

FW-7890 Series

19" 2U Intel Dual Xeron Rackmount Network Security Platform

User's Manual

Copyright and Disclaimers

© Copyright 2004 - Lanner Electronics Inc.
All Rights Reserved

The contents in this publication have been thoroughly checked and considered accurate. The publisher and manufacturer of this product, Lanner Electronics, is not responsible for any violation of patents or other rights of third parties resulting from its use. Neither does Lanner Electronics assume any responsibility for any inaccuracies contained in this manual, nor make any commitment to keep the information in this document up-to-date.

Lanner reserves the right to make improvements to this document and/or this product at any given time without notice.

No part of this document may be reproduced, stored in a retrieval system, or transmitted in any form or by any means (electronic, mechanical, photocopying, recording, or otherwise, without the formal consent from Lanner.

Trademark Acknowledgments

All products and/or brand names stated in this publication are the trademarks of their rightful and associated companies.

Radio Frequency Emissions Notice

This equipment has been tested and found to comply with the digital device limits pursuant to Part 15 of the FCC Rules. These limits are designed to provide reasonable protection against harmful interference when operate in a commercial environment. This equipment generates, uses, and can radiate radio frequency energy and, if not installed and used in accordance with the instruction manual, may cause harmful interference to radio communications. Operation of this equipment in a residential area may cause harmful interference, in which case the user will be required to correct the interference at his expense.

Federal Communications Commission (FCC) Statement

This Equipment has been tested and found to comply with the limits for a Class A digital device, pursuant to Part 15 of the FCC rules. These limits are designed to provide reasonable protection against harmful interference when the equipment is operated in a commercial environment. This equipment generates, uses and can radiate radio frequency energy and, if not installed and used in accordance with the instructions, may cause harmful interference to radio communications. Operation of this equipment in a residential area is likely to cause harmful interference in which case the user will be required to correct the interference at his own expense.

Safety Instructions

The following information relates to the safety of installation and maintenance personnel. Read all instructions before attempting to unpack, install or operate this equipment, especially before connecting the power adapter.

Please keep the following in mind as you unpack and install this equipment:

- Always follow basic safety precautions to reduce the risk of fire, electrical shock and injury to persons.
- Do not apply power into FW-7890 before installation or when disconnecting this product from its original system setup.
- To prevent fire or shock hazard, do not expose the unit to rain, moisture or install this product near water.
- Locate a safe and dry location to place this product. Keep it away from wet surfaces/surroundings.
- Never push an object of any kind into this product through openings or empty slots, as you may damage parts.
- Do not attach the power supply cabling to building surfaces. Do not allow anything to rest on the power cabling or allow it to be abused by persons walking on it.
- Distance your working area from moist floors, ungrounded power extension cables, and unavailable safety grounds.
- Avoid installation of this product during a lightning storm.
- Damages caused by electrostatic discharge may result in total or intermittent system failures. To minimize the possibility of ESD damage, an anti-static strap is highly recommended.
- When cleaning or servicing this unit, avoid using highly toxic or aerosol cleaners. Use a clean damp cloth when wiping its surfaces.
- Do not place this device in a tight and sealed location. Place the unit where it can access sufficient airflow to its vent holes (openings along its sides). Never block or cover these openings.
- Do not disassemble this product on your own.

Getting Technical Assistance

Should you encounter questions or problems with your FW-7890, Lanner Electronics is ready to assist you within the guidelines of our product support programs. First, check the electronic product documentation for assistance. If you still cannot find the solution to your problem, contact Lanner sales team with the following information handy:

- FW-7890 model name
- Part number
- Local network configuration details
- The abnormal behavior and/or error messages reported by your network system
- Your questions, or a description of the problem you are experiencing

Call, fax, or e-mail Lanner Electronics for technical support.

Phone: 886-2-8692-6060

Fax: 886-2-8692-6101

E-mail: sales@lannerinc.com

About this Manual

This target audience of this manual includes users, administrators and technicians. This publication is a useful reference when installing, configuring, operating and managing the FW-7890. This breakdown and short descriptions of this manual's contents are as follows:

- Chapter 1 – Introduction provides an overview of the FW-7890 19" 2U Rackmount network security appliance, including its related features, application usage and technical specifications list. The chapter also guides users through the pre and post installation process by listing safety tips plus an overall detailed description of the control board and system and their vital components.
- Chapter 2 – Introduce Hardware Installation
- Chapter 3 – Award BIOS Setup
- *Appendix A – summarizes the specification of the power supply*
- *Appendix B – Watchdog Timer Introduction*
- *Appendix C – Console Redirection*
- *Appendix D – LCD Module and Key Pad*
- *Appendix E – LAN Bypass Function*

Table of Contents

<i>Copyright and Disclaimers</i>	<i>ii</i>
<i>Trademark Acknowledgments</i>	<i>ii</i>
Radio Frequency Emissions Notice.....	ii
Safety Instructions.....	iv
Getting Technical Assistance.....	v
About this Manual.....	v
Table of Contents.....	vi
Chapter 1	1
Getting Started 1	
1.1 Introduction.....	1
1.1.1 Features.....	1
1.2 Technical Specifications.....	2
1.3 Packing Contents.....	3
1.4 MB-X77 System Board.....	4
1.4.1 Board Layout.....	4
1.4.2 Jumper Settings and I/O Connector.....	5
1.4.3 Connector Pin Assignments.....	5
1.5 FW-7890 19" 2U Rackmount Firewall Mechanisms.....	20
1.5.1 Face Panel.....	20
1.5.3 Rear View.....	21
Chapter 2	22
FW-7890 Hardware Installation Guide	22
2.1 Hardware Installation Guide.....	22
Chapter 3	24
Award BIOS Setup	24
3.1 BIOS Setup.....	24
3.2 Main Menu.....	25
3.3 Standard CMOS Features.....	27
3.4 Advanced BIOS Features.....	29
3.5 Advanced Chipset Features.....	31
3.6 Integrated Peripherals.....	32
3.7 Power Management Setup.....	35
3.8 PnP/PCI Configuration.....	37
3.9 PC Health Status.....	38
3.10 Load Optimized Defaults.....	39
3.11 Supervisor/User Password Setting.....	39
3.12 Save and Exit Setup.....	40
3.13 Exit Without Saving.....	40
Appendix A	41
Power Supply 41	
Appendix B	42
Watchdog Timer 42	
Appendix C	43
Console Redirection	43
Appendix D	44

<i>LCD Module and Key Pad For FW-7890</i>	44
<i>Appendix E</i>	44
<i>LAN Bypass Function</i>	44
<i>Warranty Policy</i>	47
<i>RMA Service</i>	47

Chapter 1

Getting Started

1.1 Introduction



Figure 1 – FW-7890 Outlook

The FW-7890 is a 2U rackmount network security solution targeting the Enterprise market. The FW-7890 supports dual socket 604 for Intel Xeon processor with 800MHz FSB. It is designed with an Intel E7520 as its northbridge and Intel 6300ESB as its southbridge.; All Gigabit ports to be connected from the northbridge with six PCI-E x4, ensuring maximum throughput and performance. For extra flexibility and scalability, the FW-7890 has a Mini PCI slot and two PCI-X slot, users can expand their specifications and performance by simply adding add-on cards to the slot. FW-7890 has four built-in DDRII SDRAM DIMM sockets onboard, enough for even the most intensive network security applications. The FW-7890 is a powerful and flexible unit that can meet the vast and various hardware requirement and performance needs of System Integrators, OEM customers and software developers.

1.1.1 Features

Listed below are the key features of FW-7890.

- Supports 2 * SATA removable 3.5" HDD
- Supports Dual Socket 604 for Intel Xeon processor. Up to 3.6GHz at FSB 800MHz
- Supports four DDR II DIMM socket (240-pin) up to 8GB DDR SDRAM.
- Supports 12 Gigabit Ethernet ports, with six Marvell 88E8062 chipset. It supports 12 RJ-45 connectors
- Supports Compact Flash, Console port (RJ-45), USB ports, 2* PCI-X Slot and Mini PCI.
- 19" 2U Rackmount network security appliance
- Suitable Network applications; Virtual Private Network (VPN), Firewall, IDS, Multi-Homing, Residential Gateway, Router and many more...

1.2 Technical Specifications

Model Name	FW-7890A	FW-7890B
SBC		
SBC	MB-X77A	MB-X77B
CPU	Dual Intel ® Xeon Processor, up to 3.6G with 1M L2, 800 FSB, and Hyper-Threading Technology with 64-bit Extended Memory	
Chipset	Intel E7520 / Intel 6300ESB / Winbond W83627HF	
Security Processor	Cavium CN1010	N/A
BIOS	Award BIOS	
Memory	Four 240-pin DDR-II DIMM socket, up to 8GB at 400 MHz (ECC, Registered Required)	
Network interface	Marvell 88E8062 PCI-E X 4 dual Gigabit controller via six PCI-E X 4 interface up to 12 * gigabit RJ-45 Connector	
Storage	Two CompactFlash TypeII Socket and Two removable 3.5" Hard Driver Bay via Serial ATA Interface	
I/O Interface	One RJ-45 Console port and One USB 2.0 Port	
Expansion Slot	Two PCI-X Slots (Low Profile Only, 90mm width maximum)	
RTC	Internal RTC with LI battery	
Power	2U Redundant Power Supply with input Voltage : 100VAC-240VAC and Frequency :47Hz-63Hz	
Mechanical/ Environmental		
Form Factor	19" 2U Rackmount	
Operating Temperature	0 °C – 40 °C	
Storage Temperature	-20 °C – 70 °C	
Humidity	5% - 95% RH, non-condensing	
Chassis Material	SPGC	
Dimension	550x431x88 mm	
Net Weight	22.2 KGS	
Certification	CE, FCC CLASS A	
Software support	Linux 6.5 and above, Windows 2000/2003/ XP	

1.3 Packing Contents

Carefully unpack your package and make sure that you have the following items.

- FW-7890 Network security Platform x 1 pcs
- Console cable(RJ-45) x 1 pcs
- 1.8 meters long cross-over Ethernet cable x 1 pcs
- 1.8 meters long straight-through Ethernet cable x 1 pcs
- Face panel name plate label x 1 pcs
- Power cable x 2 pcs
- Drivers and User's Manual CD x 1 pcs
- Screw Set
- CPU Cooler x 2 pcs
- Slid & Bracket Set

If you find anything missing or damaged, promptly contact your dealer for assistance.

1.4 MB-X77 System Board

MB-X77 is the system board bundled with the FW-7890 Network security platform. The succeeding sections list all MB-X77 related jumper settings and connector pin assignments.

1.4.1 Board Layout

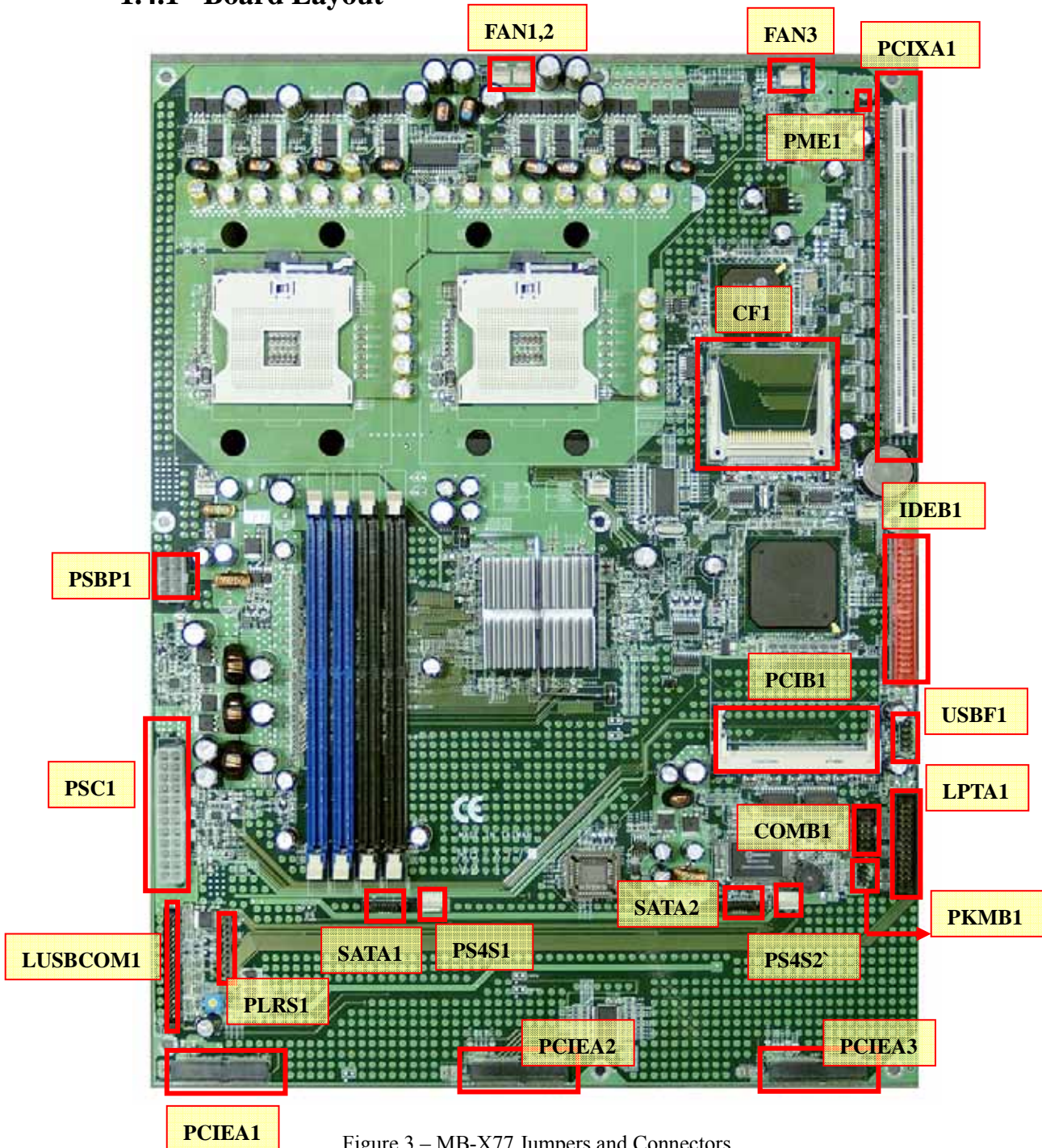

Figure 3 – MB-X77 Jumpers and Connectors

1.4.2 Jumper Settings and I/O Connector

The onboard jumper settings and I/O connector of MB-X77 are custom-tailored to fit the FW-7890 functionality. Changing the jumper settings may result in system malfunction or unforeseen damages.

Jumper Settings and I/O Connector Summary for MB-X77

JUMPER	FUNCTION
PLRS1	Power LED,HD LED,Reset,Speaker Connector(11 Pin 2.54mm)
PKMB1	PS/2 Keyboard & Mouse Connector (2x4 Header 2.54 mm)
CMOS1	Clear CMOS Data
IDEB1	IDE Interface Connector (40 Pin 2.54mm Pitch Header)
FAN 1 -3	3 Pin FAN Connector
FAN 4- 6	3 Pin FAN Connector
CF1	Compact Flash Connector
COMB1	Serial Port #2 Connector (Header)
LPTA1	Parallel Connector (26 Pin 2.00mm Pitch Header)
PSC1	24 Pin ATX Power Connector
PCIB1	124 Pin Mini PCI Socket
PCIXA1	184 Pin 3V PCIX Socket
PS4S1 - 2	4 Pin Power Connector
PS8P1	8 Pin Power Connector
SATAB1	180 SATA Connector
VR1	Control Sound
PME1	One PME1 Connector supports Wake-on-LAN
LUSBCOM1	BOX HEADER 2X20 2.00 DIP
PCIEA1 -3	PCI EXPRESS CONNECTOR
USBF1	USB Port#1 & #2 Connector 2x5 Pin 2.54mm
PSWB1	ATX Power As AT Power Use Power Button
REDP1	2 Pin header for Redundant Power detect signal

1.4.3 Connector Pin Assignments

PLRS1: Power LED, HD LED, Reset, Speaker Connector (11 Pin 2.54mm)

PIN NO.	DESCRIPTION
1	Power LED +
2	Power LED +
3	GND
4	HDD LED +
5	HDD LED -
6	RESET SW +
7	RESET SW - (GND)
8	External Speaker -
9	Internal Buzzer -
10	NC
11	External Speaker +

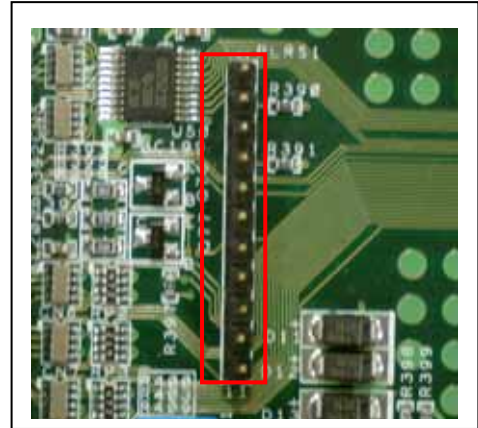

Default : 8-9 (ON) Internal Buzzer

PKMB1: PS/2 Keyboard & Mouse Connector (2x4 Header 2.54mm)

PIN NO.	DESCRIPTION	PIN NO.	DESCRIPTION
1	VCC	2	MSCLK
3	MSDATA	4	KEY
5	KBDATA	6	KEY
7	GND	8	KBCLK

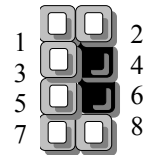

CMOS1: Clear CMOS Data

CMOS1	Description
1-2	Normal (Default)
2-3	Clear CMOS

IDE B1 : IDE Interface Connector (40Pin 2.54mm Pitch Header)

PIN NO.	DESCRIPTION	PIN NO.	DESCRIPTION
1	Reset #	2	Ground
3	Data 7	4	Data 8

5	Data 6	6	Data 9
7	Data 5	8	Data 10
9	Data 4	10	Data 11
11	Data 3	12	Data 12
13	Data 2	14	Data 13
15	Data 1	16	Data 14
17	Data 0	18	Data 15
19	Ground	20	KEY
21	DMA REQ#	22	Ground
23	IOW #	24	Ground
25	IOR #	26	Ground
27	IOCHRDY	28	Ground
29	DMA ACK #	30	Ground
31	Interrupt	32	NC
33	SA1	34	PD80P / SD80P
35	SA0	36	SA2
37	HDC CS0 #	38	HDC CS1 #
39	HDD Active LED #	40	Ground

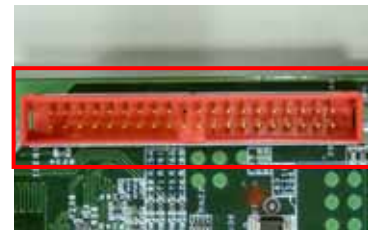
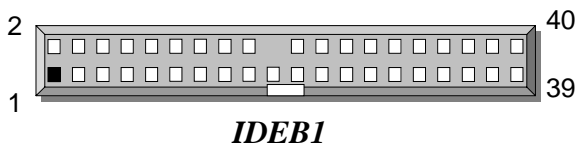

FANI~3 : 3 Pin FAN Connector

Pin No.	Description
1	Ground
2	+12V
3	NC

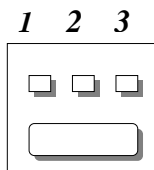

FANI

FAN4~6 : 3 Pin FAN Connector

Pin No.	Description
1	Ground
2	+12V
3	FAN Status

CF1: Compact Flash Connector

PIN	DESCRIPTION	PIN	DESCRIPTION
1	GND	26	CD1-
2	DATA3	27	DATA11
3	DATA4	28	DATA12
4	DATA5	29	DATA13
5	DATA6	30	DATA14
6	DATA7	31	DATA15
7	CE1#	32	CE2#
8	A10	33	VS1#
9	OE#	34	IOR#
10	A9	35	IOW#
11	A8	36	WE#
12	A7	37	READY#
13	CFVCC3	38	CFVCC3
14	A6	39	CSEL
15	A5	40	VS2#
16	A4	41	RESET
17	A3	42	WAIT#
18	A2	43	INPACK#
19	A1	44	REG#
20	A0	45	DASP#
21	DATA0	46	DIAG#
22	DATA1	47	DATA8
23	DATA2	48	DATA9
24	WP	49	DATA10
25	CD2-	50	GND

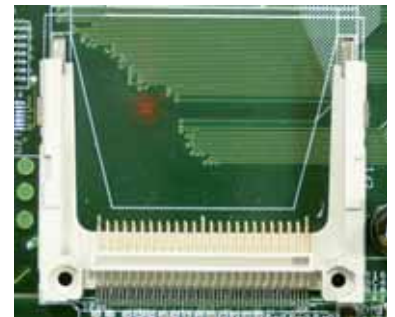
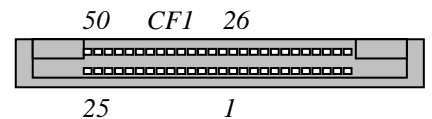

COMBI: Serial Port #2 Connector (Header)

PIN NO	DESCRIPTION
	RS-232
1	Data Carrier Detect (DCDB #)
2	Data Set Ready (DSRB #)
3	Receive Data (RXDB)
4	Request To Send (RTSB #)
5	Transmit Data (TXDB)
6	Clear To Send (CTSB #)
7	Data Terminal Ready (DTRB #)
8	Ring Indicator (RIB #)
9	Ground
10	KEY

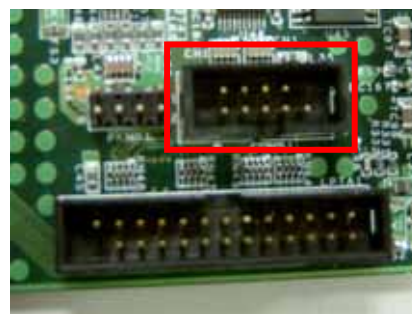
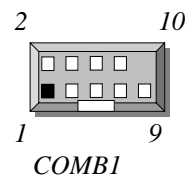

LPTA1 : Parallel Connector (26 Pin 2.00mm Pitch Header)

PIN NO.	DESCRIPTION	PIN NO.	DESCRIPTION
1	Strobe #	2	Auto Form Feed
3	Data0	4	Error #
5	Data1	6	Initialize #
7	Data2	8	Printer Select IN #
9	Data3	10	Ground
11	Data4	12	Ground
13	Data5	14	Ground
15	Data6	16	Ground
17	Data7	18	Ground
19	Acknowledge #	20	Ground
21	Busy	22	Ground
23	Paper Empty	24	Ground
25	Printer Select	26	KEY

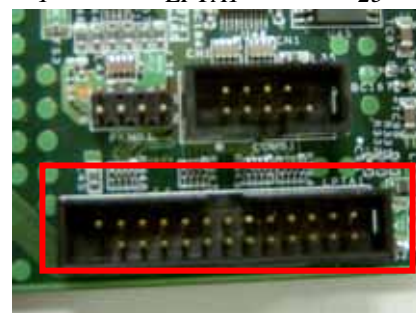
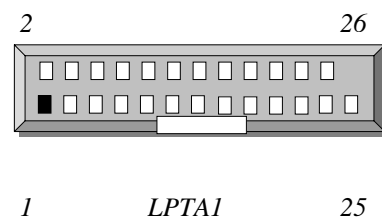

PSC1:24 Pin ATX Power Connector

PIN NO.	DESCRIPTION	PIN NO.	DESCRIPTION
1	+3.3V	13	+3.3V
2	+3.3V	14	-12V
3	Ground	15	Ground
4	+5V	16	PSON-
5	Ground	17	Ground
6	+5V	18	Ground
7	Ground	19	Ground
8	Power Good	20	NC
9	Stand-By 5V	21	+5V
10	+12V	22	+5V
11	+12V	23	+5V
12	+3.3V	24	Ground

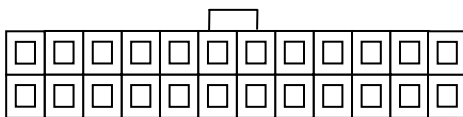

PSCI

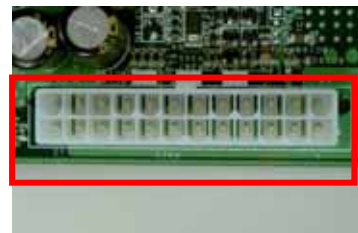

PCIB1:124 Pin Mini PCI Socket

Pin No.	Description	Pin No.	Description
1	TIP	2	RING
3	8PMJ-3	4	8PMJ-1
5	8PMJ-6	6	8PMJ-2
7	8PMJ-7	8	8PMJ-4
9	8PMJ-8	10	8PMJ-5
11	LED1_GRNP	12	LED2_YELP
13	LED1_GRNN	14	LED2_YELP
15	CHSGND	16	RESERVED
17	INT-B	18	+5V
19	+3.3V	20	INT-A
21	RESERVED	22	RESERVED
23	GROUND	24	3.3VAUX

25	CLK	26	RST
27	GROUND	28	+3.3V
29	REO	30	GNT
31	+3.3V	32	GROUND
33	AD31	34	PME
35	AD29	36	RESERVED
37	GROUND	38	AD30
39	AD27	40	+3.3V
41	AD25	42	AD28
43	RESERVED	44	AD26
45	C_BE-3	46	AD24
47	AD23	48	IDSEL
49	GROUND	50	GROUND
51	AD21	52	AD22
53	AD19	54	AD20
55	GROUND	56	PAR
57	AD17	58	AD18
59	C_BE-2	60	AD16
61	IRDY	62	GROUND
63	+3.3V	64	FRAME
65	CLKRUN	66	TRDY
67	SERR	68	STOP
69	GROUND	70	+3.3V
71	PERR	72	DEVSEL
73	C_BE-1	74	GROUND
75	AD14	76	AD15
77	GROUND	78	AD13
79	AD12	80	AD11
81	AD10	82	GROUND
83	GROUND	84	AD9
85	AD8	86	C_BE-0
87	AD7	88	+3.3V
89	+3.3V	90	AD6

91	AD5	92	AD4
93	RESERVED	94	AD2
95	AD3	96	AD0
97	+5V	98	RESERVED-WIP
99	AD1	100	RESERVED-WIP
101	GROUND	102	GROUND
103	AC_SYNC	104	M66EN
105	AC_SDATA_IN	106	AC_SDATA_OUT
107	AC_BIT_CLK	108	AC_CODEC_ID0
109	AC_CODEC_ID1	110	AC_RESET
111	MOD_AUDIO_M	112	RESERVED
113	AUDIO_GND	114	GROUND
115	SYS_AUDIO_OU	116	SYS_AUDIO_IN
117	SYS_AUDIO_OU	118	SYS_AUDIO_IN
119	AUDIO_GND	120	AUDIO_GND
121	RESERVED	122	MPCIACT
123	VCC5VA	124	3.3AUX

PSWI:For ATX Power Button

PIN NO.	DESCRIPTION
1	PANSW
2	GND

PSWB1:ATX Power As AT Power Use Power Button

PIN NO.	DESCRIPTION
1	PSON+
2	GND

REDP1:For Redundant Power Detect Signal

PIN NO.	DESCRIPTION
1	GPIO 23
2	GND

PCIXA1: 184 Pin 3V PCIX Socket

Pin			comments
	Side B	Side A	
1	-12V	TRST#	32-bit connector start
2	TCK	+12V	
3	Ground	TMS	
4	TDO	TDI	
5	+5V	+5V	
6	+5V	INTA#	
7	INTB#	INTC#	
8	INTD#	+5V	
9	PRSENT1#	Reserved	
10	Reserved	+3.3V (I/O)	
11	PRSENT2#	Reserved	
12	CONNECTOR KEY		3.3 volt key
13	CONNECTOR KEY		3.3 volt key
14	Reserved	3.3Vaux	
15	Ground	RST#	
16	CLK	+3.3V (I/O)	
17	Ground	GNT#	
18	REQ#	Ground	
19	+3.3V (I/O)	PME#	
20	AD { 31 }	AD { 30 }	
21	AD { 29 }	+3.3V	
22	Ground	AD { 28 }	
23	AD { 27 }	AD { 26 }	
24	AD { 25 }	Ground	
25	+3.3V	AD { 24 }	
26	C/BE { 3 } #	IDSEL	
27	AD { 23 }	+3.3V	
28	Ground	AD { 22 }	
29	AD { 21 }	AD { 20 }	



30	AD (19)	Ground	
31	+3.3V	AD (18)	
32	AD (17)	AD (16)	
33	C/BE (2) #	+3.3V	
34	Ground	FRAME#	
35	IRDY#	Ground	
36	+3.3V	TRDY#	
37	DEVSEL#	Ground	
38	Ground	STOP#	
39	LOCK#	+3.3V	
40	PERR#	Reserved*	
41	+3.3V	Reserved*	
42	SERR#	Ground	
43	+3.3V	PAR	
44	C/BE (1) #	AD (15)	
45	AD (14)	+3.3V	
46	Ground	AD (13)	
47	AD (12)	AD (11)	
48	AD (10)	Ground	
49	M66EN	AD (09)	66MHZ/gnd
50	Ground	Ground	5 volt key
51	Ground	Ground	5 volt key
52	AD (08)	C/BE (0) #	
53	AD (07)	+3.3V	
54	+3.3V	AD (06)	
55	AD (05)	AD (04)	
56	AD (03)	Ground	
57	Ground	AD (02)	
58	AD (01)	AD (00)	
59	+3.3V (I/O)	+3.3V (I/O)	
60	ACK64#	REQ64#	
61	+5V	+5V	
62	+5V	+5V	32-bit connector end

CONNECTOR KEY		64-bit spacer
63	Reserved	Ground
64	Ground	C/BE { 7 } #
65	C/BE { 6 } #	C/BE { 5 } #
66	C/BE { 4 } #	+3.3V (I/O)
67	Ground	PAR64
68	AD { 63 }	AD { 62 }
69	AD { 61 }	Ground
70	+3.3V (I/O)	AD { 60 }
71	AD { 59 }	AD { 58 }
72	AD { 57 }	Ground
73	Ground	AD { 56 }
74	AD { 55 }	AD { 54 }
75	AD { 53 }	+3.3V (I/O)
76	Ground	AD { 52 }
77	AD { 51 }	AD { 50 }
78	AD { 49 }	Ground
79	+3.3V (I/O)	AD { 48 }
80	AD { 47 }	AD { 46 }
81	AD { 45 }	Ground
82	Ground	AD { 44 }
83	AD { 43 }	AD { 42 }
84	AD { 41 }	+3.3V (I/O)
85	Ground	AD { 40 }
86	AD { 39 }	AD { 38 }
87	AD { 37 }	Ground
88	+3.3V (I/O)	AD { 36 }
89	AD { 35 }	AD { 34 }
90	AD { 33 }	Ground
91	Grond	AD { 32 }
92	Reserved	Reserved
93	Reserved	Ground
94	Ground	Reserved

PS4S1~2:4-Pin Power Connector (Small-4P)

Pin No.	Description
1	5V
2	Ground
3	Ground
4	12V

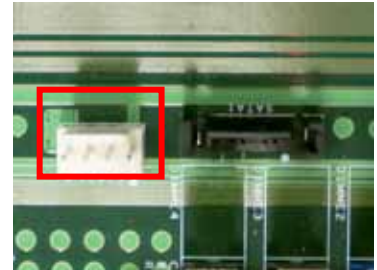
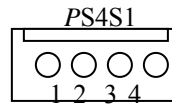

PS8P1:8-Pin Power Connector (Xeon-8P Male)

Pin No.	Description	Pin No.	Description
1	Ground	5	+12V
2	Ground	6	+12V
3	Ground	7	+12V
4	Ground	8	+12V

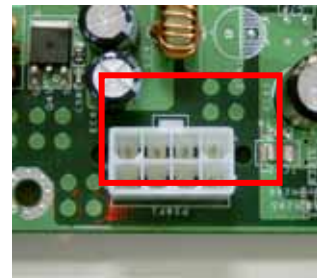
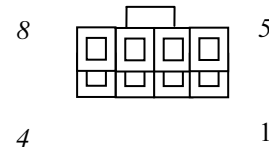

SATA1 : 180° SATA CONNECTOR

Pin No.	Description
1	GND
2	TX_P
3	TX_M
4	GND
5	RX_M
6	RX_P
7	GND

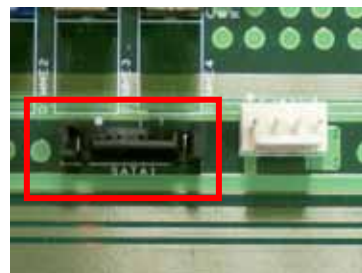

VR1 : Control Sound

PIN NO.	DESCRIPTION
1	GND
2	AOL
3	VR-L

PME1: One PME1 Connector supports Wake-on-Lan

PIN	DESCRIPTION
1	3VSTB
2	PME-
3	GND

LUSBCOM1 : BOX_HEADER_2X20_2.00_DIP

Pin No.	Description	Pin No.	Description
1	COM_GND	2	COM_GND
3	NDSR1	4	NDCD1
5	NRTS1	6	NRXD1
7	NCTS1	8	NTXD1
9	NRI1	10	NDTR1
11	GENSTS-	12	REDSTS-
13	HDLED-	14	HDLED+
15	GND	16	PRLED+
17	LCD-	18	VCC
19	LPD7	20	LPD6
21	LPD5	22	LPD4
23	LPD3	24	LPD2
25	LPD1	26	LPD0
27	LAFD-	28	LINIT-
29	LSTIN-	30	VEE
31	VCC	32	IOGND
33	DOWN	34	UP
35	RIGHT	36	LEFT
37	USBVF	38	USB_GND
39	USB_D0P	40	USB_D0N

PCIEA1~3: PCI EXPRESS CONNECTOR

Pin No.	Description	Pin No.	Description

1	12V	2	VCC3
3	12V	4	VCC3
5	12V	6	VCC3
7	RELAY_C	8	VCC3
9	VCC3AUX	10	VCC3
11	VCC	12	VCC
13	WAKE	14	TCK
15	PRSENT1	16	SMCLK
17	TRST	18	SMDAT
19	TDO	20	TDI
21	BTX3-	22	TMS
23	BTX3+	24	BRX3-
25	GND	26	BRX3+
27	BTX2-	28	GND
29	BTX2+	30	BRX2-
31	GND	32	BRX2+
33	BTX1-	34	GND
35	BTX1+	36	BRX1-
37	GND	38	BRX1+
39	BTX0-	40	GND
41	BTX0+	42	BRX0-
43	GND	44	BRX0+
	Key		Key
	Key		Key
45	GND	46	BCLK-
47	GND	48	BCLK+
49	ATX3-	50	GND
51	ATX3+	52	GND
53	GND	54	ARX3-



55	ATX2-	56	ARX3+
57	ATX2+	58	GND
59	GND	60	ARX2-
61	ATX1-	62	ARX2+
63	ATX1+	64	GND
65	GND	66	ARX1-
67	ATX0-	68	ARX1+
69	ATX0+	70	GND
71	GND	72	ARX0-
73	GND	74	ARX0+
75	ACLK-	76	GND
77	ACLK+	78	GND
79	GND	80	PWRGD

USBF1 : USB Port #1 & #2 Connector 2x5 Pin 2.54mm

PIN	DESCRIPTION	PIN	DESCRIPTION
1	USB_VCC	2	Ground
3	Key	4	USBD1+
5	USBD0-	6	USBD1-
7	USBD0+	8	Key
9	Ground	10	USB_VCC

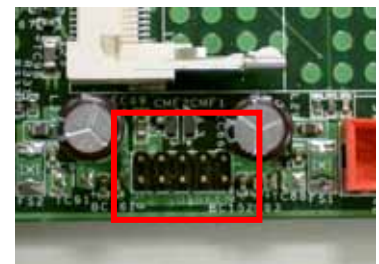
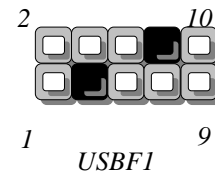

1.5 FW-7890 19" 2U Rackmount Firewall Mechanisms

This section of the manual describes the mechanical and device nomenclature of FW-7890.

1.5.1 Face Panel

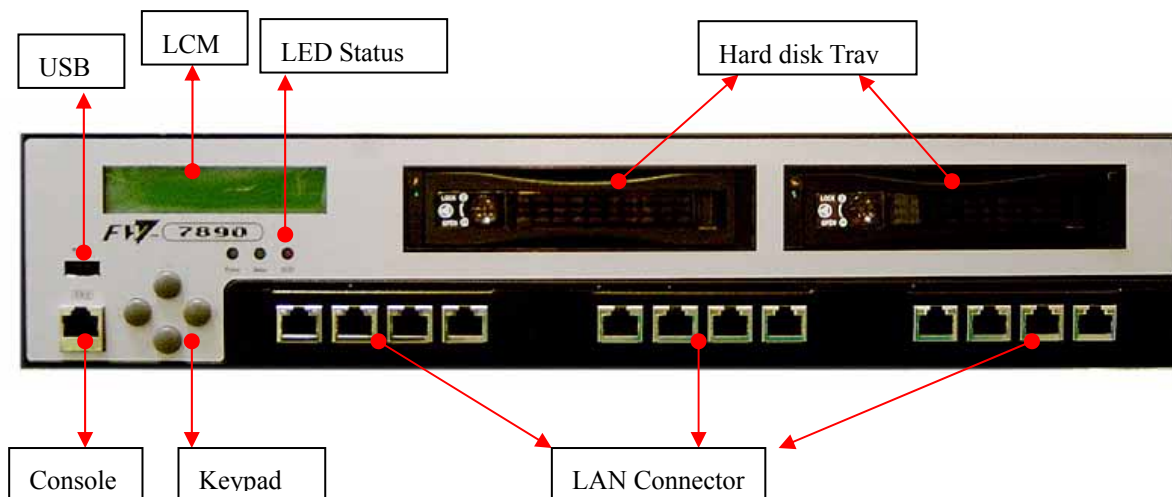

Figure 5 – FW-7890 Face Panel

Face Panel LED Status and Behavior

The following table lists and explains the behavior of each LED on the FW-7890 front panel.

LED	Color	Status	Description
PWR	Green	On	When FW-7890 power is switched ON
	N/A	Off	No power connected
HDD	Yellow	On	Hard disk under access
	N/A	Off	No Data access
Ethernet Ports Link/ACT	Green	On	When LAN is connected
	Orange	Flash	When Data is accessing
Status			Lanner Provide the Sample Code, Reference the Driver/Manual CD. The path is under /LED Status

- **Console Port:** via the console port cable, this connector attaches FW-7890 to the host PC. The Default baud rate is 115200.
- **LAN Connector:** Ethernet RJ-45 connector, connected to networking environment using a RJ-45 Ethernet cable
- **LCM & Keypad** Please reference the Appendix B

1.5.3 Rear View

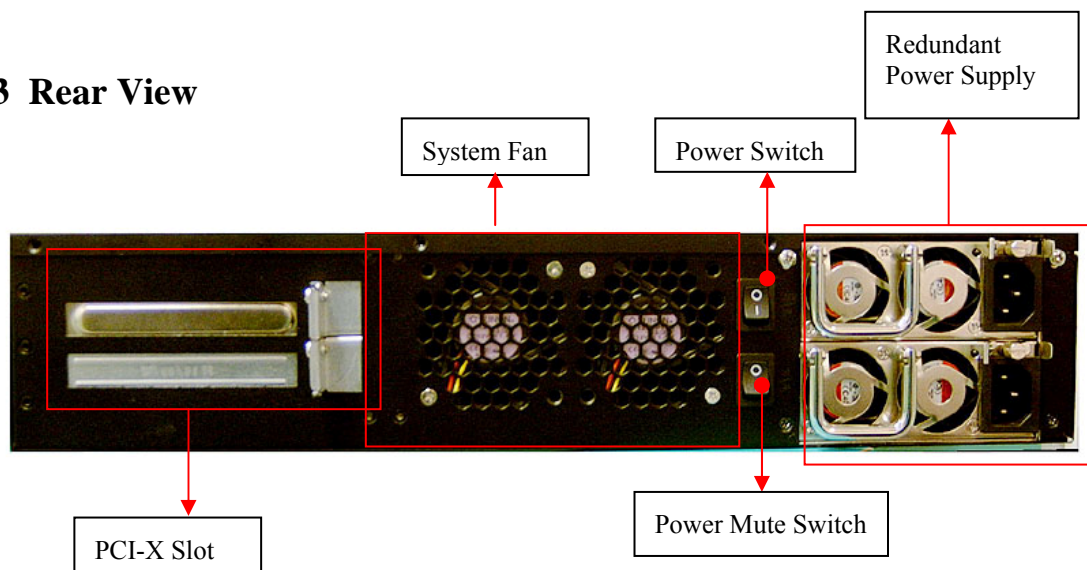

Figure 6 – FW-7890 Rear View

- **Power Switch:** Click the Power Switch , and the system will be power on.
- **Power Mute Switch:** When there is a power supply failure, the system will be alarm. Only click the power mute switch and the system will stop to alarm.



Faulty or improper use of the power adaptor may cause permanent damage to the power supply and the FW-7890. Plug the adaptor to an electrical wall outlet that matches its specifications.

Chapter 2

FW-7890 Hardware Installation Guide

2.1 Hardware Installation Guide

- CPU Installation

If you plug in single CPU in FW-7890, be notes to put in CPU1.

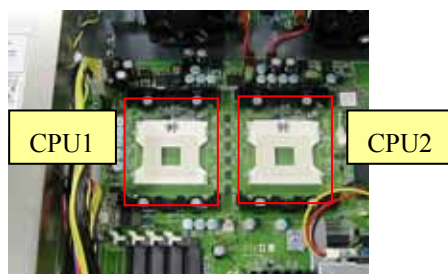

- System Memory

Step 1: The DIMM slot has a notch, the DIMM memory module only fit in one direction.

Step 2: Align the memory notch to the module and push the memory into the DIMM socket

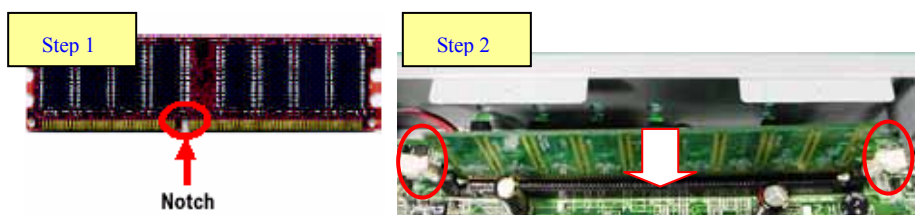

Be notes that it is the dual channel DDR II memory interface, so it needs to plug-in from one of the Blue DIMM first.

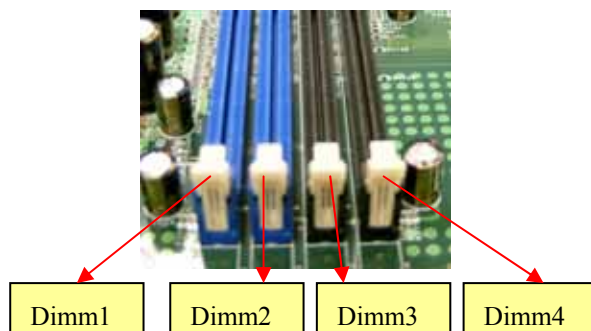

- **Installing Compact Flash Card**

Step 1: Insert the compact flash card into the slot carefully as shown in the picture.

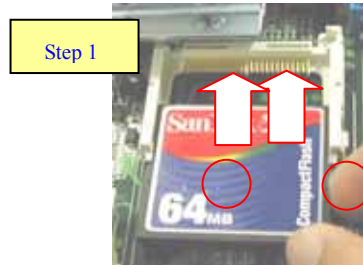

- **Installing the Mini-PCI Card**

Step 1: Insert the PCI expansion card into the mini-PCI slot at 45 degree.

Step 2: Push down the PCI expansion card and the PCI expansion card is clicked together completely with the PCI expansion slot.

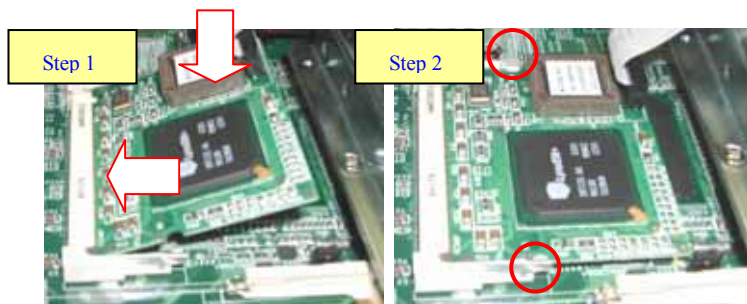

Chapter 3

Award BIOS Setup

3.1 BIOS Setup

Award's ROM BIOS provides a built-in Setup program that allows users to modify the basic system configuration and settings. The modified data will be stored in a battery-backed CMOS RAM so that this data will be retained even when the power is turned off. In general, the information saved in the CMOS RAM remains unchanged unless there is a configuration change in the system, such as hard drive replacement or new equipment installment.

Starting Setup

The AwardBIOS™ is immediately activated when you first power on the computer. The BIOS reads the system information contained in the CMOS and begins the process of checking out the system and configuring it. When it finishes, the BIOS will seek an operating system on one of the disks and then launch and turn control over to the operating system.

While the BIOS is in control, the Setup program can be activated in one of two ways:

1. By pressing immediately after switching the system on, or
2. By pressing the key when the following message appears briefly at the bottom of the screen during the POST (Power On Self-Test).

Press DEL to enter SETUP.

If the message disappears before you respond and you still wish to enter Setup, restart the system to try again by turning it OFF then ON or pressing the "RESET" button on the system case. You may also restart by simultaneously pressing <Ctrl>, <Alt>, and <Delete> keys. If you do not press the keys at the correct time and the system does not boot, an error message will be displayed and you will again be asked to...

PRESS F1 TO CONTINUE, DEL TO ENTER SETUP

Using Setup

In general, you use the arrow keys to highlight items, press <Enter> to select, use the PageUp and PageDown keys to change entries, press <F1> for help and press <Esc> to quit. The following table provides more detail about how to navigate in the Setup program using the keyboard.

< >	Move to previous item
< >	Move to next item
< >	Move to the item in the left hand
< >	Move to the item in the right hand
Enter	Select item

<Esc>	Main Menu - Quit and not save changes into CMOS Status Page Setup Menu and Option Page Setup Menu - Exit current page and return to Main Menu
<+/PgUp>	Increase the numeric value or make changes
<-/PgDn>	Decrease the numeric value or make changes
<F1>	General help, only for Status Page Setup Menu and Option Page Setup Menu
<F2>	Item Help
<F5>	Restore the previous CMOS value from CMOS, only for Option Page Setup Menu
<F7>	Load the Optimized Defaults
<F9>	System Information
<F10>	Save all the CMOS changes, only for Main Menu

Navigating through the menu bar

Use the left and right arrow keys to choose the menu you want to be in.

To display a sub menu, use the arrow keys to move the cursor to the sub menu you want. Then press <Enter>. A “!” pointer marks all sub menus.

Getting Help

Press F1 to pop up a small help window that describes the appropriate keys to use and the possible selections for the highlighted item. To exit the Help Window press <Esc> or the F1 key again.

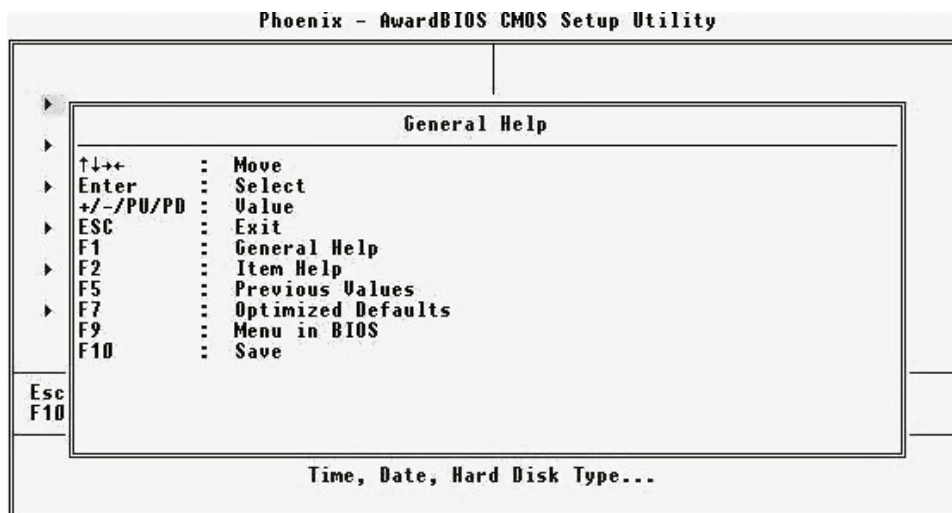

3.2 Main Menu

Once you enter the AwardBIOS™ CMOS Setup Utility, the Main Menu will appear on the screen. The Main Menu allows you to select from several setup functions and two exit choices. Use the arrow keys to select among the items and press <Enter> to accept and enter the sub-menu.

CMOS Setup Utility – Copyright © 1984-2001 Award Software

▶	Standard CMOS Features	▶	PC Health Status
▶	Advanced BIOS Features		Load Optimized Defaults
▶	Advanced Chipset Features		Set Supervisor Password
▶	Integrated Peripherals		Set User Password
▶	Power Management Setup		Save & Exit Setup
▶	PnP/PCI Configurations		Exit Without Saving
Esc	: Quit	↑ ↓ →	: Select Item
F10	: Save & Exit Setup		
Time, Date, Hard Disk Type...			

Note that a brief description of each highlighted selection appears at the bottom of the screen.

- **Standard CMOS Features**
Use this menu for basic system configuration.
- **Advanced BIOS Features**
Use this menu to set the Advanced Features available on your system.
- **Advanced Chipset Features**
Use this menu to change the values in the chipset registers and optimize your system's performance.
- **Integrated Peripherals**
Use this menu to specify your settings for integrated peripherals.
- **Power Management Setup**
Use this menu to specify your settings for power management.
- **PnP/PCI Configurations**
This entry appears if your system supports PnP / PCI.
- **PC Health Status**
This setup page is the System auto detect Temperature, voltage, fan, speed.
- **Load Optimized Defaults**
Use this menu to load the BIOS default values that are factory settings for optimal performance system operations.
- **Set Supervisor password**
Use this menu to set Supervisor Passwords.
- **Set User password**
Use this menu to set User Passwords.
- **Save & Exit Setup**
Save CMOS value changes to CMOS and exit setup.
- **Exit Without Saving**
Abandon all CMOS value changes and exit setup.

3.3 Standard CMOS Features

The items in Standard CMOS Setup Menu are divided into 9 categories. Each category includes no, one or more than one setup items. Use the arrow keys to highlight the item and then use the <PgUp> or <PgDn> keys to select the value you want in each item.

Phoenix - AwardBIOS CMOS Setup Utility Standard CMOS Features		
Date (mm:dd:yy)	Tue, Jul 13 2004	Item Help Menu Level ▶
Time (hh:mm:ss)	12 : 5 : 15	
▶ IDE Channel 0 Master		Change the day, month, year and century
▶ IDE Channel 0 Slave		
▶ IDE Channel 1 Master		
▶ IDE Channel 1 Slave		
Drive A	[None]	
Drive B	[None]	
Halt On	[All , But Keyboard]	
Base Memory	640K	
Extended Memory	65472K	
Total Memory	1024K	
↑↓→←:Move Enter:Select +/-/PU/PD:Value F10:Save ESC:Exit F1:General Help F5:Previous Values F7: Optimized Defaults		

Phoenix - AwardBIOS CMOS Setup Utility IDE Channel 0 Master		
IDE HDD Auto-Detection	[Press Enter]	Item Help Menu Level ▶▶
IDE Channel 0 Master Access Mode	[Auto]	
Capacity	0 MB	To auto-detect the HDD's size, head... on this channel
Cylinder	0	
Head	0	
Precomp	0	
Landing Zone	0	
Sector	0	
↑↓→←:Move Enter:Select +/-/PU/PD:Value F10:Save ESC:Exit F1:General Help F5:Previous Values F7: Optimized Defaults		

Item	Options	Description
Date	Month DD YYYY	Set the system date. Note that the 'Day' automatically changes when you set the date
Time	HH : MM : SS	Set the system time
IDE Channel 0	Options are in its sub menu	Press <Enter> to enter the sub menu of

Access Mode	CHS LBA Large Auto	Choose the access mode for this hard disk
Cylinder	Min = 0 Max = 65535	Set the number of cylinders for this hard disk.
Head	Min = 0 Max = 255	Set the number of read/write heads
Precomp	Min = 0 Max = 65535	**** Warning: Setting a value of 65535 means no hard disk
Landing zone	Min = 0 Max = 65535	****
Sector	Min = 0 Max = 255	Number of sectors per track

3.4 Advanced BIOS Features

This section allows you to configure your system for basic operation. You have the opportunity to select the system's default speed, boot-up sequence, keyboard operation, shadowing and security.

Phoenix - Award WorkstationBIOS CMOS Setup Utility
Advanced BIOS Features

	Item Help
▶ Hard Disk Boot Priority [Press Enter]	
Virus Warning [Disabled]	
Hyper-Threading Technology [Enabled]	Menu Level ▶
Quick Power On Self Test [Enabled]	
First Boot Device [Hard Disk]	Select Hard Disk Boot
Second Boot Device [LAN]	Device Priority
Third Boot Device [CDROM]	
Boot Other Device [Enabled]	
Boot Up NumLock Status [On]	
Security Option [Setup]	
PS/2 Mouse Function Contro [Enabled]	
HDD S.M.A.R.T. Capability [Enabled]	
Console Redirection [Enabled]	
Baud Rate [115200]	
Agent after boot [Disabled]	
▶ Shadow Areas [Press Enter]	
Full Screen LOGO Show [Disabled]	

Hard Disk Boot Priority : Select Hard disk boot device priority.

Virus Warning : The default setting of Virus Warning is "Disabled". When it is enabled, any attempt to write the boot sector and partition table will halt the system and cause a warning message to appear. If this happens, you can use an anti-virus utility on a virus free, bootable floppy diskette to reboot, to clean and to investigate your system.

Hyper-Threading Technology : Allows you to enable or disable the CPU Hyper-Threading Technology feature.

Enabled	Enables CPU Hyper Threading Feature. Please note that this feature is only working for operating system with multi
----------------	--

	processors mode supported.
Disabled	Disables CPU Hyper Threading Feature.

Quick Power On Self Test : The default setting is “Enabled”. This speeds up the Power On Self Test (POST) by skipping some items that are normally checked during the full POST. If your system is functioning normally, you can choose this feature to speed up the booting process.

First / Second / Third / Other Boot Device : The BIOS attempts to load the operating system from the devices in the sequence selected in these items. The settings are Floppy, LS/ZIP, HDD-0/HDD-1/HDD-2/HDD-3, SCSI, CDROM, LAN, and Disabled

Boot Up Numlock Status : The default setting is “On”. If set “Off”, the cursor controls will function on the numeric keypad.

Security Option : This setting controls the password in the main screen. The options are “Setup” and “System”. Select “Setup” and it will protect the Setup Utility settings from being tampered with. Select “System” if you want to use password feature every time the system boots up. The default setting is “Setup”. You can create your password by using the “SUPERVISOR/USER PASSWORD” utility on the main program screen.

PS/2 Mouse Function Control : When this option is set *Enabled*, AMIBIOS supports a PS/2 type mouse. The settings are *Enabled* or *Disabled*. The default setting is *Disabled*. System Boot Up Sequence.

HDD S.M.A.R.T. Capability: Enable installs SMART (Self-Monitoring Analysis-Reporting Technology), which issues a warning if an IDE failure is imminent.

Console Redirection: The console Redirect capability allows a system with no keyboard to transmit keyboard data to a host system via the COM port.

Enabled	Attempt to redirect console via COM port.
Disabled	Attempt to redirect console when keyboard absent.
Auto	If keyboard is plug in the Controller board, the Console Redirection will not display BIOS screen on remote PC. If keyboard is not plug in the Controller board, the Console Redirection will display BIOS screen on remote PC.

Baud Rate : Specify Baud Rate of console redirection.

Configuration options: 9600 / 19200 / 38400 / 57600 / 115200

Agent after Boot : Keep Agent after OS Boot. Configuration options: Enabled / Disabled

Shadow Areas :

These categories determine whether option ROMs will be copied to RAM,

Enabled	Optional shadow is enabled
Disabled	Optional shadow is disabled

Full Screen LOGO Show:

Show full screen logo during BIOS bootup process.

Configuration options: Enabled/Disabled

3.5 Advanced Chipset Features

Spread Spectrum	[Disabled]	Item Help
System BIOS Cacheable	[Enabled]	
Video BIOS Cacheable	[Disabled]	Menu Level ▶
Memory Hole At 15M-16M	[Disabled]	
Delay Prior to Thermal	[16 Min]	
DRAM Data Integrity Mode	[ECC]	
PCI Express A Device	[4X]	
PCI Express B Device	[4X]	
PCI Express C Device	[4X]	
MCH Compliance Mode	[Disabled]	
Memory RAS Feature	[Standard]	

Spread Spectrum: When the mainboard’s clock generator pulses, the extreme values (spikes) of the pulses creates EMI (Electromagnetic Interference). The Spread Spectrum function reduces the EMI generated by modulating the pulses so that the spikes of the pulses are reduced to flatter curves.

Configuration options: Enabled / Disabled

System BIOS Cacheable : Selecting “Enabled” allows caching of the system BIOS ROM at F0000h – FFFFFh, resulting in better system performance. However, if any program writes to this memory area, a system error may result. The settings are “Enabled” and “Disabled”.

Video BIOS Cacheable: Selecting Enabled allows caching of the video BIOS ROM at C0000h to C7FFFh, resulting in better video performance. However, if any program writes to this memory area, a system error may result.

Memory Hole At 15M-16M: You can reserve this area of system memory for ISA adapter ROM. When this area is reserved, it cannot be cached. The user information of peripherals that need to use this area of system memory usually discusses their memory requirements.

Delay Prior to Thermal : The Delay Prior To Thermal BIOS feature controls the activation of the Thermal Monitor's automatic mode. It allows you to determine when the Thermal Monitor should be activated in automatic mode after the system boots.

DRAM Data Integrity Mode

If you are using the Non-ECC DRAM, the mode will show "Non-ECC" and this function is disabled.

ECC	Set DRAM mode at ECC.
Non-ECC	Set DRAM mode at Non-ECC.

PCI Express A / B / C Device : Select the PCI Express interface.

Memory RAS Feature: A memory function; an acronym for Raw Address Select. A control pin on a DRAM used to latch and activate a row address. The row selected on a DRAM is determined by the data present at the addr. pins when RAS becomes active.

3.6 Integrated Peripherals

Init Display First	[Add-On Card]	Item Help
OnChip IDE Device	[Press Enter]	
▶ Onboard Device	[Press Enter]	Menu Level ▶
▶ SuperIO Device	[Press Enter]	

Init Display First : This item allows you to decide to active whether PCI Slot of VGA card or AGP first. The settings are “PCI Slot” and “AGP Slot”.

OnChip IDE Device : Scroll to this item and press <Enter> to view the following screen:

On-Chip (Primary/Secondary) PCI IDE : The Intel 82C440BX chipset contains a PCI IDE interface with support for two IDE channels. Select Enabled to activate the primary and/or secondary IDE interface. Select Disabled to deactivate this interface, if you install a primary and/or secondary add-in IDE interface.

On-Chip Serial ATA

This item allows you to configure your serial ATA devices if present.

Disabled	Disable SATA controller.
Auto	Auto arrange by BIOS.
Combined Mode	PATA and SATA are combined. Max.of 2 IDE drives in each channel.
Enhanced Mode	Enabled both SATA and PATA. Max.of 6 IDE drives are supported.
SATA First	SATA is operating in legacy mode.

Note. The items SATA mode, Serial ATA Port0 Mode, and Serial ATA Port1 Mode are configurable only when the ON-Chip Serial ATA item is not set to [Disabled].

Serial ATA Port0 Mode

Primary Master	Remap SATA Port 0 to IDE Pri. Master.
Primary Slave	Remap SATA Port 0 to IDE Pri. Slave.
Secondary Master	Remap SATA Port 0 to IDE Sec. Master.
Secondary Slave	Remap SATA Port 0 to IDE Sec. Slave.
P-SATA master	Remap SATA port 0 to P-SATA Master.
S-SATA master	Remap SATA port 0 to S-SATA Master.

Onboard Device : Scroll to this item and press <Enter> to view the following screen:

USB Controller: Select Enabled if your system contains a Universal Serial Bus (USB) controller and you have USB peripherals

USB 2.0 Controller

Disable this function if you are not using onboard USB 2.0 feature.

Enabled	Enable USB 2.0 Controller.
Disabled	Disable USB 2.0 Controller.

USB Keyboard Support : Select Enabled if your system contains a Universal Serial Bus (USB) controller and you have a USB keyboard.

USB Mouse Support: Select Enabled if you need to use a USB interfaced Mouse in the operating system

SuperIO Device : Scroll to this item and press <Enter> to view the following screen:

Watch Dog : Enable / Disable the Watch dog function.

By Pass Function : Enable / Disable the LAN By Pass Function

LPT/LCM CONTROL :Use this option to enable and configure or disable the LPT/LCM port present on the evaluation board.
Configuration options: LPT / LCM

SIGNAL DUAL STATUS LED

This setting is to set the status when the system is powered on.

Configuration options: Green / RED

STATUS LED

This setting is to set the status when the system is powered.

Configuration options: Always Blight / DARK / 0.1 sec BLINK / 0.5 sec BLINK

Onboard Serial Port 1 / Port 2 : Select an address and corresponding interrupt for the first and second serial ports. The settings are “3F8/IRQ4”, “2E8/IRQ3”, “3E8/IRQ4”, “2F8/IRQ3”, “Disabled”, “Auto”.

Onboard Parallel Port : This item allows you to determine onboard parallel port controller I/O address setting. The settings are “378H/IRQ7”, “278H/IRQ5”, “3BC/IRQ7”, “Disabled”.

Parallel Port Mode : Select an operating mode for the onboard parallel (printer) port. Select “Normal”, “Compatible”, or “SPP” unless you are certain your hardware and software both support one of the other available modes.

EPP Mode Select : Select EPP port type 1.7 or 1.9.

ECP Mode Use DMA : Select a DMA channel for the parallel port for use during ECP mode. The settings are “3” and “1”.

3.7 Power Management Setup

The Power Management Setup allows you to configure your system to most effectively save energy while operating in a manner consistent with your own style of computer use.

ACPI Function	[Enabled]	Item Help
Power Management	[User Define]	
Video Off In Suspend	[Yes]	Menu Level ▶
Video Off Method	[DPMS]	
Suspend Type	[Stop Grant]	
Suspend Mode	[Disabled]	
HDD Power Down	[Disabled]	
Soft-Off by PWR-BTTN	[Instant-Off]	
Wake-Up by PCI card	[Enabled]	
Resume by Alarm	[Disabled]	
x Date (of Month) Alarm	0	
x Time (hh:mm:ss) Alarm	0 : 0 : 0	
FDD, COM, LPT Port	[Disabled]	
PWRON After PWR-Fail	[Off]	

ACPI Function : This item allows you to enable or disable the Advanced Configuration and Power Management (ACPI). The settings are “Enabled” and “Disabled”.

Power Management :

This category allows you to select the type (or degree) of power saving and is directly related to the following modes:

1. HDD Power Down
2. Doze Mode
3. Suspend Mode

There are four selections for Power Management, three of which have fixed mode settings.

Disable (default)	No power management. Disables all four modes
Min. Power Saving	Minimum power management. Doze Mode = 1 hr. Standby Mode = 1 hr., Suspend Mode = 1 hr., and HDD Power Down = 15 min.
Max. Power Saving	Maximum power management – ONLY AVAILABLE FOR SL CPU's. Doze Mode = 1 min., Standby Mode = 1 min., Suspend Mode = 1 min., and HDD Power Down = 1 min.
User Defined	Allows you to set each mode individually. When not disabled, each of the ranges are from 1 min. to 1 hr. except for HDD Power Down which ranges from 1 min. to 15 min. and disable.

Video Off In Suspend This determines the manner in which the monitor is blanked.
Configuration options: Suspend->off / Always ON

Video Off Method

This determines the manner in which the monitor is blanked.

V/H SYNC+Blank	This selection will cause the system to turn off the vertical and horizontal synchronization ports and write blanks to the video buffer.
Blank Screen	This option only writes blanks to the video buffer.
DPMS	Initial display power management signaling.

Suspend Type

Select the Suspend Type. Configuration options: PWRON Suspend / Stop Grant

Suspend Mode

When enabled and after the set time of system inactivity, all devices except the CPU will be shut off. Configuration options: Disabled / 1 Min / 2 Min / 4 Min / 8 Min / 12 Min / 20 Min / 30 Min / 40 Min / 1 Hour .

HDD Power Down

When enabled and after the set time of system inactivity, the hard disk drive will be powered down while all other devices remain active.

Configuration options: Disabled / 1 Min / 2 Min / 3 Min / 4 Min / 5 Min / 6 Min / 7 Min / 8 Min / 9 Min / 10 Min / 11 Min / 12 Min / 13 Min / 14 Min / 15 Min

Soft-Off by PWR-BTTN : When set to delay 4 sec, the function allows the power button to put the system in Suspend, a power saving mode. When set to Instant-off the Soft-Off by PWR-BTTN function is disable and the computer turns completely off when the power button is pressed.

Wake-Up by PCI card: Enable this selection to use the Wake up by PCI card.

Resume by Alarm

You can set "Resume by Alarm" item to enabled and key in Data/ time to power on system.

Disabled	Disable this function.
Enabled	Enable alarm function to POWER ON system. If RTC Alarm Lead To Power On is Enabled. Date (of Month) Alarm : Every day , 1~31 Time (hh: mm: ss) Alarm : (0~23) : (0~59) : (0~59)

FDD,COM,LPT Port

Configuration options: Enabled / Disabled

PWRON After PWR-Fail : Select Enabled, this setting will let the power switch always under on-line status after commercial power back to normal.

3.8 PnP/PCI Configuration

This section describes configuring the PCI bus system. PCI, or **Personal Computer Interconnect**, is a system which allows I/O devices to operate at speeds nearing the speed the CPU itself uses when communicating with its own special components. This section covers some very technical items and it is strongly recommended that only experienced users should make any changes to the default settings.

		Item Help
Reset Configuration Data	[Disabled]	
Resources Controlled By	[Manual]	Menu Level ▶
▶ IRQ Resources	[Press Enter]	
PCI/VGA Palette Snoop	[Disabled]	
** PCI Express relative items **		
Maximum Payload Size	[4096]	When resources are controlled manually, assign each system interrupt a type, depending on the type of device using the interrupt

Reset Configuration Data

Normally, you leave this field Disabled. Select Enabled to reset Extended System Configuration Data (ESCD) when you exit Setup if you have installed a new add-on and the system reconfiguration has caused such a serious conflict that the operating system can not boot.

Configuration options: Enabled / Disabled

Resource controlled by

The Award Plug and Play BIOS has the capacity to automatically configure all of the boot and Plug and Play compatible devices. However, this capability means absolutely nothing unless you are using a Plug and Play operating system such as Windows95. If you set this field to "manual" choose specific resources by going into each of the sub menu that follows this field (a sub menu is preceded by a "!").

Configuration options: Auto (ESCD) / Manual

PCI/VGA Palette Snoop

Leave this field at Disabled.

Configuration options: Enabled / Disabled

Maximum Payload Size : The maximum TLP payload size for the device. As a receiver, the device must handle TLPs as large as the set value; as transmitter, the device must not generate TLPs exceeding the set value. range 128b ~ 4 Kb , default 4Kb PS: TLP = Transaction Layer Packet

3.9 PC Health Status

Shutdown Temperature	[Disabled]	
CPU Warning Temperature	[Disabled]	
Current System Temp	32°C /	89°F
Current CPU1 Temperature	46°C /	114°F
Current CPU2 Temperature	32°C /	89°F
Fan1 Speed	0	RPM
Fan2 Speed	4383	RPM
Fan3 Speed	0	RPM
Vcore0	1.32V	
+12VIN	11.79V	
-12VIN	- 12.03V	
Vcore1	1.18V	
VCC (V)	4.99V	
VBAT (V)	3.04V	
5VSB (V)	4.72V	

CPU Temperature

Detect CPU temperature automatically.

System Temperature

Detect System temperature automatically.

FAN 1 / FAN 2 / FAN 3

Detect Fan1 / FAN2 speed status automatically .

Vcore / +1.5V / +3.3V / +5V / +12V / -12V / -5V / +2.6V / VBAT

Detect system' s voltage status automatically .

3.10 Load Optimized Defaults

When you press <Enter> on this item you get a confirmation dialog box with a message similar to:

Load Optimized Defaults (Y/N) ? N

3.11 Supervisor/User Password Setting

You can set either supervisor or user password, or both of them. The differences between are:

Supervisor password: can enter and change the options of the setup menus.

User password: just can only enter but do not have the right to change the options of the setup menus. When you select this function, the following message will appear at the center of the screen to assist you in creating a password.

ENTER PASSWORD:

Type the password, up to eight characters in length, and press <Enter>. The password typed now will clear any previously entered password from CMOS memory. You will be asked to confirm the password. Type the password again and press <Enter>. You may also press <Esc> to abort the selection and not enter a password.

To disable a password, just press <Enter> when you are prompted to enter the password. A message will confirm the password will be disabled. Once the password is disabled, the system will boot and you can enter Setup freely.

PASSWORD DISABLED:

When a password has been enabled, you will be prompted to enter it every time you try to enter Setup. This prevents an unauthorized person from changing any part of your system configuration.

Additionally, when a password is enabled, you can also require the BIOS to request a password every time your system is rebooted. This would prevent unauthorized use of your computer.

You determine when the password is required within the BIOS Features Setup Menu and its Security option (see Section 3). If the Security option is set to “System”, the password will be required both at boot and at entry to Setup. If set to “Setup”, prompting only occurs when trying to enter Setup.

3.12 Save and Exit Setup

Pressing <Enter> on this item asks for confirmation:

Save to CMOS and EXIT (Y/N)? Y

Pressing “Y” stores the selections made in the menus in CMOS – a special section of memory that stays on after you turn your system off. The next time you boot your computer, the BIOS configures your system according to the Setup selections stored in CMOS. After saving the values the system is restarted again.

3.13 Exit Without Saving

Pressing <Enter> on this item asks for confirmation:

Quit without saving (Y/N)? Y

This allows you to exit Setup without storing in CMOS any change. The previous selections remain in effect. This exits the Setup utility and restarts your computer.

Appendix A

Power Supply

Power Supply Specification

AC Input Spec :

VOLTAGE 90 ~ 264 VAC FULL RANGE

Output Specifications

Output Voltage	Output Current Min.	Output Current Max.	Output Current Peak	Regulation Load	Regulation Line	Output Ripple & Noise Max.[P-P]
5V	2	30.00		± 5%	± 1%	50mV
12V	2	32.00		± 5%	± 1%	120mV
-5V	0.05	0.70		+5 ~ -10%	± 1%	120mV
-12V	0.05	0.70		+5 ~ -10%	± 1%	120Mv
3.3V	1	24		± 5%	± 1%	50mV
+5VSB	0.1	2		+ 6 ~ -5%	± 1%	50mV

Feature :

- *Active PFC (full range), MEET IEC-1000-3-2 CLASS D
- *12V Max. Current : 32A
- *EMPERATURE RANGE : OPERATING 0 ~ 40 , STORAGE -20 ~ 70
- *DUAL EMI NOISE INLET FILTER: FCC CLASS B, CISPR22 CLASS B
- *SAFETY: UL 1950, CSA 22.2 NO/ 950, TUV IEC 950
- *HOT-SWAPPABLE / HOT-PLUGGABLE REDUNDANCY FUNCTION
- *Use 48-pins industrial connectors
- *Cooling: TWO 38x38x28 mm DC FANS
- *AC Inlet in each module

Appendix B

Watchdog Timer

Introduction

Most systems need to be self-reliant. It's not usually possible to wait for someone to reboot them if there are some component wrong. Some system designs, such as space probes, are simply not accessible to human operators. If the system ever hangs, such systems are permanently disabled. In other cases, the speed with which a human operator might reset the system would be too slow to meet the uptime requirements of the product.

A watchdog timer is a piece of hardware that can be used to automatically detect system anomalies and reset the processor if any occur. Generally speaking, a watchdog timer is based on a counter that counts down from some initial value to zero. The software selects the counter's initial value and periodically restarts it. If the counter ever reaches zero before the software restarts it, the software is presumed to be malfunctioning and the processor's reset signal is asserted. The processor will be restarted as if a human operator had cycled the power.

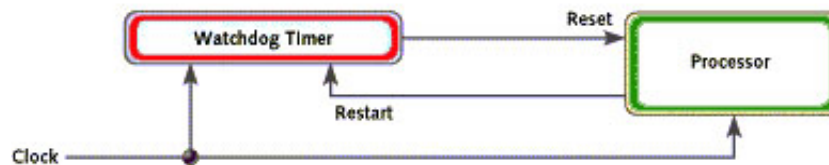

Notes : The watchdog function is design from the Intel 6300ESB. Lanner provide the sample code and Intel 6300ESB datasheet in the manual/driver CD. The path is under //WATCHDOG

Appendix C

Console Redirection

Console redirection allows you to maintain a system from a remote location by re-directing keyboard input and text output through the serial port. This section will tell you how to use console redirection.

1. Please insert console cable between on FW-7890 and Remote Client System.
2. Setup BIOS in FW-7890.
BIOS → Advanced Chipset Features → Baud Rate : 115200 (Default)
BIOS → Advanced Chipset Features → Console Redirection : Enabled(Default)

Enabled	Attempt to redirect console via COM port.
Disabled	Attempt to redirect console when keyboard absent.
Auto	If keyboard is plug in the Controller board, the Console Redirection will not display BIOS screen on remote client. If keyboard is not plug in the Controller board, the Console Redirection will display BIOS screen on remote client.

3. Configure Console redirection on client system. This example is for Windows platform.
 - i . Click the Start button, point to **programs → Accessories → Communications**, and click **Hyper Terminal**.
 - ii. Enter any name for the new connection and select any icon.
 - iii. Click OK.
 - iv. From the Connect to pull-down menu, select a COM port available on your client system and click OK.
 - v. Select **Baud Rate → 115200** , **Flow control →None** , **Data bit→8** , **Parity check → None** , **Stop bit → 1**.
4. Power on FW-7890 and it will display the bios information on the client system.

Appendix D

LCD Module and Key Pad For FW-7890

Purpose

The purpose of this document is to provide installation information for the LCD module and key pad installed in the FW-7890.

Specification overview

The LCD module is designed to provide real-time operating status and configuration information for the system. You can reference the document in the Manual/Driver CD for detail specification. The path is under //LCM/LCD_Datasheet.pdf.

The Driver and library is in the Manula/Driver CD. The path is under //LCM

How to install the driver in Windows 2000/XP.

In the W2K_WinXP folder,

[LCM.SYS → Windows 2000/XP Driver](#)

[LCM.REG → Windows 2000/XP Registry](#)

1. In Windows 2000, copy LCM.SYS to \\Winnt\system32\drivers
In Windows XP , copy LCM.SYS to \\windwos\system32\drivers
2. Double click the LCM.REG and select “YES”
3. Restart the system.

[LCM1.LIB → LCM & Keypad library](#)

1. Copy LCM1.LIB to your make tool directory.
2. If you use "Visual Studio C", add LCM1.LIB path to your Complie Setting

How to install in Linux

[LLCM1.O → LCM & Keypad library](#)

1. Copy LCM1.O to your make tool directory.
Ex. if your test program file name is 'LLCM2.c'
2. Compile: 'gcc LLCM1 -o LLCM2 LLCM2.c'
then use root to run ./LLCM2 for excution.

LCM & KeyPad Function Library description

Description :

1. Clear_LCM();

=>This Function is Clear the LCD Module.

=>Direct write the function to your program.

2.Read_KeyPad();

=>This Function get the KeyPad number if user pressed key.

=>Direct write function to your program.

Ex.

```
int a;  
a=Read_KeyPad();
```

Return Value: "1"=>The Upper Key

"2"=>The Down Key

"3"=>The Enter Key

"4"=>The ESC Key

3.Show_Data(int Dp_Type1,int Dp_Type2,int Dp_Type3,int Dp_Type4, char *Showdata1, char *Showdata2);

=>Show string Function.

=>Dp_type1 => Entry Mode Set

=>Dp_type2 => Display On/Off

=>Dp_type3 => Shift

=>Dp_type4 => Set Function

Please refer the Data Sheet about LCM and Use Decimal to input

=>Showdata1 & Showdata2 are the strings that you want to show.

=>Showdata1 Shown on Line1 Limited between 20 Character

=>Showdata2 Shown on Line2 Limited between 20 Character

Ex.

```
Show_data(0,15,0,56,"1234","5678");
```

Appendix E

LAN Bypass Function

Introduction

The bypass function is used to link (or short) two independent ethernet ports when the system crashes or power is off. That means if there are some conditions in your system, with the LAN Bypass function, it will not interrupt your network traffic.

There are two communication states for the bypass function, one is Normal state and another is Bypass state. Lanner provides three states to enable the LAN Bypass function.

1. When the system powers off, it will be forced to enable the LAN Bypass function.
2. Customers can enable/disable the LAN Bypass function via programming Intel 6300ESB GPIO 19.
3. A watchdog timer (WDT) can be used to control the LAN bypass function via programming Intel 6300ESB GPIO 18.

Please reference the Intel 6300ESB datasheet in the Manual/Driver CD. The path is under //LAN_Bypass. Lanner also provides sample code for customer reference.

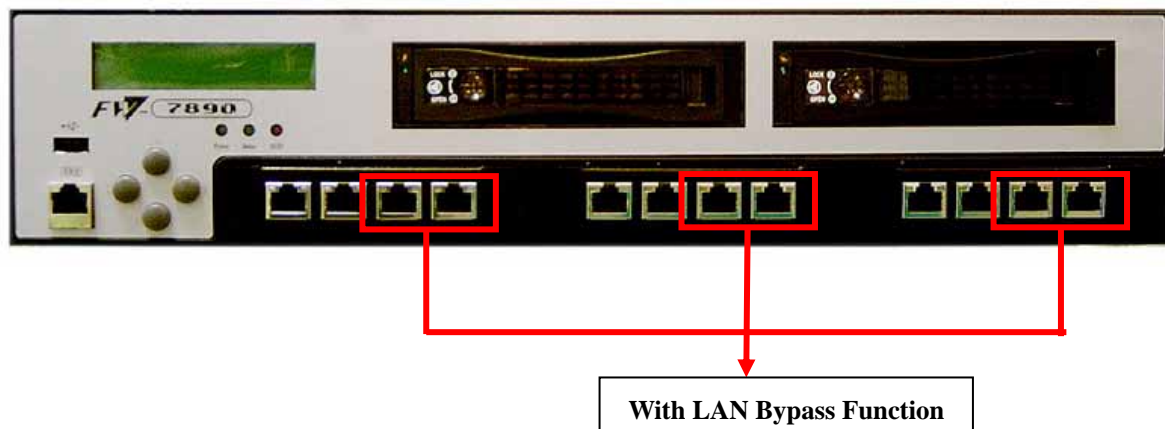

Terms and Conditions

Date:2004.07.08

Warranty Policy

1. All products are warranted against defects in materials and workmanship for a period of two years from the date of your purchase.
2. The buyer will bear the return freight charges for goods returned for repair within the warranty period; whereas manufacturer will bear the after service freight charges back to user site.
3. The buyer will pay for repair (for replaced components plus service time) and transportation charges (both ways) for items after the expiration of the warranty period.
4. If the RMA Service Request Form does not meet the stated requirement as listed on “RMA Service“, RMA goods will be returned at customer’s expense.
5. The following conditions resulting to the defective goods are excluded from this warranty:
 - A. Improper or inadequate maintenance by the customer
 - B. Unauthorized modification, misuse, or reversed engineering of the product
 - C. Operation outside of the environmental specifications for the product.

RMA Service

1. Requesting for a RMA#:

To obtain a RMA number, simply fill out and fax the “RMA Request Form” to your supplier.

2. Shipping:

- A. The customer is required to fill up the problem code as listed. If your problem is not among the codes listed, please write the symptom description on the remark.
- B. Ship the defective unit(s) on freight prepaid terms.
- C. Mark the RMA # clearly on the box.
- D. Customer is responsible for shipping damage(s) resulting from inadequate/loose packing of the defective unit(s).
- E. Use the original packing materials whenever possible.

3. All RMA# are valid for 30 days only:

RMA goods received after the effective RMA# period will be rejected.

RMA Service Request Form

When requesting RMA service, please fill out this **RMA Service Request Form**.

Without this form your RMA will be REJECTED!!!

RMA No: _____		Reasons to Return: <input type="checkbox"/> Repair(Please include failure details) <input type="checkbox"/> Testing Purpose	
Company: _____		Contact Person: _____	
Phone No. _____		Purchased Date: _____	
Fax No.: _____		Applied Date: _____	
Return Shipping Address: _____			
Shipping by: <input type="checkbox"/> Air Freight <input type="checkbox"/> Sea <input type="checkbox"/> Express _____ <input type="checkbox"/> Others: _____			
Item	Model Name	Serial Number	Configuration

Item	Problem Code	Failure Status

*Problem Code:

- | | | | |
|------------------------|------------------------------|--------------------|--------------------------|
| 01:D.O.A. | 07: BIOS Problem | 13: SCSI | 19: DIO |
| 02: Second Time R.M.A. | 08: Keyboard Controller Fail | 14: LPT Port | 20: Buzzer |
| 03: CMOS Data Lost | 09: Cache RMA Problem | 15: PS2 | 21: Shut Down |
| 04: FDC Fail | 10: Memory Socket Bad | 16: LAN | 22: Panel Fail |
| 05: HDC Fail | 11: Hang Up Software | 17: COM Port | 23: CRT Fail |
| 06: Bad Slot | 12: Out Look Damage | 18: Watchdog Timer | 24: Others (Pls specify) |

Request Party

Confirmed By Supplier

Authorized Signatures / Date

Authorized Signatures / Date

PEXNSD01-040709
Version 1.0
Printed and published in Taiwan

Free Manuals Download Website

<http://myh66.com>

<http://usermanuals.us>

<http://www.somanuals.com>

<http://www.4manuals.cc>

<http://www.manual-lib.com>

<http://www.404manual.com>

<http://www.luxmanual.com>

<http://aubethermostatmanual.com>

Golf course search by state

<http://golfingnear.com>

Email search by domain

<http://emailbydomain.com>

Auto manuals search

<http://auto.somanuals.com>

TV manuals search

<http://tv.somanuals.com>