

LANTRONIX®



PremierWave® XC User Guide

Part Number 900-598
Revision A June 2012

Copyright & Trademark

© 2012 Lantronix, Inc. All rights reserved. No part of the contents of this book may be transmitted or reproduced in any form or by any means without the written permission of Lantronix.

Lantronix® and PremierWave® are registered trademarks, and DeviceInstaller™ is a trademark of Lantronix, Inc.

Ethernet is a trademark of XEROX Corporation. Windows is a trademark of Microsoft Corporation. Linux is a registered trademark of Linus Torvalds.

Warranty

For details on the Lantronix warranty policy, please go to our web site at www.lantronix.com/support/warranty.

Contacts

Lantronix Corporate Headquarters

167 Technology Drive
Irvine, CA 92618, USA

Toll Free: 800-526-8766
Phone: 949-453-3990
Fax: 949-450-7249

Technical Support

Online: www.lantronix.com/support

Sales Offices

For a current list of our domestic and international sales offices, go to the Lantronix web site at www.lantronix.com/about/contact.

Disclaimer

This equipment has been tested and found to comply with the limits for a Class B digital device, pursuant to part 15 of the FCC Rules. These limits are designed to provide reasonable protection against harmful interference in a residential installation. This equipment generates, uses and can radiate radio frequency energy and, if not in-stalled and used in accordance with the instructions, may cause harmful interference to radio communications. However, there is no guarantee that interference will not occur in a particular installation. If this equipment does cause harmful interference to radio or television reception, which can be determined by turning the equipment off and on, the user is encouraged to try to correct the interference by one or more of the following measures:

- ♦ Reorient or relocate the receiving antenna.
- ♦ Increase the separation between the equipment and receiver.
- ♦ Connect the equipment into an outlet on a circuit different from that to which the receiver is connected.
- ♦ Consult the dealer or an experienced radio/ TV technician for help.

FCC Part 15.21 Statement

Changes or modifications made to this equipment not expressly approved by the party responsible for compliance could void the user's authority to operate the equipment.

FCC RF Radiation Exposure Statement

This equipment complies with FCC radiation exposure limits set forth for an uncontrolled environment. End users must follow the specific operating instructions for satisfying RF exposure compliance. This transmitter must be at least 20 cm from the user and must not be co-located or operating in conjunction with any other antenna or transmitter.

The information in this guide may change without notice. The manufacturer assumes no responsibility for any errors that may appear in this guide.

Revision History

Date	Rev.	Comments
June 2012	A	Initial document for firmware release 7.2.0.0.

Table of Contents

Copyright & Trademark _____	2
Warranty _____	2
Contacts _____	2
Disclaimer _____	2
FCC Part 15.21 Statement _____	3
FCC RF Radiation Exposure Statement _____	3
Revision History _____	3
List of Figures _____	10
List of Tables _____	10
1: Using This Guide	12
Purpose and Audience _____	12
Summary of Chapters _____	12
Additional Documentation _____	13
2: Introduction	14
Key Features _____	14
Applications _____	14
Protocol Support _____	15
Troubleshooting Capabilities _____	15
Configuration Methods _____	15
Addresses and Port Numbers _____	16
Hardware Address _____	16
IP Address _____	16
Port Numbers _____	16
Product Information Label _____	16
3: Installation of PremierWave XC	18
Package Contents _____	18
User-Supplied Items _____	18
Hardware Components _____	19
Back Panel _____	20
Reset Button _____	20
Top Panel _____	21
Side Panel _____	22
Bottom Panel _____	23
Installing the PremierWave XC _____	23

4: Using DeviceInstaller	26
Accessing PremierWave XC using DeviceInstaller _____	26
5: Configuration Using Web Manager	29
Accessing Web Manager _____	29
Device Status Page _____	30
Web Manager Page Components _____	31
Navigating the Web Manager _____	32
6: Network Settings	34
WAN Connection Settings _____	34
To Configure WAN Connection Settings _____	34
DDNS Settings _____	34
To View or Configure DDNS Settings _____	35
Network 1 Interface Settings _____	35
To Configure Network 1 Interface Settings _____	37
To View Network 1 Interface Status _____	37
Network 1 Link Settings _____	37
To Configure Network 1 Link Settings _____	38
Network 2 Interface Status _____	38
To View Network 2 Interface Status _____	38
Network 2 SMS Outbound Settings _____	38
To Configure Network 2 SMS Outbound Settings _____	39
Network 2 SMS Inbound Settings _____	39
To Configure Network 2 SMS Inbound Settings _____	40
Network 2 Roam Settings _____	40
To Configure Network 2 Roam Settings _____	41
Network 2 GSM/GPRS Bands Settings _____	41
To Configure Network 2 GSM/GPRS bands Settings _____	41
Network 2 SIM Pin Settings _____	42
To Configure Network 2 SIM Pin Settings _____	42
Network 2 APN Configuration Settings _____	43
To Configure Network 2 APN Configuration Settings _____	43
Network 2 Carrier Connection Settings _____	44
To Configure Network 2 Carrier Connection Settings _____	44
Network 2 SMS Statistics _____	44
To View Network 2 SMS Statistics _____	44
7: Line and Tunnel Settings	46
RS232/RS422/RS485 _____	46
Line Settings _____	46
Configuration _____	46
Command Mode _____	47

To Configure Line Settings _____	48
Statistics _____	48
To View Line Statistics _____	48
Tunnel Settings _____	49
Serial Settings _____	49
To Configure Tunnel Serial Settings _____	50
Packing Mode _____	50
To Configure Tunnel Packing Mode Settings _____	51
Accept Mode _____	51
To Configure Tunnel Accept Mode Settings _____	52
Connect Mode _____	53
To Configure Tunnel Connect Mode Settings _____	54
Disconnect Mode _____	55
To Configure Tunnel Disconnect Mode Settings _____	55
Modem Emulation _____	56
To Configure Tunnel Modem Emulation Settings _____	57
Statistics _____	57
To View Tunnel Statistics _____	57
8: Terminal and Host Settings	58
Terminal Settings _____	58
To Configure the Terminal Network Connection _____	59
To Configure the Terminal Line Connection _____	59
Host Configuration _____	59
To Configure Host Settings _____	60
9: Services Settings	61
DNS Settings _____	61
To View or Configure DNS Settings _____	61
FTP Settings _____	62
To Configure FTP Settings _____	62
Syslog Settings _____	62
To View or Configure Syslog Settings _____	63
HTTP Settings _____	63
To Configure HTTP Settings _____	64
To Configure HTTP Authentication _____	65
RSS Settings _____	66
To Configure RSS Settings _____	66
10: Security Settings	67
SSL Settings _____	67
Certificate and Key Generation _____	67
To Create a New Credential _____	68
Certificate Upload Settings _____	69

To Configure an Existing SSL Credential _____	69
Trusted Authorities _____	70
To Upload an Authority Certificate _____	70
11: Maintenance and Diagnostics Settings	71
Filesystem Settings _____	71
File Display _____	71
To Display Files _____	71
File Modification _____	72
File Transfer _____	72
To Transfer or Modify Filesystem Files _____	73
Protocol Stack Settings _____	73
To Configure IP Network Stack Settings _____	73
To Configure ICMP Network Stack Settings _____	74
To Configure ARP Network Stack Settings _____	74
To Configure SMTP Network Stack Settings _____	75
To Configure SNMP Network Stack Settings _____	75
Query Port _____	76
To Configure Query Port Settings _____	76
Diagnostics _____	77
Hardware _____	77
To View Hardware Information _____	77
IP Sockets _____	77
To View the List of IP Sockets _____	77
Ping _____	77
To Ping a Remote Host _____	78
Traceroute _____	78
To Perform a Traceroute _____	78
Log _____	79
To Configure the Diagnostic Log Output _____	79
Memory _____	79
To View Memory Usage _____	79
Processes _____	80
To View Process Information _____	80
Route _____	80
To View Route Information _____	80
Threads _____	80
To View Threads Information _____	80
System Settings _____	81
12: Advanced Settings	82
Email Settings _____	82
To View, Configure and Send Email _____	82
Command Line Interface Settings _____	83
Basic CLI Settings _____	83

To View and Configure Basic CLI Settings	83
Telnet Settings	84
To Configure Telnet Settings	84
SSH Settings	85
To Configure SSH Settings	85
XML Settings	85
XML: Export Configuration	85
To Export Configuration in XML Format	86
XML: Export Status	87
To Import Configuration in XML Format	88
Failover Settings	88
Relay Output Settings	90
To Configure Relay Output Settings	90
13: Events	91
Event Overview	91
Event Alerts	91
Events Status and Clearing Events	94
14: Security in Detail	95
Public Key Infrastructure	95
TLS (SSL)	95
Digital Certificates	95
Trusted Authorities	95
Obtaining Certificates	96
Self-Signed Certificates	96
Certificate Formats	96
OpenSSL	96
Steel Belted RADIUS	97
Free RADIUS	97
15: Updating Firmware	98
Obtaining Firmware	98
Loading New Firmware through FTP	99
16: Branding the PremierWave XC	100
Web Manager Customization	100
To Customize Short or Long Names	101

17: Troubleshooting	102
Diagnostic LED States _____	102
Problems and Error Messages _____	102
Appendix A: Technical Support	104
Appendix B: Binary to Hexadecimal Conversions	105
Converting Binary to Hexadecimal _____	105
Conversion Table _____	105
Scientific Calculator _____	105
Appendix C: Compliance	107
Device Label with CE Mark and FCC ID _____	108
RoHS Notice _____	109

List of Figures

Figure 2-1 Product Label	17
Figure 3-1 PremierWave XC Male DB9 DTE Serial Ports	19
Figure 3-2 PremierWave XC Pinout Configuration for RS-232	19
Figure 3-3 PremierWave XC Pinout Configuration for Full Duplex RS-422/485 (4-wire)	19
Figure 3-4 PremierWave XC Pinout Configuration for Half Duplex RS-485 (2-wire)	19
Figure 3-5 PremierWave XC Back Panel View	20
Figure 3-6 PremierWave XC Top View	21
Figure 3-7 PremierWave XC Side View	22
Figure 3-8 PremierWave XC Bottom View	23
Figure 3-9 PremierWave XC Connections	24
Figure 3-10 PremierWave XC SIM Insertion	24
Figure 3-11 PremierWave XC Dimensions	25
Figure 5-1 Device Status Page	30
Figure 5-2 Components of the Web Manager Page	31
Figure 15-1 Filesystem Browser	98
Figure B-1 Hexadecimal Values in the Scientific Calculator	106

List of Tables

Table 3-1 PremierWave XC LEDs and Descriptions	21
Table 3-2 PremierWave XC Side View	22
Table 4-1 Device Detail Summary	26
Table 5-1 Navigating Web Manager	32
Table 6-1 WAN Connection Settings	34
Table 6-2 DDNS Settings	35
Table 6-3 Network Interface Settings	35
Table 6-4 Network 1 (eth0) Link Settings	37
Table 6-5 Network 2 (wwan0) SMS Outbound Settings	38
Table 6-6 Network 2 (wwan0) SMS Inbound Settings	40
Table 6-7 Network 2 (wwan0) Roam Settings	40
Table 6-8 Network 2 (wwan0) GSM/GPRS Bands Settings	41
Table 6-9 Network 2 (wwan0) SIM PIN Settings	42
Table 6-10 Network 2 (wwan0) APN Configuration Settings	43
Table 6-11 Network 2 (wwan0) Carrier Connection Settings	44
Table 6-12 Network 2 (wwan0) SMS Statistics	44
Table 7-1 Line Configuration Settings	46
Table 7-2 Line Command Mode Settings	47
Table 7-3 Tunnel Serial Settings	49
Table 7-4 Tunnel Packing Mode Settings	50
Table 7-5 Tunnel Accept Mode Settings	51
Table 7-6 Tunnel Connect Mode Settings	53

Table 7-7 Tunnel Disconnect Mode Settings	55
Table 7-8 Tunnel Modem Emulation Settings	56
Table 8-1 Terminal on Network and Line Settings	58
Table 8-2 Host Configuration	59
Table 9-1 DNS Settings	61
Table 9-2 FTP Settings	62
Table 9-3 Syslog Settings	62
Table 9-4 HTTP Settings	63
Table 9-5 HTTP Authentication Settings	64
Table 9-6 RSS Settings	66
Table 10-1 Certificate and Key Generation Settings	67
Table 10-2 Upload Certificate Settings	69
Table 10-3 Trusted Authority Settings	70
Table 11-1 File Display Settings	71
Table 11-2 File Modification Settings	72
Table 11-3 File Transfer Settings	72
Table 11-4 IP Network Stack Settings	73
Table 11-5 ICMP Network Stack Settings	74
Table 11-6 ARP Network Stack Settings	74
Table 11-7 SMTP Network Stack Settings	75
Table 11-8 SNMP Network Stack Settings	75
Table 11-9 Query Port Settings	76
Table 11-10 Ping Settings	77
Table 11-11 Traceroute Settings	78
Table 11-12 Log Settings	79
Table 11-13 System Settings	81
Table 12-1 Email Configuration	82
Table 12-2 CLI Configuration Settings	83
Table 12-3 Telnet Settings	84
Table 12-4 SSH Settings	85
Table 12-5 XML Exporting Configuration	86
Table 12-6 Exporting Status	87
Table 12-7 Import Configuration from Filesystem Settings	88
Table 12-8 Failover Settings	88
Table 12-9 Relay Output Settings	90
Table 13-1 Event Alerts Settings	91
Table 16-1 Short and Long Name Settings	101
Table B-1 Binary to Hexadecimal Conversions	105

1: Using This Guide

Purpose and Audience

This guide provides the information needed to configure, use, and update the PremierWave XC. It is intended for software developers and system integrators who are deploying PremierWave in their designs.

Summary of Chapters

The remaining chapters in this guide include:

Chapter	Description
2: Introduction	Main features of the product and the protocols it supports. Includes technical specifications.
3: Installing the PremierWave XC	Instructions for installing the PremierWave XC
4: Using DeviceInstaller	Instructions for viewing the current configuration using DeviceInstaller.
5: Configuration Using Web Manager	Instructions for accessing Web Manager and using it to configure settings for the device.
6: Network Settings	Instructions for configuring network settings.
7: Line and Tunnel Settings	Instructions for configuring line and tunnel settings.
8: Terminal and Host Settings	Instructions for configuring terminal and host settings.
9: Services Settings	Instructions for configuring DNS, DDNS, FTP, HTTP and Syslog settings.
10: Security Settings	Instructions for configuring SSL security settings.
11: Maintenance and Diagnostics Settings	Instructions to maintain the PremierWave XC, view statistics, files, SNMP stack and diagnose problems.
12: Advanced Settings	Instructions for configuring email, failover, CLI and XML settings.
13: Events Configuration	Instructions for configuring events such as Input 1, Input 2, Main Power Fail, Backup Power Fail, Cellular Link Down and Ethernet Link Down to generate alerts.
14: Security in Detail	Detailed description and configuration of SSL security settings.

Chapter	Description
15: Updating Firmware	Instructions for obtaining the latest firmware and updating the PremierWave XC.
16: Branding the PremierWave XC	Instructions on how to brand your device.
17: Troubleshooting	Describes common problems and error messages.
Appendix A: Technical Support	Instructions for contacting Lantronix Technical Support.
Appendix B: Binary to Hexadecimal Conversions	Instructions for converting binary values to hexadecimals.
Appendix C: Compliance	Lantronix compliance information.

Additional Documentation

Visit the Lantronix Web site at www.lantronix.com/support/documentation for the latest documentation and the following additional documentation.

Document	Description
<i>PremierWave XC Command Reference</i>	Instructions for accessing Command Mode (the command line interface) using a Telnet connection, SSH connection or through the serial port. Detailed information about the commands. Also provides details for XML configuration and status.
<i>PremierWave XC Quick Start Guide</i>	Instructions for getting the PremierWave XC up and running.
<i>DeviceInstaller Online Help</i>	Instructions for using the Lantronix Windows-based utility to locate the PremierWave XC and to view its current settings.
<i>Com Port Redirector Quick Start and Online Help</i>	Instructions for using the Lantronix Windows-based utility to create virtual com ports.
<i>Secure Com Port Redirector User Guide</i>	Instructions for using the Lantronix Windows-based utility to create secure virtual com ports.

2: Introduction

The PremierWave XC is a unique, hybrid Ethernet and GSM/GPRS dual port serial device server which allows remote access to and management of virtually any IT/networking equipment or device connected via Ethernet or GPRS through 'Serial-tunneling'. Applications include medical equipment, POS terminals or security equipment.

Key Features

- ♦ **Power Supply:** Flexible power options and input voltage range (one barrel connector for 12V power supply, on terminal block connector for 09-30Vdc power supply)
- ♦ **Controller:** 32-bit ARM9 microprocessor running at 400 megahertz (Mhz) with 32 KB Data Cache and 32 Kilobytes (KB) internally based around the PremierWave EN
- ♦ **Memory:** 64 MB SDRAM and 64 MB NAND Flash 8 MB serial SPI Flash
- ♦ **Ethernet:** 10/100 Mbps Ethernet transceiver
- ♦ **Power:** Redundant Hot Failover Power Supply via Power 1 and Power 2
- ♦ **Serial Ports:** Two RS232/422/485 high-speed serial ports with all hardware handshaking signals. Baud rate is software selectable (300 bps to 921600 bps). Both serial interfaces support RS-485 termination resistors which can be software enabled.
- ♦ **USB Ports:** Two USB 2.0 Full Speed (12 Mbps) Host ports, currently used for USB thumb drive devices for storage
- ♦ **Failover (backup) Data Network Media Support** for either Ethernet or GSM/GPRS
- ♦ **Events** can be configured to generate alerts via SMS, SNMP trap and Relay Output
- ♦ **Temperature Range:** Operates over an extended temperature range of -40°C to +70°C

Applications

The PremierWave XC device server connects serial devices such as those listed below to Ethernet networks using the IP protocol family.

- ♦ ATM machines
- ♦ CNC controllers
- ♦ Data collection devices
- ♦ Universal Power Supply (UPS) management unit
- ♦ Telecommunications equipment
- ♦ Data display devices
- ♦ Security alarms and access control devices
- ♦ Handheld instruments
- ♦ Time/attendance clocks and terminals

Protocol Support

The PremierWave XC device server contains a full-featured IP stack. Supported protocols include:

- ◆ ARP, IP, UDP, TCP, ICMP, BOOTP, DHCP, Auto IP, Telnet, DNS, FTP, TFTP, SSH, SSL/TLS, and Syslog for network communications and management
- ◆ TCP, UDP tunneling to the serial port
- ◆ TFTP for uploading/downloading files
- ◆ FTP and HTTP for firmware upgrades and uploading/downloading files

Troubleshooting Capabilities

The PremierWave XC offers a comprehensive diagnostic toolset that lets you troubleshoot problems quickly and easily. Available from the CLI or Web Manager, the diagnostic tools let you:

- ◆ View critical hardware, memory, MIB-II, buffer pool, IP socket information and routing table
- ◆ Perform ping and traceroute operations
- ◆ Conduct forward or reverse DNS lookup operations
- ◆ View all processes currently running on the PremierWave XC, including CPU utilization
- ◆ View system log messages

Configuration Methods

After installation, the PremierWave XC requires configuration. For the unit to operate correctly on a network, it must have a unique IP address on the network. There are four basic methods for logging into the PremierWave XC and assigning IP addresses and other configurable settings:

Web Manager: View and configure all settings easily through a web browser using the Lantronix Web Manager. (See [Configuration Using Web Manager](#).)

DeviceInstaller: Configure the IP address and related settings and view current settings on the PremierWave XC using a Graphical User Interface (GUI) on a PC attached to a network. (See [Using DeviceInstaller](#).)

Command Mode: There are two methods for accessing Command Mode (CLI): making a Telnet or SSH connection, or connecting a terminal (or a PC running a terminal emulation program) to the unit's serial port. (See the PremierWave XC Command Reference Guide for instructions and available commands.)

XML: The PremierWave XC supports XML-based configuration and setup records that make device configuration transparent to users and administrators. XML is easily editable with a standard text or XML editor. (See the *PremierWave XC Command Reference Guide* for instructions and commands.)

Addresses and Port Numbers

Hardware Address

The hardware address is also referred to as the Ethernet address or MAC address. The first three bytes of the Ethernet address are fixed and identify the unit as a Lantronix product. The fourth, fifth, and sixth bytes are unique numbers assigned to each unit.

Sample Hardware Address:

- ◆ 00-80-A3-14-01-18
- ◆ 00:80:A3:14:01:18

IP Address

Every device connected to an IP network must have a unique IP address. This address references the specific unit.

Port Numbers

Every TCP connection and every UDP datagram is defined by a destination and source IP address, and a destination and source port number. For example, a Telnet server commonly uses TCP port number 23.

The following is a list of the default server port numbers running on the PremierWave XC:

- ◆ TCP Port 22: SSH Server (Command Mode configuration)
- ◆ TCP Port 23: Telnet Server (Command Mode configuration)
- ◆ TCP Port 80: HTTP (Web Manager configuration)
- ◆ UDP Port 161: SNMP
- ◆ TCP Port 21: FTP
- ◆ UDP Port 69: TFTP
- ◆ UDP Port 30718: LDP (Lantronix Discovery Protocol) port
- ◆ TCP/UDP Port 10001: Tunnel 1
- ◆ TCP/UDP Port 10002: Tunnel 2

Product Information Label

The product information label on the unit contains the following information about the specific unit:

- ◆ Part Number
- ◆ International Mobile Equipment Identity (IMEI) Number
- ◆ Hardware Address (MAC Address)
- ◆ Country of Origin
- ◆ Revision
- ◆ Manufacturing Date Code

Figure 2-1 Product Label



3: *Installation of PremierWave XC*

This chapter describes how to install the PremierWave XC device server. It contains the following sections:

- ♦ *Package Contents*
- ♦ *User-Supplied Items*
- ♦ *Hardware Components*
- ♦ *Installing the PremierWave XC*

Package Contents

The PremierWave XC package includes the following items:

- ♦ PremierWave XC device
- ♦ 3-pin Terminal Mating Connector
- ♦ 6-pin Terminal Mating Connector
- ♦ RJ-45 Ethernet Straight Cat5 Cable, 1.5 meter
- ♦ External Antenna, SMA Connector
- ♦ Power Supply 12VDC with International Adapters
- ♦ Mounting Components (DIN Rail Mounting Adapter, Cover Plates, and Rubber Feet)
- ♦ Quick Start Guide

User-Supplied Items

To complete your installation, you need the following items:

- ♦ RS-232/422/485 serial devices that require network connectivity.
 - A serial cable, as listed below, for each serial device. One end of the cable must have a female DB9 connector for the serial port.
 - A null modem cable to connect the serial port to another DTE device.
 - A straight-through modem cable to connect the serial port to a DCE device.
- ♦ An available connection to your Ethernet network and an Ethernet cable.
- ♦ A working SIM card from your Network Carrier or Service Provider
- ♦ A working DDNS Account with DynDNS.com
- ♦ A working power outlet if the unit will be powered from an AC outlet using the included 12VDC power supply.
- ♦ An additional power supply (9-30VDC) to power the device using the 3-pin terminal connector.

Hardware Components

The PremierWave XC has two male DB9 serial ports that support RS-232/422/485. [Figure 3-1](#) shows the front panel view of the device. The default serial port settings are 9600 baud, 8 bits, no parity, 1 stop bit, no flow control.

Figure 3-1 PremierWave XC Male DB9 DTE Serial Ports

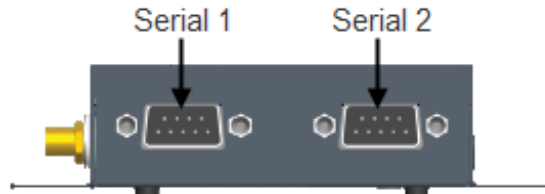

Figure 3-2 PremierWave XC Pinout Configuration for RS-232

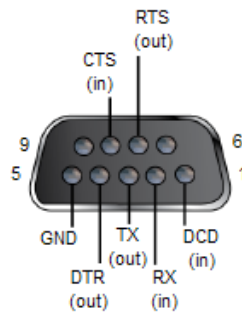

Figure 3-3 PremierWave XC Pinout Configuration for Full Duplex RS-422/485 (4-wire)

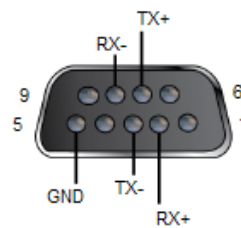
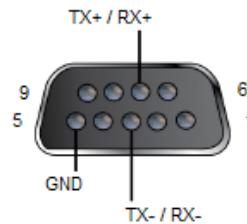

Figure 3-4 PremierWave XC Pinout Configuration for Half Duplex RS-485 (2-wire)



Back Panel

On the PremierWave XC back panel, there is a Barrel Connector for Primary Power (Power 1), 3-Pin Terminal Connector for Secondary Power (Power 2), USB 1, USB 2, RJ-45 Ethernet Port and Reset button as shown in [Figure 3-5](#).

Figure 3-5 PremierWave XC Back Panel View

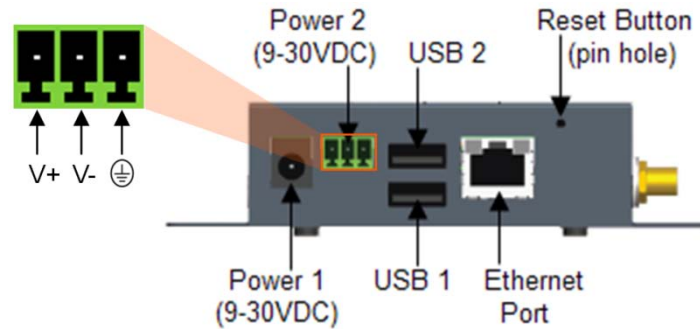

The Ethernet Port has two LEDs that indicate the status of the connection as follows:

- ♦ **Left LED**
 - Green ON 100 Mbps Link
 - Green Blink 100 Mbps Activity
 - Amber ON 10 Mbps Link
 - Amber Blink 10 Mbps Activity
- ♦ **Right LED**
 - Green ON Full Duplex
 - OFF Half Duplex

The Ethernet port can connect to an Ethernet (10 Mbps) or Fast Ethernet (100 Mbps) network.

Reset Button

You can reset the PremierWave XC to factory defaults, including clearing the network settings. The IP address, gateway, and netmask are set to 00s. To reset the unit to factory defaults, perform the following steps.

1. Place the end of a paper clip or similar object into the Reset button opening and hold down for a minimum of 10-15 seconds.
2. Remove the paper clip to release the button. The unit will continue the boot process restoring it back to the original factory default settings.

Top Panel

Figure 3-6 shows the top panel view of the PremierWave XC. Table 3-1 list and describes the LEDs.

Figure 3-6 PremierWave XC Top View

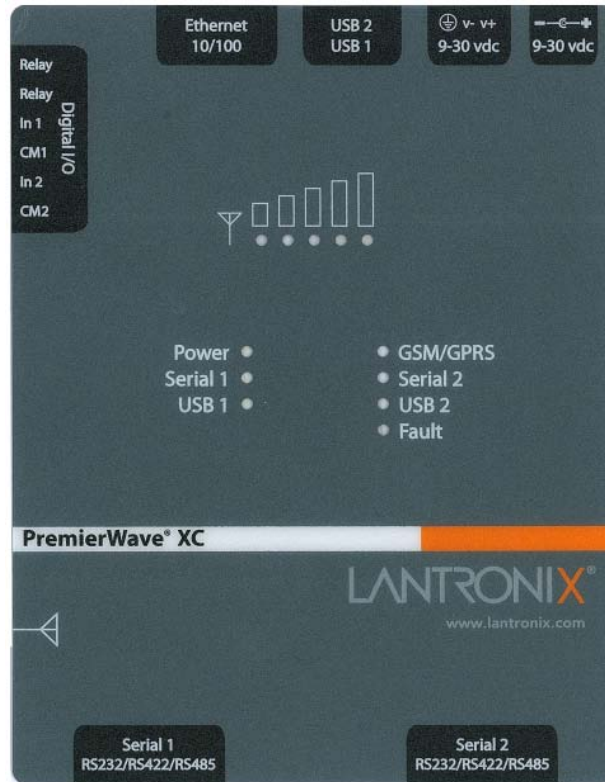

Table 3-1 PremierWave XC LEDs and Descriptions

LED	Description
Power	GREEN – power is properly supplied OFF – no power supplied
GSM/GPRS	GREEN - GPRS is connected (e.g. after an APN has been properly configured) AMBER - GSM is connected. Once the radio connection has been established with the cellular provider. OFF – no connection. Reasons for OFF are that it cannot register with the cellular provider (wrong PIN code, cellular provider unavailable, or incorrect APN).
Serial 1	GREEN – Serial port 1 is transmitting data AMBER – Serial port 1 is receiving data OFF – no data is being transmitted or received through Serial port 1
Serial 2	GREEN – Serial port 2 is transmitting data AMBER – Serial port 2 is receiving data OFF – no data is being transmitted or received through Serial port 2

LED	Description
USB 1	GREEN - a USB device is connected to USB 1 Host port and is functioning properly OFF- no USB device is connected to USB 1 Host port
USB 2	GREEN - a USB device is connected to USB 2 Host port and is functioning properly OFF- no USB device is connected to USB 2 Host port
Fault	RED- blinking when Events or Errors occurred OFF - system functioning normally
GSM Signal Strength	GREEN – 3 to 5 LEDs lighted. Good to Strong signal strength AMBER/GREEN – 1 to 2 bi-colored LEDs lighted. Weak signal strength

Side Panel

On the PremierWave XC side panel, there is a 6-pin Terminal Connector for Relay and I/Os as well as an SMA Antenna Connector as shown in [Figure 3-7](#).

Figure 3-7 PremierWave XC Side View

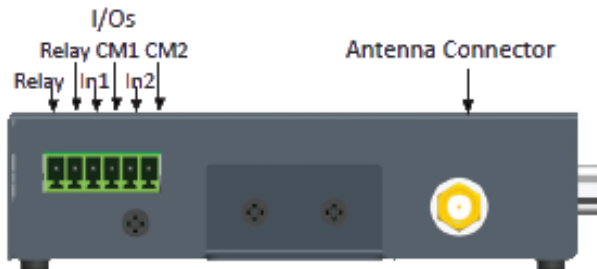

Table 3-2 PremierWave XC Side View

Connector	Description		
Relay Output	Outputs Support 1A 24V		
Inputs	Inputs accept voltage 0 to 30 VDC		
	ON	Max	30 VDC
		Min	2 VDC
	OFF	Max	0.7 VDC
Min		0 VDC	
Antenna	Connect the provided SMA Antenna		

Bottom Panel

On the PremierWave XC bottom panel, there is a SIM cover as shown in [Figure 3-8](#).

Figure 3-8 PremierWave XC Bottom View



Installing the PremierWave XC

Be sure to place or mount the device securely on a flat horizontal or vertical surface. The device comes with mounting brackets for mounting the device vertically, for example on a wall. If using AC power, avoid outlets controlled by a wall switch.

Observe the following guidelines when connecting the serial devices:

- ◆ PremierWave XC serial ports support RS-232/422/485
- ◆ A null modem cable is the best cable to connect the serial port to another DTE device. The straight-through (modem) cable is the best cable to connect the serial port to a DCE device.
- ◆ Connect your RJ-45 Ethernet cable to the RJ-45 serial port of the unit
- ◆ The device supports a power range of 9 to 30 VDC. You can power up the device with the included 12VDC power supply with barrel-power connector and/or the 3-pin terminal connector for backup power supply.

Note: As soon as you plug the device into power, the device powers up automatically, the self-test begins, and LEDs indicate the device's status.

Perform the following steps to install your device (see [Figure 3-9](#)):

1. Remove the SIM compartment door, secured by two screws. Open the SIM slot fastener (sliding top fastener towards Power connector) and Insert the SIM card into the SIM slot (with contacts facing toward main board). Close and lock the SIM slot fastener (sliding top fastener away from Power connector). Secure the SIM compartment door accordingly and secure with screws provided.
2. Connect the Antenna to the SMA connector on the side. Do note that the Safe Distance due to RF exposure from Antenna is 23cm (see [Figure 3-9](#)).

3. Connect serial devices to the serial port of the unit.
4. Connect an RJ-45 Ethernet cable between the unit and your Ethernet network.
5. Plug the PremierWave XC into the power outlet by using the power supply that was included in the packaging.
6. Power up Serial Devices.

Figure 3-9 PremierWave XC Connections

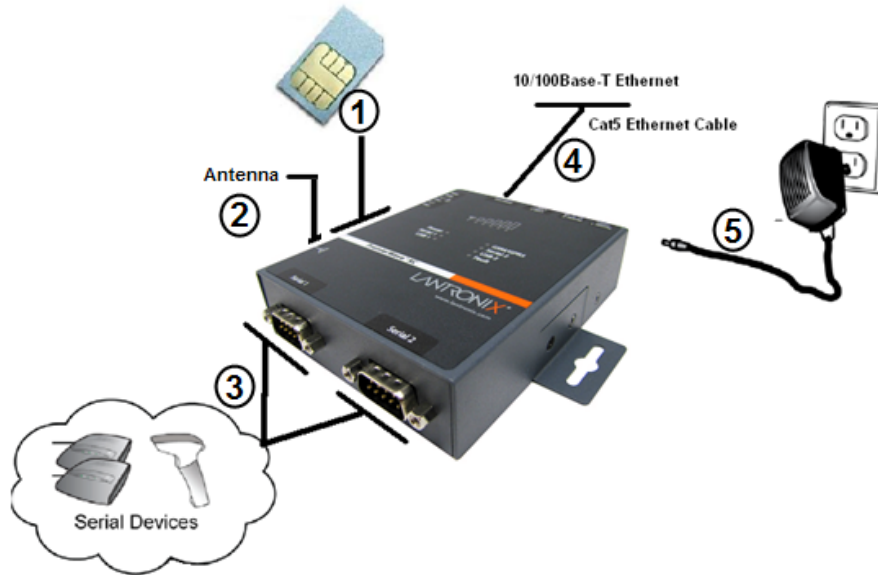

Figure 3-10 PremierWave XC SIM Insertion

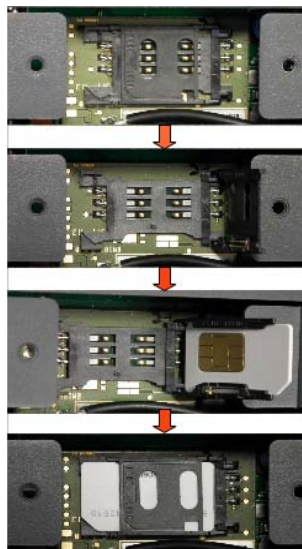
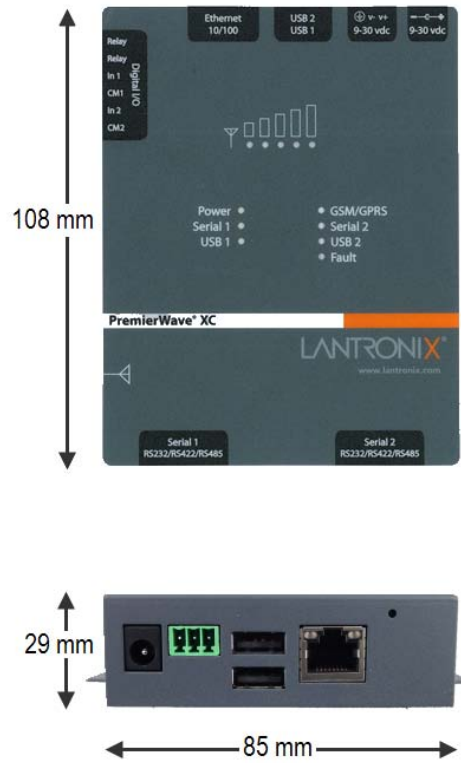

Figure 3-11 PremierWave XC Dimensions



4: Using DeviceInstaller

This chapter covers the steps for locating a PremierWave XC unit and viewing its properties and device details. DeviceInstaller is a free utility program provided by Lantronix that discovers, configures, upgrades and manages Lantronix Device Servers.

Notes:

- ◆ For instructions on using DeviceInstaller to configure the IP address and related settings or for more advanced features, see the DeviceInstaller Online Help.
- ◆ Auto IP generates a random IP address in the range of 169.254.0.1 to 169.254.255.254, with a netmask of 255.255.0.0, if no BOOTP or DHCP server is found.

Accessing PremierWave XC using DeviceInstaller

Notes: Make note of your PremierWave XC MAC address. It is needed to locate the PremierWave XC using DeviceInstaller.

To use the DeviceInstaller utility, first install the latest version from the downloads page on the Lantronix web site <http://www.lantronix.com/downloads>.

1. Run the executable to start the installation process and respond to the installation wizard prompts. (If prompted to select an installation type, select Typical.)
2. Click **Start -> All Programs -> Lantronix -> DeviceInstaller -> DeviceInstaller**.
3. When DeviceInstaller starts, it will perform a network device search. To perform another search, click Search.
4. Expand the PremierWave folder by clicking the + symbol next to the PremierWave folder icon. A list of available Lantronix PremierWave devices appears.
5. Select the PremierWave XC unit by expanding its entry and clicking on its MAC address to view its configuration.
6. On the right page, click the **Device Details** tab. The current PremierWave XC configuration appears. This is only a subset of the full configuration; the full configuration may be accessed via Web Manager, CLI or XML.

Device Detail Summary

Notes: The settings are Display Only in this table unless otherwise noted.

Table 4-1 Device Detail Summary

Current Settings	Description
Name	Name identifying the PremierWave XC.
DHCP Device Name	The name associated with the PremierWave XC module's current IP address, if the IP address was obtained dynamically.

Current Settings	Description
Group	Configurable field. Enter a group to categorize the PremierWave XC. Double-click the field, type in the value, and press Enter to complete. This group name is local to this PC and is not visible on other PCs or laptops using DeviceInstaller.
Comments	Configurable field. Enter comments for the PremierWave XC. Double-click the field, type in the value, and press Enter to complete. This description or comment is local to this PC and is not visible on other PCs or laptops using DeviceInstaller.
Device Family	Shows the PremierWave XC device family type as "PremierWave".
Short Name	Shows the short name of the device as premierwave_xc.
Long Name	Shows the long name of the device as Lantronix PremierWave XC.
Type	Shows the device type as "PremierWave XC".
ID	Shows the PremierWave XC ID embedded within the unit.
Hardware Address	Shows the PremierWave XC hardware (MAC) address.
Firmware Version	Shows the firmware currently installed on the PremierWave XC.
Extended Firmware Version	Provides additional information on the firmware version.
Online Status	Shows the PremierWave XC status as Online, Offline, Unreachable (the PremierWave XC is on a different subnet), or Busy (the PremierWave XC is currently performing a task).
IP Address	Shows the PremierWave XC current IP address. To change the IP address, click the Assign IP button on the DeviceInstaller menu bar.
IP Address was Obtained	Appears "Dynamically" if the PremierWave XC automatically received an IP address (e.g., from DHCP). Appears "Statically" if the IP address was configured manually. If the IP address was assigned dynamically, the following fields appear: <ul style="list-style-type: none"> ◆ Obtain via DHCP with values of True or False. ◆ Obtain via BOOTP with values of True or False.
Subnet Mask	Shows the subnet mask specifying the network segment on which the PremierWave XC resides.
Gateway	Shows the IP address of the router of this network. There is no default.
Number of Ports	Shows the number of serial ports on this PremierWave XC.
Supports Configurable Pins	Shows False, indicating configurable pins are not available on the PremierWave XC.
Supports Email Triggers	Shows True, indicating email triggers are available on the PremierWave XC.

Current Settings	Description
Telnet Supported	Shows True, indicating telnet is supported on this PremierWave XC.
Telnet Port	Shows the PremierWave XC port for Telnet sessions.
Web Port	Shows the PremierWave XC port for Web Manager configuration.
Firmware Upgradable	Shows True, indicating the PremierWave XC firmware is upgradable as newer versions become available.

5: Configuration Using Web Manager

This chapter describes how to configure the PremierWave XC using Web Manager, the Lantronix browser-based configuration tool. The unit's configuration is stored in nonvolatile memory and is retained without power. All changes take effect immediately, unless otherwise noted. It contains the following sections:

- ♦ [Accessing Web Manager](#)
- ♦ [Web Manager Page Components](#)
- ♦ [Navigating the Web Manager](#)

Accessing Web Manager

You can also access the Web Manager by selecting the Web Configuration tab on the DeviceInstaller window.

To access Web Manager, perform the following steps:

- ♦ Open a standard web browser. Lantronix supports the latest version of Internet Explorer, Mozilla Suite, Mozilla Firefox, Safari, Chrome or Opera.
- ♦ Enter the IP address of the PremierWave XC in the address bar. The IP address may have been assigned manually using DeviceInstaller or automatically by DHCP.
- ♦ Enter your username and password. The factory-default username is "admin" and the factory-default password is "PASS." The Device Status web page displays configuration, network settings, line settings, tunneling settings, and product information.

Note: *The Logout button is available on any web page. Logging out of the web page would force re-authentication to take place the next time the web page is accessed.*

Device Status Page

The Device Status page is the first page that appears after you log into the Web Manager. It also appears when you click **Status** in the Main Menu.

Figure 5-1 Device Status Page

PremierWave™ XC
LANTRONIX

- Status ↑
- CLI
- Diagnostics
- DNS
- Email
- Events
- Fail Over
- Filesystem
- FTP
- Host
- HTTP
- Line
- Network
- Protocol Stack
- Query Port
- Relay Output
- RSS
- SSH
- SSL
- Syslog
- System
- Terminal
- Tunnel
- XML

[Logout]

Device Status

Product Information		
Product Type:	Lantronix PremierWave XC (premierwave_xc)	
Firmware Version:	7.2.0.0R29	
Build Date:	Apr 1 13:49:39 CST 2012	
Serial Number:	00204ADA0033	
Uptime:	6 days 01:19:38	
Permanent Config:	Saved	
Power Status		
Main Power:	Up	
Backup Power:	Down	
Network Settings		
Interface:	eth0	
Link:	Auto 10/100 Mbps Auto Half/Full (100 Mbps Full)	
MAC Address:	00:20:4a:da:00:33	
Hostname:	<None>	
IP Address:	172.19.245.50/16	
Default Gateway:	172.19.0.1	
Domain:	<None>	
Primary DNS:	172.19.1.1	
Secondary DNS:	172.19.1.2	
MTU:	1500	
Line Settings		
Line 1:	RS232, 9600, None, 8, 1, None	
Line 2:	RS232, 9600, None, 8, 1, None	
Tunneling		
	Connect Mode	Accept Mode
Tunnel 1:	Disabled	Waiting
Tunnel 2:	Disabled	Waiting
WWAN0 Status		
Interface:	Wwan0	
Link:	Unlink	
IP Address:	<None>	
Netmask:	<None>	
Default Gateway:	<None>	
Primary DNS:	<None>	
Secondary DNS:	<None>	
Connection Time:	0:0:0	
No. of WAN Failures:	0	
GSM Status		
SIM Status:	GSM_SIM_NOT_PRESENT	
Roaming Status:	NO	
Network Name:	<None>	
Link Status:	Unlink	
Signal Strength:	0 (0 dBm)	
GSM/GPRS band:	Auto	
Activity		
Current Status:	Monitoring...	
Service		
Status:	Default network is available	
	Active Network is Ethernet	
DDNS Status:	Disabled	
Domain Name:	<None>	
DDNS Reported Device IP:	<None>	
Events		
Event:	Backup Power Down	
Error Message		
Error:	SIM card is not present	

Copyright © Lantronix, Inc. 2007-2011. All rights reserved.

Web Manager Page Components

The layout of a typical Web Manager page is below.

Figure 5-2 Components of the Web Manager Page

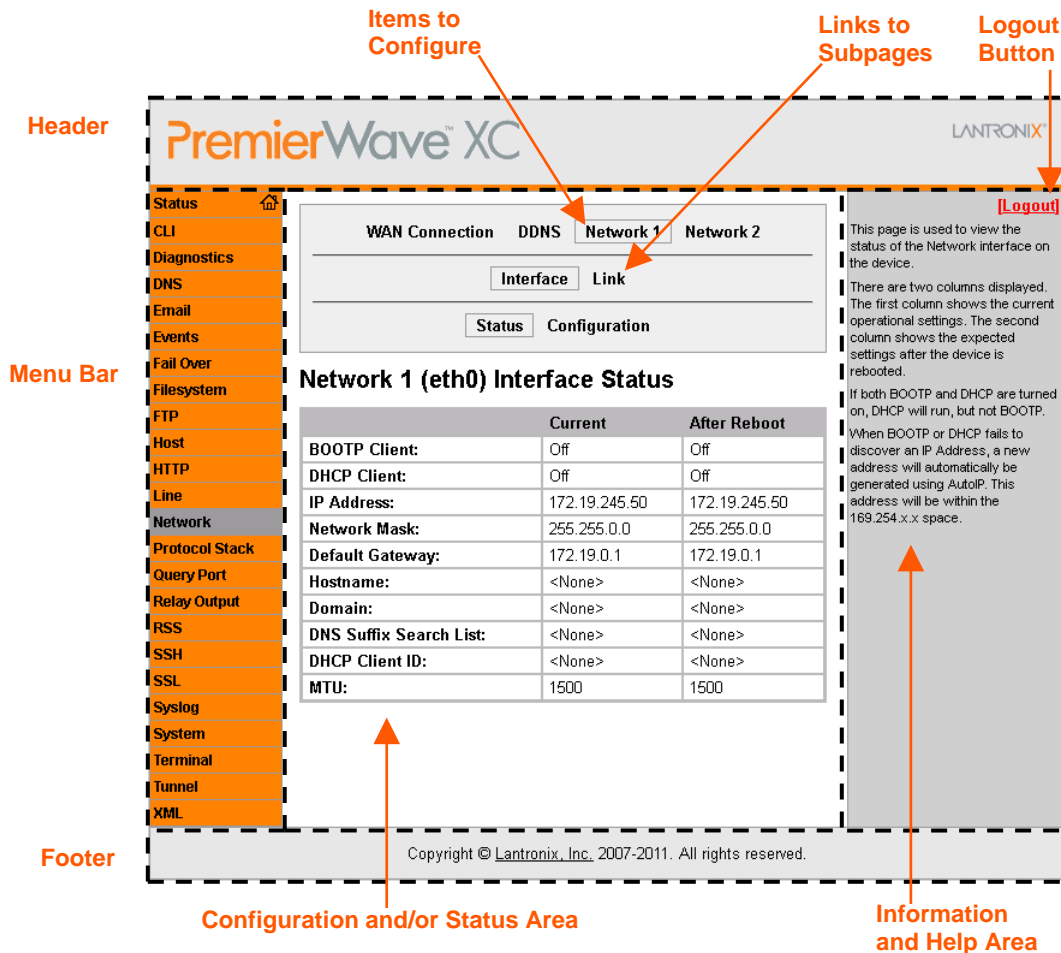

The menu bar always appears at the left side of the page, regardless of the page shown. The menu bar lists the names of the pages available in the Web Manager. To bring up a page, click it in the menu bar.

The main area of the page has these additional sections:

- ◆ At the very top, many pages, such as the one in the example above, enable you to link to sub pages. On some pages, you must also select the item you are configuring, such as a line or a tunnel.
- ◆ In the middle of many pages, you can select or enter new configuration settings. Some pages show status or statistics in this area rather than allow you to enter settings.
- ◆ At the bottom of most pages, the current configuration is displayed. In some cases, you can reset or clear a setting.
- ◆ The information or help area shows information or instructions associated with the page.

- ◆ A **Logout** link is available at the upper right corner of every web page. In Chrome or Safari, it is necessary to close out of the browser to completely logout. If necessary, reopen the browser to log back in.
- ◆ The footer appears at the very bottom of the page. It contains copyright information and a link to the Lantronix home page.

Navigating the Web Manager

The Web Manager provides an intuitive point-and-click interface. A menu bar on the left side of each page provides links you can click to navigate from one page to another. Some pages are read-only, while others let you change configuration settings.

Table 5-1 Navigating Web Manager

Web Manager Page	Description	See Page
Status	Shows product information and network, line, and tunneling settings.	30
CLI	Shows Command Line Interface (CLI) statistics and lets you change the current CLI configuration settings.	83
Diagnostics	Lets you perform various diagnostic procedures.	77
DNS	Shows the current configuration of the DNS subsystem and the DNS cache, and perform DNS Lookup.	61
Email	Shows email statistics and lets you clear the email log, configure email settings, and send an email.	82
Events	Lets you configure the events and alerts that would be used.	91
Failover	Lets you configure Failover.	88
Filesystem	Shows file system statistics and lets you browse the file system to view a file, create a file or directory, upload files using HTTP, copy a file, move a file, or perform TFTP actions.	71
FTP	Shows statistics and lets you change the current configuration for the File Transfer Protocol (FTP) server.	62
Host	Lets you view and change settings for a host on the network.	59
HTTP	Shows HyperText Transfer Protocol (HTTP) statistics and lets you change the current configuration and authentication settings.	63
Line	Shows statistics and lets you change the current configuration and Command mode settings of a serial line.	46

Web Manager Page	Description	See Page
Network	Shows status and lets you configure the network interface, WAN connection, and DDNS.	34
Protocol Stack	Lets you perform lower level network stack-specific activities.	73
Query Port	Lets you change configuration settings for the query port.	76
Relay Output	Lets you change the Initiation State, and customise the Relay output SMS command to open, close Relay Output.	90
RSS	Lets you change current Really Simple Syndication (RSS) settings.	66
SSH	Lets you change the configuration settings for SSH server host keys, SSH server authorized users, SSH client known hosts, and SSH client users.	85
SSL	Lets you upload an existing certificate or create a new self-signed certificate.	67
Syslog	Lets you specify the severity of events to log and the server and ports to which the syslog should be sent.	62
System	Lets you reboot device, restore factory defaults, upload new firmware, and change the device long and short names.	81
Terminal	Lets you change current settings for a terminal.	58
Tunnel	Lets you change the current configuration settings for a tunnel.	49
XML	Lets you export XML configuration and status records, and import XML configuration records.	85

Note: *There may be times when you must reboot the PremierWave XC for the new configuration settings to take effect. The chapters that follow indicate when a change requires a reboot.*

6: Network Settings

The PremierWave XC contains two network interfaces. The Ethernet interface is also called **Network 1** or **eth0**, and the Cellular interface is called **Network 2** or **wwan0**.

The Network Settings show the status of the Ethernet or Cellular interface/link and let you configure the settings on the device. Interface settings are related to the configuration of the IP and related protocols. Link settings are related to the physical link connection, which carries the respective network traffic.

Notes:

- ◆ Some settings require a reboot to take effect. These settings are noted below.
- ◆ The blue text in the XML command strings of this chapter are to be replaced with a user-specified name.

WAN Connection Settings

Table 6-1 shows the settings for the Wide Area Network (WAN) that can be configured.

Table 6-1 WAN Connection Settings

WAN Connection Settings	Description
Network	Select Wwan0 or Eth0 to be your default connection.

To Configure WAN Connection Settings

Using Web Manager

- ◆ To configure WAN Connection settings, click **Network** in the menu bar and select **WAN Connection**.

Using the CLI

- ◆ To enter the WAN Connection command level: `enable -> config -> wan connection`

Using XML

- ◆ Include in your file: `<configgroup name="wan connection">`

DDNS Settings

This section describes the configuration settings for DynDNS (DDNS). You would need an account with DynDns.com. This would allow the device to connect to a sub-domain with regularly changing IP address.

Table 6-2 DDNS Settings

Note: A valid account with DynDNS.com is necessary for this service to work.

Setting / Field	Description
State	Select Enabled or Disabled .
User Name	Enter or modify DDNS account user name.
Password	Enter or modify DDNS account password.
Domain	Enter or modify DDNS account host domain.

To View or Configure DDNS Settings

Using Web Manager

- ◆ To configure DDNS settings, click **Network** in the menu bar and select **DDNS**.

Using CLI

- ◆ To configure DDNS command level: `enable -> config -> ddns`

Using XML

- ◆ Include in your file: `<configgroup name="ddns">`

Network 1 Interface Settings

Table 6-3 shows the network interface settings for Ethernet that can be configured. These settings apply to the Ethernet (eth0) only.

Table 6-3 Network Interface Settings

Network Interface Settings	Description
BOOTP Client	<p>Select On or Off. At boot up, after the physical link is up, the PremierWave XC will attempt to obtain IP settings from a BOOTP server.</p> <p>Note: Overrides the configured IP address/mask, gateway, hostname, and domain. When DHCP is On, the system automatically uses DHCP, regardless of whether BOOTP is On. Changing this value requires you to reboot the device.</p>

Network Interface Settings	Description
DHCP Client	<p>Select On or Off. At boot up, after the physical link is up, the PremierWave XC will attempt to obtain IP settings from a DHCP server and will periodically renew these settings with the server.</p> <p>Note: Overrides BOOTP, the configured IP address/mask, gateway, hostname, and domain. Changing this value requires you to reboot the device.</p> <p>Note: Within WebManager, click Renew to renew the DHCP lease.</p>
IP Address	<p>Enter the static IP address to use for the interface. You may enter it alone or in CIDR format.</p> <p>Note: This setting will be used if Static IP is active (both DHCP and BOOTP are Disable). Changing this value requires you to reboot the device. When DHCP or BOOTP is enabled, the PremierWave XC tries to obtain an IP address from a DHCP or BOOTP server. If it cannot, the PremierWave XC generates and uses an Auto IP address in the range of 169.254.xxx.xxx, with a network mask of 255.255.0.0.</p>
Default Gateway	<p>Enter the IP address of the router for this network.</p> <p>Note: This setting will be used if Static IP is active (both DHCP and BOOTP are Disable).</p>
Hostname	<p>Enter the hostname for the interface. It must begin with a letter or number, continue with a sequence of letters, numbers, or hyphens, and end with a letter or number.</p> <p>Note: This setting will take effect immediately, but will not register the hostname with a DNS server until the next reboot.</p>
Domain	<p>Enter the domain name suffix for the interface.</p> <p>Note: This setting will be used when either Static IP or Auto IP is active, or if DHCP/BOOTP is active and no Domain Suffix was acquired from the server.</p>
DHCP Client ID	<p>Enter the ID if the DHCP server requires a DHCP Client ID option. The DHCP server's lease table shows IP addresses and MAC addresses for devices. The lease table shows the Client ID, in hexadecimal notation, instead of the PremierWave XC MAC address.</p>
Primary DNS	<p>Enter the IP address of the primary Domain Name Server.</p> <p>Note: This setting will be used when either Static IP or Auto IP is active, or if DHCP/BOOTP is active and no DNS server was acquired from the server.</p>
Secondary DNS	<p>Enter the IP address of the secondary Domain Name Server.</p> <p>Note: This setting will be used when either Static IP or Auto IP is active, or if DHCP/BOOTP is active and no DNS server was acquired from the server.</p>
MTU	<p>When DHCP is enabled, the MTU size is (usually) provided with the IP address. When not provided by the DHCP server, or using a static configuration, this value is used. The MTU size can be from 576 to 1500 bytes, the default being 1500 bytes.</p>

To Configure Network 1 Interface Settings

Using Web Manager

- ◆ To modify Ethernet (eth0) settings, click **Network** on the menu and select **Network 1 -> Interface -> Configuration**.

Using the CLI

- ◆ To enter the eth0 command level: `enable -> config -> if 1`

Using XML

- ◆ Include in your file: `<configgroup name="interface" instance="eth0">`

To View Network 1 Interface Status

Using Web Manager

On the Network Interface Status page, you can view both the current operational settings as well as the settings that would take effect upon a device reboot.

- ◆ To view the Ethernet (eth0) Status page, click **Network** on the menu and select **Network 1 -> Interface -> Status**.

Network 1 Link Settings

Physical link parameters can be configured for an Ethernet (eth0) Network Interface (see table below).

Table 6-4 Network 1 (eth0) Link Settings

Network 1 Ethernet (eth0) Link Settings	Description
Speed	Select the Ethernet link speed. (Default is Auto) <ul style="list-style-type: none"> ◆ Auto = Auto-negotiation of Link Speed ◆ 10 Mbps = Force 10 Mbps ◆ 100 Mbps = Force 100 Mbps
Duplex	Select the Ethernet link duplex mode. (Default is Auto) <ul style="list-style-type: none"> ◆ Auto = Auto-negotiation of Link Duplex ◆ Half = Force Half Duplex ◆ Full = Force Full Duplex

Notes:

- ◆ When speed is **Auto**, duplex must be **Auto** or **Half**.
- ◆ When speed is not **Auto**, duplex must be **Half** or **Full**.
- ◆ Fixed speed **Full** duplex will produce errors connected to **Auto**, due to duplex mismatch.

To Configure Network 1 Link Settings

Using Web Manager

- ◆ To modify Ethernet (eth0) Link information, click **Network** on the menu and select **Network 1** -> **Link**.

Using the CLI

- ◆ To enter the eth0 Link command level: `enable -> config -> if 1 -> link`

Using XML

- ◆ Include in your file: `<configgroup name="ethernet" instance="eth0">`

Network 2 Interface Status

To View Network 2 Interface Status

On the Network 2 Interface Status page, you can view the GSM/GPRS status of the device.

- ◆ To view the Network 2 (wwan0) Status page, click **Network** on the menu bar and select **Network 2** -> **Status**.

Network 2 SMS Outbound Settings

The table below shows the settings for SMS Outbound messages and to send a test message.

Table 6-5 Network 2 (wwan0) SMS Outbound Settings

Network 2 (wwan0) SMS Outbound Settings	Description
SMS Outbound	Select the appropriate SMS format. Note: <ul style="list-style-type: none"> ◆ Select the Text ASCII when sending SMS in Text format (7 bit characters and typically limited to 160 characters per message.) ◆ Select Binary to send SMS in Binary format. (8 bit characters and typically limited to 140 characters per message.) ◆ Select Unicode to send SMS in Unicode format. (16 bit characters and typically limited to 70 characters per message.)
Message Center No.	Input the SMS center Number. Note: This field is required only if the SMS center is incorrect.
Channel	Select the appropriate Channel to send SMS. Note: The default network setting for transmission of SMS messaging is GSM. However, there are carriers that support sending of SMS messages over their GPRS network. Check with your provider.

Network 2 (wwan0) SMS Outbound Settings	Description
Test Phone Number	Input the test recipient's phone number.
Test Message Body	Input the Test Message Body. Note: SMS Format is to be accordingly to the Message Body. <ul style="list-style-type: none"> ◆ When Text ASCII is selected (7 bit characters and typically limited to 160 characters per message.) ◆ When Binary is selected (8 bit characters and typically limited to 140 characters per message.) ◆ When Unicode is selected (16 bit characters and typically limited to 70 characters per message.)
Send Test Message (button)	Click to send out Test SMS Message Note: This will test the SMS Outbound configured settings with the test phone number and test message body.

To Configure Network 2 SMS Outbound Settings

Using Web Manager

- ◆ To modify Network 2 SMS Outbound settings, click **Network** on the menu bar and select **Network 2** → **Configuration** → **SMS Outbound**

Using the CLI

- ◆ To enter the Network 2 SMS outbound command level:
enable -> config -> if 2 ->link -> sms outbound

Using XML

- ◆ Include in your file: `<configgroup name="sms outbound">`

Network 2 SMS Inbound Settings

This device will accept inbound SMS messages and perform specific actions based on the message content. Currently this device allows SMS messages to control the relay states: Open or Close. The SMS Inbound message content is checked against configured strings associated with relay output actions: Open or Close. When there is a match, the relay action is performed.

For added security, the SMS Inbound feature supports configuration of a whitelist, of up to 5 phone numbers from where it will accept messages.

All SMS Inbound messages will be discarded if the SMS Inbound State is Disabled or the phone number is not configured in the Received Number list.

The table below shows the settings for SMS Inbound, and Received Number whitelist.

Table 6-6 Network 2 (wwan0) SMS Inbound Settings

Network 2 (wwan0) SMS Inbound Settings	Description
State	Select Enabled or Disabled . When Enabled and the number matches an entry in the whitelist, the device will handle the SMS. When Disabled, any received SMS will be discarded.
Received Number	Input the Received Number . At least 1 Received Number must be configured for an SMS to be processed. A maximum of 5 Received Number entries are allowed. <i>Note:</i> Please input the Received Numbers to be included in device's whitelist.

To Configure Network 2 SMS Inbound Settings

Using Web Manager

- ◆ To modify Network 2 SMS Inbound settings, click **Network** on the menu bar and select **Network 2** → **Configuration** → **SMS Inbound**

Using the CLI

- ◆ To enter the Network 2 SMS outbound command level:
enable -> config -> if 2 ->link -> sms inbound

Using XML

- ◆ Include in your file: `<configgroup name="sms inbound">`

Network 2 Roam Settings

The table below shows the settings for Roam.

Table 6-7 Network 2 (wwan0) Roam Settings

Network 2 (wwan0) Roam Settings	Description
State	Select Enabled or Disabled . Enabled allows the device to roam. Disabled prevents the device from roaming.

To Configure Network 2 Roam Settings

Using Web Manager

- ◆ To modify Network 2 GSM/GPRS band settings, click **Network** on the menu bar and select **Network 2** → **Configuration** → **Roam**

Using the CLI

- ◆ To enter the Network 2 GSM/GPRS command level:
enable -> config -> if 2 ->link -> roam

Using XML

- ◆ Include in your file: <configgroup name="roam">

Network 2 GSM/GPRS Bands Settings

The table below shows the settings for GSM/GPRS Bands settings.

Table 6-8 Network 2 (wwan0) GSM/GPRS Bands Settings

Network 2 (wwan0) GSM/GPRS Settings	Description
GSM/GPRS Bands	<p>Select the GSM/GPRS Bands if needed:</p> <ul style="list-style-type: none"> ◆ Auto (Default) ◆ GSM-900 ◆ GSM-1800 ◆ GSM-850 ◆ GSM-1900 <p><i>Note: These bands are the wwan0 frequencies designated by the ITU for the operation of GSM mobile phones. Typically Auto should suffice in most cases and should not be changed unless the unit is unable to determine the specific band used by your provider.</i></p> <p><i>GSM bands 900 & 1800 are used in most parts of the world, with the exception of places such as USA, Brazil and Canada where GSM bands 850 & 1900 are used.</i></p> <p><i>Changes do not take effect until after reboot.</i></p>

To Configure Network 2 GSM/GPRS bands Settings

Using Web Manager

- ◆ To modify Network 2 GSM/GPRS band settings, click **Network** on the menu bar and select **Network 2** → **Configuration** → **GSM/GPRS Band**

Using the CLI

- ◆ To enter the Network 2 GSM/GPRS command level:
enable -> config -> if 2 ->link -> gsm gprs band

Using XML

- ◆ Include in your file: `<configgroup name="gsm gprs band">`

Network 2 SIM Pin Settings

The SIM PIN is a 4 digit numeric code used to unlock the SIM card. This allows mobile devices to gain access to network specific information stored on the SIM. If the SIM PIN functionality is enabled on the SIM card, Network Registration will not start until after a valid PIN number has been configured. This is for both the GSM and and GPRS networks. Typically SIM cards are delivered from the provider with SIM PIN function disabled.

Upon 3 failed consecutive attempts to enter a pin, your SIM card will be locked (old PIN will become invalid). To unlock the SIM card, you will have to contact the provider of the SIM card and request a PIN Unlock (PUK) code. Use this with extreme caution, because 10 failed PUK attempts will lock the SIM forever!

The table below shows the settings for SIM PIN configuration.

Table 6-9 Network 2 (wwan0) SIM PIN Settings

Network 2 (wwan0) SIM Pin Settings	Description
PIN Lock	Select Enabled or Disabled to elect whether to protect your SIM card with a security pin. The default is Disabled.
Auto Unlock	Select Enabled or Disabled to elect whether to unlock the SIM card with a preset security pin. The default is Disabled.
PIN Code	Enter the personal identification number / password to access SIM card.
PUK Code	Enter the Pin Unlock Key to unblock a blocked SIM card that is locked by 3 consecutive incorrect pin code entries.

To Configure Network 2 SIM Pin Settings

Using Web Manager

- ◆ To modify Network 2 SIM Pin settings, click **Network** on the menu bar and select **Network 2** → **Configuration** → **SIM PIN**

Using the CLI

- ◆ To enter the Network 2 SIM Pin command level:
enable -> config -> if 2 -> link -> pin

Using XML

- ◆ Include in your file: `<configgroup name="pin">`

Network 2 APN Configuration Settings

The APN is a Network Identifier used by the carrier to determine the type of network service you requested for your mobile device. Your service provider will provide the APN information along with your SIM card.

Note: Make sure that the APN, User Name, Password and Dialup Number is entered correctly. If not, GPRS attachment would fail. This typically refers to the Data Network Access (GPRS). GSM (Text SMS) functionality typically does not require APN to operate.

The table below shows the settings for APN configuration.

Table 6-10 Network 2 (wwan0) APN Configuration Settings

Network 2 (wwan0) APN Configuration Settings	Description
APN	Enter Access Point Name (APN).
User name	Enter or modify user name.
Password	Enter or modify password.
Dialup number	Enter or modify dialup number of APN.

To Configure Network 2 APN Configuration Settings

Using Web Manager

- ◆ To modify Network 2 APN Configuration settings, click **Network** on the menu bar and select **Network 2** → **Configuration** → **APN Configuration**

Using the CLI

- ◆ To enter the Network 2 APN Configuration command level:
enable -> config -> if 2 -> link -> apn

Using XML

- ◆ Include in your file: `<configgroup name="ppp">`

Network 2 Carrier Connection Settings

The Carrier Connection is the identity of the carrier(s) supported by the SIM card provider. The table below shows the settings for Carrier Connection configuration.

Table 6-11 Network 2 (wwan0) Carrier Connection Settings

Network 2 (wwan0) Carrier Connection Settings	Description
Carrier Connection	<p>This identifies the carriers supported by the SIM card provider.</p> <ul style="list-style-type: none"> ♦ Auto allows the device to determine which carrier best matches the SIM card configuration. Select Auto, unless your service provider directs you to change it. ♦ If Manual is selected, you will have to run the Network Scan function to see a list of the carriers supported based on the SIM card. Refer to the your SIM card service provider as to which carrier to select.

To Configure Network 2 Carrier Connection Settings

Using Web Manager

- ♦ To modify Network 2 Carrier Connection settings, click **Network** on the menu bar and select **Network 2** → **Configuration** → **Carrier Connection**

Using the CLI

- ♦ To enter the Network 2 Carrier Connection command level:
enable -> config -> if 2 -> link -> carrier

Using XML

- ♦ Include in your file: `<configgroup name="carrier">`

Network 2 SMS Statistics

To View Network 2 SMS Statistics

Using Web Manager

- ♦ To view Network 2 SMS Statistics, click **Network** on the menu bar and select **Network 2** → **SMS Statistics**

Table 6-12 Network 2 (wwan0) SMS Statistics

Network 2 (wwan0) SMS Statistics	Description
Sender	Displays the current sender information for the wwan0 module.

Network 2 (wwan0) SMS Statistics	Description
Timestamp	Displays the timestamp information for the wwan0 module.
Content	Displays the current content of the wwan0 module.

7: Line and Tunnel Settings

The PremierWave XC contains two Lines. Lines 1 and 2 are standard RS232/RS485 serial ports.

RS232/RS422/RS485

Lines 1 and 2 can be configured to operate in the following modes:

- ◆ RS232
- ◆ RS422/RS485 Full Duplex
- ◆ RS422/RS485 Half Duplex, with and without termination impedance
- ◆ All serial settings such as Baud Rate, Parity, Data Bits, etc, apply to these Lines.

Line Settings

The Line Settings allow configuration of the serial Lines (ports). Some settings may be specific to only certain Lines. Such settings are noted below.

Configuration

Table 7-1 Line Configuration Settings

Line Settings	Description
Name	Enter a name or short description for the line, if desired. By default, there is no name specified. A name that contains white space must be quoted.
Interface	Sets the interface type for the Line. The default is RS232 for Lines 1 and 2. Choices are: <ul style="list-style-type: none">◆ RS232 (Lines 1 and 2 only)◆ RS485 Full-Duplex (Lines 1 and 2 only)◆ RS485 Half-Duplex (Lines 1 and 2 only)
Termination	Sets the Line Termination to Enabled or Disabled . The default is Disable . <i>Note: This setting is only relevant for Lines 1 and 2 with Interface type RS485 Half-Duplex.</i>
State	Sets the operational state of the Line to either Enable or Disable . The default is Enable .
Protocol	Sets the operational protocol for the Line. The default is Tunnel . Choices are: <ul style="list-style-type: none">◆ None◆ Tunnel = Serial-Network tunneling protocol.

Line Settings	Description
Baud Rate	Sets the Baud Rate (speed) of the Line. The default is 9600 . Any set speed between 300 and 921600 may be selected: 300, 600, 1200, 2400, 4800, 9600, 19200, 38400, 57600, 115200, 230400, 460800, 921600. When selecting Custom baud rate (available for line 1 and line 2 only), you may manually enter any value between 300 and 5000000.
Parity	Sets the Parity of the Line. The default is None .
Data Bits	Sets the number of data bits for the Line. The default is 8.
Stop Bits	Sets the number of stop bits for the Line. The default is 1.
Flow Control	Sets the flow control for the Line. The default is None.
Xon Char	Set Xon Char to be used when Flow Control is set to Software. Prefix decimal with \ or prefix hexadecimal with 0x or prefix a single control character <control>.
Xoff Char	Set Xoff Char to be used when Flow Control is set to Software. Prefix decimal with \ or prefix hexadecimal with 0x or prefix a single control character <control>.
Gap Timer	Set the Gap Timer delay to Set the number of milliseconds to pass from the last character received before the driver forwards the received serial bytes. By default, the delay is four character periods at the current baud rate (minimum 1 ms).
Threshold	Set the number of threshold bytes which need to be received in order for the driver to forward received characters.

Command Mode

Table 7-2 Line Command Mode Settings

Line Command Mode Settings	Description
Mode	Sets the Command Mode state of the Line. When in Command Mode, a CLI session operates exclusively on the Line. Choices are: <ul style="list-style-type: none"> ◆ Always ◆ Use Serial String ◆ Disabled <p>Note: In order to enable command mode on the Line, Tunneling on the Line must be Disabled (both connect and accept modes).</p>
Wait Time	Enter the amount of time to wait during boot time for the Serial String. This timer starts right after the Signon Message has been set on the Serial Line and applies only if mode is "Use Serial String".

Line Command Mode Settings	Description
Serial String	Enter the Text or Binary string of bytes that must be read on the Serial Line during boot time in order to enable Command Mode. It may contain a time element to specify a required delay in milliseconds x, formed as {x}. Applies only if mode is "Use Serial String". It may contain a binary character(s) of the form [x]. For example, use decimal [12] or hex [0xc].
Echo Serial String	Select Enabled or Disabled for Echo Serial String. Applies only if mode is "Use Serial String". Select enable to echo received characters back out on the line while looking for the serial string.
Signon Message	Enter the string of bytes to be sent to the Serial Line during boot time. It may contain a binary character(s) of the form [x]. For example, use decimal [12] or hex [0xc].

To Configure Line Settings

Note: The following section describes the steps to view and configure Line 1 settings; these steps apply to other line instances of the device.

Using Web Manager

- ◆ To configure a specific line, click **Line** in the menu bar and select **Line 1 -> Configuration**.
- ◆ To configure a specific line in Command Mode, click **Line** in the menu bar and select **Line 1 -> Command Mode**.

Using the CLI

- ◆ To enter Line 1 command level: `enable -> line 1`

Using XML

- ◆ Include in your file: `<configgroup name="line" instance="1">`
- ◆ Include in your file: `<configgroup name="serial command mode" instance="1">`

Statistics

To View Line Statistics

Using Web Manager

- ◆ To view statistics for a specific line, click **Line** in the menu bar and select **Line 1 -> Statistics**.

Using the CLI

- ◆ To view Line statistics: `enable -> line 1, show statistics`

Using XML

- ◆ Include in your file: `<statusgroup name="line" instance="1">`

Tunnel Settings

Tunneling allows serial devices to communicate over a network, without “being aware” of the devices which establish the network connection between them. Tunneling parameters are configured using the Tunnel menu and submenus. The Tunnel settings allow you to configure how the Serial-Network tunneling operates. Tunneling is available on all serial Lines. The connections on one serial Line are separate from those on another serial port.

Note: The following section describes the steps to view and configure Tunnel 1 settings; these steps apply to other tunnel instances of the device.

Serial Settings

This page shows the settings for the tunnel selected at the top of the page and lets you change the settings. The Line Settings and Protocol are displayed for informational purposes and must be configured from the Line pages.

Table 7-3 Tunnel Serial Settings

Tunnel Serial Settings	Description
Line Settings	Line Settings information here is display only. Go to the section, To Configure Line Settings to modify these settings.
Protocol	Protocol information here is display only. Go to the section To Configure Line Settings to modify these settings.
DTR	Select the conditions in which the Data Terminal Ready (DTR) control signal on the Serial Line are asserted. Choices are: <ul style="list-style-type: none"> ◆ Unasserted ◆ TruPort = the DTR is asserted whenever either a connect or an accept mode tunnel connection is active with the Telnet Protocol RFC2217 saying that the remote DSR is asserted. ◆ Asserted while connected = the DTR is asserted whenever either a connect or an accept mode tunnel connection is active. ◆ Continuously asserted

To Configure Tunnel Serial Settings

Using Web Manager

- ◆ To configure the Serial Settings for a specific tunnel, click **Tunnel** in the menu bar and select **Tunnel 1 -> Serial Settings**.

Using the CLI

- ◆ To enter Tunnel 1 command level: `enable -> tunnel 1 -> serial`

Using XML

- ◆ Include in your file: `<configgroup name="tunnel serial" instance="1">`

Packing Mode

With Packing, data from the serial Line is not sent over the network immediately. Instead, data is queued and sent in segments, when either the timeout or byte threshold is reached. Packing applies to both Accept and Connect Modes.

Table 7-4 Tunnel Packing Mode Settings

Tunnel Packing Mode Settings	Description
Mode	Configure the Tunnel Packing Mode. Choices are: <ul style="list-style-type: none"> ◆ Disable = Data not packed. ◆ Timeout = data sent after timeout occurs. ◆ Send Character = data sent when the Send Character is read on the Serial Line.
Threshold	Sets the threshold (byte count). If the received serial data reaches this threshold, then the data will be sent on the network. Valid range is 100 to 1450 bytes. Default is 512.
Timeout	Sets the timeout value, in milliseconds, after the first character is received on the serial Line, before data is sent on the network. Valid range is 1 to 30000 milliseconds. Default is 1000.
Send Character	Enter Control Characters in any of the following forms: <ul style="list-style-type: none"> ◆ <control>J ◆ 0xA (hexadecimal) ◆ \10 (decimal). If used, the Send Character is a single printable character or a control character that, when read on the Serial Line, forces the queued data to be sent on the network immediately.
Trailing Character	Enter Control Characters in any of the following forms: <ul style="list-style-type: none"> ◆ <control>J ◆ 0xA (hexadecimal) ◆ \10 (decimal). If used, the Send Character is a single printable character or a control character that is injected into the outgoing data stream right after the Send Character. Disable the Trailing Character by blanking the field (setting it to <None>).

To Configure Tunnel Packing Mode Settings

Using Web Manager

- ◆ To configure the Packing Mode for a specific tunnel, click **Tunnel** in the menu bar and select **Tunnel 1 -> Packing Mode**.

Using the CLI

- ◆ To enter the Tunnel 1 Packing command level: `enable -> tunnel 1 -> packing`

Using XML

- ◆ Include in your file: `<configgroup name="tunnel packing" instance="1">`

Accept Mode

In Accept Mode, the PremierWave XC listens (waits) for incoming connections from the network. A remove node on the network initiates the connection.

The configurable local port is the port the remote device connects to for this connection. There is no remote port or address. The default local port is 10001 for serial line 1 and 10002 for serial line 2.

Serial data can still be received while waiting for a network connection, keeping in mind serial data buffer limitations.

Table 7-5 Tunnel Accept Mode Settings

Tunnel Accept Mode Settings	Description
Mode	Sets the method used to start a tunnel in Accept mode. Choices are: <ul style="list-style-type: none"> ◆ Disable = do not accept an incoming connection. ◆ Always = accept an incoming connection. (<i>default</i>) ◆ Any Character = start waiting for an incoming connection when any character is read on the serial line. ◆ Start Character = start waiting for an incoming connection when the start character for the selected tunnel is read on the serial line. ◆ Modem Control Asserted = start waiting for an incoming connection as long as the Modem Control pin (DSR) is asserted on the serial line until a connection is made. ◆ Modem Emulation = start waiting for an incoming connection when triggered by modem emulation AT commands. Connect mode must also be set to Modem Emulation.
Local Port	Sets the port number for use as the network local port. The defaults are as follows: <ul style="list-style-type: none"> ◆ Tunnel 1 : 10001 ◆ Tunnel 2 : 10002
Protocol	Select the protocol type for use with Accept Mode: <ul style="list-style-type: none"> ◆ SSH ◆ SSL ◆ TCP (default protocol) ◆ TCP AES

Tunnel Accept Mode Settings	Description
	<ul style="list-style-type: none"> ◆ Telnet
TCP Keep Alive	Enter the time, in milliseconds, the PremierWave XC waits during a silent connection before checking if the currently connected network device is still on the network. If the unit then gets no response after 8 attempt, it drops the connection. Enter 0 to disable.
Flush Serial	Sets whether the serial Line data buffer is flushed upon a new network connection. Choices are: <ul style="list-style-type: none"> ◆ Enabled = serial data buffer is flushed on network connection ◆ Disabled = serial data buffer is not flushed on network connection (<i>default</i>)
Block Serial	Set whether Block Serial is enabled for debugging purposes. Choices are: <ul style="list-style-type: none"> ◆ Enabled = if Enabled, incoming characters from the Serial Line will not be forwarded to the network. Instead, they will be buffered and will eventually flow off the Serial Line if hardware or software flow control is configured. ◆ Disabled = this is the default setting; incoming characters from the Serial Line are sent on into the network. Any buffered characters are sent first.
Block Network	Set whether Block Network is enabled for debugging purposes. Choices are: <ul style="list-style-type: none"> ◆ Enabled = if Enabled, incoming characters from the network will not be forwarded to the Serial Line. Instead, they will be buffered and will eventually flow off the network side. ◆ Disabled = this is the default setting; incoming characters from the network are sent on into the Serial Line. Any buffered characters are sent first.
Password	Enter a password. This password can be up to 31 characters in length and must contain only alphanumeric characters and punctuation. When set, clients must send the correct password string to the unit within 30 seconds from opening network connection in order to enable data transmission. The password sent to the unit must be terminated with one of the following: <ul style="list-style-type: none"> ◆ 0A (Line Feed) ◆ 00 (Null) ◆ 0D 0A (Carriage Return/Line Feed) ◆ 0D 00 (Carriage Return/Null) If, Prompt for Password is set to Enabled, the user will be prompted for the password upon connection.
Email on Connect	Select an email profile number to which an email notification will be sent upon the establishment of an accept mode tunnel.
Email on Disconnect	Select an email profile number to which an email notification will be sent upon the disconnection of an accept mode tunnel.

To Configure Tunnel Accept Mode Settings

Using Web Manager

- ◆ To configure the Accept Mode for a specific tunnel, click **Tunnel** in the menu bar and select **Tunnel 1 -> Accept Mode**.

Using the CLI

- ◆ To enter Tunnel 1 Accept Mode command level: `enable -> tunnel 1 -> accept`

Using XML

- ◆ Include in your file: `<configgroup name="tunnel accept" instance="1">`

Connect Mode

In Connect Mode, the PremierWave XC continues to attempt an outgoing connection on the network, until established. If the connection attempt fails or the connection drops, then it retries after a timeout. The remote node on the network must listen for the Connect Mode's connection.

For Connect Mode to function, it must be enabled, have a remote station (node) configured, and a remote port configured (TCP or UDP). When established, Connect Mode is always on. Enter the remote station as an IP address or DNS name. The PremierWave XC will not make a connection unless it can resolve the address.

For Connect Mode using UDP, the PremierWave XC accepts packets from any device on the network. It will send packets to the last device that sent it packets.

Note: *The Port in Connect Mode is not the same port configured in Accept Mode.*

The TCP keepalive time is the time in which probes are periodically sent to the other end of the connection. This ensures the other side is still connected.

Table 7-6 Tunnel Connect Mode Settings

Tunnel Connect Mode Settings	Description
Mode	Sets the method to be used to attempt a connection to a remote host or device. Choices are: <ul style="list-style-type: none"> ◆ Always = a connection is attempted until one is made. If the connection gets disconnected, the PremierWave XC retries until it makes a connection. ◆ Disable = an outgoing connection is never attempted. (<i>default</i>)
Local Port	Enter an alternative Local Port. The Local Port is set to <Random> by default but can be overridden. Blank the field to restore the default.
Host 1	Click on the displayed information to expand it for editing. If <None> is displayed, clicking it will allow you to configure a new host. At least one Host is required to enable Connect Mode as this information is necessary to connect to that host.
Reconnect Timer	Sets the value of the reconnect timeout (in milliseconds) for outgoing connections established by the device. Valid range is 1 to 65535 milliseconds. Default is 15000.

Tunnel Connect Mode Settings	Description
Flush Serial Data	Sets whether the serial Line data buffer is flushed upon a new network connection. Choices are: <ul style="list-style-type: none"> ◆ Enabled = serial data buffer is flushed on network connection ◆ Disabled = serial data buffer is not flushed on network connection (<i>default</i>)
Block Serial	Set whether Block Serial is enabled for debugging purposes. Choices are: <ul style="list-style-type: none"> ◆ Enabled = If Enabled, incoming characters from the Serial Line will not be forwarded to the network. Instead, they will be buffered and will eventually flow off the Serial Line if hardware or software flow control is configured. ◆ Disabled = this is the default setting; incoming characters from the Serial Line are sent on into the network. Any buffered characters are sent first. ◆ Any Character = a connection is attempted when any character is read on the serial line. ◆ Start Character = a connection is attempted when the start character for the selected tunnel is read on the serial line. ◆ Modem Control Asserted = a connection is attempted as long as the Modem Control pin (DSR) is asserted, until a connection is made. ◆ Modem Emulation = a connection is attempted when triggered by modem emulation AT commands.
Block Network	Set whether Block Network is enabled for debugging purposes. Choices are: <ul style="list-style-type: none"> ◆ Enabled = If Enabled, incoming characters from the network will not be forwarded to the Serial Line. Instead, they will be buffered and will eventually flow off the network side. ◆ Disabled = this is the default setting; incoming characters from the network are sent on into the Serial Line. Any buffered characters are sent first.
Email on Connect	Select an email profile number to which an email notification will be sent upon the establishment of an accept mode tunnel.
Email on Disconnect	Select an email profile number to which an email notification will be sent upon the disconnection of an accept mode tunnel.

To Configure Tunnel Connect Mode Settings

Using Web Manager

- ◆ To configure the Connect Mode for a specific tunnel, click **Tunnel** in the menu and select **Tunnel 1 -> Connect Mode**.

Using the CLI

- ◆ To enter the Tunnel 1 Connect Mode command level: `enable -> tunnel 1 -> connect`

Using XML

- ◆ Include in your file: `<configgroup name="tunnel connect" instance="1">`

Disconnect Mode

Specifies the optional conditions for disconnecting any Accept Mode or Connect Mode connection that may be established. If any of these conditions are selected but do not occur and the network disconnects to the device, a Connect Mode connection will attempt to reconnect. However, if none of these conditions are selected, a closure from the network is taken as a disconnect.

Table 7-7 Tunnel Disconnect Mode Settings

Tunnel Disconnect Mode Settings	Description
Stop Character	Enter the Stop Character which, when received on the Serial Line, disconnects the tunnel. The Stop Character may be designated as a single printable character or as a control character. Control characters may be entered in any of the following forms: <control>J or 0xA(hexadecimal) or \10 (decimal). Disable the Stop Character by blanking the field to set it to <None>.
Modem Control	Set whether Modem Control enables disconnect when the Modem Control pin is not asserted on the Serial Line. Choices are: <ul style="list-style-type: none"> ◆ Enabled ◆ Disabled (default)
Timeout	Enter the number of milliseconds a tunnel may be idle before disconnection. The value of zero disables the idle timeout.
Flush Serial Data	Set whether to flush the Serial Line when the Tunnel is disconnected. Choices are: <ul style="list-style-type: none"> ◆ Enabled ◆ Disabled (default)

To Configure Tunnel Disconnect Mode Settings

Using Web Manager

- ◆ To configure the Disconnect Mode for a specific tunnel, click **Tunnel** in the menu bar and select **Tunnel 1 -> Disconnect Mode**.

Using the CLI

- ◆ To enter the Tunnel 1 Disconnect command level: `enable -> tunnel 1 -> disconnect`

Using XML

- ◆ Include in your file: `<configgroup name="tunnel disconnect" instance="1">`

Modem Emulation

Some older equipment is designed to attach to a serial port and dial into a network with a modem. This equipment uses AT commands to control the connection. For compatibility with these older devices on modern networks, our product mimics the behavior of the modem.

Table 7-8 Tunnel Modem Emulation Settings

Tunnel Modem Emulation Settings	Description
Echo Pluses	Set whether the pluses will be echoed back during a “pause +++ pause” escape sequence on the Serial Line. Choices are: <ul style="list-style-type: none"> ◆ Enabled ◆ Disabled (default)
Echo Commands	Set whether characters read on the Serial Line will be echoed, while the Line is in Modem Command Mode. Choices are: <ul style="list-style-type: none"> ◆ Enabled ◆ Disabled (default)
Verbose Response	Set whether Modem Response Codes are sent out on the Serial Line. Choices are: <ul style="list-style-type: none"> ◆ Enabled ◆ Disabled (default)
Response Type	Select a representation for the Modem Response Codes sent out on the Serial Line. Choices are: <ul style="list-style-type: none"> ◆ Text (ATV1) (default) ◆ Numeric (ATV0)
Error Unknown Commands	Set whether the Error Unknown Commands is enabled (ATU0) and ERROR is returned on the Serial Line for unrecognized AT commands. Otherwise (ATU1) OK is returned for unrecognized AT commands. Choices are: <ul style="list-style-type: none"> ◆ Enabled ◆ Disabled (default)
Incoming Connection	Set how and if requests are answered after an incoming RING (ATS0=2). Choices are: <ul style="list-style-type: none"> ◆ Disabled (default) ◆ Automatic ◆ Manual
Connect String	Enter the customized Connect String sent to the Serial Line with the Connect Modem Response Code.
Display Remote IP	Set whether the Display Remote IP is enabled so that the incoming RING sent on the Serial Line is followed by the IP address of the caller. Choices are: <ul style="list-style-type: none"> ◆ Enabled ◆ Disabled (default)

To Configure Tunnel Modem Emulation Settings

Using Web Manager

- ◆ To configure the Modem Emulation for a specific tunnel, click **Tunnel** in the menu bar and select **Tunnel 1 -> Modem Emulation**.

Using the CLI

- ◆ To enter the Tunnel 1 Modem command level: `enable -> tunnel 1 -> modem`

Using XML

- ◆ Include in your file: `<configgroup name="tunnel modem" instance="1">`

Statistics

Tunnel statistics contains data counters, error counters, connection time and connection information. Statistics are available at each individual connection and aggregated across all connections.

To View Tunnel Statistics

Using Web Manager

- ◆ To view statistics for a specific tunnel, click **Tunnel** in the menu bar and select the **Tunnel 1 -> Statistics**.

Using the CLI

- ◆ To view Tunnel 1 statistics: `enable -> tunnel 1, show statistics`

Using XML

- ◆ Include in your file: `<statusgroup name="tunnel" instance="1">`

8: Terminal and Host Settings

Predefined connections are available via telnet, SSH, or a serial port. A user can choose one of the presented options and the device automatically makes the predefined connection.

Either the Telnet, SSH, or serial port connection can present the CLI or the Login Connect Menu. By default, the CLI is presented when the device is accessed. When configured to present the Login Connect Menu, the hosts configured via the Host selections, and named serial lines are presented.

Terminal Settings

You can configure whether each serial line or the telnet/SSH server presents a CLI or a Login Connect menu when a connection is made.

Table 8-1 Terminal on Network and Line Settings

Terminal on Network and Line Settings	Description
Terminal Type	Enter text to describe the type of terminal. The text will be sent to a host via IAC. <i>Note:</i> IAC means, "interpret as command." It is a way to send commands over the network such as send break or start echoing .
Login Connect Menu	Select the interface to display when the user logs in. Choices are: <ul style="list-style-type: none">◆ Enabled = shows the Login Connect Menu.◆ Disabled = shows the CLI (default)
Exit Connect Menu	Select whether to display a choice for the user to exit the Login Connect Menu and reach the CLI. Choices are: <ul style="list-style-type: none">◆ Enabled = a choice allows the user to exit to the CLI.◆ Disabled = there is no exit to the CLI (default)
Send Break	Enter a Send Break control character, e.g., <control> Y, or blank to disable. When the Send Break control character is received from the network on its way to the serial line, it is not sent to the line; instead, the line output is forced to be inactive (the break condition). <i>Note:</i> This configuration option is only available for Line Terminals.
Break Duration	Enter how long the break should last in milliseconds, up to 10000. Default is 500. <i>Note:</i> This configuration option is only available for Line Terminals.
Echo	Select Enabled or Disabled . Applies only to Connect Mode Telnet connections, not to Accept Mode. Only disable Echo if your terminal echoes, in which case you will see double of each character typed. Default is enabled.

To Configure the Terminal Network Connection

Using Web Manager

- ◆ To configure the Terminal on Network, click **Terminal** on the menu bar and select **Network -> Configuration**.

Using the CLI

- ◆ To enter the Terminal Network command level:
enable -> config -> terminal network

Using XML

- ◆ Include in your file: `<configgroup name="terminal" instance="network">`

To Configure the Terminal Line Connection

Note: The following section describes the steps to view and configure Terminal 1 settings; these steps apply to other terminal instances of the device.

Using Web Manager

- ◆ To configure a particular Terminal Line, click **Terminal** on the menu bar and select **Line 1 -> Configuration**.

Using the CLI

- ◆ To enter the Terminal Line command level: enable -> config -> terminal 1

Using XML

- ◆ Include in your file: `<configgroup name="terminal" instance="1">`

Host Configuration

Table 8-2 Host Configuration

Host Settings	Description
Name	Enter a name for the host. This name appears on the Login Connect Menu. To leave a host out of the menu, leave this field blank.
Protocol	Select the protocol to use to connect to the host. Choices are: <ul style="list-style-type: none"> ◆ Telnet ◆ SSH <p>Note: SSH keys must be loaded or created on the SSH page for the SSH protocol to work.</p>

Host Settings	Description
SSH Username	Appears if you selected SSH as the protocol. Enter a username to select a pre-configured Username/Password/Key (configured on the SSH: Client Users page), or leave it blank to be prompted for a username and password at connect time.
Remote Address	Enter an IP address for the host to which the device will connect.
Remote Port	Enter the port on the host to which the device will connect.

To Configure Host Settings

Note: The following section describes the steps to view and configure Host 1 settings; these steps apply to other host instances of the device.

Using Web Manager

- ◆ To configure a particular Host, click **Host** on the menu bar and select **Host 1 -> Configuration**.

Using the CLI

- ◆ To enter the Host command level: `enable -> config -> host 1`

Using XML

- ◆ Include in your file: `<configgroup name="host" instance="1">`

9: Services Settings

DNS Settings

This section describes the active run-time settings for the domain name system (DNS) protocol. The primary and secondary DNS addresses come from the active interface. The static addresses from the Network Interface configuration settings may be overridden by DHCP or BOOTP.

Note: The blue text in the XML command strings of this chapter are to be replaced with a user-specified name.

Table 9-1 DNS Settings

Setting / Field	Description
Lookup	Perform one of the following: <ul style="list-style-type: none">◆ Enter an IP address, and perform a reverse Lookup to locate the hostname for that IP address◆ Enter a hostname, and perform a forward Lookup to locate the corresponding IP address

To View or Configure DNS Settings

Using Web Manager

- ◆ To view DNS current status, click **DNS** in the menu bar.
- ◆ To lookup DNS name or IP address, click **DNS** in the menu bar to access the **Lookup** field.
- ◆ To configure DNS for cases where it is not supplied by a protocol, click **Network** in the menu bar and select **Interface -> Configuration**.

Using CLI

To enter the DNS command level: `enable -> dns`

Using XML

- ◆ Include in your file: `<configgroup name="interface" instance="eth0">`

FTP Settings

The FTP protocol can be used to upload and download user files, and upgrade the PremierWave firmware. A configurable option is provided to enable or disable access via this protocol.

Table 9-2 FTP Settings

FTP Settings	Description
State	Select Enabled or Disabled for the state of the FTP server.

To Configure FTP Settings

Using Web Manager

- ◆ To configure FTP, click **FTP** in the menu bar.

Using the CLI

- ◆ To enter the FTP command level: `enable -> config -> ftp`

Using XML

- ◆ Include in your file: `<configgroup name="ftp server">`

Syslog Settings

The Syslog information shows the current configuration and statistics of the syslog. Here you can configure the syslog host and the severity of the events to log.

Note: *The system log is always saved to local storage, but it is not retained through reboots unless diagnostics logging to the filesystem is enabled. Saving the system log to a server that supports remote logging services (see RFC 3164) allows the administrator to save the complete system log history. The default port is 514.*

Table 9-3 Syslog Settings

Syslog Settings	Description
State	Select Enabled or Disabled for the state of the syslog.
Host	Enter the IP address of the remote server to which system logs are sent for storage.
Remote Port	Enter the number of the port on the remote server that supports logging services. The default is 514.
Severity Log Level	Specify the minimum level of system message the PremierWave XC should log. This setting applies to all syslog facilities. The drop-down list in the Web Manager is in descending order of severity (e.g., Emergency is more severe than Alert.)

To View or Configure Syslog Settings

Using Web Manager

- ◆ To configure the Syslog, click **Syslog** in the menu bar.

Using the CLI

- ◆ To enter the Syslog command level: `enable -> config -> syslog`

Using XML

- ◆ Include in your file: `<configgroup name="syslog">`

HTTP Settings

Hypertext Transfer Protocol (HTTP) is the transport protocol for communicating hypertext documents on the Internet. HTTP defines how messages are formatted and transmitted. It also defines the actions web servers and browsers should take in response to different commands. HTTP Authentication enables the requirement of usernames and passwords for access to the device.

Table 9-4 HTTP Settings

HTTP Settings	Description
State	Select Enabled or Disabled for the state of the HTTP server.
Port	Enter the port for the HTTP server to use. The default is 80 .
Secure Port	Enter the port for the HTTPS server to use. The default is 443 . The HTTP server only listens on the HTTPS Port when an SSL certificate is configured.
Secure Protocols	Select to enable or disable the following protocols: <ul style="list-style-type: none"> ◆ SSL3 = Secure Sockets Layer version 3 ◆ TLS1.0 = Transport Layer Security version 1.0. TLS 1.0 is the successor of SSL3 as defined by the IETF. ◆ TLS1.1 = Transport Layer Security version 1.1 The protocols are enabled by default. Note: A server certificate and associated private key need to be installed in the SSL configuration section to use HTTPS .
Secure Credentials	Specify the name of the set of RSA and/or DSA certificates and keys to be used for the secure connection.
Max Timeout	Enter the maximum time for the HTTP server to wait when receiving a request. This prevents Denial-of-Service (DoS) attacks. The default is 10 seconds.
Max Bytes	Enter the maximum number of bytes the HTTP server accepts when receiving a request. The default is 40 kB (this prevents DoS attacks).

HTTP Settings	Description
Logging State	Select Enabled or Disabled for the state of the HTTP server logging.
Max Log Entries	Sets the maximum number of HTTP server log entries. Only the last Max Log Entries are cached and viewable.
Log Format	Set the log format string for the HTTP server. Follow these Log Format rules: <ul style="list-style-type: none"> ◆ %a - remote IP address (could be a proxy) ◆ %b - bytes sent excluding headers ◆ %B - bytes sent excluding headers (0 = '-') ◆ %h - remote host (same as '%a') ◆ %{h}i - header contents from request (h = header string) ◆ %m - request method ◆ %p - ephemeral local port value used for request ◆ %q - query string (prepend with '?' or empty '-') ◆ %t - timestamp HH:MM:SS (same as Apache '%(%H:%M:%S)t' or '%(%T)t') ◆ %u - remote user (could be bogus for 401 status) ◆ %U - URL path info ◆ %r - first line of request (same as '%m %U%q <version>') ◆ %s - return status
Authentication Timeout	The timeout period applies if the selected authentication type is either Digest or SSL/Digest . After this period of inactivity, the client must authenticate again.

To Configure HTTP Settings

Using Web Manager

- ◆ To configure HTTP settings, click **HTTP** in the menu bar and select **Configuration**.
- ◆ To view HTTP statistics, click **HTTP** in the menu bar and select **Statistics**.

Using the CLI

- ◆ To enter the HTTP command level: `enable -> config -> http`

Using XML

- ◆ Include in your file: `<configgroup name="http server">`

Table 9-5 HTTP Authentication Settings

HTTP Authentication Settings	Description
URI	Enter the Uniform Resource Identifier (URI). Note: The URI must begin with '/' to refer to the filesystem.

HTTP Authentication Settings	Description
Auth Type	<p>Select the authentication type:</p> <ul style="list-style-type: none"> ◆ None = no authentication is necessary. ◆ Basic = encodes passwords using Base64. ◆ Digest = encodes passwords using MD5. ◆ SSL = the page can only be accessed over SSL (no password is required). ◆ SSL/Basic = the page is accessible only over SSL and encodes passwords using Base64. ◆ SSL/Digest = the page is accessible only over SSL and encodes passwords using MD5. <p><i>Note: When changing the parameters of Digest or SSL Digest authentication, it is often best to close and reopen the browser to ensure it does not attempt to use cached authentication information.</i></p>

To Configure HTTP Authentication

Using Web Manager

- ◆ To configure HTTP Authentication, click **HTTP** in the menu bar and select **Authentication**.

Using the CLI

- ◆ To enter the HTTP command level: `enable -> config -> http`

Using XML

- ◆ Include in your file:

```
<configgroup name="http authentication uri" instance="uri name">
```

RSS Settings

Really Simple Syndication (RSS) (sometimes referred to as Rich Site Summary) is a method of feeding online content to Web users. Instead of actively searching for configuration changes, RSS feeds permit viewing only relevant and new information regarding changes made to the via an RSS publisher. The RSS feeds may also be stored to the file system `cfg_log.txt` file.

Table 9-6 RSS Settings

RSS Settings	Description
RSS Feed	Select On or Off to enable/disable the RSS feeds to an RSS publisher.
Persistent	Select On or Off to enable/disable the RSS feed to be written to a file (<code>cfg_log.txt</code>) and to be available across reboots.
Max Entries	Sets the maximum number of log entries. Only the last Max Entries are cached and viewable.

To Configure RSS Settings

Using Web Manager

- ◆ To configure RSS, click **RSS** in the menu bar.

Using the CLI

- ◆ To enter the RSS command level: `enable -> config -> rss`

Using XML

- ◆ Include in your file: `<configgroup name="rss">`

10: Security Settings

SSL Settings

Secure Sockets Layer (SSL) is a protocol for managing the security of data transmission over the Internet. It provides encryption, authentication, and message integrity services. SSL is widely used for secure communication to a web server, and also for wireless authentication.

Certificate/Private key combinations can be obtained from an external Certificate Authority (CA) and uploaded into the unit. Self-signed certificates with associated private key can be generated by the device server itself.

For more information regarding certificates and how to obtain them, see the chapter, [Security in Detail](#).

Note: The *blue text* in the XML command strings of this chapter are to be replaced with a user-specified name.

Certificate and Key Generation

The PremierWave can generate self signed certificates and their corresponding keys. This can be done for both the rsa and dsa certificate formats. Certificates can be identified on the PremierWave by a name provided at generation time.

Table 10-1 Certificate and Key Generation Settings

Certificate Generation Settings	Description
Country (2 Letter Code)	Enter the 2-letter country code to be assigned to the new self-signed certificate. Examples: US for United States and CA for Canada
State/Province	Enter the state or province to be assigned to the new self-signed certificate.
Locality (City)	Enter the city or locality to be assigned to the new self-signed certificate.
Organization	Enter the organization to be associated with the new self-signed certificate.
Organization Unit	Enter the organizational unit to be associated with the new self-signed certificate.
Common Name	Enter the common name to be associated with the new self signed certificate. Note that this is a required field.
Expires	Enter the expiration date, in mm/dd/yyyy format, for the new self-signed certificate. Example: An expiration date of May 9, 2012 is entered as 05/09/2012.

Certificate Generation Settings	Description
Key length	Select the bit size of the new self-signed certificate. Choices are: <ul style="list-style-type: none"> ◆ 512 bits ◆ 768 bits ◆ 1024 bits ◆ 2048 bits The larger the bit size, the longer it takes to generate the key.
Type	Select the type of key: <ul style="list-style-type: none"> ◆ RSA = Public-Key Cryptography algorithm based on large prime numbers, invented by Rivest Shamir and Adleman. Used for encryption and signing. ◆ DSA = Digital Signature Algorithm also based on large prime numbers, but can only be used for signing. Developed by the US government to avoid the patents on RSA.

To Create a New Credential

Using Web Manager

- ◆ To create a new credential, click **SSL** in the menu bar and select **Credentials**.

Using the CLI

- ◆ To enter the SSL command level: `enable -> ssl`
- ◆ To enter the Credentials command level: `enable -> ssl -> credentials`

Using XML

- ◆ Not applicable.

Certificate Upload Settings

SSL certificates identify the PremierWave XC to peers, and can be used with some methods of wireless authentication. Certificate and key pairs can be uploaded to the PremierWave through either the CLI or XML import mechanisms. Certificates can be identified on the PremierWave by a name provided at upload time.

Table 10-2 Upload Certificate Settings

Upload Certificate Settings	Description
New Certificate	<p>SSL certificate to be uploaded. RSA or DSA certificates are allowed.</p> <p>The format of the certificate must be PEM. It must start with "-----BEGIN CERTIFICATE-----" and end with "-----END CERTIFICATE-----". Some Certificate Authorities add comments before and/or after these lines. Those need to be deleted before upload.</p>
New Private Key	<p>The key needs to belong to the certificate entered above.</p> <p>The format of the file must be PEM. It must start with "-----BEGIN RSA PRIVATE KEY-----" and end with "-----END RSA PRIVATE KEY-----". Read DSA instead of RSA in case of a DSA key. Some Certificate Authorities add comments before and/or after these lines. Those need to be deleted before upload.</p>

To Configure an Existing SSL Credential

Using Web Manager

- ◆ To configure an existing SSL Credential, click **SSL** in the menu bar and select **Credentials**.

Using the CLI

- ◆ To enter the SSL command level: `enable -> ssl`
- ◆ To enter the Credential command level: `enable -> ssl -> credentials`

Using XML

- ◆ Include in your file:

```
<configgroup name="ssl">
and <configitem name="credentials" instance="name">
and <value name="RSA certificate"/> or <value name="DSA
certificate"/>
```

Trusted Authorities

One or more authority certificates are needed to verify a peer's identity. Authority certificates are used with some wireless authentication methods. These certificates do not require a private key.

Table 10-3 Trusted Authority Settings

Trusted Authorities Settings	Description
Authority	<p>SSL authority certificate.</p> <p>RSA or DSA certificates are allowed.</p> <p>The format of the authority certificate can be PEM or PKCS7. PEM files must start with "-----BEGIN CERTIFICATE-----" and end with "-----END CERTIFICATE-----". Some Certificate Authorities add comments before and/or after these lines. Those need to be deleted before upload.</p>

To Upload an Authority Certificate

Using Web Manager

- ◆ To upload an Authority Certificate, click **SSL** in the menu bar and select **Trusted Authorities**.

Using the CLI

- ◆ To enter the SSL command level: `enable -> ssl`
- ◆ To enter the Trusted Authorities command level:
`enable -> ssl -> trusted authorities`

Using XML

- ◆ Include in your file:

```
<configgroup name="ssl">
and <configitem name="trusted authority" instance="1">
and <configitem name="intermediate authority" instance="1">
```

11: Maintenance and Diagnostics Settings

Filesystem Settings

The PremierWave XC uses a flash file system to store files. Use the filesystem to list, view, add, remove, and transfer files.

File Display

It is possible to view the list of existing files, and to view their contents in the ASCII or hexadecimal formats.

Table 11-1 File Display Settings

File Display Commands	Description
ls	Displays a list of files on the PremierWave, and their respective sizes.
cat	Displays the specified file in ASCII format.
dump	Displays the specified file in a combination of hexadecimal and ASCII formats.
pwd	Print working directory.
cd	Change directories.
show tree	Display file/directory tree.

To Display Files

Using Web Manager

- ◆ To view existing files and file contents, click **Filesystem** in the menu bar and select **Browse**.

Using the CLI

- ◆ To enter the Filesystem command level: `enable -> filesystem`

Using XML

- ◆ Not applicable.

File Modification

The PremierWave XC allows for the creation and removal of files on its filesystem.

Table 11-2 File Modification Settings

File Modification Commands	Description
rm	Removes the specified file from the file system.
touch	Creates the specified file as an empty file.
cp	Creates a copy of a file.
mkdir	Creates a directory on the file system.
rmdir	Removes a directory from the file system.
format	Format the file system and remove all data.

File Transfer

Files can be transferred to and from the PremierWave via the TFTP protocol. This can be useful for saving and restoring XML configuration files. Files can also be uploaded via HTTP.

Table 11-3 File Transfer Settings

File Transfer Settings	Description
Upload File	Browse to location of the file to be uploaded.
Action	Select the action that is to be performed via TFTP: <ul style="list-style-type: none"> ◆ Get = a “get” command will be executed to store a file locally. ◆ Put = a “put” command will be executed to send a file to a remote location.
Local File	Enter the name of the local file on which the specified “get” or “put” action is to be performed.
Remote File	Enter the name of the file at the remote location that is to be stored locally (“get”) or externally (“put”).
Host	Enter the IP address or name of the host involved in this operation.
Port	Enter the number of the port involved in TFTP operations.

To Transfer or Modify Filesystem Files

Using Web Manager

- ◆ To create a new file or directory, upload an existing file, copy or move a file, click **Filesystem** in the menu bar and select **Browse**.

Using the CLI

- ◆ To enter the Filesystem command level: `enable -> filesystem`

Using XML

- ◆ Not applicable.

Protocol Stack Settings

There are various low level IP network stack specific items that are available for configuration. This includes settings related to IP, ICMP, ARP, SMTP and SNMP which are described in the sections below.

Table 11-4 IP Network Stack Settings

Protocol Stack IP Settings	Description
IP Time to Live	This value typically fills the Time To Live in the IP header. SNMP refers to this value as "ipDefaultTTL". Enter the number of hops to be transmitted before the packet is discarded.
Multicast Time to Live	This value fills the Time To Live in any multicast IP header. Normally this value will be one so the packet will be blocked at the first router. It is the number of hops allowed before a Multicast packet is discarded. Enter the value to be greater than one to intentionally propagate multicast packets to additional routers.

To Configure IP Network Stack Settings

Using Web Manager

- ◆ To configure IP protocol settings, click **Protocol Stack** in the menu bar and select **IP**.

Using the CLI

- ◆ To enter the command level: `enable -> config -> ip`

Using XML

- ◆ Include in your file: `<configgroup name="ip">`

Table 11-5 ICMP Network Stack Settings

Protocol Stack ICMP Settings	Description
State	Select Enabled or Disabled . The State selection is used to turn on/off processing of ICMP messages. This includes both incoming and outgoing messages.

To Configure ICMP Network Stack Settings

Using Web Manager

- ◆ To configure ICMP protocol settings, click **Protocol Stack** in the menu bar and select **ICMP**.

Using the CLI

- ◆ To enter the command level: `enable -> config -> icmp`

Using XML

- ◆ Include in your file: `<configgroup name="icmp">`

Table 11-6 ARP Network Stack Settings

Protocol Stack ARP Settings	Description
IP Address	Enter the IP address to add to the ARP cache.
MAC Address	Enter the MAC address to add to the ARP cache.

To Configure ARP Network Stack Settings

Using Web Manager

- ◆ To configure ARP protocol settings, click **Protocol Stack** in the menu bar and select **ARP**.

Using the CLI

- ◆ To enter the command level: `enable -> config -> arp`

Using XML

- ◆ Include in your file: `<configgroup name="arp">`

Table 11-7 SMTP Network Stack Settings

Protocol Stack SMTP Settings	Description
Relay Address	Address of all outbound messages through a mail server. Can contain either a hostname or an IP address.
Relay Port	Port utilized for the delivery of outbound email messages.

To Configure SMTP Network Stack Settings

Using Web Manager

- ◆ To configure SMTP protocol settings, click **Protocol Stack** in the menu bar and select **SMTP**.

Using the CLI

- ◆ To enter the command level: `enable -> config -> smtp`

Using XML

- ◆ Include in your file: `<configgroup name="smtp">`

Table 11-8 SNMP Network Stack Settings

Note: Configuration must be correct in order for the device to successfully send SNMP Trap.

Protocol Stack SNMP Settings	Description
Remote Hostname	Enter the Remote Hostname location for the send location of the SNMP trap.
Community	Enter the Community name of the SNMP trap.
sysLocation	Enter the location of the device to send the SNMP trap.

To Configure SNMP Network Stack Settings

Using Web Manager

- ◆ To configure SNMP protocol settings, click **Protocol Stack** in the menu bar and select **SNMP**.

Using the CLI

- ◆ To enter the command level: `enable -> config -> snmp`

Using XML

- ◆ Include in your file: `<configgroup name="snmp xc">`

Query Port

The query port (UDP port 0x77FE) is used for the automatic discovery of the device by the DeviceInstaller utility. Only 0x77FE discover messages from DeviceInstaller are supported. For more information on DeviceInstaller, see [Chapter 4: Using DeviceInstaller](#).

Table 11-9 Query Port Settings

Query Port Settings	Description
State	Select Enabled or Disabled to enable or disable listening and responding to query port messages.

To Configure Query Port Settings

Using Web Manager

- ◆ To view Query Port settings or to switch the Query Port Server on or off, click **Query Port** in the menu bar.

Using the CLI

- ◆ To enter the Query Port command level: `enable -> config -> query port`

Using XML

- ◆ Include in your file:

```
<configgroup name="query port">
and
<configitem name="state">
```

Diagnostics

The PremierWave XC has several tools for diagnostics and statistics. Various options allow for the configuration or viewing of IP socket information, ping, traceroute, memory, processes, log, route and threads.

Hardware

To View Hardware Information

Using Web Manager

- ◆ To view hardware information, click **Diagnostics** in the menu bar and select **Hardware**.

Using the CLI

- ◆ To enter the command level: `enable -> device, show hardware information`

Using XML

- ◆ Include in your file: `<statusgroup name="hardware">`

IP Sockets

You can view the list of listening and connected IP sockets.

To View the List of IP Sockets

Using Web Manager

- ◆ To view IP Sockets, click **Diagnostics** in the menu bar and select **IP Sockets**.

Using the CLI

- ◆ To enter the command level: `enable, show ip sockets`

Using XML

- ◆ Include in your file: `<statusgroup name="ip sockets">`

Ping

The ping command can be used to test connectivity to a remote host.

Table 11-10 Ping Settings

Diagnostics: Ping Settings	Description
Host	Enter the IP address or host name for the PremierWave XC to ping.
Count	Enter the number of ping packets PremierWave XC should attempt to send to the Host . The default is 5 .

Diagnostics: Ping Settings	Description
Timeout	Enter the time, in seconds, for the PremierWave XC to wait for a response from the host before timing out. The default is 5 seconds.

To Ping a Remote Host

Using Web Manager

- ◆ To ping a Remote Host, click **Diagnostics** in the menu bar and select **Ping**.

Using the CLI

- ◆ To enter the command level: `enable`

Using XML

- ◆ Not applicable.

Traceroute

Here you can trace a packet from the PremierWave XC to an Internet host, showing how many hops the packet requires to reach the host and how long each hop takes. If you visit a web site whose pages appear slowly, you can use traceroute to determine where the longest delays are occurring.

Table 11-11 Traceroute Settings

Diagnostics: Traceroute Settings	Description
Host	Enter the IP address or DNS hostname. This address is used to show the path between it and the PremierWave XC when issuing the traceroute command.
Protocol	Select the traceroute protocol: <ul style="list-style-type: none"> ◆ TCP ◆ ICMP ◆ UDP

To Perform a Traceroute

Using Web Manager

- ◆ To perform a Traceroute, click **Diagnostics** in the menu bar and select **Traceroute**.

Using the CLI

- ◆ To enter the command level: `enable`

Log

Table 11-12 Log Settings

Diagnostics: Log Settings	Description
Output	Select a diagnostic log output type: <ul style="list-style-type: none"> ◆ Disable ◆ Filesystem ◆ Line 1 ◆ Line 2
Max Length	Set the maximum length of the log.txt file. <i>Note: This setting becomes available when Filesystem is selected.</i>

To Configure the Diagnostic Log Output

Using Web Manager

- ◆ To configure the Diagnostic Log output, click **Diagnostics** in the menu bar and select **Log**.

Using the CLI

- ◆ To enter the command level: enable -> config -> diagnostics -> log

Using XML

- ◆ Include in your file:

```
<configgroup name="diagnostics">
  and
  <configitem name="log">
```

Memory

The memory information shows the total, used, and available memory (in kilobytes).

To View Memory Usage

Using Web Manager

- ◆ To view memory information, click **Diagnostics** in the menu bar and select Memory.

Using the CLI

- ◆ To enter the command level: enable -> device, show memory

Using XML

- ◆ Include in your file: <statusgroup name="memory">

Processes

The PremierWave XC Processes information shows all the processes currently running on the system. It shows the Process ID (PID), Parent Process ID (PPID), user, CPU percentage, percentage of total CPU cycles, and process command line information.

To View Process Information

Using Web Manager

- ◆ To view process information, click **Diagnostics** in the menu bar and select **Processes**.

Using the CLI

- ◆ To enter the command level: `enable, show processes`

Using XML

- ◆ Include in your file: `<statusgroup name="processes">`

Route

The PremierWave XC Route information shows the system's routing table, which includes Destination, Gateway, Genmask, Flag, Metric, Ref, Use and Interface.

To View Route Information

Using Web Manager

- ◆ To view the routing table information, click **Diagnostics** in the menu bar and select **Route**.

Using the CLI

- ◆ To enter the command level: `enable, route`

Threads

The PremierWave XC Threads information shows the Thread ID (TID), Thread Name and CPU Usage for the various system threads.

To View Threads Information

Using Web Manager

- ◆ To view system's threads information, click **Diagnostics** in the menu bar and select **Threads**.

System Settings

The PremierWave XC System settings allow for rebooting the device, restoring factory defaults, uploading new firmware and updating a system's short and long name.

Table 11-13 System Settings

System Settings	Description
Reboot Device	This reboots the device.
Restore Factory Defaults	This restores the device to the original factory settings. All configuration will be lost. The PremierWave XC automatically reboots upon setting back to the defaults.
Upload New Firmware	FTP to the PremierWave. Write the new firmware file to firmware.rom on the PremierWave. The device automatically reboots upon the installation of new firmware. See the section, FTP Settings .
Short Name	Enter a short name for the system name. A maximum of 32 characters are allowed.
Long Name	Enter a long name for the system name. A maximum of 64 characters are allowed.

To Reboot or Restore Factory Defaults

Using Web Manager

- ♦ To access the area with options to reboot, restore to factory defaults, upload new firmware, update the system name (long or short names) or to view the current configuration, click **System** in the menu bar.

Using the CLI

- ♦ To enter the command level: `enable`

Using XML

- ♦ Include in your file: `<configgroup name="xml import control">`

12: Advanced Settings

Email Settings

View and configure email alerts relating to events occurring within the system.

Table 12-1 Email Configuration

Email – Configuration Settings	Description
To	Enter the email address to which the email alerts will be sent. Multiple addresses are separated by semicolon (;). Required field if an email is to be sent.
CC	Enter the email address to which the email alerts will be copied. Multiple addresses are separated by semicolon (;).
From	Enter the email address to list in the From field of the email alert. Required field if an email is to be sent.
Reply-To	Enter the email address to list in the Reply-To field of the email alert.
Subject	Enter the subject for the email alert.
Message File	Enter the path of the file to send with the email alert. This file appears within the message body of the email.
Overriding Domain	Enter the domain name to override the current domain name in EHLO (Extended Hello).
Server Port	Enter the SMTP server port number. The default is port 25 .
Local Port	Enter the local port to use for email alerts. The default is a random port number.
Priority	Select the priority level for the email alert.

To View, Configure and Send Email

Note: The following section describes the steps to view and configure Email 1 settings; these steps apply to other emails available for the device.

Using Web Manager

- ◆ To view Email statistics, click **Email** in the menu bar and select **Email 1 -> Statistics**.
- ◆ To configure basic Email settings, click **Email** in the menu bar and select **Email 1 -> Configuration**.
- ◆ To send an email, click **Email** in the menu bar and select **Email 1 -> Send Email**.

Using the CLI

- ◆ To enter Email command level: `enable -> email 1`

Using XML

- ◆ Include in your file: `<configgroup name="email" instance="1">`

Command Line Interface Settings

The Command Line Interface settings allow you to control how users connect to and interact with the PremierWave's command line. It is possible to configure access via the Telnet and SSH protocols, in addition to general CLI options.

Basic CLI Settings

The basic CLI settings control general CLI access and usability options.

Table 12-2 CLI Configuration Settings

Command Line Interface Configuration Settings	Description
Login Password	Enter the password for logins by the admin account. The default password is "PASS".
Enable Level Password	Enter the password for access to the Command Mode Enable level. There is no password by default.
Quit Connect Line	Set the string used to terminate a connect line session and resume the CLI. Type <control> before any key to be pressed while holding down the Ctrl key, for example, <control>L.
Inactivity Timeout	Set a time period in which the CLI session should disconnect if no data is received. Enter 0 to disable. Blank the display field to restore the default.
Line Authentication	Select Enabled or Disabled to enable or disable authentication for CLI access on the serial lines.

To View and Configure Basic CLI Settings

Using Web Manager

- ◆ To view CLI statistics, click **CLI** in the menu bar and select **Statistics**.
- ◆ To configure basic CLI settings, click **CLI** in the menu bar and select **Configuration**.

Using the CLI

- ◆ To enter CLI command level: `enable -> config -> cli`

Using XML

- ◆ Include in your file: `<configgroup name="cli">`

Telnet Settings

The telnet settings control CLI access to the PremierWave XC over the Telnet protocol.

Table 12-3 Telnet Settings

Telnet Settings	Description
Telnet State	Select Enabled or Disabled to enable or disable CLI access via telnet.
Telnet Port	Enter an alternative Telnet Port to override the default used by the CLI server. Blank the field to restore the default.
Telnet Max Sessions	Specify the maximum number of concurrent Telnet sessions that will be allowed.
Telnet Authentication	Enable or disable authentication for telnet logins.

To Configure Telnet Settings

Using Web Manager

- ◆ To configure Telnet settings, click **CLI** in the menu bar and select **Configuration**.

Using the CLI

- ◆ To enter the Telnet command level: `enable -> config -> cli -> telnet`

Using XML

- ◆ Include in your file:

```
<configgroup name="telnet">
and
<configitem name="state">
and
<configitem name="authentication">
```

SSH Settings

The SSH settings control CLI access to the PremierWave XC over the SSH protocol.

Table 12-4 SSH Settings

SSH Settings	Description
SSH State	Select Enabled or Disabled to enable or disable CLI access via SSH.
SSH Port	Specify the SSH Port and override the default, as needed. Blank the field to restore the default.
SSH Max Sessions	Specify the maximum number of concurrent SSH sessions that will be allowed.

To Configure SSH Settings

Using Web Manager

- ◆ To configure SSH settings, click **CLI** in the menu bar and select **Configuration**.

Using the CLI

- ◆ To enter the SSH command level: `enable -> config -> cli -> ssh`

Using XML

- ◆ Include in your file:

```
<configgroup name="ssh">
and
<configitem name="state">
```

XML Settings

The PremierWave XC allows for the configuration of units using an XML configuration record (XCR). Export a current configuration for use on other PremierWave XCs or import a saved configuration file.

XML: Export Configuration

You can export the current system configuration in XML format. The generated XML file can be imported later to restore a configuration. It can also be modified and imported to update the configuration on this PremierWave XC unit or another. The XML data can be dumped to the screen or exported to a file on the file system.

By default, all groups are exported. You may also select a subset of groups to export.

Table 12-5 XML Exporting Configuration

XML Export Configuration Settings	Description
Export to browser	Select this option to export the XCR data in the selected fields to the browser. Use the “xcr dump” command to export the data to the browser.
Export to local file	Select this option to export the XCR data to a file on the device. If you select this option, enter a file name for the XML configuration record. Use the “xcr export” command to export the data to a local file.
Export secrets	Only use this with extreme caution. If selected, secret password and key information will be exported. Use only with a secure link, and save only in secure locations.
Comments	Select this option to include descriptive comments in the XML.
Lines to Export	Select instances to be exported in the line, serial, tunnel and terminal groups.
Groups to Export	Check the configuration groups that are to be exported to the XML configuration record. The group list should be comma delimited and encased in double quotes. The list of available groups can be viewed with the “xcr list” command.

To Export Configuration in XML Format

Using Web Manager

- ◆ To export configuration format, click **XML** in the menu bar and select **Export Configuration**.

Using the CLI

- ◆ To enter the XML command level: `enable -> xml`

Using XML

- ◆ Not applicable.

XML: Export Status

You can export the current status in XML format. By default, all groups are exported. You may also select a subset of groups to export.

Table 12-6 Exporting Status

XML Export Status Settings	Description
Export to browser	Select this option to export the XCR data in the selected fields to the browser. Use the "xcr dump" command to export the data to the browser.
Export to local file	Select this option to export the XCR data to a file on the device. If you select this option, enter a file name for the XML configuration record. Use the "xcr export" command to export the data to a local file.
Lines to Export	Select instances to be exported in the line, serial, tunnel and terminal groups.
Groups to Export	Check the configuration groups that are to be exported to the XML configuration record. The group list should be comma delimited and encased in double quotes. The list of available groups can be viewed with the "xcr list" command.

To Export Status in XML Format

Using Web Manager

- ◆ To export configuration format, click **XML** in the menu bar and select **Export Status**.

Using the CLI

- ◆ To enter the XML command level: `enable -> xml`

XML: Import Configuration

Here you can import a system configuration from an XML file.

The XML data can be imported from a file on the file system or pasted into a CLI session. The groups to import can be specified at the command line, the default is all groups.

Import Configuration from External File

This import option requires entering the path and file name of the external XCR file you want to import.

Import Configuration from the Filesystem

This import option picks up settings from a file and your import selections of groups, lines, and instances. The list of files can be viewed from the filesystem level of the CLI.

Table 12-7 Import Configuration from Filesystem Settings

Import Configuration from Filesystem Settings	Description
Filename	Enter the name of the file on the PremierWave XC (local to its filesystem) that contains XCR data.
Lines to Import	Select filter instances to be imported in the line, serial, tunnel and terminal groups. This affects both Whole Groups to Import and Text List selections.
Groups to Import	Select the configuration groups to import from the XML configuration record. This option imports all instances of each selected group.
Text List	Enter the string to import specific instances of a group. The textual format of this string is: <code><g>:<i>;<g>:<i>;...</code> Each group name <code><g></code> is followed by a colon and the instance value <code><i></code> and each <code><g>:<i></code> value is separated by a semi-colon. If a group has no instance then only the group name <code><g></code> should be specified.

To Import Configuration in XML Format

Using Web Manager

- ◆ To import configuration, click **XML** in the menu bar and select **Import Configuration**.

Using the CLI

- ◆ To enter the XML command level: `enable -> xml`

Failover Settings

Failover is the process of allowing a second Network interface to backup the Primary (WAN Connection) configured interface. It uses a Dead Remote Host reachability (Ping) mechanism to determine when it should switch over to the second interface. Failover automatically uses the Primary Network configured DNS Servers as the Remote Host, if one is not configured.

Table 12-8 Failover Settings

Failover Settings	Description
State	Select Enabled or Disabled to enable or disable the Failover.

Failover Settings	Description
Ping Timeout Interval	Enter the value for the Ping Timeout Interval. Maximum duration of executing one Ping command. <i>Note: Default value is 30.</i>
Ping Interval	Enter the value for the Ping Interval. Device will ping Remote host every defined seconds. <i>Note: Default value is 3.</i>
Max. Failed Pings (before Failover)	Enter the number for Max. Failed Pings If device fails to connect after defined attempts, device will failover to secondary connection. <i>Note: Default value is 5.</i>
Consecutive Successful Pings (before fallback)	Enter the number for Consecutive Successful Pings After default connection is up, device will revert to default connection after defined continuous successful pings. <i>Note: Default value is 5.</i>
Ethernet Host Address	Specify the Ethernet Host address . Define the Ethernet host address to ping when using Ethernet as default connection.
Wwan0 Host Address	Specify the Wwan0 Host address . Define the Wwan0 host address to ping when using Wwan0 as default connection.

To Configure Failover Settings

Using Web Manager

- ◆ To configure failover settings, click **Fail Over** on the menu bar.

Using the CLI

- ◆ To enter the XML command level: `enable -> config → failover mode`

Using XML

- ◆ Include in your file: `<configgroup name="failover mode">`

Relay Output Settings

The PremierWave XC allows Relay Output state to be controlled by events, user commands and SMS inbound messaging.

Configuration of the Relay Output settings allow you to configure the initial state for the Relay Output after boot up, test the Open and Close state of the relay, and configure the SMS inbound message to control the Open and Close state of the Relay output.

Table 12-9 Relay Output Settings

Relay Output Settings	Description
Initial State	Select Initial State of the relay output to be opened or closed.
State Preservation	Select to enable or disable preserving the relay output state after warm boot.
SMS Open CMD	Customize: SMS text controls the relay output to be in open state.
SMS Close CMD	Customize: SMS text controls the relay output to be in close state.

To Configure Relay Output Settings

Using Web Manager

- ◆ To configure Relay Output settings, click **Relay Output** on the menu bar.

Using the CLI

- ◆ To enter the XML command level: `enable -> relay output`

Using XML

- ◆ Include in your file: `<configgroup name="relay output">`

13: Events

Event Overview

The PremierWave XC supports configuration of several alerts for specific events detected. The supported alerts are SMS text messaging, SNMP traps and PremierWave's built in Relay Output control. Different events such as Input 1, Input 2, Main Power Fail, Backup Power Fail, Wwan0 Link Down and Ethernet Link Down could be configured to generate alerts.

Main and Backup Power Failure - PremierWave monitors both input power states and triggers one or more configurable alerts.

Cellular and Ethernet Interface Down Event - PremierWave monitors the Primary Interface configurable remote host reachability (Primary Interface DNS Servers if not configured) state and triggers one or more configurable alerts when the remote host becomes unreachable.

I/O Inputs 1 and 2 Signal Status Change - PremierWave monitors I/O input state changes (configurable high2low or low2high) and triggers one or more configurable alerts.

When an event is enabled and detected, the status of the event will be displayed in both CLI and Web Manager. An event is cleared when the event has been rectified or cleared by the Clear Event command via Web or CLI. PremierWave event states are also cleared during system initialization.

Event Alerts

The following alerts can be configured to be triggered when an event occurs.

Table 13-1 Event Alerts Settings

Event Alert Settings	Description
Input Event	Configure the input event to trigger on a low to high or high to low signal. Note: This setting is only available for Input 1 and 2 event.
Relay output	Enable or disable the Relay output Note: Enable selected, will close the Relay output Note: Disable selected, will not affect the Relay output.
Send SMS	Enable or disable the Send SMS alert Input the recipient number (up to 5) and message body. Note: Wwan0 link with GSM must be up. Therefore, Send SMS alert is not available for Wwan0 Link Down event.
Send SNMP Trap	Select Enabled or Disabled to enable or disable the SNMP Trap Note: must be configured beforehand.

To Configure Input 1 Settings

Using Web Manager

- ◆ To configure Input 1 settings, click **Events** on the menu bar, and click **Input 1**.

Using the CLI

- ◆ To enter the XML command level: `enable -> config -> events -> input 1`

Using XML

- ◆ Include in your file: `<configgroup name="input 1">` for Input 1 Configuration
- ◆ Include in your file: `<configgroup name="input 1 relayoutput">` for Input 1 Relay Output
- ◆ Include in your file: `<configgroup name="input 1 send sms">` for Input 1 Send SMS
- ◆ Include in your file: `<configgroup name="input 1 send snmp">` for Input 1 Send SNMP Trap

To Configure Input 2 Settings

Using Web Manager

- ◆ To configure Input 2 settings, click **Events** on the menu bar, and click **Input 2**.

Using the CLI

- ◆ To enter the XML command level: `enable -> config -> events -> input 2`

Using XML

- ◆ Include in your file: `<configgroup name="input 2">` for Input 2 Configuration
- ◆ Include in your file: `<configgroup name="input 2 relayoutput">` for Input 2 Relay Output
- ◆ Include in your file: `<configgroup name="input 2 send sms">` for Input 2 Send SMS
- ◆ Include in your file: `<configgroup name="input 2 send snmp">` for Input 2 Send SNMP Trap

To Configure Main Power Fail Settings

Using Web Manager

- ◆ To configure Main Power Fail settings, click **Events** on the menu bar, and click **Main Power Fail**.

Using the CLI

- ◆ To enter the XML command level: `enable -> config -> events -> main power fail`

Using XML

- ◆ Include in your file: `<configgroup name="power fail">` for Main Power Fail Relay Output
- ◆ Include in your file: `<configgroup name="power fail send sms">` for Main Power Fail Send SMS
- ◆ Include in your file: `<configgroup name="power fail send snmp">` for Main Power Fail Send SNMP Trap

To Configure Backup Power Fail Settings

Using Web Manager

- ◆ To configure Backup Power Fail settings, click **Events** on the menu bar, and click **Backup Power Fail**.

Using the CLI

- ◆ To enter the XML command level: `enable -> config -> events -> backup power fail`

Using XML

- ◆ Include in your file: `<configgroup name="back up power fail">` for Backup Power Fail Relay Output
- ◆ Include in your file: `<configgroup name="back up power fail send sms">` for Backup Power Fail Send SMS
- ◆ Include in your file: `<configgroup name="back up power fail send snmp">` for Backup Power Fail Send SNMP Trap

To Configure Wwan0 Link Down Settings

Using Web Manager

- ◆ To configure Wwan0 Link Down settings, click **Events** on the menu bar, and click **Wwan0 Link Down**.

Using the CLI

- ◆ To enter the XML command level: `enable -> config -> events -> Wwan0 link down`

Using XML

- ◆ Include in your file: `<configgroup name="cellular link down">` for Wwan0 Link Down Relay Output
- ◆ Include in your file: `<configgroup name="cellular link down send snmp">` for Wwan0 Link Down SNMP Trap

To Configure Ethernet Link Down Settings

Using Web Manager

- ◆ To configure Ethernet Link Down settings, click **Events** on the menu bar, and click **Ethernet Link Down**.

Using the CLI

- ◆ To enter the XML command level: `enable -> config -> cellular -> event config -> ethernet link down`

Using XML

- ◆ Include in your file: `<configgroup name="ethernet link down">` for Ethernet Link Down Relay Output
- ◆ Include in your file: `<configgroup name="ethernet link down send sms">` for Ethernet Link Down Send SMS
- ◆ Include in your file: `<configgroup name="ethernet link down send snmp">` for Ethernet Link Down Send SNMP Trap

Events Status and Clearing Events

When Events are generated, PremierWave XC would generate alerts and the Fault LED of the device would be flashing.

The user can verify the current IO events status under **Events -> Status**, under menu bar.

After resolving the events, you would need to clear events.

To Clear Events

Using Web Manager

- ◆ To clear Events, click **Events** on the menu bar, and click **Clear Event button**.

Using the CLI

- ◆ To enter the XML command level: `clear events`

Using the XML

- ◆ Not applicable.

14: Security in Detail

Public Key Infrastructure

Public Key Infrastructure (PKI) is based on an encryption technique that uses two keys: a public key and private key. Public keys can be used to encrypt messages which can only be decrypted using the private key. This technique is referred to as asymmetric encryption, as opposed to symmetric encryption, in which a single secret key is used by both parties.

TLS (SSL)

Transport Layer Security (TLS) and its predecessor, Secure Sockets Layer (SSL), use asymmetric encryption for authentication. In some scenarios, only a server needs to be authenticated, in others both client and server authenticate each other. Once authentication is established, clients and servers use asymmetric encryption to exchange a secret key. Communication then proceeds with symmetric encryption, using this key.

SSH and some wireless authentication methods on the PremierWave XC make use of SSL. The PremierWave XC supports SSLv2, SSLv3, and TLS1.0.

TLS/SSL application hosts use separate digital certificates as a basis for authentication in both directions: to prove their own identity to the other party, and to verify the identity of the other party. In proving its own authenticity, the PremierWave XC will use its own "personal" certificate. In verifying the authenticity of the other party, the PremierWave XC will use a "trusted authority" certificate.

In short:

- ◆ When using EAP-TLS, the PremierWave XC needs a personal certificate with matching private key to identify itself and sign its messages.
- ◆ When using EAP-TLS, EAP-TTLS or PEAP, the PremierWave XC needs the authority certificate(s) that can authenticate those it wishes to communicate with.

Digital Certificates

The goal of a certificate is to authenticate its sender. It is analogous to a paper document that contains personal identification information and is signed by an authority, for example a notary or government agency. With digital certificates, a cryptographic key is used to create a unique digital signature.

Trusted Authorities

A private key is used by a trusted certificate authority (CA) to create a unique digital signature. Along with this private key is a certificate of authority, containing a matching public key that can be used to verify the authority's signature but not re-create it.

A chain of signed certificates, anchored by a root CA, can be used to establish a sender's authenticity. Each link in the chain is certified by a signed certificate from the previous link, with

the exception of the root CA. This way, trust is transferred along the chain, from the root CA through any number of intermediate authorities, ultimately to the agent that needs to prove its authenticity.

Obtaining Certificates

Signed certificates are typically obtained from well-known CAs, such as VeriSign. This is done by submitting a certificate request for a CA, typically for a fee. The CA will sign the certificate request, producing a certificate/key combo: the certificate contains the identity of the owner and the public key, and the private key is available separately for use by the owner.

As an alternative to acquiring a signed certificate from a CA, you can act as your own CA and create self-signed certificates. This is often done for testing scenarios, and sometimes for closed environments where the expense of a CA-signed root certificate is not necessary.

Self-Signed Certificates

A few utilities exist to generate self-signed certificates or sign certificate requests. The PremierWave XC also has the ability to generate its own self-signed certificate/key combo. You can use XML to export the certificate in PEM format, but you cannot export the key. Hence the internal certificate generator can only be used for certificates to identify that particular PremierWave XC.

Certificate Formats

Certificates and private keys can be stored in several file formats. Best known are PKCS12, DER and PEM. Certificate and key can be in the same file or in separate files. Additionally, the key can be either be encrypted with a password or left in the clear. However, the PremierWave XC currently only accepts separate PEM files, with the key unencrypted.

Several utilities exist to convert between the formats.

OpenSSL

OpenSSL is a widely used open source set of SSL related command line utilities. It can act as server or client. It can also generate or sign certificate requests, and can convert from and to several different of formats.

OpenSSL is available in binary form for Linux and Windows.

To generate a self-signed RSA certificate/key combo:

```
openssl req -x509 -nodes -days 365 -newkey rsa:1024 -keyout mp_key.pem  
-out mp_cert.pem
```

See www.openssl.org or www.madboa.com/geek/openssl for more information.

Note: *Signing other certificate requests is also possible with OpenSSL but the details of this process are outside the scope of this document.*

Steel Belted RADIUS

Steel Belted RADIUS is a commercial RADIUS server from Juniper Networks that provides a GUI administration interface. It also provides a certificate request and self-signed certificate generator.

The self-signed certificate has extension `.sbrpvk` and is in the PKCS12 format. OpenSSL can convert this into a PEM format certificate and key:

```
openssl pkcs12 -in sbr_certkey.sbrpvk -nodes -out sbr_certkey.pem
```

The `sbr_certkey.pem` file contains both certificate and key. If loading the SBR certificate into PremierWave XC as an authority, you will need to edit it:

1. Open the file in any plain text editor.
2. Delete all info before "----- BEGIN CERTIFICATE-----" and after "----- END

CERTIFICATE-----", and then save as `sbr_cert.pem`.

SBR accepts trusted-root certificates in the DER format. Again, OpenSSL can convert any format into DER:

```
openssl x509 -inform pem -in mp_cert.pem -outform der -out mp_cert.der
```

Note: With SBR, when the identity information includes special characters such as dashes and periods, SBR changes the format it uses to store these strings and becomes incompatible with the current PremierWave XC release. Support may be added for this and other formats in future releases.

Free RADIUS

Free RADIUS is another versatile Linux open-source RADIUS server.

15: Updating Firmware

Obtaining Firmware

Obtain the most up-to-date firmware and release notes for the unit from the Lantronix Web site (www.lantronix.com/support/documentation) or by using anonymous FTP (<ftp://ftp.lantronix.com/>).

Loading New Firmware through Web Manager

Reload the firmware using the device web manager Filesystem page.

To upload new firmware:

1. Select **Filesystem** in the menu bar. The **Filesystem > Statistics** page appears.
2. Click the **Browse** link (beside the **Statistics** link near the top of the screen) to access the **Filesystem Browser** page.
3. Click the **Browse** button to browse to the firmware file.
4. Highlight the file and click **Open**.
5. Click **Upload** to install the firmware on the PremierWave XC. The device automatically reboots on the installation of new firmware.
6. Close and reopen the web manager internet browser to view the device's updated web pages.

Note: Alternatively, firmware may be updated by sending the file to the PremierWave XC over a FTP or TFTP connection.

Figure 15-1 Filesystem Browser

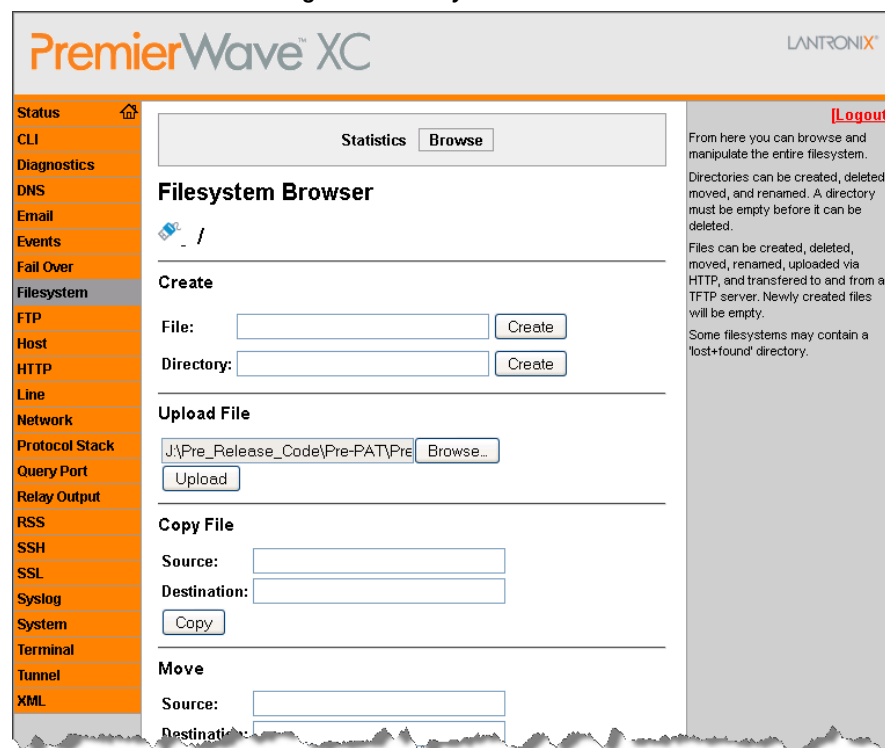

Loading New Firmware through FTP

Firmware may be updated by sending the file to the PremierWave XC over a FTP connection. The destination file name on the PremierWave XC must be "firmware.rom". The device will reboot upon successful completion of the firmware upgrade.

Example FTP session:

```
$ ftp 192.168.10.127
Connected to 192.168.10.127.
220 (vsFTPd 2.0.7)
Name (192.168.10.127:user): admin
331 Please specify the password.
Password:
230 Login successful.
Remote system type is UNIX.
Using binary mode to transfer files.
ftp> put premierwave_XC_7_0_0_0R8.rom firmware.rom
200 PORT command successful. Consider using PASV.
150 Ok to send data.
226 File receive OK.
9308164 bytes sent in 3.05 seconds (3047859 bytes/s)
ftp> quit
221 Goodbye.
```

16: Branding the PremierWave XC

This chapter describes how to brand your PremierWave XC by using Web Manager and Command Line Interface (CLI). It contains the following sections on customization:

- ♦ [Web Manager Customization](#)
- ♦ [Short and Long Name Customization](#)

Web Manager Customization

Customize the Web Manager's appearance by modifying `index.html`, `style.css`, and the product logo. The style (fonts, colors, and spacing) of the Web Manager is controlled with `style.css`. The text and graphics are controlled with `index.html`. The product logo is the image in top-left corner of the page and defaults to a product name image.

Note: *The recommended dimensions of the new graphic are 300px width and 50px height.*

The Web Manager files are hidden and are incorporated directly into the firmware image but may be overridden by placing the appropriate file in the appropriate directory on the PremierWave XC file system.

Web Manager files can be retrieved and overridden with the following procedure:

- ♦ FTP to the PremierWave XC device.
- ♦ Make a directory (`mkdir`) and name it `http/config`.
- ♦ Change to the directory (`cd`) that you created in step 2 (`http/config`).
- ♦ Save the contents of `index.html` and `style.css` by using a web browser and navigating to <http://<PremierWaveXC>/config/index.html> and <http://<PremierWaveXC>/config/style.css>.
- ♦ Modify the file as required or create a new one with the same name.
- ♦ To customize the product logo, save the image of your choice as `logo.gif`.
- ♦ Put the file(s) by using `put <filename>`.
- ♦ Type `quit`. The overriding files appear in the file system's `http/config` directory.
- ♦ Restart any open browser to view the changes.
- ♦ If you wish to go back to the default files in the firmware image, simply delete the overriding files from the file system.

Short and Long Name Customization

You can customize the short and long names in your PremierWave XC. The names display in the CLI show command and in the System web page in the Current Configuration table. The short name is used for the show command. Both names are displayed in the CLI Product Type field.

Table 16-1 Short and Long Name Settings

Name Settings	Description
Short Name	Enter a short name for the system name. A maximum of 32 characters are allowed.
Long Name	Enter a long name for the system name. A maximum of 64 characters are allowed.

To Customize Short or Long Names

Using Web Manager

- ◆ To access the area with options to customize the short name and the long name of the product, or to view the current configuration, click **System** in the menu bar.

Using the CLI

- ◆ To enter the command level: `enable`

Using XML

- ◆ Include in your file:
`<configitem name="short name">`
and
`<configitem name="long name">`

17: Troubleshooting

This chapter discusses how you can diagnose and fix errors quickly without having to contact a dealer or Lantronix. When troubleshooting, always ensure that the physical connections (power cable, network cable, serial cable, antenna, SIM card) are secure.

Diagnostic LED States

Condition	Status LED
No GSM/GPRS Connection	GSM/GPRS LED off
Event Triggered	Fault LED Blinking
DDNS not configured	Fault LED Blinking
Wrong APN	GSM/GPRS LED off
SIM card not present	GSM/GPRS LED off

Problems and Error Messages

Problem/Message	Reason	Solution
Network not allowed. GSM is not available.	Network Carrier is not properly selected.	Verify Carrier Connection and select the correct home network or appropriate roaming network.
SIM is locked by PIN Code	SIM PIN is required	Input the SIM PIN (maximum 3 tries) Check with operator for SIM Pin.
SIM is not present	SIM card is not properly inserted or missing.	Verify the SIM card after powering down the device.
SIM WRONG PIN	SIM PIN is required.	Input the SIM PIN (maximum 3 tries) Check with operator for SIM PIN.
SIM card is locked by PUK	SIM PUK is required.	Input the SIM PUK (maximum 3 tries) Check with operator for SIM PUK code.
GSM is not available	Antenna is not properly attached.	Verify if antenna is properly attached to device.
Wwan0 DIALUP FAILURE	APN is wrong or SIM card has no GPRS data enabled.	Verify APN settings with Network Operator. Do ensure that SIM has GPRS-enabled.

Problem/Message	Reason	Solution
APN/user name/password is blank.	APN, user name or password that is required, are missing.	Verify APN settings with Network Operator. Do ensure that SIM has GPRS-enabled.
Open GSM/GPRS tunnel failed	Unable to open GSM/GPRS tunnel.	Verify if device is on the GSM/GPRS network. Verify APN settings with Network Operator. Do ensure that SIM has GPRS-enabled.
DDNS no username/password/domain name	Required field missing.	Verify Login detail is entered.
Update DDNS failed, check your account state.	DynDNS is not active.	Verify if DynDNS account is active.

Appendix A: Technical Support

If you are unable to resolve an issue using the information in this documentation, please contact Technical Support:

Technical Support US

Check our online knowledge base or send a question to Technical Support at <http://www.lantronix.com/support>.

Phone: (800) 422-7044 (US Only)
(949) 453-7198

Technical Support Europe, Middle East, Africa

Phone: +33 13 930 4172
+49 (0) 180 500 13 53 (Germany Only)

Email: eu_techsupp@lantronix.com or eu_support@lantronix.com

Firmware downloads, FAQs, and the most up-to-date documentation are available at <http://www.lantronix.com/support>

When you report a problem, please provide the following information:

- ◆ Your name, and your company name, address, and phone number
- ◆ Lantronix model number
- ◆ Lantronix serial number/MAC address
- ◆ Firmware version (on the first screen shown when you Telnet to the device and type show)
- ◆ Description of the problem
- ◆ Status of the unit when the problem occurred (please try to include information on user and network activity at the time of the problem)
- ◆ Additionally, it may be useful to export and submit the exported XML Configuration file.

Appendix B: Binary to Hexadecimal Conversions

Many of the unit's configuration procedures require you to assemble a series of options (represented as bits) into a complete command (represented as a byte).

The resulting binary value must be converted to a hexadecimal representation.

Use this chapter to learn to convert binary values to hexadecimal or to look up hexadecimal values in the tables of configuration options. The tables include:

- ◆ Command Mode (serial string sign-on message)
- ◆ AES Keys

Converting Binary to Hexadecimal

Following are two simple ways to convert binary numbers to hexadecimal notation.

Conversion Table

Hexadecimal digits have values ranging from 0 to F, which are represented as 0-9, A (for 10), B (for 11), etc. To convert a binary value (for example, 0100 1100) to a hexadecimal representation, treat the upper and lower four bits separately to produce a two-digit hexadecimal number (in this case, 4C). Use the following table to convert values from binary to hexadecimal.

Table B-1 Binary to Hexadecimal Conversions

Decimal	Binary	Hex
0	0000	0
1	0001	1
2	0010	2
3	0011	3
4	0100	4
5	0101	5
6	0110	6
7	0111	7
8	1000	8
9	1001	9
10	1010	A
11	1011	B
12	1100	C
13	1101	D
14	1110	E
15	1111	F

Scientific Calculator

Another simple way to convert binary to hexadecimal is to use a scientific calculator, such as the one available on the Windows operating systems. For example:

1. On the Windows Start menu, click **Programs -> Accessories -> Calculator**.
2. On the **View** menu, select **Scientific**. The scientific calculator appears.
3. Click **Bin** (Binary), and type the number you want to convert.

Figure B-1 Hexadecimal Values in the Scientific Calculator

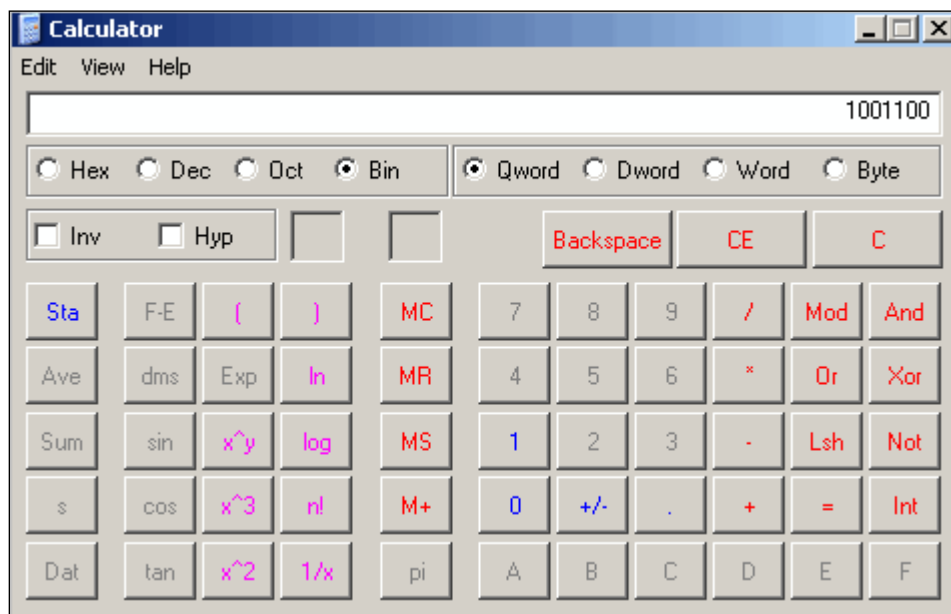

4. Click **Hex**. The hexadecimal value appears.

Appendix C: Compliance

(According to ISO/IEC Guide 17050-1, 17050-2 and EN 45014)

Manufacturer's Name & Address:

Lantronix, Inc.
167 Technology Drive, Irvine, CA 92618 USA

Product Name Model:

PremierWave XC External Device Server

Conforms to the following standards or other normative documents:

- ◆ FCC Part 15 Class B
- ◆ FCC Part 22H, Part 24E
- ◆ CE 1588
- ◆ AS/NZS
- ◆ EN 301 511 V9.02
- ◆ EN 301 489-1 V1.8.1
- ◆ EN 301 489-7 V1.3.1
- ◆ EN 62311:2008
- ◆ EN 50385:2002
- ◆ EN 60950-1:2006 + A11:2009
- ◆ UL 60950-1
- ◆ CSA C22.2 No. 60950-1-07
- ◆ PTCRB
- ◆ R&TTE
- ◆ RoHS
- ◆ REACH

Device Label with CE Mark and FCC ID



WARNING: Please keep a safety distance of 23cm from antenna due to RF exposure.

Manufacturer's Contact:

Lantronix, Inc.
 167 Technology Drive, Irvine, CA 92618 USA
 Tel: 949-453-3990
 Fax: 949-450-7249

RoHS Notice

All Lantronix products in the following families are China RoHS-compliant and free of the following hazardous substances and elements:

- Lead (Pb)
- Mercury (Hg)
- Cadmium (Cd)
- Hexavalent Chromium (Cr (VI))
- Polybrominated biphenyls (PBB)
- Polybrominated diphenyl ethers (PBDE)

Product Family Name	Toxic or hazardous Substances and Elements					
	Lead (Pb)	Mercury (Hg)	Cadmium (Cd)	Hexavalent Chromium (Cr (VI))	Polybrominated biphenyls (PBB)	Polybrominated diphenyl ethers (PBDE)
DSC	0	0	0	0	0	0
EDS	0	0	0	0	0	0
IntelliBox	0	0	0	0	0	0
MatchPort	0	0	0	0	0	0
Micro	0	0	0	0	0	0
MSS100	0	0	0	0	0	0
PremierWave	0	0	0	0	0	0
SCS	0	0	0	0	0	0
SecureBox	0	0	0	0	0	0
SLB	0	0	0	0	0	0
SLC	0	0	0	0	0	0
SLP	0	0	0	0	0	0
Spider and Spider Duo	0	0	0	0	0	0
UBox	0	0	0	0	0	0
UDS1100 and 2100	0	0	0	0	0	0
WiBox	0	0	0	0	0	0
WiPort	0	0	0	0	0	0
xDirect	0	0	0	0	0	0
xPico	0	0	0	0	0	0
XPort	0	0	0	0	0	0
XPress DR & XPress-DR+	0	0	0	0	0	0
xPrintServer	0	0	0	0	0	0
xSenso	0	0	0	0	0	0

O: toxic or hazardous substance contained in all of the homogeneous materials for this part is below the limit requirement in SJ/T11363-2006.

X: toxic or hazardous substance contained in at least one of the homogeneous materials used for this part is above the limit requirement in SJ/T11363-2006.

Free Manuals Download Website

<http://myh66.com>

<http://usermanuals.us>

<http://www.somanuals.com>

<http://www.4manuals.cc>

<http://www.manual-lib.com>

<http://www.404manual.com>

<http://www.luxmanual.com>

<http://aubethermostatmanual.com>

Golf course search by state

<http://golfingnear.com>

Email search by domain

<http://emailbydomain.com>

Auto manuals search

<http://auto.somanuals.com>

TV manuals search

<http://tv.somanuals.com>