

*Lanzar*®

SDBT75NU

# OWNER'S MANUAL

## Mobile Video System

---

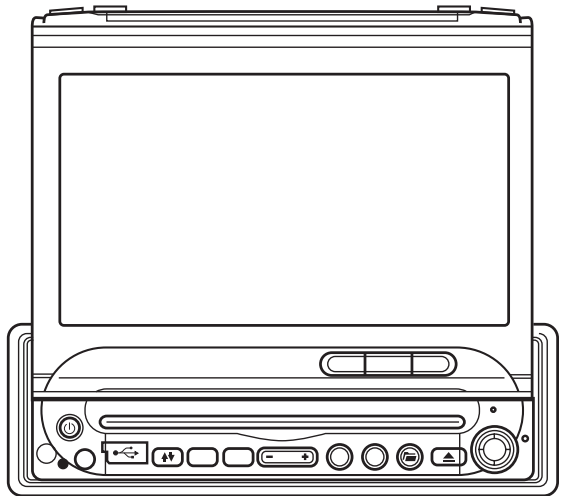

- **Vertical Adjustable And Horizontal Rotatable Panel**
- **7.0 Inch Touch Screen Monitor**
- **Multi-subtitle/audio Languages Function**
- **Multi-angle Function**
- **Smart Mode Function**
- **Parental Control**
- **Remote Control**

[www.lanzar.com](http://www.lanzar.com)

Download from [Www.Somanuals.com](http://www.Somanuals.com). All Manuals Search And Download.

# FEATURES

---

## **Compatible with PAL DVD (Video CD) and NTSC DVD (Video CD)**

This player can play discs recorded in either PAL or NTSC format.

- A single LSI chip now integrates all major DVD playback circuit functions including MPEG2 decoder, video D/A converter, and audio decoders.
- L/R stereo analog audio outputs for connection to existing head unit aux inputs. Video output is composite video.
- Supplied remote handles multi-function software (multi-language audio-track/subtitle, multi-angle, multi-story, etc.), plus all basic functions.

## **USE THIS PRODUCT SAFELY**

This set has been designed and manufactured to assure personal safety. Improper use can result in electric shock or fire hazard. The safeguards incorporated in this unit protect you if you observe the following procedures for installation, use and servicing. This unit doesn't contain any parts that can be repaired by the user.

### **When Driving**

Keep the volume level low enough to be aware of road and traffic conditions.

### **When Car Washing**

Do not expose the product to water or excessive moisture. This could cause electrical shorts, fire or other damage.

### **When Parked**

Parking in direct sunlight can produce very high temperatures inside your vehicle. Give the interior a chance to cool down before starting playback.

### **Use the Proper Power Supply**

This product is designed to operate with a 12 volt DC, negative ground battery system the regular system in a North American car).

### **Protect the Disc Mechanism**

Avoid inserting any foreign objects into the slot of this player.

Failure to observe this may cause malfunction due to the precise mechanism of this unit.

## **Use Authorized Service Centers**

Do not attempt to disassemble or adjust this precision product. Please refer to the Service Center list included with this product for service assistance.

## **For Installation**

The unit should be installed in a horizontal position with the front end up at a convenient angle, but not more than 30°.

## **Protect the Monitor Mechanism**

- The monitor is operated automatically. Do not draw the monitor out or turn it upward or downward manually. Otherwise, the mechanism construction may be harmed to some degree.
- When you operate the monitor with the remote handset, do not touch the monitor by your hands. It may harm your fingers.

# CONTENTS

---

|  |           |
|--|-----------|
| <b>Features</b> .....                    | <b>2</b>  |
| <b>Use This Product Safely</b> .....     | <b>2</b>  |
| <b>Safety Information</b> .....          | <b>4</b>  |
| <b>Disc Notes</b> .....                  | <b>5</b>  |
| <b>Installation</b> .....                | <b>6</b>  |
| <b>The Player</b> .....                  | <b>9</b>  |
| <b>Electrical Connection</b> .....       | <b>11</b> |
| <b>Remote Control</b> .....              | <b>12</b> |
| Preparing the Remote Control .....       | 14        |
| Loading a disc .....                     | 14        |
| Ejecting a disc .....                    | 14        |
| <b>Operation</b> .....                   | <b>15</b> |
| Basic Operation .....                    | 15        |
| Disc (DVD, VCD, CD, MP3) Operation ..... | 19        |
| Radio Operation .....                    | 24        |
| AV Operation .....                       | 25        |
| USB Play Operation .....                 | 25        |
| <b>Trouble Shooting</b> .....            | <b>26</b> |
| <b>Specification</b> .....               | <b>27</b> |

# SAFETY INFORMATION

---

## CAUTION:

MOBILE DVD PLAYER IS A CLASS I LASER PRODUCT. HOWEVER THIS MOBILE DVD PLAYER USES A VISIBLE/INVISIBLE LASER BEAM WHICH COULD CAUSE HAZARDOUS RADIATION EXPOSURE IF DIRECTED. BE SURE TO OPERATE THE MOBILE DVD PLAYER CORRECTLY AS INSTRUCTED.

USE OF CONTROLS OR ADJUSTMENTS OR PERFORMANCE OF PROCEDURES OTHER THAN THOSE SPECIFIED HEREIN MAY RESULT IN HAZARDOUS RADIATION EXPOSURE.

DO NOT OPEN COVERS AND - DO NOT REPAIR YOURSELF. REFER SERVICING TO QUALIFIED PERSONNEL.

## WARNING:

- TO REDUCE THE RISK OF FIRE OR ELECTRIC SHOCK, DO NOT EXPOSE THIS EQUIPMENT TO RAIN OR MOISTURE.
- TO REDUCE THE RISK OF FIRE OR ELECTRIC SHOCK, AND ANNOYING INTERFERENCE, USE ONLY THE RECOMMENDED ACCESSORIES.
- THIS DEVICE IS INTENDED FOR CONTINUOUS OPERATION.

This product incorporates copyright protection technology that is protected by method claims of certain U.S. patents and other intellectual property rights owned by Macrovision Corporation and other rights owners. Use of this copyright protection technology must be authorized by Macrovision Corporation, and is intended for home and other limited viewing uses only unless otherwise authorized by Macrovision Corporation. Reverse engineering or disassembly is prohibited.

## Region Management Information

Region Management Information:

This Mobile DVD Player is designed and manufactured to respond to the Region Management Information that is recorded on a DVD disc. If the Region number described on the DVD disc does not correspond to the Region number of this Mobile DVD Player, this Mobile DVD Player cannot play this disc.

# DISC NOTES

## Disc formats supported by this player



**DVD**  
12 cm disc  
(Single-sided disc only)



**Video CD**  
12 cm disc



**CD**  
12 cm disc



**MP3**  
12 cm disc

### Handling and Cleaning

- Dirt, dust, scratches and warping disc will cause misoperation.
- Do not place stickers or make scratches on discs.
- Do not warp discs.
- A disc should always be kept in its case when not in use to prevent from damage.
- Do not place discs in the following places:
  1. Direct sunlight
  2. Dirty, dusty and damp areas
  3. Near car heaters
  4. On the seats or dashboard

### Disc Cleaning

Use a dry soft cloth to wipe the surface. If the disc is quite dirty, use a soft cloth slightly moistened with isopropyl (rubbing) alcohol. Never use solvents such as benzine, thinner or conventional record cleaners as they may mar the surface of the disc.

### Note:

A disc may become somewhat scratched (although not enough to make it unusable) depending on the way it is handle and conditions in the usage environment.

Note these scratches are not an indication of any problem with the player.

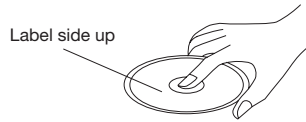

Label side up



Do not touch the underside of the disc



Do not bend

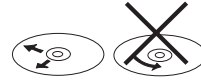

Wipe the disc from center toward the outside edge

### Preparing New Discs with Rough Spots

A new disc may have rough edges on its inside and outside edges. If a disc with rough edges is used, the proper setting will not be performed and the player will not play the disc. Therefore, remove the rough edges in advance by using a ball point pen or pencil as shown on the right. To remove the rough edges, press the side of the pen or pencil against the inside and outside edges of the disc.

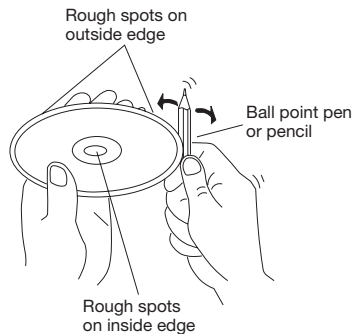

# INSTALLATION

## Notes:

- Choose the mounting location where the unit will not interfere with the normal driving function of the driver.
- Before finally installing the unit, connect the wiring temporarily and make sure it is all connected up properly and the unit and the system work properly.
- Use only the parts included with the unit to ensure proper installation. The use of unauthorized parts can cause malfunctions.
- Consult with your nearest dealer if installation requires the drilling of holes or other modifications of the vehicle.
- Install the unit where it does not get in the driver's way and cannot injure the passenger if there is a sudden stop, like an emergency stop.
- If installation angle exceeds 30° from horizontal, the unit might not give its optimum performance.

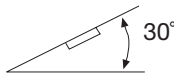

- Avoid installing the unit where it would be subject to high temperature, such as from direct sunlight, or from hot air, from the heater, or where it would be subject to dust, dirt or excessive vibration.

## DIN FRONT/REAR-MOUNT

This unit can be properly installed either from "Front" (conventional DIN Front-mount) or "Rear" (DIN Rear-mount installation, utilizing threaded screw holes at the sides of the unit chassis). For details, refer to the following illustrated installation methods.

## DIN FRONT-MOUNT (Method A) Installation Opening

This unit can be installed in any dashboard having an opening as show below:

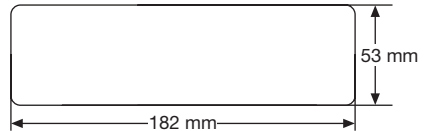

## Installing the unit

Be sure you test all connections first, and then follow these steps to install the unit.

1. Make sure the ignition is turned off, and then disconnect the cable from the vehicle battery's negative (-) terminal.
2. Disconnect the wire harness and the antenna.
3. Lift the top of the outer trim ring then pull it out to remove it.
4. The two supplied keys release tabs inside the unit's sleeve so you can remove it. Insert the keys as far as they will go (with the notches facing up) into the appropriate slots at the middle left and right sides of the unit. Then slide the sleeve off the back of the unit.

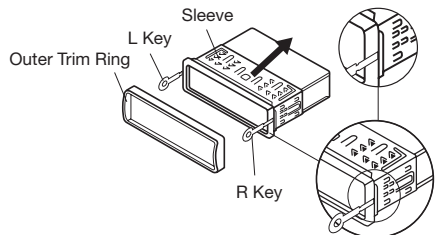

5. Mount the sleeve by inserting the sleeve into the opening of the dashboard and bend open the tabs located around the sleeve with a screwdriver. Not all tabs will be able to make contact, so examine which ones will be most effective. Bending open the appropriate tabs behind the dashboard to secure the sleeve in place.

# INSTALLATION

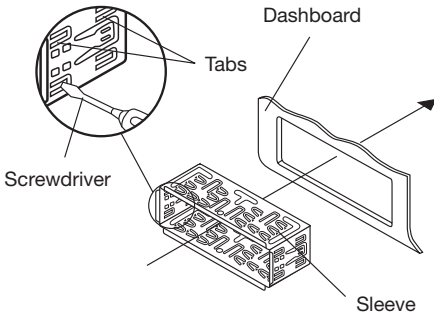

6. Reconnect the wire harness and the antenna and be careful not to pinch any wires or cables.
7. Slide the unit into the sleeve until it locks into place.
8. To further secure the unit, use the supplied metal strap to secure the back of the unit in place. Use the supplied hardware (Hex Nut (M5mm) and Spring Washer) to attach one end of the strap to the mounting bolt on the back of the unit. If necessary, bend the metal strap to fit your vehicle's mounting area. Then use the supplied hardware (Tapping Screw (5x25mm) and Plain Washer) to attach the other end of metal strap to a solid metal part of the vehicle under the dashboard. This strap also helps ensure proper electrical grounding of the unit.  
Note to install the short threading terminal of the mounting bolt to the back of the unit and the other long threading terminal to the dashboard.

9. Reconnect the cable to the vehicle battery's negative (-) terminal. Then replace the outer trim ring and install the unit's front panel. (see the steps of "using the detachable front panel").

## Removing the unit

1. Make sure the ignition is turned off, and then disconnect the cable from the vehicle battery's negative (-) terminal.
2. Remove the metal strap attached the back of the unit (if attached).
3. Lift the top of the outer trim ring then pull it out to remove it.
4. Insert both of the supplied keys into the slots at the middle left and right sides of the unit, then pull the unit out of the dashboard.

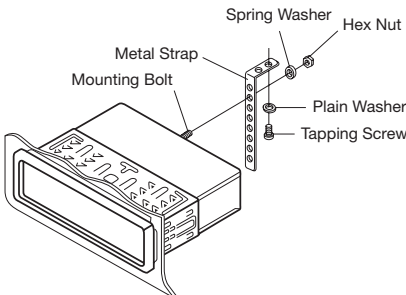
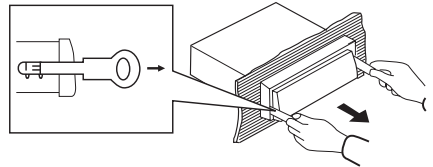

# INSTALLATION

## **DIN REAR-MOUNT (Method B)**

If your vehicle is a Nissan, Toyota, follow these mounting instructions.

Use the screw holes marked T (Toyota), N (Nissan) located on both sides of the unit to fasten the unit to the factory radio mounting brackets supplied with your vehicle.

When you install the front panel the unit will resume work automatically.

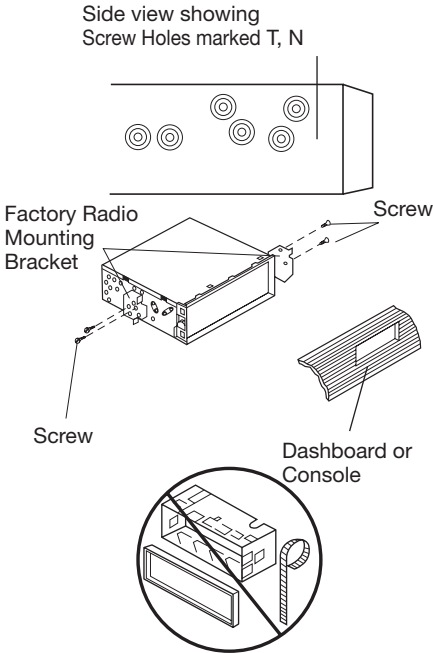

To fasten the unit to the factory radio mounting brackets.

1. Align the screw holes on the bracket with the screw holes on the unit, and then tighten the screws on each side.
2. Fasten with the supplied truss screws (5x5mm) or flush surface screws (4x5mm), depending on the shape of the screw holes in the bracket.

Note:

- (1) The outer trim ring, sleeve and the metal strap are not used for method B installation.
- (2) When the unit is on work, if you release the front panel, the unit will enter into the power off state automatically, and you can see the indicator LED flashing.



# THE PLAYER

## FRONT VIEW

Closed Position

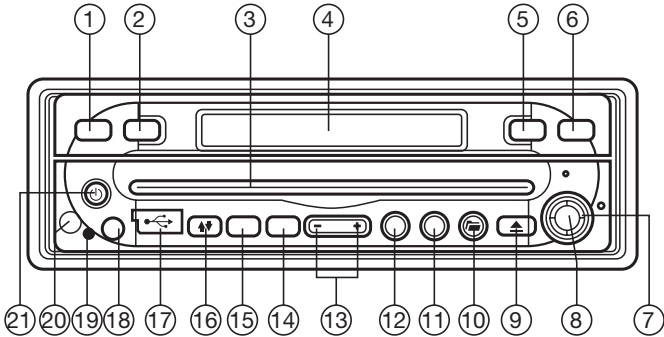

Open Position

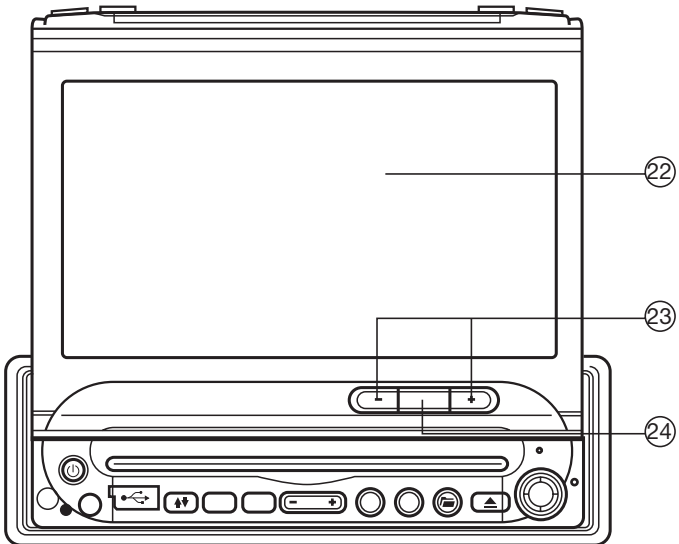

# THE PLAYER

---

1. BAND
2. AS/PS
3. Disc Slot
4. LCD Display
5. LOC
6. MO/ST
7. ◀/▶, △/▽ (Cursor Buttons)
8. ENT
9. ▲ (Eject)
10. ■ (MENU)
11. S(Smart MODE)
12. ▶|| /MUT
13. VOL+/-
14. MODE
15. DSP
16. ▲▼ (Open/Close)
17. ●↔ (USB Interface)
18. AV IN
19. Reset Button
20. Remote Sensor
21. ⏪ (BACK)
22. 7 INCH TFT TOUCH  
SCREEN MONITOR
23. SET+/-
24. SET/SRC

# ELECTRICAL CONNECTION

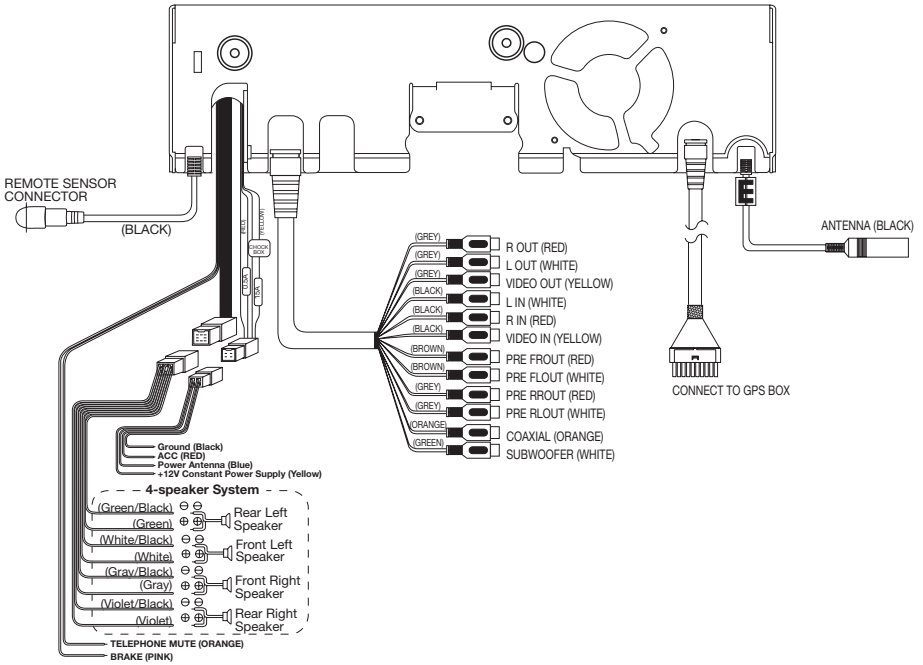





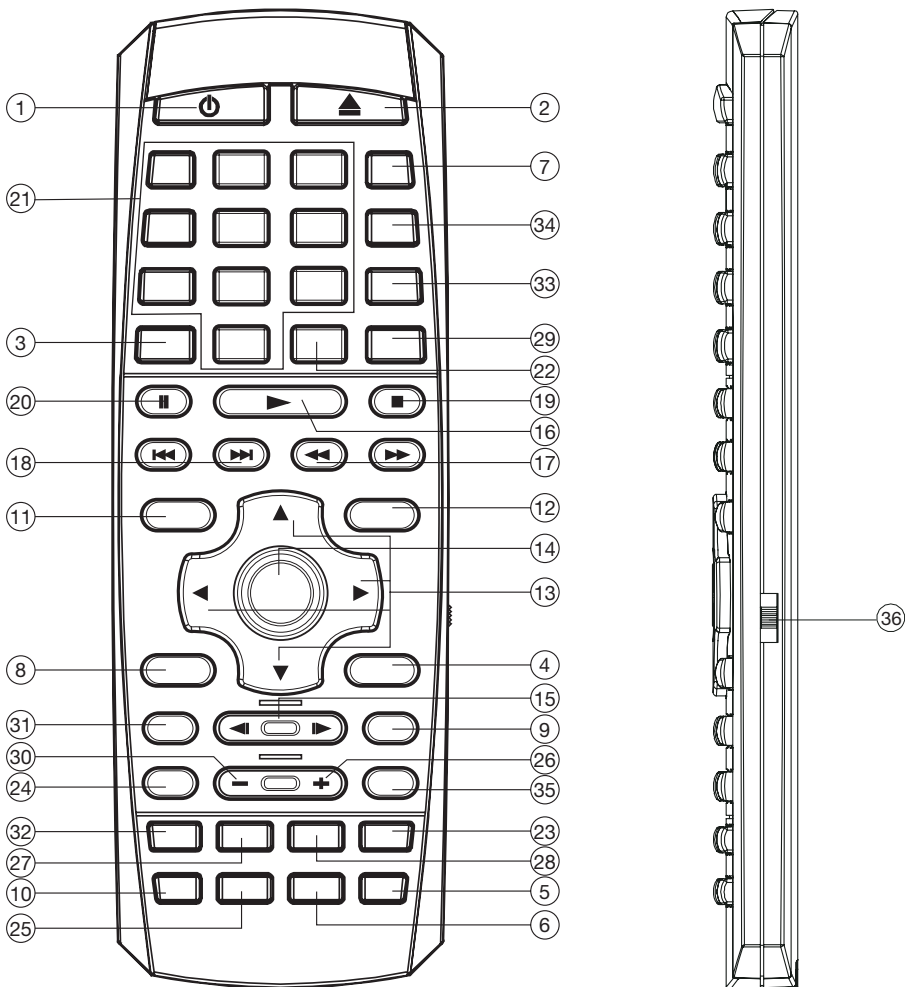























# REMOTE CONTROL

## LOCATION AND FUNCTION OF KEYS



# REMOTE CONTROL

---

1.  Press POWER to turn the unit ON or OFF.
2.  Press to eject the disc.
3. EQ Press it to select desired audio equalization.
4. SUBT/BACK Changing of the SUBTITLE language on multi-subtitle language DVD disc. In menu operation on the screen press it to return to the previous menu.
5. ANG Changing of the view angle on multi-angle DVD disc.
6. DISP Display statistical disc information during playback in DVD mode.
7. MODE Press to change the input source.
8. SETUP Display the SETUP menu in DVD mode.
9. PROG Allows the track played in the order you programmed.
10. AUD Changing of the AUDIO soundtrack on multi-audio soundtrack DVD disc. Changing of the sound mode of the VCD/CD discs.
11. TITLE(DSP) Display the TITLE menu that is stored in DVD disc. In other mode, press DSP to display the current mode on or off.
12. MENU Display the main menu.
13.     In case of MENU mode,     buttons served as cursor buttons to select item left/right, ahead/back. In FM mode, use   to choose the frequency.
14. OK Confirm the Track/Chapter selected with the numeric buttons or selected with the cursor buttons on screen.
15.   Changing for slow forward/reverse playback motion on DVD disc.
16.  Press to play the disc.
17.   Press  to search forward rapidly &  to search reverse rapidly. In FM mode, use   to search the frequency.
18.   Press  to skip to the next track & press  to skip back one track. In radio mode, press   to select the preset station.
19.  Press it to stop playback.
20.  Press it to pause playback.
21. 0-9 Numeric buttons
22. MO/ST In radio mode press the button to set the reception between mono mode or stereo mode.
- /- - No defining.
23. P/N Switch between PAL mode and NTSC mode.
24. S-M Press it to enter SMART MODE function.
25. ZOOM Allows the picture to be increased in size.
26. VOL+ Press VOL+ button to increase the volume level.
27. GOTO Disc search button in DVD mode, cooperatively used with numeric buttons. No defining.
28. RDM (SHF) Press it to play all tracks on CD in random order.
29. LOC(CLEAR) In FM mode, press it to select between local and distant stations. If you press the RESUME button, you can press CLEAR button to clear the stop point.
30. VOL- Press VOL- button to decrease the volume level.
31. RPT Switch the Repeat mode of discs.
32. A-B A-B repeat allows a passage to be repeated continuously.
33. AS/PS In radio mode, press it to activate Automatic Memory Storing/Program Scanning function.
34. BAND(PBC) In radio mode, press it to select desired band. Changing between PBC ON and PBC OFF on the VCD disc.
35. MUTE In radio, DVD, AV1, AV2 mode, press to mute the sound.
36. DVD-AUDIO Switch it to select operation mode among, DVD and AUDIO.

# REMOTE CONTROL

---

## Preparing the Remote Control

### *Inserting the Batteries*

1. Open the battery compartment cover.
2. Insert the new batteries. Make sure that the positive and negative terminals of the batteries are oriented as indicated.
3. Close the cover  
Battery: One button cell lithium battery.

### *Using the Remote Control*

Point the remote control towards the remote control signal receiver on the player front face.

Operation angle: About  $\pm 30$  degree in each the direction of the front of the remote sensor.

## LOAD/EJECT A DISC

---

### **Loading a Disc**

1. Turn the ignition on to the accessory position.
2. Press the  $\odot$  button (21).
3. Insert the disc with printed side facing up into the disc slot (3).
4. The player will start playback automatically.

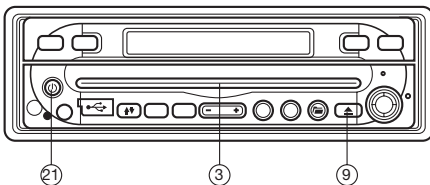

### **Ejecting a Disc**

In any mode, press  $\blacktriangle$  button (9) to eject the disc.

# OPERATION

## BASIC OPERATION

### ◆ Turning the player on/off

Shortly press  $\odot$  button on the front panel or on the remote control to turn the player on.

When the unit is on, press and hold  $\odot$  button on the front panel or shortly press  $\odot$  button on the remote control will turn the unit off.

(Note: Shortly press  $\odot$  button on the front panel will return the previous menu.)

### ◆ Open/Close the Monitor

Press  $\blacktriangle/\blacktriangledown$  button on the front panel the monitor will draw out automatically.

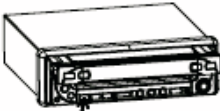

Press this button to draws out the monitor

When the monitor draws out to a certain location, it will turn upward automatically and stop at vertical position.

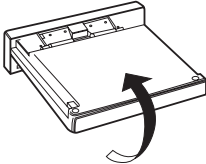

Return the monitor to the central viewing position, then press  $\blacktriangle/\blacktriangledown$  button on the front panel.

the monitor will turn downward automatically.

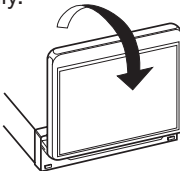

When the monitor turns downward to a certain angle, it will draw in.

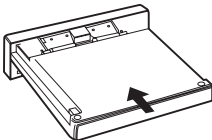

**Note:** The panel has automatic protection function. If the panel was hit by suddenly, it would be pushed into the unit. Please

wait for several seconds, the panel will slide out automatically.

### ◆ Screen Adjustment (Angle/ Slide/ Picture)

1) Method A (Adjust the angle/ slide/ picture):

When the monitor stops moving, touch the screen you will see the following picture(for the different mode the picture has a little difference):



Touch the **SCR** icon on the screen or press **SET/SRC** button on the front panel, the following picture will appear:

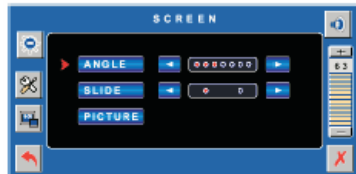

Tap  $\blacktriangle/\blacktriangleright$  icon to adjust the monitor angel upward/downward in small steps or draw the panel in/out to get a desired viewing position.

Tap the **PICTURE** icon on the screen, touch  $\blacktriangle/\blacktriangledown$  to adjust the picture among Bright /contrast /Color /Tint. Or use  $\blacktriangle/\blacktriangleright$  icon to adjust the picture continuously.



Shortly press **SET/SRC** on the front panel to select Angle or Slide items. Then use +/--buttons on the front panel to turn the monitor angel upward/downward in small steps or draw the panel in/out to get a desired viewing position.

And you can rotate the monitor left and right from the central viewing position at a certain angle range manually.

# OPERATION

## Note:

1. Don't rotate the monitor forcibly to avoid mechanical damage.
2. When the front panel is on the outside position (**Slide** item select the right dot.), you can adjust the angle of the panel. Pushing the front panel into the slot, the front panel will be drawn out after several seconds.

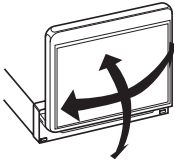

Note: Under the label (printed "Take out screw before turn TFT"), there is a screw on the back of the unit, before you turn the TFT monitor, please take it out.

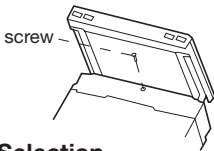

## ◆ Mode Selection

- 1) Tap SRC icon on the touch screen, or press and hold **SET/SRC** button on the front panel for several seconds, SOURCE picture will appear:

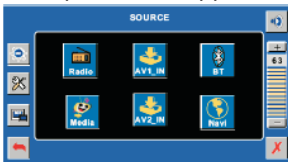

Tap the different icon on the screen to select the corresponding mode among: Radio, Media, AV1-IN, AV2-IN, BT(Optional), Navi(Optional).

- 2) Press **MODE** button on the remote control to select among RADIO, MEDIA, AV1-IN,AV2-IN, BT(Optional), Navi(Optional).

## ◆ Remote Sensor

There is a remote sensor on the front panel. You can point the remote control handset to the remote sensor on the front panel and press function keys on the remote control to control the unit. The unit is also connected to an external remote receiver (See the electrical connection diagram above), and the function is the same with the remote sensor on the front panel.

## ◆ 7 Inch TFT Monitor Display

When the monitor stretches out, the 7 inch TFT Monitor display can show the current state of the unit.

## ◆ Volume Level Adjustment

Press **VOL+/-** buttons on the remote control or **+/-** icon on the right side of the screen to increase or decrease the volume level.

Shortly press **MUT** on the front panel or **MUTE** on the remote control or tap

the  icon on the right side of the screen will mute the sound. Shortly

press **MUT** or **MUTE** or tap  icon again the sound will resume.

Note: if there is no operation of the volume bar, the volume bar will disappear automatically. Tap the right place of the screen, it will appear.

## ◆ Reset

Press  on the front panel to release the front panel you will see the Reset button (See THE PLAYER picture above.) It must be activated with either a ballpoint pen or thin metal object. The reset button is to be activated for the following reasons:

- Initial installation of the unit when all wiring is completed.
- All the function buttons do not operate.
- Error symbol on the display.

## ◆ Setup

Press MENU button on the remote control or tap any place on the screen

main menu will appear. Then tap  icon on the left of the screen will enter the **SETUP** interface like followed picture (note: Only in Media mode the "DVD SETUP" bar can be displayed):





Note:

For all the operation on the screen, you can tap the corresponding icon on the screen or use **◀/▶**, **▲/▼** and **OK** buttons on the remote control to select and confirm.



# OPERATION

Tap  will return to the previous menu,  
 tap  to turn off the current menu.  
**1) AUDIO**  
 Tap AUDIO bar to enter the AUDIO menu.

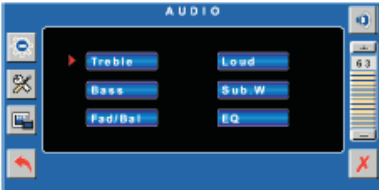

Tap the Treble, Loud, Bass, Sub.W, Fad/Bal, EQ bar to adjust the different items. (Note: when the unit has not subwoofer function, tapping Sub.W bar on the screen doesn't work.)  
 A: Treble Adjustment



Use  to adjust the treble level between -14dB~14dB.  
 B: Loud Selection



Use  to select loud ON or OFF.  
 C: Bass Adjustment



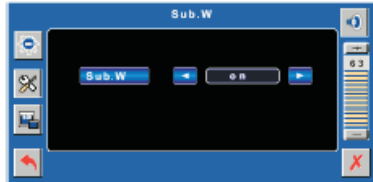

Use  to adjust the bass level between -14dB~14dB.  
 D: Subwoofer Selection (Only for the unit with subwoofer function.)

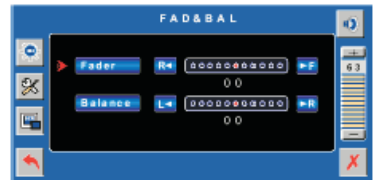

Use  to select subwoofer on or off.  
 E: Fader/Balance Adjustment



Use  to adjust the sound level of the front/rear speaker.  
 Use  to adjust sound level of the left/right speaker.  
 F: EQ selection



Tap the corresponding bar to select the different sound mode: Flat, Rock, Classic, POP, Jazz, Custom.  
 Note: when you select the different sound mode, the corresponding value of BASS and TREBLE will be displayed on the screen.

## 2) SYSTEM

Tap the SYSTEM bar to enter SYSTEM menu.

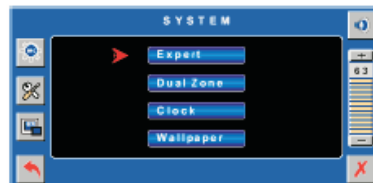

# OPERATION

## A: Expert menu



In expert menu, the following operation will be allowed:

- Use ◀/▶ to select Beep on or off.
- Use ◀/▶ to turn the Clock display on or off.  
Note: With the expert menu on, when select clock on, the current time will be displayed on the up right of the screen, and you can see the time is changing. When exit the expert menu the clock will be displayed on the up right of the screen.  
When select clock off, the current clock will be stopped, when you exit the expert menu, the clock display will be turned off.
- Use ◀/▶ to turn the Zone on or off. (only in radio mode, you can change Zone to ON.)
- Use ◀/▶ to select the mode of time between 12H/24H per day.

## B: Dual Zone

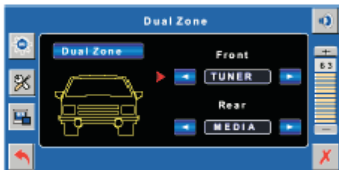

For the front speaker, use ◀/▶ to select corresponding items.

How to operate dual zone, please refer to the following Smart Mode Operation section.

## C: Clock adjustment

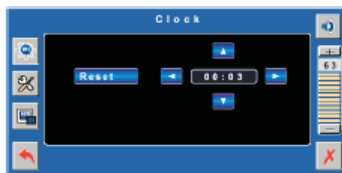

Using ◀/▶ to select the hour and minute. Then using ▲/▼ to change the value of the hour and minute.

Note: Tap the Reset bar on the screen will

reset the time to “00:00”.

## D: Wallpaper selection



Use ◀/▶ to select the wallpaper among: Blue, Black and Cyan.

## 3) DVD SETUP

Please refer to the **DISC (DVD, VCD, CD, MP3) OPERATION** part in this instruction manual.

## 4) DEFAULT

Tap the DEFAULT bar on the SETUP menu, you will be asked “Are you sure to load factory default setting?”, if you want to select default setting, tap ENTER bar on the screen or press OK button on the remote control to confirm, and “Load factory ok !” will appear on the screen.

### ◆ Note (FOR THE UNIT WITH TEL-MUTE AND BRAKE FUNCTION)

- 1) When there is an incoming call, the unit will be in mute state, and “TEL MUTE” appears on the screen display.
- 2) If the brake wire isn’t connected to the ground (when driving, in BRAKE OFF), the picture will not be shown on the screen in DVD/AV mode for safety purpose. Only the audio will be heard.

### ◆ Smart Mode Operation

Shortly press S-M button on the remote control or S (Smart MODE) button on the front panel to enter Smart Mode.

- 1) When the current mode is TUNER, BT press S-M or S to enter smart mode, the front zone mode is TUNER, the rear zone mode can be switched among MEDIA, AV1 IN and AV2 IN. In this time, the front speaker’s audio is RADIO, the rear speaker’s audio will be muted. And AV OUT is DVD, AV1 IN or AV2 IN.
- 2) (Only for the unit with navigation function.)

When the current mode is NAVI, Press S-M or S to enter smart mode, the front zone mode is NAVI, the rear zone mode can be switched between TUNER and DVD. In this time, if there is no navigation sound, the front/rear

# OPERATION

speaker's audio is RADIO or DVD. When the speaker's sound is RADIO, AV OUT is no output. When the speaker's sound is DVD, AV OUT is DVD. If there comes navigation sound, the current front speaker's audio will be switched to navigation sound, the rear speaker's audio is RADIO or DVD. When the speaker's sound is RADIO, AV OUT is no output. When the speaker's sound is DVD, AV OUT is DVD.

## DISC (DVD, VCD, CD, MP3) OPERATION

In media mode, tap anywhere of the screen the DVD menu will be displayed on the screen:



### ◆ Stopping Playback

Shortly press **■** button on the remote control or on the screen one time to pre-stop the unit playback. When **▶/||** button on the front panel or **▶** on the screen or on the remote control is pressed, normal playback will continue.

Press **■** button twice to stop the playback and go back to the DVD LOGO.

### ◆ Pausing Play/Step Play

Pressing **▶/||** on the front panel or on the remote control or on the screen during playback will stop playback temporarily. To return to normal playback, press **▶/||** again.

If you play a DVD/VCD/SVCD, second press **▶/||** on the front panel for several seconds to stop at the next picture (step function). If you play a CD/MP3/Picture CD, second press **▶/||** on the front panel for several seconds is ineffective.

### ◆ Rapid Forward/Rapid Reverse

Press **▶▶** & **◀◀** on the screen or on the remote control during playback. Each time the button is pressed, the speed of rapid forward /reverse changes according to the disc as follows.

DVD/VCD/CD/MP3:

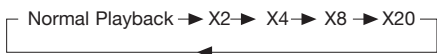

### ◆ Slow Motion Playback (For DVD Only)

Press **▶/◀** on the remote control during play. Each time the button is pressed, the speed of slow forward / reverse changes according to the disc as follows.

DVD:

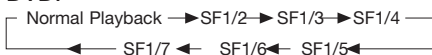

In slow motion state, press **▶** on the remote control to recover normal playback.

### ◆ Skipping Track

Press **▶▶/||◀◀** buttons on the remote control or on the screen or **◀/▶** on the front panel during playback.

Press **▶▶** to skip to the next track, and press **◀◀** to skip to the previous track.

**Note:** For some VCD2.0 discs (PBC-playback control), **▶▶/||◀◀** buttons may be unavailable.

### ◆ DVD Video Menu Play

When playing a DVD disc in the DVD player:

- 1) The disc will be played automatically and stop at menu picture.
- 2) Use **◀/▶, ▲/▼** cursor buttons to move between the highlight bars in the menu.
- 3) Press **OK** button on the remote control to confirm the selected item.

### ◆ Last Play Memory

- 1) During disc playback, if you hold **⏻** power on the DVD unit for several seconds or press **⏻** power button on the remote control to turn off the unit and then press the **⏻** power button on the DVD unit again to turn on the unit, the DVD unit will resume playing from the point that just interrupted.
- 2) During disc playback, if you press **MODE** button to switch to other mode, then return to DVD mode again, the unit will resume playing from the point that just interrupted.

### ◆ Repeat Play/Paragraph Repeat Play

**Repeat play:** when you want to repeat playing the whole disc or a track or a chapter in the disc.

- 1) Press **RPT** button repeatedly to select different repeat modes.
- 2) For different kinds of discs, pressing **RPT** button has different effects.

For DVD:



# OPERATION

For VCD/SVCD/CD/MP3/WMA:



**Note:** REPEAT feature does not support VCD2.0 (with PBC ON).

**Paragraph Repeat Play: when you want to repeating play a desired paragraph.**

A-B repeat allows a passage to be repeated continuously.

1) Press **A-B** button first at the start of the required passage:

**REPEAT A-**

2) Press **A-B** button secondly at the end of the passage:

**REPEAT A-B**

3) Then the unit will repeat playing the passage you just set from A to B.

4) To revert to normal playback, press **A-B** button again.

**A-B CANCEL**

## ◆ Shuffle/Random Play

Press **RDM/SHF** button on the remote control will play the tracks in shuffle order, and "SHUFFLE" will appear on the screen. Press this button again will exit shuffle play mode, and "SHUFFLE: [OFF]" will appear on the screen.

Note: when playing a DVD disc, this button is an invalid key.

## ◆ PBC Menu Playback of VCD/SVCD

For some VCD or SVCD discs, there is a menu in order to select the desired contents. This menu is called PBC (Playback Control) menu.

Press **PBC** button on the remote control to change between PBC ON and PBC OFF on the disc.

In PBC ON mode, REPEAT, RANDOM, BOOKMARK, A-B, PROGRAM and GOTO functions are unavailable.

## ◆ ON-SCREEN DISPLAY FUNCTION

Press the **DSP** button during playback to display the console information of the current disc on the screen.

**For DVD:**

**Once you press DISP button you will see the information as the following order.**

DVD TT 1/1 CH 4/28 C 00:07:12

1/1 ENG 5.1CH 3/4 FRE OFF

DVD TT 1/1 CH 4/28 C -00:05:15

DVD TT 1/1 CH 4/28 T 00:15:55

DVD TT 1/1 CH 4/28 T -01:48:33

1) Item: TT

Function: Display the current title number and total title number.

2) Item: CH

Function: Display the current chapter number and total chapter number.

3) Item: ⌚

(This icon only displayed for several seconds, after several seconds it will disappeared.)

Function: Display the played time of the current chapter.

4) C-: Display the remaining time of the current chapter.

5) T: Display the player time of time current title.

6) T-: Display the remaining time of the current title.

7) C: Display the played time of the current chapter.

8) 1/1 ENG 5.1CH 3/4 FRE OFF

Display the current disc's LANGUAGE, AUDIO TYPE, SUBTITLE LANGUAGE and PLAY ANGLE.

**For VCD:**

CD TRK 4/16 HDCD ex C 00:00:08

CD TRK 4/16 HDCD ex C -00:03:31

CD TRK 4/16 HDCD ex T 00:13:21

CD TRK 4/16 HDCD ex T -00:58:04



## OPERATION

**OK** will clear the information you have programmed.

### For data disc including audio (MP3/WMA), movie(MPEG), picture (JPG) files:

The operation is the same as VCD/CD operation.

Press **PROG** button on the remote control the following media play window will be shown on the screen:

|       |   |   |   |   |   |       |   |   |    |   |   |
|-------|---|---|---|---|---|-------|---|---|----|---|---|
| Prog- |   |   |   |   |   |       |   |   |    |   |   |
| T     | C | T | C | T | C | T     | C |   |    |   |   |
| 1     | : | : | 5 | : | : | 9     | : | : | 13 | : | : |
| 2     | : | : | 6 | : | : | 10    | : | : | 14 | : | : |
| 3     | : | : | 7 | : | : | 11    | : | : | 15 | : | : |
| 4     | : | : | 8 | : | : | 12    | : | : | 16 | : | : |
| Play  |   |   |   |   |   | Clear |   |   |    |   |   |

#### Note:

➤ When playing tracks you programmed, press **PROG** button to enter the program interface, press **PROG** for second time will exit the menu and the unit will resume to normal play. When you want to return to program play, press **PROG** to enter program interface and select **PLAY** then use **OK** button to confirm, it will begin program play. And "PROG PLAY" will appear on the screen.

#### ◆ DVD SETUP

##### There are two method to enter the DVD SETUP menu:

Method A: In DVD mode, when the disc is playing or in stop mode, press **SETUP** on the remote control to enter setup menu.  
Method B: in SETUP menu, tap the DVD SETUP bar to enter the menu.

When the cursor is on the topside, use ◀ / ▶ buttons to move between the different pages.

\* Press ▼ button to move the cursor to the setup page below and then you can use ▲ / ▼ buttons to move between the different setup options.

\* Press ▶ button to display the choice list for each setup option and then use ▲ / ▼ buttons and **OK** button to change your selection.

#### SYSTEM SETUP

When you open the setup menu, you will see the system setup page at first, see below:

##### SYSTEM SETUP

- TV SYSTEM
- SCREEN SAVER
- TV TYPE
- PASSWORD
- RATING
- DEFAULT
- EXIT SETUP

- 1) TV SYSTEM: Change the TV mode among NTSC, PAL and AUTO.
- 2) SCREEN SAVER: Change the SCREEN SAVER on or off.
- 3) TV TYPE: Change the TV TYPE among 4:3PS, 4:3LB and 16:9.
- 4) PASSWORD: Change the PASSWORD lock or unlock, the default PASSWORD is "0000".
- 5) RATING: Change the parental RATING among 1KID SAFE, 2G, 3PG, 4PG13, 5PG-R, 6R, 7NC-17, 8ADULT.
- 6) DEFAULT: Restore the system setup to the default setup.

#### LANGUAGE SETUP

- When you open the language setup menu, you will see the language setup page:

##### LANGUAGE SETUP

- OSD LANGUAGE
- AUDIO LANG
- SUBTITLE LANG
- MENU LANG

EXIT SETUP

# OPERATION

You can change the OSD LANGUAGE among: English, German, Spanish, French, Portuguese, Italian and Russian. You can change the AUDIO/ SUBTITLE/ MENU language among: English, French, Spanish, German, Italian, Portuguese, Russian. And you can select audio/subtitle/menu language off.

## AUDIO SETUP

- When you open the AUDIO menu, you will see the following picture:

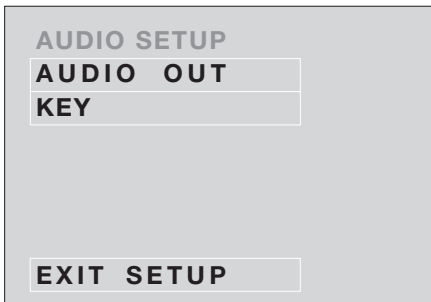

- 1) AUDIO OUT: Change among SPDIF/OFF, SPDIF/RAW and SPDIF/PCM.
- 2) KEY: Change among -4, -2, 0, +2, +4.

## FREQUENTLY ASKED QUESTIONS

- When inserting a DVD disc, why it can't be played, just showing "region error"? It is because that the DVD player and the discs all have the "REGION CODE". If the region number described on the DVD disc does not correspond to the region number of this DVD player, the unit cannot play the disc.
- When inserting a DVD disc, there is a window shown on the screen that requires entering 4 characters password, why? It is because that the current disc has "Parental Control" level, and the player's parental level is set below the level of the disc, you should enter the correct password to play the disc normally.

## NOTE:

- For how to set the "Parental Control" level, please refer to "SYSTEM SETUP \RATING" in the following page.

## ATTACHMENT: PARENTAL CONTROL

DVD discs have a parental level assigned to the disc. The range of parental controls is from 1 to 8.

The player can be set in a similar way. If the player's parental level is set to 8 it will play all discs. If the player's parental level is set below 8, only discs with a lower or equal parental level will play.

For example if the player is set to 5, only discs with parental control ratings of 5, 4, 3, 2, & 1 will play. To play a higher rated disc you must change the player's rating to a higher number.

For example, consider a disc that generally is suitable for most audiences, and is rated as level 2 for the most part. However in the middle there are also scenes rated at 5 & 7 (not suitable for children). Alternative scenes with lower rating are included.

The player plays the highest rated scene that the parental setting allows.

A section of the disc can have several different sequences that vary in parental control level. In the above example of a disc with parental control, the player will show a different section depending on the parental control level set in the player's menu. In this way parents can control the content of films and there is no indication that any censorship has occurred.

The meaning of the levels 1 to 8 varies depending upon the country and the type of content on the disc.

The parental control levels are:

- Unlock
- 1 KID SAFE
- 2 G
- 3 PG
- 4 PG 13
- 5 PG-R
- 6 R
- 7 NC-17
- 8 ADULT

# OPERATION

## RADIO OPERATION

### ◆ Switching to radio mode

Press **MODE** button on remote control to select radio mode or tap the **Radio** icon on the **SOURCE** menu on the screen.

In radio mode, the following information will appear on the display.

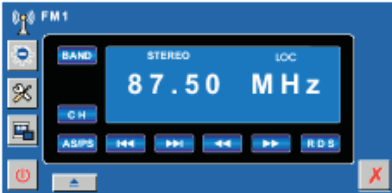

### ◆ Selecting the frequency band

Press **BAND** on remote control or tap **BAND** bar on the screen to select desired band. The reception band will change in the following order:

For two wave bands:

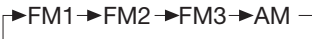

### ◆ Selecting station

During radio mode, shortly press ► button on the front panel or on the remote control or tap ►► icon on the screen to increase frequency, shortly press ◀ button on the front panel or on the remote control or tap ◀◀ icon on the screen to decrease frequency by one step of channel spacing. Hold the button longer for fast tuning. The frequency is updated correspondingly on display.

Press and hold ◀/► buttons on the front panel, "Manual" will appear on the screen display, you can adjust the frequency manually. If there is no operation for about 5 seconds, "Manual" will disappear. The system will exit this mode.

### ◆ Setting memory

Press **RADIO PRESET** buttons (1~6) on remote control or press ▲/▼ on the front panel or on the remote control to preset stations at radio mode. With this system, a total of 24 stations (for two wave band) or 30 stations (for three wave band) can be stored in the memory of six buttons. Each band stores up to six preset stations.

The stations might be FM1, FM2, FM3, MW band. The operation is as below:

- Store in Memory Press and hold desired memory location button for several seconds. The current listening station will be stored into the number button.
- Or tap "CH" character on the screen then press and hold M1~6 button bars on the screen will store the current station to the location button.
- Retrieve a Preset Station Press any one of the **RADIO PRESET** buttons (1~6) on remote control to retrieve a station which had been stored in the memory in advance the chosen number is shown on display.

### ◆ Automatic Memory Store & Program Scanning

- Program scanning Shortly press **AS/PS** button on remote control or on the front panel to scan preset station. And it will hold at each station for about 5 seconds.

- Automatic memory storing Press and hold **AS/PS** button on remote control for about several seconds or press **AS/PS** button on the front panel, the radio searches from the current frequency and checks the signal strength until one cycle search is finished. And then stations are stored into the preset number button in turn according to the strength of the stations. When auto search is finished, it will enter into preset scan mode automatically.

**Note:** In FM mode press and hold 1-6 numeric buttons on the front panel or on the remote control for about 2 seconds, will store the current station to the current numeric key position.

### ◆ Mono/Stereo

Press **MO/ST** button on remote control to select mono or stereo mode. You can sometimes improve reception of distant stations by selecting mono operation.

### ◆ Local/Distant

Press and **LOC** button on the remote control to select between local and distant stations. Local setting for reception of strong Station, and a distant setting for reception of weaker stations.



# OPERATION

When search station in LOC mode, if there is no station available, it will switch to DIS mode and search station automatically. If there is no station available too it will stop searching and return to LOC mode.

When search station in DIS mode, if there is no station available, it will stop searching in DIS mode.

## AV OPERATION

### Switching to AV mode

There is a pair of AUDIO/VIDEO INPUT jacks on the front and back of the unit. When you connect an audio/video system through these jacks, press MODE button on the remote control or on the front panel to select AV mode.

### USB PLAY OPERATION (OPERATION)

On the back of the unit, there is an USB socket. An USB driver can be connected through this interface.

- 1) Connect a USB driver to the USB interface, the unit will read the files stored in the USB device automatically.
- 2) When there is a disc in the disc slot, connecting a USB driver to the USB interface, the unit will play the disc. Press ■ (stop) or || (pause) button on the remote control or ►||/MUT on the front panel to enter STOP or PAUSE mode, then press GOTO button to read the USB device.  
When in USB play mode, be sure not to remove the USB driver from the USB interface. When stop USB play, you can remove the USB drive, after remove USB driver from the unit, the unit will play the disc automatically.
- 3) In USB play mode, you can press MODE button on remote control to switch the mode to other mode.

- The main unit can only support the standard USB-memory disc which is approved by Microsoft.
- USB MP3 player is not a standard which means different brand name or different models have their own standard. So our product cannot support every MP3 player.
- When connecting an MP3 player and there has normal battery in the player (non rechargeable battery), you should remove the battery from the MP3 player then connect it to the USB interface. Otherwise, it may cause battery burst.

## USB PLAY OPERATION

On the front panel of the unit, there is an USB interface. An USB driver can be connected through this interface.

- 3) When there is no disc in the disc slot, connect an USB driver to the USB interface, and change the mode to MEDIA mode, the unit will read the files stored in the USB device automatically. When reading an USB device, if insert a disc to disc slot, the unit will read the disc automatically.
  - 4) If there is a disc in the disc slot, connecting an USB driver to the USB interface, when changing the mode to MEDIA mode, the unit will play the disc. Press ■ (stop) or || (pause) button on the remote control or press and hold ►||/MUT on the front panel to enter PRE-STOP, STOP or PAUSE mode, then press GOTO button to read the USB device.
    - \* When reading the USB device, Press ■ (stop) or || (pause) button on the remote control or ►||/MUT on the front panel to enter PRE-STOP, STOP or PAUSE mode, then press GOTO button will play the disc.
    - \* When reading the USB device, disconnect the USB device, the unit will play the disc automatically.
- The main unit can only support the standard USB-memory disc which is approved by Microsoft.
  - USB MP3 player is not a standard which means different brand name or different models have their own standard. So our product cannot support every MP3 player.
  - When connecting an MP3 player and there has normal battery in the player (non rechargeable battery), you should remove the battery from the MP3 player then connect it to the USB interface. Otherwise, it may cause battery burst.
  - When in USB play mode, be sure not to remove the USB driver from the USB interface.

# TROUBLE SHOOTING

---

If it appears that your DVD unit is faulty, first consult this checklist. It may be that something simple has been overlooked.

**Under no circumstances should you try to repair the player yourself, as this will invalidate the warranty. Only qualified service personnel can remove the cover or service this player.**

## **NO POWER**

- Check if the on/off button on the front of the player is set to on.
- Check if AC or DC power plug of the mains unit is properly connected.
- Check if there is power at the AC or DC outlet.

## **NO PICTURE**

- Check if the mode is set to proper state, such as DVD mode, RADIO, TV, AV and RGB mode.
- Check the video connection.

## **DISTORTED PICTURE**

- Check the disc for fingerprints and clean with soft cloth, wiping from centre to edge.
- Sometimes a small amount of picture distortion may appear. This is not a malfunction.

## **THE PICTURE IS OVER DARK, OVER BRIGHT OR HAS NO COLOR**

Enter the picture setup menu (refer to the Picture mode Adjustment above) to adjust the corresponding item (BRIGHT, CONTRAST, COLOR or TINT) to proper value, then you can get an optimum picture effect.

## **COMPLETELY DISTORTED PICTURE**

- The disc format is not according to the TV-set used (PAL/NTSC).

## **DISC DOES NOT PLAY**

- Ensure the disc label is upwards.
- Clean the disc.
- Check if the disc is defective by trying another disc.

## **NO SOUND**

- Check audio connections.
- If using a HIFI amplifier, try another sound source.

- Check if the volume is minimum, and adjust the VOL+ to increase the volume level.

## **NO RETURN TO START-UP SCREEN WHEN DISC IS REMOVED**

- Press POWER to turn off the unit, then press it again to turn on the unit.
- Press Reset button on the front of the DVD unit.

## **THE PLAYER DOES NOT RESPOND TO THE REMOTE CONTROL**

- Aim the remote control directly at the sensor on the front of the player.
- Avoid all obstacles which may interfere with the signal path.
- Inspect or replace the remote control batteries.

## **NO AUDIO AT DIGITAL OUTPUT**

- Check the digital connections
- Check the Digital Audio menu to make sure that the digital output is correctly set.
- Check if the audio format of the selected audio language matches your receiver's capabilities.

## **BUTTONS DO NOT WORK**

- Turn the player off and on with the power on/off button on the front of the player.
- Press Reset button on the front of the DVD unit.



## Free Manuals Download Website

<http://myh66.com>

<http://usermanuals.us>

<http://www.somanuals.com>

<http://www.4manuals.cc>

<http://www.manual-lib.com>

<http://www.404manual.com>

<http://www.luxmanual.com>

<http://aubethermostatmanual.com>

Golf course search by state

<http://golfingnear.com>

Email search by domain

<http://emailbydomain.com>

Auto manuals search

<http://auto.somanuals.com>

TV manuals search

<http://tv.somanuals.com>