

Lancast®

CenturyStack®

8100 Managed Hub

10/100Mbps

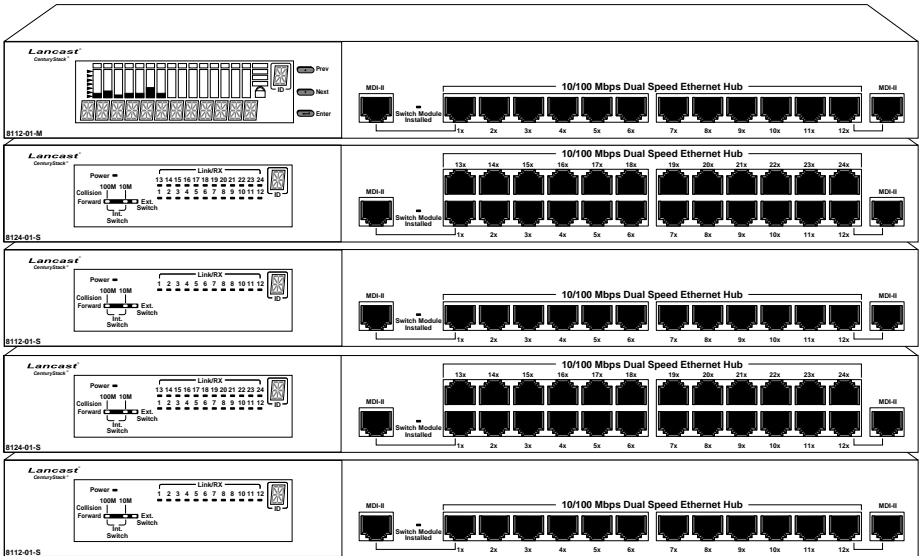

Installation & User Guide

Models: 8124-01-M / 8124-01-S
8112-01-M / 8112-01-S

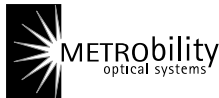

© 1998-1999 METRObility Optical Systems, Inc.

All rights reserved.

Printed in USA.

This publication is protected by the copyright laws of the United States and other countries, with all rights reserved. No part of this publication may be reproduced, stored in a retrieval system, translated, transcribed, or transmitted, in any form, or by any means manual, electric, electronic, electromagnetic, mechanical, chemical, optical or otherwise, without prior explicit written permission of METRObility Optical Systems, Inc.

Lancast and CenturyStack are registered trademarks of METRObility Optical Systems, Inc. All other trademarks appearing in this manual are the property of their respective owners.

The information contained in this document is assumed to be correct and current. The manufacturer is not responsible for errors or omissions and reserves the right to change specifications at any time without notice.

Table of Contents

CenturyStack® 8100 Managed Hub Installation & User Guide

Introduction	7
Unpacking the CenturyStack 8100 Managed Hub	7
Overview of the CenturyStack 8100 Managed Hub	7
Key Features	9
Front Panel Overview	12
Managed Slaves	12
LED Indication	13
Master Units	15
Rear Panel Overview	16
Installation	17
1 Choosing a Location	17
Stacking	17
Rack Mounting	17
Using Cascade Cables	18
Constructing a Management Stack	18
Position Within the Stack	18
Master Hub Role	19
Slave Hub Role	19
Hub ID	19
Segmenting Hubs	19
Connecting Devices	19
Cables	19
Workstations	20
Connecting to Ethernet Hubs or Devices	20
Connecting to Fast Ethernet Switching Hubs and Devices	21
Connecting to Other Dual Speed Hubs	21

Using Expansion Modules	23
2 Expansion Module Overview	23
Internal Bridge Function	23
External Bridge Function	23
Backpressure (flow control)	24
Installing a Bridge Module	24
TX Module LED Indicators	26
FX Module LED Indicators	27
Module 8102-01-X	28
Module 8103-01-X	30
Module 8102-03-X	32
Module 8103-03-X	34
 Managing Through the Mini Console	 37
3 Mini Console Overview	37
Features	37
VFD Display	38
Observing Basic Port Information	38
Port Indicator Definition	39
Console Keys	39
Menu Tree	40
Observing Network Traffic	42
Selecting a Group	43
Monitoring Port Statistics	44
Selecting a Port to Monitor	45
Monitoring Port Detail Information	47
Monitoring All Ports Status	47
Monitoring Individual Port Status	49
Configuring Ports	50
Configuring All Ports	50
Configuring a Single Port	51
Unit Configuration	52
Configuring the Unit	53

Locking the Mini Console	53
Unlocking the Mini Console	54
Network Configuration	55
IP Address Configuration	55
Subnet Mask	57
Default Gateway	57
Out-of-Band Configuration	57
Securing the Hub	57
Setting the Password	57
Cancelling the Password	58
In case You Forget the Password	58
Restarting the Hub	59
Restoring the System Default Setup	59
System Information Menu	60

4 Master Hub Configuration & Console Management 61

Connecting the Console Interface	61
Menu Convention	62
Using the Console Program	64
Logging In	64
Main Menu	65
Monitoring System Information	66
Setting Up for Management	68
Network Configuration	69
Local Console/Remote Telnet-Ethernet	69
Local Console/Remote Telnet-SLIP	70
Serial Port Configuration	72
SNMP Community Setup	74
Trap Receiver Setup	76
Web-Based Management Configuration	78
Trap Filter	80
Controlling Devices	81
Repeater Group Control/Status	82
Repeater Port Control/Status	85

2/3 Port Bridge Module Control/Status	87
Redundant Link Control	90
Security Intrusion	94
Monitoring the Network	96
Repeater Statistics Information	97
Repeater Group Statistics Information	99
Repeater Port Statistics Information	101
Address Tracking Information	105
Address Search Information	107
Broadcast Storm Protection	109
Broadcast Storm Detected	111
User Authentication	112
System Utility	114
System Download	115
System Restart	116
Factory Reset	118
Login Timeout Interval	119
Configuration Upload Setting	120
Configuration Upload Request/Status	122
SNMP Management	122

Technical Information **123**

5

Product Specifications	123
Agency Compliance	126
RFI Statements	126
Warranty & Servicing	127

Appendix **129**

Mini Console Menu Tree	129
Troubleshooting the Network	130

Introduction

Unpacking the CenturyStack 8100 Managed Hub

Check that the following components have been included:

- 8100 Series Hub
- Rack Mount Bracket and Hardware
- Rubber Feet
- Cascade Cable
- Power Cord
- Installation & User Guide (this manual)

Your order has been provided with the safest possible packaging. Inspect it carefully. If you discover any shipping damage, notify the carrier and follow their instructions for damage and claims. Be sure to save the original shipping carton if return or storage of the unit is necessary.

Overview of the CenturyStack 8100 Managed Hub

The CenturyStack® 8100 Series Hubs are auto sensing, dual speed, manageable and stackable hubs. The CenturyStack 8100 Series Managed Hubs consist of masters and managed slaves with 12 or 24 ports. The features and functions of the CenturyStack 8100 Managed Series makes it a powerful, cost-effective solution for large campus networks and rapid growth companies.

All models in the CenturyStack 8100 Series Managed Hubs accept slide-in expansion modules, adding more power and versatility, such as: bridging 10Mbps and 100Mbps segments and extending distances up to 2 kilometers.

Dual Speed CenturyStack Managed Hub 8112-01-M/S

The CenturyStack twelve port models are 8112-01-M (master) and the 8112-01-S (managed slave).

The 8112-01-M master model shown below includes a Network Management Unit (NMU), Mini-Console, 12 dual-speed auto sensing ports, 2 MDI-II ports and a switch module expansion slot.

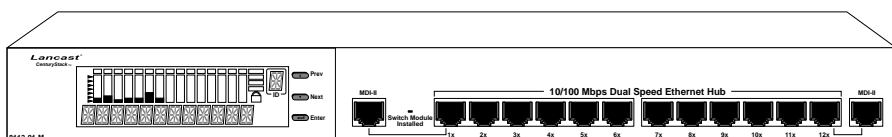

Dual Speed CenturyStack Hub 8112-01-M (Master with NMU)

The 8112-01-S managed slave model shown below, includes an LED panel, 12 dual-speed auto sensing ports, 2 MDI-II ports, and a switch module expansion slot. The 8112-01-S can be fully managed by any master model.

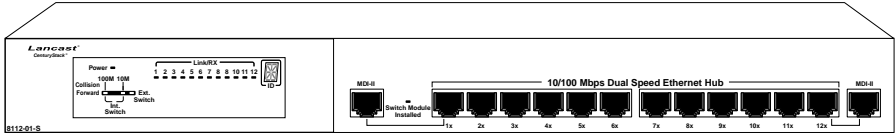

Dual Speed CenturyStack Hub 8112-01-S (Managed Slave)

Dual Speed CenturyStack Managed Hub 8124-01-M/S

The CenturyStack twenty-four port models are 8124-01-M (master) and 8124-01-S (managed slave).

The 8124-01-M master model shown below includes a Network Management Unit (NMU), Mini-Console, 24 dual-speed auto sensing ports, 2 MDI-II ports and a switch module expansion slot.

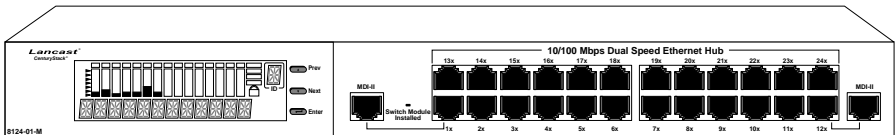

Dual Speed CenturyStack Hub 8124-01-M (Master with NMU)

The 8124-01-S Managed Slave model shown below, includes an LED panel, 24 dual-speed auto sensing ports, 2 MDI-II ports, and a switch module expansion slot. The 8124-01-S can be fully managed by any master hub model.

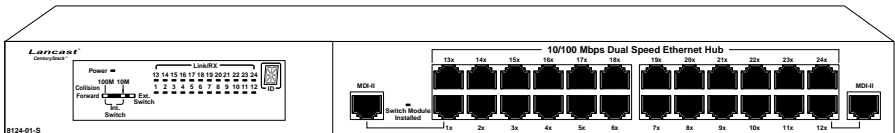

Dual Speed CenturyStack Hub 8124-01-S (Managed Slave)

Key Features

The CenturyStack Dual Speed Managed Hub Series has many advanced features:

10/100Mbps Auto Sensing Ports

All ports in the CenturyStack 8100 Series are dual speed auto sensing, including the MDI-II ports. Hubs automatically detect the transmission speed and set the port accordingly.

Stackability

Every model in the CenturyStack 8100 Series is compatible, and can be configured in the same stack with up to 6 hubs, using cascade cables.

Expansion Slots

Every model in the CenturyStack 8100 Series has one slot for adding expansion modules, see below. The lower slot accepts switch expansion modules. See *Chapter 2: Using Expansion Modules* for more information. The upper slot is for the Network Management Unit (NMU) only.

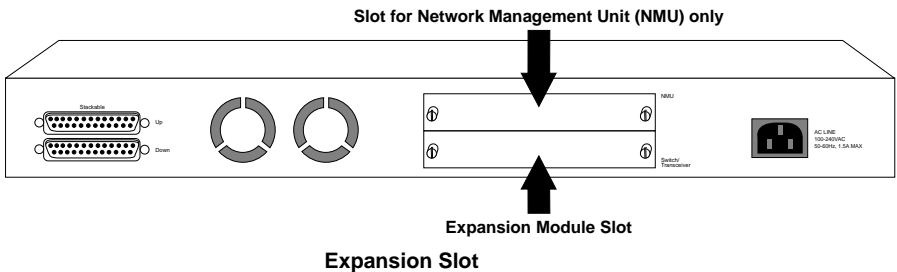

Manageability

The CenturyStack 8100 Series Hubs provide extensive management capabilities including: Mini-Console Management for device level management, Console Management using a VT-100 terminal emulator, Web-Based Management using a Web Browser or SNMP network management.

- Mini-Console Management
- Local Console/Remote Telnet
- Out-of-Band Management
- Web-Based Management
- SNMP Management

RMON Probe Capability

The Remote Network Monitoring (RMON) probe is an instrument that exists for the purpose of managing a network. The goals of the RMON probe are described in the following sections: Offline Operation, Proactive Monitoring, Problem Detection and Reporting, Value Added Data, and Multiple Managers. The CenturyStack 8100 Managed Series Hubs support RMON group (1) statistics, group (2) History, group (3) Alarm, and group (9) Event.

- **Offline Operation:** This allows a probe to be configured to perform diagnostics and to collect statistics continuously, even when communications with the management station may not be possible or efficient.
- **Proactive Monitoring:** The monitor can notify the management station of failure and can store historical statistical information about the failure. The management station can play this historical information back in an attempt to perform further diagnosis into the cause of the problem.
- **Problem Detection and Reporting:** The monitor can be configured to recognize conditions, most notably error conditions, and to continuously check for them. When one of these conditions occurs, the event may be logged, and management stations may be notified in a number of ways.
- **Value Added Data:** By highlighting those hosts on the network that generate the most traffic or errors, the probe can give the management station precisely the information it needs to solve a class of problems.
- **Multiple Managers:** Remote monitoring can deal with multiple management stations using its resources concurrently.

Redundant Link Capacity

Redundant links can be configured enabling up to 24 pairs in a CenturyStack. For each pair of redundant links one port must be set as the primary and active, the other as backup and isolated. If the primary port fails, it is isolated and the backup port is set to primary and active.

Address Tracking Capability

CenturyStack provides MAC Address based tracking capability for traffic analysis to diagnose network problems such as Intrusion. This function records the source MAC address of each data packet received by the port and provides the filter for data analysis. Up to 15 source MAC addresses can be detected on each port.

Source Address Search Capability

CenturyStack provides Source Address Search Capability. This active address tracking capability is used to watch for a given MAC address and report on which port it was seen. This capability can be used to collect the necessary information for mapping the topology of a network. Up to 8 MAC addresses can be searched simultaneously. You can configure address search parameters including Source MAC address and Address Search Status with local console management, Web-Based Management or SNMP management.

Security Intrusion Control Capability

CenturyStack provides MAC Address based Security Intrusion Control Capability to prevent any unauthorized nodes access to the network. You can configure the hub to take various actions when a violation is detected. Actions include: no action, sending a trap message or partitioning a port.

Broadcast Storm Detection and Protection Capability

CenturyStack provides Broadcast Storm Detection and Protection Capability by periodically monitoring the broadcast counters of each port to detect a broadcast storm. Ports detected causing a broadcast storm are automatically partitioned, a trap is sent to the network manager, or no action is taken, depending on the configuration.

Front Panel Overview: Managed Slaves

An LED panel, 12 dual-speed, auto sensing ports, switch module installed LED, and 2 MDI-II shared ports are on the front panel of the unit. See below.

An LED panel, 24 dual-speed, auto sensing ports, switch module installed LED, and 2 MDI-II shared ports are on the front panel of the unit. See below.

The Switch Module Installed LED is on if a switch module is installed in the hub.

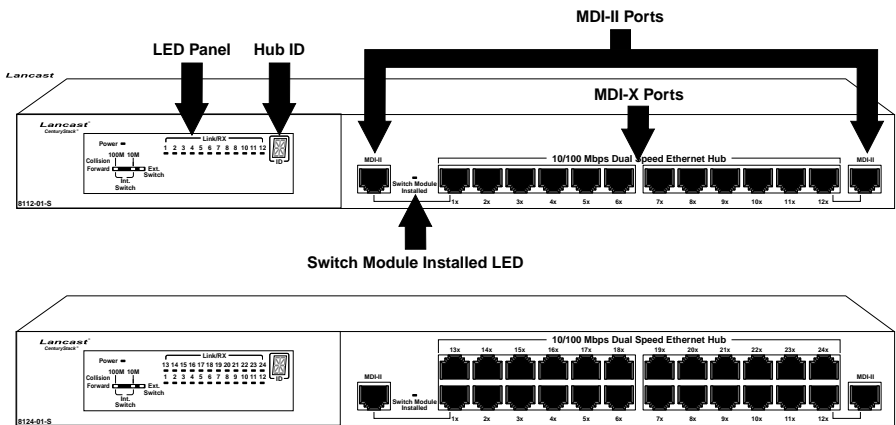

Front Panel 8112-01-S (12 Ports)

Front Panel 8124-01-S (24 Ports)

LED Indication

The hub's LEDs indicate status information for the device, its ports for both segments (10Mbps and 100Mbps), and switch status.

LED Indicators 12 Port

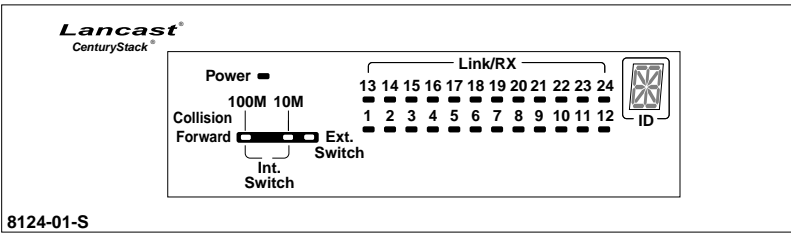
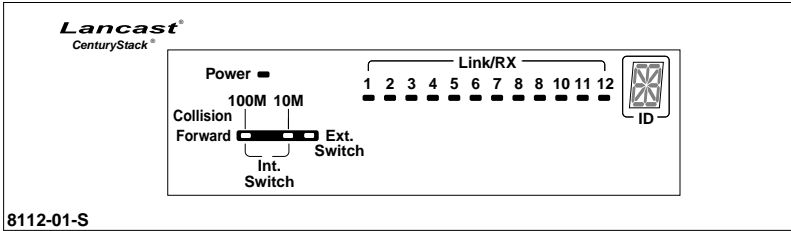

LED Indicators 24 Port

- **Power:** The Power LED is on when the power cable is plugged into the hub and a wall socket.
- **Link/Rx:** The Link/Rx LED is on for each connected port and blinks for ports receiving transmissions.
- **Collision:** Collision LEDs indicate collision for either segment (10Mbps and 100Mbps). If there is collision in a segment the LED for that segment is on.
- **Forward:** Packet forwarding is active via the switch module connecting both 10Mbps and 100Mbps domains. Forward LED indicates the packet forward status through the switch modules. Forward for both segments (10Mbps and 100Mbps) is indicated in the table on the next page.

Forwarding LED* indicator meaning				
Forward LED	Status	Int Switch	Ext Switch	Meaning
100M	On	On	Off	A 10Mbps transmission being received by 100Mbps segment through the internal switch
100M	On	Off	On	A 10Mbps transmission being received by 100Mbps segment through the external switch
10M	On	On	Off	A 100Mbps transmission being received by 10Mbps segment through the internal switch
10M	On	Off	On	A 100Mbps transmission being received by 10Mbps segment through the external switch
100M	On	On	On	A 10Mbps transmission being received by 100Mbps segment through the internal switch and through the external distance extender (Modules 8103-01-X and 8103-03-X only)
10M	On	On	On	A 100 Mbps transmission being received by 10Mbps segment through the internal switch and through the external distance extender (Modules 8103-01-X and 8103-03-X only)

*NOTE: Collision LED is amber. All other LEDs are green.

- **Internal Switch (Bridge):** The Internal Switch LED is always on when the internal switch (bridge) function is active and forwarding the data.
- **External Switch (Bridge):** The External Switch LED is on when data is being forwarded from one segment to another segment through the external switch port.
- **Hub ID:** Each linked hub is automatically assigned a hub ID number and this number is indicated in the ID indicator.

Front Panel Overview: Master Units

The front panel for model 8112-01-M supports the Mini Console, switch module installed LED, 12-10/100 ports, and 2-MDI-II ports.

The front panel for model 8124-01-M supports the Mini Console, switch module installed LED, 24-10/100 ports, and 2-MDI-II ports.

The switch module installed LED is on if a switch module is installed.

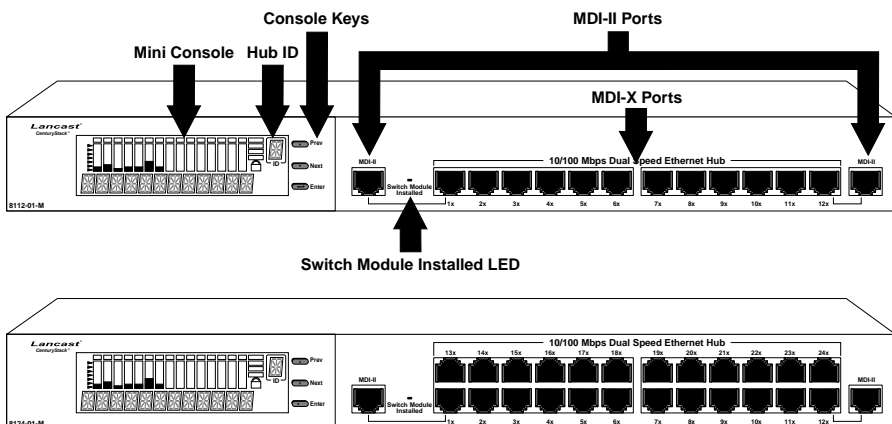

Front Panel CenturyStack 8112-01-M (12 Port)

Front Panel CenturyStack 8124-01-M (24 Port)

Mini Console

The Mini Console is a high definition display with console keys that enables you to easily monitor and configure the system. The Mini Console provides watch diagnostic functions, including port settings, status monitoring, traffic utilization, collision, and error rate.

With the Mini Console, you can configure each device in a CenturyStack hub and all of its ports. For more information see *Chapter 3: Managing Through the Mini Console*.

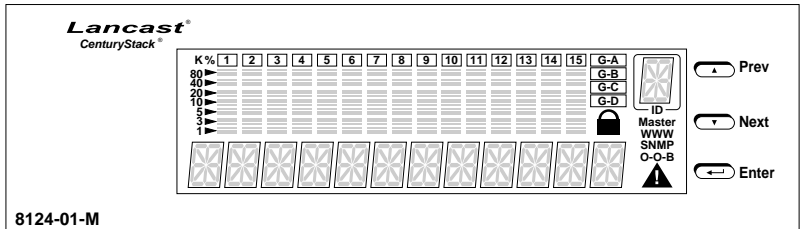

Mini Console

Rear Panel Overview

The rear panel of each hub in the CenturyStack 8100 Series supports 2-expansion slots, two cascade ports and an AC power socket. The cascade ports are used for cascading hubs (stacking hubs); the Up port of one hub must be connected to the Down port of the other hub.

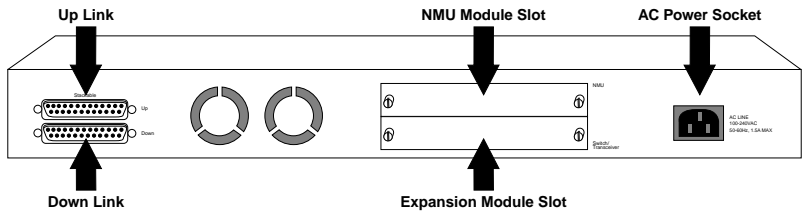

Chapter 1

Installation

Choosing a Location

The CenturyStack location should be less than 100 meters from servers, workstations, or switches. The CenturyStack can be desk mounted or rack mounted.

CAUTION: Category 5 UTP/STP cables are environmentally sensitive. Make sure that the cable route is not too close to electrical noise sources such as power lines or fluorescent lights.

Stacking

The CenturyStack Managed Series are stackable in standard 19" racks. Up to six hubs can be stacked with cascade cables. One master and up to five slaves can make up a stack. The master can be positioned anywhere in the stack, so you can add to a stack without re-positioning the hubs.

Rack Mounting

Rack mounting brackets are included to mount hubs in a standard EIA 19-inch racks.

Align the mounting brackets on the sides of the unit with the slit over the holes. Secure the screws tightly to fix the brackets to the device. Then, place the device into the 19" rack and affix it properly. Please ensure that the ventilation holes on the unit are not blocked.

Using Cascade Cables

You can stack the CenturyStack 8100 Series hubs using cascade cables. The master hub can be placed anywhere in the stack. By cascading the hub stack, each hub is automatically identified and assigned an ID number according to its position in the stack.

Cascading hubs with cascade cables to make a stack is as simple as connecting the **Up port** of one hub to the **Down port** of another hub as illustrated below.

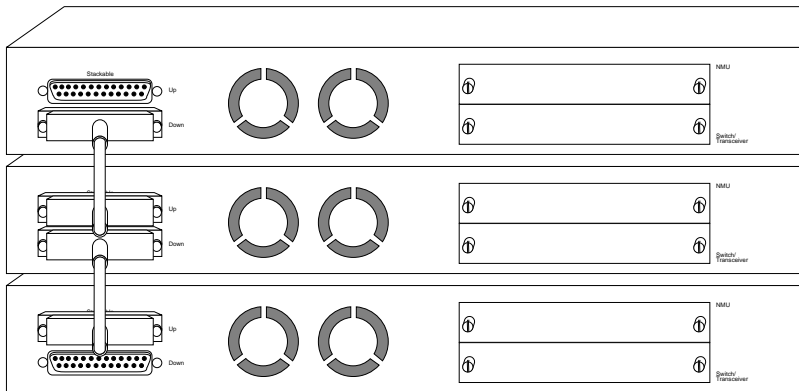

Cascade Ports

NOTE: To connect the cascade cable, the **Up port** on one hub connects to the **Down port** of another hub.

Constructing a Management Hub Stack

A stack can be constructed with up to six hubs in total. One master hub and up to five slave hubs can exist in one stack.

Position within the Stack

The master hub can be positioned anywhere in a stack and automatically assigns the ID of each hub according to its position in the stack.

Master Hub Role

The master is used to manage and configure other hubs in the stack and supplies the stack with additional ports (12/24) and an additional expansion module slot. The master hub can also be used as a stand-alone intelligent hub. Managing the hubs can be accomplished with the master hub's versatile management capabilities, such as:

- **Mini Console Management**

Refer to Chapter 3: Managing Through the Mini Console

- **Console Management**
Refer to Chapter 4: Console Management
- **Web-Based Management**
Refer to the CenturyStack Network Management Guide
- **SNMP Management**
Refer to the CenturyStack Network Management Guide

Slave Hub Role

Slave hubs supply the stack with additional ports (12/24) and an additional expansion module slot. Slave hubs can be positioned above or below the master hub. The 8112-01-S and 8124-01-S can also act as stand alone unmanaged hubs.

Hub ID

The master hub and slave hubs can be positioned anywhere in the stack and each hub's ID is automatically assigned based on its position (in the stack).

Segmenting Hubs

CenturyStack hubs can isolate one or both segments (10 Mbps and 100 Mbps segments) from the other hubs in a stack. When a segment is isolated it does not repeat to the other segments in the hub or to other segments in the stack.

Connecting Devices

The dual speed CenturyStack can connect to 10Mbps, 100Mbps, or 10/100Mbps devices due to its auto sensing capability. CenturyStack will auto sense the connected port speed and set its port to match the speed of the connected port.

Cables

CenturyStack ports accept Cat 3, 4 and 5 cables with RJ-45 connectors for 10Mbps connections and Cat 5 cables with RJ-45 connectors for 100Mbps connections. The maximum length of cables, between hub and workstations is 100 meters. The maximum length of cables, between hub and hub is 5 meters for 100Mbps connections and 100 meters for

10Mbps connections. All ports are hot pluggable. It is recommended you label each cable to identify the device or port at each end.

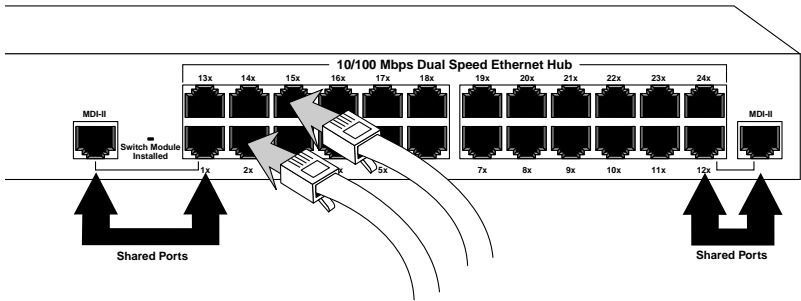

Connecting Devices

Connecting Workstations

Install either a 10BASE-T or a 100BASE-TX Fast Ethernet Network Interface Card into each workstation if not already installed. Using a UTP/STP cable, connect the Ethernet card (in the workstation) to a CenturyStack port.

Connecting Ethernet Hubs or Devices

Connect 10Mbps devices using UTP/STP Cat 3, 4 or 5 cables with RJ-45 connectors, enabling sending/receiving to or from other 10Mbps devices. By default, each port is set in auto sensing mode. CenturyStack can detect a 10BASE-T device and transmit/receive information to/from it.

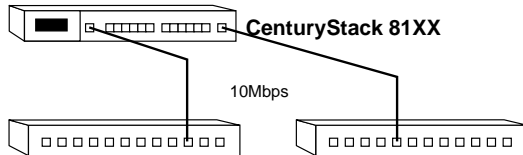

Connecting Ethernet Hubs

Connecting Fast Ethernet Switching Hubs

Connect 100Mbps devices using UTP/STP Cat 5 cables with RJ-45 connectors, maximum length 5 meters, enabling sending/receiving to other fast Ethernet switching hubs. By default, each port is set to auto sensing mode. CenturyStack can detect a connected 100BASE-TX device and transmit/receive information to/from it. The distance between switching hubs can be extended up to 2km by connecting two hubs through expansion modules using fiber cable.

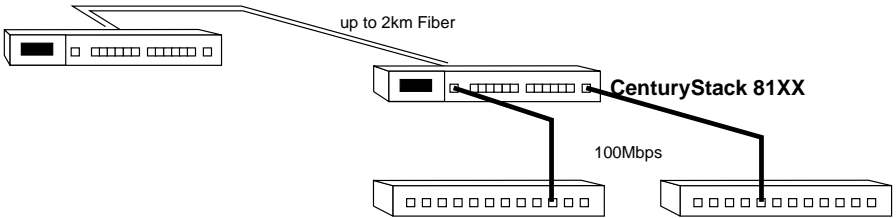

Connecting Fast Ethernet Hubs

Connecting the Other Dual Speed Hubs

Other dual speed hubs can be connected to the ports of the CenturyStack Hubs. Each port can auto sense the connected port speed and set its speed to match the connected port. The maximum distance between devices is 5 meters using Cat 5 UTP/STP cable. To increase the distance between dual speed hubs you must use fiber cable and connect using an expansion switch module. For more information about expansion switch modules, refer to *Chapter 2: Using Expansion Modules*.

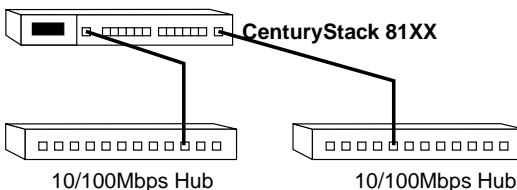

Connecting Other Dual Speed Hubs to a CenturyStack Hub

Chapter 2

Using Expansion Modules

Expansion Module Overview

Expansion modules provide additional functions such as internal bridging of 10Mbps and 100Mbps segments and extended distances between devices. The available modules are:

- **Module 8102-01-X:** 2 port Bridge or 10/100BASE-TX Switch Module
- **Module 8102-03-X:** 2 port Bridge or 100BASE-FX Fiber Distance Extender Switch Module
- **Module 8103-01-X:** 3 port Bridge and 10/100BASE-TX Switch Module
- **Module 8103-03-X:** 2 port Bridge and 100BASE-FX Fiber Distance Extender Switch Module

With CenturyStack, the software setting for *Bridging Module Admin State* (external distance extender function and internal function) is disabled by default. The *Admin State* of a bridge module must be configured using Console or Web-Based Management after installation.

Internal Bridge Function

The Internal Bridge Function is used for bridging 10Mbps and 100Mbps segments in a hub or in a stack. Only one internal switch can be enabled in a CenturyStack, more than one will cause network looping.

IMPORTANT: There can only be one internal switch enabled in a CenturyStack, however multiple external bridges are allowed. Therefore, if more than one module exists in a CenturyStack, ensure that only one module has its internal bridge enabled.

External Bridge Function

The external bridge function is used to extend the distance between 100Mbps hubs or stacks from the normal limitation of five meters to one hundred meters with TX modules using RJ 45 cable. With FX modules using fiber cable, you can expand the distance between hubs or stacks up to 2km.

Backpressure (flow control)

When packets are passed from 100Mbps segments to 10Mbps segments the flow is restricted due to the lesser capacity of the 10Mbps segment causing backpressure and resulting in dropped packets. With flow control or backpressure enabled, packets are made to wait until the flow is unrestricted before being sent, reducing the number of dropped packets.

Installing a Bridge Module

Power down CenturyStack before installing a bridge module. Bridge modules have both hardware and software configuration settings. The hardware configurations must be made before you physically install the module and the software configurations must be made using a master hub, after the module is installed and before the bridging functions take effect. Please read this section carefully before installing modules.

IMPORTANT:

- **These modules are not hot swappable. You must remove power from the hub before installing or replacing a bridge module.**
- **You should enable the internal bridge on only one bridge module when you have multiple bridge modules installed in a CenturyStack. This prevents a network loop condition.**
- **Three bridge modules are shipped with the Internal Bridge function enabled (8102-01-X, 8103-01-X and 8103-03-X), only the 8102-03-X is shipped with the Internal Bridge function disabled. All models ship with the backpressure function disabled.**

To install these modules, perform the following steps. Use static sensitive precautions.

1. Set the bridge function and backpressure function by moving the appropriate jumpers. See the following sections for the bridge module model that you are installing and set the jumpers accordingly.

2. Remove the power from the hub by disconnecting the power cable from the AC outlet.
3. Remove the installed bridge module or blank cover of the expansion module slot (not the NMU slot, only the bottom slot is available) by turning the two knobs on the front counterclockwise as shown below.

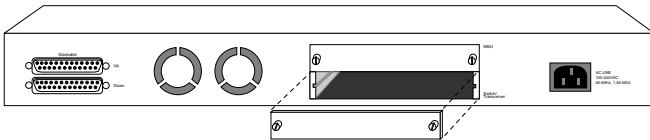

Removing the Blank Module Panel

4. Insert the new module, ensuring that the edges slide through the guides, as shown below.

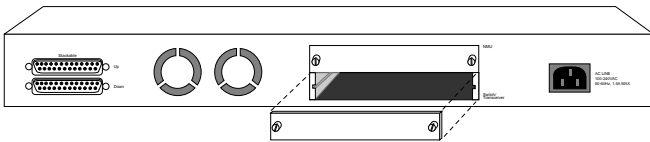

Insert the Module

5. Turn the two knobs on the new bridge module until they are securely attached to the hub.
6. Connect the appropriate communication cable to the new module.
7. For stand alone slave models the installation is complete, just connect AC power.
8. If your adding this hub to an existing stack, connect the hub to the stack. Refer to *Chapter 1: Using Cascade Cables*.
9. Reconnect the AC power cord to the wall outlet.

10. For a hub stack with a master present, you must configure the software for the installed bridge module to enable the internal bridge function because the software default setting is disabled. The default software setting will not allow the internal bridge function to enable. The software must be configured using a master hub.

11. Start a Console or Web-Based Management session and set the software configuration for the new module. For information on starting a console session, refer to *Chapter 4: Console Management*. For information on Bridge Module configuration, refer to *Chapter 4: Console Management: Controlling Devices*.

TX Module LED Indicators

The LEDs on each module indicate port activity. All LEDs are green.

- **Link:** On, indicates a link is up.
- **TX:** On, indicates a transmission in progress.
- **RX:** On, indicates receiving data.
- **100M:** On, indicates the 100 Mbps segment is linked. Off, indicates the 10 Mbps segment is linked when TX or RX LED is also on. (NOTE: if there is no cable connected to the module, the LED is on by default)
- **FDX:** On, indicates the port is set to *full duplex*. Off, indicates the port is set to *half duplex*.
- **Collision:** On, indicates collision occurring.

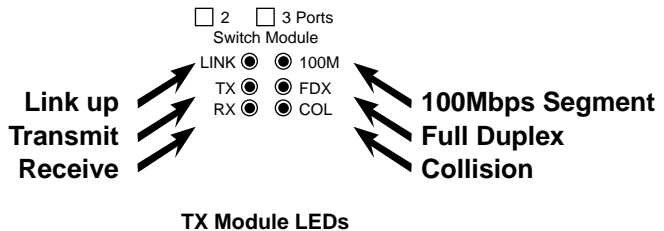

FX Module LED Indicators

The LEDs on each module indicate port activity. All LEDs are green.

- Link: On, indicates a link is up.
- TX: On, indicates a transmission in progress.
- RX: On, indicates receiving data.
- FDX: On, indicates the port is set to *full duplex*.
Off, indicates the port is set to *half duplex*.
- Collision: On, indicates collision occurring.

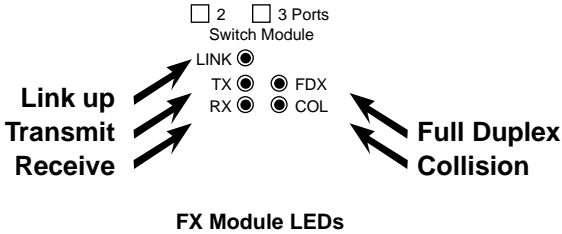

NOTE: Fiber Modules support 100Mbps only.

Module 8102-01-X

Module 8102-01-X is either an internal bridge for bridging the internal 10Mbps and 100Mbps segments or an external 10/100BASE-TX distance extender with MDI-X and MDI-II interfaces using an RJ-45 cable. Only one of these functions can be enabled at one time. The internal or external bridge must be enabled or disabled with on board jumpers before installation. Module flow-control (backpressure) can be enabled or disabled by setting the on board jumpers before installation. The default settings are as follows:

- Bridge Function setting: Internal (Default)
- Backpressure setting: Disabled (Default)

Module 8102-01-X Bridge Jumpers

The default jumper setting of the 8102-01-X module is internal bridge enabled. To disable the internal bridge and enable the external bridge, change the jumpers (JP1~JP16) from 1&2 to 2&3.

Jumpers JP1~JP16

- 1&2 connected = internal bridge is enabled (Default)
- 2&3 connected = external bridge is enabled

Module 8102-01-X Backpressure Jumpers

The default jumper setting for backpressure is disabled. To enable the backpressure function, change JP18 jumper to 2&3.

Jumper JP18

- 1&2 = disabled (Default)
- 2&3 = enabled

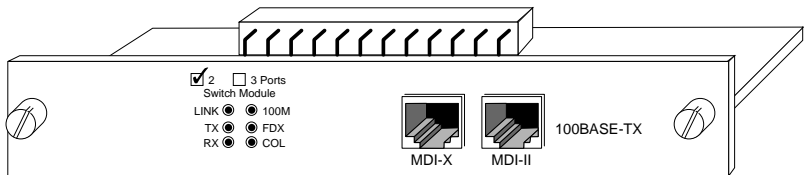

Jumpers: Module 8102-01-X

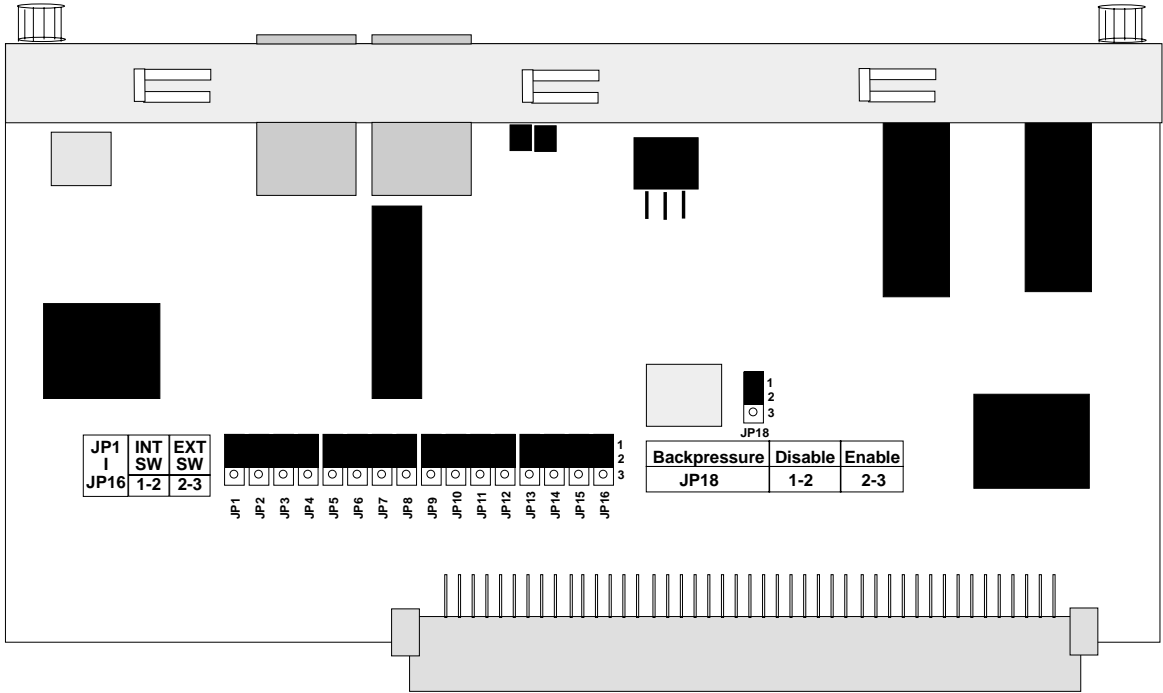

Module 8103-01-X

Module 8103-01-X is a 3-port bridge module with a two port internal bridge for bridging 10Mbps and 100Mbps segments and an external 10/100BASE-TX distance extender with MDI-X and MDI-II interfaces using an RJ-45 cable. Both of these functions can be enabled at one time, in fact, the distance extender is always enabled. The internal or external bridge must be enabled or disabled with on board jumpers before installation. Module flow-control (backpressure) can be enabled or disabled by setting the on board jumpers before installation. The default settings are as follows:

- Bridge Function setting: Internal and External enabled (Default)
- Backpressure setting: Disabled (Default)

Module 8103-01-X Bridge Jumpers

The default jumper setting of the internal bridge of Module 8103-01-X is enabled. The external distance extender is always enabled. To disable the internal bridge, change the jumpers (JP2, J4 ~ JP6) from 2&3 to 1&2.

Jumpers JP2, JP4 ~ JP6

- 1&2 connected = internal bridge is disabled
- 2&3 connected = internal bridge is enabled (Default)

Module 8103-01-X Backpressure Jumpers

The default jumper setting for backpressure is disabled. To enable the backpressure function, change JP1 and JP7 jumpers to 2&3.

Jumpers JP1, JP7

- 1&2 = disabled (Default)
- 2&3 = enabled

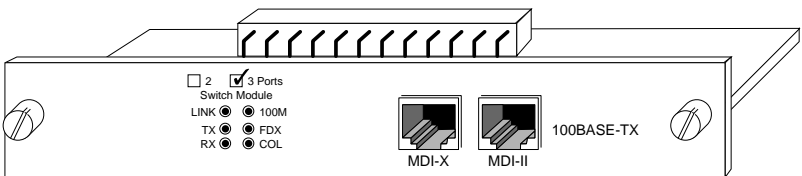

Jumpers: Module 8103-01-X

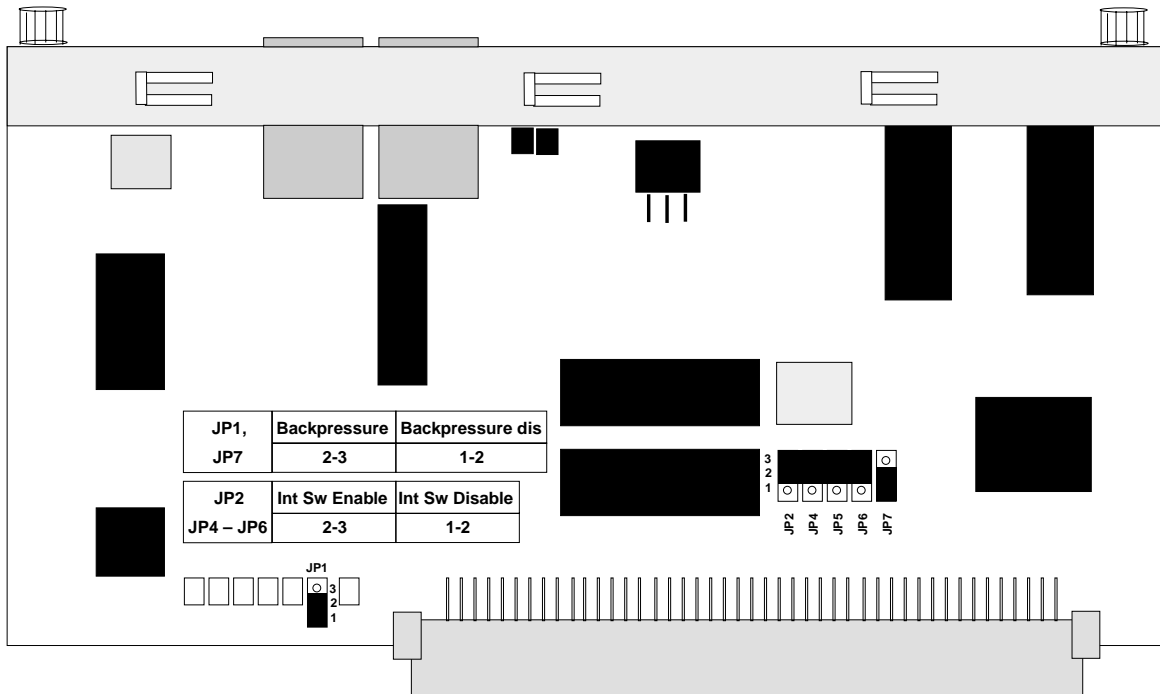

Module 8102-03-X

Module 8102-03-X provides a two port internal bridge for bridging 10Mbps and 100Mbps segments or 100BASE-FX distance extender with SC type connectors for fiber cable. The internal bridge must be enabled with on board jumpers before installation. The external distance extender is enabled by default. Module flow-control (backpressure) can be enabled or disabled by setting the on board jumpers before installation.

The default settings are as follows:

- Bridge Function setting: Internal disabled (Default)
- Backpressure setting: Disabled (Default)

Module 8102-03-X Bridge Jumpers

The default jumper setting of the Module 8102-03-X is internal bridge disabled. To enable the internal bridge and disable the external bridge change the jumpers (JP2~JP17) from 2&3 to 1&2.

Jumpers JP2~JP17

- 1 & 2 connected = internal bridge is enabled
- 2 & 3 connected = external bridge is enabled (Default)

8102-03-X Duplex Jumper

When the Module 8102-03-X internal bridge is enabled, the duplex jumper should be set to Half Duplex.

Jumper JP1

- 1 & 2 = half-duplex enabled
- 2 & 3 = full-duplex enabled

Module 8102-03-X Backpressure Jumpers

The default jumper setting for backpressure is disabled. To enable the backpressure function, change JP19 jumper to 2&3.

Jumper JP19

- 1 & 2 = disabled (Default)
- 2 & 3 = enabled

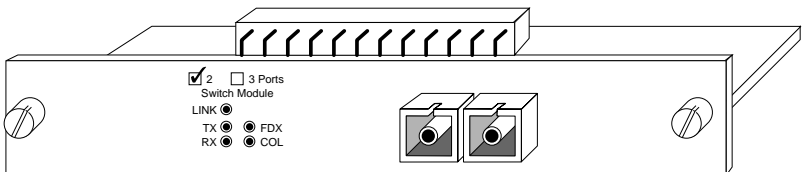

Jumpers: Module 8102-03-X

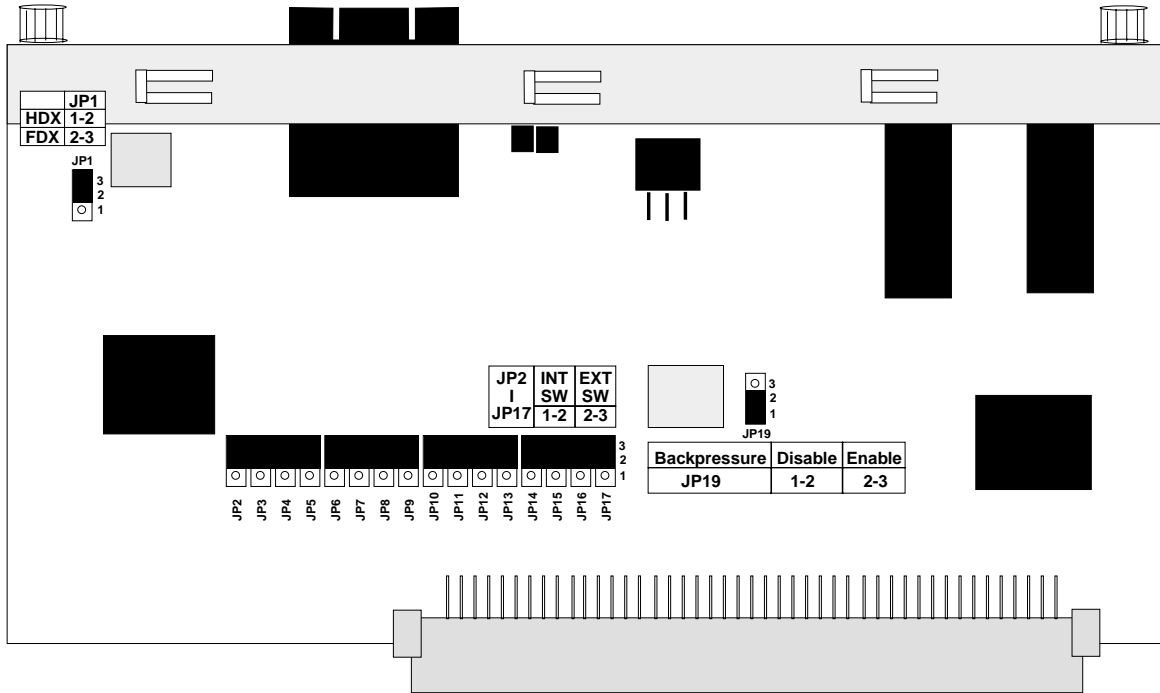

Module 8103-03-X

Module 8103-03-X provides a two port internal bridge for bridging 10Mbps and 100Mbps segments and 100BASE-FX distance extender with SC type connectors and fiber cable. The internal bridge must be enabled or disabled with on board jumpers before installation. The external distance extender is always enabled. Module flow-control (backpressure) can be enabled or disabled by setting the on board jumpers before installation. The default settings are as follows:

- Bridge Function setting: Internal enabled (Default)
- Backpressure setting: Disabled (Default)

Module 8103-03-X Bridge Jumpers

The default jumper setting of the Module 8103-03-X is internal bridge disabled. The external distance extender is always enabled. To enable the internal bridge, change the jumpers (JP3 & JP5~JP7) from 1&2 to 2&3.

Jumper JP1—Duplex Jumper (JP1)

- 1&2 = half duplex
- 2&3 = full duplex

Jumpers JP3 & JP5~JP7

- 1&2 connected = internal bridge is disabled (Default)
- 2&3 connected = internal bridge is enabled

Module 8103-03-X Backpressure Jumpers

The default jumper setting for backpressure is disabled. To enable the backpressure function for the external port and internal 100Mbps segment, change JP2 jumper to 2&3. To enable the backpressure function for the internal bridge change JP8 jumper to 2&3.

Jumpers JP2, JP8

- 1&2 = disabled (Default)
- 2&3 = enabled

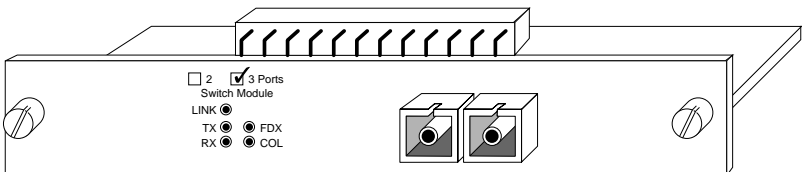

NOTE: JP2 is used to control the distance extender port and internal 100Mbps-segment backpressure function. JP8 is used to control internal bridge backpressure function.

Jumpers: Module 8103-03-X

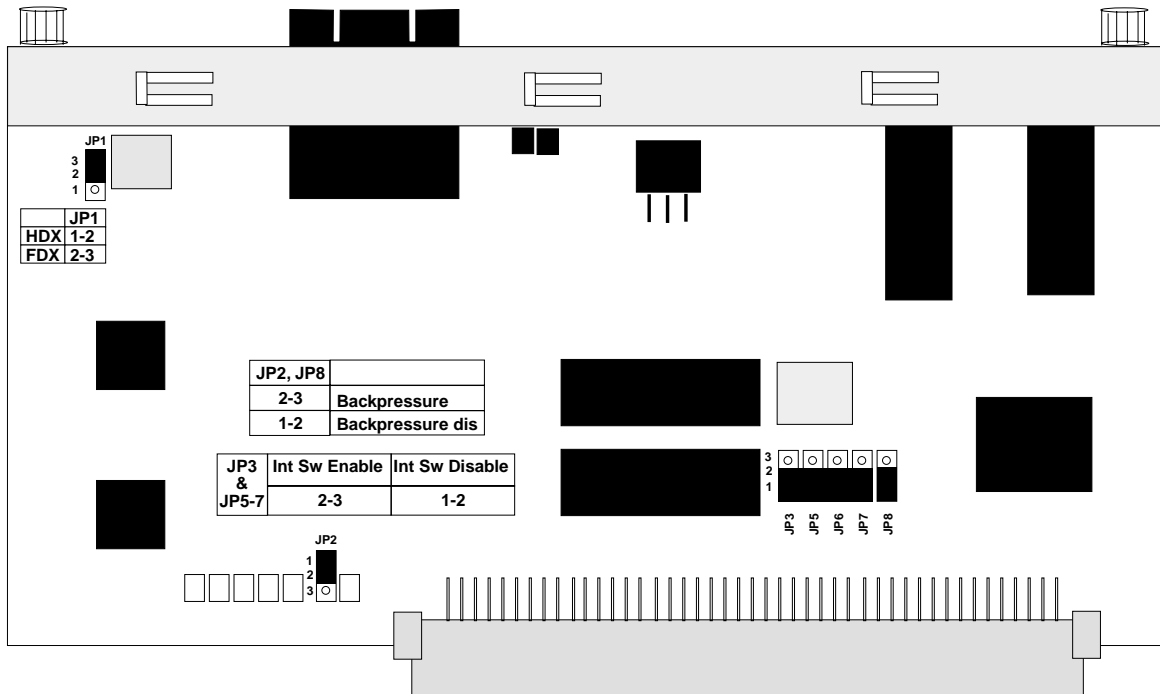

Chapter 3

Managing Through the Mini Console

Mini Console Overview

The Mini Console is a high definition display panel that provides brilliant text and graphics. It displays information about the system, port status or other information depending on the menu selected. Extensive configuration settings can be viewed and configured with the Mini Console. The Mini Console is only available for the CenturyStack master units.

Features

- High definition display panel (text and graphics)
- Message Zone
- Gauge Bars
- % Indicators
- Port Indicators
- Port Frame Indicators
- Console Keys
- Hub ID
- Group Indicators
- Symbols (Lock, Caution, WWW, SNMP & OOB)

Mini Console Display Panel

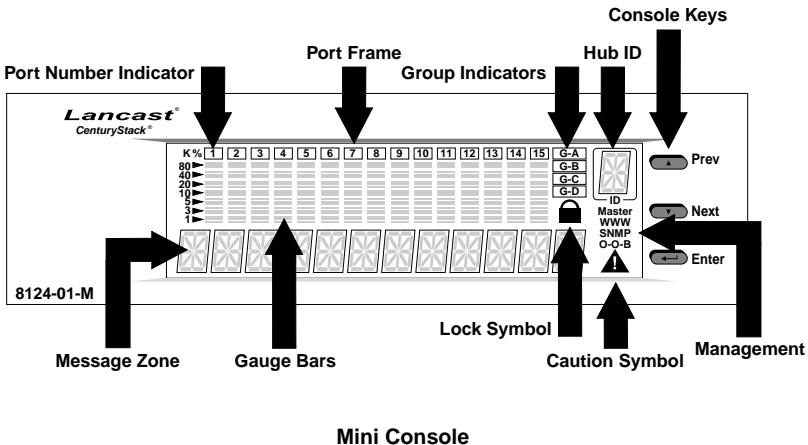

VFD Display

The Vacuum Florescent Display (VFD) shows the following port and system information:

%: The relative percentage of utilization or collision.

Port Number Indicators: Indicates the number of a port, and by brightness, indicates status information. *See the next table.*

Port Indicator Frame: Indicates which ports are disabled and partitioned.

Message Zone: The Message Zone displays the menu items of the menu tree, port information and system information including self-diagnostic tests and error messages.

Gauge Bars: Displays information such as utilization, port status, and serves as an indicator for groups or ports.

Lock Icon: Indicates that the control panel configuration is locked.

G-A: Port group indicator displays status of ports 1 to 12.

G-B: Ports 13 to 24.

Master: Indicates this hub is a master hub.

WWW: Indicates the Web-Based Management feature is enabled.

SNMP: Indicates the hub is SNMP manageable.

OOB: Indicates that out-of-band is enabled.

Observing Basic Port Information

The basic port information, such as link up, link down, receive activity, enabled and disabled, and auto partition can be easily viewed through the gauge bar, Message Zone and Port Indicators located in the first row of the Mini Console. The gauge bars below each linked port ascend and descend in relation to the amount of traffic through the ports.

Port Indicator Definition

The port number indicators define the port status and activity by the way they are illuminated, such as ON, OFF, flashing and with a frame around the numbers.

The following table summarizes the definition of the port indicators.

Port Indicator Definitions		
Port No. (Green)	Frame (Amber)	Indicates
Normal	OFF	Port is available but link is down.
Bright	OFF	Port is available and link is up.
Bright	ON	The Link is up and the administrator has disabled the port.
Normal	ON	The Link is down and the administrator has disabled the port.
Flashing	OFF	Link is up and receiving data.
Normal	BLINKING	The port is partitioned by the machine itself due to errors.

Console Keys

The Console Keys are used to cycle through the menu tree, to make selections and settings. The **Prev** Key and the **Next** Key cycle one position in the same level, and the **Enter** Key makes a selection. To move up the menu tree toward the root, select **BACK** or **MAIN MENU** in the menu tree structure.

BACK: Selecting **BACK** moves back up one level in the menu tree.

MAIN MENU: Selecting **MAIN MENU** moves directly to the main level in the menu tree.

The following summarizes the Console Key functions.

Prev: Cycles back through the current menu level.

Next: Cycles forward through the current menu level.

Enter: Selects the displayed menu item or when pressed and held changes a setting. Holding down the Enter key changes the default setting and places an “*” before the item indicating it is the current default.

Menu Tree

The menu tree consists of these seven main level menus:

- Utilization
- Group Select
- Statistics
- Port Status
- Port Configuration
- Unit Configuration
- System Information

The Main Menu items and their sub menus are outlined below.

UTILIZATION	Press “ENTER” to toggle port menus 1-12 or 13-24	
GROUP SELECT	GROUP 1~GROUP N	
STATISTICS	PORT 1~PORT N	READABLE FRM
		READABLE OCT
		FCS ERRORS
		ALIGN ERRORS
		FRM TOO LONG
		SHORT EVENTS
		RUNTS
		COLLISIONS
		LATE EVENTS
		VERY LONG EN
		RATE MISMTCH
		AUTO PART
TOTAL ERRORS		

PORT STATUS	ALL PORTS	10M PORTS
		100M PORTS
		LINK UP
		LINK DOWN
		POLAR NORMAL
		POLAR REVERS
		NO AUTO PARTS
		AUTO PART
		ENABLE
	DISABLE	
	PORT 1~PORT N	Press "ENTER" to show the status applied to the port
PORT CONFIG	SYS LOCKED	**** PSW
	ALL PORT	ENABLED
	PORT 1~PORT N	DISABLED
		AUTO-NEGO
		10BASE-T
	100BASE-X	
UNIT CONFIG	CONSOLE LOCK	LOCK
	NETWORK CONFIG	IP ADDRESS
		SUBNET MASK
		DEF GATEWAY
	SET PASSWORD	
	SYS RESTART	CONTINUE
		CANCEL
	SYS DEFAULT	CONTINUE
		CANCEL
	EIA232 CFG	BAUD RATE
4800		
9600		
19200		
BACK		
SYSTEM INFO	HW VER	HW version displays
	SW VER	SW version displays
	IP ADDRESS	IP Address displays
	SUBNET MASK	Subnet Mask displays
	DEFAULT GATEWAY	Default Gateway displays

Observing Network Traffic

You can observe the network traffic in the Mini Console with the Utilization menu. Seven columns of gauge bars, which shift continuously from left to right as time elapses, represent the utilization rate of each segment. The gauge bar columns on the left are for the 10Mbps segment and the gauge bars on the right are for the 100Mbps segment. Each column of gauge bars is a historical view of the total utilization in the 10Mbps segment and the total utilization in the 100Mbps segment at the time the statistics were taken by the hub. The total utilization history, represented by the seven columns in each segment is over a three-second time frame. "UTILIZATION" and "10M 100M" display in the Message Zone interchangeably at intervals of several seconds as shown below.

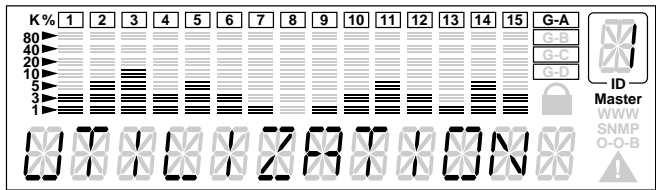

Utilization per Port

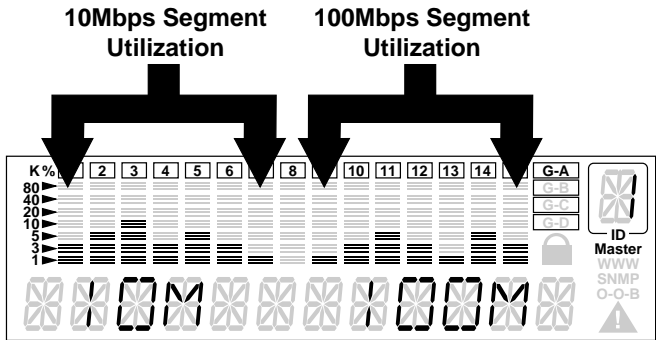

Utilization per Segment

Selecting a Group

You can select a group to monitor and configure when there are managed hubs cascaded to the master hub. “Group” refers to a hub in the stack, the range is 1~6 when the maximum number of hubs exist in the stack. You can manage each hub using the Mini Console. To select a group:

1. From the main menu press <Next> until “GROUP SELECT” displays in the Message Zone.
2. Press <Enter>. Several bars under the Port number indicate the current group, as shown below.

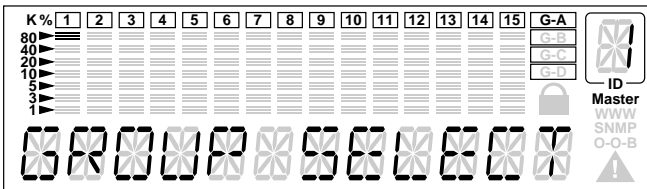

Group Select

3. Press <Next> until the group number you wish to monitor displays in the Message Zone as shown below.

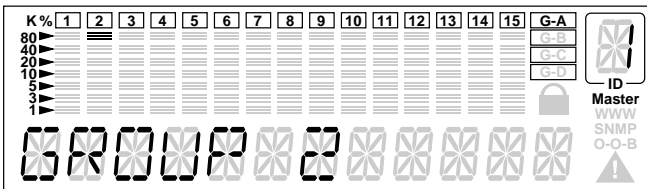

Group 2

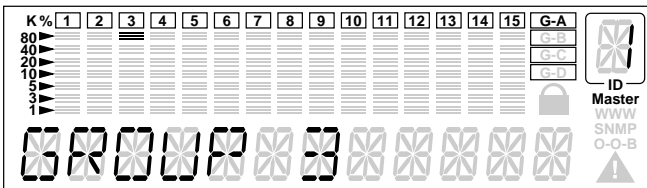

Group 3

Monitoring Port Statistics

You can monitor statistics of individual ports or all ports simultaneously using the Statistics Menu. The table, “Port Statistics Counters” lists the available counters that can be monitored.

Port Statistic Counters

Counter Type	Displayed
READABLE FRAMES	The total number of frames received on the hub port.
READABLE OCTETS	The total number of octets of data received on the hub port.
FCS ERRORS	The total number of packets received by the port that had bad Frame Check Sequence.
ALIGN ERRORS	The total number of packets received that have bad FCS with a non-integral number of octets.
FRM TOO LONG	The total number of packets received that were longer than 1518 octets (including FCS octets but excluding framing bits) and were otherwise well formed.
SHORT EVENTS	The total number of packets received that were less than 64 octets (including FCS octets but excluding framing bits) and were otherwise well formed.
RUNTS	The total number of packets received that were less than 64 octets due to collisions or activity duration was greater than the ShortEventMaxTime event and less than the ValidPacketMinTime event.
COLLISIONS	Total collisions.
LATE EVENTS	Total events received by the port where the activity duration is greater than the LateEventThreshold.
VERY LONG EVENTS	Total events received by the port where the activity duration is greater than the MAU Jabber Lockup Protection timer TW3.
RATE MISMATCH	Total frames received by the port with no collisions and the activity duration greater than the ValidPacketMinTime event and also frequency (data rate) is mismatched from the local frames mismatch frequency.

AUTO PART	Total number of times the port was auto-partitioned.
TOTAL ERRORS	Total errors received by the port including FCS errors, Align errors, Frame Too Long, Short Events, Late Events, Very Long Events and Rate Mismatch.

Selecting a Port to Monitor

1. Press <Next> until Statistics displays in the Message Zone.

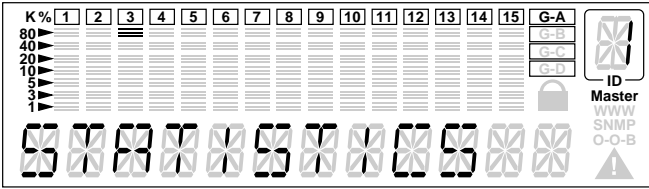

Statistics

2. Press Enter to go to the port selection menu and select a port for viewing. In the port selection menu, six units of the gauge bars, below the port number, indicate the current port. The current port number displays in the Message Zone, as shown below.

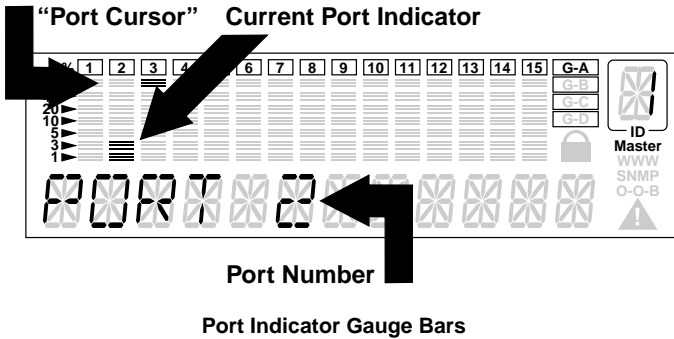

Port Number

Port Indicator Gauge Bars

- Press <Next> to move the “port cursor” to the desired port, the port number displays in the Message Zone, as shown below.

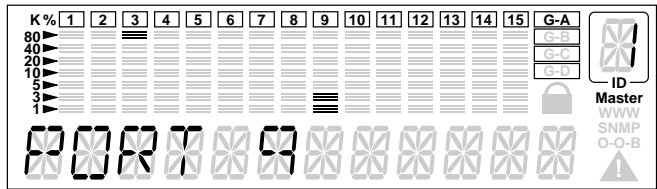

Scrolling to a Port

- Press <Enter> to confirm the selection of the port; and go to the counter type selection menu. The name of the port statistics counter “READABLE FRM” displays in the Message Zone as shown below.

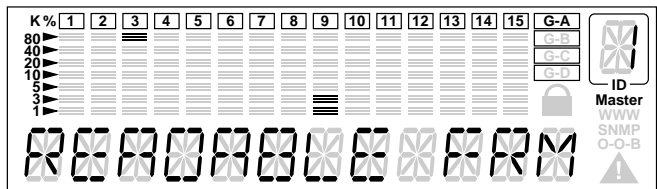

Readable Form

- Press Next to scroll through each type of counter.
- Press Enter to view the value of the current counter (currently displayed in the Message Zone), the value of the counter displays in the Message Zone.

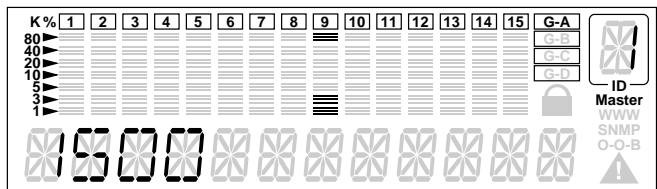

Statistic Counter Value

Monitoring Port Detail Information

You can monitor detailed port information for all ports at once or for individual ports using the Port Status menu.

Monitoring All Ports Status

To view all port status:

1. Press <Next> until “PORT STATUS” displays in the Message Zone. The current selected group is indicated by the group cursor under the port ID indicator, as shown below.

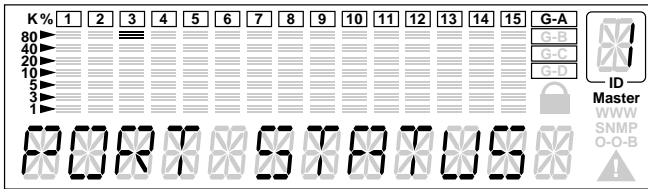

Port Status

2. Press <Enter>. “ALL PORTS” displays in the Message Zone. When monitoring all ports, the gauge bar columns are divided into 24, one for each port. The upper row of columns represents ports 13~24 and the lower row of columns represents ports 1~12.

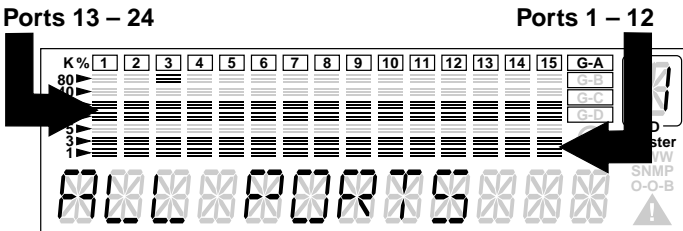

All Ports Status

- Press Enter to view all the ports' status at once. The figure below illustrates 10Mbps ports 1, 2, 3, 4, 7, 10, 13, 14, 15, 16, 19 & 22.

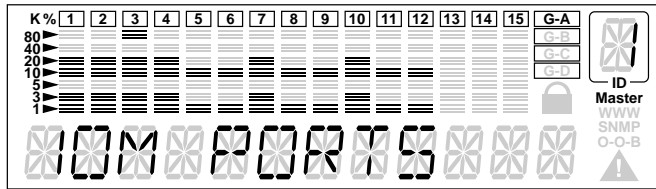

10Mbps Ports

- Press <Next> to view the status of other ports. 100Mbps ports status displays. In the figure below, ports 5, 6, 8, 9, 11, 12, 17, 18, 20, 21, 23, & 24 are indicated as 100M ports.

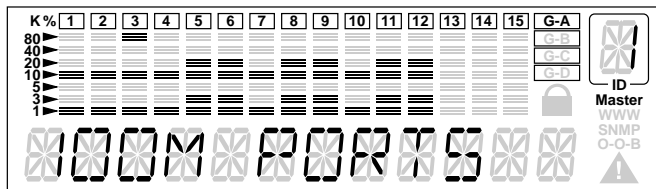

100Mbps Ports

- Press <Next> to view other port status information. The status information that is available is listed in the next table.

ALL PORTS Status Information

10M PORTS	Indicates all 10M ports.
100M PORTS	Indicates all 100M ports.
LINK UP	Indicates all Link up ports.
LINK DOWN	Indicates all Link down ports.
POLAR NORMAL	The receive (Rx) polarity of the port is normal.

POLAR REVERSE	The receiver (Rx) polarity has been automatically crossed by the hub.
NO AUTO PART	Indicates all ports not auto partitioned.
AUTO PART	Indicates all Auto Partitioned ports.
ENABLED	Indicates all Enabled ports.
DISABLED	Indicates all Disabled ports.

Monitoring Individual Port Status

To view the status of individual ports:

1. Press <Next> until “PORT STATUS” displays in the Message Zone.
2. Press <Enter> to go to the port selection menu. “ALL PORTS” displays in the Message Zone.
3. Press <Next> to select an individual port. “PORT 1” displays in the Message Zone. After a slight delay, the status of Port 1 is automatically cycled through, displaying the status of Port 1.

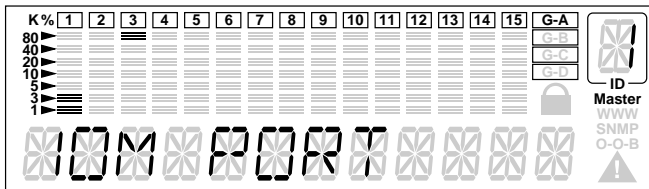

Port Status

4. Press <Next> to view port status of the next port. After a slight delay the status of the selected port is automatically cycled through, displaying the status of the selected port.
5. Press <Next> to view port status of other ports.

Configuring Ports

The PORT CONFIG menu enables you to configure individual ports or all ports at one time. You are prompted to enter the password when the console is locked. The ports must be configured to match the devices at the other end of the link. Settings such as speed must be identical. All ports are set to default to AUTO NEGO. When the AUTO NEGO mode is set, the highest speed supported by both ends is negotiated by the port and the device at the other end.

In the Port Setting menu, “PORT CONFIG” displays in the message zone and the currently selected hub is indicated by the “group cursor” under the port number indicator, as shown below.

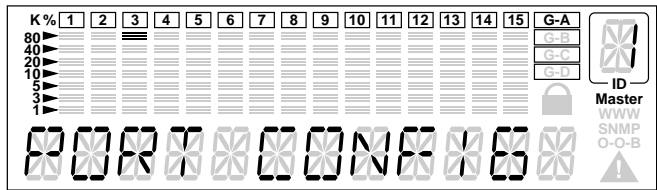

Port Configuration

Configuring *ALL PORTS*

1. With “PORT CONFIG” displayed in the Message Zone, press Enter to go to the port selection menu. “All PORTS” displays in the Message Zone.
2. Press <Enter>. The first of the configuration items for all 24 ports is indicated in the Message Zone. Press <Next> to scroll through all the configuration options. The figure illustrates the ports that are set to Auto Negotiate enable, indicated by the columns that have 6 gauge bars, specifically ports 5, 6, 8, 12, 17, 18, 20, 24. Columns that have only 3 gauge bars indicate the ports that are not set to the configuration displayed in the Message Zone. To change the configuration, scroll to the desired setting and press and hold the ENTER key. The new setting displays 6 gauge bars for all ports.

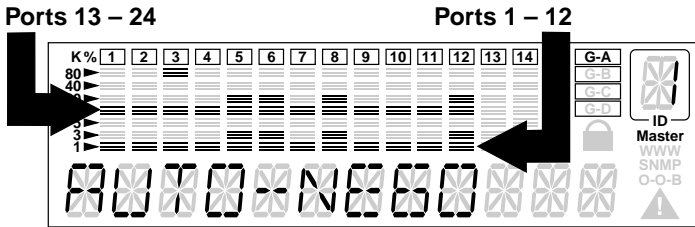

Auto Negotiate Ports

3. Press <Next> to scroll through each configuration item.
4. Press Enter to apply the configuration displayed in the Message Zone to all the ports.

Configuring a single port

1. With "PORT CONFIG" displayed in the Message Zone, press <Enter> to go to the port selection menu.
2. Press <Next> to select an individual port.
3. Press <Enter>. The configuration of the selected port displays in the Message Zone. Six gauge bars below the port number indicate the current port. 3 gauge bars (group cursor) directly under the port number indicate the current group.

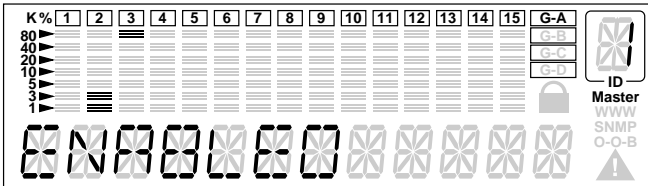

Current Configuration

4. Press <Next> to scroll through each configuration item.
5. Press <Enter> to apply the currently displayed configuration to the port.

The applied configuration is indicated by an asterisk sign displayed before the name of the configuration in the Message Zone as shown below, otherwise, the asterisk sign does not appear.

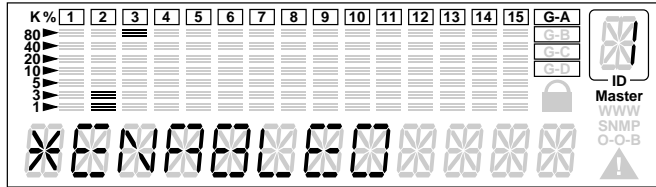

Current Port Configuration (single port)

The table lists typical default settings and the possible optional settings for a port. An “*” appears before each current setting. To change a setting, press and hold down Enter until an “*” appears before the desired setting, the “*” is removed from the previous setting.

Port Setting	
Default	Optional Settings
*AUTO-NEGO	10BASE-T/100BASE-X
*ENABLE	Disable

Unit Configuration

You can configure the hub using the Unit Configuration Menu. For security reasons you are prompted for the password when the device is locked. Without the password users cannot enter the Unit Configuration menu in order to change any unit configurations. When the device is unlocked, no password verification is required to change the unit configurations. The password entry is described in “Set Password.”

Configuring the Unit

1. Select UNIT CONFIGURATION from the Main Menu.

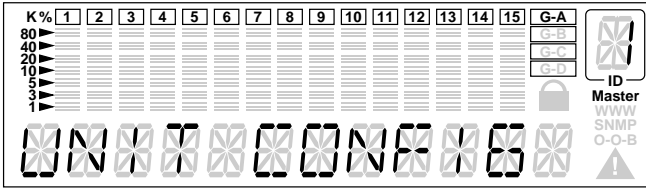

Unit Config Main Menu

2. Press <Enter> to go to the UNIT CONFIGURATION menu.
3. Press <Next> to scroll through each configuration option.
4. Press <Enter> to go to the next level of the configuration menu.

The following lists Unit Configuration options:

Unit Configuration Options	
Console Lock	Lock
Network Config	IP Address, Subnet Mask and Default Gateway
Set Password	Set new password
System Restart	Restart hub
System Default	Reset hub to factory configuration
EIA232 Config	Baud Rate

Locking the Mini Console

In the console lock configuration menu, the text string “LOCK” displays in the Message Zone. If the device is currently locked, a lock symbol also displays on the right side of the Mini Console.

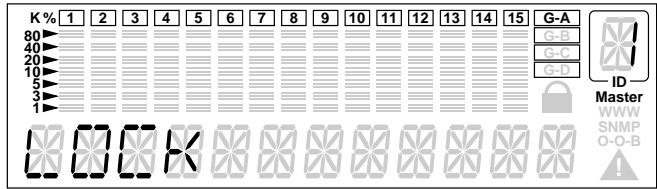

Unlocked State

1. Select UNIT CONFIGURATION from the Main Menu.
2. Press <Enter> to go to the UNIT CONFIGURATION menu.
3. Console Lock displays in the Message Zone.
4. Press <Next> to toggle to lock.
5. Press <Enter> to set the configuration, a lock sign appears in the display.

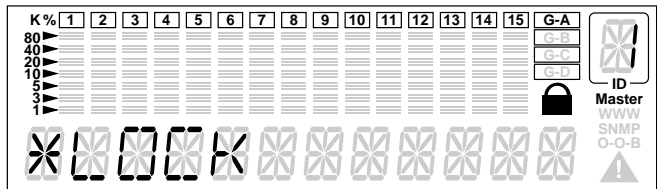

Locked State

Unlocking the Mini Console

Once unlocked, a password is not required to make configuration settings with the Mini Console. The console will return to the Lock State after 15 minutes of no key activity. The default password is "0000". To unlock the Mini Console:

1. Select UNIT CONFIGURATION from the Main Menu.
2. Press <Enter> to go to the UNIT CONFIGURATION menu.

3. You are prompted to enter the password.
4. Enter the password. The console is unlocked.

Network Configuration

The Network Configuration menu allows setting the hub's IP Address, Subnet Mask and Default Gateway. The hub's Network Configurations must be set to compatible settings with LAN configurations to make connections to the hub.

Network Configuration	
Configuration	Default
IP ADDRESS	000.000.000.000
SUBNET MASK	000.000.000.000
DEFAULT GATEWAY	000.000.000.000

IP Address Configuration

1. Select "UNIT CONFIG" and press <Enter>.
2. Press <Next> until "NETWORK CONFIG" displays in the Message Zone.
3. Press <Enter>. IP ADDRESS displays in the message zone.
4. Press <Enter>. The current IP address displays in the IP address configuration menu. The first digit is blinking.

NOTE: The IP address is too long to be fully displayed and it moves to the left as digits are entered.

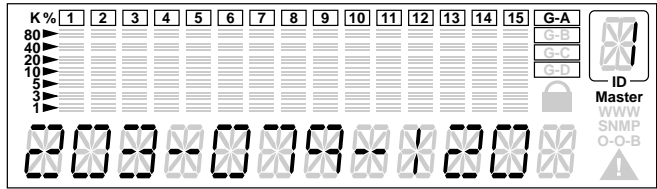

IP Address

5. Press <Prev> to increase the digit (“0” ~ “9”).

NOTE: Use “0” for a blank space, for example: entering “000” equals “0” or entering “022” equals “22”.

6. Press Enter to set the digit and move the cursor to the next digit. The current digit is blinking.
7. Repeat steps 1 & 2 until the entire IP address is entered.
8. Press <Enter> to confirm.

Since the Message Zone can not contain the whole IP address, the digits will shift to the left to make room for the last digits. When setting the IP address is complete, the system will validate the IP address. If the IP address is valid, the display will show the IP address, and the system will apply the setting. Otherwise, the system will reject it, and a message “INVALID IP” displays for a few seconds, and the invalid IP address displays again to allow modification to it.

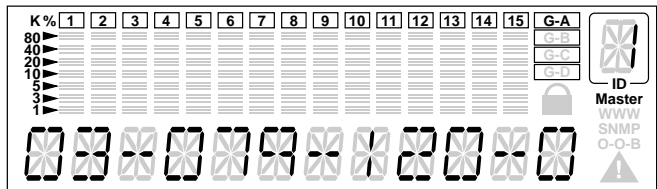

IP Address shift left

Subnet Mask

Select the SUBNET MASK option and follow the same procedure for setting an IP Address.

Default Gateway

Select the DEFAULT GATEWAY option and follow the same procedure for setting an IP Address.

Out-of-Band Configuration

You can set the Out-of-Band configuration with the EIA232 Config Menu, which allows setting the baud rate for the EIA232 port. Possible baud rates are 2400, 4800, 9600, or 19200.

1. Scroll to UNIT CONFIG and press Enter.
2. Scroll to EIA 232 CONFIG and press <Enter>.
3. Scroll to BAUD RATE and press <Enter>.
4. Press <Next> until the baud rate that you want to set displays in the message zone.
5. Press <Enter> to set the new baud rate. An “*” appears before the set baud rate.
6. Press <Next> until BACK displays in the message zone.
7. Press Enter to move back up the menu tree one level.

Securing the Hub

The hub can be secured with the use of a password and the console lock. When it is locked, no configuration settings can be made, a lock icon displays in the Mini Console panel and it can only be unlocked by entering the correct password. The default password is “0000”.

Setting the Password

The current password displays in the password setting menu. The pass-

word displays as four asterisks. The current digit blinks, indicating it can be configured.

1. Scroll to UNIT CONFIG and press <Enter>. You are prompted to enter the password, **** PSW appears in the message zone and the first “*” flashes. Press <Next> to increase the digit.
2. Unlock the control panel by entering the default password 0000, one digit at a time by pressing <Next> once and <Enter> once to progress to the next digit.
3. Repeat Step 2 three times. The control panel is unlocked.
4. Scroll to SET PASSWORD and press <Enter>.
5. Enter a new password and press Enter to exit the password configuration, SET PASSWORD displays in the message zone.
6. Press <Next> until MAIN MENU displays in the message zone and <Enter> to exit to the main menu.

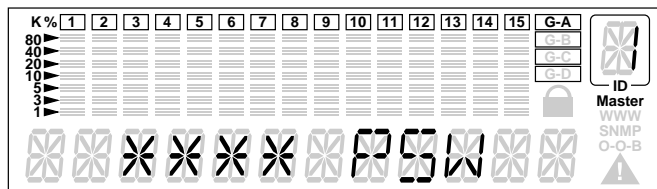

Password

Cancelling the Password

The password can be cancelled only by entering a new password or by setting each digit to “*”.

In Case You Forget Your Password

If you forget your password, use the Console Management program to read the password setting. See *Chapter 4: “Connecting the Console Interface”* and *“User Authentication”* for more information.

Restarting the Hub

The hub will use your configurations to set up the system when it restarts. Restart the system with the Restart Menu using the following steps:

1. Scroll to UNIT CONFIG and press <Enter>.
2. Scroll to SYS RESTART and press <Enter>.
3. Press <Enter> at “CONTINUE” or press <Next> to abort the action at the menu option “CANCEL”.
4. Press <Enter> to confirm.

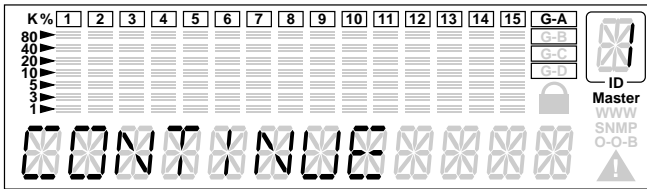

System Restart-Continue

Restoring System Default Setup

The factory default configurations are selected from the SYS DEFAULT menu, a sub menu of the Main Menu item “UNIT CONFIG”. The factory defaults are the settings that were set at the factory before shipping the hub. Restore the default settings with the following steps:

1. Press Enter at the “SYS DEFAULT” menu option. “CONTINUE” displays in the Message Zone.
2. Press <Enter> to restore factory defaults or press <Next> to scroll to CANCEL and press Enter to cancel the operation.

CAUTION: Restoring the system default settings overwrites all custom settings, including password, port configurations, and unit configurations.

System Information Menu

The System Information menu displays information about the device version, the device software version, and the network configuration settings (IP Address, Subnet Mask and Default Gateway).

System Information

The following system information is cycled through in the Mini Console:

System Information	
HW VER	Hardware Version
SW VER	Software Version
IP ADDRESS	IP Address
SUBNET MASK	Subnet Mask
DEF GATEWAY	Default Gateway

Chapter 4

Master Hub Configuration and Console Management

This Chapter is only for CenturyStack Master Hub configuration and management. When installing CenturyStack the first time, it is necessary to configure the hub through the Console Interface.

Connecting to the Console Interface

You can set up a management session by connecting a direct RS-232 cable between the management port on the CenturyStack and the communication port of your PC or terminal.

To connect a local terminal to the CenturyStack, do the following:

1. Install a terminal emulation application such as Windows Hyperterminal on your PC.
2. Configure the terminal emulation application as follows:
Baud rate 9600
Parity None
Data bits 8
Stop bits 1
Flow Control ... None
VT-100 Configuration
3. If you are using Microsoft Windows terminal emulation, disable the “Use Function, Arrow, and Ctrl Keys for Windows” option in the Terminal Preferences menu under Settings.
4. Connect the console management port on the CenturyStack to your PC or DTE device using a serial cable. The CenturyStack has a 9-pin, female connector.

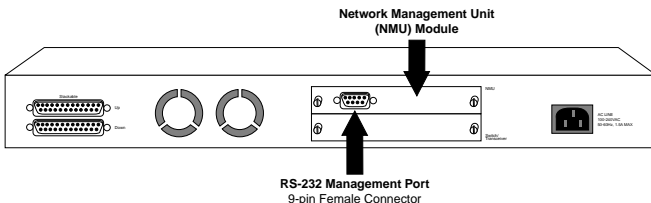

Connecting the Console Interface

- Press <ENTER> 2 or 3 times and the login panel to the management interface and login menu appears as shown below. See Menu Convention in the next section to understand the menu fields and commands of the console management interface.

Menu Convention

This section describes the types of fields and commands of console management menus and their usage.

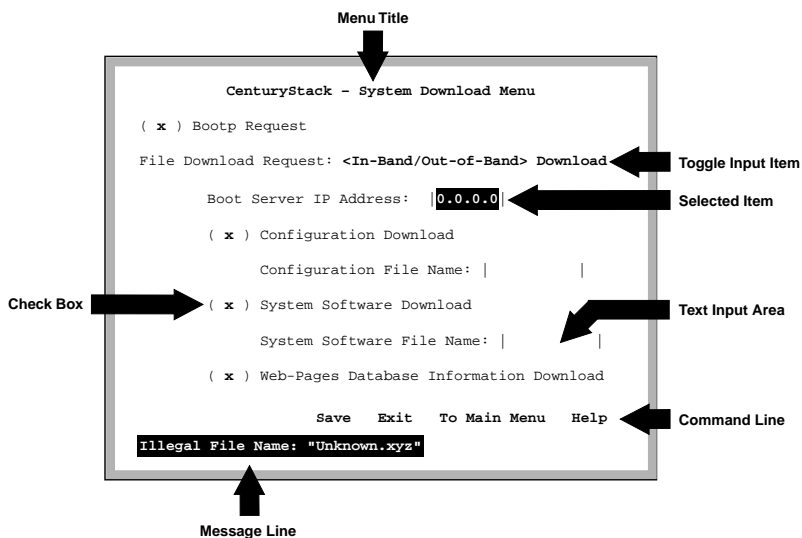

Menu Conventions

You can move the cursor between items in menus using the Tab key or arrow keys. Console Management Menu conventions are listed below:

Menu Title: The menu title briefly describes the purpose of the menu.

Check Box: Use to set a configuration item that is enclosed in parentheses “()”. You can toggle this field to checked or not checked. Checked items are enabled and the procedure associated with this field will be performed.

Toggle Input Item: Use the space bar to toggle between options that are enclosed in angle brackets “< >”.

Text Input Item: Text fields appear between square brackets “[]”, and the text of the selected item can be edited or entered from the keyboard.

Item Selected: Items that are selected are highlighted. Use the Tab key to select a different item.

Command Line: Available commands for a given menu, once highlighted, are executed with the Enter key.

Message Line: Displays messages prompting you to confirm an action or advise that an action cannot be performed.

Using the Console Program

Ensure that the VT-100 compatible terminal parameters are set. Start the VT-100 compatible terminal and connect power to the hub. If the hub is already powered, press <Enter>, one or more times to bring up the login menu. The login menu appears similar to the illustration below.

Logging In

When logging in for the first time, enter the User Name “LANCAST,” password and press <Enter>. User Names and Passwords are not case sensitive.

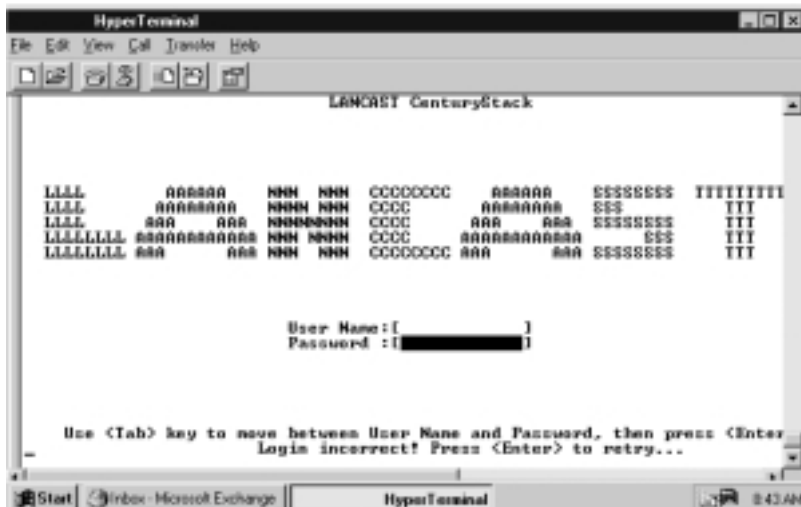

Login Menu

For security reasons, you can change the login User Name and Password. For more information about setting user names and passwords, see “User Authentication”.

Main Menu

The management functions of CenturyStack are available from the Main Menu. A management function is selected by pressing <Tab> or Up/Down Arrow keys to highlight the function of interest and pressing Enter. The Main Menu appears with the first item highlighted as below.



Main Menu

The Main Menu has six major selectable items: System Information, Management Setup, Device Control, Network Management, User Authentication, and System Utility.

System Information: Allows you to view general system information as well as specifying location and contact information.

Management Setup: Allows you to view and specify management configurations.

Device Control: Allows you to monitor and configure hubs.

Network Monitor: Allows you to monitor statistic counters.

User Authentication: Allows you to configure user names and passwords.

System Utility: Allows you to configure software downloads, restart options, and Telnet session timeout intervals.

Monitoring System Information

The System Information Menu displays information about the system. You can view the system software and hardware information and configure the system configurations as shown below.

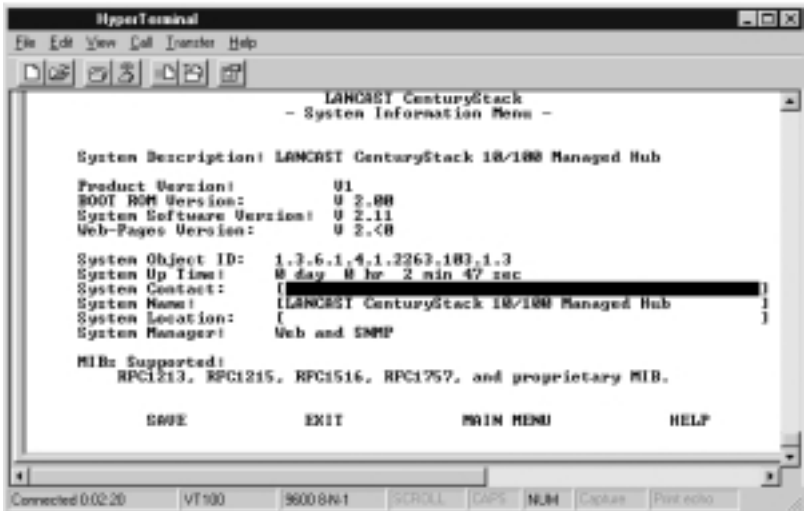

System Information

You can specify up to 48 alphanumeric characters each for the System Name, Contact, and Location to provide useful information to all users concerning the Hubs. The information on this panel should be kept current so that persons requiring assistance know who to contact.

NOTE: You must select <Save> to save any changes you have made.

System Description: A textual description of the entity. This also includes the name and version identification of the system's hardware type, software operating system, and networking software.

System Object ID: This ID is the vendor's authoritative identification of the network management subsystem contained in the entity. This value is allocated within the SMI enterprises' subtree (1.3.6.1.4.1) and provides an easy and unambiguous means for determining what kind of device is being managed.

System Up Time: The time since the network management portion of the system was last restarted or powered on.

System Contact: You can enter a name or other description of who to contact in case of network problems. You can enter a character string up to 48 bytes.

System Name: You can enter a name or other description of the hub or stack. You can enter a character string up to 48 bytes.

System Location: You can enter a name or other description of the physical location of the hub, for example the building or address, the city, etc. You can enter a character string up to 48 bytes.

Setting up for Management

The Management Setup Menu is used to configure CenturyStack for the available management functions.



Management Setup Menu

Network Configuration: Allows you to configure the IP Address, Subnet Mask, Default Gateway, and SLIP Address.

Serial Port Configuration: Allows you to configure the serial port connections.

SNMP Community Setup: Configure community names and access rights.

Trap Receiver: Set up community trap addresses.

Management Capability Setup: Enable or Disable Web access and Out-Of-Band Management.

Trap Filter: Enable or disable trap filters.

Network Configuration

There are several ways or Network Interfaces that you can use to configure the hub. You must set up the hub using Local Console management to enable the other management capabilities:

- Mini Console (see Chapter 3)
- Local Console/Remote Telnet
- Web-Based Management
- SNMP Management

The Network Configuration Menu allows setting up Ethernet and SLIP connections to the hub. Network Interface <1> is used to configure Ethernet connections and Network Interface <2> is used to configure SLIP connections.

Local Console/Remote Telnet-Ethernet

An Ethernet connection allows you to monitor and configure the hub with a Local Console via Telnet Session, a Web browser or SNMP management. You need to configure the IP Address and Subnet Mask to work with your LAN settings before you can make an Ethernet connection.



In-Band Ethernet Configuration Menu

Interface: The current interface number; 1=Ethernet, 2=SLIP

Interface T ype: The interface type — Ethernet or SLIP

MAC Address: Displays the hub's MAC Address, for example: 00-E0-95-00-00-05.

IPAddress: The dotted decimal address assigned to the CenturyStack.

Subnet Mask: The dotted decimal subnet mask assigned to the CenturyStack.

Default Gateway: The dotted decimal IP address of the default gateway assigned to CenturyStack. CenturyStack must be restarted before the IP address, subnet mask, and default gateway can take effect. To ensure that the new information is correct, a "ping" should be done from another device connected to the CenturyStack.

NOTE: The hub does not respond to ping packages that are greater than 1484 bytes.

Local Console/Remote Telnet-SLIP

SLIP connections enable monitoring and configuring the CenturyStack remotely with a modem. To make SLIP connections use Network Interface <2> and set the configurations shown below.

NOTE: The SNMP agent, TCP/IP stack and the Web engine are implemented on the 10Mbps bus of the master hub. Therefore the 10Mbps segment must be used for Web-Based Management in the absence of a switch module.



Out-of-Band Serial Configuration Menu

The baud rate, character size, parity, and stop bits are read only and not configurable.

Baud Rate: The current serial port baud rate that can be configured from the Serial Port Configuration Menu.

Character Size: 8 bits character size

Parity: None

Stop Bits: 1 stop bit

IP Address: The dotted decimal address assigned to the SLIP interface of CenturyStack

Subnet Mask: The dotted decimal mask assigned to the SLIP interface of CenturyStack.

Serial Port Configuration

The Serial Port Configuration Menu is used to configure Console Mode connections to a VT-100 terminal emulator and Out-of-Band serial connections to a modem.

Console Mode

To view the Console Mode settings, select “Console” Mode in the Serial Port Configurations. Console Mode settings are read only. Use the settings as shown below.



Console Operation Mode

Out-of-Band Mode

Out-of-Band mode enables setting up serial port configurations for making a connection to the hub using a modem.

To make Out-of-Band serial connections use the Out-of-Band operation mode in the Serial Port Configurations Menu shown on the next page.



Out-of-Band Operation Mode

Baud Rate: The baud rate can be configured as one from 2400bps, 4800bps, 9600bps, 19200bps. The default is 9600.

Character Size: 8 bits character size

Parity: No parity.

Stop Bits: 1 stop bit

Select <Save> to retain the new configuration. The new configuration takes effect if Out-of-Band management is enabled.

When SLIP is enabled, the EIA 232 port can be used for SLIP only. The EIA 232 port cannot be used to gain access to a management session via VT100 terminal emulation. If the SLIP connection is malfunctioning, you can disable SLIP by rebooting and pressing <Enter> when the Abort message appears. The message will appear for only 10 seconds. OOB also appears on the lower right side of the Mini Console. You can also establish a Telenet session and modify the serial port configuration.

SNMP Community Setup

The SNMP Community Setup Menu is used to set up SNMP communities. Up to six Community Names, Access Rights, and Status can be configured.

You can add, delete, or edit SNMP community names, set the access rights and status. Community names are case sensitive, Private and private are considered different. You cannot enter the same name more than once; an error message appears at the bottom of the panel. Press the <Esc> key to continue.

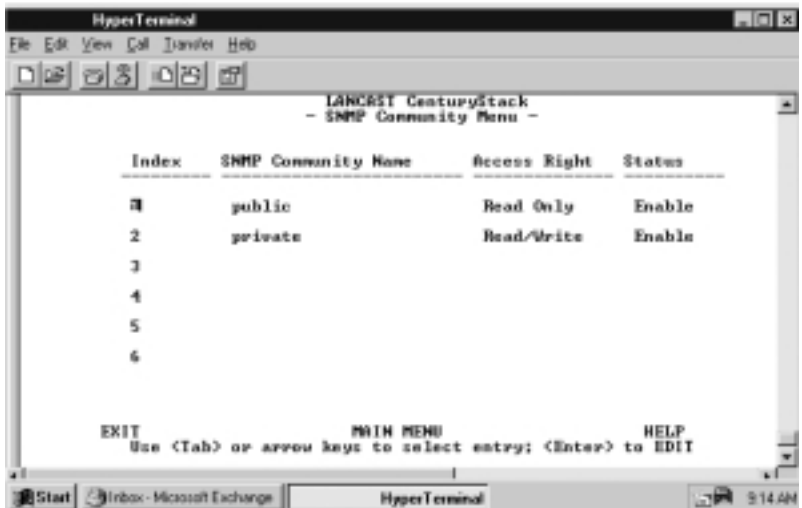

SNMP Community Setup

Community Name: Text string up to 16 characters.

Access Right

- **Read Only:** The SNMP manager can only view the status of the hub.
- **Read/W rite:** The SNMP manager can view and configure the hub.

Status: The SNMP Community is enabled or disabled.

To add a community name:

1. Highlight an index number and press <Enter>. An editable panel is presented, “SNMP Community Menu -2”.
2. Enter a name in the Input field.
3. Set the access right and status.
4. Highlight ADD, and press <Enter>, the new name is entered and displayed.

To edit a community name:

1. Enter an existing name in the Input field and press <Enter>.
2. Change the access right and status.
3. Highlight Delete and press <Enter> to delete an existing name.
4. Highlight Update and press <Enter>.

Trap Receiver Setup

Traps are messages sent across the network to an SNMP Network Manager. These messages alert the network manager for network management purposes. You can set up six trap receivers.

You can configure the following:

Community Name: The authorized SNMP community string of the remote network manager. (maximum 16 characters)

IPAddress: The IP Address of the remote network manager station to which traps should be sent.

Status: A community name can be active or inactive. Community names that are set to active receive traps.

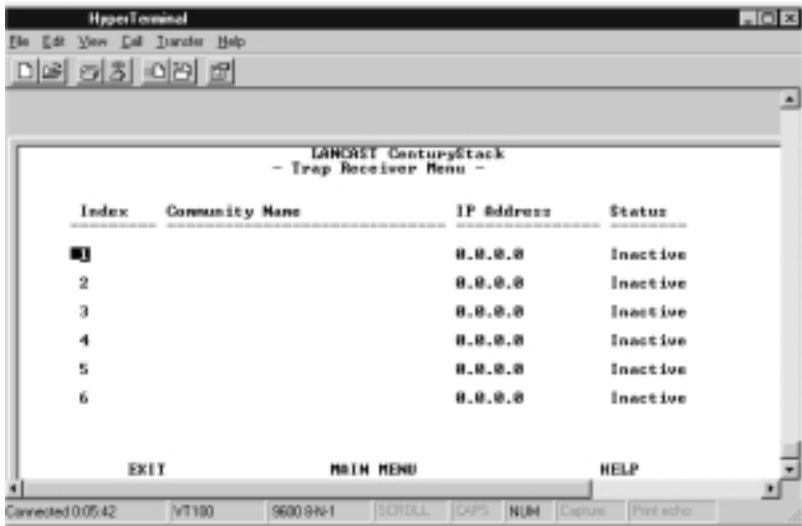

Index	Community Name	IP Address	Status
1		0.0.0.0	Inactive
2		0.0.0.0	Inactive
3		0.0.0.0	Inactive
4		0.0.0.0	Inactive
5		0.0.0.0	Inactive
6		0.0.0.0	Inactive

EXIT MAIN MENU HELP

Trap Receiver Setup

To set up a trap receiver community name:

1. Select a Trap Community Name and press <Enter> to open the configuration menu for the selected index as shown below.

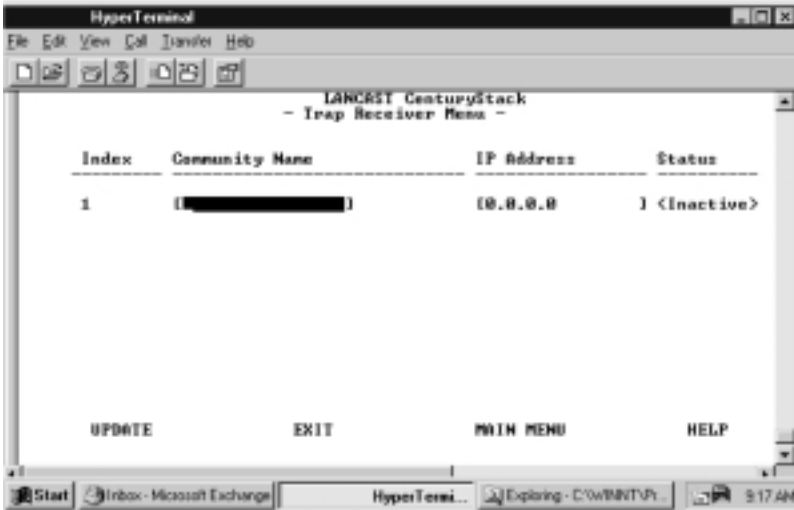

Configuring a Community Name

The Community Name can be edited, the IP Address can be configured, and the Status can be set to Active or Inactive. Communities that are set to Inactive do not receive traps, until their status is reset to Active. Select Update and press <Enter> to save changes.

Web-Based Management Configuration

The Management Capability Setup Menu allows enabling or disabling Web-Based Management and Out-of-Band Management. Use the space bar to toggle between settings. Select Save and press <Enter> to save the setting.

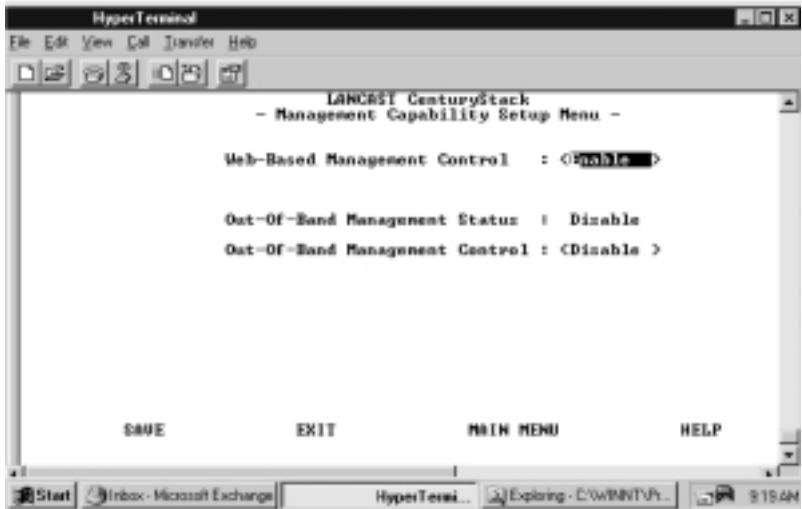

Management Capability Setup Menu

This menu lets you enable or disable Web-Based Management and Out-of-Band Management.

Web-Based Management: You can enable or disable Web-Based management. The new configuration takes effect after executing SAVE.

Out-of-Band Management Status: Displays the current status.

Out-of-Band Management Control

You can enable or disable Out-of-Band management.

- When connecting with local console, this setting takes effect immediately.
- When connecting with Telnet, the system must be restarted before the setting takes effect.

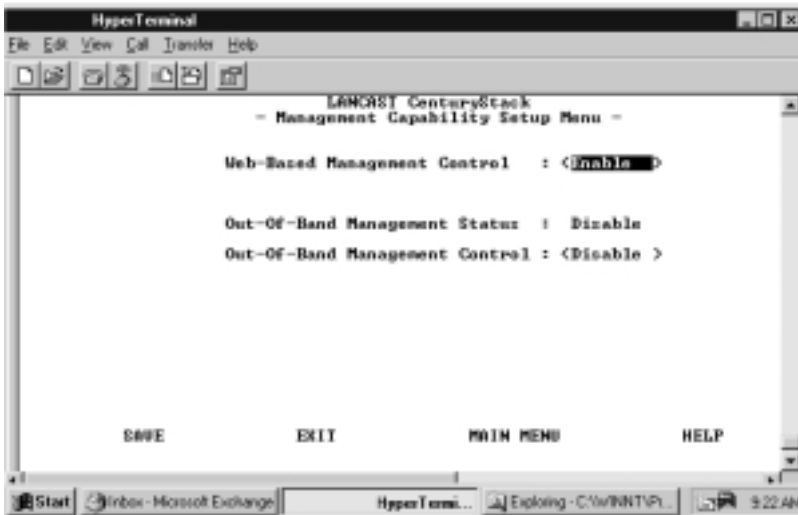

Web-Based Management Configuration

Trap Filter

Selecting this option presents the Trap Filter Menu as shown below.

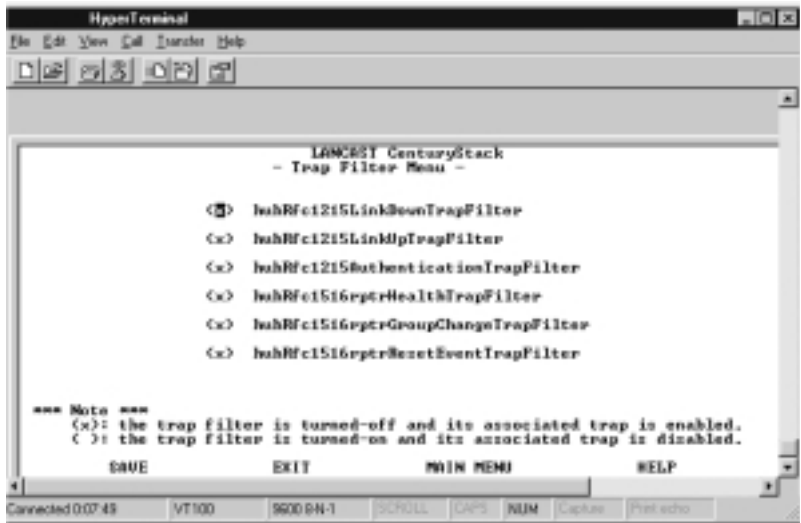

Trap Filter Menu

This menu lets you enable or disable trap filters for those traps defined by RFC1215 and RFC1516. Marking a trap filter disables the trap and no traps are sent for the specified trap. The default is all traps enabled.

Controlling Devices

The Device Control Menu displays the configurable device sub menus.



Device Control Menu

Repeater Group Control/Status : Allows you to read and configure all the hubs in a stack.

Repeater Port Control/Status: Allows you to read and configure ports on any hub in a stack.

2/3-Port Bridge Module Control/Status: Allows you to set up any Bridge (Switch) Modules such as Module 8102-01-X, Module 8102-03-X, Module 8103-01-X, and Module 8103-03-X in a stack.

Redundant Link Control: Allows you to set up as many as 24 redundant link pairs.

Security Intrusion: Allows you to set up Security.

Repeater Group Control/Status

The Repeater Group Control/Status displays status information for groups and allows enabling or disabling a group as well as naming and resetting the group.



Repeater Group Control/Status

Group Number: The ID number of a hub in the stack; the range is 1~6.

Group Status

Port Capacity: The maximum number of ports that can be contained within the group (12/24).

Repeater Type: The repeater type of the group. (10/100 Mbps Class II)

Group Role: Describes the Hub's role as either master or slave.

HW Revision: The hardware version of the CenturyStack Hubs.

Group Serial Number: The serial number of the hub, for example, 21564.

Group Last Changed: The value of system uptime since any of the following conditions occurred:

- hub cold or warm-started
- this instance of group was created (such as, when a device or module was added to the system)
- a change in the value of hub operational status
- ports were added or removed as members of the group (such as, group admin. enabled or disabled)
- any of the counters associated with this hub that have been reset.

Group Partitioned Ports: The total number of partitioned ports in the group.

Group Operational Status

- **Operational:** The hub is connected to the stack.
- **Not Present:** The hub is not present.

Group Control

Lists the configurable functions and provides option fields. Use Ctrl + S to toggle between options.

Group Admin State: Allows you to isolate one or both segments from the other hubs in a CenturyStack. When a segment is disabled, the segment cannot repeat to the other hubs in the stack. The default value is Enabled 10Mbps and 100Mbps.

- **Enable 10-100 (Default):** Both 10Mbps and 100Mbps segments of a given hub are connected to the backplane of the stack. This is the default.
- **Disable 10-100:** Both 10Mbps and 100Mbps segments of the hub are isolated from the stack.
- **Enable 10:** Only the 10Mbps segment of a given group is connected to the backplane of the stack. The 100 Mbps segment of a given group is isolated from the stack.
- **Enable 100:** Only the 100Mbps segment of a given group is connected to the backplane of the stack. The 10Mbps segment of a given group is isolated from the stack.

Group Reset

All, some or none of the group's function can be changed by selecting one of these options:

NOTE: The selected option takes effect after SAVE is executed.

- **No Reset:** None of these are reset.
- **Reset All:** The function logic and counters of the group will be reset. This is identical to cold restart.
- **Reset Function Logic Only:** The function logic of the group will be reset. The counters will be held static and will not be reset. This reset operation will reset the link status of each port to 'Link Down'. That will cause a Link Status Change event to be raised.
- **Reset Counters Only:** The counters of each port will be reset to 0, but the function logic will be held static and will not be reset.

Group Name: The name assigned to this hub.

Group Last Change Notify

- **Enable:** Sends out a trap when the value of this field changes.
- **Disable:** Does not send out a trap when the value of this field changes.

To change the setting of a given group:

1. Select the group by number.
2. Set the new value to the Group Admin State.
3. Set reset request to the Group Reset field.
4. Type in the name of the Group Name field.
5. Set Group Last Change Notify field.
6. Select <Save>.

Repeater Port Control/Status

The Repeater Port Control/Status displays status information for each port, of each linked repeater, and allows enabling/disabling, setting the speed, and enabling/disabling link status change notification for ports.

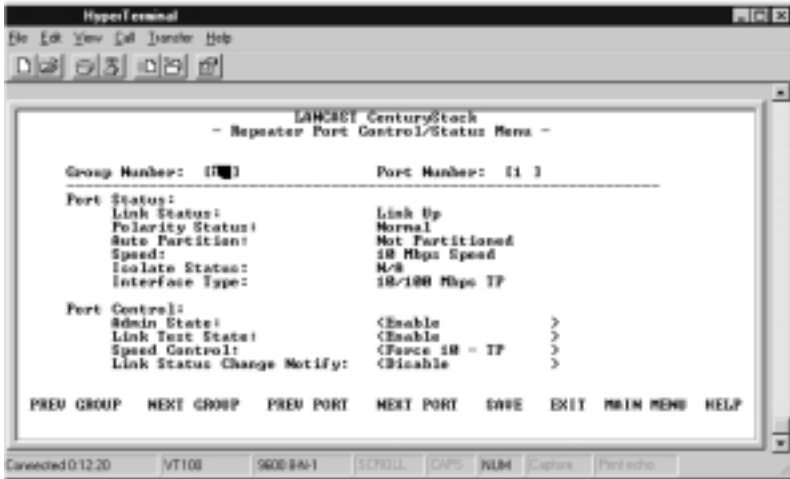

Repeater Port Control/Status

The Repeater Port Control/Status menu provides information about the hub's port status. A hub can be selected with the PREV GROUP and NEXT GROUP commands and its ports selected with the PREV PORT and NEXT PORT commands. The selected port state can be configured.

Group Number: The CenturyStack ID assigned to the hub in the stack. (1 to 6)

Port Number: The port number (1~24) of the hub specified in the Group Number.

Port Status: Displays the current read only settings.

Link Status: The current link status of the port.

- **Link Down:** Link pulses are not detected on this port.
- **Link Up:** Link pulses are being received on this port.

NOTE: When the port link test function is disabled, the Port Link Status always returns Link Up for ports.

Polarity Status: The current polarity link status of the port.

- **Rx Polarity Normal:** The receive polarity of the given port is not reversed.
- **Rx Polarity Reversed:** The receive polarity of the given port is reversed and has been automatically crossed by the repeater.

Auto Partition: The current partition status of the port.

- **Not Auto Partitioned:** The port is not partitioned
- **Auto Partitioned:** The port is partitioned

Speed: This is the current speed of this port. The default is Auto Negotiate.

- **Auto Negotiate:** The port speed is automatically negotiated to the fastest speed with the device connected to the port.
- **Force 10-TP:** The port is forced to operate at 10Mbps only, and can only pass data with 10Mbps devices.
- **Force 100-TP:** The port is forced to operate at 100Mbps only and can only pass data with 100Mbps devices.

Isolate Status (100Mbps Port Only): Indicates whether this 100Mbps port is currently isolated by the repeater.

- **Isolated:** The port is isolated.
- **Interface Type:** The interface type of the port. (TP port interface type)

Port Control

Lists the configurable functions and provides option fields, use Ctrl + S to toggle between options.

Admin State: The current administration state of the port. (enable/disable)

Link Test: Enable or disable link testing.

Speed Control: The port speed. The port automatically connects to the 10Mbps or 100Mbps segment based on its port speed.

- **Auto Negotiate:** The speed is detected and the duplex mode is forced to half duplex.
- **Force 10-TP:** The port speed is forced to 10Mbps.
- **Force 100-TP:** The port speed is forced to 100Mbps.

Link Status Change Notify

- **Enable:** The trap is sent.
- **Disable:** The trap is not sent.

NOTE: Whenever the Port Link Status is changed, the "hubPortLinkStsChgTrap" will be raised by the hub.

2/3 Port Bridge Module Control/Status

This menu displays settings and allows configuring a bridge (switch) module in a given hub in the stack.



2/3 Port Switch Module Control/Status Menu

Group Number: The hub ID number assigned to the stack. (1 to 6)

Bridge Module Status: Displays the current read only settings.

Bridge Description: A description of the characteristics of this bridge module.

- **8102-01-X** Bridge or 10/100BASE-TX Distance Extender
- **8103-01-X** Bridge and 10/100BASE-TX Distance Extender
- **8102-03-X** Bridge or 100BASE-FX Distance Extender
- **8103-03-X** Bridge and 100BASE-FX Distance Extender

External Port Interface Type: Indicates the interface type of the external port for a given module.

- **TP port with RJ-45 interface**
- **Multi-mode with SC type interface**

External Port Link Status: The current link status of the installed module. Read only

- **Link Up**
- **Link Down**

External Port Speed: The module's external port speed. Read only.

- **Half Duplex 10Mbps**
- **Full Duplex 10Mbps**
- **Half Duplex 100Mbps**
- **Full Duplex 100Mbps**

Hardware Status: Indicates the operation status of this module.

- **Operate as Internal Plus External Bridge:** The internal bridge function and the external distance extender function are enabled.
- **Operate as External Bridge Only:** The internal bridge function of a given bridge module is disabled via the hardware configuration.
- **Not Present:** There is no bridge module installed in the given group.

Bridge Module Control

This control lists the configurable functions and provides option fields; use Ctrl + S to toggle between options.

External Function Admin State: The default value is Disable.

- **Enable:** Enables the external bridge function.
- **Disable:** Disables external distance extender function of a given module. Once the distance extender function is disabled, you must enable it to restore external distance extender operation.

Internal Function Admin State: The default value is Disable.

- **Enable:** Enables the internal bridge function. The internal hardware Jumper switch must also be enabled for the internal bridge to function.

NOTE: The internal bridge must be enabled in hardware with the Jumper switch settings before the Admin state can be enabled. Refer to Chapter 2: Using Expansion Modules.

- **Disable:** Disables the internal bridge function. Once the internal bridge function is disabled, then you must enable it to restore internal bridge operation.

NOTES: 1. These modules are not “hot-swappable”. You must remove power from the hub before installing or removing the modules. 2. You should enable the internal bridge on only one switch module if you have multiple bridge modules installed in the stack. This prevents a network loop condition.

External Port Link Status Change Notify: When enabled, a trap is sent to the receiver when link status of the port changes.

- **Enable:** The trap is sent to the trap receivers.
- **Disable:** No trap is sent.

Redundant Link Control

The Redundant Link Control menu allows configuring up to 24 pairs of redundant links. A redundant pair consists of any two physically linked ports in the stack, where one is the primary link port and the other is the secondary link port. The primary link is the active link between two devices and the secondary is a backup and is set to inactive to prevent looping. In the event that the primary link fails, the secondary link becomes active. The secondary link stays active even if the primary link recovers. You must manually reset the primary link status to active in order to re-instate the redundant pair.

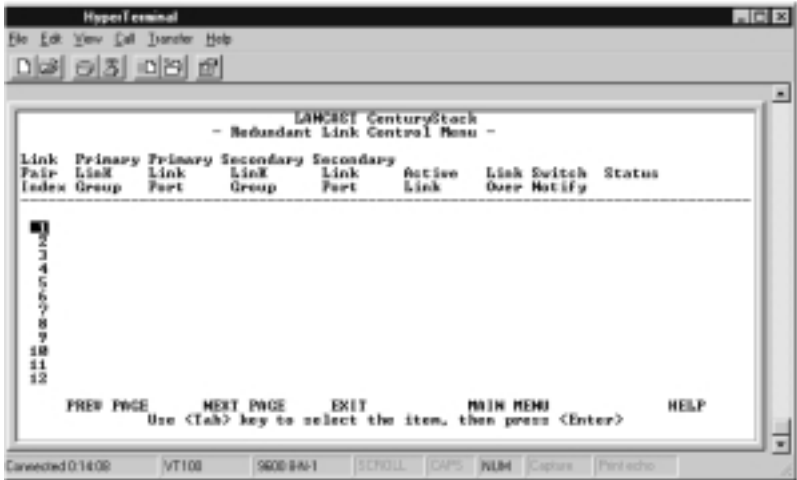

Redundant Link Control

You configure a primary link by assigning a specific port on a specific hub to a Link Pair Index. You assign a secondary link by assigning a specific port on a specific hub to the same Link Pair Index.

Link Pair Index: The number identifying the redundant link pair. (1 to 24)

Primary Link Group: This object identifies the hub ID of the primary link for a given redundant link pair.

Primary Link Port: This object identifies the port number of the primary link for a given redundant link pair.

Secondary Link Group: This object identifies the hub ID of the secondary link for a given redundant link pair.

Secondary Link Port: This object identifies the port number of the secondary link for a given redundant link pair.

Active Link: This object indicates the current status for a given redundant link pair.

- **Primary:** The port is currently the active primary link.
- **Secondary:** The port is currently the secondary port.
- **Both fail:** Both the primary and the secondary failed.

Link Switch Over Notify: If the link status of the active link is down for more than five seconds then the active link failure is detected and “port switch over” is performed and a trap is sent to the trap receivers.

- **Enable:** A trap is sent to the trap receivers if a switch over occurs.
- **Disable:** No trap is sent to the trap receivers if a switch over occurs.

Status: You can enable, disable or suspend the operation of specific redundant link pairs.

- **Enable:** The redundant link pair is in the normal operation mode. The primary port is active and the secondary port is disabled.
- **Disable:** If you disable the active port, the status of this link pair is changed to the suspend state and indicates that the active port has been disabled and the redundant link function is temporarily suspended. If you enable the active port later on, the status of this redundant link pair is changed to enabled.

NOTE: Setting the redundant link to disable does not cause the ports to be switched over.

- **Suspend:** Indicates that the active ports are disabled and the redundant link function is temporarily suspended until you set its state to enable.
NOTE: The suspend state does not cause the port to be switched over.
- **Invalid:** Purge the configuration of a redundant link pair from the system database.
- **Return-to-primary:** Selecting this option and pressing enter re-assigns the primary link as the active link again. A trap is sent to the trap receivers if the status of the redundant link is enable. If the status is suspend, then the link pair is reactivated, but no trap is sent.

Configuring Link Pairs

1. Select a Link Pair. (1-24) Use NEXT PAGE to select pairs 13 through 24.
2. Enter the Primary Link Group (1 to 6).
3. Enter the Primary Link Port (1 to 12/24).
4. Enter the Secondary Link Group (1 to 6).
NOTE: You can configure and save the Secondary Link Group and the Primary Link Group as the same hub, however, this will be of no use in the event of a hub failure.
5. Enter the Secondary Link Port (1 to 12/24).
6. Enable the Link Switch Over Notify. (Optional)
7. Enable the Status.
8. Select <Save> to update the new Linked Pair. Repeat these steps for each Link Pair.

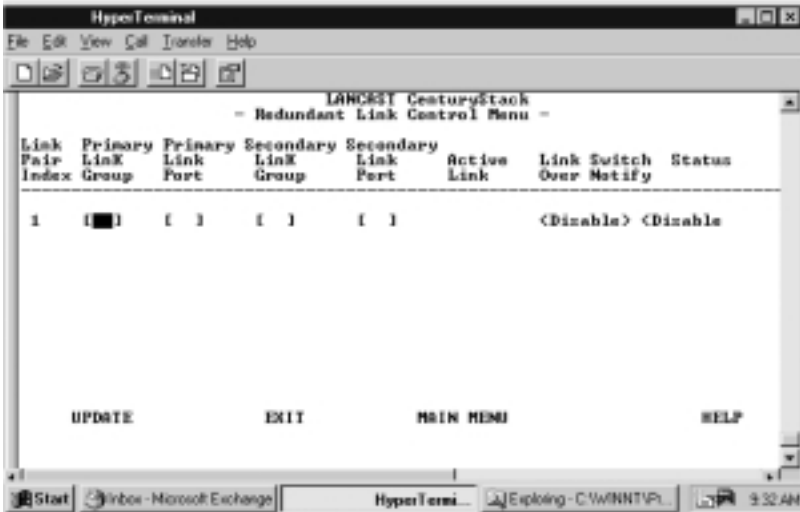

Configuring Redundant Link Control

Editing a Link Pair

You can edit a Link Pair by entering the Link Pair number (of an existing Link Pair) and reconfiguring the rest of the columns, then select Save, the Link Pair is updated to the new settings.

Deleting a Link Pair

You can delete a Link Pair by entering the Link Pair number (of an existing Link Pair) and setting the Status to Invalid, then select <Save>; the Link Pair is removed.

Security Intrusion

The Security Intrusion Control/Status Menu allows setting up security features.

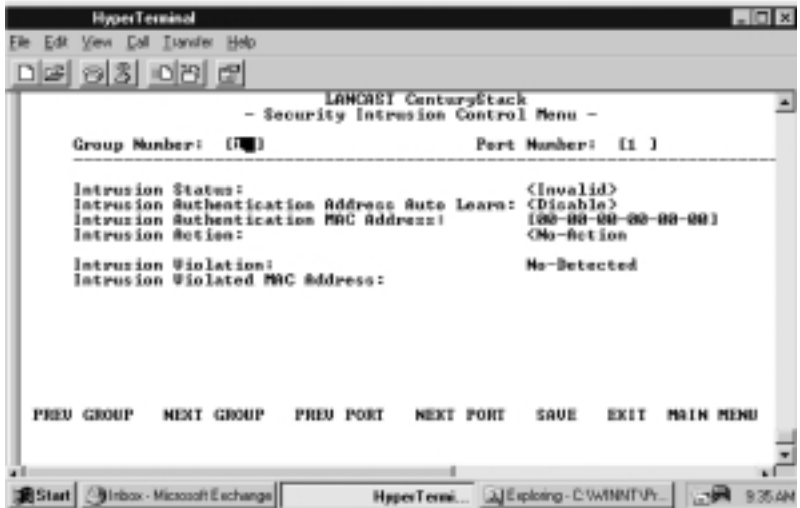

Security Intrusion Control/Status Menu

The intrusion control enables you to set up secure ports that allow access by a single authorized MAC address.

Group Number: The hub ID number that is assigned to the CenturyStack hub (1-6).

Port Number: The port number of the hub that is specified in the Group Number (1-12/24).

Intrusion Status

- **Enable:** Enable the security intrusion control for the current port.
- **Disable:** The security intrusion control of a given port is disabled.

- **Invalid:** Purge the security intrusion control configuration for the current port from the system database.

Intrusion Authentication Address AutoLearn

- **Enable:** The hub learns the MAC address of the first device from which this port receives data. After learning the MAC address, the auto learn function is disabled and the recorded MAC address is the authorized MAC address. This address displays in the Intrusion Authentication MAC address field.
- **Disabled:** Auto learn operation is disabled.

Intrusion Authentication MAC Address: The Intrusion Authentication MAC address is the MAC address of a device that is allowed to connect with this particular port.

Intrusion Action: This is the action that is performed when the hub detects an intrusion of an unauthorized MAC address.

- **No Action:** No action will be taken.
- **Send Trap:** A trap is sent to the trap receivers.
- **Partition Port:** The port is partitioned.
- **Send-Trap-and-Partition-Port:** The port is partitioned and a trap is sent to the trap receivers.

Intrusion Violation

- **Detected:** The MAC address that caused the intrusion is written to the Intrusion Violated MAC Address field.
- **No-Detected:** No intrusion has been detected.

Intrusion Violated MAC Address: Displays the MAC address of the last unauthorized device to send to this port.

NOTE: *If another hub or unrouted switch is attached to a port with Security Intrusion enabled, then only one of possibly many MAC addresses will be allowed to pass data.*

Monitoring the Network

Statistic counters can be monitored for each repeater group and its ports. The Monitoring Network Menu displays the monitoring sub menus.



Monitoring Network Menu

Repeater Statistics Information: Contains Hub statistics such as Tx collisions, total frames and total errors and total octets for both 10Mbps segment and 100Mbps segment.

Repeater Group Statistics Information: Displays the statistic counters for each hub.

Repeater Port Statistics Information: Displays the statistic counters for a selected port.

Address Tracking Information: Provides a way for a network management application to passively gather information about which network addresses are connected to which ports of a hub.

Address Search Information: Active address tracking capability is used to watch for a given MAC address and report on which port it was seen.

Broadcast Storm Protection: Monitor the broadcast counters of each hub port to detect if broadcast storming exists in the network.

Broadcast Storm Detected: Each hub port or optional module port which causes the broadcast storm displays.

Repeater Statistics Information

Selecting this option presents the Repeater Statistics Information Menu as shown below.

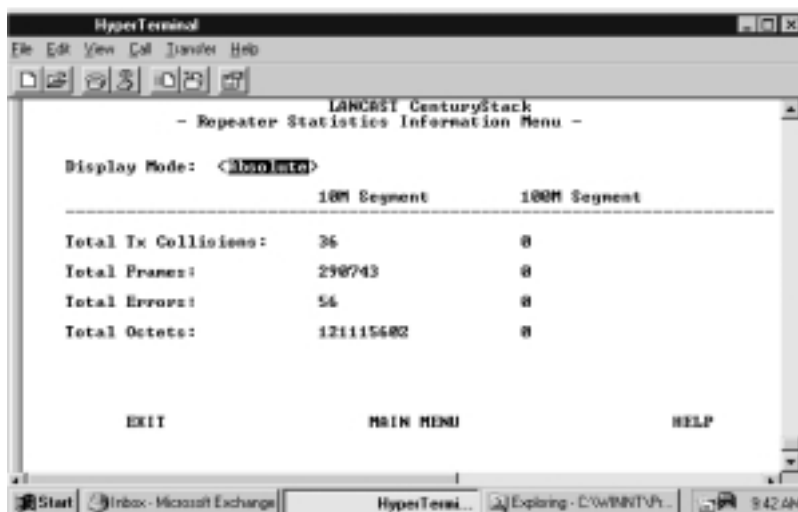

Repeater Statistics Information Menu (Absolute)

You can monitor the statistics in Absolute or Relative counters. The default is Absolute counters.

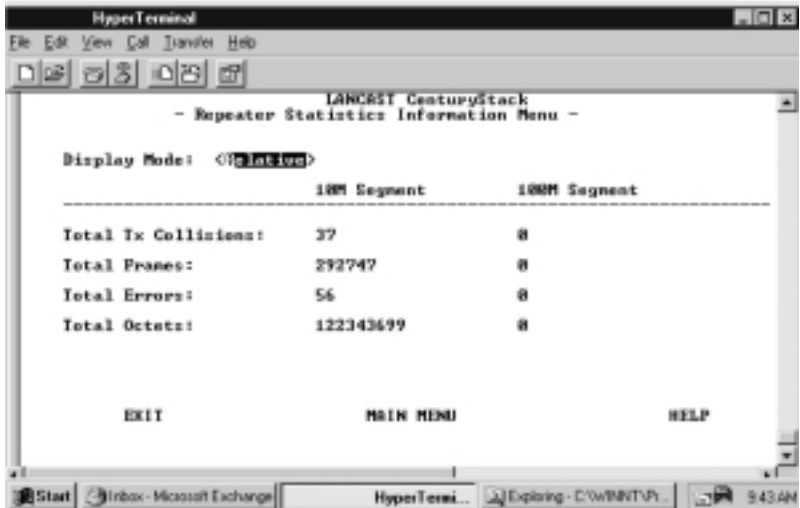

Repeater Statistics Information Menu (Relative)

Total Tx Collisions: The number of transmission collisions that have occurred in this hub.

Total Frames: The number of frames received in this hub.

Total Errors: Total errors received by the port including FCS errors, Align errors, Frame Too Long, Short Events, Late Events, Very Long Events and Rate Mismatches.

Total Octets: The number of octets contained in the valid frames that have been received by this hub.

Repeater Group Statistics Information

The Repeater Group Statistics Information Menu displays statistics counters for each group.

Absolute

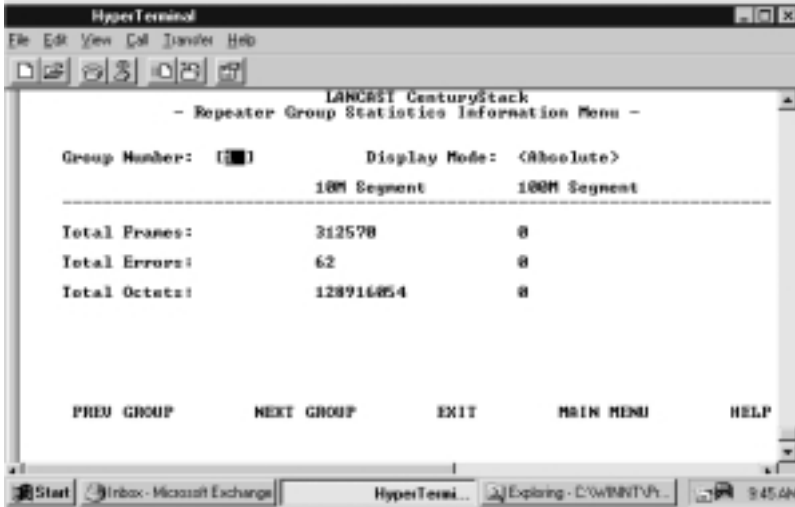

Repeater Group Statistics Information Menu (Absolute)

Statistics information counters for the current hub (Group Number). Counters are displayed in Absolute or Relative values by toggling the display mode. Absolute values represent the value collected since system start. You cannot clear absolute counters using the CLRCNT. Absolute counters are reset by either Group Reset-All or Group Reset Counters only. Relative counters represent the values collected since the relative mode was selected. You can reset the relative counters to zero by changing to Absolute Mode then changing back to Relative Mode.

Relative

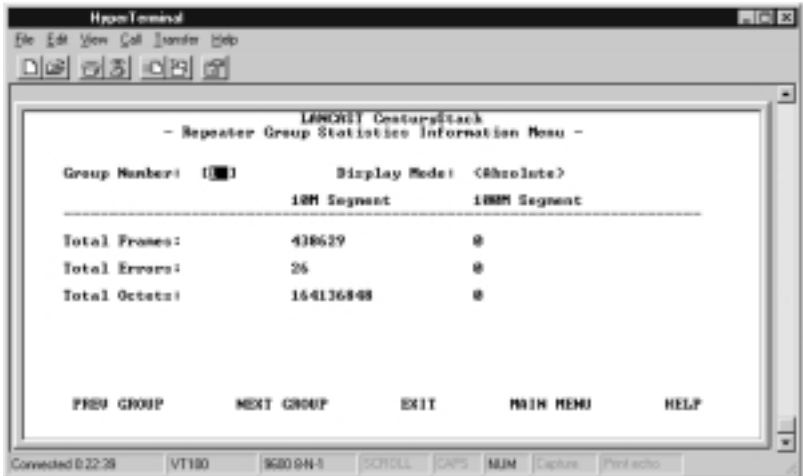

Repeater Group Statistics Information Menu (Relative)

Total Frames: The number of frames of valid frame length that have been received on the ports of this hub and not including FCS Error and Collision Event.

Total Octets: The total number of octets contained in the valid frames that have been received on the ports of this hub.

Tx Collisions: The total number of transmission collisions on this hub.

Total Errors: Total errors received by the port including FCS errors, Align errors, Frame Too Long, Short Events, Late Events, Very Long Events and Rate Mismatch.

Repeater Port Statistics Information

The Repeater Port Statistics Information Menu shows statistics in Absolute and Relative values.

Absolute



Repeater Port Statistics Information Menu (Absolute)

The Repeater Port Statistics Information Menu displays counter information for the current port of the current hub. A hub can be selected with the PREV GROUP and NEXT GROUP commands and its ports can be selected with the PREV PORT and NEXT PORT commands.

Relative



Repeater Port Statistics Information Menu (Relative)

Display Mode: Relative counters represent the values collected since the relative mode was selected. Absolute values represent the value collected since system start.

Group Number: The ID number of a hub in the stack. (1 to 6)

Port Number: Port number of selected group. (1 to 12/24)

Display Mode: Display counters in Absolute or Relative values.

Readable Frames: Total readable frames received by the port.

Broadcast Packets: The total number of good packets received which were directed to a broadcast address. Note that this does not include multicast packets.

Multicast Packets: The total number of good packets received which were directed to a multicast address. Note that this number does not include packets directed to the broadcast address.

FCS Errors: The total number of packets received by the port that had a bad Frame Check Sequence.

Alignment Errors: Total Alignment Errors frames within the proper size (64 to 1518 octets) received by the port.

Frame Too Long: Total frames received by the port that were longer than 1518 octets (excluding framing bits, but including FCS octets).

Short Events: Total frames received by the port that were shorter than 64 octets or activity duration was shorter than the event, ShortEventMaxTime. (74 to 82 bit times)

Runts: The total number of packets received that were less than 64 octets due to collisions or activity duration that was greater than the ShortEventMaxTime event and less than the ValidPacketMinTime event.

Collisions: Total collisions.

Late Events: Total events received by the port where the activity duration is greater than the LateEventThreshold.

Very Long Events: Total events received by the port where the activity duration is greater than the MAU Jabber Lockup Protection timer TW3.

Data Rate Mismatches: Total frames received by the port with no collisions and with an activity duration that was greater than the ValidPacketMinTime event. Also frequency (data rate) is detectably mismatched from the local frames mismatch frequency.

Auto Partitions: Total number of times the port was auto-partitioned.

Isolates (100Mbps only): Total isolates for 100Mbps

transmissions. This counter is incremented by one each time that a port automatically isolates as a consequence of false carrier events. The conditions which cause a port to automatically isolate are defined by the transition from the False Carrier state to the Link Unstable state. The port automatically recovers.

Symbol Errors (100Mbps only): Total symbol errors for 100Mbps transmissions. This counter is incremented by one for each valid length packet received at the port with at least one occurrence of an invalid data symbol. This can increment only once per valid carrier event. The approximate minimum time for rollover of this counter is 7.4 hours at 100Mbps.

Total Errors: Total errors received by the port including FCS errors, Align errors, Frame Too Long, Short Events, Late Events, Very Long Events and Rate Mismatch.

Address Tracking Information

The Address Tracking Information Menu provides per port based node tracking capability (MAC address based). This capability provides the basic traffic analysis function to diagnose network problems, such as Intrusion. The node tracking function records the source MAC of each data packet and provides the filters for data analysis.

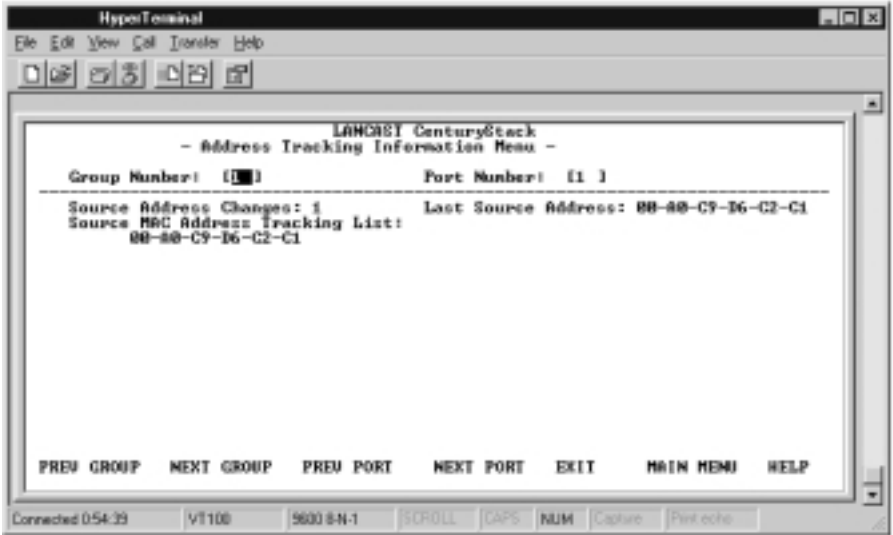

Address Tracking Menu

Source Address Changes: This counter is incremented by one for each time that the Last Source Address for this port changes. This may indicate whether a link is connected to a single device or another multi-user segment. The approximate minimum time for roll-over of this counter is 81 hours.

Last Source Address: Indicates the Source MAC Address of the last readable frame received by this port. If this port has received no frames since the hub began monitoring the port activity, a null string displays.

Source MAC Address Tracking List: A list of source MAC addresses that were recently received on this port. The first

Source MAC Address (00-E0-95-00-00-00 for example) in the tracking list contains the value that is given by the Last Source Address for this port. This list can contain 15 entries. The list does not age out, the first entries are deleted to accommodate new entries when the list is full.

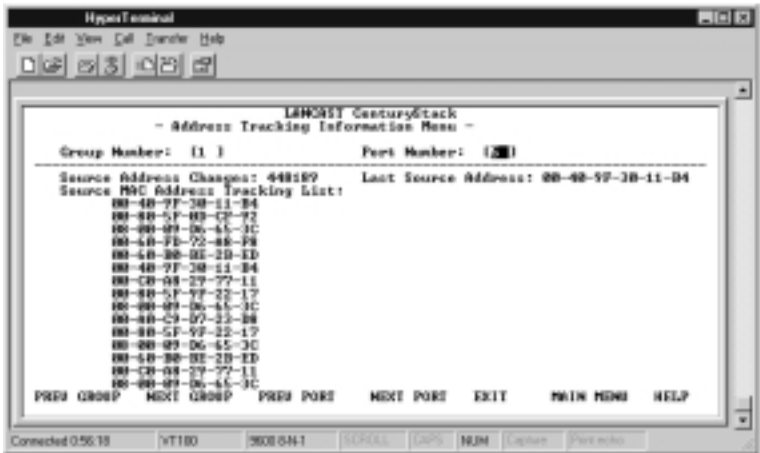

Address Tracking Information Menu (list)

Address Search Information

Selecting this option presents the Address Search Information Menu as shown below.

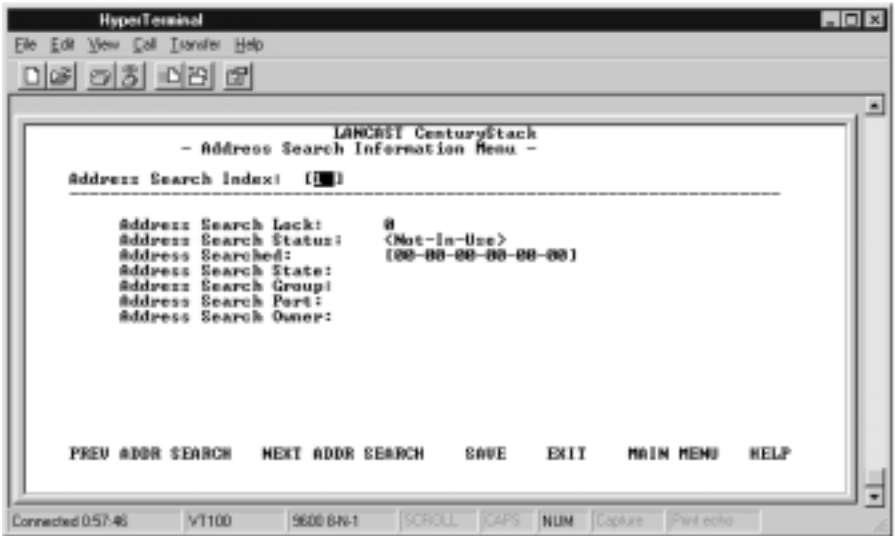

Address Search Information Menu

The CenturyStack provides per segment based source (MAC address) matching capability. The active address tracking capability is used to watch for a given MAC address and report on which port it was seen. This capability can also be used to collect the necessary information for mapping the topology of a network. Up to 8 MAC addresses can be searched simultaneously.

Address Search Index: Identifies the source address to be searched in the system for which this entry contains information. (1-8)

Address Search Lock: Used by a management station as an advisory lock for a search entry. The search lock increments by 1 if the address is available. The number increments to the maximum value of integer type and then roles over to zero.

Address Search Status

- ***In Use:*** A management station has obtained ownership.
- ***Not in Use:*** No other management station has obtained ownership.

A management station first retrieves the values of the appropriate instances of the Address Search Lock and Address Search Status objects, periodically repeating the retrieval if necessary, until the value of Address Search Status is 'Not In Use'. The management station then tries to set the Address Search Lock In Use. If the set operation succeeds, then the management station has obtained ownership of the entry, and the value of Address Search Lock is incremented to 1. Failure of the set operation indicates that some other manager has obtained ownership of the entry.

Address Searched: Specify MAC address for search.

Address Search State: The current state of the MAC address search on this hub.

- ***Single:*** The hub detects the address on one port only.
- ***Multiple:*** The hub detects the address on more than one port.
- ***None:*** The hub does not detect the address of any port.

Address Search Group: The group number received whose source address is the same as the address searched.

Address Search Port: The port number received whose source address is the same as the address searched.

Address Search Owner: The entity that currently has ownership of this search entry

Broadcast Storm Protection

The Hub periodically monitors the broadcast counters of each hub port to detect a broadcast storm condition. If a hub port is detected to be causing a broadcast storm, it is automatically partitioned and a trap is sent to the network manager. The Hub continually monitors those ports that have been partitioned to check if the broadcast storm condition still exists. The partitioned hub port is auto recovered to normal operation once the broadcast storm condition is released.

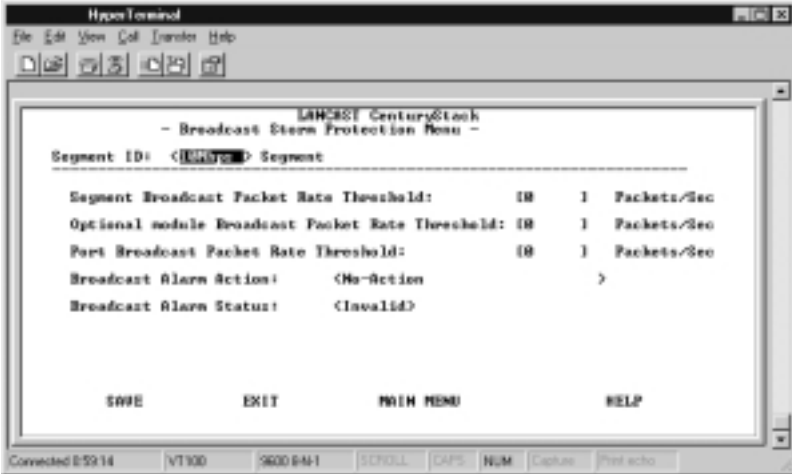

Broadcast Storm Protection Menu

You can configure the broadcast threshold value for each port, each segment, and each optional module. The Segment Rate Threshold, Port Rate Threshold, and Optional Module Rate Threshold determines whether the broadcast storm exists or not.

Segment ID: Identifies the 10Mbps segment or the 100Mbps segment.

Segment Broadcast Packet Rate Threshold: The number of broadcast packets received on a given segment per second. The range is 0 to 14,880 packets per second.

Optional Module Broadcast Packet Rate Threshold: The number of broadcast packets received on a given optional module per second. The range is 0 to 14,880 packets per second.

Port Broadcast Packet Rate Threshold: The number of broadcast packets received on a given port per second. The range is 0 to 14,880 packets per second.

Broadcast Alarm Action: Once a broadcast storm is detected on a given port, the Alarm Detection Status will be set to Detected, and the proper action shall be performed based on the value specified by its Broadcast Alarm Action.

- **Partition:** The port will be disabled. Once a port is partitioned due to broadcast storm, the Broadcast Storm protection function will continue to monitor the port based on the following rule:
 - a) The port is disabled for 15 seconds, enabled again for 5 seconds.
 - b) If the storm exists for 2 minutes, the port is disabled and not monitored.

NOTE: It is up to the user to enable the port once the source of the broadcast storm has been handled.
- **Send Trap and Partition:** The port will be disabled and a trap will be sent.
- **Send Trap:** A trap is sent.
- **No Action:** No action will be taken.

Broadcast Alarm Status

- **Enable:** Enable the broadcast monitoring and protection function on this segment
- **Disable:** Disable the broadcast monitoring and protection function on this segment
- **Invalid:** Purge the broadcast monitoring and protection setting for this segment

Formula for calculating Broadcast packet rate

$$\text{Broadcast packet rate} = \frac{\text{Broadcast packet received}}{\text{Sampling Interval in Seconds}}$$

Broadcast Storm Detected

This menu displays a list of ports with a detected Broadcast Storm.



Broadcast Storm Detected Menu

Each broadcast storm is detected and the hub and port number are listed in this menu. If there have been no storms detected, this menu is empty. A maximum of 32 broadcast storms can be displayed, 16 per page. The list is updated on a first in, first out basis when the maximum of 32 detections is reached.

User Authentication

The User Authentication Menu is used to assign user login names, passwords and read/write privileges. The Mini Console password can be configured in the User Authentication Menu.

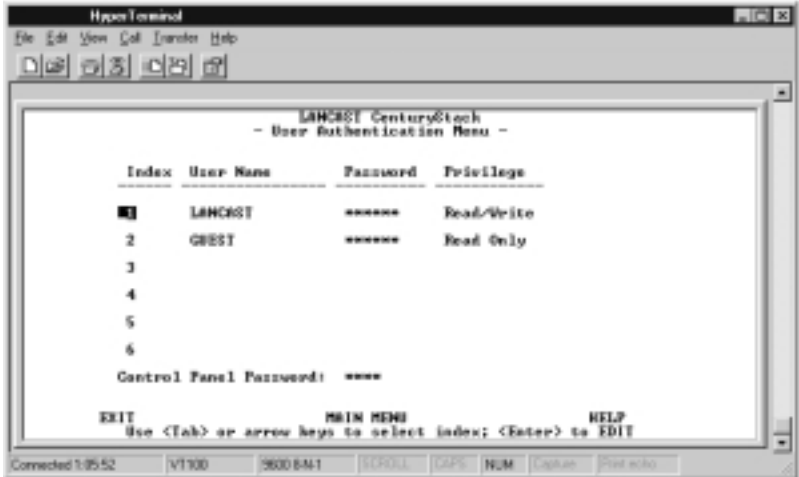

User Authentication Menu

To define each user authentication, select an index number and press <Enter>.

Use the ADD command to add a name. A user name and password can be deleted using the DELETE command. Select the EXIT command to return to the previous screen and view the results.

NOTE: You can configure the user Authentication information (password) of the Mini Console with Local Console or Remote Telnet. The factory default Mini Console password is "0000".

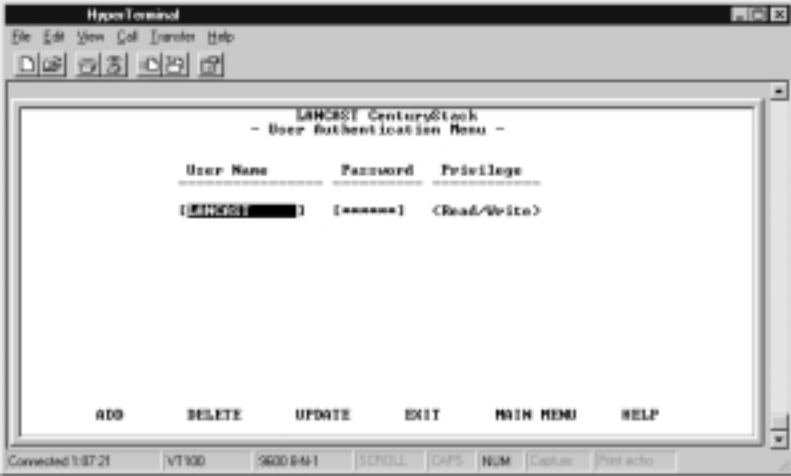

User Authentication Menu (editable)



User Authentication Menu (updated)

Select the index number first and press Enter. Enter a user name of up to 12 characters and a password of up to 6 characters, specify read/write privilege and then press <Enter>.

System Utility

The System Utility Menu lets you download microcode, restart the Hub, reset the Hub to the factory default, set the login time-outs, configure the upload settings and request an upload.



System Utility Menu

System Download: System downloads are used to update system software or replace existing software that has become corrupted.

System Restart: The system can be restarted at any time and is required after certain configuration settings are made.

Factory Reset: The system can be reset to the original settings, however all custom settings will be lost.

Login Timeout Interval: Set the amount of time before a Telnet automatically logs out, when requesting an upload.

Configuration Upload Setting: Set the IP Address of the server and the file name to be uploaded.

Configuration Upload Request/Status: Submit a request for a configuration file upload.

System Download

The System Download Menu enables reading Boot Server Information from a remote BOOTP Server and to download system configuration files, Web Server database information and system software from a remote TFTP Server. To download software check Bootp Request, select the appropriate download function, enter the filename with the full path, save the configuration and finally, restart the device from the System Restart Menu.

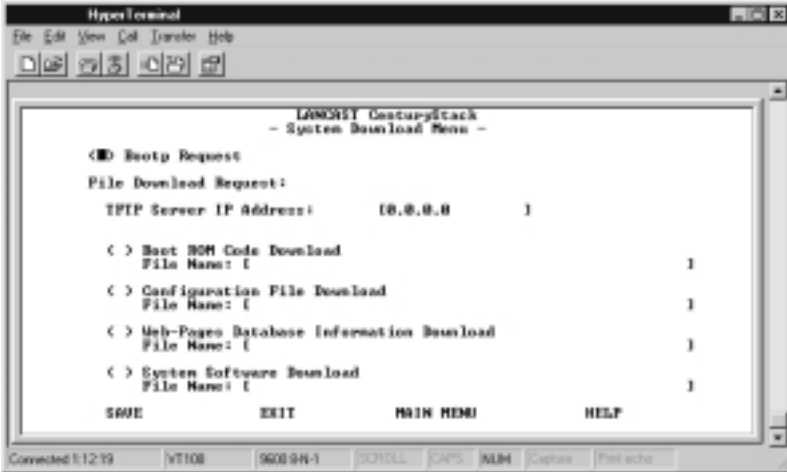

System Download Menu

This menu lets you perform a BootP request and a TFTP code download.

To request an IP address, subnet mask, and a default gateway address from your BootP server, perform the following steps:

1. Select Bootp request

NOTE: Not all DHCP servers support basic BOOTP services. If you experience a problem check your DHCP server manual.

2. Perform a cold restart on the system.
You should perform a code download only to update existing software or if existing code has become corrupted. Before performing a system download, make sure that you know the IP address of your TFTP server and the location of the files on the server.

NOTE: Use the following naming convention:

- **Boot ROM Code download - 110Vxxx.BT**
- **Web Pages Database Information Download – 110Vxxx.WEB**
- **System Software Download - 110Vxxx.RT**
where, xxx is the version number.

To download TFTP code, perform the following:

1. Enter the IP address of the TFTP server.
2. Select the downloads that you want to perform.
3. Enter the path and file name for each of the downloads you have selected (for example, C:\microcode\110V101.BT).
4. Save the configuration.
5. Restart the system.

System Restart

The System Reset Menu allows the user to reset the system with a **Cold** or **Warm** reset.



System Restart Menu

You can restart the system at any time without losing configuration settings, except in the case of a download. When you select Execute and then select <Enter>, a warning message informs the user that system restart is going to be performed right now.

Warm: A warm restart restarts the hub at the runtime code. For most cases, a warm restart is sufficient, except in the case of a BootP request or code download.

Cold: A cold restart restarts the hub at the BOOTROM level and is the same as unplugging and re-plugging power to the hub. A cold restart is needed when the user performs a BootP request or code download.

Factory Reset

The Factory Reset Menu allows resetting CenturyStack to the original factory settings. All user configurations will be lost. A Confirm Messages displays before the hub is reset so the user can abort the factory reset.



Factory Reset Menu

The Factory Reset Menu lets you return all Hub settings to the original default settings.

When you issue a factory reset, all of your custom settings are overwritten.

To perform the factory reset, do the following steps:

1. Select how the user wants network configuration processed during a factory reset:
 - **Not Reset:** Current configuration is saved.
 - **Reset from BootP:** Request a new network configuration from the BootP server.
 - **Reset to factory default:** Current network configuration is reset to factory defaults.

2. Select how the user wants the user authentication configuration processed during a factory reset:
 - **Not Reset:** Current user authentication configuration is saved.
 - **Reset to factory default:** Current user authentication configuration returns to factory defaults.
3. Select Execute and press <Enter>.

When Execute and Enter are selected, a warning message informs the user that system configuration data will be reset.

Login Timeout Interval

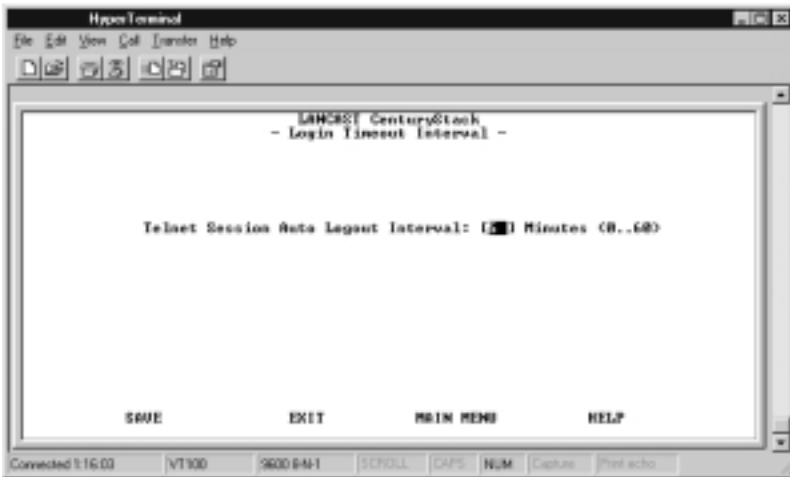

Login Timeout Interval Menu

This menu lets you select the time after which an established Telnet session is automatically logged out if inactive. The range is zero to 60 minutes. The default is five minutes. If you specify zero, the session remains logged in regardless of how long it is inactive.

Configuration Upload Setting

CenturyStack network management provides the capability to upload the hub configuration data to the remote server in binary format. You can upload your configuration files and save as a backup in case you need to restore your system settings.

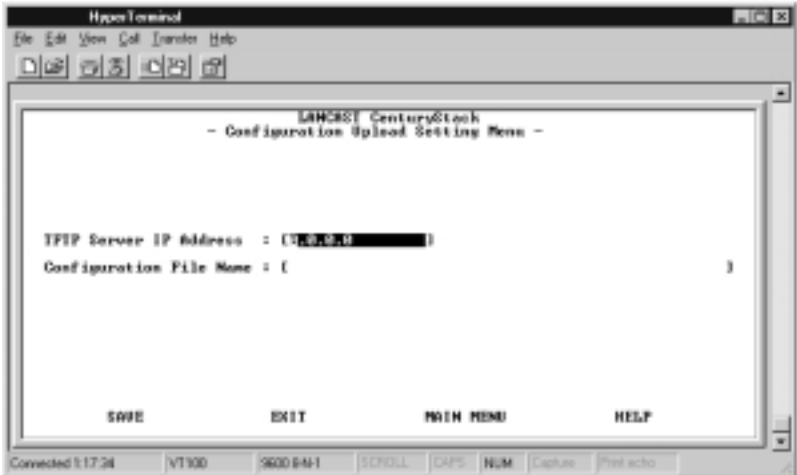

Configuration Upload Setting Menu

Enter the TFTP Server IP Address and the chosen file name (for example: filename.CFG) and the path where the files will be uploaded on the server. Select Save to save your configuration settings, and then request the upload using the Configuration Upload Request Menu.

TFTP Server IP Address: The IP address of the server where the configuration files are to be stored.

Configuration File Name: The name of the configuration file and the full path.

Configuration Upload Request/Status



Configuration Upload Request

This menu enables you to submit a request for a configuration file upload and view the status of a download. Select Submit to make the Upload Request.

TFTP Server IP Address: The IP address of the server where the configuration files will be uploaded.

Configuration File Name: The name of the configuration file and the full path.

Current State: When the configuration file download is complete, Completed displays.

Time Elapsed: The time elapsed since starting the upload request.

Upload Status: The status of the data transfer with regard to errors.

- **No Error:** The upload was successfully stored in the specified configuration file.
- **No-Such-File:** The path specified in the Configuration Filename field cannot be found on the TFTP Server.
- **Access Violation:** The file specified Configuration Filename field is Write Protected.
- **Disk Full:** The disk specified Configuration Filename field is full.
- **Timeout:** The TFTP upload timeouts expired at 20 seconds. A progress bar displays in the menu showing the progress.
- **Other:** Other errors that are defined by the system.

Once you have uploaded your configuration files, you can download them if necessary. See “System Utility”, for information about downloading configuration files.

SNMP Management

Managing via MIB File

CenturyStack’s built in Management Information Base allows it to be managed by any MIB file browser. For more detailed information on SNMP management see the software manual.

Chapter 5

Technical Information

Product Specifications

Standards Compliance	IEEE 802.3 10BASE-T, 10BASE5 Ethernet IEEE 802.3u 100BASE-TX Ethernet
Number of Ports	12/24 auto-sensing 10/100M Ethernet (RJ-45) ports
Display Panel	
Master:	Vacuum Fluorescent Display (VFD) providing extensive network status information utilization graphs and statistics at a glance
Slave:	Rich diagnostic LEDs indicate Link/Rx per port; Forwarding indicator for both 10/100Mbps segments Collision indicator for both 10/100Mbps segments 10/100Mbps indicators with internal/external switch module activities
Media Interface Exchange	2 10/100Mbps Uplink ports (MDI-II) shared with port 1 & port 12 respectively
Stacking	6 hubs per stack SCSI cascade Automatic Unit ID numbering Management data on serial cascade Class II repeater
NMU Slot	1 slot for network management unit (Master only)
Expansion Slot	1 slot for optional switch module

Smart Mini Console	Configuration, device/port management, and network statistics monitoring (Master only) Three keys on the front panel to perform for all the Mini Console functions VFD (Vacuum Fluorescent Display) panel displays text & graphic information
Key Management Features (through Web and SNMP)	Master/Slave management architecture Per port address tracking Per stack source address search capability Network traffic monitoring Duplicated IP detection Intrusion control per port security 24 pairs of redundant link Broadcast storm protection
BOOTP/TFTP	software download supported
Console/Telnet Management	VT-100 terminal interface supported Local console management via RS-232 (DB-9) port In-band/out-of-band remote telnet management Web-Based Management Complete web server embedded in device Integrated HTML forms and Java™ applets Standard web server security to total network protection Photographic quality GUI to configure/monitor Management from anywhere and any platform
SNMP Management	Supporting standard RFC 1213 MIB II, RFC 1516 Repeater MIB, and proprietary MIBs Supporting RFC 1757 RMON Group 1, 2, 3, 9 In-band/Out-of-Band management

Power Requirements	100 - 240 VAC, 50/60 Hz Internal universal power supply
Environment	Operating Temperature: 10° to 40° C Storage Temperature: -25° to 70° C Operating Humidity: 8% to 80% non-condensing
Safety Regulations	CUL (UL & CSA)
EMI Certifications	CE Mark FCC Class A VCCI Class 1
Dimensions	W x D x H : 17.3" x 8.7" x 2.2"
Weight	6.3 lb
Mounting	Standard EIA 19" rack mount
Ordering Information	
8112-01-M/8124-01-M	12/24 ports auto sensing 10/100Mbps Master Hub with Local console/Remote Telnet management, SNMP, Web-Based Management & Mini-Console Management
8112-01-S/8124-01-S	12/24 ports auto sensing 10/100Mbps Slave Hub
Optional Modules	
Module 8102-01-X	Bridge or 10/100BASE-TX Distance Extender Switch Module (MDI-X & MDI-II interface)
Module 8102-03-X	Bridge or 10/100BASE-FX Distance Extender Switch Module (SC-type connector)
Module 8103-01-X	Bridge and 10/100BASE-TX Distance Extender Switch Module (MDI-X & MDI-II interface)
Module 8103-03-X	Bridge and 10/100BASE-FX Distance Extender Switch Module (SC-type connector)

Agency Compliance

Product Safety and Compliance Statements

This equipment complies with the following requirements:

- UL
- CSA
- TUV
- EN60950 (safety)
- FCC Part 15, Class A
- EN55022 Class A (emissions)
- EN50082-1 (immunity)
- IEC 825-1 Classification
- Class 1 Laser Product

This product shall be handled, stored and disposed of in accordance with all governing and applicable safety and environmental regulatory agency requirements.

Radio Frequency Interference Statements

FCC Radio Frequency Interference Statement

This equipment has been tested and found to comply with the limits for Class A digital device, pursuant to Part 15 of FCC Rules. These limits are designed to provide reasonable protection against harmful interference when the equipment is operated in a commercial environment. This equipment generates, uses and can radiate radio frequency energy, and if not installed and used in accordance with the instruction manual, may cause harmful interference to radio communication. Operation of this equipment in a residential area is likely to cause harmful interference in which case the user will be required to correct the interference at his own expense.

CAUTION: Changes or modifications to this equipment not expressly approved by the party responsible for compliance could void the user's authority to operate the equipment.

Canadian Radio Frequency Interference Statement

This Class A digital apparatus meets all requirements of the Canadian Interference-Causing Equipment Regulations.

Cet appareil numérique de la classe A respecte toutes les exigences du Règlement sur le matériel brouilleur du Canada.

Warranty and Servicing Information

METRObility Optical Systems, Inc. warrants the CenturyStack 8100 Managed Hub to be in good working order for a period of **THREE YEARS** from the date of METRObility shipment. Should the unit fail anytime during said three-year period, METRObility will, at its option, replace or repair the product. This warranty is limited to defects in workmanship and materials and does not cover damage from accident, disaster, misuse, abuse or unauthorized modifications. Under no circumstances will METRObility be liable for any damages incurred by the use of this product including, but not limited to, lost profits, lost savings, and any incidental or consequential damages arising from the use of, or inability to use, this product.

If the product was purchased from an authorized METRObility dealer, limited warranty service may be obtained by returning the product to the dealer. Return the product in its original shipping container (or equivalent), pre-insured, and with proof of purchase.

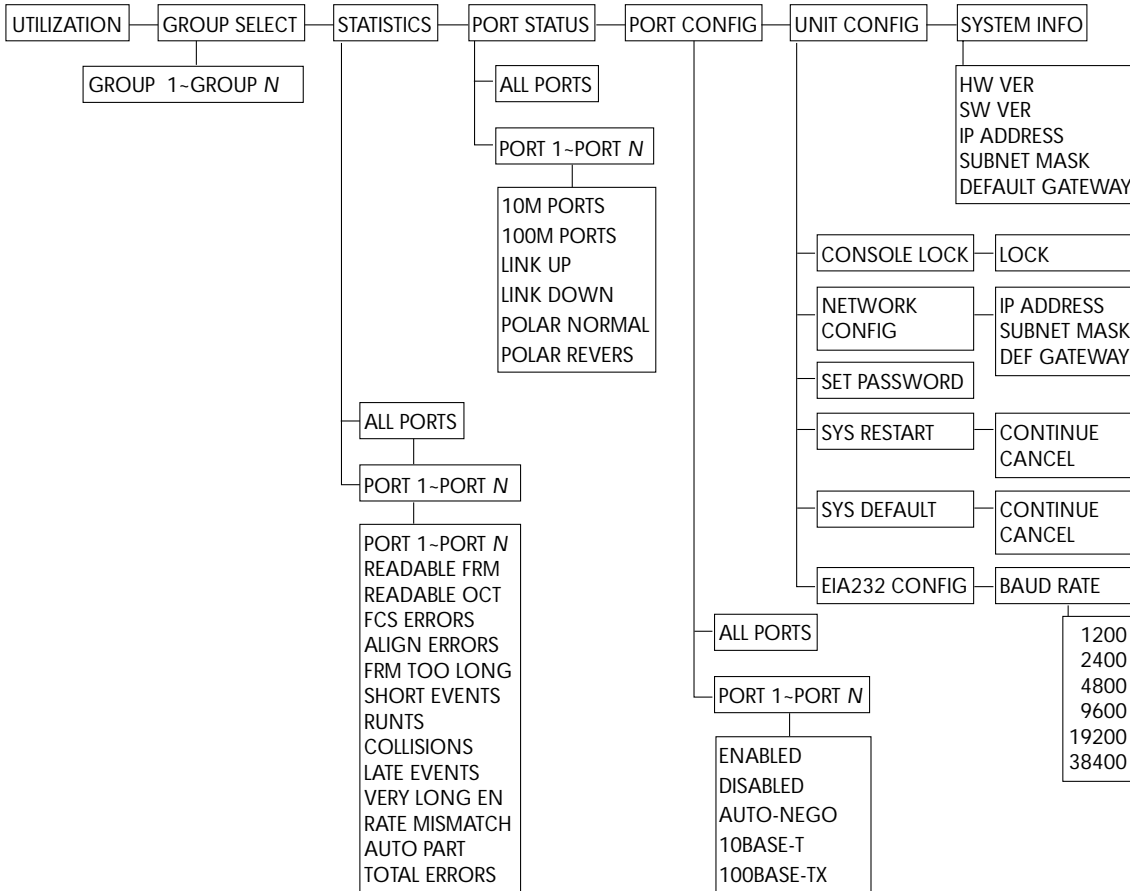

Troubleshooting the Network

- Q: The local-console 'login screen' does not come up sometimes when a terminal (PC running terminal emulation) is connected to already booted master hub. Why?
- A: The screen must be refreshed, when CenturyStack is running and the terminal emulator is started. Pressing Ctrl + R refreshes the screen and the login menu appears.
- Q: Users of the 100Mbps segment cannot use Web-Based Management, however 10Mbps segment users can. Why?
- A: The SNMP agent, TCP/IP stack and the Web engine are implemented on the 10Mbps bus of the master hub. Therefore the 10Mbps segment must be used for Web-Based Management in the absence of a switch module.
- Q: Even though the switch module with internal bridging has been installed, the 10Mbps segments can't communicate with the 100Mbps segments. Why?
- A: The switching function is disabled by default in the software, therefore even though the internal function is enabled with the on board jumpers, 10Mbps and 100Mbps segments cannot communicate. The internal switch must be enabled using local console management through connections from the RS-232 port on the hub to a serial port on a PC. Select Device Control from the main menu and then 2/3 port bridge module control/status. Enable the internal switch.
- Q: With regards to CenturyStack modules: Users will need to use Web or Console management to enable the module, however, what if users only have a slave model in their LAN and want to install a 8102-01 as an internal switch or have a 8103-01 as both internal and external, or have another slave model in the stack and one 8102-01 as an external switching port?
- A: In the case of 8112-01-S only, (whether single or multiple stacked), the switch module will function straightaway when installed. The mode ("internal" or/and "external") can be set on the module PCB using the jumpers provided. When the master hub is present, we need to additionally enable the module's function in the management software (through Local Console or Web-Based Management/SNMP Management).
-

- Q: Is there a loop detection and isolation feature available in CenturyStack, in case two switch modules (internal bridging enabled on the hardware) are installed in the same stack?
- A: No. The stack will go into a loop even before the software has booted. Therefore, the only control is on hardware (jumpers on the PC board)
- Q: In Web-Based Management, the Hub's front panel is not displayed.
- A: For Netscape users, you need to clear the memory cache. To clear memory cache, from the Netscape menu bar, select Edit, select Preferences from the drop down list, click the + sign beside Advanced and then select Clear Memory Cache.
- Q: I do not see the graphic of the unit when I use Internet Explorer as my browser.
- A: If you are using Internet Explorer version 4.72 or newer, you will need to modify the Java settings. From the task bar, select View, then Internet Options, then Security. Set security to Custom, then go into Settings. From here, scroll down to Java and click Custom. A Java Custom Settings box displays in the lower left corner. Select this box, highlight Permission Given to Unsigned Content, then select the Edit Permission tab. Finally, select Enable under Run Unsigned Content.

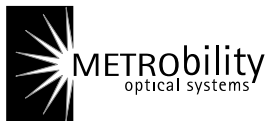

25 Manchester Street, Merrimack, NH 03054 USA
tel: 603-880-1833 • fax: 603-594-2887
www.metrobility.com

5660-810000-001 C
8/01

Free Manuals Download Website

<http://myh66.com>

<http://usermanuals.us>

<http://www.somanuals.com>

<http://www.4manuals.cc>

<http://www.manual-lib.com>

<http://www.404manual.com>

<http://www.luxmanual.com>

<http://aubethermostatmanual.com>

Golf course search by state

<http://golfingnear.com>

Email search by domain

<http://emailbydomain.com>

Auto manuals search

<http://auto.somanuals.com>

TV manuals search

<http://tv.somanuals.com>