

INSTALLING THE REMOTE CONTROL'S BATTERY

Replacing the Remote Batteries

1. Remove the battery cover by pressing in on the tab and the lifting the cover off.
2. Insert a CR2025 button-type battery into the battery compartment with the "+" facing up. Replace the battery cover.

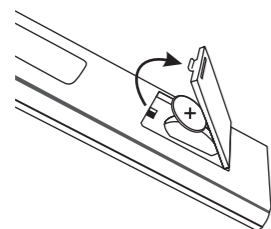

BATTERY PRECAUTIONS

Follow these precautions when using batteries in this device:

1. Warning—Danger of explosion if battery is incorrectly replaced. Replace only with the same or equivalent type.
2. Use only the size and type of batteries specified.
3. Be sure to follow the correct polarity when installing the batteries as indicated in the battery compartment. Reversed batteries may cause damage to the device.
4. If the device is not to be used for a long period of time, remove the batteries to prevent damage or injury from possible battery leakage.
5. Do not try to recharge batteries not intended to be recharged; they can overheat and rupture. (Follow battery manufacturer's directions.)

LOCATION OF CONTROLS

FRONT

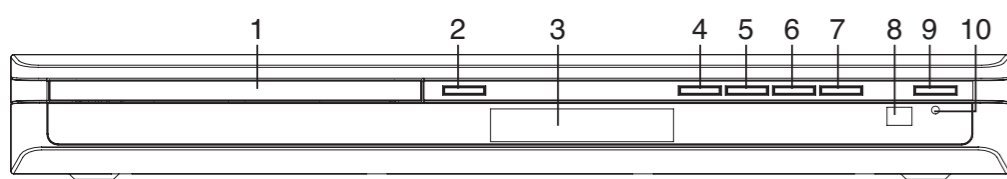

1. Disc Compartment
2. OPEN/CLOSE Button
3. Display
4. Play/Pause Button
5. Stop Button
6. Skip/Search Down Button
7. Skip/Search Up Button
8. Remote Sensor
9. Power Button
10. ON/STANDBY Indicator

REAR

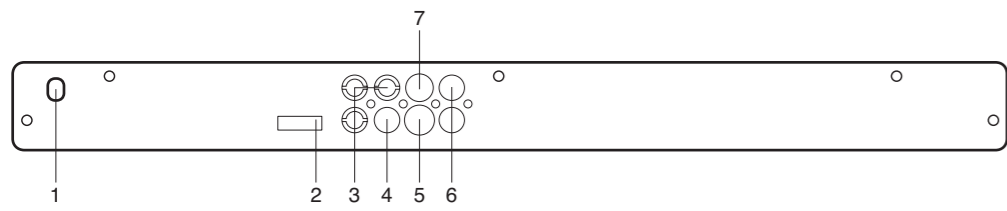

1. AC Power Cord
2. HDMI Jack
3. Component Video (Y, PB, PR) Output Jacks
4. Coaxial Digital Audio Output Jack
5. S-Video Output Jack
6. Audio Left/Right Output Jacks
7. Video Output Jack

AV Cable Part No. 043-28102-533-001*

REMOTE

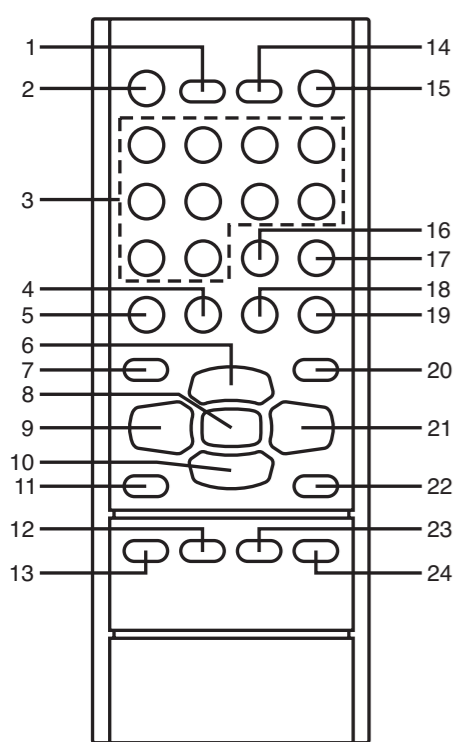

1. HDMI/PS Button
2. STANDBY ON/OFF Button
3. Number Buttons
4. REV (Reverse) Button
5. OPEN/CLOSE Button
6. Navigation (Up) Button
7. ANGLE Button
8. ENTER/PLAY Button
9. Navigation (Left)/SKIP Button
10. Navigation (Down) Button
11. SEARCH Button
12. TITLE/RETURN Button
13. SUBTITLE Button
14. DISPLAY Button
15. MUTE Button
16. REPEAT/A-B Button
17. PAUSE/STEP Button
18. FWD (Forward) Button
19. STOP Button
20. ZOOM Button
21. Navigation (Right)/SKIP Button
22. SETUP Button
23. AUDIO Button
24. DVD MENU/PBC Button

REMOTE PART NO. HS-MVD2047-BLK-320*

*Consumer Replaceable Part (See bottom of page 4 to order.)

CONNECTIONS

Connection DVD to TV

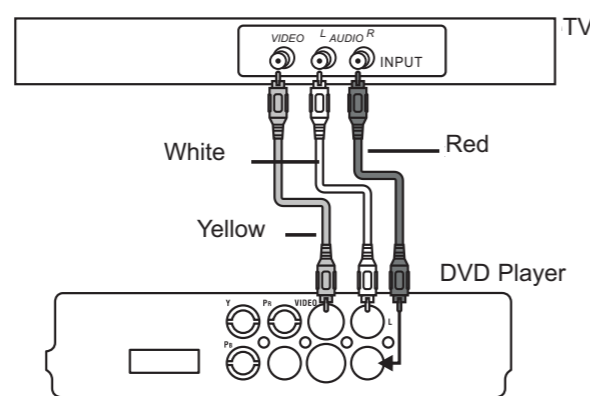

NOTE: When connecting the system cables, turn off the power and make certain the AC cord has been removed from the wall outlet. See figure on previous page.

1. Connect the Left and Right audio cables to the Left and Right AUDIO OUT jacks on the rear of the DVD player. Connect the other ends to the Left and Right IN jacks on the TV. You can also use the Coaxial Digital Out as described below.
2. Connect the video cable (Select one of the following connections for video.)

(GOOD) BASIC: Connect the video cable to the VIDEO OUT jack on the rear of the DVD player. Connect the other end to the VIDEO IN jack on the TV.

(VERY GOOD) S-VIDEO (not shown): Connect the S-Video cable to the S-VIDEO jack on the rear of the DVD player. Connect the other end to the S-VIDEO jack on the TV.

(BETTER) PROGRESSIVE (Y, PB, PR) VIDEO OUT: Use these jacks to connect to a TV with progressive video input jacks, press the HDMI/PS button to select the compatible resolution of the TV. Progressive scan is a video scanning system that displays all lines in a frame in one pass, as opposed to the traditional system, interlaced scan. This connection provides optimum quality. To ensure maximum picture quality, use three video-grade cables for connections. Note that it is essential to match the color-coded connectors with a compatible TV.

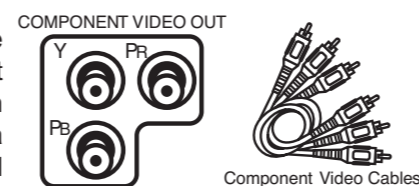

NOTE: IF THE TV SCREEN IS BLANK, PRESS THE HDMI/PS BUTTON REPEATEDLY UNTIL THE PICTURE APPEARS ON THE SCREEN AGAIN.

(BEST) HDMI (not shown): Connect an HDMI cable (Not included) to the HDMI jack on the rear of the DVD player. Connect the other end to the HDMI IN jack on the TV. HDMI transfers audio and video signals, so if using HDMI, there is no need to connect to audio separately. Press the HDMI/PS button to select the compatible resolution of the TV.

IMPORTANT HDMI NOTE: When using HDMI as your video source, setup the HDMI in the General Setup Menu as described later in this manual. If your TV does not have Audio and Video input jacks and only has an RF jack, you need to connect an FR modulator (not provided).

Connecting the DVD to a Home Theater System

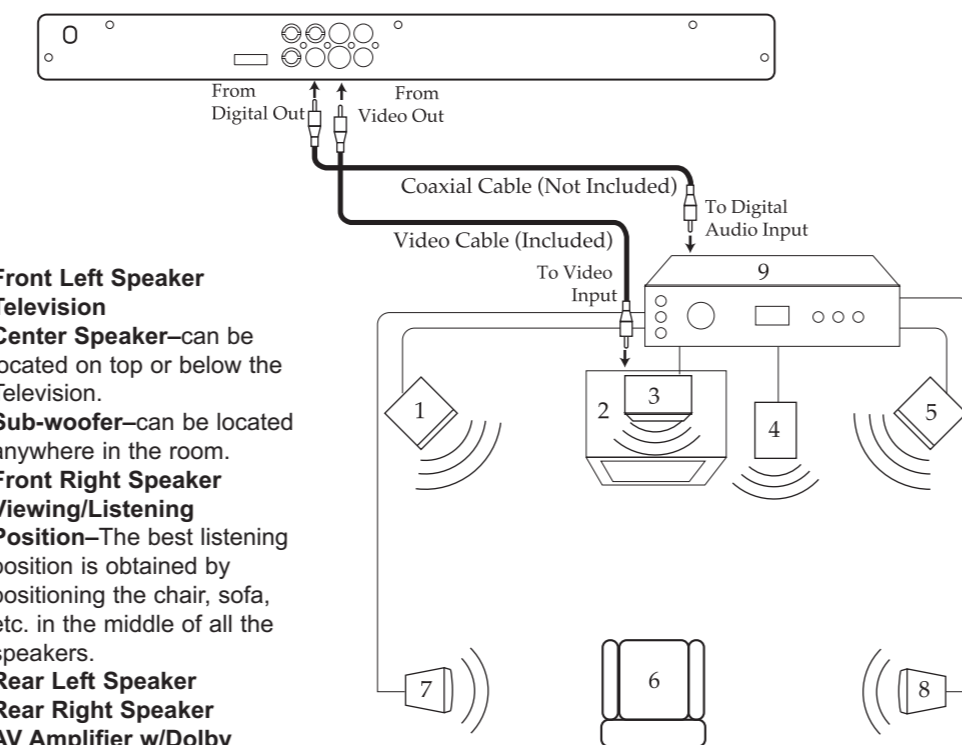

1. Front Left Speaker
2. Television
3. Center Speaker—can be located on top or below the Television.
4. Sub-woofer—can be located anywhere in the room.
5. Front Right Speaker
6. Viewing/Listening Position—The best listening position is obtained by positioning the chair, sofa, etc. in the middle of all the speakers.
7. Rear Left Speaker
8. Rear Right Speaker
9. AV Amplifier w/Dolby Digital Decoder/DTS Decoder

Place the subwoofer, front, rear and center speakers in locations as shown/described here. After correctly positioning the speakers, perform the Tone Test on the AV Amplifier and adjust the volume controls until the desired sound is achieved. For best results, sit in the viewing position and have someone adjust the volumes for you; this will enable you to set the optimal levels.

NOTES FOR CONNECTING TO A TV:

- If your TV has an HDMI input, connect the DVD player with the component cable for best results, otherwise use the Component, S-Video or Video OUT jack on the DVD player.
- Set the TV's TV/VIDEO button or switch to the VIDEO setting.
- When connecting the DVD, refer to the owner's manuals for the TV and the audio system, as well as this manual.
- When connecting, make sure the power is off and all units are unplugged before making any connections.
- Connect the DVD player to your TV directly. If you connect the DVD player through a VCR, the playback picture will be distorted because DVD video discs are copy protected.
- If using a TV with a blue screen option, turn the option off for best results.
- If you place the DVD player near a tuner, the radio broadcast sound might be distorted. In this case, move the DVD player away from the tuner.

PLAYING DISCS

Compatible Discs

This DVD player is capable of playing the following types of discs: DVDs, DVD+/- R, DVD+/- RW, Audio CDs, Video CDs, CD/CD-R/RW with MP3 files, MPEG4 and Kodak Picture CDs. Before you insert a disc in the player, make sure it is compatible.



You cannot play the following types of discs: laser Discs, CD-I, CD-ROM (computer discs), DVD-ROM or discs recorded using other broadcast standards (i.e. PAL or SECAM) or CD-G discs.

NOTE: Some discs may not be compatible due to laser pickup, recording formats and software used. Some technologies and methods used for MP3 file recording on CD-R/RWs can prevent optimal playback of these files by degrading the sound quality and/or the ability for the player to read the file.

Regional Coding

Both the DVD Player and the discs are coded by region. These regional codes must match in order for the disc to play. The region code for this DVD player is listed on the back of the player.

BASIC PLAYBACK OPTIONS

DVD/CD/VCD BASIC OPERATION

1. Plug the power cord into the outlet once the DVD player is connected to your TV.
2. Turn on the TV and tune to its Video Input Channel, if necessary.
3. Press the STANDBY button on the remote or the Power button on the main unit to turn on the unit; the On/Standby indicator will turn off.
4. Press the OPEN/CLOSE button to open the disc tray. Insert a disc with the label side facing up on the disc tray. Press the OPEN/CLOSE button again to close the tray; playback will start automatically.
5. If the Menu appears, use the Navigation (Left, Right, Up, Down) buttons to select the desired option and press the ENTER/PLAY button to select it.
6. To stop playback, press the STOP button. Because the unit will remember where you stopped (not applicable in CD mode), simply press the ENTER/PLAY button to resume playback where you left off (resuming playback). If the STOP button is pressed twice, the unit will stop completely. If the player is left in Stop/Pause mode for more than one minute without any user interaction, the screen saver will activate if the Screen Saver menu option is set to ON. There is no resume function when playing CDs.

SEARCH FORWARD/REVERSE: During playback, press the FWD or REV button to move the disc forward or backward at double (x2) speed to locate a specific section. Repeatedly press and the speed will increase to x4, x8, x16 and resume normal playback.

NOTE: The disc will move forward or backward at high speed until you press the ENTER/PLAY button; normal playback will resume at that point.

PAUSE AND STEP: Press the PAUSE/STEP button while in the Play mode to pause the picture. To advance one frame at a time, press the PAUSE/STEP button repeatedly. To resume normal playback, press the ENTER/PLAY button.

SKIP: Press the Skip button to advance the disc to the beginning of the next chapter/track. Press the Skip button to move the disc to the beginning of the previous chapter/track.

ZOOM: Press the ZOOM button once during Normal or Still playback modes, and the unit will zoom x2. Press once or twice more and the unit will zoom x3 or x4. Use the Navigation buttons to move the image on the TV screen. Press the ZOOM button once more to cancel the zoom function. This is not available on all discs.

SLOW FORWARD AND REVERSE: Press the PAUSE/STEP button to pause the playback, then repeatedly press the FWD button to move the DVD forward in slow motion speeds of 1/2, 1/4, 1/8, 1/16 and resume normal playback. Repeatedly press the REV button to move the DVD backward in slow motion speeds of 1/2, 1/4, 1/8, 1/16 and resume normal playback. The sound will be muted. You can also press the ENTER/PLAY button to resume normal playback.

BASIC PLAYBACK OPTIONS (CONTINUED)

TITLE/CHAPTER SEARCH (DVD ONLY): Press the SEARCH button once. Press the Navigation buttons to select Title, then use the Number buttons to select the desired title number (i.e. for number 5, press "05"). Playback will start immediately. OR Press the Navigation buttons to select the Chapter, then use the Number buttons to select the desired chapter number (i.e. for number 2, press "02"). Playback will start immediately.

TITLE/CHAPTER/TIME SEARCH (DVD ONLY): Press the SEARCH button twice. Press the Navigation buttons to select Title, then use the Number buttons to select the desired title number (i.e. for number 5, press "05"). Playback will start immediately. OR Press the Navigation buttons to select the Title Time, then use the Number buttons to select the desired Title Time (Hour/Minutes/Seconds); playback will start immediately. Press the SEARCH button a third time. Press the Navigation buttons to select the Chapter, then use the Number buttons to select the desired chapter number (i.e. for number 5, press "05"). Playback will start immediately. OR Press the Navigation buttons to select the Chapter Time, then use the Number buttons to select the desired Chapter Time (Hour/Minutes/Seconds); playback will start immediately.

Repeat Playback
While the disc is playing, press REPEAT/A-B button repeatedly to select a play mode: DVD play modes: Chapter repeat, Title repeat, A-B Repeat, Off CD play modes: Track repeat, All track repeat, A-B Repeat, Off VCD Mode (PBC control must be off): Track repeat, All track repeat, A-B Repeat, Off MP3 Mode: Track repeat, Folder repeat, Folder

PLAYBACK MODES

A-B Repeat
To repeat a segment between two points (A and B), press the REPEAT/A-B button three times to define the segment you want to repeat. Allow the disc to play to the end of the segment or use FORWARD to advance to the end point (B). Press the REPEAT/A-B button again at the end of the segment. The segment plays repeatedly until you press REPEAT/A-B to resume normal playback.

ADVANCED PLAYBACK OPTIONS

ANGLE MARK: While in the Playback mode, press the ANGLE button; the total number of angles will appear on the screen. Repeatedly press the ANGLE button to select the desired angle; the angle will change in one to two seconds. This is not available on all discs.

AUDIO (DVD AND VCD): Some discs have several audio tracks used for different languages or different audio formats. To change the language or audio format during play, press the AUDIO button one or more times to select one of the available audio formats or languages. For VCD select (Mono-left, Mono-right, Mix-mono, Stereo). **Note:** This option is only available if the disc offers a number of languages or formats.

PLAYBACK CONTROL (PBC): The Playback Control feature is available only on Video CDs. Press the DVD MENU/PBC button to turn the PBC feature on and off. The Playback Control feature supports the menus of the VCD format similar to a DVD menu.

MUTE: To mute the playback sound, press the MUTE button.

SUBTITLE MENU: Press the SUBTITLE menu button to select a subtitle language and the turn the subtitle menu on/off if your subtitle feature is available on the disc.

TITLE MENU: To display the title menu if available on the disc press the TITLE/RETURN menu button. Then use the Navigation buttons to select your desired option and press ENTER/PLAY button.

DISPLAY BUTTON: Each press of the DISPLAY button will display the elapsed time and remaining time of a playing disc. Each press of the DISPLAY button will cycle through, depending on the playback mode, as follows:

	DVD	CD/VCD
1st press	Title Elapsed Time	Single Elapsed Time
2nd press	Title Remaining Time	Single Remaining Time
3rd press	Chapter Elapsed Time	Total Elapsed Time
4th press	Chapter Remaining Time	Total Remaining Time
5th press	Off	Off

MP3: Press the DISPLAY button to select between the Track Elapsed Time and Track Remaining Time.

NOTE: For VCD, if the PBC is on, the Total Elapsed Time and Total Remaining Time will not be available.

Free Manuals Download Website

<http://myh66.com>

<http://usermanuals.us>

<http://www.somanuals.com>

<http://www.4manuals.cc>

<http://www.manual-lib.com>

<http://www.404manual.com>

<http://www.luxmanual.com>

<http://aubethermostatmanual.com>

Golf course search by state

<http://golfingnear.com>

Email search by domain

<http://emailbydomain.com>

Auto manuals search

<http://auto.somanuals.com>

TV manuals search

<http://tv.somanuals.com>