

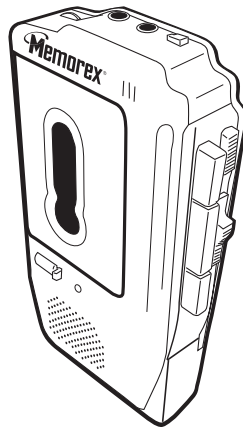

MB2190

User's Guide

Micro Cassette Recorder



**Before operating this product,
please read these instructions completely.**

LOCATION OF CONTROLS

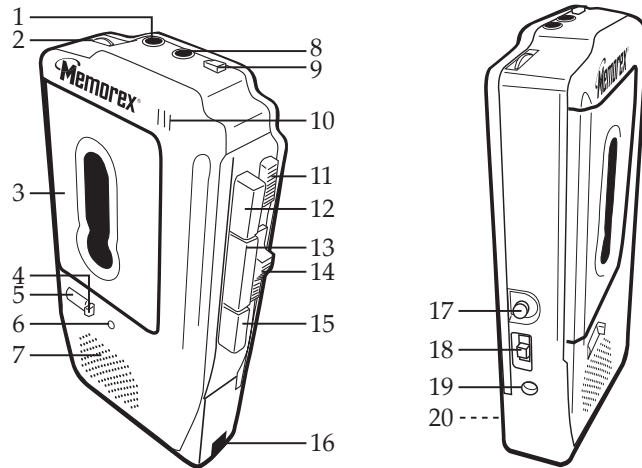

- | | |
|---|--|
| 1. MIC (Microphone) Jack | 11. PAUSE (ON/OFF) Switch |
| 2. VOLUME/VOX Mic Sensitivity Control | 12. Record Button |
| 3. Microcassette Compartment | 13. Play Button |
| 4. Tape Counter Reset Button | 14. REW (REV)/F.F (CUE) Switch Button |
| 5. Tape Counter | 15. Stop/Eject Button |
| 6. REC/BATT Indicator | 16. Hand Strap Hole/Hand Strap* |
| 7. Speaker | 17. CUE MARKER Button |
| 8. PHONES (Headphones) Jack | 18. TAPE SPEED (2.4/1.2) Switch |
| 9. VOX (Voice Activation) ON/OFF Switch | 19. DC 3V Jack $\ominus\oplus\oplus$ |
| 10. Built-in Microphone | 20. Battery Compartment (Rear of Unit) |

* **NOTE:** The hand strap is attached and cannot be removed from the unit.

POWER SOURCES

BATTERY INSTALLATION

Open the battery compartment and insert two (2) "AAA" size batteries (not included) following the polarity diagram. Put the battery compartment cover back into place.

NOTE: The REC/BATT indicator will brightly light during recording when batteries are fresh. When they are weak, the indicator will appear dim.

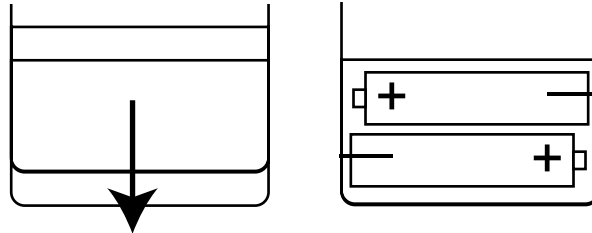

BATTERY PRECAUTIONS

Follow these precautions when using batteries in this device:

1. Use only the size and type of batteries specified.
2. Be sure to follow the correct polarity when installing the batteries as indicated in the battery compartment. Reversed batteries may cause damage to the device.
3. Do not mix different types of batteries together (e.g. Alkaline and Carbon-zinc) or old batteries with fresh ones.
4. If the device is not to be used for a long period of time, remove the batteries to prevent damage or injury from possible battery leakage.
5. Do not try to recharge batteries not intended to be recharged; they can overheat and rupture. (Follow battery manufacturer's directions.)

DC JACK

To use this unit with an external AC adapter (not included) having 3V and a positive center pin, insert the AC adapter's plug into the DC 3V jack on the unit. The batteries will be disconnected when the AC adapter is connected.

OPERATION

TO PLAY A PRERECORDED MICROCASSETTE TAPE

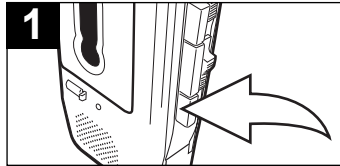

1 Press the Stop/Eject button and insert a microcassette tape with the side to be played facing you. Close the Cassette Compartment.

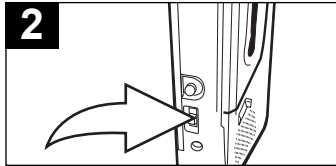

2 Slide the TAPE SPEED switch to the tape speed used when recorded.

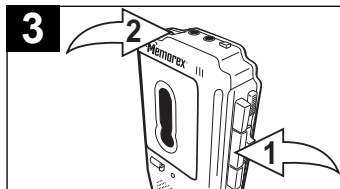

3 Press the Play button **▶** to start playback and adjust the VOLUME/VOX Mic Sensitivity control **⊕** as desired.

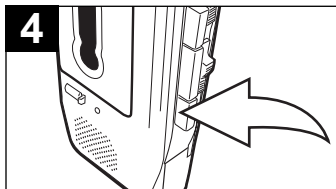

4 To stop the tape before it reaches the end, press the Stop/Eject button.

EARPHONE JACK

For private listening, connect an earphone (not included) to this jack. The speaker is automatically disconnected when the earphone plug is inserted in the jack.

OPERATION (CONTINUED)

TO FAST REWIND/REVIEW A MICROCASSETTE TAPE

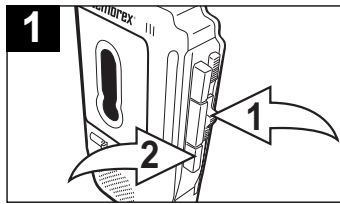

To rapidly rewind a microcassette tape in the Stop mode, slide the REW (REV)/F.F (CUE) switch ❶ to the REW (REV) position. Press the Stop/Eject button ❷ when you reached the desired position.

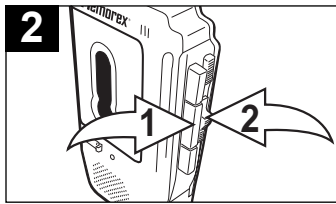

To rapidly review a microcassette tape, press the Play button ❶ and then slide and hold the REW (REV)/F.F (CUE) switch ❷ to the REW (REV) position. You will then hear the microcassette play at fast speed. Release the switch to resume normal playback.

TO FAST FORWARD/CUE A MICROCASSETTE TAPE

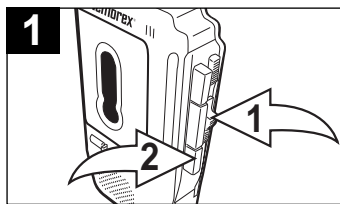

To rapidly forward a microcassette tape in the Stop mode, slide the REW (REV)/F.F (CUE) switch ❶ to the F.F (CUE) position. Press the Stop/Eject button ❷ when you reached the desired position.

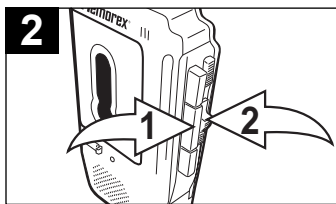

To rapidly cue a microcassette tape, press the Play button ❶ and then slide and hold the REW (REV)/F.F (CUE) switch ❷ to the F.F (CUE) position. You will then hear the microcassette play at fast speed. Release the switch to resume normal playback.

OPERATION (CONTINUED)

TO PAUSE A CASSETTE TAPE

This unit can pause the microcassette while Recording, Playback, Rewind or Fast Forward

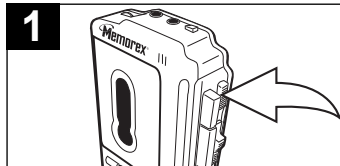

1
To pause Recording, Playback, Rewind or Fast Forward, slide the PAUSE switch to the ON position.

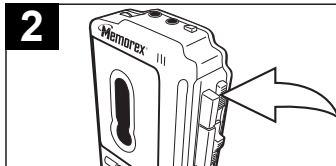

2
To resume, slide back to the OFF position.

TAPE COUNTER

The tape counter is helpful in locating particular portions of the tape.

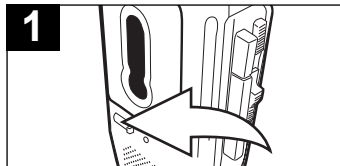

1
The tape counter will count up or down when playing, recording, fast forwarding or rewinding a microcassette tape.

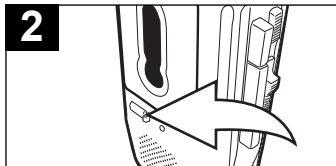

2
To reset the counter, press the Tape Counter Reset button; the counter will reset to "000"

TAPE SPEED SWITCH

Set the one of the following positions:

- 2.4: NORMAL SPEED: Compatible with most single-speed microcassette recorders. This setting has the best sound quality.
- 1.2: LONGER RECORDING: This will allow double recording time, but the sound quality will not be as good as when in the normal speed mode.

OPERATION (CONTINUED)

NORMAL RECORDING

This unit is capable of recording only when sound is heard. To use this feature, see the next page. For normal recording, follow the steps below.

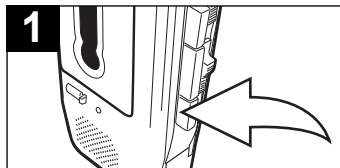

Press the Stop/Eject button and insert a microcassette tape with the side to be played facing you and the Erase Prevention Tab intact (see note below). Close the Cassette Compartment.

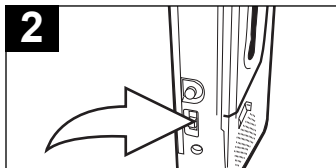

Slide the TAPE SPEED switch to the desired tape speed.

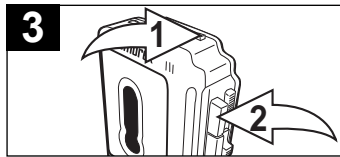

For constant recording, slide the VOX ON/OFF switch **1** to the OFF position and press the Record button **2** (the Play button will automatically depress) and the REC/BATT indicator will light.

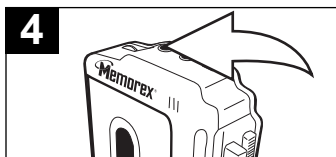

Speak into the built-in microphone or insert a microphone into the MIC jack and speak into it in a normal tone of voice.

IMPORTANT NOTE: If you cannot press the Record button, then there is either no tape inserted, or the erase prevention tab has been removed. See page 9 for details.

OPERATION (CONTINUED)

VOICE ACTIVATED (VOX) RECORDING

Voice activated recording will allow dictation only when you speak. When the unit detects a pause of a few seconds, it will temporarily stop recording until it detects sound again.

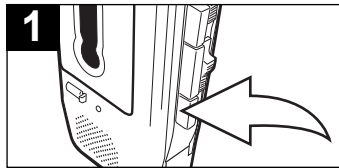

Press the Stop/Eject button and insert a microcassette tape with the side to be played facing you. Close the Cassette Compartment.

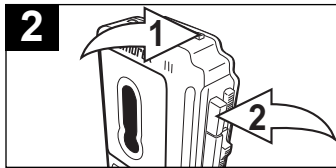

For Voice Activated Recording, slide the VOX ON/OFF switch **1** to the ON position and press the Record button **2** (the Play button will automatically depress).

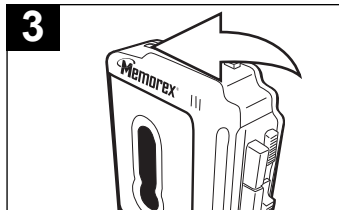

Speak into the built-in microphone or insert a microphone into the MIC jack and speak into it in a normal tone of voice. Adjust the VOLUME/VOX Mic Sensitivity control until your voice activates the recorder (REC/BATT indicator will light).

NOTES:

- The first few sounds activate the recorder and may not be recorded.
- A variation in voice level during recording will not stop the unit; two seconds of silence is required to stop the recording.
- For constant recording, see previous page.
- When recording, the VOLUME/VOX Mic Sensitivity control adjusts the microphone sensitivity. At 10, a soft sound will activate the recorder. At 0, a louder sound is required.

OPERATION (CONTINUED)

CUE MARKER

The cue marker will allow you to record a tone on the microcassette for easy locating after you record.

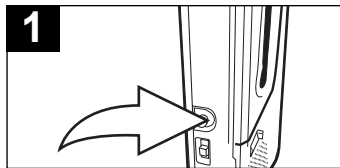

1 While recording, press and hold the CUE MARKER button for three seconds; a tone will then be recorded on the microcassette at that point.

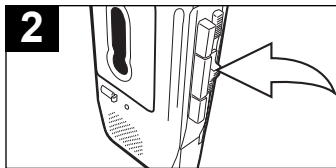

2 When playing the message back, the cue marker tone will NOT be heard at the point it was recorded.

Slide and hold the REW (REV)/F.F (CUE) switch to either the REW (REV) or the F.F (CUE) position during playing the message back; the unit will play back the recording at fast speed. You will be able to hear the Cue Marker humming sound when listening at fast speed.

CARE AND MAINTENANCE

SAFEGUARD AGAINST ACCIDENTAL ERASURE

When a new recording is made, any program material previously recorded is automatically erased and only the new recording remains. To safeguard valuable recordings from being erased accidentally, the cassette and the deck are equipped with a special device.

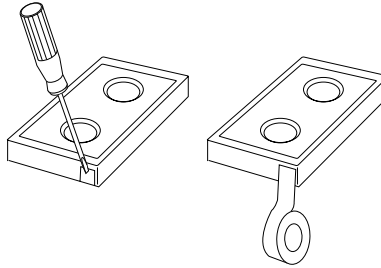

On the cassette there is an erase prevention tab on each side. To prevent accidental erasing, break out these tabs with a screwdriver. If only one side of the tape is to be protected, break out the tab on the left side with the side desired facing you.

To record on a tape in which the tab has been broken, place a piece of adhesive tape over that area.

NOTE: When a tab is broken out, the record button cannot be depressed.

CASSETTE TAPE RECOMMENDATIONS

Standard tape lengths have 15 (C-30), 30 (C-60) and 45 (C-90) minutes of recording time on each side. Longer length tapes of 60 (C-120) minutes of recording time on each side are not recommended. Use only high quality tapes. If a problem develops, check the unit first with another cassette to determine if the problem is with the cassette, and not with the unit.

If there is any slack in the tape in the cassette, it should be removed before inserting the cassette. Place a pencil in one of the hubs and rotate toward the outside of the cassette until all slack is taken up.

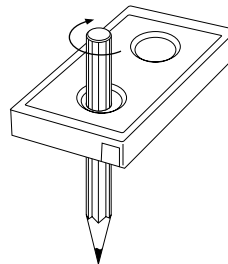

CARE AND MAINTENANCE (CONTINUED)

CLEANING

Clean the tape head, capstan and pinch roller using a cotton swab slightly moistened with alcohol. Avoid scratching the head surface. To clean the unit housing, use a soft cloth slightly dampened with water and wipe dry.

CAUTION: Never use chemicals such as benzene or paint thinner for cleaning, otherwise the case may be deformed or discolored.

Traffic Safety

- Do not use while operating a motorized vehicle. It may create a traffic hazard and is illegal in many areas.
- Even if your earphone is an open air type designed to let you hear outside sounds, do not turn the volume up so high that you cannot hear what is around you.
- Use extreme caution or temporarily discontinue use in potentially hazardous situations.

SPECIFICATIONS

Tape Speed 2.4cm/sec or 1.2cm/sec
Frequency Response 250-4500Hz
Speaker 25mm (8 Ohm)
Power Source 3V, "AAA" size x 2 batteries (Not Included)
Dimensions 119 x 65 x 23 mm
Weight 140g (without batteries)

Specifications are subject to change without notice.

**FOR ADDITIONAL SET-UP OR OPERATING
ASSISTANCE, PLEASE VISIT OUR WEBSITE AT
WWW.MEMOREXELECTRONICS.COM OR
CONTACT CUSTOMER SERVICE AT
1-800-919-3647**

**PLEASE KEEP ALL PACKAGING MATERIAL FOR
AT LEAST 90 DAYS IN CASE YOU NEED TO
RETURN THIS PRODUCT TO YOUR PLACE OF
PURCHASE OR MEMOREX.**

**FOR PARTS AND ACCESSORIES, CONTACT
FOX INTERNATIONAL AT 1-800-321-6993.**

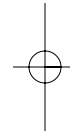
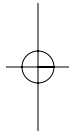

Memcorp, Inc.
Weston, FL
Printed in Hong Kong

Visit our website at
www.memorexelectronics.com

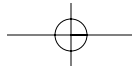

Free Manuals Download Website

<http://myh66.com>

<http://usermanuals.us>

<http://www.somanuals.com>

<http://www.4manuals.cc>

<http://www.manual-lib.com>

<http://www.404manual.com>

<http://www.luxmanual.com>

<http://aubethermostatmanual.com>

Golf course search by state

<http://golfingnear.com>

Email search by domain

<http://emailbydomain.com>

Auto manuals search

<http://auto.somanuals.com>

TV manuals search

<http://tv.somanuals.com>