

Memorex®

Is it live or is it Memorex?™

MMP8500

User's Guide

*Personal FM
Stereo MP3/
WMA Player*

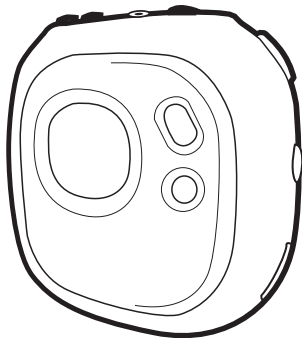

Before operating this product,

please read these instructions completely.

PRECAUTIONS

COPYRIGHT:

- Distributing copies of MP3 or WMA tracks without permission is a violation of international copyright laws.

SAFETY:

- Vibration experienced during walking or exercising will not affect the player. However, dropping the player or dropping a heavy object on the player may result in damage or sound distortion.
- Avoid spilling any liquid onto or into the player.
- Do not leave the player in a location near heat sources; in a location subject to direct sunlight, excessive dust, sand, moisture, rain or mechanical shock; on an unlevel surface; or in a car with the windows closed during periods of excessive heat.

ROAD SAFETY:

- Do not use headphones while driving, cycling or operating any motorized vehicle. It may create a traffic hazard and it is illegal in some areas. It can be potentially dangerous to play your headset at a high volume while walking, especially at pedestrian crossings. You should exercise extreme caution or discontinue use in potentially hazardous situations.

FCC WARNING:

- This equipment may generate or use radio frequency energy. Changes or modifications to this equipment may cause harmful interference unless the modifications are expressly approved in the instruction manual. The user could lose the authority to operate this equipment if an unauthorized change or modification is made.

Dear Customer:

Selecting fine audio equipment such as the unit you've just purchased is only the start of your musical enjoyment. Now it's time to consider how you can maximize the fun and excitement your equipment offers. This manufacturer and the Electronic Industries Association's Consumer Electronics Group want you to get the most out of your equipment by playing it at a safe level. One that lets the sound come through loud and clear without annoying blaring or distortion and, most importantly, without affecting your sensitive hearing.

Sound can be deceiving. Over time your hearing "comfort level" adapts to higher volumes of sound. So what sounds "normal" can actually be loud and harmful to your hearing. Guard against this by setting your equipment at a safe level BEFORE your hearing adapts.

To establish a safe level:

- Start your volume control at a low setting.
- Slowly increase the sound until you can hear it comfortably and clearly, and without distortion.

Once you have established a comfortable sound level:

- Set the dial and leave it there.

Taking a minute to do this now will help to prevent hearing damage or loss in the future. After all, we want you listening for a lifetime.

We Want You Listening For A Lifetime

Used wisely, your new sound equipment will provide a lifetime of fun and enjoyment. Since hearing damage from loud noise is often undetectable until it is too late, this manufacturer and the Electronic Industries Association's Consumer Electronics Group recommend you avoid prolonged exposure to excessive noise. This list of sound levels is included for your protection.

Decibel

Level

Example

30	Quiet library, soft whispers
40	Living room, refrigerator, bedroom away from traffic
50	Light traffic, normal conversation, quiet office
60	Air conditioner at 20 feet, sewing machine
70	Vacuum cleaner, hair dryer, noisy restaurant
80	Average city traffic, garbage disposals, alarm clock at two feet

THE FOLLOWING NOISES CAN BE DANGEROUS UNDER CONSTANT EXPOSURE:

90	Subway, motorcycle, truck traffic, lawn mower
100	Garbage truck, chain saw, pneumatic drill
120	Rock band concert in front of speakers, thunderclap
140	Gunshot blast, jet engine
180	Rocket launching pad

Information courtesy of the Deafness Research Foundation.



LOCATION OF CONTROLS

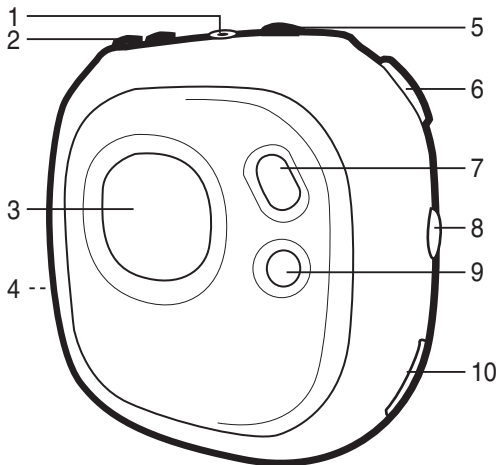

1. Headphone Jack
2. VOLUME +/- Buttons
3. Display
4. Battery Compartment and SD/MMC Memory Card Slot (Side of Unit)
5. PRESET/Power On-Off/Stop Button
6. Function Switch (Play, Pause, Skip+/-, Tuning +/-)
7. MODE Button (Main Menu/Setting)
8. LOCK Switch
9. EQ/REPEAT Button
10. USB Jack

BATTERY INSTALLATION

When the bars in the battery indicator (in the display) become low (see figure 1), replace the battery as follows.

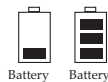

Figure 1

1. Open the battery door by sliding it towards the bottom of the unit as shown in figure 2.
2. Flip the battery plate upward and insert one (1) “AAA” cell battery (included) as shown in figure 3. Alkaline batteries are recommended for the longest playing time.
3. Flip the battery plate to its original position as shown in figure 4 and slide the battery door back on.

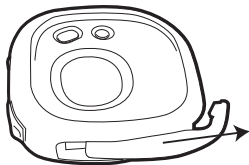

Figure 2

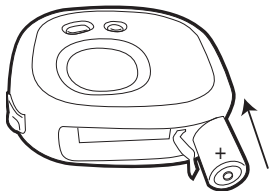

Figure 3

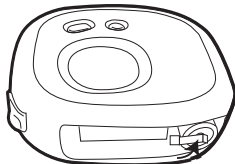

Figure 4

BATTERY PRECAUTIONS

Follow these precautions when using batteries in this device:

1. Use only the size and type of batteries specified.
2. Be sure to follow the correct polarity when installing the battery as indicated. Reversed batteries may cause damage to the device.
3. If the device is not to be used for a long period of time, remove the battery to prevent damage or injury from possible battery leakage.
4. Do not try to recharge batteries not intended to be recharged; they can overheat and rupture. (Follow battery manufacturer's directions.)

INSTALLATION (CONTINUED)

ARM STRAP

1

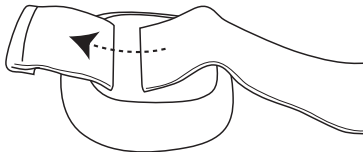

Insert the arm strap into the slot on the rear of the unit and pull through.

2

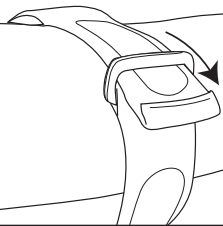

Pull the arm strap and insert it into the buckle.

3

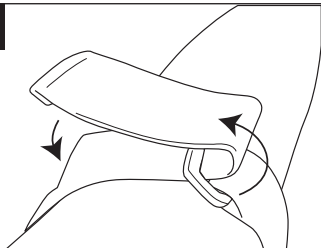

Pull the strap and fold over, then fasten the velcro.

HEADPHONE JACK:

Turn on the unit and set the volume to low. Insert the headphone's plug into the Headphone jack.

DOWNLOADING AND TRANSFERRING FILES

TO INSTALL THE "DIGITAL AUDIO PLAYER" CD SOFTWARE

For Windows98 or 98SE:

The USB mass storage function will not be activated without driver installation. To activate the USB mass storage function, please use the installation CD-Rom to install the driver.

For Windows ME, Windows2000 or Windows XP:

Windows will automatically detect the Audio player without installing the CD software when the USB cable is connected. But to Format the player, update the driver or to uninstall the software, you must install the CD software.

For Macintosh OSX:

Macintosh OSX will automatically detect the Audio player without installing the CD software . Do not install the software when using a Macintosh.

If you are connecting your player to your computer for the first time, please follow these instructions:

Procedure to Install Player Driver

1. Insert the Installation CD-ROM into the CD Drive. Then the Auto-run program will start to install the driver automatically.



NOTE: If the setup does not start, please run the setup.exe in the CD-ROM Drive directory. Click setup.exe on the installation CD.

Download from [Www.Somanuals.com](http://www.Somanuals.com). All Manuals Search And Download.

DOWNLOADING AND TRANSFERRING FILES (CONTINUED)

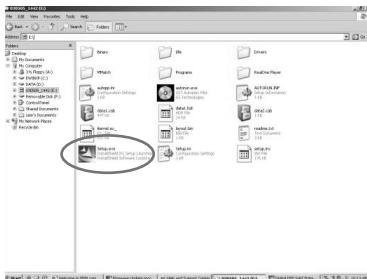

2. Follow the on screen instructions to install the driver. Please install the Player driver in the directory "C:\Program Files\Memorex\Digital Audio Player".

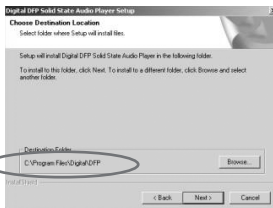

WARNING: DO NOT change the installation path for the "Memorex Solid State Digital Audio Player". Otherwise, the driver will not run properly.

3. After successfully installing the driver, you must restart windows.

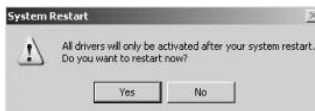

DOWNLOADING AND TRANSFERRING FILES (CONTINUED)

- 4 After installation has completed, the "Memorex Solid State Digital Audio Player" will be added to the Program folder.

TRANSFERRING FILES

You can download MP3 files from the internet or use encoding software to convert music that you have on an audio CD into MP3 formats. Once these files are stored on your computer you can easily copy them to your MMP8500.

Connect the computer to your MMP8500 player using the supplied USB cable.

Press the POWER button to turn the unit on; the following will be displayed in the LCD screen of your MMP8500:

A "Removable Disk" window will automatically pop up on your computer screen. If a SD/MMC memory card has been inserted (see page 14), another folder will appear on your computer screen to represent the card.

To add more files and songs to your player simply drag and drop MP3, WMA or WAV files from anywhere on your computer into the "Removable Disk" window.

When you are finished, see the Safely Remove Hardware procedure on page 10 before disconnecting the MMP8500.

Download from www.Somanuals.org. All Manuals Search And Download.



DOWNLOADING AND TRANSFERRING FILES (CONTINUED)

SAFELY REMOVING YOUR PLAYER FROM THE COMPUTER

NOTE: To avoid damage to your player or data loss, always follow the procedure listed below before disconnecting the USB cable from your computer or disconnecting the player from the USB cable.

Using your mouse, double click the "Safely Remove Hardware" icon on the task bar.



From the "Safely Remove Hardware" window, select "USB Mass Storage Device" and click the "Stop" button. The "Stop a Hardware Device" window will pop up as shown:

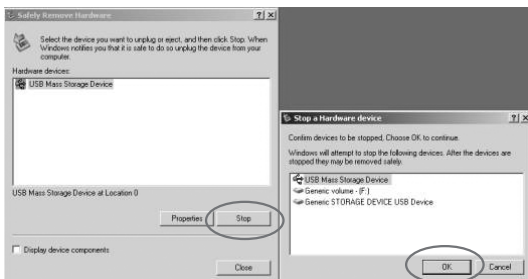

Click "OK" and when a "Safe to Remove Hardware" window is displayed and you may remove the player from the USB cable or remove the USB cable from the computer.



DOWNLOADING AND TRANSFERRING FILES (CONTINUED)

FORMATTING THE PLAYER

NOTE: All files will be deleted when the player is formatted.

With the player turned off, connect the player and PC using the supplied USB cable. Press the POWER button to turn the unit on.

Click "Start" on the taskbar and select "Programs". From the Program menu, select "Memorex Solid State Digital Audio Player", and then click "Format"; a format dialogue box will pop up, click "Start" and the application program will format the player.

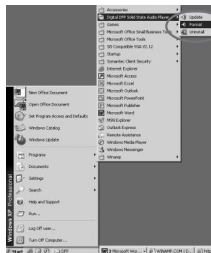

Once the format has completed, click "Close" to exit the format program.

TO SAFELY REMOVE YOUR PLAYER

Double click the "Safe Removal" icon to display the "Unplug or Eject Hardware" window. Select the device you want to remove and click the "Stop" button.

Click "OK" and when a "Safe to Remove Hardware" window is displayed and you may remove the player from the USB cable or remove the USB cable from the computer.

DOWNLOADING AND TRANSFERRING FILES (CONTINUED)

UPDATING THE FIRMWARE (You must first connect your unit to your computer)

Occasionally, Memorex may release new software (firmware) for this unit enhancing its functionality.

1. Go to www.memorexelectronics.com to download the latest firmware.
2. Unzip the firmware into the `C:\Program Files\Memorex\Digital Audio Player` directory (if this is the one selected when installing the drivers).
3. While the unit is off, connect the USB cable as described previously.
4. Click on START and select PROGRAM. From the PROGRAM folder, select Memorex Solid State Digital Audio Player, then click on UPDATE; the Update dialog box will appear with the following message: Please place your MP3 device into recovery mode to continue
5. Press and hold the PRESET/Power On-Off/Stop button. Wait until you see the dialog box begin to load, then release the button; in a few seconds you will see the update screen appear with the new version.
6. Click on START and the application will begin to download the firmware to your player. If a dialog box appears on the screen, select YES for updating and Formatting the unit (this will delete the files in the unit) or select NO for updating the unit without formatting the unit.

REALONE PLAYER INSTALLATION (PC ONLY):

1. Insert the Installation CD.
2. Click on START and select PROGRAM. From the PROGRAM folder, select Windows Explorer.
3. Select the directory of Windows Explorer and click on the folder of RealOne Player; various versions in different languages of the application will be displayed.
4. Double click the version that you want to install; the installation will then begin automatically. For the English version, please double click the "RealOnePlayerV2Gold_en" file to begin installation.
5. Follow the RealOne InstallWizard online prompts to complete the installation.

NOTE: Before saving tracks to your RealOne player, open the RealOne player and click on "CD" at the bottom of the screen. Next, click on Preferences; select MP3 audio as the format, then click "OK". This will ensure the music is recorded in the correct format for the MMP8500 to read.

DOWNLOADING AND TRANSFERRING FILES (CONTINUED)

INSTRUCTIONS FOR DOWNLOADING SONGS FROM THE COMPUTER USING REALONE SOFTWARE

- 1 Install the Real One Software.
- 2 When the unit is on, connect the USB cable to the MP3 Player and the USB port of the computer. Once the USB cable is connected to the player "Mass Storage" will be displayed on the LCD display for approximately three seconds.
- 3 To make sure the computer recognizes the MP3 player, double click on MY COMPUTER, and check for a drive called Removable disk. Double click on Removable Disk, and make sure the Capacity is equal to 122MB, and minimize this window.
- 4 Insert a Music CD into the CD-ROM drive of your computer, and open Real One Media Browser. Next, click on the CD icon on the bottom tool bar of the Media Browser. Click on preferences, choose MP3 Audio, and 96Kbps Stereo and click OK.
- 5 Click the "Save Tracks" icon on the bottom menu bar to open the "Select Tracks" dialog box. Select the desired tracks on the CD and click "OK" to save the tracks into My Library; "Pending" will appear at the end of the tracks' name and "Saved" will show after the tracks' name when finished saving. Choose "My library" from the Menu Bar and double click on the yellow folder (Show organizer). Double click on the "All Media" (view your entire library) to view a list of the saved songs.
- 6 Click on the Yellow plus (+) sign on the left bottom tool bar and click on "Add File" to add the tracks to the MP3 player. Once you click on Add File, another dialog box will appear on your screen, double click on the name of the CD that you want to load into your MP3 player and highlight all of the songs. Right click on the songs and select "Send To", then click on the MP3 player. If you do not see your MP3 player, click on Copy to copy the songs.
- 7 Open the Removable disk window, right click to open another dialog box and click on paste to load your songs into your MP3 player. Once you paste the songs, you will notice that the MP3 display will show files transferred into the box which means your files are been loaded into the player.
- 8 Once the files are finished loading into the player, disconnect the USB cable, insert headphones and listen to your music.

DOWNLOADING AND TRANSFERRING FILES (CONTINUED)

EXTERNAL MEMORY CARD

TO AVOID DAMAGE, make sure the unit is off before inserting or removing the card.

1. Open the battery compartment door by sliding it towards the bottom of the unit, as shown in figure 1.
2. Insert a SD/MMC memory card (not included) up to 512MB, facing up as shown in figure 2.
3. Connect the USB cable as described previously.
4. Drag MP3 and WMA files into the new folder. The memory card indicator will appear at the bottom left corner on the display.
5. To remove the SD/MMC memory card, push the edge of the card as shown in figure 3, then the card will spring out. Carefully remove the card.

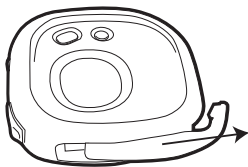

Figure 1

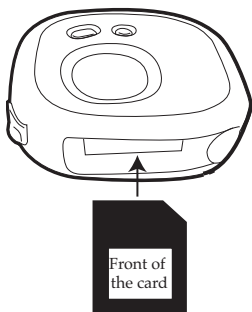

Figure 2

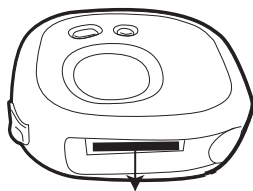
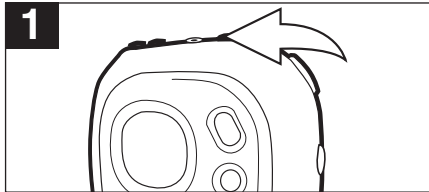

Figure 3

OPERATION

TURNING THE POWER ON



Turn the unit on by pressing the PRESET/Power button; the Memorex start screen will appear in the display temporarily. To turn the unit off, press and hold the PRESET/Power button; "Holding to Power Off" will appear in the display. When the unit turns off, release the PRESET/Power button.

LOCK SWITCH

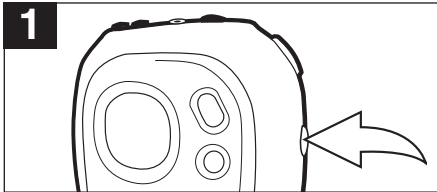

Slide the LOCK switch to the Lock (down) position; the lock indicator will appear in the display and no buttons will be able to be pressed. This is useful when you do not want the station/track changed by accidentally pressing a button. Slide the LOCK switch to the Unlock (up) position to cancel the Lock function.

EQ

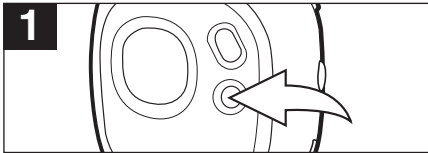

While playing MP3s, press and hold the EQ/REPEAT button until the EQ display text becomes highlighted. Then, repeatedly press the EQ/REPEAT button to select the desired EQ setting: NORM (Normal), ROCK, UBAS (Ultra Bass), JAZZ, CLAS (Classical) or POP. Wait two seconds and the unit will exit EQ setting mode.

NOTES:

- If you attempt to turn the power on while the LOCK switch is in the Lock (down) position, the unit will show "HOLD" and then turn off.
- The EQ feature is only available when playing MP3/WMA files.

OPERATION (CONTINUED)

TO LISTEN TO THE FM RADIO

1

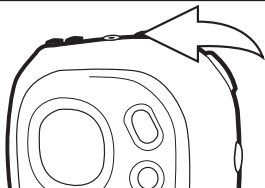

Turn the unit on by pressing the PRESET/Power button; the Memorex start screen will appear in the display temporarily.

2

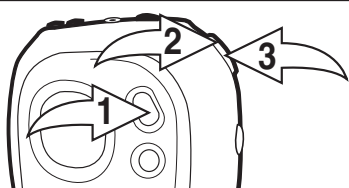

Press the MODE button ❶; the Main menu will appear in the display. Within six seconds, push the Function switch towards ►► ❷ until FM RADIO is selected, then press the Function switch ◀◀ ❸ to the Play/Pause position to select it.

3

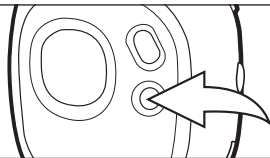

When a station is broadcasting in stereo, press the EQ/REPEAT button until STEREO appears in the display to listen in stereo. Press the EQ/REPEAT button again until the word STEREO disappears to listen in mono. If the station is not strong enough, or not broadcasting in stereo, the indicator will not appear.

4

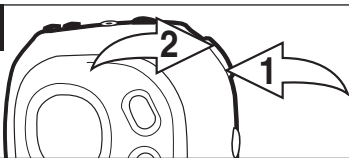

Push and release the Function switch towards ◀◀ ❶ or ►► ❷ to tune a station. For rapid search tuning, push and hold the Function switch towards ◀◀ ❶ or ►► ❷ for one second, then release; the unit will automatically search and stop on the next strongest station.

CONTINUED ON THE NEXT PAGE

OPERATION (CONTINUED)

5

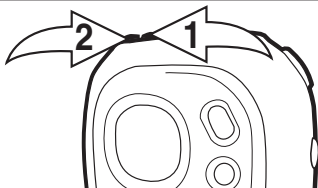

Press the VOLUME + button ❶ to increase the volume or the VOLUME - button ❷ to decrease the volume.

6

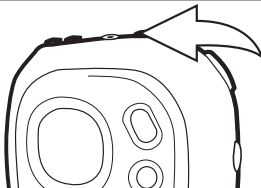

To turn the unit off, press and hold the PRESET/Power button until the unit turns off.

ANTENNA

FM – The headphones act as an antenna for FM. Extend the headphone wire for best FM reception.

OPERATION (CONTINUED)

TO MANUALLY SET A STATION INTO MEMORY

1

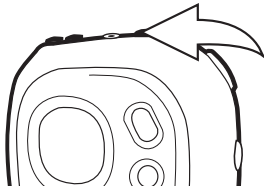

Make sure the PRESET indicator does not appear in the display. If it does, press the PRESET/Power button and the PRESET indicator will disappear. Tune a desired station as described in the previous section.

2

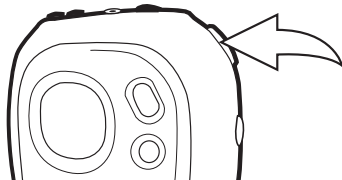

Push the Function switch; "STORE" will appear in the display.

3

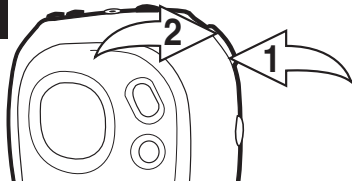

Select a preset number ("C01" to "C10") by pushing the Function switch towards ◀◀ ❶ or ▶▶ ❷.

4

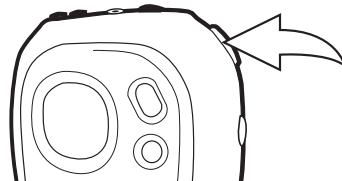

When the desired memory number appears, push the Function switch to store the preset; "STORE" will disappear from the display and the station will be set into memory.

OPERATION (CONTINUED)

TO AUTOMATICALLY SET STATIONS INTO MEMORY

1

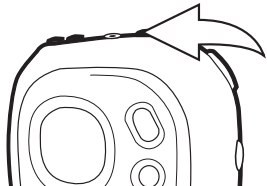

Make sure the PRESET indicator does not appear in the display. If it does, press the PRESET/Power button and the PRESET indicator will disappear.

2

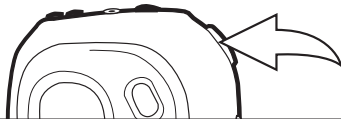

Press and hold the Function switch until "AUTO SCAN" appears in the display. The unit will automatically store the ten next strong stations into memory. New FM Stations will overwrite previous presets.

NOTE: If less than ten stations have been scanned into the memory, the memory will keep at a frequency with 87.5MHz

TO RECEIVE MEMORY PRESETS

1

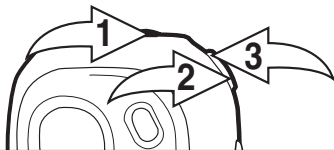

Press the Preset/POWER On-OFF/Stop button ❶; "PRESET" will appear in the display. Select a preset number by pushing the Function switch towards ◀❷ or ▶❸. Press the Preset/POWER On-OFF/Stop button ❶ to exit the preset mode, "PRESET" indicator will not disappear from the display

OPERATION (CONTINUED)

TO LISTEN TO MP3s/WMA's

1

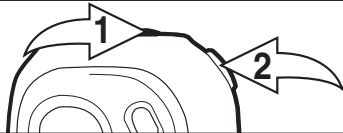

Turn the unit on by pressing the PRESET/Power button ❶; the Memorex start screen will appear in the display temporarily. Press the Function switch ❷ to the Play/Pause position to start playing the MP3/WMA files. The MP3 information will scroll across the display, the Bit Rate and EQ setting will alternate at the bottom of the display and the song number and timer will appear at the top of the display.

2

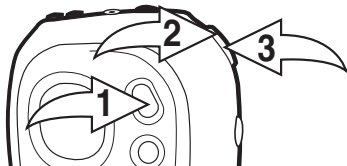

If the unit is in the Radio or Stop Watch mode, press the MODE button ❶; the Main menu will appear in the display. Within six seconds, push the Function switch towards ►► cⓂ until MUSIC PLAYER is selected, then press the Function switch ❷ to select it.

3

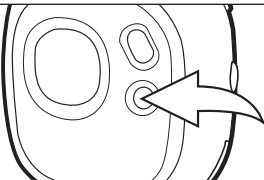

While playing MP3s, press and hold the EQ/REPEAT button until the EQ display text becomes highlighted. Then, repeatedly press the EQ/REPEAT button to select the desired EQ setting: NORM (Normal), ROCK, UBAS (Ultra Bass), JAZZ, CLAS (Classical) or POP. Wait two seconds and the unit will exit EQ setting mode.

4

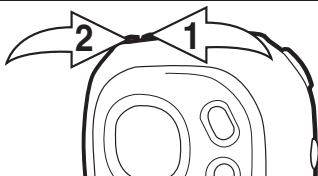

Press the VOLUME + button ❶ to increase the volume or the VOLUME - button ❷ to decrease the volume.

CONTINUED ON THE NEXT PAGE

OPERATION (CONTINUED)

5

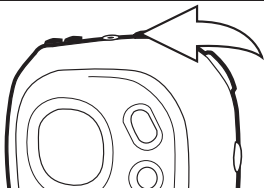

Press the PRESET/Power button to stop MP3/WMA playback.

NOTE:

- See pages 7 through 12 for information on uploading MP3 and WMA files to this unit.

TO PAUSE PLAYBACK

1

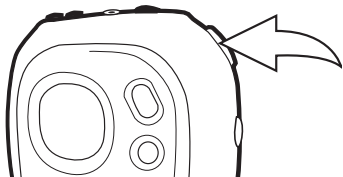

During playback, if you wish to pause the file momentarily, push the Function switch; playback will pause and the timer will stop counting.

2

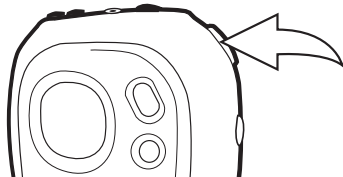

Push the Function switch again to resume playback; the sound will return and the timer will start counting again.

OPERATION (CONTINUED)

FORWARD/REVERSE SKIP

1



During playback, push the Function switch towards ►► to advance the player to the beginning of the next file. Push the Function switch towards ►► repeatedly to advance the player to higher number files.

2



During playback, push the Function switch towards ◀◀ to move the player back to the beginning of the currently playing file. Push the Function switch towards ◀◀ repeatedly to move the player back to lower numbered files.

HIGH-SPEED MUSIC SEARCH

1

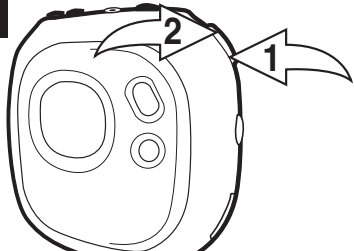

During playback, push and hold the Function switch towards ◀◀ ① or ►► ② to move the player forward or backward within a file to locate a specific musical passage. The player will move forward or backward at high speed as long as the the Function switch is held. When you release the Function switch, normal playback will resume.

OPERATION (CONTINUED)

REPEAT PLAYBACK OF A FILE

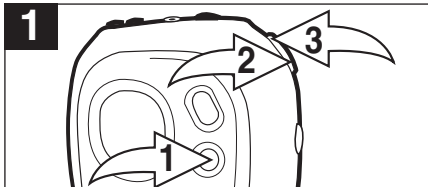

To repeat a single file, press the EQ/REPEAT button **1** once while playing a file; “.T” will appear in the display. Press the Skip/Search **2** or **3** button to select the specific track that you wish to repeat.

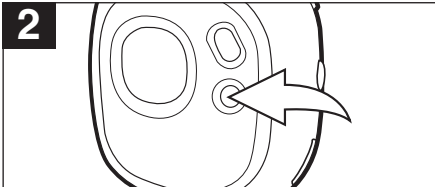

The specific track you selected will be repeated continuously. To cancel Repeat playback, press the EQ/REPEAT button until the Mode indicator disappears.

REPEAT PLAYBACK OF ALL FILES

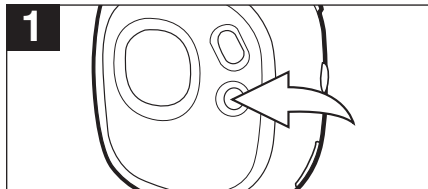

To repeat all files, press the EQ/REPEAT button twice while playing a file; “.A” will appear in the display.

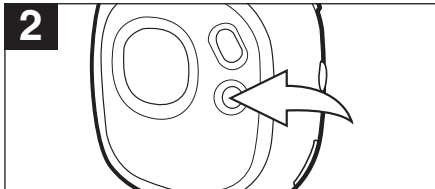

All tracks on the disc will be repeated continuously. To cancel Repeat playback, press the EQ/REPEAT button until the Mode indicator disappears.

OPERATION (CONTINUED)

TO RANDOMLY PLAY ALL THE FILES AND THEN STOP

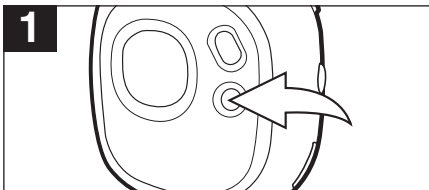

To randomly play all the files and then stop, press the EQ/REPEAT button three times while playing a file; “s” will appear in the display.

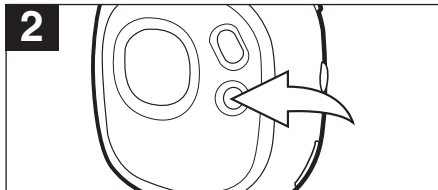

The unit will play all the tracks in random order. When all the tracks have been played, the unit will stop. To cancel Random playback, press the EQ/REPEAT button until the Mode indicator disappears.

TO RANDOMLY PLAY ALL THE FILES CONTINUOUSLY

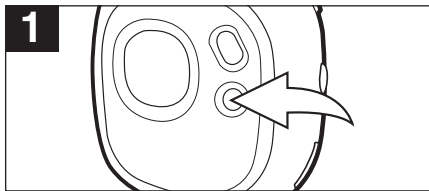

To randomly play all the files continuously, press the EQ/REPEAT button four times while playing a file; “3” will appear in the display.

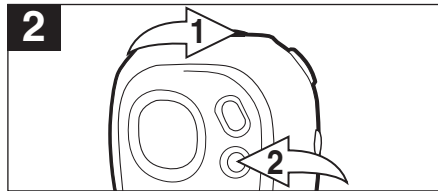

The unit will play all the tracks in random order until the PRESET/Power button ❶ is pressed (top stop playback). To cancel Random playback, press the EQ/REPEAT button ❷ until the Mode indicator disappears.

OPERATION (CONTINUED)

USING THE STOP WATCH

1

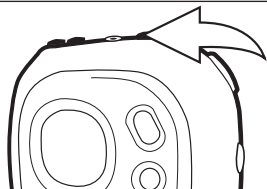

Turn the unit on by pressing the PRESET/Power button; the Memorex start screen will appear in the display temporarily.

2

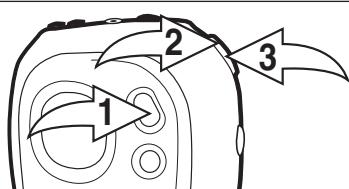

Press the MODE button ❶; the Main menu will appear in the display. Within six seconds, push the Function switch towards ►► ❷ until STOP WATCH is selected, then press the Function switch ❸ to select it.

3



Press the Function switch to start the timer; the timer will then start counting up. Press the Function switch to stop the timer; the timer will then stop counting. Press the Function switch to start the timer up again.

4

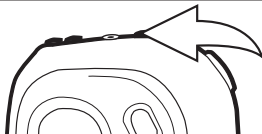

Press the PRESET/Power button to reset the timer to "00:00:00".

NOTES:

- The MP3/WMA files can still be played back while using the stop watch. When listening to MP3/WMAs (see page 20), follow steps 2 through 4 above to operate the stop watch.
- To turn off MP3/WMA playback when in the Stop watch mode, you need to turn off the unit or change the unit back to MP3 mode.

OPERATION (CONTINUED)

TO CHANGE THE SETTINGS

1

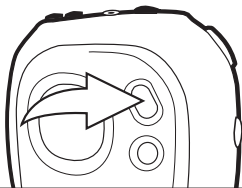

Press and hold the MODE button until the Setting menu appears in the display.

2

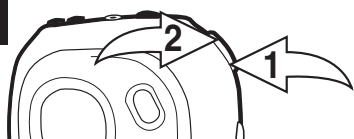

Within six seconds, select one of the settings by pushing the Function switch towards **◀◀ 1** or **▶▶ 2**.

CONTRAST: Adjust the contrast.

EQUALIZER: Select the EQ setting.

PLAY TIMER: Set Elapsed or Remaining Time, which will appear when playing a file.

LIGHT TIMER: Set the time the backlight will remain on after activated.

3

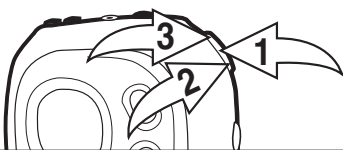

Push the Function switch **1** to select the setting; the respective menu will appear. Adjust the setting by pushing the Function switch towards **◀◀ 2** or **▶▶ 3**. When the desired setting is done, push the Function switch **1** again to confirm.

TROUBLESHOOTING GUIDE

If you experience a problem with this unit, check the chart below before calling for service.

SYMPTOM	CAUSE	SOLUTION
Unit will not turn on.	Dead battery, or not installed properly.	Replace battery and install properly.
	LOCK switch is in the Lock (down) position.	Slide switch to the Unlock (up) position.
No sound.	Headphones are not inserted.	Insert headphones.
	Volume is set too low.	Raise the volume using the VOLUME + button.
	The MP3 or WMA files are corrupted.	Download uncorrupted files.
FM distorted.	Station not tuned.	Retune station and extend headphone wire.
Download Failure.	Damaged USB cable.	Replace cable.
The computer is not recognizing the MMP8500.	The MMP8500 must be turned on.	Turn the MMP8500 on.
	The USB cable is not securely connected.	Make sure USB cable is securely connected.
	Driver is not installed or computer is not compatible.	Install driver and/or see pages 7 through 12 for compatibility.

TROUBLESHOOTING GUIDE (CONTINUED)

There are rare instances when after downloading the firmware the player will not turn on; in these cases the unit will need to be reset. To reset the unit, perform the following steps:

1. Click on the START button of your computer.
2. Select PROGRAM.
3. Select Memorex Solid State Digital Audio Player.
4. Click on UPDATE.
5. The Update screen will appear with the following message: "Please place your MP3 device into recovery mode to continue".
6. Open the battery compartment on the player and lift the positive connector from the positive end of the battery.
7. Connect the USB cable to your computer and the other end to the MMP8500.
8. Connect the positive connector back on the battery.
9. Press and hold the POWER button; the dialog box will begin to load.
10. Release the button and the update screen will appear.
11. Click on Start to initiate the loading of the firmware. If a dialog box appears on the screen, select YES for updating and Formatting the unit (this will delete all the files in the unit) or select NO for updating the unit without formatting the unit.
12. When the loading is complete, click on CLOSE, and the unit is now fully functional.

SPECIFICATIONS

AUDIO

Frequency Range	20Hz-20KHz
Headphone Output	20mW, 16 ohm (max volume)
S/N Ratio	85dB (MP3)

FILE SUPPORT

File Type.....	MPEG 1/2/2.5 Layer 3, WMA
Bit Rate.....	8Kbps-320Kbps
Tag Info.....	ID3 Tag

FM TUNER

FM Frequency Range	87.5MHz-108MHz
Antenna	Headphone Cord

GENERAL:

Dimensions	0.95 x 2.5 x 2.75 inches
Weight	35g (without battery)
Battery	1 AAA size alkaline
LCD.....	Full Graphics with Backlight
Language	English
USB	USB 1.1
External Memory	SD or MMC
Built-in Memory.....	128MB
Maximum Play Time.....	Approx 10 hours (128Kbps, MP3)
Supported OS.....	Win ME, Win 2000, Win XP, Mac OSX
Firmware Upgrade.....	Yes (except Win 98 or Mac)
Operating Temperature	-5° to 40°C

Specifications are subject to change without notice.

**FOR ADDITIONAL SET-UP OR OPERATING ASSISTANCE,
PLEASE VISIT OUR WEBSITE AT
WWW.MEMOREXELECTRONICS.COM
OR CONTACT CUSTOMER SERVICE AT 1-800-919-3647.**

**PLEASE KEEP ALL PACKAGING MATERIAL FOR AT LEAST 90
DAYS IN CASE YOU NEED TO RETURN THIS PRODUCT TO YOUR
PLACE OF PURCHASE OR TO MEMOREX.**

**FOR PARTS AND ACCESSORIES, CONTACT FOX INTERNATIONAL
AT 1-800-321-6993.**

Memcorp, Inc.
Weston, FL
Printed in China

Visit our website at www.memorexelectronics.com

Free Manuals Download Website

<http://myh66.com>

<http://usermanuals.us>

<http://www.somanuals.com>

<http://www.4manuals.cc>

<http://www.manual-lib.com>

<http://www.404manual.com>

<http://www.luxmanual.com>

<http://aubethermostatmanual.com>

Golf course search by state

<http://golfingnear.com>

Email search by domain

<http://emailbydomain.com>

Auto manuals search

<http://auto.somanuals.com>

TV manuals search

<http://tv.somanuals.com>