

Memorex®

Is it live or is it Memorex?™

MMP8570

User's Guide

*Personal FM Stereo
MP3/WMA Player*

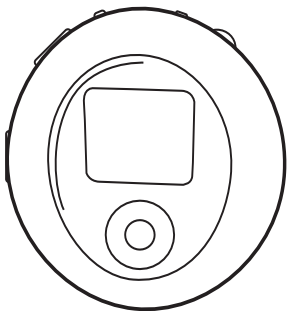

Before operating this product,

please read these instructions completely.

PRECAUTIONS

COPYRIGHT:

- Distributing copies of MP3, WMA, WMA with DRM tracks without permission is a violation of international copyright laws.

SAFETY:

- Vibration experienced during walking or exercising will not affect the player. However, dropping the player or dropping a heavy object on the player may result in damage or sound distortion.
- Avoid spilling any liquid onto or into the player.
- Do not leave the player in a location near heat sources; in a location subject to direct sunlight, excessive dust, sand, moisture, rain or mechanical shock; on an unlevel surface; or in a car with the windows closed during periods of excessive heat.

ROAD SAFETY:

- Do not use headphones while driving, cycling or operating any motorized vehicle. It may create a traffic hazard and it is illegal in some areas. It can be potentially dangerous to play your headset at a high volume while walking, especially at pedestrian crossings. You should exercise extreme caution or discontinue use in potentially hazardous situations.

FCC WARNING:

- This equipment may generate or use radio frequency energy. Changes or modifications to this equipment may cause harmful interference unless the modifications are expressly approved in the instruction manual. The user could lose the authority to operate this equipment if an unauthorized change or modification is made.

FCC DECLARATION

This device complies with Part 15 of the FCC rules. Operation is subject to the following two conditions: 1) This device may not cause interference, and 2) This device must accept any interference received, including interference that may cause undesired operation.

Warning: Changes or modifications to this unit not expressly approved by the party responsible for compliance could void the user's authority to operate the equipment.

NOTE: This equipment has been tested and found to comply with the limits for a Class B digital device, pursuant to Part 15 of the FCC Rules. These limits are designed to provide reasonable protection against harmful interference in a residential installation. This equipment generates, uses and can radiate radio frequency energy and, if not installed and used in accordance with the instructions, may cause harmful interference to radio communications.

However, there is no guarantee that interference will not occur in a particular installation. If this equipment does cause harmful interference to radio or television reception, which can be determined by turning the equipment off and on, the user is encouraged to try to correct the interference by one or more of the following measures:

- Reorient or relocate the receiving antenna.
- Increase the separation between the equipment and receiver.
- Connect the equipment into an outlet on a circuit different from that to which the receiver is connected.
- Consult the dealer or an experienced radio/TV technician for help.

Shield cable must be used with this unit to ensure compliance with class B FCC limits.

Dear Customer:

Selecting fine audio equipment such as the unit you've just purchased is only the start of your musical enjoyment. Now it's time to consider how you can maximize the fun and excitement your equipment offers. This manufacturer and the Electronic Industries Association's Consumer Electronics Group want you to get the most out of your equipment by playing it at a safe level. One that lets the sound come through loud and clear without annoying blaring or distortion and, most importantly, without affecting your sensitive hearing.

Sound can be deceiving. Over time your hearing "comfort level" adapts to higher volumes of sound. So what sounds "normal" can actually be loud and harmful to your hearing. Guard against this by setting your equipment at a safe level BEFORE your hearing adapts.

To establish a safe level:

- Start your volume control at a low setting.
- Slowly increase the sound until you can hear it comfortably and clearly, and without distortion.

Once you have established a comfortable sound level:

- Set the dial and leave it there.

Taking a minute to do this now will help to prevent hearing damage or loss in the future. After all, we want you listening for a lifetime.

We Want You Listening For A Lifetime

Used wisely, your new sound equipment will provide a lifetime of fun and enjoyment. Since hearing damage from loud noise is often undetectable until it is too late, this manufacturer and the Electronic Industries Association's Consumer Electronics Group recommend you avoid prolonged exposure to excessive noise. This list of sound levels is included for your protection.

Decibel

Level

Example

30	Quiet library, soft whispers
40	Living room, refrigerator, bedroom away from traffic
50	Light traffic, normal conversation, quiet office
60	Air conditioner at 20 feet, sewing machine
70	Vacuum cleaner, hair dryer, noisy restaurant
80	Average city traffic, garbage disposals, alarm clock at two feet

THE FOLLOWING NOISES CAN BE DANGEROUS UNDER CONSTANT EXPOSURE:

90	Subway, motorcycle, truck traffic, lawn mower
100	Garbage truck, chain saw, pneumatic drill
120	Rock band concert in front of speakers, thunderclap
140	Gunshot blast, jet engine
180	Rocket launching pad

Information courtesy of the Deafness Research Foundation.



LOCATION OF CONTROLS

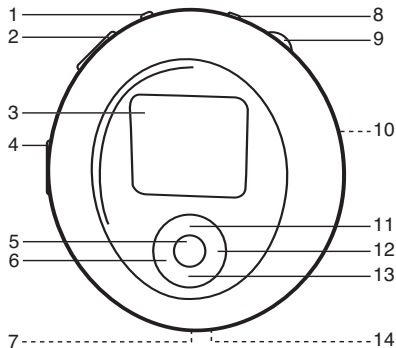

1. Menu/Lock Button
2. VOLUME +/- Buttons
3. Display
4. PRESS TO OPEN Button
5. PLAY/PAUSE ►|| Button
6. Navigation ◀/Skip/Search ◀◀ Button
7. Headphone Jack
8. Power/Stop Button
9. Navigation Control
10. Battery Compartment (Rear of Unit)
11. Tuning/Navigation Up ▲ Button
12. Navigation ►/Skip/Search ►► Button
13. Tuning/Navigation Down ▼ Button
14. USB Port

BATTERY INSTALLATION

When the bars in the battery indicator (in the display) become low (see figure 1), replace the battery as follows.



1. Open the rear cover by pressing the PRESS TO OPEN button, then lift the rear cover up to remove it as shown in figure 2.



Figure 1

2. Insert one (1) "AAA" battery as shown in figure 3. An alkaline battery is recommended for the longest playing time.
3. Put the rear cover back on until it snaps in place.

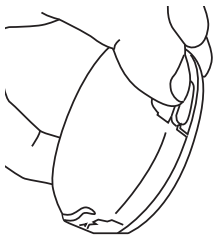

Figure 2

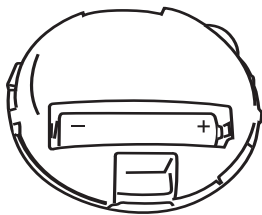

Figure 3

BATTERY PRECAUTIONS

Follow these precautions when using a battery in this device:

1. Use only the size and type of battery specified.
2. Be sure to follow the correct polarity when installing the battery as indicated. Reversed batteries may cause damage to the device.
3. If the device is not to be used for a long period of time, remove the battery to prevent damage or injury from possible battery leakage.
4. Do not try to recharge batteries not intended to be recharged; they can overheat and rupture. (Follow battery manufacturer's directions.)

INSTALL "DIGITAL AUDIO PLAYER" SOFTWARE

TO INSTALL THE "DIGITAL AUDIO PLAYER" CD SOFTWARE

For Windows ME, Windows2000 or Windows XP:

Windows will automatically detect the audio player without installing the CD software when the USB cable is connected.

For Macintosh OSX:

Macintosh OSX will automatically detect the audio player without installing the CD software. Do not install the software when using a Macintosh.

For Windows98SE:

The USB mass storage function will not be activated without driver installation. To activate the USB mass storage function, please use the installation CD-Rom to install the driver.

For Windows 98SE, if you are connecting your player to your computer for the first time, please follow these instructions:

Procedure to Install Player Driver

1. Insert the Installation CD-Rom into the CD Drive; the auto-run program will display the Main Menu window. Click "Software Drivers".

NOTE: If the Main Menu window does not appear, double click "Memorex Startup CD" application file on the Installation CD to open the Main Menu window.



WINDOWS 98 DRIVER INSTALLATION

- Click "MMP8570" to run the Windows 98SE driver.
- Follow the on-screen instructions to install the software.

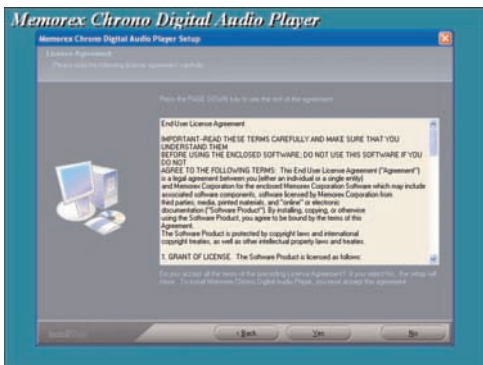
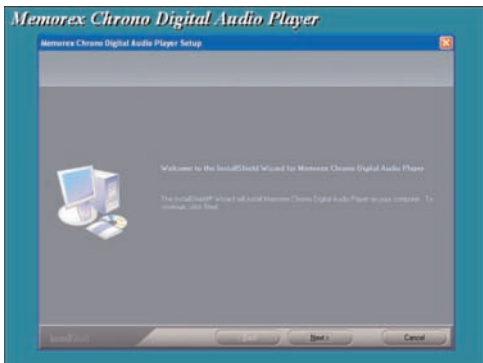

WINDOWS 98 DRIVER INSTALLATION (CONTINUED)



4. Install the software under the directory as prompted.

Warning: DO NOT change the installation path. Otherwise, the driver may not run properly.

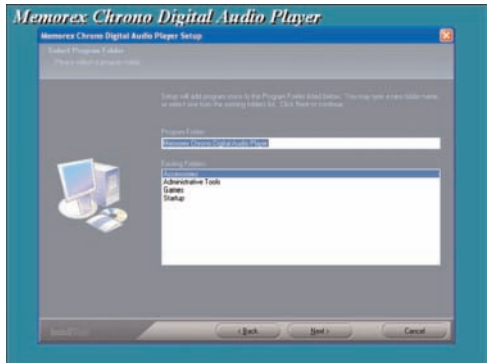

WINDOWS 98 DRIVER INSTALLATION (CONTINUED)

5. After successfully installing the driver software, click "Finish" to finish the installation and exit the Setup menu.

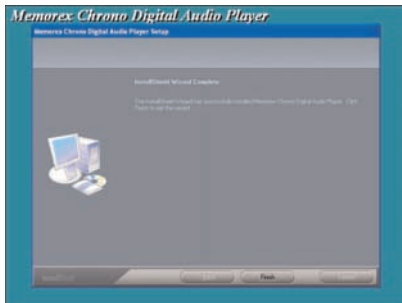

6. When the installation has completed, the new program, "Memorex Chrono Digital Audio Player", will be added to the PROGRAM menu on your computer.

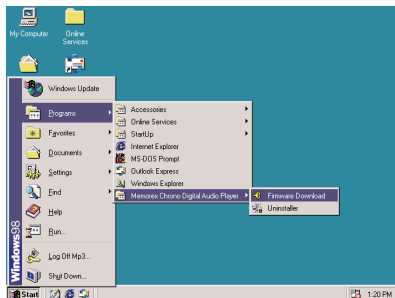

DOWNLOADING AND TRANSFERRING FILES

TRANSFERRING FILES

You can download digital music files from the Internet or use encoding software to convert music that you have on an audio CD into MP3 or WMA format. Once these files are stored on your computer you can easily copy them to your player.

Connect the computer to your player using the supplied USB cable.

Press the Power/Stop button to turn the unit on.

A "Removable Disk" window will automatically pop up on your computer screen.

To add more files and songs to your player simply drag and drop MP3 or WMA files from anywhere on your computer into the

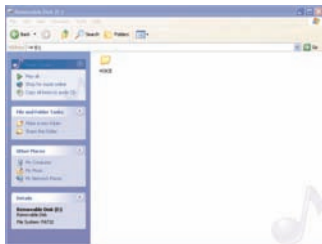

"Removable Disk" window.

IMPORTANT NOTE: A WMA file with DRM will **not** play back if you directly drag and drop it into the "Removable Disk" window. You must use MMJB or Windows Media Player to transfer copy protected files.

When you are finished, see the Safely Remove Hardware procedure on the next page before disconnecting the player.

SAFELY REMOVE HARDWARE

SAFELY REMOVING YOUR PLAYER FROM THE COMPUTER

NOTE: To avoid damage to your player or data loss, always follow the procedure listed below before disconnecting the USB cable from your computer or disconnecting the player from the USB cable.

Using your mouse, double click the "Safely Remove Hardware" icon on the task bar.



From the "Safely Remove Hardware" window, select "USB Mass Storage Device" and click the "Stop" button. The "Stop a Hardware Device" window will pop up as shown: Click "OK". When the "Safe to Remove Hardware" window is displayed, you may remove the player from the USB cable or remove the USB cable from the computer.

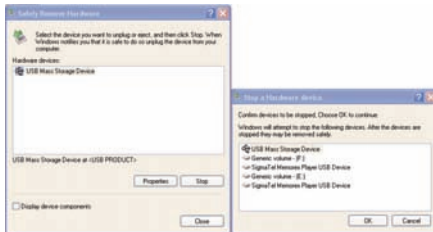

NOTES:

- If the "Safely Remove Hardware" icon is not displayed on the task bar, please double click on My Computer. Right click on "Removable Disk" and left click on "Eject". Then it is safe to remove the player from the computer.
- The "Safely Remove Hardware" procedure is not necessary for Win98 and Win98SE users.

INSTALLING MUSICMATCH JUKEBOX

MUSICMATCH JUKEBOX INSTALLATION (PC ONLY):

1. Insert the Installation CD-ROM into the CD Drive, the auto-run program will display the Main Menu. Click "Install Musicmatch Jukebox".

NOTE: If the Main Menu Window does not appear, double click "Memorex Startup CD" Application file in the installation CD in order to open the Main Menu.

2. Follow the online prompts to complete the installation.

DOWNLOADING TRACKS TO THE UNIT USING MUSICMATCH JUKEBOX (MMJB)

Please follow these instructions for transferring tracks from the computer to the unit.

NOTE: WMA DRM protected files will not play if you use the 'drag and drop' procedure. You must follow the procedure below to play WMA DRM files on your MMP8570.

1. Install the MMJB Software as described above.
2. Turn the unit ON, then connect the USB cable to the unit and the USB port of the computer. "Transfer Mode" will be displayed on the LCD when it is properly connected.
3. Open MMJB and click "Portable Device" on the left hand side of the window. The "Portable Device Manager" window will pop up. MMJB may need some time while synchronizing with the device.
4. You may now either:
 - a. Click the "Add" button and search for tracks or Playlists. Highlight the desired tracks or Playlists and click "Add".
 - b. Drag and drop tracks into the Portable Device Manager window from anywhere on your computer or from the MMJB Library.
5. The tracks are now properly transferred to the player. Follow the "Safely Removing Hardware" section on the previous page. Unplug the unit from the computer and insert the headphones and listen to your music.

INSTALLING MUSICMATCH JUKEBOX (CONTINUED)

RECORDING TRACKS FROM A CD TO A COMPUTER USING MUSICMATCH JUKEBOX (MMJB)

1. Click the "Copy From CD" button on the left hand side of the window to open the Recorder window.
2. Insert an audio CD into your CD-ROM drive.
(CD Lookup will read your CD and attempt to fill in Album, Artist, and Track (Tag) information if the computer connected to the internet)
3. Tick the boxes next to the tracks that you wish to record.
4. Click the "Start Copy" button. (The files will be recorded as MP3 files at 128Kbps). MMJB will start to record from the audio CD, to the digital file format you choose, and place recorded files into the Library.

Important Note: For further details please consult the "Musicmatch User Guide" located on the Main Menu of the Installation CD.

DOWNLOADING AND TRANSFERRING FILES (CONTINUED)

EXTERNAL MEMORY CARD

TO AVOID DAMAGE, make sure the unit is off before inserting or removing the card.

1. Remove the rear cover by pressing the PRESS TO OPEN button, then lift the rear cover up to remove it as shown in Figure 1.
2. Insert a SD/MMC memory card (not included) up to 512MB, facing up as shown in Figure 2.
3. Connect the USB cable as described previously.
The unit will turn on automatically.

NOTE: If the unit cannot turn on automatically when connected to the computer using the USB cable. Remove the inserted SD/MMC memory card then try again.

4. Drag MP3 and WMA files into the SD/MMC memory card's "Removable Disk" window."

NOTE: The WMA file with DRM will not playback if you directly drag and drop it into the "Removable Disk" window. See pages 13-14 for downloading WMA files with DRM from the computer to your player.

5. To remove the SD/MMC memory card, *turn the unit off*, then push the edge of the card as shown in Figure 3, then the card will spring out. Carefully remove the card.

6. Replace the rear cover until it snaps in place.

NOTE: If the external memory card is inserted while in the MUSIC PLAYER mode, the memory card indicator will appear at the top side of the display.

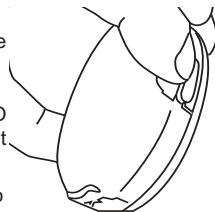

Figure 1

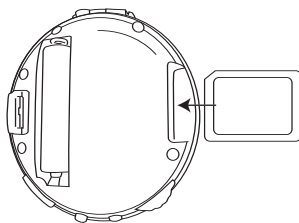

Figure 2

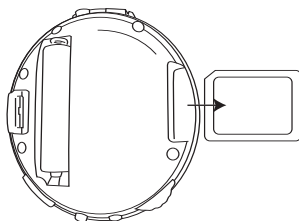

Figure 3

OPERATION

TURNING THE POWER ON/OFF

1



Turn the unit on by pressing the Power/Stop button; the Memorex start screen will appear in the display temporarily. Then the Music Player menu will appear and the MP3/WMA track's information will appear in the display. To turn the unit off, press and hold the Power/Stop button; "Hold Down To Power Off" will appear in the display. The unit will turn off after it counts up from one to three. Do not release the Power/Stop button until the unit turns off.

LOCK SWITCH

1



Press and hold the Menu/Lock button until "LOCKED" and the Lock icon appears in the display, then release. Then a small Lock icon will appear at the top right side of the display which indicates that the Lock function is activated (no buttons will be able to be pressed). This is useful when you do not want the station/track changed by accidentally pressing a button. To cancel the Lock function, press and hold the Menu/Lock button until "UNLOCKED" appears and the Lock icon flashes in the display. Then the small Lock icon will disappear from the display which indicates that the Lock function is cancelled.

NOTE: An illustration of the Lock icon follows:



EQ—MUSIC PLAYER ONLY

1

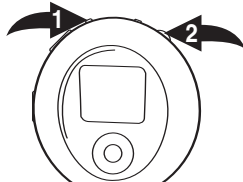

Press the Menu/Lock button ❶; the Menu will appear. Rotate the Navigation control ❷ to select Settings, then press the Navigation control ❷; the Settings menu will appear. Rotate the Navigation control ❷ to select Equalizer, then press the Navigation control ❷; the Equalizer menu will appear. Rotate the Navigation control ❷ to select the desired EQ setting: Normal, Rock, Jazz, Classical, Pop or Bass. Press the Navigation control ❷ to exit the Equalizer menu. Press the Menu/Lock button ❶ to exit the Settings menu. Rotate the Navigation control ❷ to select Now Playing, then press the Navigation control ❷. The selected EQ setting will appear at the bottom left of the display when in Music Player menu.

NOTE: To operate this unit, you can use the Navigation/Skip/Search ◀/◀◀ or ▶/▶▶ button and/or the Tuning/Navigation Up ▲ or Down ▼ button in place of the Navigation control.

OPERATION (CONTINUED)

TO LISTEN TO THE FM RADIO

1

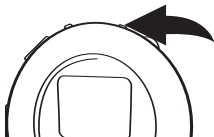

Turn the unit on by pressing the Power/Stop button; the Memorex start screen will appear in the display temporarily. Then the Music Player menu will appear and the MP3/WMA track's information will appear in the display.

2

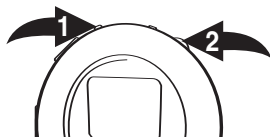

Press the Menu/Lock button ❶; the Menu will appear. Rotate the Navigation control to select FM Tuner, then press the Navigation control ❷; the FM Tuner will appear.

3



Select a station by rotating the Navigation control. When a station is broadcasting in stereo, "STEREO" will appear in the display, otherwise "MONO" will appear in the display.

NOTE: See note on Navigation at the bottom of page 16.

4



Press the VOLUME +/- buttons to increase or decrease the volume.

ANTENNA

FM—The headphones act as an antenna for FM. Extend the headphone wire for best FM reception.

AUTO SCAN: When you select the Radio mode for the first time, the unit will automatically scan and set the available stations into presets 1 through 10. Then Channel 1 will appear with the corresponding frequency tuned in. If there are no available stations, the frequency of the presets will be kept at 87.5MHz.

OPERATION (CONTINUED)

TO MANUALLY SET A STATION INTO MEMORY

1

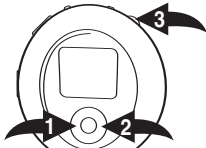

2

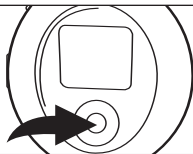

Follow the steps on the previous page to turn on the unit and enter the FM Tuner mode. Select the desired channel number to set using the Navigation/Skip/Search ◀◀ 1 or ▶▶ 2 button. Tune a station using the Navigation control 3.

NOTE: See note on Navigation at the bottom of page 16.

When a desired station is tuned, press the PLAY/PAUSE ▶|| button to store the preset; "CHANNEL" will blink twice in the display and the station will be set into memory.

TO RECEIVE MEMORY PRESETS

1

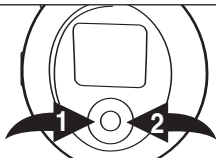

Select a desired preset channel by using the Navigation/Skip/Search ◀◀ 1 or ▶▶ 2 button.

OPERATION (CONTINUED)

TO LISTEN TO MP3s/WMA's

1

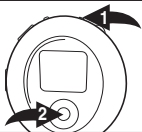

Turn the unit on by pressing the Power/Stop button **1**; the Memorex start screen will appear in the display temporarily. Then the Music Player menu will appear and the MP3/WMA track's information will appear in the display. Press the PLAY/PAUSE **▶||** button **2** to start playback; the MP3/WMA information will scroll across the display and the song number and timer will appear at the top of the display.

2

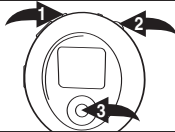

If the unit is in a mode other than the MP3/WMA player, press the Menu/Lock button **1**; the Main menu will appear in the display. Rotate the Navigation control **2** to select "Play Now", then press the Navigation control **2** to select and enter the Music Player menu and the MP3/WMA track's information will appear in the display. Press the PLAY/PAUSE **▶||** button **3** to start playback. **NOTE:** If the unit is already playing a MP3/WMA track, "Play Now" will change to "Now Playing".

3

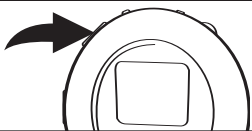

Set the Equalizer as shown on page 16. Press the VOLUME +/- buttons to increase or decrease the volume.

4



Press the Power/Stop button to stop playback. To turn the unit off, press and hold the Power/Stop button; "Hold Down To Power Off" will appear in the display. The unit will turn off after it counts up from one to three. Do not release the Power/Stop button until the unit turns off.

NOTE:

- See pages 7 through 15 for information on uploading MP3 and WMA files to this unit.

NOTE: If you are not in the Music Player menu, the Stop function will not be available. Press the Navigation/Skip/Search **◀/⏪** or **▶/⏩** button until the unit returns to the Music Player menu.

OPERATION (CONTINUED)

TO PAUSE PLAYBACK



During playback, if you wish to pause the file momentarily, press the PLAY/PAUSE ►|| button; playback will pause, the Pause indicator will appear and the timer will stop counting.



Press the PLAY/PAUSE ►|| button again to resume playback; the sound will return, the Play indicator will appear and the timer will start counting again.

NOTE: If you are not in the Music Player menu, the Pause function will not be available. Press the Navigation ◀/Skip/Search ◀◀ button until the unit returns to the Music Player menu.

TO SELECT/BROWSE THROUGH THE FILES



Press the Menu/Lock button ●; the Main menu will appear. Rotate the Navigation control ⌚ to select Browse, then press the Navigation control ⌚; the Root folder contents will appear.



Rotate the Navigation control to select Internal or External (card), then press the Navigation control; the contents of the folder will appear. Rotate the Navigation control to browse through the files, then press the Navigation control to select a file to play; the file will automatically start playing.

NOTE: If you select a track/file inside a particular folder, the total tracks/files in that folder will appear at the top of the display and the unit will only play the tracks/files in that folder. To play all the tracks on the unit (in both the Internal and External memories), press the Menu/Lock button to enter the Main menu, then select Browse and press the Navigation control to enter the Browse menu. Then select All Music using the Navigation control. Press the Navigation control and the total tracks/files (of both the Internal and External memories) will be shown at the top of the display.

OPERATION (CONTINUED)

FORWARD/REVERSE SKIP

1

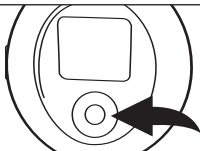

During playback, press the Navigation/Skip/Search ►/► button to advance the player to the beginning of the next file. Press the Navigation/Skip/Search ►/► button repeatedly to advance the player to higher-numbered files.

2

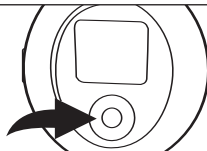

During playback, press the Navigation/Skip/Search ◀/◀ button to move the player back to the beginning of the currently playing file. Press the Navigation/Skip/Search ◀/◀ button repeatedly to move the player back to lower-numbered files.

HIGH-SPEED MUSIC SEARCH

1

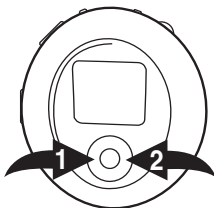

During playback, press and hold the press the Navigation/Skip/Search ◀/◀ ❶ or ►/► ❷ button to move the player forward or backward within a file to locate a specific musical passage. The player will move forward or backward at high speed as long as the button is held. When you release the button, normal playback will resume.

NOTE: If you are not in the Music Player menu, the Forward/Reverse Skip and High-Speed Music Search functions will not be available. Press the Navigation/Skip/Search ◀/◀ or ►/► button until the unit returns to the Music Player menu.

OPERATION (CONTINUED)

TO SELECT A PLAY MODE

1

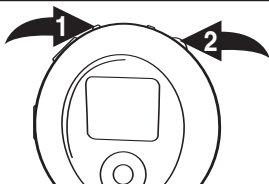

Press the Menu/Lock button ❶. Rotate the Navigation control ❷ to select Settings, then press the Navigation control ❷; the Settings menu will appear.

2

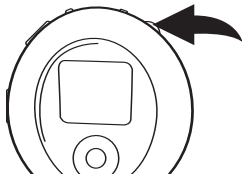

Rotate the Navigation control to select Play mode, then press the Navigation control; the Play Mode menu will appear.

3

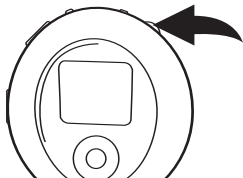

Rotate the Navigation control to select a desired Play mode (Normal, Repeat Track, Repeat All, Shuffle or Shuffle Repeat), then press the Navigation control; the respective indicator will appear at the top of the display and the Settings menu will appear.

4

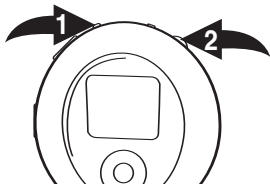

Press the Menu/Lock button ❶ once to return to the Main Menu. Rotate the Navigation control ❷ to select Now Playing, then press the Navigation control ❷; the selected mode will be activated.

OPERATION (CONTINUED)

TO SET THE CONTRAST

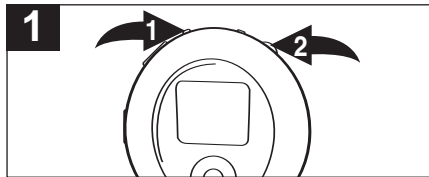

Press the Menu/Lock button ❶. Rotate the Navigation control ❷ to select Settings, then press the Navigation control ❸; the Settings menu will appear. Rotate the Navigation control ❹ to select Contrast, then press the Navigation control; the Contrast setting will appear.

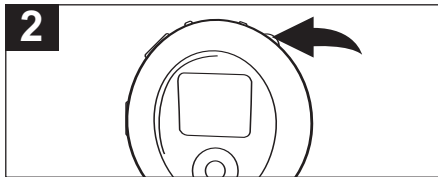

Rotate the Navigation control to set the contrast, then press the Navigation control; the Settings menu will appear.

TO SET THE BACKLIGHT

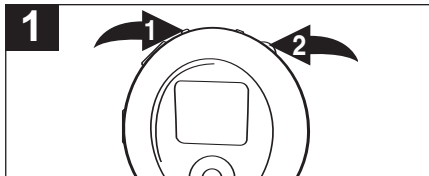

Press the Menu/Lock button ❶. Rotate the Navigation control ❷ to select Settings, then press the Navigation control ❸; the Settings menu will appear. Rotate the Navigation control ❹ to select Backlight, then press the Navigation control; the Backlight menu will appear.

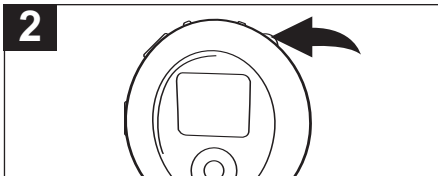

Rotate the Navigation control to select Always Off, 3 seconds, 5 seconds, 10 seconds or Always On. This is the time the backlight will be lit before turning off when no buttons are pressed. Select Always Off and the backlight will not light. Press the Navigation control to set; the Settings menu will appear.

OPERATION (CONTINUED)

TO SET THE POWER SAVINGS

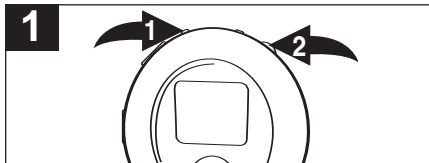

Press the Menu/Lock button ❶. Rotate the Navigation control ❷ to select Settings, then press the Navigation control ❷; the Settings menu will appear. Rotate the Navigation control ❷ to select Power Savings, then press the Navigation control ❷; the Power Savings menu will appear.

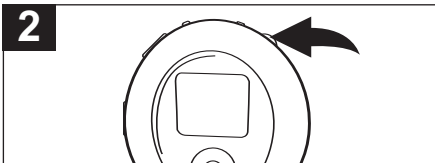

Rotate the Navigation control to select Disable, 1 minute, 3 minutes, 5 minutes or 10 minutes. This is the time the unit will stay on if it is not in Play mode and no buttons have been pressed for the set time. Press the Navigation control to set; the Settings menu will appear.

OPERATION (CONTINUED)

TO SET THE LANGUAGE

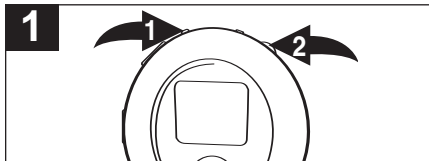

Press the Menu/Lock button ❶. Rotate the Navigation control ❷ to select Settings, then press the Navigation control ❸; the Settings menu will appear. Rotate the Navigation control ❹ to select Language, then press the Navigation control ❺; the Language menu will appear.

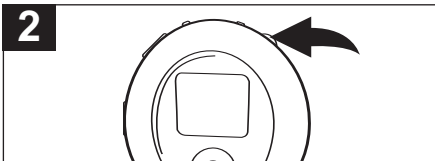

Rotate the Navigation control to select English, Traditional Chinese, French, Spanish, Dutch or Italian. Press the Navigation control to set; the Settings menu will appear.

TO VIEW THE SYSTEM INFO

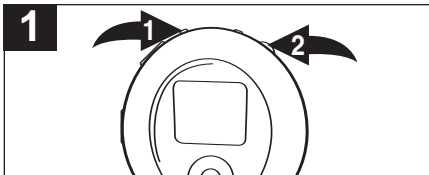

Press the Menu/Lock button ❶. Rotate the Navigation control ❷ to select Settings, then press the Navigation control ❸; the Settings menu will appear.

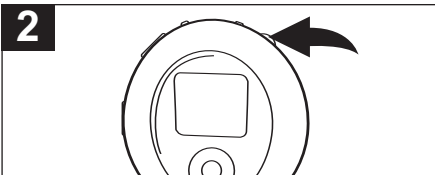

Rotate the Navigation control to select System Info, then press the Navigation control; the System Information will appear. Press the Navigation control to exit System Info; the Settings menu will appear.

NOTE: Press the Menu/Lock button to exit the Settings Menu and return to the Main menu.

SPECIFICATIONS

DELETING A FILE

1

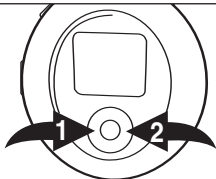

While in the Music Player Menu, press the Navigation/Skip/Search ◀◀ ❶ or ▶▶ ❷ button to select the file that you wish to delete.

NOTE: You can also use the Browse function (see page 20) to browse and select a file to delete.

2

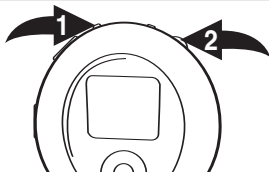

When the selected MP3/WMA file's information appears in the display, press the Menu/Lock button ❶; the Main Menu will appear. Rotate the Navigation control to select Delete File ❷, then press the Navigation control ❸; the delete file menu will appear in the display.

3

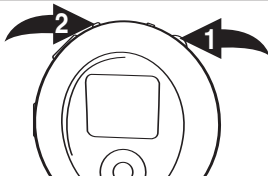

Rotate the Navigation control ❶ to highlight "Yes" or "No". If you highlight "Yes", then press the Navigation control, the selected file will be deleted. If you highlight "No", then press the Navigation control ❶, the unit will skip to the next MP3/WMA file. Press the Menu/Lock button ❷ once to cancel the Delete File function and return to the main menu.

TROUBLESHOOTING GUIDE

If you experience a problem with this unit, check the chart below before calling for service.

SYMPTOM	CAUSE	SOLUTION
Unit will not turn on.	Dead battery, or not installed properly.	Replace battery and install properly.
No sound.	Headphones are not inserted.	Insert headphones.
	Volume is set too low.	Raise the volume.
	DRM files copied & pasted.	See pages 13-14.
FM distorted.	The MP3 or WMA files are corrupted.	Download uncorrupted files.
	Station not tuned.	Retune station and extend headphone wire.
Download Failure.	Damaged USB cable.	Replace cable.
The computer is not recognizing the player.	The USB cable is not securely connected.	Make sure USB cable is securely connected.
	Win98 driver is not installed or computer is not compatible.	Install Win98 driver and/or see pages 7 through 10 for compatibility.

TROUBLESHOOTING GUIDE (CONTINUED)

SYMPTOM	CAUSE	SOLUTION
No buttons work.	The Lock feature is activated.	Deactivate Lock feature as described on page 16.
	Unit needs to be reset or firmware needs to be updated.	Reset unit and/or update firmware, see pages 29-30.
Unit acting erratically.	Unit needs to be reset or firmware needs to be updated.	Reset unit and/or update firmware, see pages 29-30.
WMA files with DRM cannot playback.	Incorrect downloading methods.	See pages 13-14 to download WMA files with DRM.

FORMATTING THE PLAYER

WARNING! Do not format this player unless it stops working and you are instructed to do so by technical support personnel.

Formatting the Player

1. Use the USB cable to connect the player and the computer.
2. Double click on My Computer, right click the "Removable Disk" and left click on "Format".
3. At the "Format" window, select "FAT32" from the file system pull down menu, then click start to format the unit (see figure to the right).

NOTE: Make sure you have selected the "FAT32" at the file system pull down menu, otherwise after formatting, the player will not work properly.

4. Click OK to confirm and the player will start to format.
5. When finished, click "Close" to close the Format window.

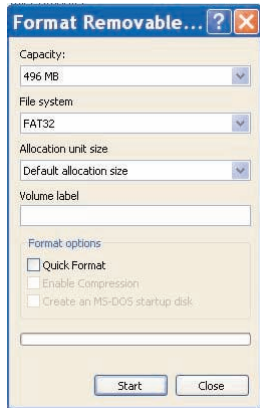

UPDATING THE FIRMWARE

WARNING! Do not update the firmware unless you are experiencing problems with your digital audio device. Incorrect or faulty firmware installation will cause the player to stop functioning.

1. Download the updated firmware at www.memorexelectronics.com.
2. Unzip the file, then double click setup.exe in the Desktop folder to install the software to your computer.
3. Connect the player to the computer using the supplied USB cable and the installation screen will appear. (If the installation screen does not appear, unplug the USB cable and turn off the unit. Connect to the computer again and press & hold for the Power/Stop button until the installation screen appears.
4. Follow the on-screen instructions to install the driver.
5. When finished, click START and locate the newly installed software "Memorex Chrono Digital Audio Player" and select "Firmware Download".

RESETTING THE UNIT

If the player is not operating properly, try resetting it by removing the battery for a few seconds.

SPECIFICATIONS

Audio	Frequency Range	20Hz – 20KHz
	Headphones Output	10mW, 16ohm (Max. Vol)
	S/N Ratio	90dB (MP3)
File Support	MP3	MPEG 1/2/2.5 Layer 3
	WMA	Windows Media Audio (WMA file with DRM)
	Bit Rate	8kbps – 320kbps
	Tag Info	ID3 Tag (Unicode OS)
FM Tuner	FM Frequency Range	87.5MHz – 107.9 MHz
	Antenna	Headphones/Earphones Cord Antenna
General	Dimension	75 x 68 x 25 mm
	Weight	50g (without battery)
	Battery	1 x AAA battery
	LCD	Full Graphic with Backlight
	Language	6 Languages (English, Traditional Chinese, French, Spanish, Dutch, Italian)
	USB	USB 2.0
	Built-in Memory	512MB
	Max. Playtime	Approx. 18 hours (128kps, MP3)
	Supported OS	Win ME, 2000, XP and Mac OSX Win 98SE (Driver is required)
	Operating Temperature	23° F to 104° F (-5° C to 40° C)

Specifications are subject to change without notice.

**FOR FIRMWARE UPGRADE, PLEASE VISIT OUR WEBSITE AT
WWW.MEMOREXELECTRONICS.COM
TO CHECK IF THERE IS NEW FIRMWARE AVAILABLE.**

**FOR ADDITIONAL SET-UP OR OPERATING ASSISTANCE,
PLEASE VISIT OUR WEBSITE AT
WWW.MEMOREXELECTRONICS.COM
OR CONTACT CUSTOMER SERVICE AT (954) 660-7100.**

**PLEASE KEEP ALL PACKAGING MATERIAL FOR AT LEAST 90
DAYS IN CASE YOU NEED TO RETURN THIS PRODUCT TO YOUR
PLACE OF PURCHASE OR TO MEMOREX.**

**FOR PARTS AND ACCESSORIES, CONTACT FOX INTERNATIONAL
AT 1-800-321-6993.**

Memcorp, Inc.
Weston, FL
Printed in China

Visit our website at www.memorexelectronics.com

Free Manuals Download Website

<http://myh66.com>

<http://usermanuals.us>

<http://www.somanuals.com>

<http://www.4manuals.cc>

<http://www.manual-lib.com>

<http://www.404manual.com>

<http://www.luxmanual.com>

<http://aubethermostatmanual.com>

Golf course search by state

<http://golfingnear.com>

Email search by domain

<http://emailbydomain.com>

Auto manuals search

<http://auto.somanuals.com>

TV manuals search

<http://tv.somanuals.com>