

# **Memorex®**

**PERSONAL AM/FM STEREO/COMPACT  
DISC MP3 PLAYER**

**MODEL: MPD8846**

**BEFORE OPERATING THIS PRODUCT, PLEASE READ THESE  
INSTRUCTIONS COMPLETELY.**



## **OPERATING INSTRUCTIONS**

## SAFETY PRECAUTIONS



**CAUTION**  
**RISK OF ELECTRIC SHOCK**  
**DO NOT OPEN**



**CAUTION:** TO REDUCE THE RISK OF ELECTRIC SHOCK, DO NOT REMOVE COVER (OR BACK). NO USER-SERVICEABLE PARTS INSIDE. REFER SERVICING TO QUALIFIED SERVICE PERSONNEL.

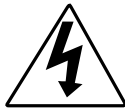

**DANGEROUS VOLTAGE:**

The lightning flash with arrowhead symbol, within an equilateral triangle is intended to alert the user to the presence of uninsulated dangerous voltage within the product's enclosure that may be of sufficient magnitude to constitute a risk of electric shock to persons.



**ATTENTION:**

The exclamation point within an equilateral triangle is intended to alert the user to the presence of important operating and maintenance (servicing) instructions in the literature accompanying the appliance.

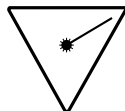

**DANGER:**

This product utilizes a Class 1 laser to read Compact Discs. This laser Compact Disc Player is equipped with safety switches to avoid exposure when the CD door is open and the safety interlocks are defeated. Invisible and hazardous laser radiation when open and interlock failed or defeated. Avoid direct exposure to beam. Please do not attempt to defeat or bypass the safety switches.

**FCC WARNING:**

This equipment may generate or use radio frequency energy. Changes or modifications to this equipment may cause harmful interference unless the modifications are expressly approved in the instruction manual. The user could lose the authority to operate this equipment if an unauthorized change or modification is made.

**SURGE PROTECTORS:**

It is recommended to use a surge protector for AC connection. Lightning and power surges ARE NOT covered under warranty for this product.

## SAFETY PRECAUTIONS (CONTINUED)

### INFORMATION:

This equipment has been tested and found to comply with the limits for a Class B digital device, pursuant to Part 15 of the FCC Rules. These limits are designed to provide reasonable protection against harmful interference in a residential installation. This equipment generates, uses, and can radiate radio frequency energy and, if not installed and used in accordance with the instructions, may cause harmful interference to radio communications. However, there is no guarantee that interference will not occur in a particular installation. If this equipment does cause harmful interference to radio or television reception, which can be determined by turning the equipment off and on, the user is encouraged to try to correct the interference by one or more of the following measures:

- Reorient or relocate the receiving antenna.
- Increase the separation between the equipment and receiver.
- Connect the equipment into an outlet on a circuit different from that to which the receiver is connected.
- Consult the dealer or an experienced radio/TV technician for help.

- Do not open the CD compartment while the CD is rotating.
- Always keep the CD compartment closed when not in use.
- Keep all foreign objects out of the CD compartment.
- Place the unit on a stable surface.
- Avoid installing the unit in locations described below:
  - Places exposed to direct sunlight or close to heat radiating appliances such as electric heaters.
  - On top of other stereo equipment that radiates too much heat.
  - Placed lacking ventilation or dusty places.
  - Places subject to constant vibration.
  - Humid or moist places.

**Dear Customer:**

Selecting fine audio equipment such as the unit you've just purchased is only the start of your musical enjoyment. Now it's time to consider how you can maximize the fun and excitement your equipment offers. This manufacturer and the Electronic Industries Association's Consumer Electronics Group want you to get the most out of your equipment by playing it at a safe level. One that lets the sound come through loud and clear without annoying blaring or distortion and, most importantly, without affecting your sensitive hearing.

Sound can be deceiving. Over time your hearing "comfort level" adapts to higher volumes of sound. So what sounds "normal" can actually be loud and harmful to your hearing. Guard against this by setting your equipment at a safe level BEFORE your hearing adapts.

**To establish a safe level:**

- Start your volume control at a low setting.
- Slowly increase the sound until you can hear it comfortably and clearly, and without distortion.

**Once you have established a comfortable sound level:**

- Set the dial and leave it there.

Taking a minute to do this now will help to prevent hearing damage or loss in the future. After all, we want you listening for a lifetime.

**We Want You Listening For A Lifetime**

Used wisely, your new sound equipment will provide a lifetime of fun and enjoyment. Since hearing damage from loud noise is often undetectable until it is too late, this manufacturer and the Electronic Industries Association's Consumer Electronics Group recommend you avoid prolonged exposure to excessive noise. This list of sound levels is included for your protection.

**Decibel**

<u>Level</u>	<u>Example</u>
30	Quiet library, soft whispers
40	Living room, refrigerator, bedroom away from traffic
50	Light traffic, normal conversation, quiet office
60	Air conditioner at 20 feet, sewing machine
70	Vacuum cleaner, hair dryer, noisy restaurant
80	Average city traffic, garbage disposals, alarm clock at two feet

**THE FOLLOWING NOISES CAN BE DANGEROUS UNDER CONSTANT EXPOSURE:**

90	Subway, motorcycle, truck traffic, lawn mower
100	Garbage truck, chain saw, pneumatic drill
120	Rock band concert in front of speakers, thunderclap
140	Gunshot blast, jet engine
180	Rocket launching pad

Information courtesy of the Deafness Research Foundation.



## LOCATION OF CONTROLS

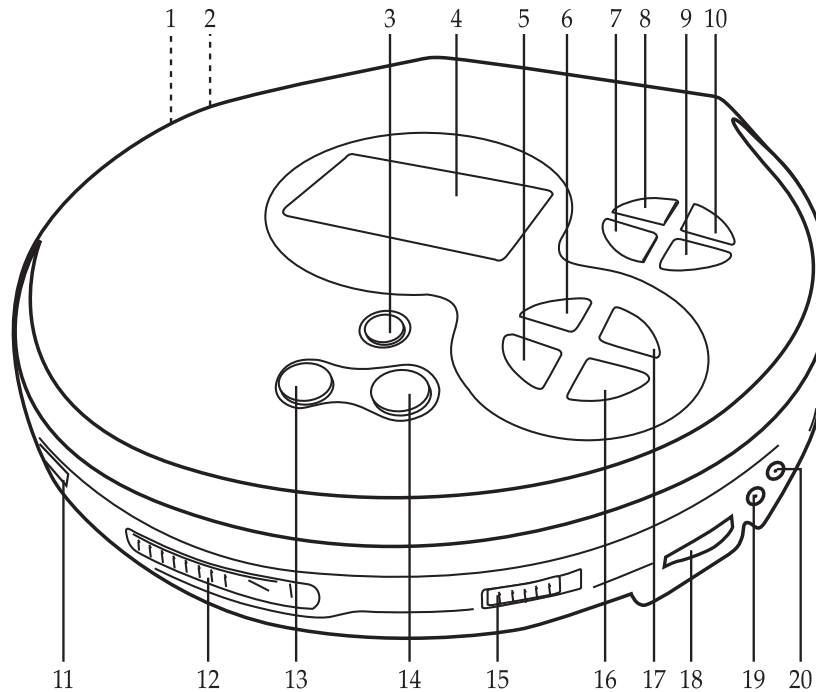

- |   |                                |
|---|--------------------------------|
| 1. DC 4.5V Jack (Side of Unit)                    | 11. FUNCTION (CD/RADIO) Switch |
|   | 12. CD Door OPEN Switch        |
| 2. Battery Compartment (Inside of CD Compartment) | 13. PROG. (Program) Button     |
| 3. MENU/ESP/BAND Button                           | 14. ENTER/CLEAR Button         |
| 4. Display  | 15. DBBS (Bass Boost) Switch   |
| 5. MODE/◀ Button                                  | 16. RESUME/▶ Button            |
| 6. PRESET ▼ Button                                | 17. PRESET ▲ Button            |
| 7. Skip/TUNING DN (◀◀) Button                     | 18. VOLUME Control             |
| 8. STOP (■)/ Power Off Button                     | 19. PHONES (Headphones) Jack   |
| 9. Skip/TUNING UP (▶▶) Button                     | 20. LINE OUT Jack              |
| 10. PLAY/PAUSE (▶  ) /Power On Button             |                                |

## POWER SOURCES

This CD player requires either two (2) "AA" cell standard batteries (not included) or the AC adapter (not included).

### BATTERY INSTALLATION

"Low Battery" will light in the display when batteries are low (when using battery power).

1. Open the CD Compartment, then open the battery compartment door by pressing in the tab and lifting it. **To prevent the possibility of losing the cover, it cannot be removed.**
2. Insert two (2) "AA" cell batteries (not included) according to the polarity diagram inside the battery compartment. Alkaline batteries are recommended for the longest playing time.

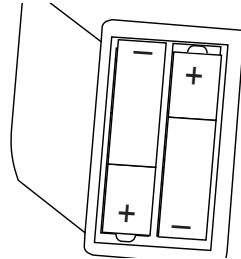

### BATTERY PRECAUTIONS

Follow these precautions when using batteries in this device:

1. Use only the size and type of batteries specified.
2. Be sure to follow the correct polarity when installing the batteries as indicated next to the battery compartment. Reversed batteries may cause damage to the device.
3. Do not mix different types of batteries together (e.g. Alkaline and Carbon-zinc) or old batteries with fresh ones.
4. If the device is not to be used for a long period of time, remove the batteries to prevent damage or injury from possible battery leakage.
5. Do not try to recharge batteries not intended to be recharged; they can overheat and rupture. (Follow battery manufacturer's directions.)

### AC OPERATION

To operate the unit using AC power, connect an AC adapter (not included) to an AC outlet having 120V, 50/60Hz AC only. Plug the small end into the DC 4.5V jack on the side of the unit and connect the other end into the AC outlet. The batteries are automatically disconnected when the AC adapter is used.

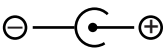
POLARITY: 

## RADIO OPERATION

### TO LISTEN TO THE RADIO

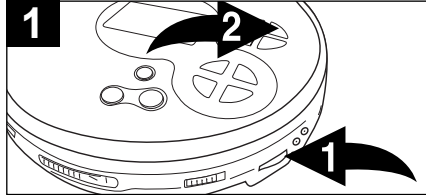

Set the VOLUME control ❶ to minimum and plug the headphone into the PHONES jack. Press the PLAY/PAUSE (▶||) /POWER ON button ❷ to turn the unit on.

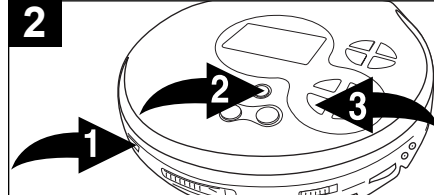

Slide the FUNCTION switch ❶ to the RADIO position. Press the MENU/ESP/BAND button ❷ to select a band (AM or FM). If listening to FM, press the MODE/◀ button ❸ to select Stereo or Mono.

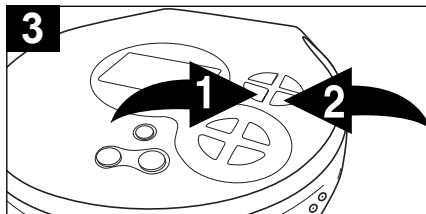

Press and release the Skip/TUNING DN |◀◀ ❶ or UP ▶▶ ❷ button to tune a station. Press and hold the Skip/TUNING DN |◀◀ ❶ or UP ▶▶ ❷ button for Auto Scan tuning (see below).

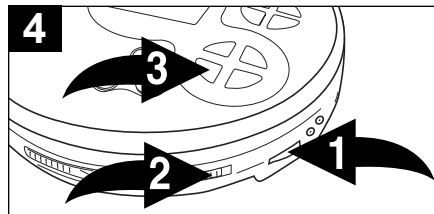

Adjust the VOLUME control ❶ and DBBS switch ❷ as desired. If FM STEREO reception is weak/noisy, press the MODE/◀ button ❸ to Mono, in this case the reception will be monaural.

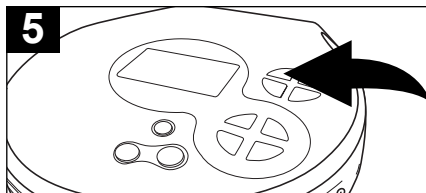

To turn the radio off, press the STOP (■)/POWER OFF button.

#### ANTENNAS

**AM** – This unit has a built-in ferrite bar antenna, which provides adequate reception in most areas. If reception is weak, turn the unit to improve reception.

**FM** – The headphones act as an antenna for FM. Extend the headphone wire for best FM reception.

#### AUTO SCAN

Press and hold the Skip/TUNING DN |◀◀ or UP ▶▶ button for approximately one second and the unit will automatically search for the next available station.

## RADIO OPERATION (CONTINUED)

### TO SET AND RECEIVE A STATION INTO MEMORY

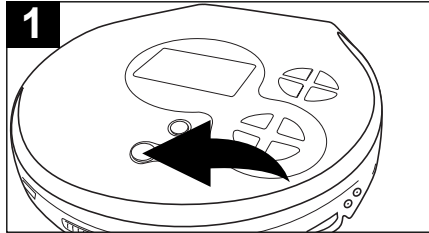

**1** Tune a desired station as described in the previous section. Press the PROG. button; the preset number will blink.

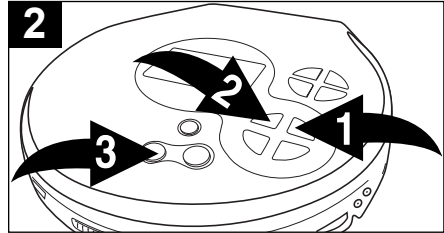

**2** Within ten seconds, select the desired preset using the PRESET ▲ ❶ or ▼ ❷ button to set the memory. Press the PROG. ❸ button to confirm.

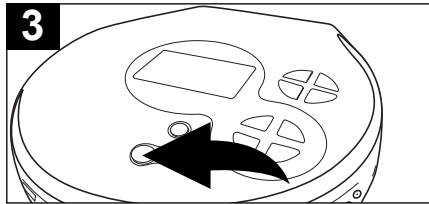

**3** Repeat steps 1 and 2 to program more presets (up to 10 presets for each band).

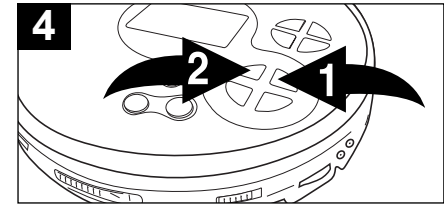

**4** To receive a preset station, simply press the PRESET ▲ ❶ or ▼ ❷ button to select the desired preset.

### BASS BOOST

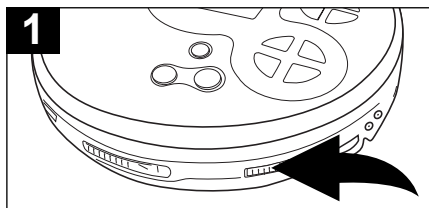

**1** To emphasize the bass, slide the DBBS switch to the ON position. For normal bass, slide the DBBS switch to the OFF position.

### TURNING POWER ON /OFF

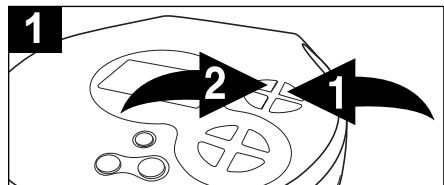

**1** To turn the unit on, press the PLAY/PAUSE (▶||)/POWER ON button ❶.  
To turn the unit off, press the STOP (■)/POWER OFF button ❷. The unit will automatically shut off if stopped (CD Standby) for one minute.





## CD OPERATION

### TO INSERT AND PLAY A CD

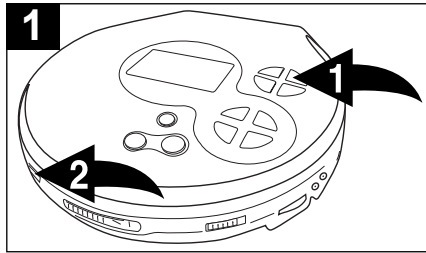
This CD player is designed to play all kinds of Audio Discs and MP3 CD ROMS, such as CD recordables and rewritables. Do not try to play CDI, CDV, DVD or computer CDs in this unit.





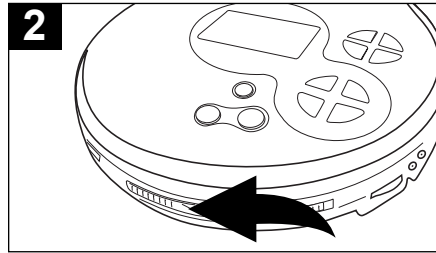

Press the PLAY/PAUSE (▶||)/POWER ON button  to turn the unit on. Slide the FUNCTION switch  to the CD position.

**NOTE:** If the FUNCTION switch is in the CD position and there is a CD in the CD Compartment, the CD will automatically start playing when the power is turned on.

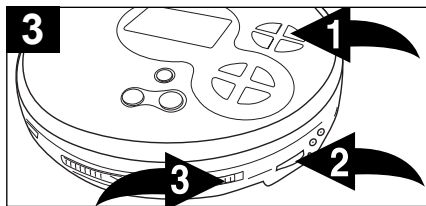

Slide the CD Door OPEN switch to the right to open the CD compartment. Gently press a disc, label side up, onto the spindle until it locks in place. Close the CD compartment lid; the total tracks (and folders, if using MP3) will appear in the display.



Press the PLAY/PAUSE (▶||)/POWER ON button  to begin playback; the current track and elapsed playing time (CD information and folder will also appear, if using MP3) will appear in the display. Adjust the VOLUME control  and DBBS switch  as desired.

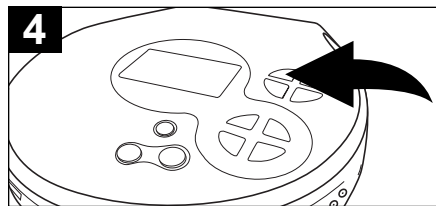

When the disc is through playing, it will stop. Press the STOP (■)/POWER OFF button to stop the disc before it is finished. Press the STOP (■)/POWER OFF button again to turn the unit off.

## CD OPERATION (CONTINUED)

### CD PLAYBACK NOTES:

- See page 16 for more information on MP3's.
- When recording ("burning") CDs, make sure the session is "finalized", or simply record ("burn") only one session. You can find more information in your recorder's manual.
- This unit is capable of playing standard CDs or 3" singles; no adapter is required.
- If a disc is inserted incorrectly, dirty, damaged or not present at all, "no disc" will appear in the display.
- If a disc is not recorded properly, a disc error will occur.
- Playback will stop when you open the CD compartment, but it is not recommended to open the compartment before the STOP (■) /POWER OFF button is pressed or during CD playback.
- If there is no activity for 60 seconds, the unit will turn itself off to save the batteries.
- It may take 10 to 30 seconds for the player to read an MP3 CD and begin playback, depending on the number of tracks burned on the CD.

### TO PAUSE A CD

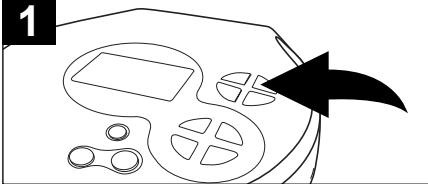
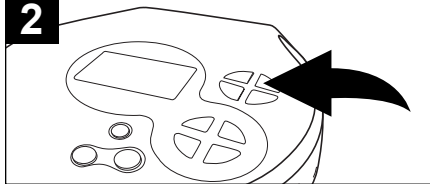
	
<p>During CD playback, if you wish to pause the disc momentarily, press the PLAY/PAUSE (▶  ) /POWER ON button. Playback stops but the disc continues to spin and the elapsed time flashes in the display.</p>	<p>Press the PLAY/PAUSE (▶  ) /POWER ON button again to release pause and resume playback. The sound returns and the elapsed time in the display stops flashing.</p>

### BACKLIGHT

When the power is turned on, the display backlight will light for eight seconds. With the power on, press any button to turn the backlight on for eight seconds. During Playback CD, TUNER or in Standby mode, press the ENTER/CLEAR button to turn on the backlight for checking the display.

## CD OPERATION (CONTINUED)

### TO BEGIN PLAYBACK FROM A SPECIFIC TRACK

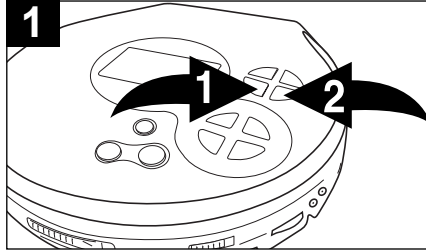

After you insert the disc into the CD player and the total number of tracks and time appear on the display, you may press either the Skip/TUNING DN or UP button to select a specific track for playback.

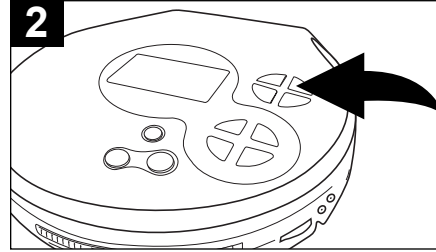

When the desired track number (and file number if using MP3) appears in the display, press the PLAY/PAUSE /POWER ON button. Playback will begin with the track (or file) you selected.

### FORWARD/REVERSE SKIP TRACK

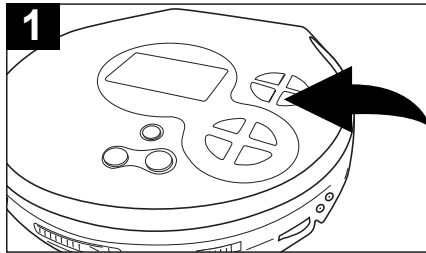

During playback, press and release the Skip/TUNING UP button once to advance the player to the beginning of the next track. Press the Skip/TUNING UP button repeatedly to advance the player to higher numbered tracks.

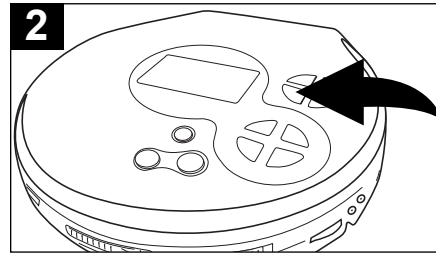

During playback, press and release the Skip/TUNING DN button once to move the player back to the beginning of the currently playing track. Press the Skip/TUNING DN button repeatedly to move the player back to lower numbered tracks.

## CD OPERATION (CONTINUED)

### HIGH-SPEED MUSIC SEARCH

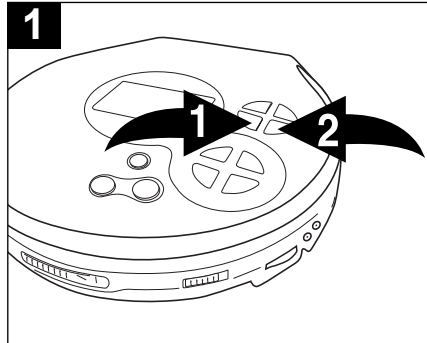

During playback, depress and hold either the Skip/TUNING DN  $\blacktriangleleft$  ❶ or UP  $\blacktriangleright$  ❷ button to move the player forward or backward within a track to locate a specific musical passage. The player will move forward or backward at high speed as long as the buttons are depressed. When you release the Skip/TUNING DN  $\blacktriangleleft$  ❶ or UP  $\blacktriangleright$  ❷ button, normal playback will resume.

### REPEAT PLAYBACK OF ONE TRACK

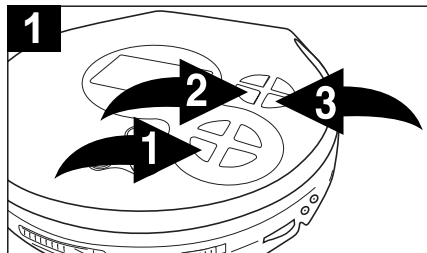

To repeat a single track, while in the Stop mode, press the MODE/ $\blacktriangleleft$  button ❶ once; "REP 1" will appear in the display. Press the Skip/TUNING DN  $\blacktriangleleft$  ❷ or UP  $\blacktriangleright$  ❸ button to select the specific track that you wish to repeat.

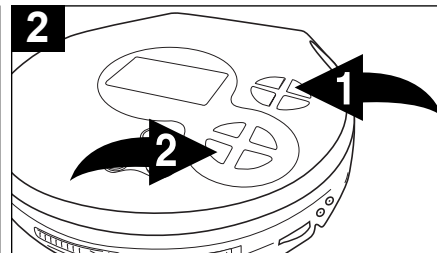

When the desired track number appears in the display, press the PLAY/PAUSE ( $\blacktriangleright$   $\parallel$ ) /POWER ON button ❶ to begin playback. The specific track you selected will be repeated continuously. To cancel Repeat playback, press the MODE/ $\blacktriangleleft$  button ❷ repeatedly until the mode indicator disappears.

## CD OPERATION (CONTINUED)

### REPEAT PLAYBACK OF ALL TRACKS

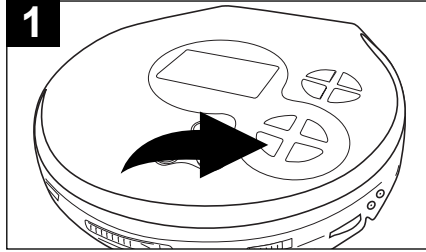

To repeat all the tracks on the CD, while in the Stop mode, press the MODE/◀ button ❶; "REP A" will appear in the display.

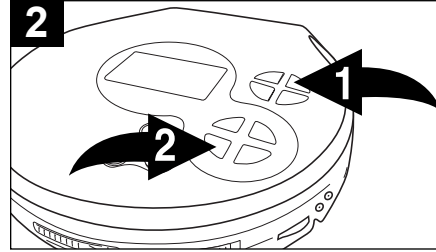

Press the PLAY/PAUSE (▶||)/POWER ON button ❶ to begin playback. All tracks on the disc will be repeated continuously. To stop Repeat playback, press the MODE/◀ button ❷ repeatedly until the mode indicator disappears.

### REPEAT PLAYBACK OF A FOLDER (MP3 w/folders only)

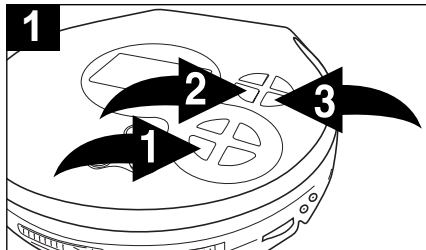

To repeat all files in a directory (MP3 CD only), while in the Stop mode, press the MODE/◀ button ❶ three times; "REP D" will appear in the display. Press the Skip/TUNING DN ◀◀ ❷ or UP ▶▶ ❸ button to select the specific directory that you wish to repeat.

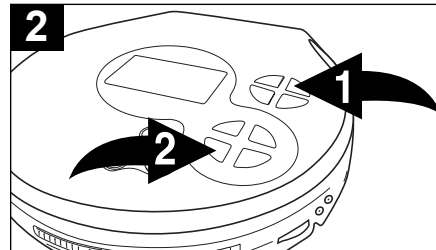

Press the PLAY/PAUSE (▶||)/POWER ON button ❶ to begin playback. All files in the selected directory will be repeated continuously. To stop Repeat playback, press the MODE/◀ button ❷ repeatedly until the mode indicator disappears. See page 16 for more info on MP3 format.

## CD OPERATION (CONTINUED)

### INTRO PLAYBACK (Will play the first 10 seconds of each track)

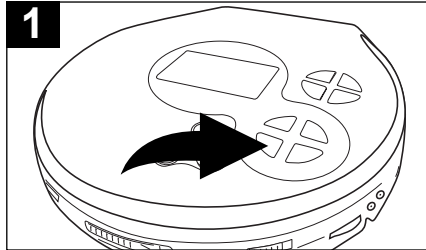

**1** While in the Stop mode, press the MODE/◀ button three times (four times if an MP3 CD with multiple directories is inserted); "INTRO" will appear in the display.

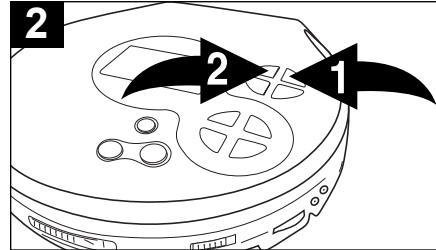

**2** Press the PLAY/PAUSE (▶||)/POWER ON button ❶ to begin Intro playback. The first 10 seconds of all tracks on the disc will be played in sequence. Press the STOP (■)/POWER OFF button ❷ to stop Intro playback.

To cancel Intro playback, press the MODE button repeatedly until the Mode indicator disappears.

### TO RANDOMLY PLAY BACK A CD

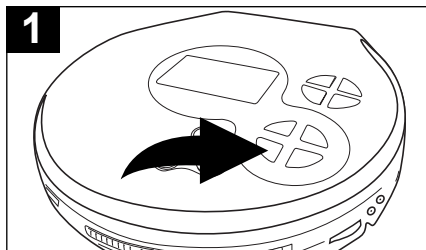

**1** While in the Stop mode, press the MODE/◀ button four times (five times if an MP3 CD with multiple directories is inserted); "RANDOM" will appear in the display.

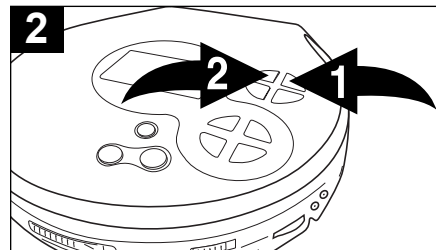

**2** Press the PLAY/PAUSE (▶||)/POWER ON button ❶ to begin playback. The unit will play all the tracks in random order. When all the tracks have been played, the unit will stop. Press the STOP (■)/POWER OFF button ❷ to stop Random playback.

To cancel Random playback, press the MODE button repeatedly until the Mode indicator disappears.

## CD OPERATION (CONTINUED)

### TO PROGRAM THE MEMORY (UP TO 24 TRACKS)

Programming is the ability to preselect the order in which a series of tracks will be played.

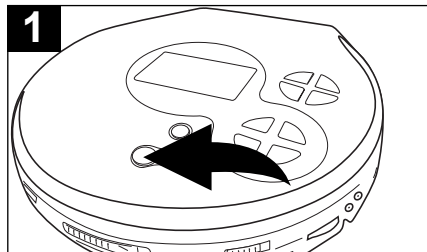

**1** While in the Stop mode, press the PROG. button. The track number will blink and "P-01" will appear in the display.

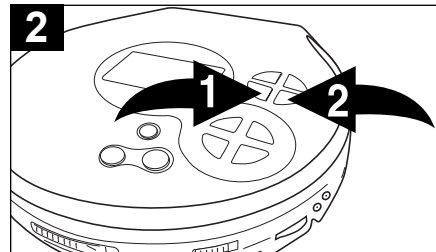

**2** Select a track to be programmed using the Skip/TUNING DN ◀◀ 1 or UP ▶▶ 2 button. If using a MP3 disc, see note below.

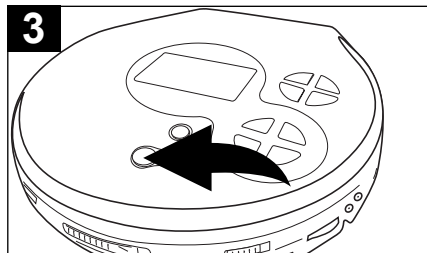

**3** Press the PROG. button to memorize the track. Repeat steps 2 and 3 to program additional tracks up to a maximum of 24 tracks.

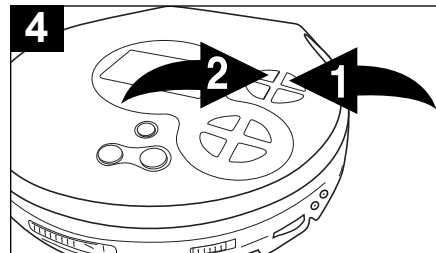

**4** Press the PLAY/PAUSE (▶||)/POWER ON button 1 to begin programmed playback; "P" will appear in the display. After the program is played, it will stop or press the STOP (■) /POWER OFF button 2 to stop programmed playback.

#### NOTES:

- When in the Stop mode, press and hold the ENTER/CLEAR button for two seconds to clear the memory; "P" indicator will disappear.
- **MP3:** If an MP3 CD is inserted, you will first select the directory number in step 1, then the file/track number.

**SEE TOP OF NEXT PAGE FOR MORE NOTES ON PROGRAMMING THE MEMORY.**

## CD OPERATION (CONTINUED)

### NOTES ON PROGRAM PLAYBACK

- You can review the program by pressing the PROG. button repeatedly while in the Stop mode.
- To add a track to the program memory, simply press the PROG. button repeatedly until the track (Directory for MP3) appears and "00" blinks in the display, then follow steps 2 and 3 on the previous page.
- Press the STOP (■) /POWER OFF button to stop the program before it is finished (the program memory will be kept).
- Each file may be stored in the program memory as many times as desired (up to 24 files).
- You can skip tracks/directories through the program while it is playing using the Skip/TUNING DN ◀◀ or UP ▶▶ button.

### ESP (ELECTRONIC SKIP PROTECTION)

This feature protects against loss of sound caused by vibrations and shocks. Continuous playback is ensured once some of the music has been stored into memory.

ESP will automatically be activated when listening to standard or MP3 CDs. You cannot deactivate ESP while listening to an MP3 CD. However, you can deactivate it when playing a standard CD by simply pressing the MENU/ESP/BAND button; the ESP indicator will disappear from the display. Deactivating the ESP will conserve battery life.

### RESUME

This unit has Auto resume, which will resume playback of the previous track when the unit is turned on (and the same CD is still in the CD compartment).

The RESUME/▶ button will allow you to resume playback of a CD that was previously stopped. If you stopped a CD in the middle of playing, simply press the RESUME/▶ button and the CD will continue at the start of the last played track.



## CD OPERATION (CONTINUED)

### MP3 FAQs - Frequently Asked Questions

#### Please read before playing an MP3 CD.

*Does the unit support packet write CD-RW?*

Yes it can. You can add or delete MP3 files without reformatting. It appears like a PC hard drive.

*Can the unit read regular music CDs?*

Yes it can. However you can not mix MP3s and WAV files on the same CD. If you do this your Portable MP3 CD Player will play only the MP3 files.

*Does the unit have Electronic Skip Protection built-in?*

Yes it has an anti-shock buffer (45 seconds for standard CD and 120 seconds for MP3 CD). What it means for the everyday user is that it can withstand road bumps, shaking, etc. There will be no skipping when you jog, or run on a tread mill or drive on a bumpy road.

*Can I use the MP3 extension for non-audio data files?*

No, this may result in serious malfunction and harmful noise interference.

*Can I mix MP3 files with other file types on the CDR?*

Yes, but your Portable MP3 CD Player will ignore those files and read only the MP3 files on the CDR.

*Does the unit support multi-session CDRs?*

If the MP3 CD is not finalized, you can burn a new group of MP3 files until the CD is full.

*Does the unit support subdirectories (subfolders)?*

Yes, the unit can read MP3 files from subfolders.

*What appears on the display when playing back MP3 CDs?*

The album, title and artist (if set when MP3 was recorded).

## CD OPERATION (CONTINUED)

### SELECTING SONGS BY MP3 TITLE

You can search for a song by title as follows:

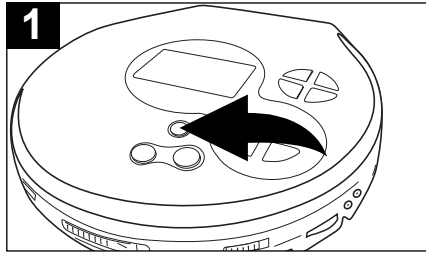

While in the Stop mode, press the MENU/ESP/BAND button; the alpha-  
bet will appear in the display.

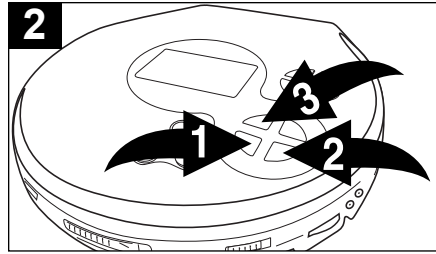

Select the first letter of a file you would like to listen to using the MODE/◀ ❶ and/or RESUME/▶ ❷ buttons. Press the PRESET ▼ button ❸ to access the lower letters.

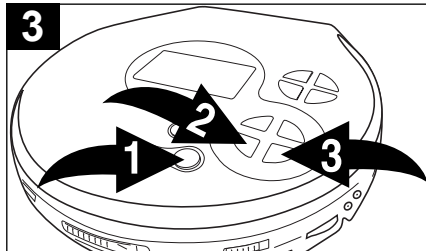

Press the ENTER/CLEAR button ❶ and a list of files starting with the selected letter will appear. Press the MODE/◀ ❷ and/or RESUME/▶ ❸ buttons to scroll through the list.

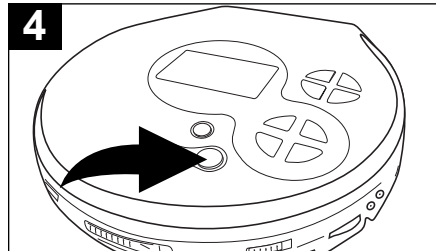

When the desired file appears, press the ENTER/CLEAR button and the file will automatically start playing.

#### NOTE:

If you select a letter that does not contain any files, "No File" will appear in the display.

## CD OPERATION (CONTINUED)

### SEARCHING THROUGH MP3 DIRECTORIES

You can search the contents of the directories (if burned on CD) as follows:

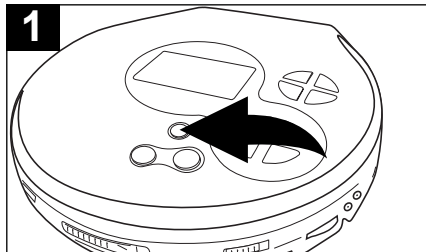

1 Press the MENU/ESP/BAND button twice; the first directory will appear in the display, as well as its contents.

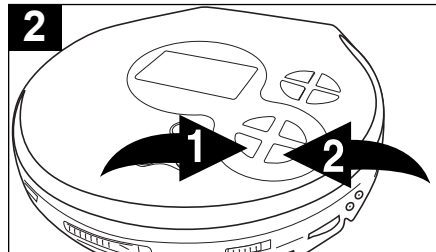

2 To select a file from the directory, use the MODE/◀ ❶ and/or RESUME/▶ ❷ buttons.

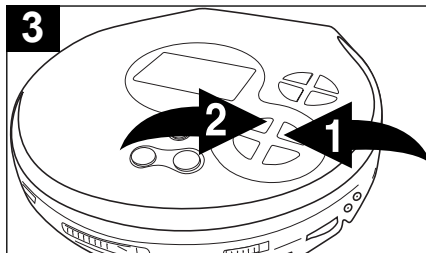

3 If you would like to change directories, use the PRESET ▲ ❶ and/or ▼ ❷ buttons.

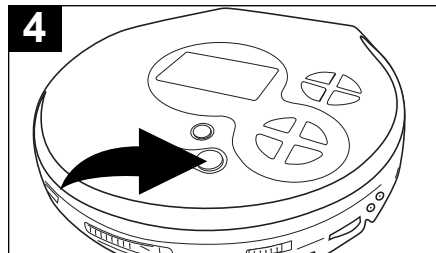

4 When the desired file appears, press the ENTER/CLEAR button and the file will automatically start playing.

#### Radio Sound Through a Home Audio System

By using a home audio connection cable (not included), superb radio sound can be heard through your home audio system. Before making any connections, turn off the power to all equipment.

Plug a connection cable (not included) between the LINE OUT jack on the side of the CD player and the amplifier's AUX or CD input jack. (Do not connect it to the amplifier's PHONO jack.)

**NOTE:** If the radio interferes with TV reception, move the unit away from the TV or turn off the power to this unit.

## CD OPERATION (CONTINUED)

### SINGLE SESSION

The following chart is an example of a **Windows Explorer** display that will appear on your computer monitor for a single session MP3 CD ROM with directories/albums. Check the added notes to help you understand the MP3 CD unit display and the playback sequence of directories/albums and tracks on a single session MP3 CD.

### MULTI SESSION

The computer user does not need to finalize the CDR disc as music is burned on the CD. Because of this, the music can be downloaded at different times until the whole CD is full.

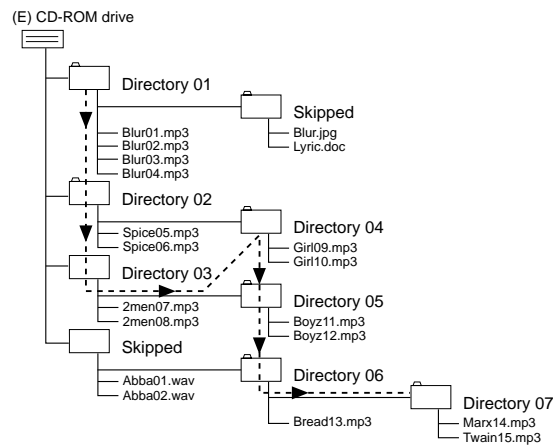

### NOTES:

- The arrow pathway shows the sequence of MP3 directory and file playback.
- This example has a total of seven MP3 directories.
- Based on this layout, the first file will be "Blur01.mp3" and the last file will be "Twain15.mp3".
- "Skipped" denotes a directory which contains non-audio files only, e.g. jpg, wav, etc. These cannot be detected nor played on this player. When an album contains mixed format files, the non-MP3 files will be skipped.

## CARE AND MAINTENANCE

### Caring for Compact Discs

- Treat the compact disc carefully. Handle the compact disc only by its edges. Never allow your fingers to come in contact with the shiny, unprinted side of the compact disc.
- Do not attach adhesive tape, stickers, etc. to the compact disc label.
- Clean the compact disc periodically with a soft, lint-free, dry cloth. Never use detergents or abrasive cleaners to clean the compact disc. If necessary, use a CD cleaning kit.
- If a compact disc skips or gets stuck on a section of the compact disc, it is probably dirty or damaged (scratched).

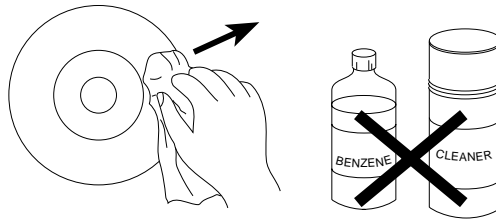
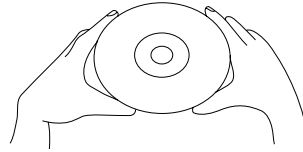

- When cleaning the compact disc, wipe in straight lines from the center of the compact disc to the outer edge of the compact disc. Never wipe in circular motions.
- Compact discs should be stored in their cases after each use to avoid damage.
- Do not expose compact discs to direct sunlight, high humidity, high temperatures, or dust, etc. Prolonged exposure or extreme temperatures can warp the compact disc.
- Do not stick or write anything on either side of the compact disc. Sharp writing instruments, or the ink may damage the surface.

### Cleaning the unit

- To prevent fire or shock hazard, disconnect your unit from the AC power source when cleaning.
- The finish on your unit may be cleaned with a dust cloth and cared for as other furniture. Use caution when cleaning and wiping the plastic parts.
- Mild soap and a damp cloth may be used on the front panel.

## TROUBLESHOOTING GUIDE

If you experience a problem with this unit, check the chart below before calling for service.

SYMPTOM	CAUSE	SOLUTION
Unit will not turn on.	Dead batteries, or not installed properly.	Replace batteries, and install properly.
	Weak or dead Re-chargeable batteries.	Recharge or replace batteries (if used).
	AC adapter not connected.	Check AC adapter connection.
Disc will not play.	CD compartment not closed.	Close CD compartment.
	Disc inserted incorrectly.	Reinsert disc correctly.
	Dirty or defective disc.	Try another disc.
	Moisture condensation on disc.	Wipe disc with soft cloth.
Erratic CD playback.	Dirty or defective disc.	Clean or replace disc.
No sound from headphones.	Headphone plug not inserted correctly.	Reinsert headphone plug correctly.
	VOLUME control set to minimum.	Increase volume.
	Weak batteries.	Replace batteries.
	Defective disc.	Try another disc.
ESP not working.	ESP is not activated.	Press the MENU/ESP/BAND button.
Noise or sound distorted on radio.	Station not tuned properly for AM or FM.	Retune AM or FM broadcast station.
	FM: Headphone wire not extended.	Extend Headphone wire.
	AM: Unit is not positioned correctly.	Rotate unit until best reception is obtained.
FM STEREO indicator does not light.	Poor FM signal.	Retune station.
	MODE button not set to Stereo.	Press MODE button to turn on Stereo.
No sound.	FUNCTION switch is not in the desired position.	Set FUNCTION switch to the desired function.

## SPECIFICATIONS

MPEG Rate .....	32-384Kbps
Sampling Frequency .....	8/11.025/12KHz for MPEG2.5
	16/22.05/24KHz for MPEG2
	32/44.1/48KHz for MPEG1
MP3 Playback .....	ISO9660 format compatible
Frequency Range (FM) .....	87.5-108MHz
Frequency Range (AM) .....	530-1720kHz

Check the CD burner/recorder's documentation to see if it complies with these specifications.

FOR ADDITIONAL SET-UP OR OPERATING ASSISTANCE, PLEASE VISIT OUR WEBSITE AT

**[WWW.MEMOREXELECTRONICS.COM](http://WWW.MEMOREXELECTRONICS.COM)**

OR CONTACT CUSTOMER SERVICE AT 1-800-919-3647.

PLEASE KEEP ALL PACKAGING MATERIAL FOR AT LEAST 90 DAYS IN CASE YOU NEED TO RETURN THIS PRODUCT TO YOUR PLACE OF PURCHASE OR MEMOREX.

FOR PARTS AND ACCESSORIES, CONTACT FOX INTERNATIONAL AT 1-800-321-6993.

Memcorp, Inc.  
Weston, FL  
Printed in Hong Kong

Visit our website at [www.memorexelectronics.com](http://www.memorexelectronics.com)



## Free Manuals Download Website

<http://myh66.com>

<http://usermanuals.us>

<http://www.somanuals.com>

<http://www.4manuals.cc>

<http://www.manual-lib.com>

<http://www.404manual.com>

<http://www.luxmanual.com>

<http://aubethermostatmanual.com>

Golf course search by state

<http://golfingnear.com>

Email search by domain

<http://emailbydomain.com>

Auto manuals search

<http://auto.somanuals.com>

TV manuals search

<http://tv.somanuals.com>