

Memorex®

STRIP-CUT SHREDDER

MODEL: MPS1500

**BEFORE OPERATING THIS PRODUCT,
PLEASE READ THESE INSTRUCTIONS COMPLETELY.**

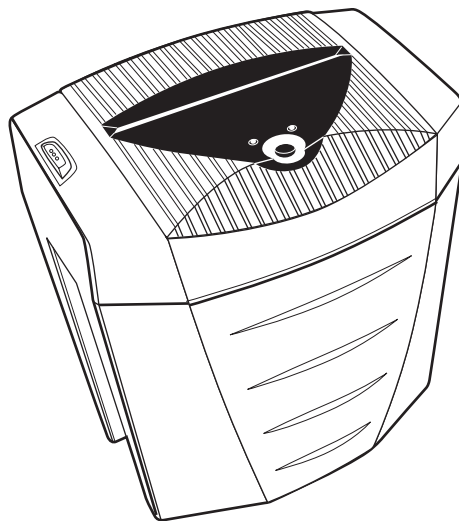

OPERATING INSTRUCTIONS

SAFETY PRECAUTIONS



CAUTION
RISK OF ELECTRIC SHOCK
DO NOT OPEN



CAUTION: TO REDUCE THE RISK OF ELECTRIC SHOCK, DO NOT REMOVE COVER (OR BACK). NO USER-SERVICEABLE PARTS INSIDE. REFER SERVICING TO QUALIFIED SERVICE PERSONNEL.



DANGEROUS VOLTAGE

The lightning flash with arrowhead symbol, within an equilateral triangle is intended to alert the user to the presence of uninsulated dangerous voltage within the product's enclosure that may be of sufficient magnitude to constitute a risk of electric shock to persons.



ATTENTION

The exclamation point within an equilateral triangle is intended to alert the user to the presence of important operating and maintenance (servicing) instructions in the literature accompanying the appliance.

SURGE PROTECTORS:

It is recommended to use a surge protector for AC connection. Lightning and power surges ARE NOT covered under warranty for this product.

IMPORTANT:

PLEASE KEEP ALL PACKAGING MATERIAL FOR AT LEAST 90 DAYS IN CASE YOU NEED TO RETURN THIS PRODUCT TO YOUR PLACE OF PURCHASE OR MEMOREX.

DANGER, Do not insert fingers near the shredder.

DANGER, Do not wear dangling jewelry near the shredder.

DANGER, Remove staples and paper clips before inserting page(s) into the shredder.

DANGER, Do not insert disks, CDs or cassette tapes into the shredder.

DANGER, Do not wear dangling ties near the unit.

DANGER, Make sure your hair is not near the shredder.

SAFETY PRECAUTIONS

To guard against injury, the following basic safety precautions must be observed in the installation and use of this shredder. For your own safety, **DO NOT ATTEMPT TO INSTALL OR OPERATE THE SHREDDER UNTIL YOU READ ALL THESE INSTRUCTIONS.**

- Make sure the power is off when the shredder is not used.
- Do not use the shredder for anything other than its intended purpose (shredding paper documents). Do not shred cloth, plastic, cardboard, or any other hard material that will damage the shredder blades. Remove all paper clips and staples from paper before shredding.
- Do not place hands or fingers into the shredder feed opening as serious injury may result.
- Follow all warnings and instructions marked on the shredder.
- This product should not be placed near, or over, a heat source.
- Do not use this product near water or in areas of high humidity and avoid spilling liquids on it.
- To stop shredding in case of emergency, slide the AUTO/OFF/REV switch to the OFF position and/or unplug the shredder immediately. For this reason, make sure the outlet that the shredder is connected to is easily accessible.
- Do not leave the power cord where something may be placed on it, or it may be stepped on.
- **This unit should not be operated or stored near children or pets.**
- Always turn off or unplug the shredder prior to moving, cleaning or emptying the wastebasket.
- The use of an extension cord is not recommended.

PLEASE SAVE THESE INSTRUCTIONS

TO GET THE MOST OUT OF YOUR SHREDDER:

- Never try to shred more than the shred capacity. Overloading the shredder will shorten its durability.
- Always feed the paper(s) in straight, do not feed at an angle.
- Always use the shredder with the AUTO/OFF/REV switch in the AUTO position.
- Clean the outside of the shredder by wiping it with a damp cloth from time to time. Mild stains can be removed using a soft, damp cloth and mild detergent. Remove detergent residue with a damp cloth. Always unplug the shredder before cleaning.
- Never use any harsh or abrasive cleanser.
- Keep the shredder away from direct sunlight.

POWER SOURCE

AC USAGE

Use the AC polarized line cord included with the unit for operation on AC power. Insert the plug into a conveniently located AC outlet having 120V, 60 Hz.

NOTE: The AC plug supplied with the unit is polarized to help minimize the possibility of electric shock. If the AC plug does not fit into a nonpolarized AC outlet, do not file or cut the wide blade. It is the user's responsibility to have an electrician replace the obsolete outlet.

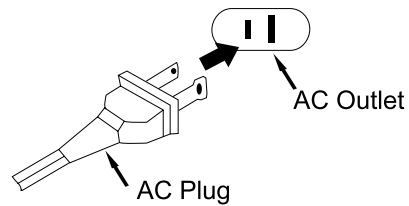

LOCATION OF CONTROLS

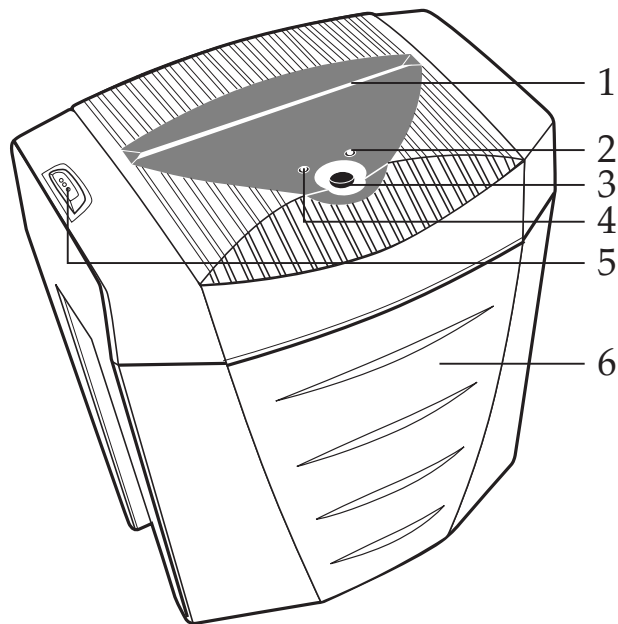

1. Shredder
2. BIN FULL Indicator
3. CLEAR Button
4. POWER Indicator
5. AUTO/OFF/REV Switch
6. Wastebasket

OPERATION

Follow the instructions below to operate your new shredder.
After unpacking the shredder, place it securely on the supplied wastebasket.
Then, plug the unit into an AC outlet as described on page 1.

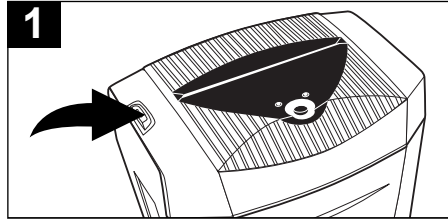

1 Slide the AUTO/OFF/REV switch to the AUTO position; the POWER indicator will light.

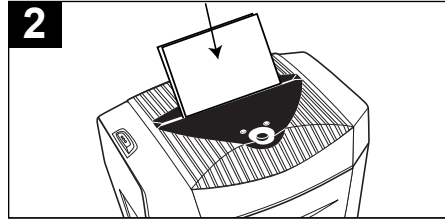

2 Insert up to 5 pages of 20lb paper into the shredder, and the unit will automatically shred them.

NOTES:

- If inserting small documents, insert them in the center of the shredder as the sensor is located there.
- Do not attempt to insert more than 5 pages at a time, as it will shorten the life of the shredder.
- The shredder will stop automatically if it is overheated by long and continuous intermittent operation. Allow the shredder to rest for approximately 20 minutes to cool down.

WASTEBASKET FULL INDICATOR:

When the wastebasket is full, the BIN FULL indicator will light on the cover. Empty wastebasket in this case.

WASTEBASKET PROTECTION:

As a safety feature of this shredder, if the top unit separates from the wastebasket, the shredder will not operate.

OPERATION

REMOVING PAPER JAMS:

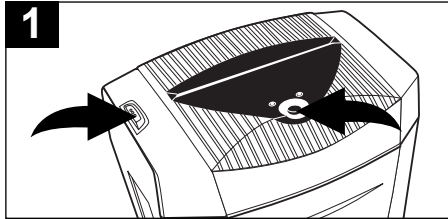

If a paper jam occurs, slide the AUTO/OFF/REV switch to the REV (Reverse) position to withdraw the non-shredded paper. If paper still remains in the shredder, press the CLEAR button to shred and clear the remaining pages.

PAPER TIP SOLUTION

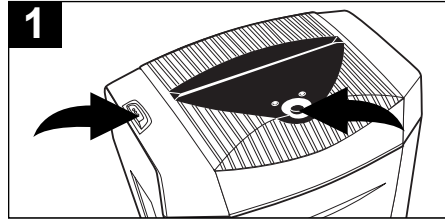

On occasion, paper strips get stuck in the shredder. In this case, slide the AUTO/OFF/REV switch to the REV position for 2 to 3 seconds. Then, slide the AUTO/OFF/REV switch back to the AUTO position and press the CLEAR button for 2 to 3 seconds. Repeat this procedure one to two times to fully clear the paper tips.

TO TURN THE SHREDDER OFF

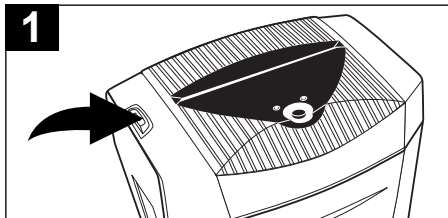

To turn the shredder off, simply slide the AUTO/OFF/REV switch to the OFF position; the POWER indicator will go off.

SPECIFICATIONS

Power Source.....120V AC, 60Hz
 Shred capacity.....5 single sheets of 20lb paper
 Shred Size.....1/4" strips
 Paper Cut.....Strip-Cut

TROUBLESHOOTING GUIDE

Before requesting service, please refer to the following troubleshooting guide. Many questions/problems you may be having will be answered simply.

SYMPTOM	SOLUTION
Shredder does not run.	Power cord is not plugged in.
	The inserted paper(s) are beyond the shredder capacity. Use 5 or less pages at once.
	The motor is overheated due to continuous shredding. Do not use shredder for 20 minutes.
Shredder running, but no paper is inserted.	Empty wastebasket as it is full.
	Paper is stuck in the shredder, clear the them from the shredder.
When inserting envelopes or similar small pages, the shredder does not activate.	The width of the pages is not wide enough to touch the sensor at the center of the shredder. Press the CLEAR button and shred the non-shredded paper completely.

FOR ADDITIONAL SET-UP OR OPERATING ASSISTANCE, PLEASE VISIT OUR WEBSITE AT WWW.MEMCORPINC.COM OR CONTACT CUSTOMER SERVICE AT 1-800-919-3647

FOR PARTS & ACCESSORIES, CONTACT FOX INT'L AT 1-800-321-6993.

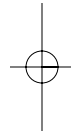
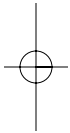

Memcorp, Inc.
Weston, FL 33331
Printed in Hong Kong

Visit our website at www.memcorpinc.com

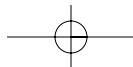

Free Manuals Download Website

<http://myh66.com>

<http://usermanuals.us>

<http://www.somanuals.com>

<http://www.4manuals.cc>

<http://www.manual-lib.com>

<http://www.404manual.com>

<http://www.luxmanual.com>

<http://aubethermostatmanual.com>

Golf course search by state

<http://golfingnear.com>

Email search by domain

<http://emailbydomain.com>

Auto manuals search

<http://auto.somanuals.com>

TV manuals search

<http://tv.somanuals.com>