

Memorex®

Is it live or is it Memorex?™

MKS8730

User's Guide

CD/CD+G
Karaoke System
with 7" B&W Monitor
and Remote Control

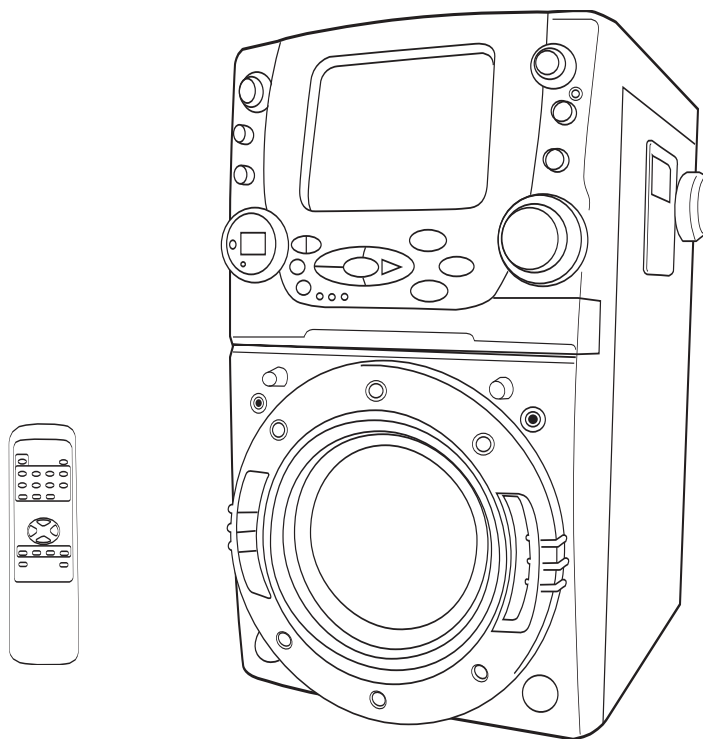

**Before operating this product,
please read these instructions completely.**

LOCATION OF CONTROLS (CONTINUED)

REAR

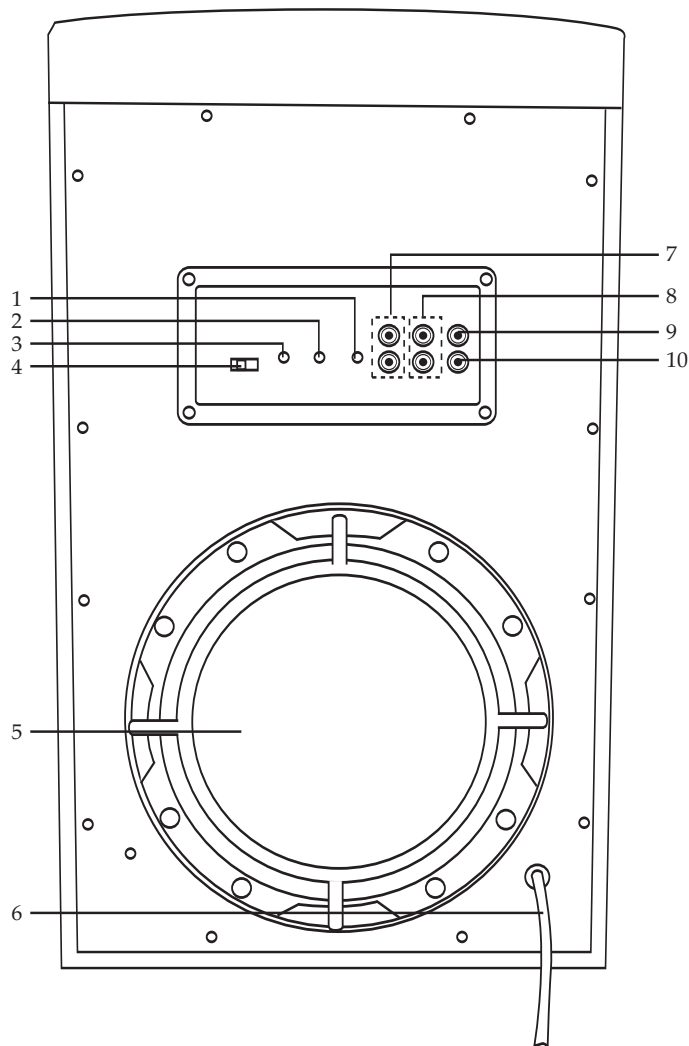

1. V-HOLD Control
2. CONTRAST Control
3. BRIGHTNESS Control
4. SPEAKER Switch
5. Rear Speaker
6. AC Cord
7. AUX OUT Left and Right Jacks
8. AUX IN Left and Right Jacks
9. VIDEO IN Jack
10. VIDEO OUT Jack



Dear Customer,

Please read this manual thoroughly before operating the unit to become more familiar with it and obtain the performance that will bring you continued enjoyment for many years. Keep these instructions handy for future reference.

PLEASE KEEP ALL PACKAGING MATERIAL FOR AT LEAST 90 DAYS IN CASE YOU NEED TO RETURN THIS PRODUCT TO YOUR PLACE OF PURCHASE OR MEMOREX.

For future reference, record the serial number of the unit printed on the rear of the cabinet.

Serial Number _____

| | | |
|--|---|---|
|  | CAUTION RISK OF ELECTRIC SHOCK DO NOT OPEN |  |
| CAUTION: TO REDUCE THE RISK OF ELECTRIC SHOCK, DO NOT REMOVE COVER (OR BACK). NO USER-SERVICEABLE PARTS INSIDE. REFER SERVICING TO QUALIFIED SERVICE PERSONNEL. | | |



DANGEROUS VOLTAGE:

The lightning flash with arrowhead symbol, within an equilateral triangle is intended to alert the user to the presence of uninsulated dangerous voltage within the product's enclosure that may be of sufficient magnitude to constitute a risk of electric shock to persons.



ATTENTION:

The exclamation point within an equilateral triangle is intended to alert the user to the presence of important operating and maintenance (servicing) instructions in the literature accompanying the appliance.

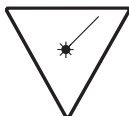

DANGER:

Invisible and hazardous laser radiation when open and interlock failed or defeated. Avoid direct exposure to beam.

| |
|---|
| FCC WARNING: This equipment may generate or use radio frequency energy. Changes or modifications to this equipment may cause harmful interference unless the modifications are expressly approved in the instruction manual. The user could lose the authority to operate this equipment if an unauthorized change or modification is made. |
|---|

| |
|--|
| LASER SAFETY: This unit employs a laser. Only qualified service personnel should attempt to service this device due to possible eye injury. CAUTION: USE OF CONTROLS, ADJUSTMENTS OR PERFORMANCE PROCEDURE HEREIN MAY RESULT IN HAZARDOUS RADIATION EXPOSURE. |
|--|

| |
|---|
| INFORMATION This equipment has been tested and found to comply with the limits for a Class B digital device, pursuant to Part 15 of the FCC Rules. These limits are designed to provide reasonable protection against harmful interference in a residential installation. This equipment generates, uses and can radiate radio frequency energy and, if not installed and used in accordance with the instructions, may cause harmful interference to radio communications. However, there is no guarantee that interference will not occur in a particular installation. If this equipment does cause harmful interference to radio or television reception, which can be determined by turning the equipment off and on, the user is encouraged to try to correct the interference by one or more of the following measures: <ul style="list-style-type: none">• Reorient or relocate the receiving antenna.• Increase the separation between the equipment and receiver.• Connect the equipment into an outlet on a circuit different from that to which the receiver is connected.• Consult the dealer or an experienced radio/TV technician for help. |
|---|

| |
|---|
| WARNING: TO PREVENT FIRE OR SHOCK HAZARD, DO NOT EXPOSE THIS UNIT TO RAIN OR MOISTURE. |
|---|

| |
|---|
| SURGE PROTECTORS: It is recommended to use a surge protector for AC connection. Lightning and power surges ARE NOT covered under warranty for this product. |
|---|

Dear Customer:

Selecting fine audio equipment such as the unit you've just purchased is only the start of your musical enjoyment. Now it's time to consider how you can maximize the fun and excitement your equipment offers. This manufacturer and the Electronic Industries Association's Consumer Electronics Group want you to get the most out of your equipment by playing it at a safe level. One that lets the sound come through loud and clear without annoying blaring or distortion-and, most importantly, without affecting your sensitive hearing.

Sound can be deceiving. Over time your hearing "comfort level" adapts to higher volumes of sound. So what sounds "normal" can actually be loud and harmful to your hearing. Guard against this by setting your equipment at a safe level BEFORE your hearing adapts.

To establish a safe level:

- Start your volume control at a low setting.
- Slowly increase the sound until you can hear it comfortably and clearly, and without distortion.

Once you have established a comfortable sound level:

- Set the dial and leave it there.

Taking a minute to do this now will help to prevent hearing damage or loss in the future. After all, we want you listening for a lifetime.

We Want You Listening For A Lifetime

Used wisely, your new sound equipment will provide a lifetime of fun and enjoyment. Since hearing damage from loud noise is often undetectable until it is too late, this manufacturer and the Electronic Industries Association's Consumer Electronics Group recommend you avoid prolonged exposure to excessive noise. This list of sound levels is included for your protection.

Decibel

| <u>Level</u> | <u>Example</u> |
|--------------|--|
| 30 | Quiet library, soft whispers |
| 40 | Living room, refrigerator, bedroom away from traffic |
| 50 | Light traffic, normal conversation, quiet office |
| 60 | Air conditioner at 20 feet, sewing machine |
| 70 | Vacuum cleaner, hair dryer, noisy restaurant |
| 80 | Average city traffic, garbage disposals, alarm clock at two feet |

THE FOLLOWING NOISES CAN BE DANGEROUS UNDER CONSTANT EXPOSURE:

| | |
|-----|---|
| 90 | Subway, motorcycle, truck traffic, lawn mower |
| 100 | Garbage truck, chain saw, pneumatic drill |
| 120 | Rock band concert in front of speakers, thunderclap |
| 140 | Gunshot blast, jet engine |
| 180 | Rocket launching pad |

Information courtesy of the Deafness Research Foundation.



SAFETY INSTRUCTIONS

Before using the unit, be sure to read all operating instructions carefully. Please note that these are general precautions and may not pertain to your unit. For example, this unit may not have the capability to be connected to an outdoor antenna.

1. READ INSTRUCTIONS

All the safety and operating instructions should be read before the product is operated.

2. RETAIN INSTRUCTIONS

The safety and operating instructions should be retained for future reference.

3. HEED WARNINGS

All warnings on the product and in the operating instructions should be adhered to.

4. FOLLOW INSTRUCTIONS

All operating and use instructions should be followed.

5. CLEANING

Unplug this product from the wall outlet before cleaning. Do not use liquid cleaners or aerosol cleaners. Use a dry cloth for cleaning.

6. ATTACHMENTS

Do not use attachments not recommended by the product's manufacturer as they may cause hazards.

7. WATER AND MOISTURE

Do not use this product near water—for example: near a bathtub, washbowl, kitchen sink or laundry tub; in a wet basement; or near a swimming pool.

8. ACCESSORIES

Do not place this product on an unstable cart, stand, tripod, bracket or table. The product may fall, causing serious injury and serious damage to the product. Use only with a cart, stand, tripod, bracket or table recommended by the manufacturer or sold with the product. Any mounting of the product should follow the manufacturer's instructions, and should use a mounting accessory recommended by the manufacturer.

PORTABLE CART WARNING
(symbol provided by RETAC)



8A. An appliance and cart combination should be moved with care. Quick stops, excessive force and uneven surfaces may cause the appliance and cart combination to overturn.

9. VENTILATION

Slots and openings in the cabinet and in the back or bottom are provided for ventilation, to ensure reliable operation of the product and to protect it from overheating. These openings must not be blocked or covered. The openings should never be blocked by placing the product on a bed, sofa, rug or other similar surface. This product should never be placed near or over a radiator or heat source. This product should not be placed in a built-in installation such as a bookcase or rack unless proper ventilation is provided or the manufacturer's instructions have been adhered to.

10. POWER SOURCES

This product should be operated only from the type of power source indicated on the marking label. If you are not sure of the type of power supply to your home, consult your appliance dealer or local power company. For products intended to operate from battery power, or other sources, refer to the operating instructions.

11. GROUNDING OR POLARIZATION

This product is equipped with a polarized alternating-current line plug (a plug having one blade wider than the other). This plug will fit into the power outlet only one way. This is a safety feature. If you are unable to insert the plug fully into the outlet, try reversing the plug. If the plug should still fail to fit, contact your electrician to replace your obsolete outlet. Do not defeat the safety purpose of the polarized plug.

12. POWER-CORD PROTECTION

Power-supply cords should be routed so that they are not likely to be walked on or pinched by items placed upon or against them, paying particular attention to cords at plugs, convenience receptacles, and the point where they exit from the appliance.

13. LIGHTNING

To protect your product from a lightning storm, or when it is left unattended and unused for long periods of time, unplug it from the wall outlet and disconnect the antenna or cable system. This will prevent damage to the product due to lightning and power-line surges.

14. POWER LINES

An outside antenna system should not be located in the vicinity of overhead power lines or other electric light or power circuits, or where it can fall into such power lines or circuits. When installing an outside antenna system, extreme care should be taken to keep from touching such power lines or circuits as contact with them might be fatal.

15. OVERLOADING

Do not overload wall outlets and extension cords as this can result in a risk of fire or electric shock.

16. OBJECT AND LIQUID ENTRY

Never push objects of any kind into this product through openings as they may touch dangerous voltage points or short out parts that could result in fire or electric shock. Never spill or spray any type of liquid on the product.

17. OUTDOOR ANTENNA GROUNDING

If an outside antenna is connected to the product, be sure the antenna system is grounded so as to provide some protection against voltage surges and built-up static charges. Section 810 of the National Electric Code, ANSI/NFPA 70, provides information with respect to proper grounding of the mast and supporting structure, grounding of the lead-in wire to an antenna discharge product, size of grounding conductors, location of antenna discharge product, connection to grounding electrodes and requirements for grounding electrodes.

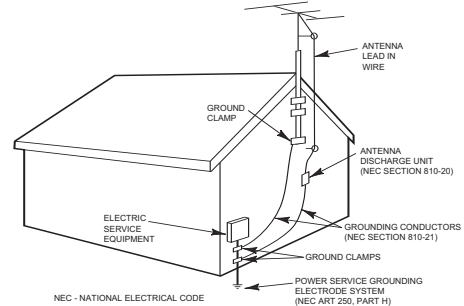

EXAMPLE OF ANTENNA GROUNDING AS PER NATIONAL ELECTRICAL CODE

18. SERVICING

Do not attempt to service this product yourself as opening or removing covers may expose you to dangerous voltage or other hazards. Refer all servicing to qualified service personnel.

19. REPLACEMENT PARTS

When replacement parts are required, be sure the service technician uses replacement parts specified by the manufacturer or those that have the same characteristics as the original part. Unauthorized substitutions may result in fire, electric shock or other hazards.

20. SAFETY CHECK

Upon completion of any service or repairs to this product, ask the service technician to perform safety checks to determine that the product is in proper operating condition.

21. WALL OR CEILING MOUNTING

The product should be mounted to a wall or ceiling only as recommended by the manufacturer.

22. DAMAGE REQUIRING SERVICE

Unplug the product from the wall outlet and refer servicing to qualified service personnel under the following conditions:

- When the power-supply cord or plug is damaged.
- If liquid has been spilled or objects have fallen into the product.
- If the product has been exposed to rain or water.
- If the product does not operate normally by following the operating instructions. Adjust only those controls that are covered by the operating instructions, as an adjustment of other controls may result in damage and will often require extensive work by a qualified technician to restore the product to its normal operation.
- If the product has been dropped or the cabinet has been damaged.
- When the product exhibits a distinct change in performance—this indicates a need for service.

23. HEAT

The product should be situated away from heat sources such as radiators, heat registers, stoves or other products (including amplifiers) that produce heat.

24. NOTE TO CATV SYSTEM INSTALLER

This reminder is provided to call the CATV system installer's attention to Article 820-40 of the NEC that provides guidelines for proper grounding and, in particular, specifies that the cable ground shall be connected to the grounding system of the building, as close to the point of cable entry as practical.

LOCATION OF CONTROLS

FRONT

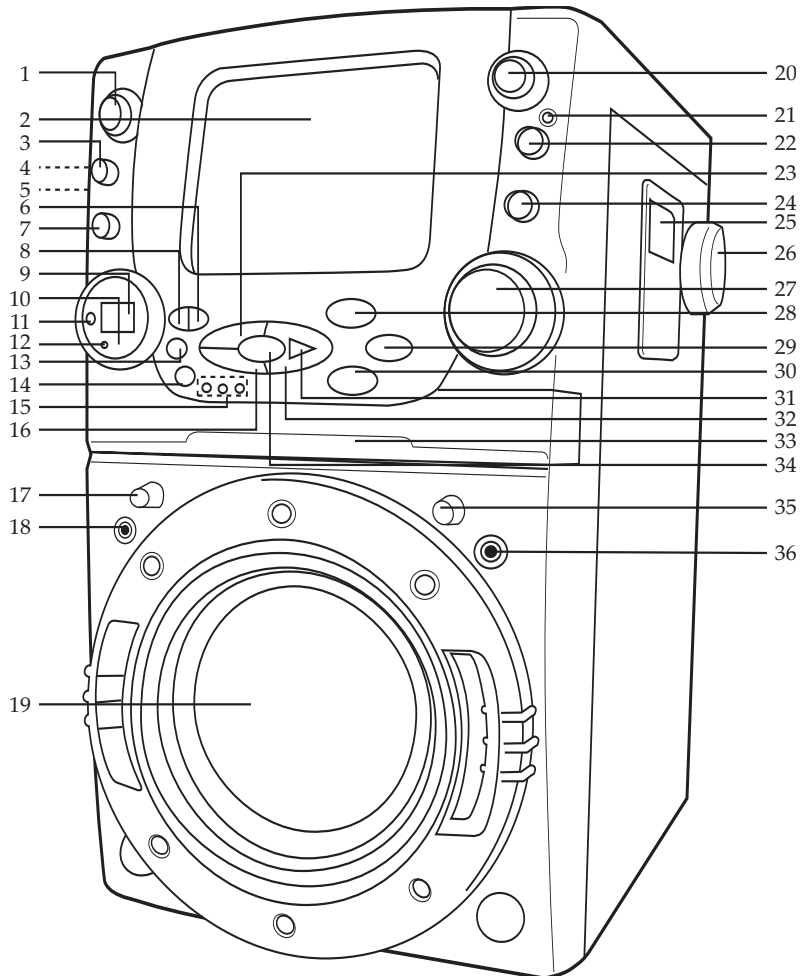

- | | |
|---|----------------------------------|
| 1. MONITOR ON/OFF Switch | 19. Front Speaker |
| 2. Monitor | 20. FUNCTION (AUX/CD/CDG) Switch |
| 3. ECHO Control | 21. CDG Indicator |
| 4. MIC Holder (Side of Unit) | 22. TONE Control |
| 5. Carrying Handle (Side of Unit) | 23. SKIP/SEARCH ►► Button |
| 6. OPEN/CLOSE Button | 24. BALANCE Control |
| 7. AVC (Auto Voice) Control | 25. Carrying Handle |
| 8. DISC SKIP Button | 26. Monitor Angle Control |
| 9. CD Track Display | 27. MASTER VOLUME Control |
| 10. POWER Button | 28. DISC 1 Button |
| 11. Remote Sensor | 29. DISC 2 Button |
| 12. POWER Indicator | 30. DISC 3 Button |
| 13. PROGRAM Button | 31. PLAYBACK Indicator |
| 14. REPEAT Button | 32. PLAY/PAUSE (►) Button |
| 15. REPEAT (ONE/DISC/ALL DISC) Indicators | 33. CD Carousel Tray |
| 16. SKIP/SEARCH ◄◄ Button | 34. STOP (■) Button |
| 17. MIC 1 VOLUME Control | 35. MIC 2 VOLUME Control |
| 18. MIC 1 Jack | 36. MIC 2 Jack |

REMOTE CONTROL

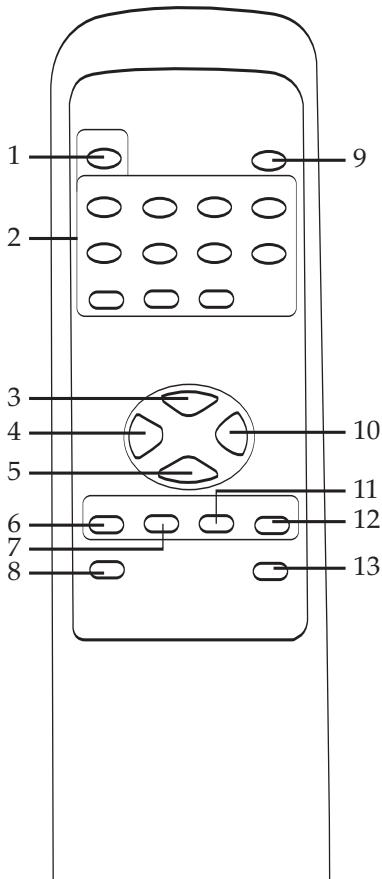

1. DISC SKIP Button
2. Number Buttons (0-9, 10+)
3. PLAY/PAUSE (▶||) Button
4. SKIP/SEARCH ◀◀ Button
5. STOP (■) Button
6. REPEAT Button
7. PROGRAM Button
8. VOLUME Down Button
9. OPEN/CLOSE Button
10. SKIP/SEARCH ▶▶ Button
11. INTRO Button
12. RANDOM Button
13. VOLUME Up Button

BATTERY OPERATION

The battery compartment is located on the rear of the remote control.

1. Remove the battery compartment door by pressing down and sliding the door off.
2. Insert two (2) AAA size batteries into the battery compartment as shown to the right. Be sure to observe the polarity markings which are engraved inside the battery compartment. If the batteries are inserted incorrectly, the remote control will not operate.
3. Replace the battery compartment door.

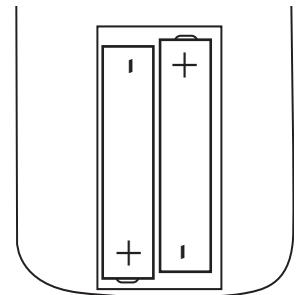

BATTERY PRECAUTIONS

Follow these precautions when using batteries in this device:

1. Use only the size and type of batteries specified.
2. Be sure to follow the correct polarity when installing the batteries as indicated in the battery compartment. Reversed batteries may cause damage to the device.
3. Do not mix different types of batteries together (e.g. Alkaline, Rechargeable and Carbon-zinc) or old batteries with fresh ones.
4. If the device is not to be used for a long period of time, remove the batteries to prevent damage or injury from possible battery leakage.
5. Do not try to recharge batteries not intended to be recharged; they can overheat and rupture. (Follow battery manufacturer's directions.)

POWER SOURCE

AC:
Use the AC polarized line cord included with the unit for operation on AC power. Insert into a conveniently located AC outlet having 120V, 60Hz.

NOTE: The AC plug supplied with the unit is polarized to help minimize the possibility of electric shock. If the AC plug does not fit into a nonpolarized AC outlet, do not file or cut the wide blade. It is the user's responsibility to have an electrician replace the obsolete outlet.

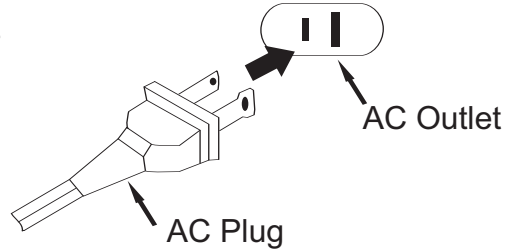

OPTIONAL CONNECTIONS

If you are using special CD+G (Graphics) discs in this Karaoke system, you can connect this unit to an external television set in order to see the on-screen graphics that are recorded on CD+G Karaoke discs on an external TV, as well as the built-in monitor. To see the on-screen graphics recorded on the CD+G disc on the built-in monitor, make sure the MONITOR ON/OFF Switch is set to the ON position.

The video cable has yellow RCA type plugs on each end. Please note that your TV set must have an RCA type Video Input jack in order to view the CD+G lyrics on your TV screen. You cannot connect this portable Karaoke system to your TV's coaxial antenna terminal.

Also note that on-screen lyrics are only available on special Karaoke compact discs that bear the CD+G mark.



Many newer TV sets have a set of Video and Stereo Audio jacks on the front panel for quick and easy connections without having to turn the TV set to gain access to the jacks on the back panel. If your TV set has such front panel A/V jacks, we suggest that you use those jacks to connect your portable Karaoke system.

After connecting the Video Out jack on this Karaoke system to the Video In jack on your TV with the included video cable, you have the following three choices:

1. Listen to the sound from the built-in speaker in this Karaoke system. In this case, no external audio connections are required.
2. If your TV has stereo audio input jacks, you can connect the Aux Out jacks on the back of this unit to the Audio In jacks on your TV. The stereo audio connection cable is included. In this case, the lyrics from the CD+G disc will appear on your TV screen and/or monitor and the sound from the disc will be heard from your TV speakers.

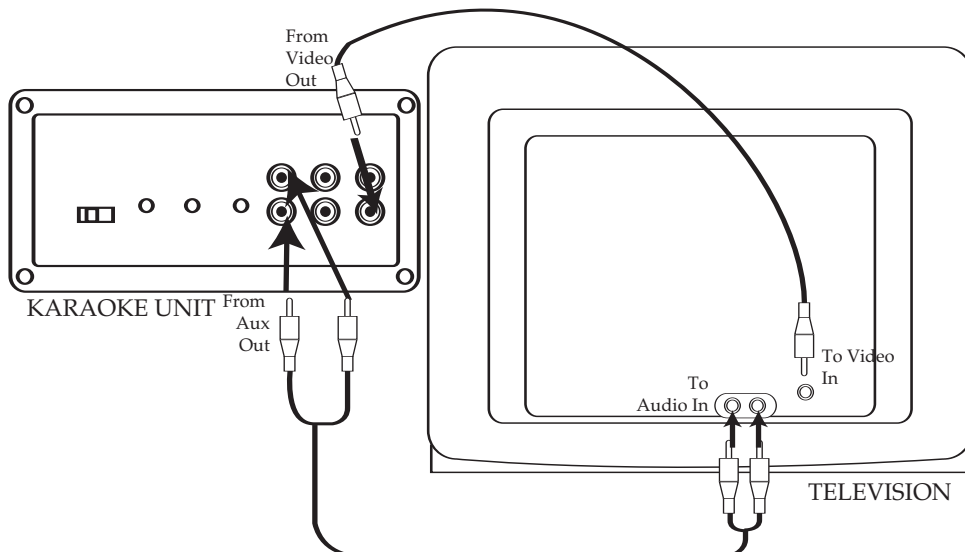

OPTIONAL CONNECTIONS (CONTINUED)

Note: If you have a mono TV with only one Audio In jack, you may have to purchase a “Y” adapter (stereo to mono) at your local electronics accessories store in order to combine the Left and Right stereo channels from this portable Karaoke system to a single mono channel for connection to your mono TV.

3. You can connect the Aux Out jacks from this portable Karaoke system to the Aux In or Audio In jacks of your home stereo system to hear the sound through your home stereo speakers. Follow the instructions for your home stereo system to select the device connected to the external jacks as the audio source.

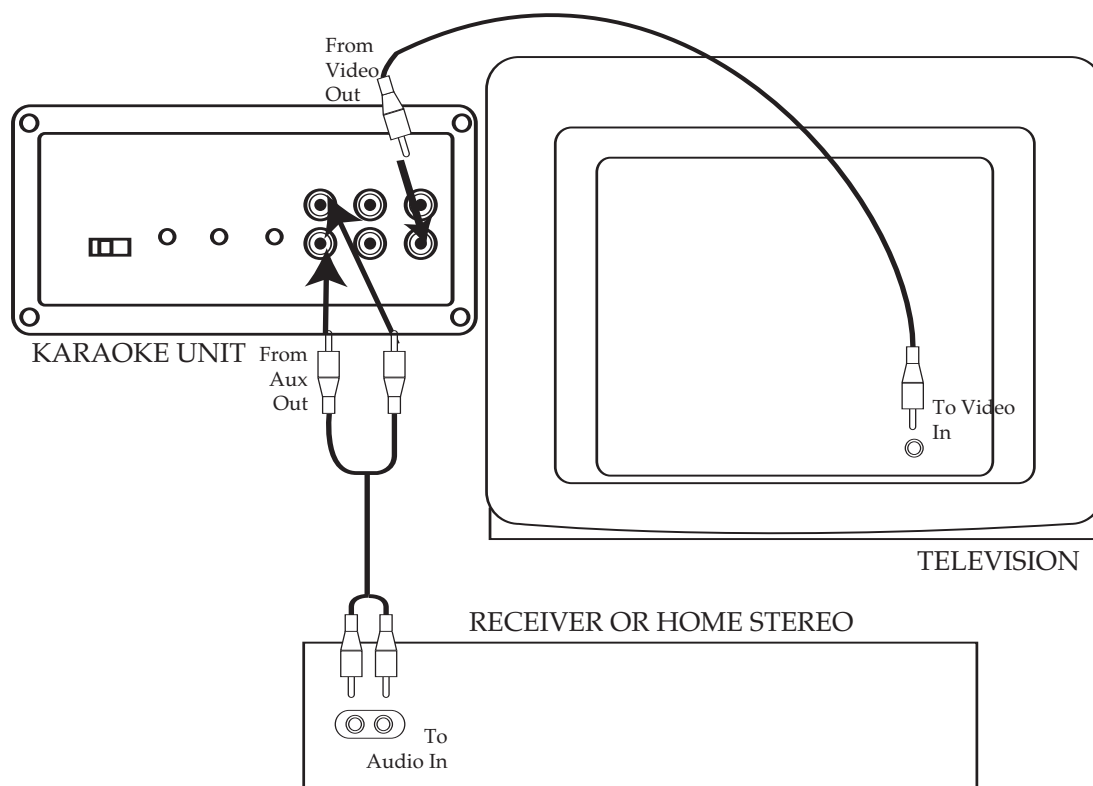

OPTIONAL CONNECTIONS (CONTINUED)

CONNECTING AN EXTERNAL AUDIO UNIT

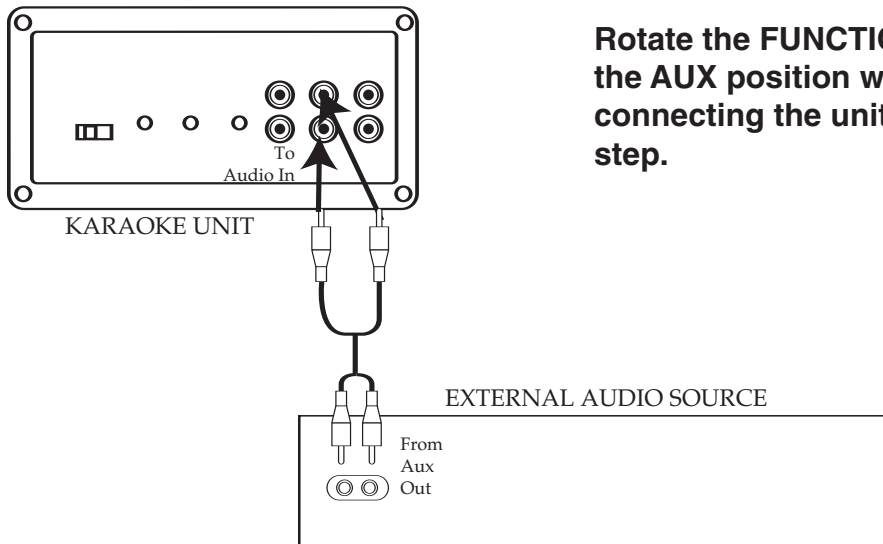

Rotate the **FUNCTION** switch to the **AUX** position when connecting the unit as per this step.

NOTES:

- Connecting the unit to an external audio source will allow you to broadcast the external unit's sound through this unit's speaker(s).
- When connecting the external unit, refer to the owner's manual of the external unit, as well as this manual.
- When connecting the external unit, make sure the power is off and both units are unplugged before making any connections.

CONNECTING AN EXTERNAL VIDEO UNIT

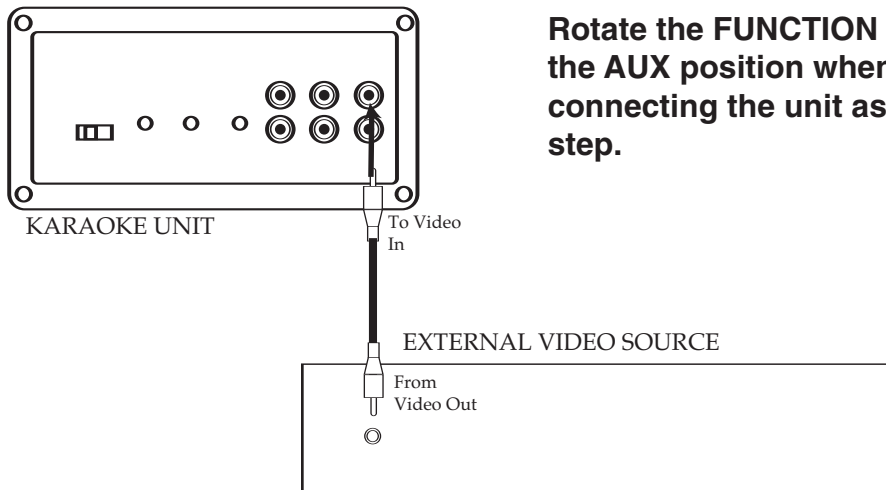

Rotate the **FUNCTION** switch to the **AUX** position when connecting the unit as per this step.

NOTES:

- Connecting the unit to an external video source will allow you to see the external unit's video through this unit's monitor.
- When connecting the external unit, refer to the owner's manual of the external unit, as well as this manual.
- When connecting the external unit, make sure the power is off and both units are unplugged before making any connections.

OPERATION

CONNECTING THE MICROPHONE

This unit has two microphone jacks which will allow you to sing along with your favorite songs. Before connecting, make sure the MIC 1 & 2 VOLUME controls are set to minimum.

ECHO CONTROL

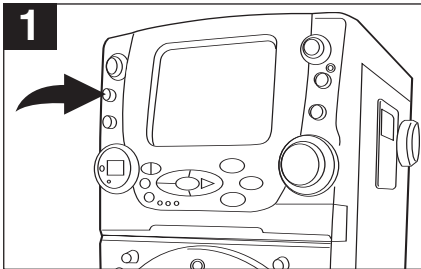

Rotate the ECHO control clockwise to increase the echo or counterclockwise to decrease the echo.

MIC ON/OFF SWITCH

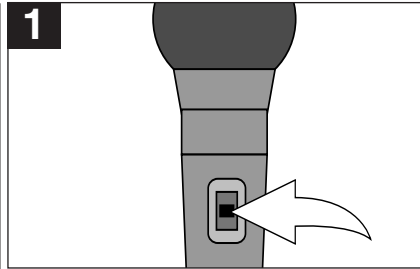

To turn the microphone on, slide the ON/OFF switch, located on the side of the microphone, to the ON position. To turn the microphone off, slide the ON/OFF switch to the OFF position.

TONE CONTROL

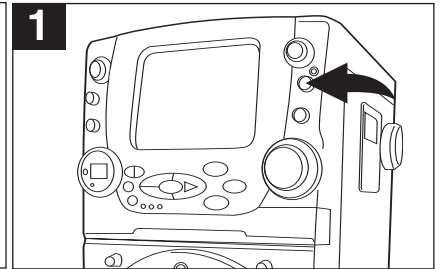

Rotate the TONE control clockwise to increase the tone (high) response or counterclockwise to decrease the tone response.

BALANCE CONTROL

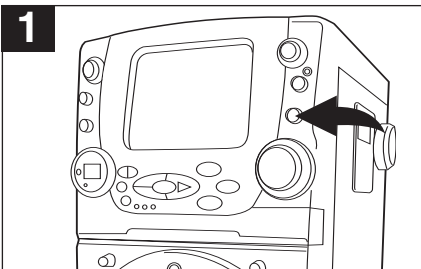

Rotate the BALANCE control clockwise to hear the music and vocals or counterclockwise to hear the music only.

NOTE: To use the BALANCE control, a CD+G disc must be used.

AUTO VOICE CONTROL (AVC)

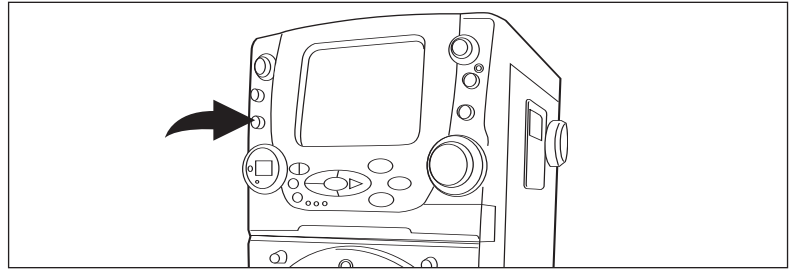

When the VOCAL feature is activated, the vocals on a multiplex recording are muted as soon as the singer begins singing into the microphone. When the singer stops singing, the vocals are automatically unmuted. Adjust the AUTO VOICE control for the best balance between playback and microphone levels.

IMPORTANT: This feature only works with multiplex CDs.

OPERATION (CONTINUED)

DISC SKIP

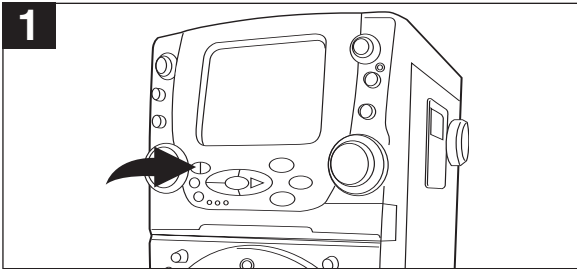

Press the DISC SKIP button to rotate the carousel and select a disc.

USING AN EXTERNAL UNIT

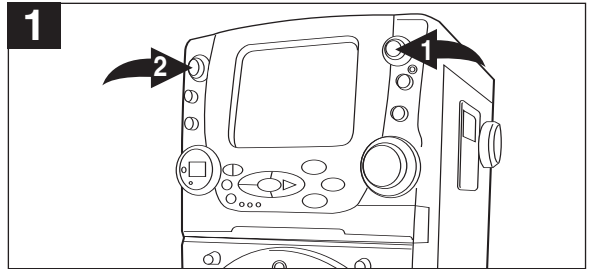

Connect an external unit to the AUX/VIDEO IN jacks on the rear of the unit. Rotate the FUNCTION switch ❶ to the AUX position to output the external unit's sound through this unit's speaker(s). To output the external unit's video through this unit's monitor, rotate the FUNCTION switch ❶ to the AUX position and the MONITOR ON/OFF switch ❷ to the ON position.

MONITOR ANGLE CONTROL

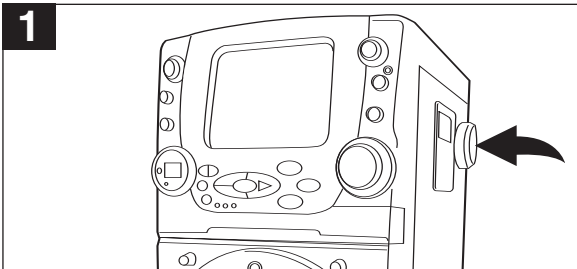

Gently pull out the Monitor Angle control and rotate to adjust the viewing angle of the monitor.

SPEAKER SWITCH

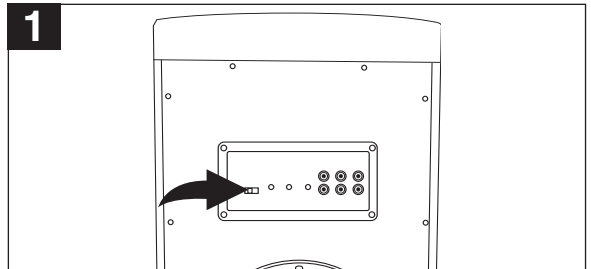

Slide the SPEAKER switch on the rear of the unit to the desired position for the audio output:
FRONT: Front speaker only.
FRONT & BACK: Both speakers.
BACK: Back speaker only.

MONITOR ON/OFF SWITCH

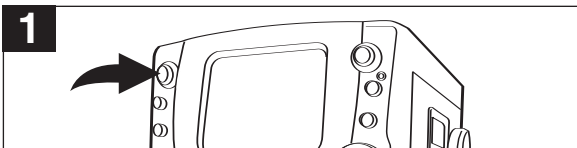

Rotate to the ON position to turn the monitor on. Rotate to the OFF position to turn the monitor off.

INSERT/REMOVE DISCS

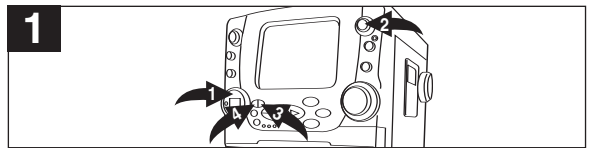

To insert discs, press the POWER button ❶ to turn the unit on and rotate the FUNCTION switch ❷ to the CD/CDG position. Press the OPEN/CLOSE button ❸ to open the CD carousel door and insert CDs with the label side facing upward. Note the disc location number(s) in the compartment as they correspond to the DISC 1, 2 and 3 buttons. Press the DISC SKIP button ❹ to rotate the tray and insert a third disc (if desired). Press the OPEN/CLOSE button ❸ to close the CD carousel door. To remove discs, when in CD/CDG Stop mode, press the OPEN/CLOSE button ❸ to open the CD carousel door and remove the discs. Press the DISC SKIP button ❹ to rotate the tray and remove the other disc. Press the OPEN/CLOSE button ❸ to close the CD carousel door.

OPERATION (CONTINUED)

PLAYING COMPACT DISCS

NORMAL PLAYBACK

(For karaoke, please refer to page 17.)

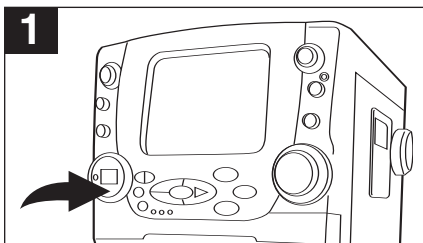

1 Press the POWER button to turn the unit on; the POWER indicator will light.

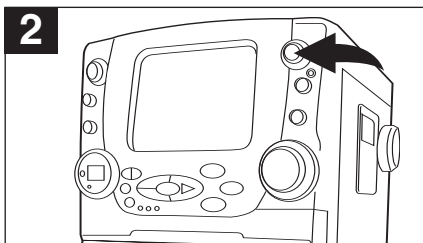

2 Rotate the FUNCTION switch to the CD/CDG position.

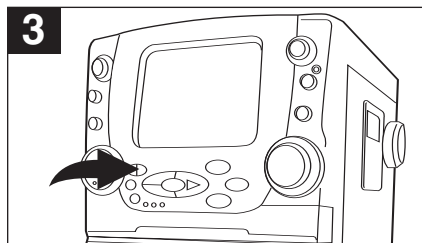

3 Press the OPEN/CLOSE button to open the CD Carousel Door and insert up to two CDs with the label side facing upward and the shiny side facing downward. Note the disc location number(s) in the compartment as they correspond to the DISC 1, 2 and 3 buttons.

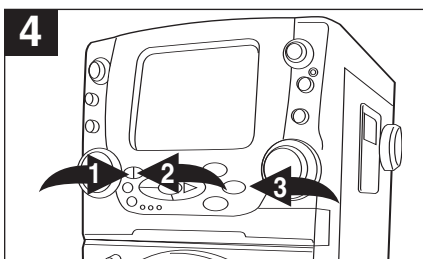

4 Press the DISC SKIP button ❶ to rotate the tray and insert a third disc (if desired). Close the CD Carousel Door by pressing the OPEN/CLOSE button ❷. Select a disc using the DISC 1, 2 and/or 3 buttons ❸.

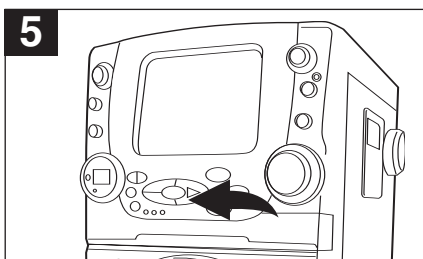

5 Press the PLAY/PAUSE (▶||) button to begin playback on Track 1; the PLAYBACK indicator will light.

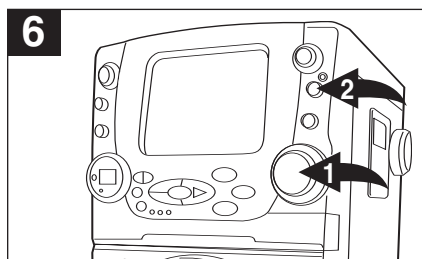

6 Adjust the MASTER VOLUME ❶ and TONE ❷ controls as desired. Playback will continue until all of the tracks of the discs inside the CD carousel have been played.

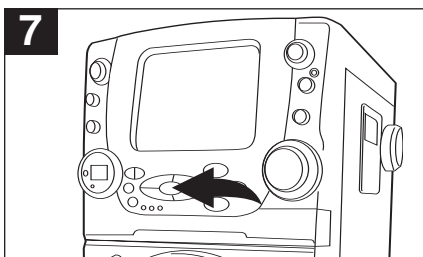

7 To stop playback before the disc ends, press the Stop (■) button. The disc will stop and the display will show the total number of tracks on the last disc played.

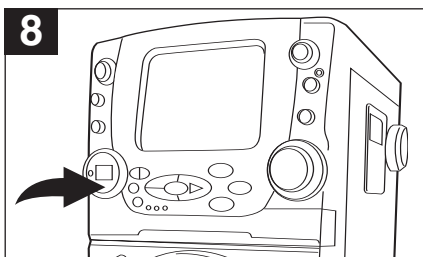

8 Press the POWER button to turn the unit off; the POWER indicator will turn off.

OPERATION (CONTINUED)

CD PAUSE CONTROL

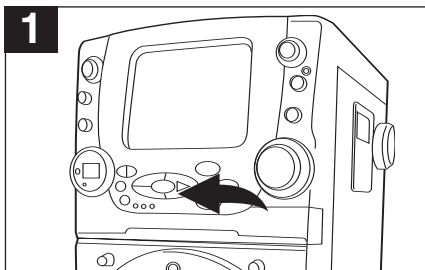

During CD playback, if you wish to pause the disc momentarily, press the PLAY/PAUSE (▶||) button. Playback stops but the disc continues to spin and the CD track display will blink.

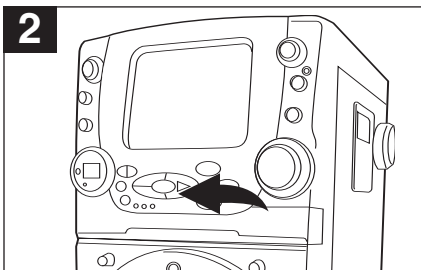

Press the PLAY/PAUSE (▶||) button again to release pause and resume normal CD playback; the CD track display will light.

TO BEGIN PLAYBACK FROM A SPECIFIC TRACK

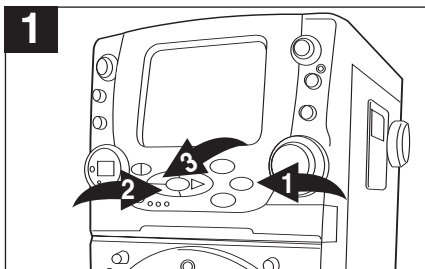

After you insert the discs into the CD player, press the DISC 1, 2 or 3 button ❶ to select the desired disc. The total number of tracks of the selected disc will appear on the display, you may press either the SKIP/SEARCH ◀▶ or ▶▶ button to select a specific track for playback.

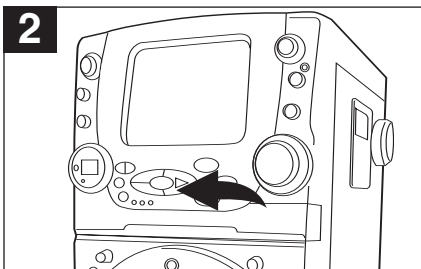

When the desired track number blinks in the display, press the PLAY/PAUSE (▶||) button. Playback will begin on the track you selected.

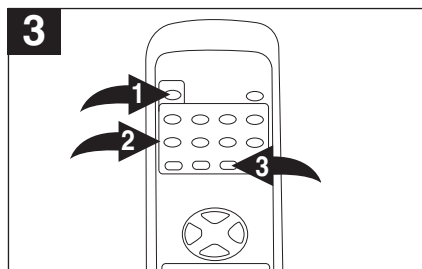

You can also select the desired disc by pressing the Disc Skip button ❶ on the remote repeatedly. Then use the Number buttons ❷ to directly select a track. If the track is over 9, press the 10+ button ❸ first. Playback will start automatically.

FORWARD/REVERSE SKIP TRACK AND HIGH-SPEED MUSIC SEARCH (◀▶/▶▶)

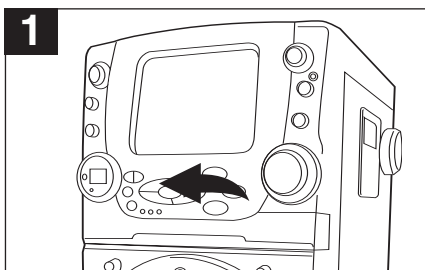

During playback, press the SKIP/SEARCH ▶▶ button once to advance the player to the beginning of the next track. Press the SKIP/SEARCH ▶▶ button repeatedly to advance the player to higher-numbered tracks.

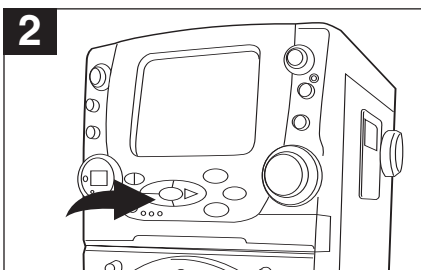

During playback, press the SKIP/SEARCH ◀▶ button once to move the player back to the beginning of the current track. Press the SKIP/SEARCH ◀▶ button repeatedly to move the player back to lower-numbered tracks.

3

STANDARD CD ONLY

During playback, depress and hold either the SKIP/SEARCH ▶▶ or ◀▶ button to move the player forward or backward within a track to locate a specific musical passage. The player will move forward or backward at high speed as long as the button is depressed. When you release the SKIP/SEARCH ▶▶ or ◀▶ button, normal playback will resume.

OPERATION (CONTINUED)

REPEAT PLAYBACK

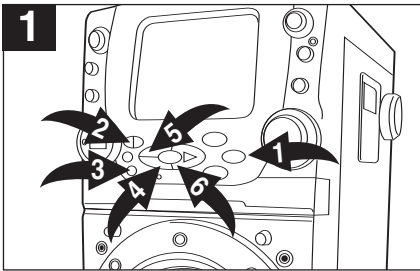

To repeat a single track, select the desired disc by pressing the Disc 1, 2, 3 **1** or Disc Skip **2** button. When the total tracks of the selected disc appear in the display, press the REPEAT button **3** once; the REPEAT ONE indicator will light. Press the SKIP/SEARCH **4** or **5** button to select the specific track that you wish to repeat. When the desired track number blinks in the display, press the PLAY/PAUSE **6** button to begin playback. The specific track you selected will be repeated continuously.

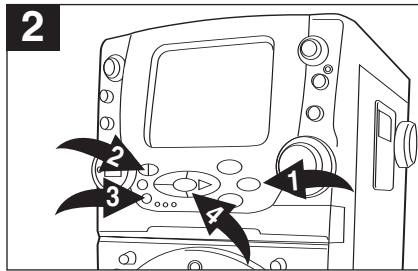

To repeat all of the tracks on one disc continuously, select the disc by pressing the Disc 1, 2, 3 **1** or Disc Skip **2** button. When the total tracks of the selected disc appear in the display, press the REPEAT button **3** twice; the REPEAT DISC indicator will light. Press the PLAY/PAUSE **4** button to repeat all of the tracks on the selected disc.

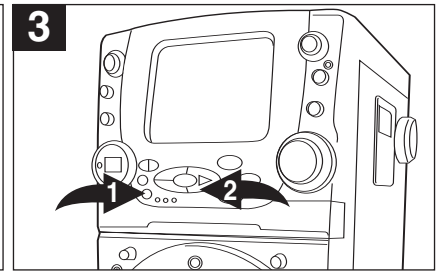

To repeat all of the tracks on all of the loaded discs continuously, press the REPEAT button **1** three times while in the CD/CDG Stop mode; the REPEAT ALL DISC indicator will light. Press the PLAY/PAUSE **2** button to begin repeating all discs.

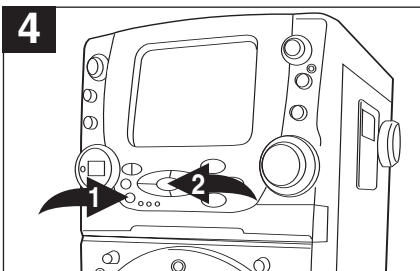

To cancel Repeat Playback, press the REPEAT button **1** until the REPEAT indicators go off or press the STOP **2** button to stop repeat playback.

OPERATION (CONTINUED)

PROGRAMMED PLAYBACK

The CD player in this unit has a 30 track programmable memory that allows you to program up to 30 tracks on any disc for playback in any desired order. You may program 30 different tracks or you may also program certain tracks to play more than once.

To perform programmed playback, proceed as follows:

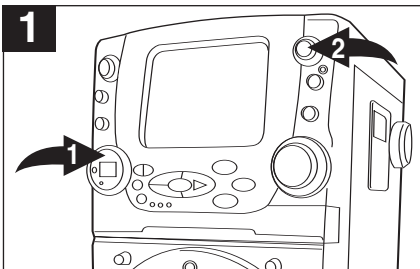

Press the POWER button ❶ to turn the unit on. Rotate the FUNCTION switch ❷ to the CDG position.

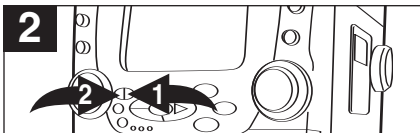

Press the OPEN/CLOSE button ❶ to open the CD Carousel Door and insert up to two CDs with the label side facing upward and the shiny side facing downward. Note the disc location number(s) in the compartment as they correspond to the Disc 1, 2 and 3 buttons. Press the Disc Skip button ❷ to rotate the tray and insert a third disc (if desired). Close the CD Carousel Door by pressing the OPEN/CLOSE button ❶.

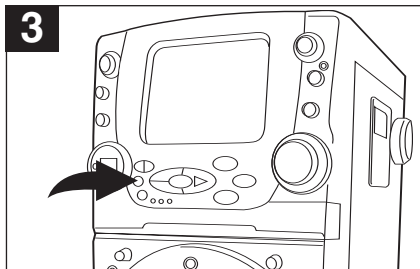

Press the PROGRAM button; "01" will appear in the display for two seconds, then "00" will blink in the display.

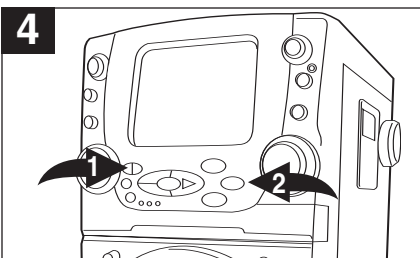

Press the DISC SKIP button ❶ or DISC 1, 2 or 3 button ❷ to select the desired disc.

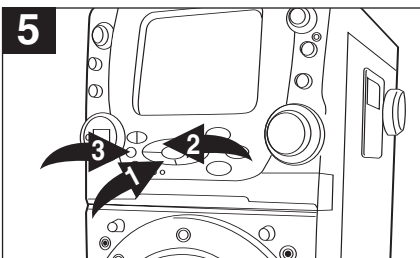

When "00" blinks again in the display, press either the SKIP/SEARCH ❶ or ❷ button to select the track you wish to program. When the desired track number appears in the display, press the PROGRAM button ❸ again.

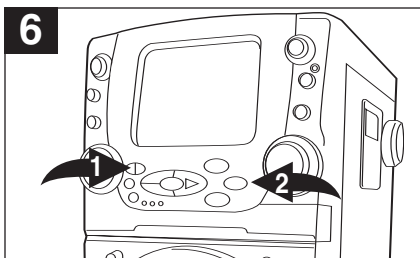

When "00" blinks again in the display, repeat steps 4 and 5 until you have programmed the desired track numbers into the CD Program Memory.



Press the PLAY/PAUSE (▶||) button ❶ to begin programmed playback; playback will begin on the first track that you programmed. The player will continue to play all of the tracks that you programmed in the order in which you programmed them. When the last programmed track has been played, the player will stop and the display will show the total number of tracks on the last disc played. If you press the PROGRAM button ❷ and then press the PLAY/PAUSE (▶||) button ❶ again, playback will start on the first track you programmed and will continue until all the programmed tracks have been played.

To clear programmed playback, while in the Stop mode, press the PROGRAM button followed by the STOP (■) button or open the CD door.

To check the programmed tracks, while in the Stop mode, press the PROGRAM button repeatedly to view the programmed tracks.

OPERATION (CONTINUED)

PROGRAMMED REPEAT

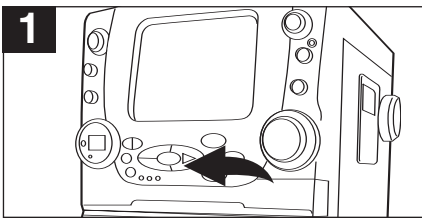

It is also possible to use the Program and Repeat functions together to repeat a specific program indefinitely. First, program the tracks you wish to hear in the order you wish to hear them, as described on the previous page. Press the PLAY/PAUSE (▶||) button to begin programmed playback.

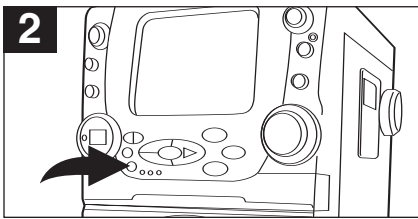

Then, press the REPEAT button repeatedly until the REPEAT ALL DISC indicator lights. The player will play the tracks you selected in the order in which you programmed them. When the last track in the program has been played, the entire program will begin again.

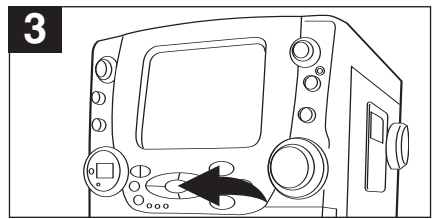

Programmed Repeat operation will continue indefinitely until you press the STOP (■) button or open the CD door.

INTRO PLAYBACK

Follow the instructions below to playback the first 10 seconds of each track:

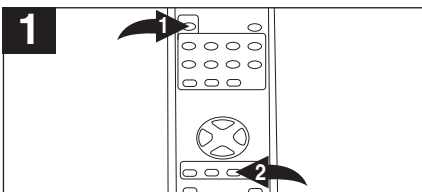

While in the Stop mode, press the DISC SKIP button ❶ on the remote to select the desired disc. When the total number of tracks on the selected disc appear in the display, press the INTRO button ❷; the unit will then play the first 10 seconds of each track of the selected disc and then stop.

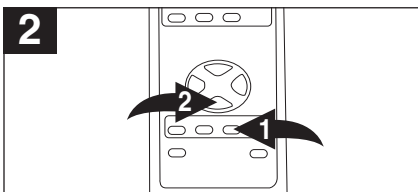

If you hear a song you want to hear in its entirety, press the INTRO button ❶ on the remote again or press the STOP (■) button ❷ to stop Intro playback.

RANDOM PLAYBACK

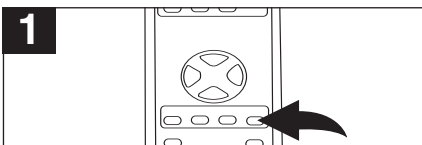

To play the tracks on the discs inside the CD carousel in a random order, while in the Stop mode, press the RANDOM button on the remote control. Playback will start automatically, the PLAYBACK Indicator will blink and all the tracks on the discs inside the CD carousel will play in a random order.

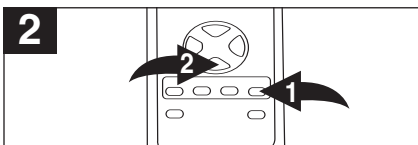

To cancel random playback, press the RANDOM button ❶ on the remote control again, the PLAYBACK indicator will light, or press the STOP (■) button ❷ to stop Random playback.

OPERATION (CONTINUED)

PLAYING A CD+G (COMPACT DISC + GRAPHICS) KARAOKE DISC

You can listen to a CD+G karaoke disc. CD+G discs combine the recorded music with an additional video track that displays the song lyrics on this monitor and/or an external TV, if connected. As the song plays, the words to be sung are highlighted on most CD+Gs.

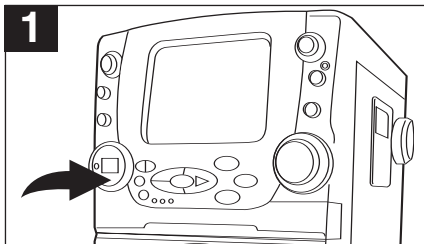

Press the POWER button to turn the unit on; the POWER indicator will light. Insert CD+G discs as shown on page 11 and insert the microphone(s) into the MIC jack(s).

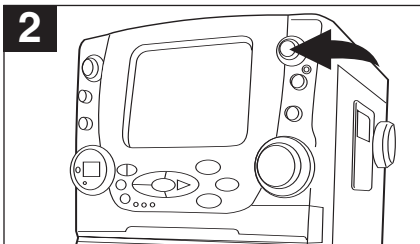

Rotate the FUNCTION switch to the CD/CDG position. You can connect the unit to a TV or TV and stereo as shown on pages 7 and 8.

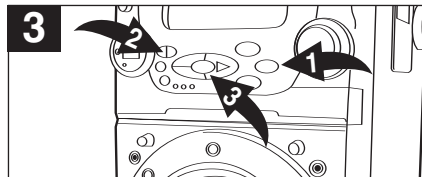

Select the desired CD+G disc by pressing the Disc 1, 2, 3 **1** or Disc Skip **2** button. Press the PLAY/PAUSE **3** button to start CD+G playback and the image and lyrics will appear on the monitor and/or external TV and the CDG indicator will light.

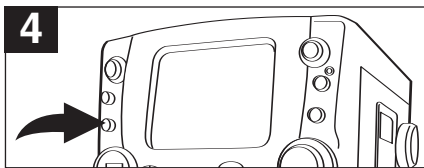

Rotate the AUTO VOICE control clockwise to suppress the vocal tracks on the disc being played when singing into the microphone. Rotate the AUTO VOICE control counterclockwise to have the vocal tracks on the disc play at normal volume.

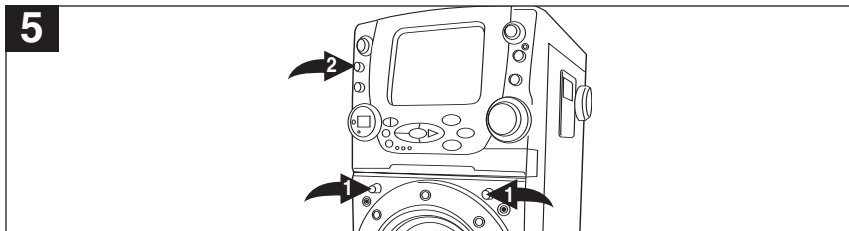

Adjust the MIC 1 & 2 VOLUME controls **1** as desired. Increasing this control will increase the volume of the microphone. Adjust the ECHO control **2** to add an echo effect to your voice. The ECHO control **2** is variable so add as much or as little reverb as desired. Sing or talk into the microphone and you will hear both the CD+G and the microphone.

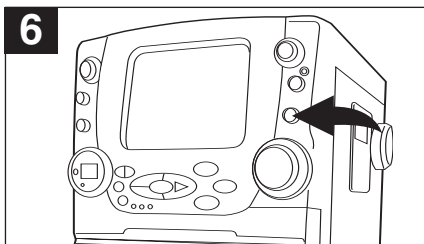

Rotate the BALANCE control clockwise to hear the vocals or counterclockwise to hear the music only. Be sure that the BALANCE control is set to the center position so that you hear both the vocal and music tracks with equal volume.

NOTES:

- The Program, Intro, Repeat and Random features on a CD+G disc operate the same as with a standard CD.
- During playback of a CD+G disc, the CDG indicator will light. During playback of a non-CD+G disc, the CDG indicator will not light.

OPERATION (CONTINUED)

INFORMATION ABOUT CD+G KARAOKE DISCS:

CD+G Karaoke discs are designed specifically for playback in special CD players that include a CD+G decoder, such as this unit. These discs contain the lyrics to each song and the lyrics will appear on your TV screen, line by line, as the disc is playing. Usually the words on the screen will change color in time with the music to help you sing along at the proper tempo, even if you do not know the song.

Some CD+G Karaoke discs have all of the songs recorded twice, first with music only, and then with music and vocals together. (This type of recording is called a "Multiplex" recording.) For example, if you purchase a CD+G disc containing four songs, tracks one through four may have the music only without vocals, and tracks five through eight might have the same four songs recorded with music on the left channel and the vocal tracks on the right channel.

NOTE: For Multiplex recordings, make sure the BALANCE control is set to the center position so you can hear both the vocal and music tracks at an equal level.

MICROPHONE FEEDBACK:

"Feedback" is a howling or screeching sound that occurs when the microphone comes too close to the speaker(s). To avoid microphone feedback, keep the microphone as far away from the speaker(s) as the microphone cable will allow. If you must bring the microphone close to the speaker(s), such as when you are changing a disc or adjusting one of the other controls on the front of the unit, set the microphone ON/OFF switch to the OFF position.

When watching a CD+G or watching the video from the VIDEO IN jack on the monitor screen, adjust the brightness, v-hold and contrast as follows

BRIGHTNESS

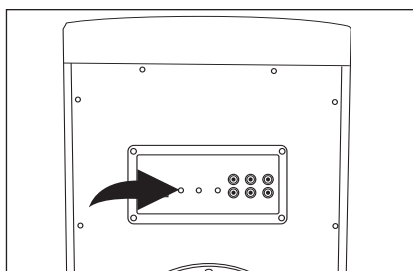

If the picture is too light or too dark, rotate to adjust the brightness.

CONTRAST

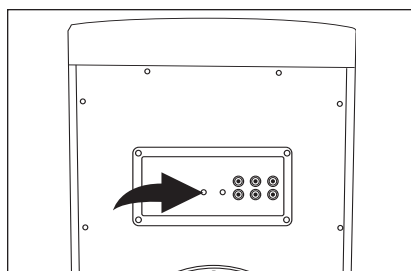

If the picture is too strong or too weak, rotate to adjust the contrast and clearly define the shades of blacks, grays and whites.

V-HOLD

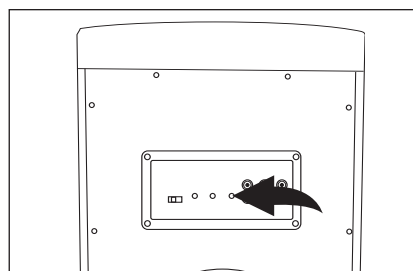

If the picture moves up and down or rolls, rotate to adjust the vertical hold.

CARE AND MAINTENANCE

Caring for Compact Discs

- Treat the compact disc carefully. Handle the compact disc only by its edges. Never allow your fingers to come in contact with the shiny, unprinted side of the compact disc.

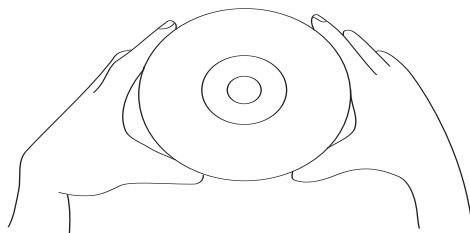

- Do not attach adhesive tape, stickers, etc. to the compact disc label.
- Clean the compact disc periodically with a soft, lint-free, dry cloth. Never use detergents or abrasive cleaners to clean the compact disc. If necessary, use a CD cleaning kit.
- If a compact disc skips or gets stuck on a section of the compact disc, it is probably dirty or damaged (scratched).
- When cleaning the compact disc, wipe in straight lines from the center of the compact disc to the outer edge of the disc. Never wipe in circular motions.

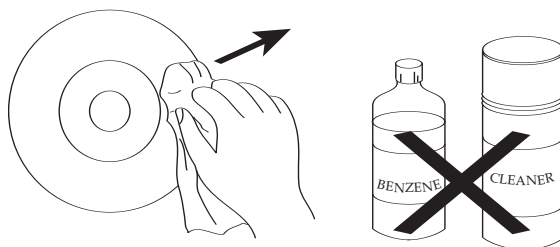

- This unit is designed to play only compact discs bearing the identification logo as shown here. Other discs may not conform to the CD standard and may not play properly. 
- Compact Discs should be stored in their cases after each use to avoid damage.
- Do not expose compact discs to direct sunlight, high humidity, high temperatures or dust, etc. Prolonged exposure or extreme temperatures can warp the compact disc.
- Do not stick or write anything on either side of the compact disc. Sharp writing instruments, or the ink, may damage the surface.

Cleaning the Unit

- To prevent fire or shock hazard, disconnect your unit from the AC power source when cleaning.
- The finish on your unit may be cleaned with a dust cloth and cared for as other furniture. Use caution when cleaning and wiping the plastic parts.
- Mild soap and a damp cloth may be used on the front panel

TROUBLESHOOTING GUIDE

Should this unit exhibit a problem, check the following before seeking service:

| Symptom | Possible Cause | Solution |
|---|--|--|
| Compact Disc Player | | |
| CD Player will not play. | CD is not installed or installed upside-down. | Insert CD with label side up. |
| CD skips while playing. | Disc is dirty or scratched. | Wipe disc with cloth or use another disc. |
| General | | |
| No sound. | Power cord disconnected. | Connect power cord. |
| Karaoke | | |
| Some vocals are still present when AUTO VOICE control is off. | Backup vocals are supposed to be included. | This is normal, only the main vocal(s) are to be reduced. |
| Feedback is heard when singing. | Microphone is too close to unit or MIC Volume is too high. | Move microphone away from unit or decrease MIC Volume. |
| Words do not appear on TV screen. | Using non-CD+G disc. | Use CD+G disc. |
| | Video cable connected improperly to TV. | Check connection; see pgs. 7-8. |
| | Source is not selected on TV. | Change TV source to match the location of karaoke connection (i.e. VIDEO 1, AUX IN, etc.). |
| | A CD+G disc is playing but the CDG indicator isn't on. | CD+G disc may need cleaning (see page 19). |

SPECIFICATIONS

GENERAL:

Power Source120V, 60Hz AC
Speaker.....2 x Impedance 8 Ohms
Dimensions13.25" (W) x 20" (H) x 14.5" (D)
Weight25 lbs
Output Power... ..11W

CD SECTION:

Disc Diameter4.72" (120mm)
.....3.15" (80mm) Single CD
Optical Source.....Class 1 Laser
D/A Conversion1-bit
Wavelength.780 nm

Specifications are subject to change without notice.

**FOR ADDITIONAL SET-UP OR OPERATING ASSISTANCE, PLEASE VISIT OUR WEBSITE AT
WWW.MEMOREXELECTRONICS.COM
OR CONTACT CUSTOMER SERVICE AT (954) 660-7100.**

**PLEASE KEEP ALL PACKAGING MATERIAL FOR AT LEAST 90 DAYS IN CASE YOU NEED TO
RETURN THIS PRODUCT TO YOUR PLACE OF PURCHASE OR TO MEMOREX.**

FOR PARTS AND ACCESSORIES, CONTACT FOX INTERNATIONAL AT 1-800-321-6993.

Memcorp, Inc.
Weston, FL
Printed in China

Visit our website at www.memorexelectronics.com

Free Manuals Download Website

<http://myh66.com>

<http://usermanuals.us>

<http://www.somanuals.com>

<http://www.4manuals.cc>

<http://www.manual-lib.com>

<http://www.404manual.com>

<http://www.luxmanual.com>

<http://aubethermostatmanual.com>

Golf course search by state

<http://golfingnear.com>

Email search by domain

<http://emailbydomain.com>

Auto manuals search

<http://auto.somanuals.com>

TV manuals search

<http://tv.somanuals.com>