

Memorex[®]

HOME AUDIO SYSTEM WITH CD PLAYER, CASSETTE RECORDER AND AM/FM STEREO RADIO

MODEL: MX3720

**BEFORE OPERATING THIS PRODUCT, PLEASE READ THESE
INSTRUCTIONS COMPLETELY.**

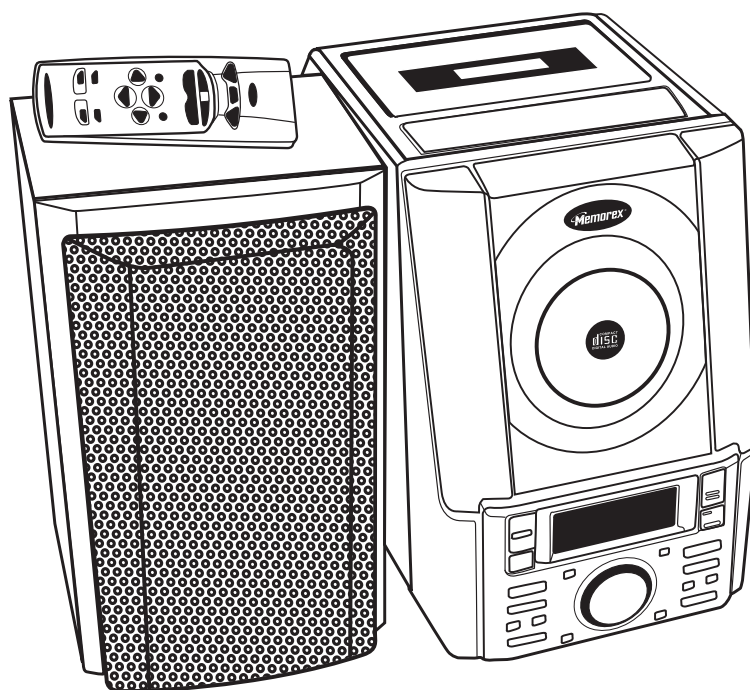

OPERATING INSTRUCTIONS

WARNING

TO PREVENT FIRE OR SHOCK HAZARD, DO NOT USE THIS PLUG WITH AN EXTENSION CORD, RECEPTACLE OR OTHER OUTLET UNLESS THE BLADES CAN BE FULLY INSERTED TO PREVENT BLADE EXPOSURE. TO PREVENT FIRE OR SHOCK HAZARD, DO NOT EXPOSE THIS APPLIANCE TO RAIN OR MOISTURE.



The lightning flash with arrowhead symbol, within an equilateral triangle is intended to alert the user to the presence of uninsulated 'dangerous voltage' within the product's enclosure that may be of sufficient magnitude to constitute a risk of electric shock to persons.

CAUTION

**RISK OF ELECTRIC SHOCK
DO NOT OPEN**

CAUTION: TO REDUCE THE RISK OF ELECTRIC SHOCK DO NOT REMOVE COVER (OR BACK), NO USER SERVICEABLE PARTS INSIDE REFER SERVICING TO QUALIFIED SERVICE PERSONNEL.



The exclamation point within an equilateral triangle is intended to alert the user to the presence of important operating and maintenance (servicing) instructions in the literature accompanying the appliance.

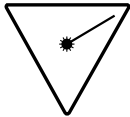

DANGER:

Invisible and hazardous laser radiation when open and interlock failed or defeated. Avoid direct exposure to beam.

1. Read these instructions.
2. Keep these instructions.
3. Heed all warnings.
4. Follow all instructions.
5. Do not use this apparatus near water.
6. Clean only with dry cloth.
7. Do not block any ventilation openings. Install in accordance with the manufacturer's instructions.
8. Do not install near any heat sources such as radiators, heat registers, stoves, or other apparatus (including amplifiers) that produce heat.
9. Do not defeat the safety purpose of the polarized or grounding-type plug. A polarized plug has two blades with one wider than the other. A grounding type plug has two blades and a third grounding prong. The wide blade or the third prong are provided for your safety. If the provided plug does not fit into your outlet, consult an electrician for replacement of the obsolete outlet.
10. Protect the power cord from being walked on or pinched particularly at plugs, convenience receptacles, and the point where they exit from the apparatus.
11. Only use attachments / accessories specified by the manufacturer.
12. Unplug this apparatus during lightning storms or when unused for long periods of time.
13. Refer all servicing to qualified service personnel. Servicing is required when the apparatus has been damaged in any way, such as power-supply cord or plug is damaged, liquid has been spilled or objects have fallen into the apparatus, the apparatus has been exposed to rain or moisture, does not operate normally, has changed its performance, or has been dropped.
14. This appliance shall not be exposed to dripping or splashing water and that no object filled with liquids such as vases shall be placed on the apparatus.
15. Do not overload wall outlet. Use only power source as indicated.
16. Use replacement parts as specified by the manufacturer.
17. The product may be mounted to a wall only if recommended by the manufacturer.
18. Upon completion of any service or repairs to this product, ask the service technician to perform safety checks.

SAFETY INSTRUCTIONS

INFORMATION:

This equipment has been tested and found to comply with the limits for a Class B digital device, pursuant to Part 15 of the FCC Rules. These limits are designed to provide reasonable protection against harmful interference in a residential installation. This equipment generates, uses, and can radiate radio frequency energy and, if not installed and used in accordance with the instructions, may cause harmful interference to radio communications. However, there is no guarantee that interference will not occur in a particular installation. If this equipment does cause harmful interference to radio or television reception, which can be determined by turning the equipment off and on, the user is encouraged to try to correct the interference by one or more of the following measures:

- Reorient or relocate the receiving antenna.
- Increase the separation between the equipment and receiver.
- Connect the equipment into an outlet on a circuit different from that to which the receiver is connected.
- Consult the dealer or an experienced radio/TV technician for help.

LASER SAFETY: THIS UNIT EMPLOYS A LASER. ONLY QUALIFIED SERVICE PERSONNEL SHOULD ATTEMPT TO SERVICE THIS DEVICE DUE TO POSSIBLE EYE INJURY.

CAUTION: USE OF CONTROLS, ADJUSTMENTS OR PERFORMANCE PROCEDURE HEREIN MAY RESULT IN HAZARDOUS RADIATION EXPOSURE.

WARNING: DO NOT EXPOSE THIS APPLIANCE TO RAIN OR MOISTURE.

FCC WARNING:

This equipment may generate or use radio frequency energy. Changes or modifications to this equipment may cause harmful interference unless the modifications are expressly approved in the instruction manual. The user could lose the authority to operate this equipment if an unauthorized change or modification is made.

SURGE PROTECTORS:

It is recommended to use a surge protector for AC connection. Lightning and power surges ARE NOT covered under warranty for this product.

PREPARATION FOR USE

AC Operation

Unwind the AC power cord and extend it to its full length. Insert the small end of the AC power cord into the AC socket on the back cabinet of the unit. Insert the other end of the AC power cord into any convenient 120V 60Hz household outlet.

Please note that this unit is equipped with a polarized AC plug which has one blade wider than the other. This is a safety feature to reduce the likelihood of electric shock. This polarized AC plug will only fit in a polarized AC outlet. If you find that you cannot insert this plug into your outlet, you may have an obsolete non-polarized outlet. Please do not try to defeat this safety feature by using a non-polarized adapter or by filing the wider blade to make it fit into your outlet. If this plug does not fit into your outlet, you should contact a qualified licensed electrician to replace your obsolete outlet.

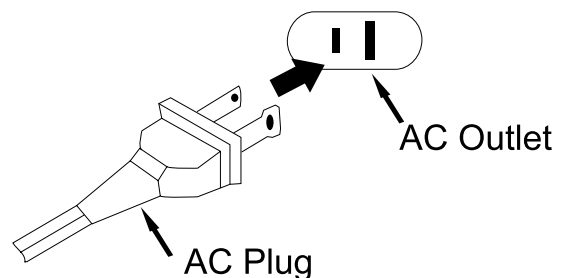

PREPARATION FOR USE (CONTINUED)

SPEAKER CONNECTION

1. Place the speakers in convenient locations on either side of the unit. Usually a distance of five to eight feet between speakers provides the best stereo effect, but this may vary depending on the size and acoustics of the room.
2. Locate the Speaker Terminals on the rear of the unit and connect the left speaker's solid red wires to the LEFT red (+) terminals and connect the striped black wires to the LEFT black (-) terminals.
3. To connect the speakers, press the terminal down, insert the speaker wire and press the terminal back to the lock position.
4. Pull lightly on the connection to make sure it is secure.
5. Repeat steps 2 and 3 for the right speaker.

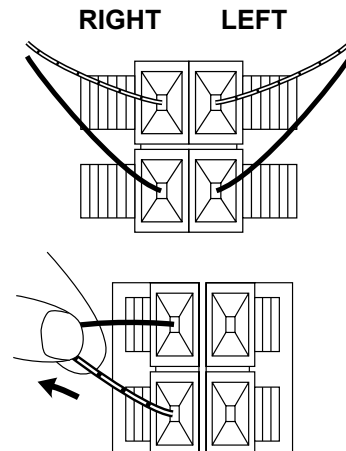

CAUTION: Only connect the speakers which are supplied with the unit. The use of any other or additional speakers may cause damage to the unit. Never operate the unit without the speakers connected.

AUX JACKS:

To connect an external unit, such as a CD recorder, VCR, etc., simply connect the external unit's left and right audio cables to the left and right AUX IN jacks on the rear of this unit. Press the AUX function button on the front of this unit to listen to the external unit.

BATTERY OPERATION

The battery compartment is located on the rear of the remote control.

- Remove the battery compartment door by pressing down and sliding the door.
- Insert two (2) AAA size batteries into the battery compartment as shown to the right. Be sure to observe the polarity markings which are engraved inside the battery compartment. If the batteries are inserted incorrectly, the remote control will not operate.
- Replace the battery compartment door.

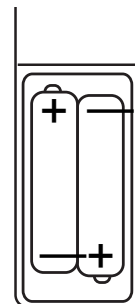

BATTERY PRECAUTIONS

Follow these precautions when using batteries in this device:

1. Use only the size and type of batteries specified.
2. Be sure to follow the correct polarity when installing the batteries as indicated in the battery compartment. Reversed batteries may cause damage to the device.
3. Do not mix different types of batteries together (e.g. Alkaline and Carbon-zinc) or old batteries with fresh ones.
4. If the device is not to be used for a long period of time, remove the batteries to prevent damage or injury from possible battery leakage.
5. Do not try to recharge batteries not intended to be recharged; they can overheat and rupture.
(Follow battery manufacturer's directions.)

REMOTE SENSOR:

To operate the unit with the remote control, point the remote at the remote sensor on the front of the main unit and press the appropriate button. The remote control has an effective operating range of approximately 15 feet and an angle of no more than 30°.

NOTE: Bright sunlight may interfere with the operation of the remote control.

LOCATION OF CONTROLS AND INDICATORS

MAIN UNIT

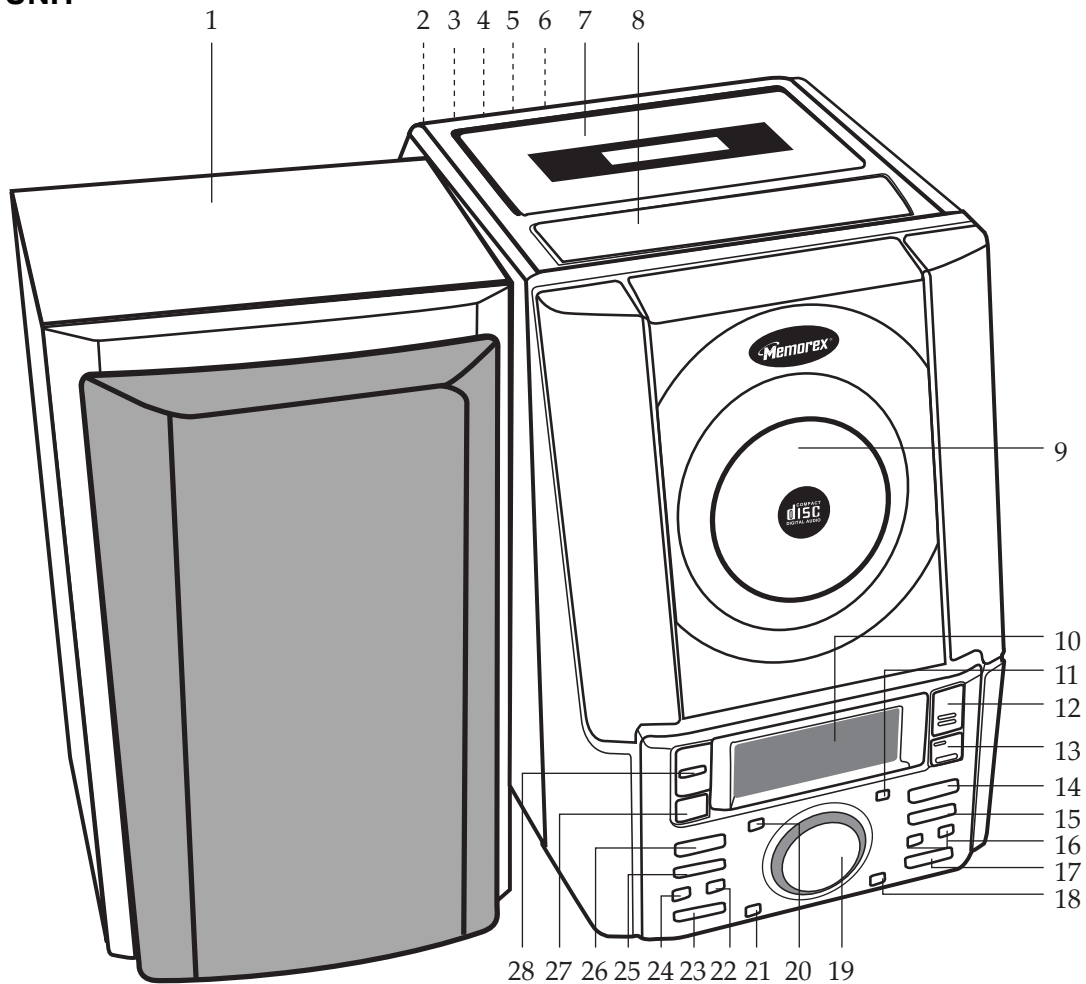

- | | |
|---------------------------------------------------------------|-----------------------------------------|
| 1. Speaker | 12. CD OPEN/CLOSE Button |
| 2. Headphone Jack (Top/rear of Unit) | 13. Sensor |
| 3. FM Antenna (Rear of Unit) | 14. PLAY/PAUSE (▶) Button |
| 4. FM MODE Switch (Rear of Unit) | 15. BAND/STOP(■) Button |
| 5. AUX IN Jacks (Rear of Unit) | 16. Tuning/CD SKIP/Search ▶▶/◀◀ Buttons |
| 6. Speaker Jacks (Rear of Unit) | 17. MEMORY/PROGRAM/CLOCK SET Button |
| 7. Cassette Compartment | 18. DISPLAY Button |
| 8. Cassette Button Compartment
(Buttons Under Compartment) | 19. VOLUME Buttons |
| PAUSE () | 20. REPEAT/PRESET UP Button |
| STOP/EJECT (■▲) | 21. SLEEP/TIMER Button |
| FAST FORWARD (▶▶) | 22. AUX Function Button |
| REWIND (◀◀) | 23. PRESET EQ Button |
| PLAY (▶) | 24. TAPE Function Button |
| RECORD (●) | 25. TUNER Function Button |
| 9. CD Compartment | 26. CD Function Button |
| 10. Display | 27. STANDBY Indicator |
| 11. RANDOM Button | 28. POWER Button |

LOCATION OF CONTROLS AND INDICATORS

REMOTE

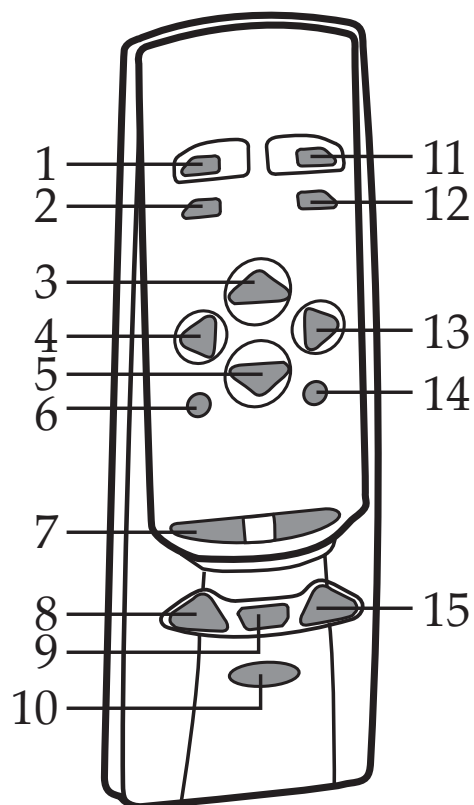

1. MUTE Button
2. REPEAT/REPEAT UP Button
3. PLAY/PAUSE (▶||) Button
4. Tuning CD SKIP/Search ◀◀ Button
5. Band/STOP(■) Button
6. PRESET EQ Button
7. VOLUME Buttons
8. TIMER Button
9. DISPLAY Button
10. POWER Button
11. PROGRAM/CLOCK SET Button
12. RANDOM Button
13. Tuning CD SKIP/Search ▶▶ Button
14. FUNCTION Button
15. SLEEP Button

OPERATING INSTRUCTIONS

SETTING THE CLOCK

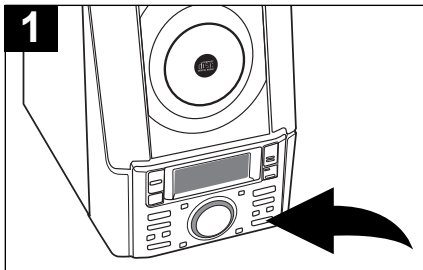

With the power off, press and hold the MEMORY/PROGRAM/CLOCK SET button; "24H" will blink.

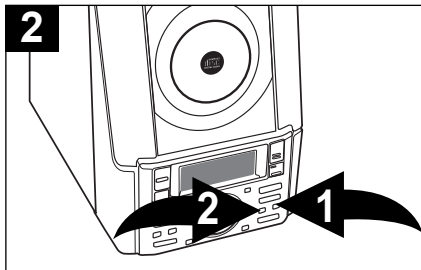

Press the Tuning/CD SKIP/Search (▶▶) ① or (◀◀) ② button to set the unit to the 24 hour (24H) mode (also known as military time, or 12 hour (12H) mode).

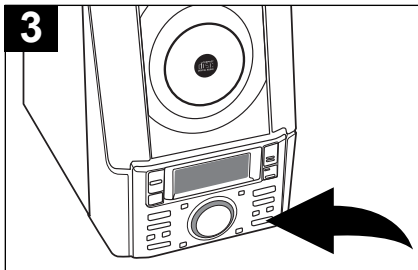

Press the MEMORY/PROGRAM/CLOCK SET button and the hours will blink.

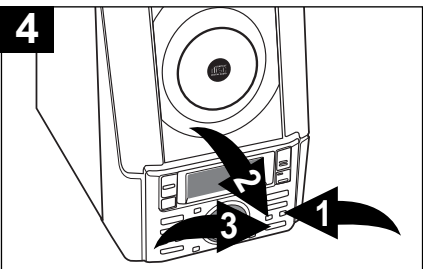

Press the Tuning/CD SKIP/Search (▶▶) ① or (◀◀) ② button to set the current hour, then press the MEMORY/PROGRAM/CLOCK SET button ③ again; the minute digits will blink.

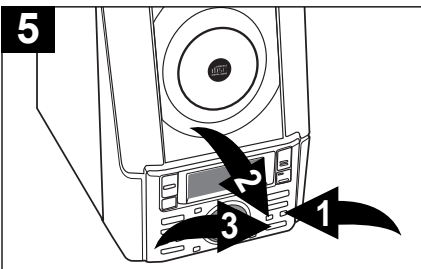

Press the Tuning/CD SKIP/Search (▶▶) ① or (◀◀) ② button to set the current minute. Press the MEMORY/PROGRAM/CLOCK SET button ③ and the time will be set.

NOTE: In the 12 hour mode the display will show AM and PM indicators. In the 24 hour mode there are no AM or PM indicators. "1:00PM" is displayed as "13:00", "6:00PM" is displayed as "18:00" and 12 midnight is displayed as "0:00". The 12 hour mode is used in the USA and Canada. The 24 hour mode is used in Europe, Asia and other countries.

PRESET EQ

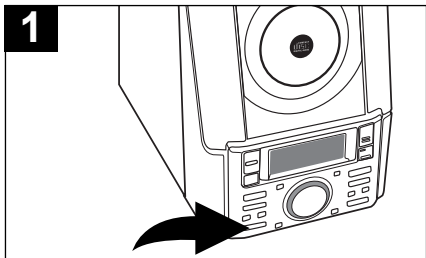

Press the PRESET EQ button to cycle through the preset EQ settings, or to turn the EQ off. Each press of the PRESET EQ button will cycle as follows: CLASSIC, ROCK, POP, Off.

DISPLAY BUTTON

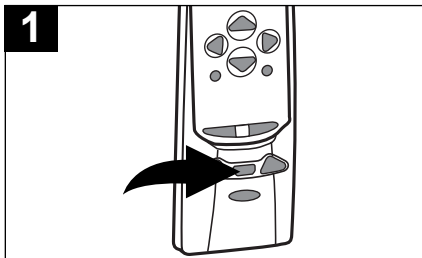

In the Off mode, press the DISPLAY button to cycle from the clock to the timer. In the On mode, press the DISPLAY button to cycle from the selected function to the clock and to the timer.

HEADPHONE JACK

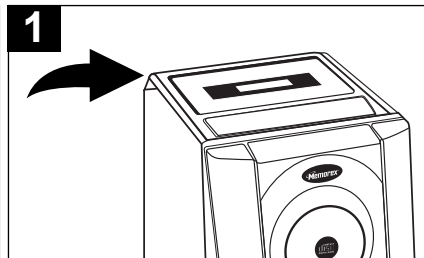

To listen to the unit through headphones, simply insert the headphones (not included) into the Headphones jack. The speakers will be disconnected when the headphones are plugged in.

OPERATING INSTRUCTIONS (CONTINUED)

LISTENING TO THE RADIO

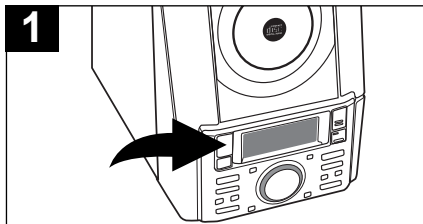

Press the POWER button to turn the unit on; the STANDBY indicator will go out.

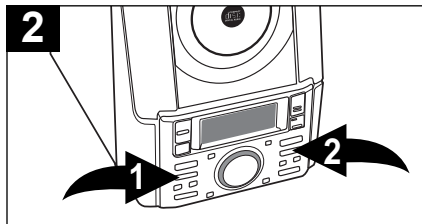

Press the TUNER Function button ❶; "TUNER" will appear in the display. Press the BAND/STOP button ❷ to select AM or FM.

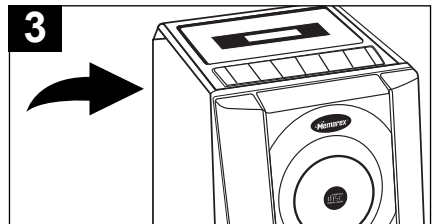

Slide the FM MODE switch on the rear of the unit to the ST or MONO position to select Stereo or mono when listening to an FM station.

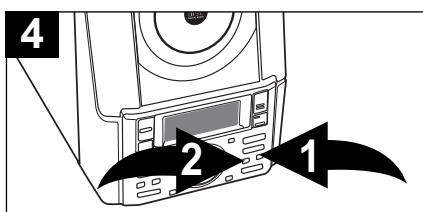

Press the Tuning/CD SKIP/Search ►► ❶ or ◀◀ ❷ button to select a station (see Tuning note below).
NOTE: If the FM band is selected and you have tuned to an FM Stereo station, the FM Stereo indicator will light in the display.

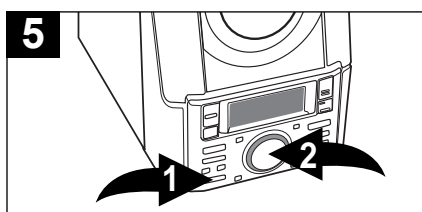

Adjust the PRESET EQ ❶ and VOLUME ❷ buttons as desired.

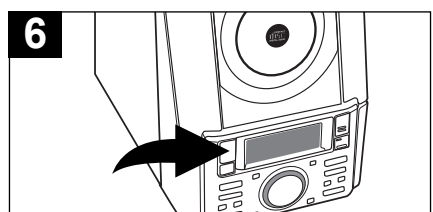

When you have finished listening, press the POWER button to turn the unit off; the STANDBY indicator will light.

TUNING:

MANUAL TUNING: Repeatedly press the Tuning/CD SKIP/ Search ►► or ◀◀ to manually advance the frequency in the display up or down until the desired frequency appears.

AUTOMATIC TUNING: Press and hold the Tuning/CD SKIP/ Search ►► or ◀◀ until the frequency in the display starts to scan, and then release the button; the tuner will search and then stop on the next strong station it finds. Repeat this procedure until the desired frequency appears in the display.

Hints for Better Reception:

FM - Make sure that the FM Wire Antenna is extended to its full length. You may have to vary the direction of the antenna to find the strongest signal for each FM station.

AM - The AM ferrite bar antenna is located inside the unit. It may be necessary to turn the unit slightly so that the internal antenna is pointing in the direction of the AM transmitter. You may have to experiment to find the position that provides the strongest reception for each of your favorite AM stations.

MUTE

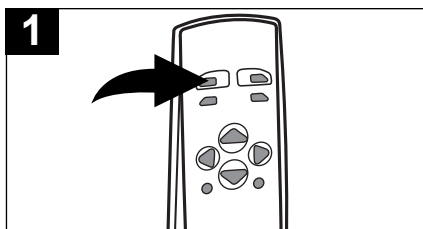

To temporarily mute the sound, press the MUTE button on the remote control; "MUTE" will appear in the display and the sound will be muted. Press the MUTE button again to restore the sound and "MUTE" will disappear from the display.

OPERATING INSTRUCTIONS (CONTINUED)

SETTING RADIO PRESETS

This unit can preset 10 AM and 10 FM radio stations for convenient recall.

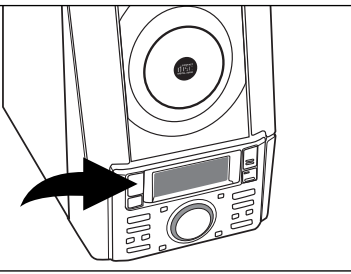
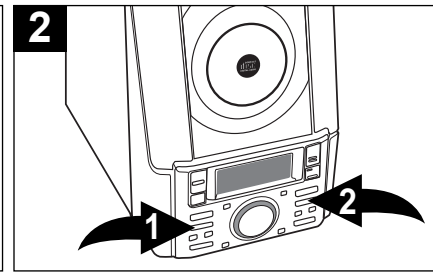
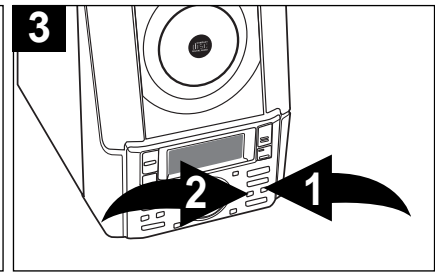
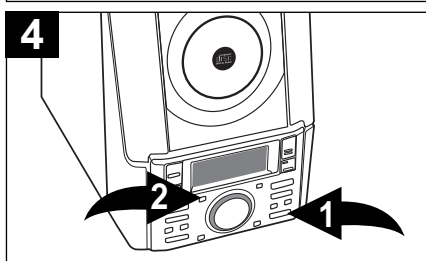
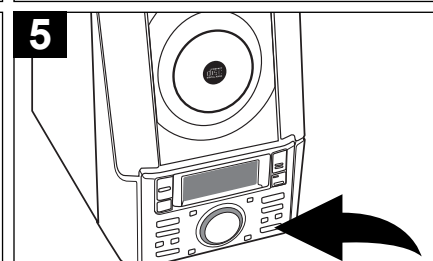
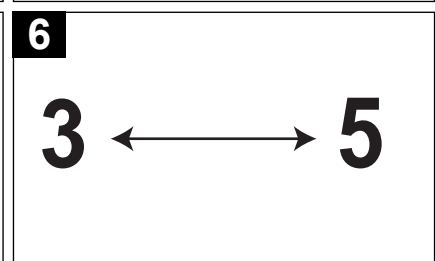
		
<p>Press the POWER button to turn the unit on; the STANDBY indicator will go out.</p>	<p>Press the TUNER Function button ❶; "TUNER" will appear in the display. Press the BAND/STOP(■) button ❷ to select AM or FM.</p>	<p>Use the Tuning/CD SKIP/ Search (▶▶) ❶ or (◀◀) ❷ button to select a station.</p>
		
<p>Press the MEMORY/PROGRAM/CLOCK SET button ❶. Within four seconds, press the REPEAT/PRESET UP button ❷ until the desired memory number appears on the display.</p>	<p>Press the MEMORY/PROGRAM/CLOCK SET button again to set the station in the selected memory.</p>	<p>Repeat steps 3 through 5 to program up to 10 stations in each band, if desired. In case the main power supply is interrupted, the memory presets will be erased.</p>

RECALLING RADIO PRESETS

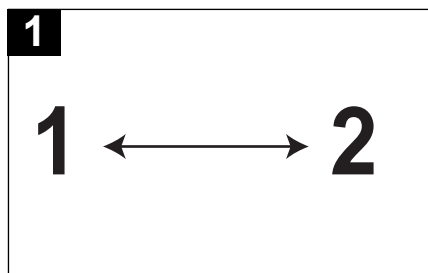
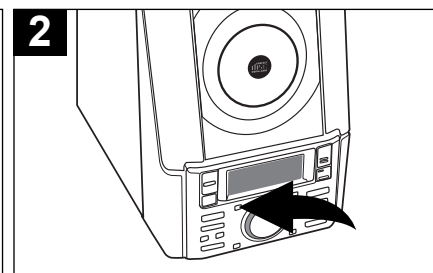
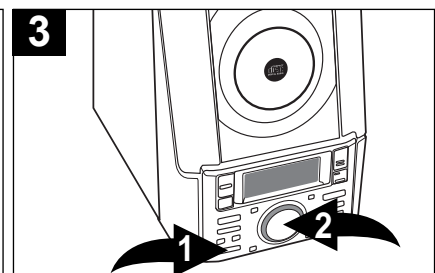
		
<p>Follow steps 1 and 2 above.</p>	<p>Press the REPEAT/PRESET UP button to select a preset; the station will automatically be tuned in.</p>	<p>Adjust the PRESET EQ ❶ and VOLUME ❷ buttons as desired.</p>

OPERATING INSTRUCTIONS (CONTINUED)

PLAYING COMPACT DISCS

NORMAL PLAYBACK

This unit can play standard compact discs, as well as CD-R and CD-RW Compact discs.

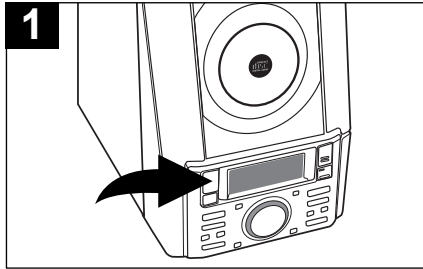

1 Press the **POWER** button to turn the unit on; the **STANDBY** indicator will go out.

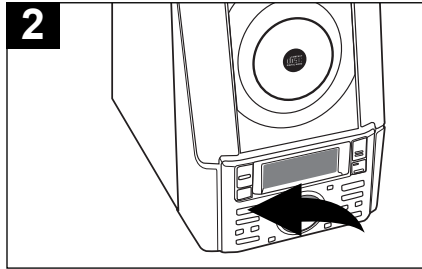

2 Press the **CD Function** button to select CD.

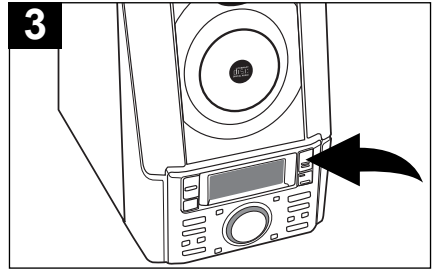

3 Press the **CD OPEN/CLOSE** button to open the CD compartment door. Gently press a CD onto the center spindle, with the printed label side facing out. Close the CD compartment door.

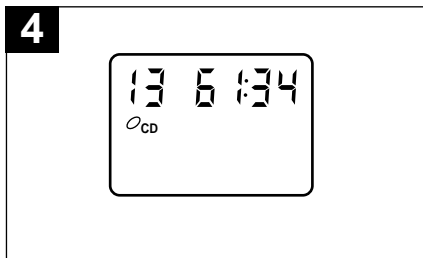

4 The CD player will read the table of contents on the disc and the total number of tracks and total playing time on the disc will appear in the display.

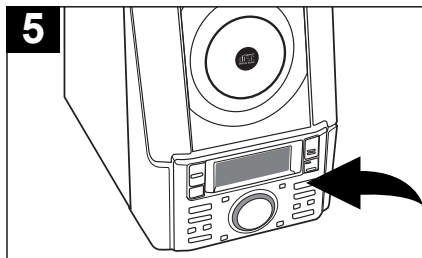

5 Press the **PLAY/PAUSE (▶||)** button to begin playback on Track 1.

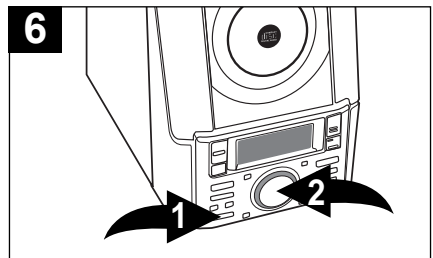

6 Adjust the **PRESET EQ ①** and **VOLUME ②** buttons as desired. Playback will continue until all the tracks on the disc have been played.

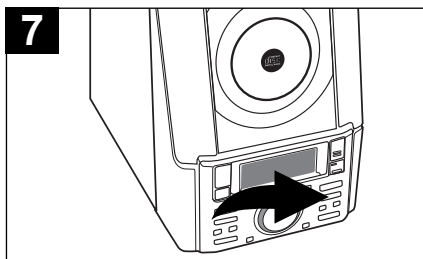

7 To stop playback before the disc ends, press the **BAND/STOP (■)** button. The disc will stop and the display will show the total number of tracks and playing time on the disc.

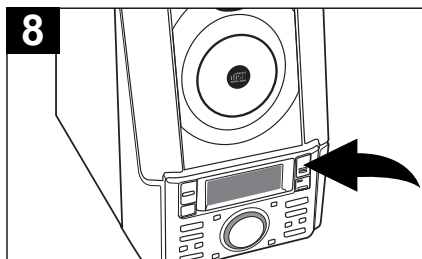

8 After the last track has been played, the disc stops automatically and the display shows the total number of tracks and playing time on the disc. If you are finished listening, press the **CD OPEN/CLOSE** button.

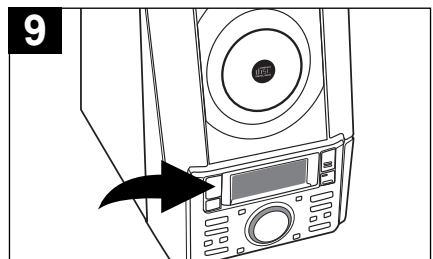

9 Remove your disc and press the **POWER** button to turn the unit off; the **STANDBY** indicator will light.

OPERATING INSTRUCTIONS (CONTINUED)

CD PAUSE CONTROL

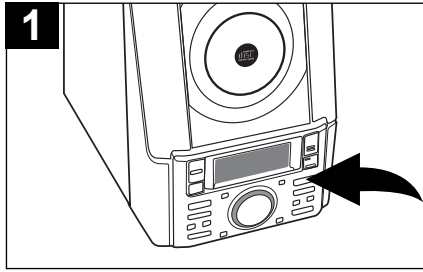

1 During CD playback, if you wish to pause the disc momentarily, press the PLAY/PAUSE (▶||) button again. Playback stops but the disc continues to spin and the time display will blink.

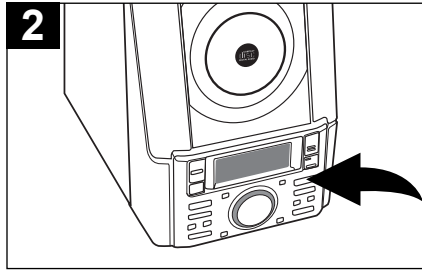

2 Press the PLAY/PAUSE (▶||) button again to release pause and resume normal CD playback.

RANDOM PLAYBACK

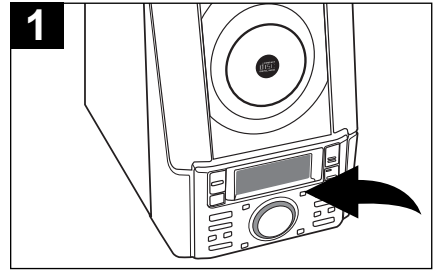

1 To randomly play back all the tracks on the disc, press the RANDOM button; "RANDOM" will appear in the display and the tracks will play randomly.

TO BEGIN PLAYBACK FROM A SPECIFIC TRACK

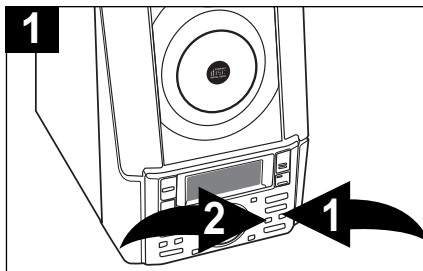

1 After you insert the disc into the CD player and the total number of tracks appear on the display, you may press either the Tuning/CD SKIP/Search (▶▶) ① or (◀◀) ② button to select a specific track for playback.

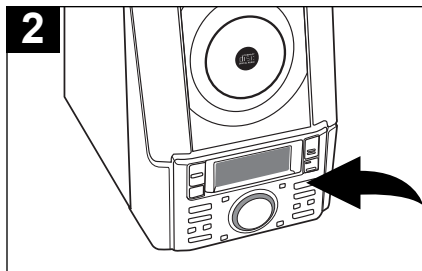

2 When the desired track number appears in the display, press the PLAY/PAUSE (▶||) button. Playback will begin on the track you selected.

FORWARD/REVERSE SKIP TRACK AND HIGH-SPEED MUSIC SEARCH (▶▶/◀◀)

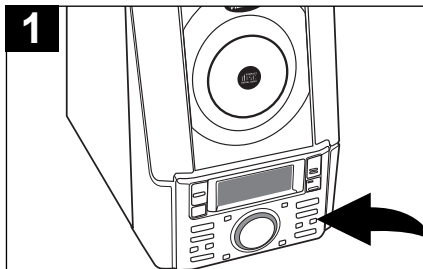

1 During playback, press the Tuning/CD SKIP/Search (▶▶) button once to advance the player to the beginning of the next track. Press the Tuning/CD SKIP/Search (▶▶) button repeatedly to advance the player to higher number tracks.

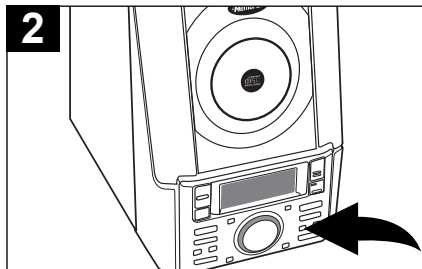

2 During playback, press the Tuning/CD SKIP/Search (◀◀) button once to move the player back to the beginning of the current track. Press the Tuning/CD SKIP/Search (◀◀) button repeatedly to move the player back to lower numbered tracks.

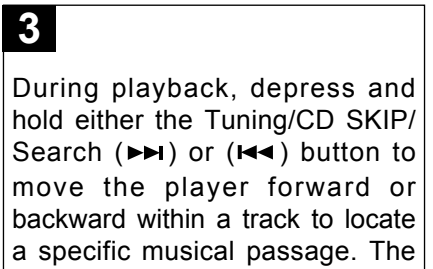

3 During playback, depress and hold either the Tuning/CD SKIP/Search (▶▶) or (◀◀) button to move the player forward or backward within a track to locate a specific musical passage. The player will move forward or backward at high speed as long as the button is depressed. When you release the Tuning/CD SKIP/Search (▶▶) or (◀◀) button, normal playback will resume at that point.

OPERATING INSTRUCTIONS (CONTINUED)

REPEAT PLAYBACK

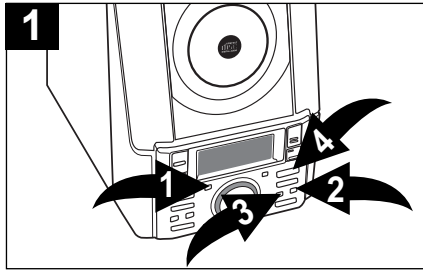

To repeat a single track, press the REPEAT/PRESET UP button ❶ twice; "REPEAT" will blink in the display. Press the Tuning/CD SKIP/Search (▶▶) ❷ or (◀◀) button ❸ to select the specific track that you wish to repeat. When the desired track number appears in the display, press the PLAY/PAUSE (▶||) button ❹ to begin playback. The specific track you selected will be repeated continuously.

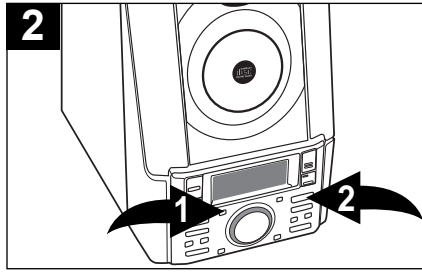

To repeat all of the tracks on a disc continuously, press the REPEAT/PRESET UP button ❶ once; "REPEAT" will light solid in the display. Press the CD PLAY/PAUSE (▶||) button ❷ to begin all tracks repeat.

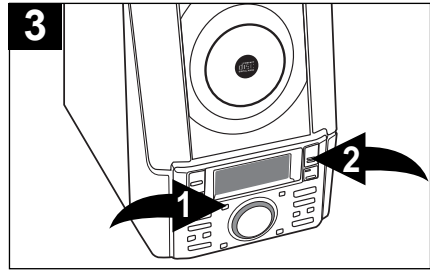

To cancel Repeat Playback, press the REPEAT/PRESET UP button ❶ until "REPEAT" disappears from the display. You can also cancel Repeat Playback by pressing the CD OPEN/CLOSE button ❷.

PROGRAMMED PLAYBACK

The CD player in this unit has a 20 track programmable memory that allows you to program up to 20 tracks on any disc for playback in any desired order. You may program 20 different tracks or you may also program certain tracks to play more than once.

To perform programmed playback, proceed as follows:

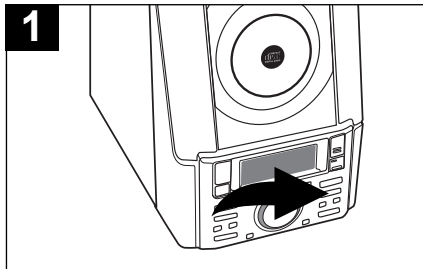

Press the BAND/STOP (■) button to select CD.

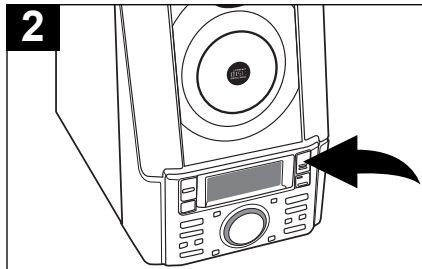

Press the CD OPEN/CLOSE button to open the CD compartment door. Gently press a CD onto the center spindle, with the printed label side facing out. Close the CD compartment door.

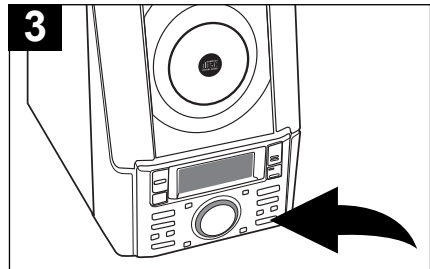

Press the MEMORY/PROGRAM/CLOCK SET button; "P-01" (program number), "00" (track number) will appear and "MEMORY" will blink in the display.

PROGRAMMED PLAYBACK SECTION CONTINUED ON NEXT PAGE.

OPERATING INSTRUCTIONS (CONTINUED)

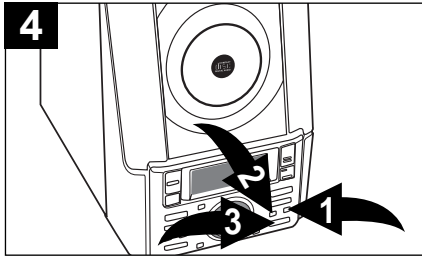

Press the Tuning/CD SKIP/Search (▶▶) ❶ or (◀◀) button ❷ to select the first track that you wish to program. When the desired track number appears in the display, press the MEMORY/PROGRAM/CLOCK SET button ❸ again.

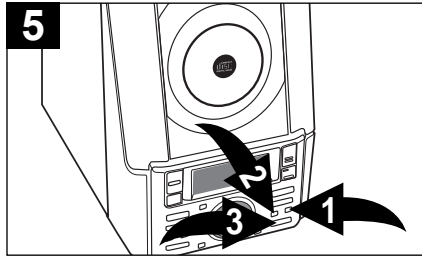

Press either the Tuning/CD SKIP/Search (▶▶) ❶ or (◀◀) button ❷ to select the next track you wish to program. When the desired track number appears in the display, press the MEMORY/PROGRAM/CLOCK SET button ❸ again.

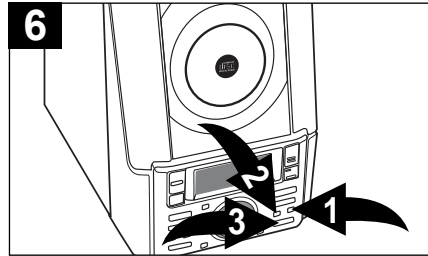

Repeat step 5 until you have programmed up to 20 track numbers into the CD Program Memory.

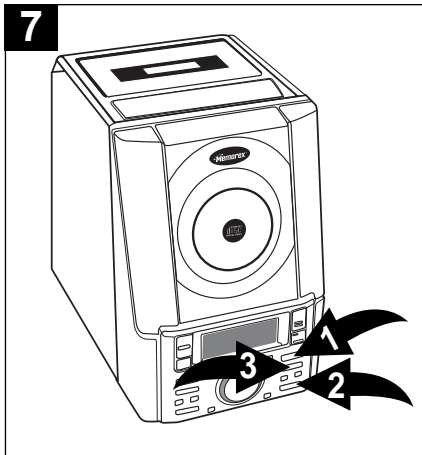

After programming up to 20 tracks in the CD Program Memory, press the PLAY/PAUSE (▶||) button ❶ to begin programmed playback. "MEMORY" will appear in the display and playback will begin on the first track that you programmed. The player will continue to play all of the tracks that you programmed in the order in which you programmed them. When the last programmed track has been played, the player will stop and the display will again show the total number of tracks on the disc. To cancel the Programmed Playback mode, press the MEMORY/PROGRAM/CLOCK SET button ❷ to enter the program mode, and then press the BAND/STOP (■) button ❸.

PROGRAMMED REPEAT

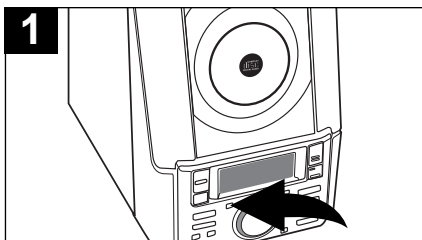

It is also possible to use the Program and Repeat functions together to repeat a specific program indefinitely. First, program the tracks you wish to hear in the order you wish to hear them, as described above. Then, press the REPEAT/PRESET UP button twice. Both the MEMORY and REPEAT indicators will appear in the display.

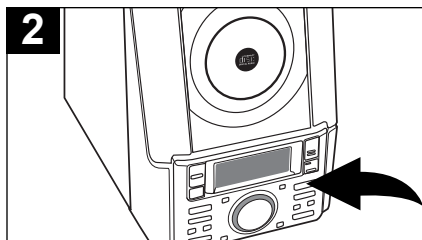

Press the PLAY/PAUSE (▶||) button to begin programmed repeat playback. The player will play the tracks you selected in the order in which you programmed them. When the last track in the program has been played, the entire program will begin again.

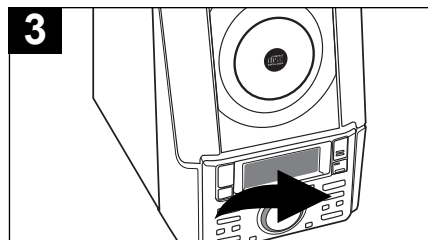

Program Repeat operation will continue indefinitely until you press the BAND/STOP (■) button.

OPERATING INSTRUCTIONS (CONTINUED)

PLAYING CASSETTE TAPES

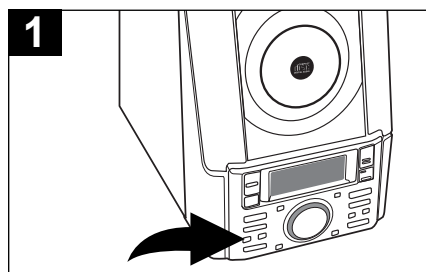

Press the TAPE Function button.

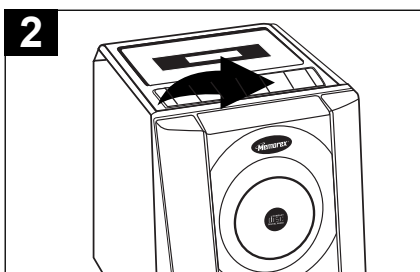

Open the Cassette Button compartment and press the STOP/EJECT button to open the cassette compartment.

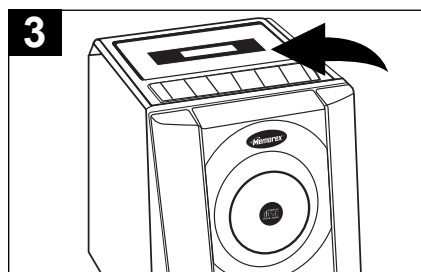

Insert a pre-recorded cassette into the slots in the Cassette Door with the open end facing up. Close the cassette door.

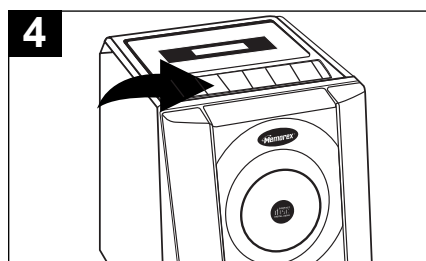

Press the PLAY (▶) button to begin playback.

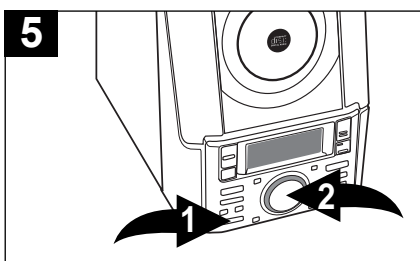

Adjust the PRESET EQ ❶ and VOLUME ❷ buttons as desired.

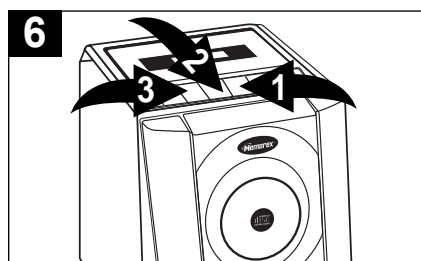

To advance or rewind the tape rapidly, press either the F.FWD (▶▶) ❶ or REWIND (◀◀) ❷ button. When you reach the desired point, press the PLAY (▶) button ❸ to resume normal playback.

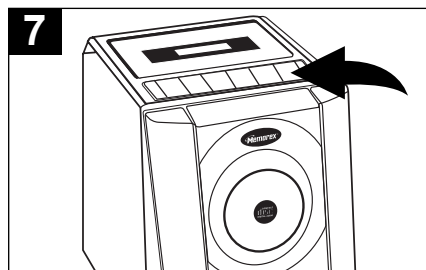

To pause playback momentarily, press the PAUSE (||) button. The tape movement stops but the tape motor is still running. Press the PAUSE (||) button again to release pause and resume normal playback.

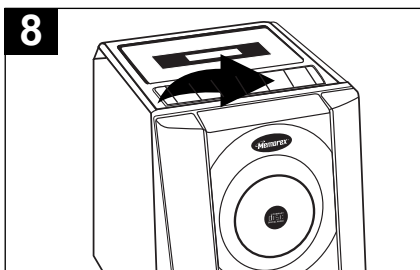

To stop playback before the tape ends, press the STOP/EJECT button. The PLAY (▶) button is released and the tape motor shuts off. When the tape reaches the end, the auto-stop mechanism activates, the PLAY (▶) button is released and the tape motor shuts off.

OPERATING INSTRUCTIONS (CONTINUED)

MAKING A TAPE RECORDING

The tape recorder in this system allows you to make direct recordings from the radio or CD player to a blank cassette in the tape compartment. An automatic recording volume level control (ALC) circuit will automatically control the volume level of your recordings to prevent distortion. You may change the settings of the volume or the Stereo-Wide controls during a tape recording, as these controls have no effect on the material being recorded onto the tape.

To make a tape recording, proceed as follows:

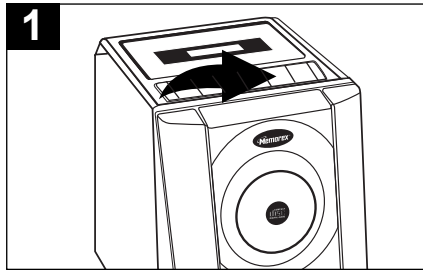

1 Open the Cassette Button compartment and press the STOP/EJECT button to open the cassette compartment. Insert a good quality blank cassette tape and close the Cassette Door.

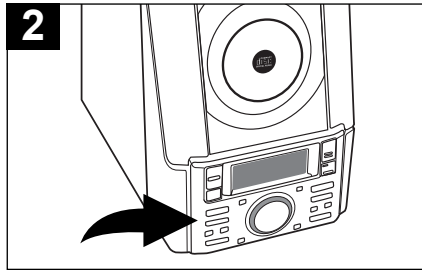

2 Press one of the Function buttons (CD, TUNER or AUX), and operate that function according to its own instructions.

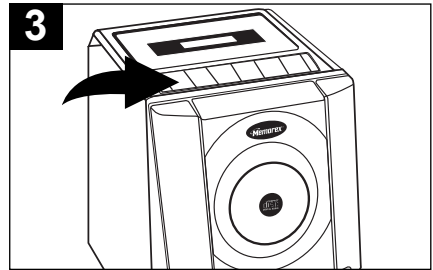

3 When you are ready to begin recording, press the RECORD (●) button. The PLAY (▶) button will also engage. The tape will begin moving and all of the material from your selected source will be recorded on the tape.

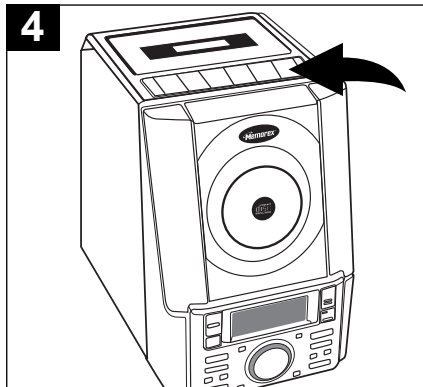

4 To avoid recording unwanted material, such as radio commercials, use the PAUSE (||) button to stop the recording temporarily. Release the PAUSE (||) button to begin recording again.

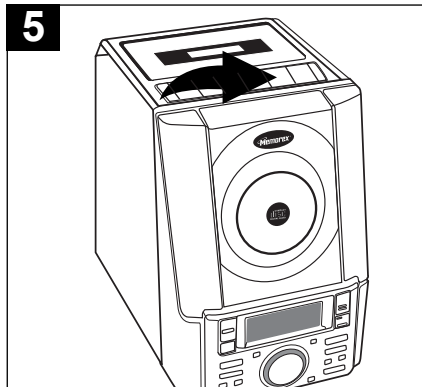

5 When you are finished recording, press the STOP/EJECT (■) button to stop the tape.

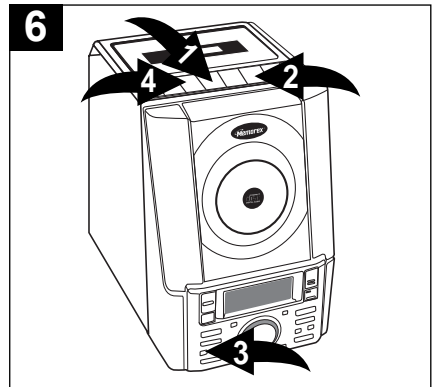

6 If you wish to listen to your recording immediately, press the cassette REWIND (◀◀) button ❶ until the tape rewinds to the beginning, then press the STOP (■) button ❷. Press the TAPE Function button ❸ and press the PLAY (▶) button ❹ to begin playback.

OPERATING INSTRUCTIONS (CONTINUED)

SETTING THE TIMER

Set the timer to turn the unit on to the Tuner or CD mode at a preset time as follows :

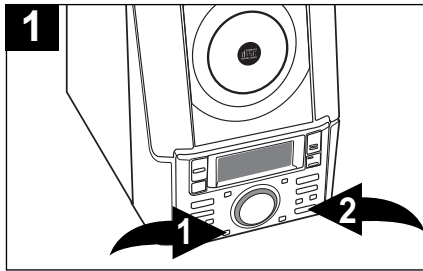

With the power off, press the SLEEP/TIMER button ❶ until "TIMER" blinks in the display. Press and hold the MEMORY/PROGRAM/ CLOCK SET button ❷ until timer hour digits blink in the display.

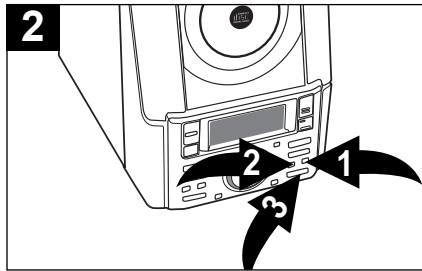

Press the Tuning/CD SKIP/Search (▶▶) ❶ or (◀◀) ❷ button to set the hour, then press the MEMORY/PROGRAM/ CLOCK SET button ❸ again; the minute digits will blink. Press the Tuning/CD SKIP/Search (▶▶) ❶ or (◀◀) ❷ button to set the minutes, then press the MEMORY/PROGRAM/ CLOCK SET button ❸ again.

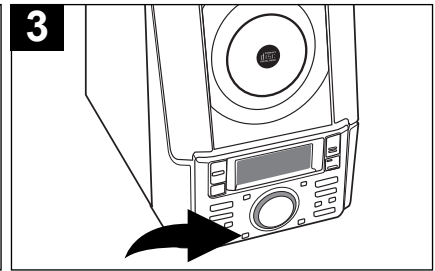

Within a couple seconds, "TIMER" will light in the display to indicate that the timer is set. When the actual time matches the time set for the Timer, the unit will turn on to the last function (CD or tuner) used. **TO TURN THE TIMER OFF SO IT IS NOT SET FOR THE NEXT DAY**, press the TIMER/SLEEP button again until "TIMER" disappears from the display.

The unit will revert back to standby mode one hour after the timer has been activated.

ACTIVATING THE SLEEP FUNCTION

Set the sleep timer as follows:

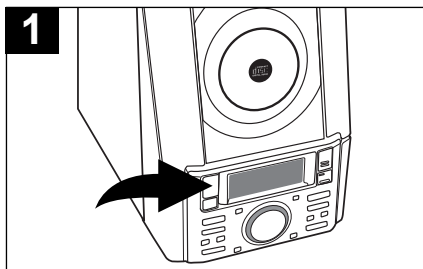

Press the POWER button to turn the unit on and tune the desired radio station or insert a CD as previously instructed.

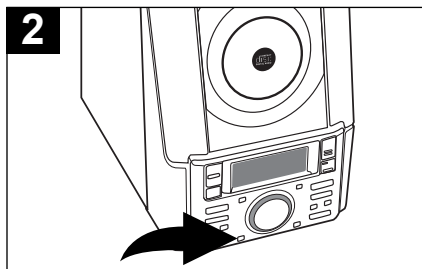

Press the TIMER/SLEEP button and "90" will appear and "SLEEP" will blink in the display.

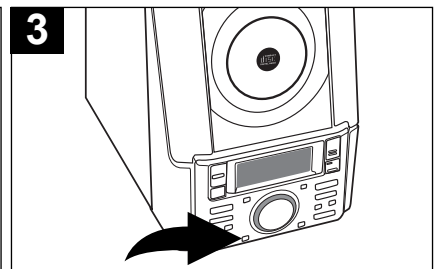

Press the TIMER/SLEEP button a second time to set the unit to turn off after 80 minutes. Each additional press will decrease the sleep time by 10 minutes. After the sleep time is set, you can press the TIMER/SLEEP button at any time to stop the Sleep function; "SLEEP" will disappear from the display.

CARE AND MAINTENANCE

SAFEGUARD AGAINST ACCIDENTAL ERASURE

When a new recording is made, any program material previously recorded is automatically erased and only the new recording remains. To safeguard valuable recordings from being erased accidentally, the cassette and the deck are equipped with a special device.

On the back of the cassette there is an erase prevention tab on each side. To prevent accidental erasing, break out these tabs with a screwdriver. If only one side of the tape is to be protected, break out the tab on the left side with the side desired facing you.

To record on a tape in which the tab has been broken, place a piece of adhesive tape over that area.

NOTE: When a tab is broken out, the record button cannot be depressed.

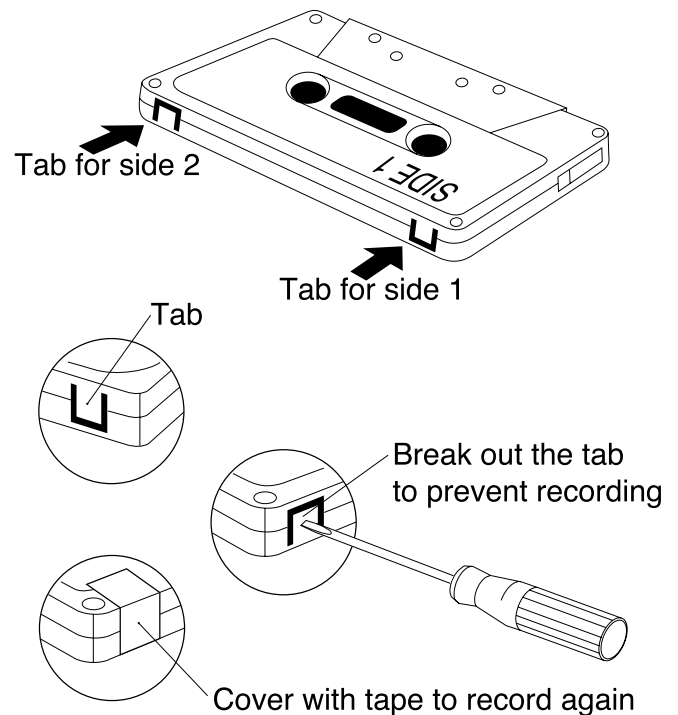

CASSETTE TAPE RECOMMENDATIONS

Standard tape lengths have 15 (C-30), 30 (C-60) and 45 (C-90) minutes of recording time on each side. Longer length tapes of 60 (C-120) minutes of recording time on each side are not recommended. Use only high quality tapes. If a problem develops, check the unit first with another cassette to determine if the problem is with the cassette, and not with the unit.

If there is any slack in the cassette, it should be removed before inserting the cassette. Place a pencil in one of the hubs and rotate it clockwise until all slack is taken up.

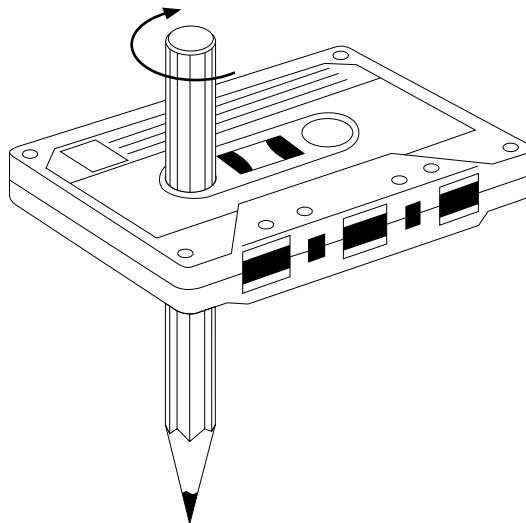

CARE AND MAINTENANCE (CONTINUED)

Caring for Compact Discs

- Treat the compact disc carefully. Handle the compact disc only by its edges. Never allow your fingers to come in contact with the shiny, unprinted side of the compact disc.
- Do not attach adhesive tape, stickers, etc. to the compact disc label.
- Clean the compact disc periodically with a soft, lint-free, dry cloth. Never use detergents or abrasive cleaners to clean the compact disc. If necessary, use a CD cleaning kit.
- If a compact disc skips or gets stuck on a section of the compact disc, it is probably dirty or damaged (scratched).
- When cleaning the compact disc, wipe in straight lines from the center of the compact disc to the outer edge of the compact disc. Never wipe in circular motions.

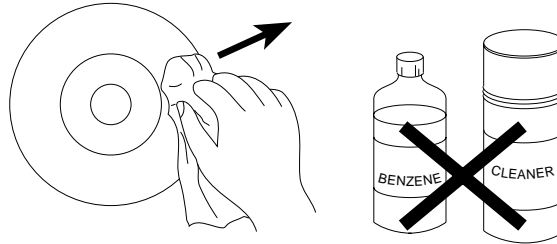
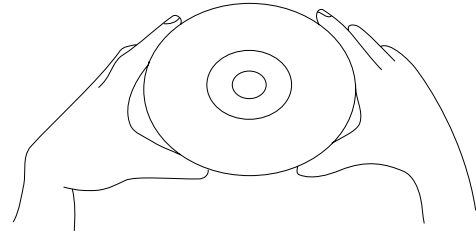

- This unit is designed to play only compact discs bearing the identification logo as shown here. Other compact discs may not conform to the CD standard and may not play properly.
- Compact discs should be stored in their cases after each use to avoid damage.
- Do not expose compact discs to direct sunlight, high humidity, high temperatures, or dust, etc. Prolonged exposure or extreme temperatures can warp the compact disc.
- Do not stick or write anything on either side of the compact disc. Sharp writing instruments, or the ink may damage the surface.



Cleaning the unit

- To prevent fire or shock hazard, disconnect your unit from the AC power source when cleaning.
- The finish on your unit may be cleaned with a dust cloth and cared for as other furniture. Use caution when cleaning and wiping the plastic parts.
- Mild soap and a damp cloth may be used on the front panel.
- Periodic cleaning of the tape heads, capstan and pinch roller is necessary to maintain good sound reproduction. Clean them after every 100 hours of use or less if playback has deteriorated. Use a cotton swab moistened with head cleaning solution or isopropyl alcohol, then wipe dry with another swab.

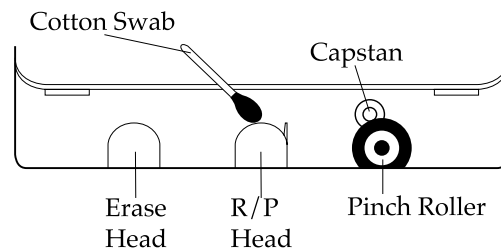

NOTE: Never use metal objects on or near the tape heads. Do not allow any cleaning material to fall into the tape assembly.

TROUBLESHOOTING GUIDE

Should this unit exhibit a problem, check the following before seeking service:

Symptom	Possible Cause	Solution
Radio		
Noise or sound distorted on radio broadcasts.	Station not tuned properly for AM or FM.	Retune the AM or FM broadcast station.
	FM: Wire Antenna is not extended.	Extend Wire Antenna.
	AM: Unit is not positioned correctly.	Rotate unit until best reception is obtained.
FM STEREO does not light in the display.	Poor FM signal being received.	Retune station or try another station that broadcasts in stereo.
	Station is not broadcasting in stereo.	Change stations.
AM or FM, no sound.	TUNER Function button is not set to Tuner.	Press the TUNER Function button to select Tuner.
	Volume at minimum.	Increase volume.
Compact Disc Player		
CD Player will not play.	CD Function button is not selected.	Press the CD Function button to select CD.
	CD is not installed or installed incorrectly.	Insert CD with label facing the out.
CD skips while playing.	Disc is dirty or scratched.	Wipe disc with cloth or use another disc.
Cassette Player		
No sound.	TAPE Function button is not selected.	Press the TAPE Function button.
	Volume at minimum.	Increase volume.
Sound distorted.	Dirty head.	Clean the head.
Speed varies.	Tape old or worn.	Replace the tape.
	Batteries are low.	Replace the batteries.
Cassette Recorder		
Will not record.	Erase prevention tab removed.	Cover hole with adhesive tape.
Distorted sound on playback.	Defective tape or dirty tape head.	Replace tape or clean tape head.
General		
No power.	AC power cord is not connected.	Connect AC power cord.
Remote not working.	Batteries not inserted, or inserted correctly.	Insert batteries correctly.

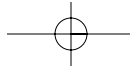

**FOR ADDITIONAL SET-UP OR OPERATING ASSISTANCE, PLEASE VISIT OUR WEBSITE AT
WWW.MEMCORPINC.COM
OR CONTACT CUSTOMER SERVICE AT 1-800-919-3647.**

**PLEASE KEEP ALL PACKAGING MATERIAL FOR AT LEAST 90 DAYS IN CASE YOU NEED
TO RETURN THIS PRODUCT TO YOUR PLACE OF PURCHASE OR MEMOREX.**

FOR PARTS AND ACCESSORIES, CONTACT FOX INT'L AT 1-800-321-6993.

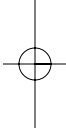
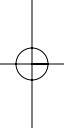
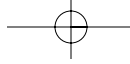

Memcorp, Inc.
Weston, FL
Printed in Hong Kong

Visit our website at www.memcorpinc.com



Free Manuals Download Website

<http://myh66.com>

<http://usermanuals.us>

<http://www.somanuals.com>

<http://www.4manuals.cc>

<http://www.manual-lib.com>

<http://www.404manual.com>

<http://www.luxmanual.com>

<http://aubethermostatmanual.com>

Golf course search by state

<http://golfingnear.com>

Email search by domain

<http://emailbydomain.com>

Auto manuals search

<http://auto.somanuals.com>

TV manuals search

<http://tv.somanuals.com>