

# **Memorex<sup>®</sup>**

## ***HOME AUDIO SYSTEM WITH CD PLAYER AND AM/FM STEREO RADIO***

***MODEL: MX3900***

**BEFORE OPERATING THIS PRODUCT, PLEASE READ THESE  
INSTRUCTIONS COMPLETELY.**

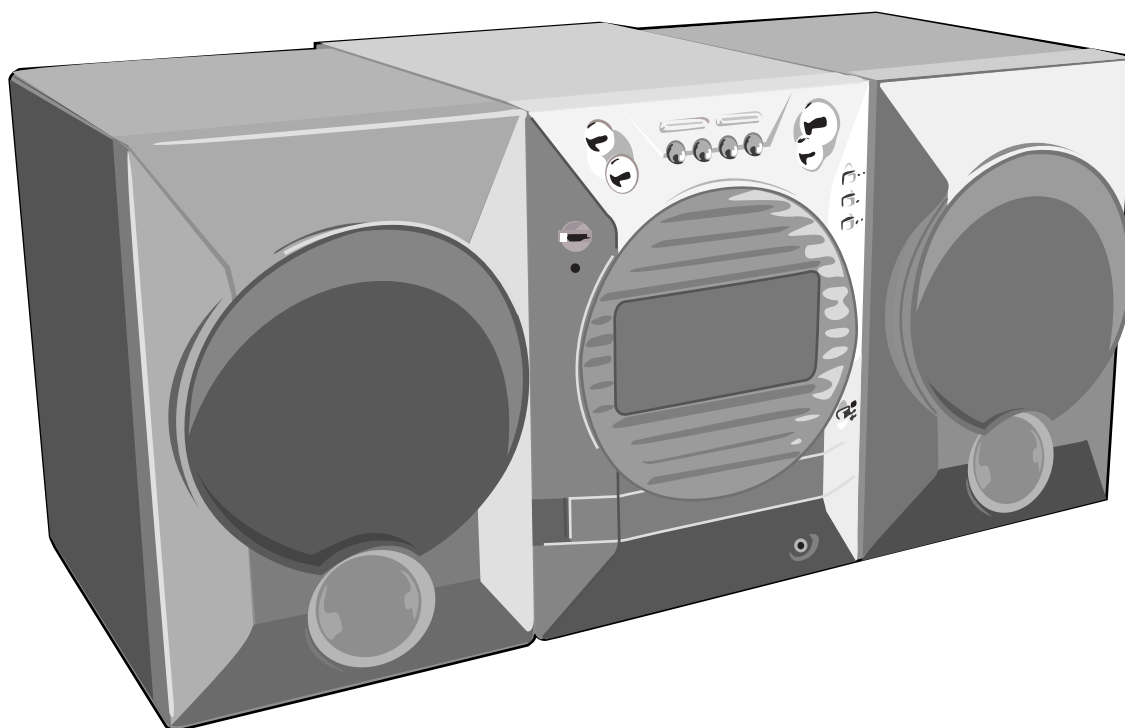

## **OPERATING INSTRUCTIONS**

## WARNING

**TO PREVENT FIRE OR SHOCK HAZARD, DO NOT USE THIS PLUG WITH AN EXTENSION CORD, RECEPTACLE OR OTHER OUTLET UNLESS THE BLADES CAN BE FULLY INSERTED TO PREVENT BLADE EXPOSURE. TO PREVENT FIRE OR SHOCK HAZARD, DO NOT EXPOSE THIS APPLIANCE TO RAIN OR MOISTURE.**



The lightning flash with arrowhead symbol, within an equilateral triangle is intended to alert the user to the presence of uninsulated 'dangerous voltage' within the product's enclosure that may be of sufficient magnitude to constitute a risk of electric shock to persons.

### CAUTION

**RISK OF ELECTRIC SHOCK  
DO NOT OPEN**

**CAUTION: TO REDUCE THE RISK OF ELECTRIC SHOCK DO NOT REMOVE COVER (OR BACK), NO USER SERVICEABLE PARTS INSIDE REFER SERVICING TO QUALIFIED SERVICE PERSONNEL.**



The exclamation point within an equilateral triangle is intended to alert the user to the presence of important operating and maintenance (servicing) instructions in the literature accompanying the appliance.

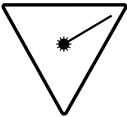

### **DANGER:**

Invisible and hazardous laser radiation when open and interlock failed or defeated. Avoid direct exposure to beam.

1. Read these instructions.
2. Keep these instructions.
3. Heed all warnings.
4. Follow all instructions.
5. Do not use this apparatus near water.
6. Clean only with dry cloth.
7. Do not block any ventilation openings. Install in accordance with the manufacturer's instructions.
8. Do not install near any heat sources such as radiators, heat registers, stoves, or other apparatus (including amplifiers) that produce heat.
9. Do not defeat the safety purpose of the polarized or grounding-type plug. A polarized plug has two blades with one wider than the other. A grounding type plug has two blades and a third grounding prong. The wide blade or the third prong are provided for your safety. If the provided plug does not fit into your outlet, consult an electrician for replacement of the obsolete outlet.
10. Protect the power cord from being walked on or pinched particularly at plugs, convenience receptacles, and the point where they exit from the apparatus.
11. Only use attachments / accessories specified by the manufacturer.
12. Unplug this apparatus during lightning storms or when unused for long periods of time.
13. Refer all servicing to qualified service personnel. Servicing is required when the apparatus has been damaged in any way, such as power-supply cord or plug is damaged, liquid has been spilled or objects have fallen into the apparatus, the apparatus has been exposed to rain or moisture, does not operate normally, has changed its performance, or has been dropped.
14. This appliance shall not be exposed to dripping or splashing water and that no object filled with liquids such as vases shall be placed on the apparatus.
15. Do not overload wall outlet. Use only power source as indicated.
16. Use replacement parts as specified by the manufacturer.
17. The product may be mounted to a wall only if recommended by the manufacturer.
18. Upon completion of any service or repairs to this product, ask the service technician to perform safety checks.

## SAFETY INSTRUCTIONS

### INFORMATION:

This equipment has been tested and found to comply with the limits for a Class B digital device, pursuant to Part 15 of the FCC Rules. These limits are designed to provide reasonable protection against harmful interference in a residential installation. This equipment generates, uses, and can radiate radio frequency energy and, if not installed and used in accordance with the instructions, may cause harmful interference to radio communications. However, there is no guarantee that interference will not occur in a particular installation. If this equipment does cause harmful interference to radio or television reception, which can be determined by turning the equipment off and on, the user is encouraged to try to correct the interference by one or more of the following measures:

- Reorient or relocate the receiving antenna.
- Increase the separation between the equipment and receiver.
- Connect the equipment into an outlet on a circuit different from that to which the receiver is connected.
- Consult the dealer or an experienced radio/TV technician for help.

**LASER SAFETY:** This unit employs a laser. Only qualified service personnel should attempt to service this device due to possible eye injury.

**CAUTION:** USE OF CONTROLS, ADJUSTMENTS OR PERFORMANCE PROCEDURE HEREIN MAY RESULT IN HAZARDOUS RADIATION EXPOSURE.

**WARNING:** DO NOT EXPOSE THIS APPLIANCE TO RAIN OR MOISTURE.

### FCC WARNING:

This equipment may generate or use radio frequency energy. Changes or modifications to this equipment may cause harmful interference unless the modifications are expressly approved in the instruction manual. The user could lose the authority to operate this equipment if an unauthorized change or modification is made.

## PREPARATION FOR USE

### AC Operation

Unwind the AC power cord and extend it to its full length. Insert the small end of the AC power cord into the AC socket on the back cabinet of the unit. Insert the other end of the AC power cord into any convenient 120V 60Hz household outlet.

Please note that this unit is equipped with a polarized AC plug which has one blade wider than the other. This is a safety feature to reduce the likelihood of electric shock. This polarized AC plug will only fit in a polarized AC outlet. If you find that you cannot insert this plug into your outlet, you may have an obsolete non-polarized outlet. Please do not try to defeat this safety feature by using a non-polarized adapter or by filing the wider blade to make it fit into your outlet. If this plug does not fit into your outlet, you should contact a qualified licensed electrician to replace your obsolete outlet.

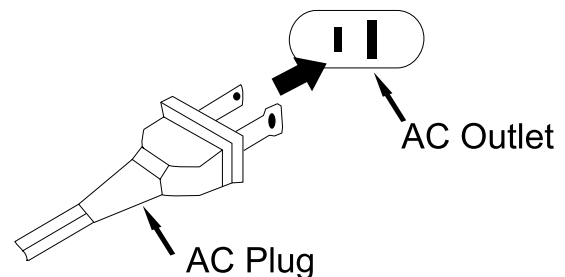

## PREPARATION FOR USE (CONTINUED)

### SPEAKER CONNECTION

1. Place the speakers in convenient locations on either side of the unit. Usually a distance of five to eight feet between speakers provides the best stereo effect, but this may vary depending on the size and acoustics of the room.
2. Locate the Speaker Terminals on the rear of the unit and connect the solid black wires to the red (+) terminals and connect the striped wires to the black (-) terminals.
3. To connect the speakers, press the terminal down, insert the speaker wire and press the terminal back to the lock position.
4. Pull lightly on the connection to make sure it is secure.
5. Connect the Speaker Light cable to the Speaker Light jacks. **These will light up the logo on the speakers.**

**CAUTION:** Only connect the speakers which are supplied with the unit. The use of any other or additional speakers may cause damage to the unit. Never operate the unit without the speakers connected.

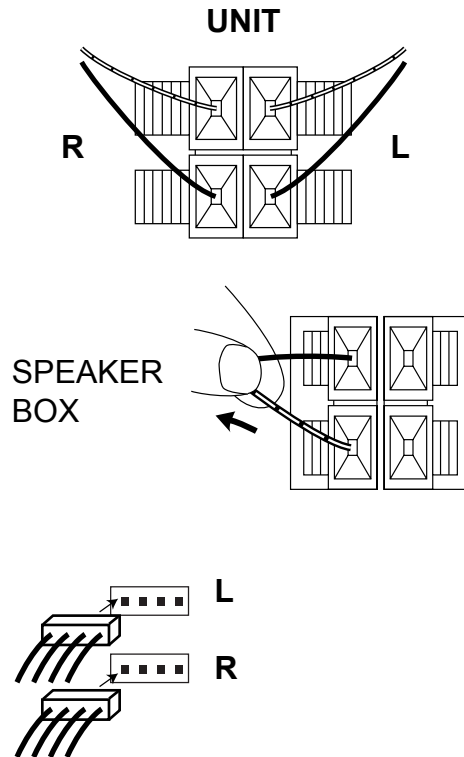

### BATTERY OPERATION

The battery compartment is located on the rear of the remote control.

- Remove the battery compartment door by pressing down and sliding the door in the direction of the arrow.
- Insert two (2) AA size batteries into the battery compartment as shown to the right. Be sure to observe the polarity markings which are engraved inside the battery compartment. If the batteries are inserted incorrectly, the remote control will not operate.
- Replace the battery compartment door.

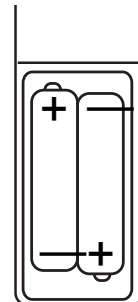

### BATTERY PRECAUTIONS

Follow these precautions when using batteries in this device:

1. Use only the size and type of batteries specified.
2. Be sure to follow the correct polarity when installing the batteries as indicated in the battery compartment. Reversed batteries may cause damage to the device.
3. Do not mix different types of batteries together (e.g. Alkaline and Carbon-zinc) or old batteries with fresh ones.
4. If the device is not to be used for a long period of time, remove the batteries to prevent damage or injury from possible battery leakage.
5. Do not try to recharge batteries not intended to be recharged; they can overheat and rupture.  
(Follow battery manufacturer's directions.)

### REMOTE SENSOR:

To operate the unit with the remote control, point the remote at the remote sensor on the front of the main unit and press the appropriate button. The remote control has an effective operating range of approximately 15 feet and an angle of no more than 30°.

**NOTE:** Bright sunlight may interfere with the operation of the remote control.

## LOCATION OF CONTROLS AND INDICATORS

### MAIN UNIT

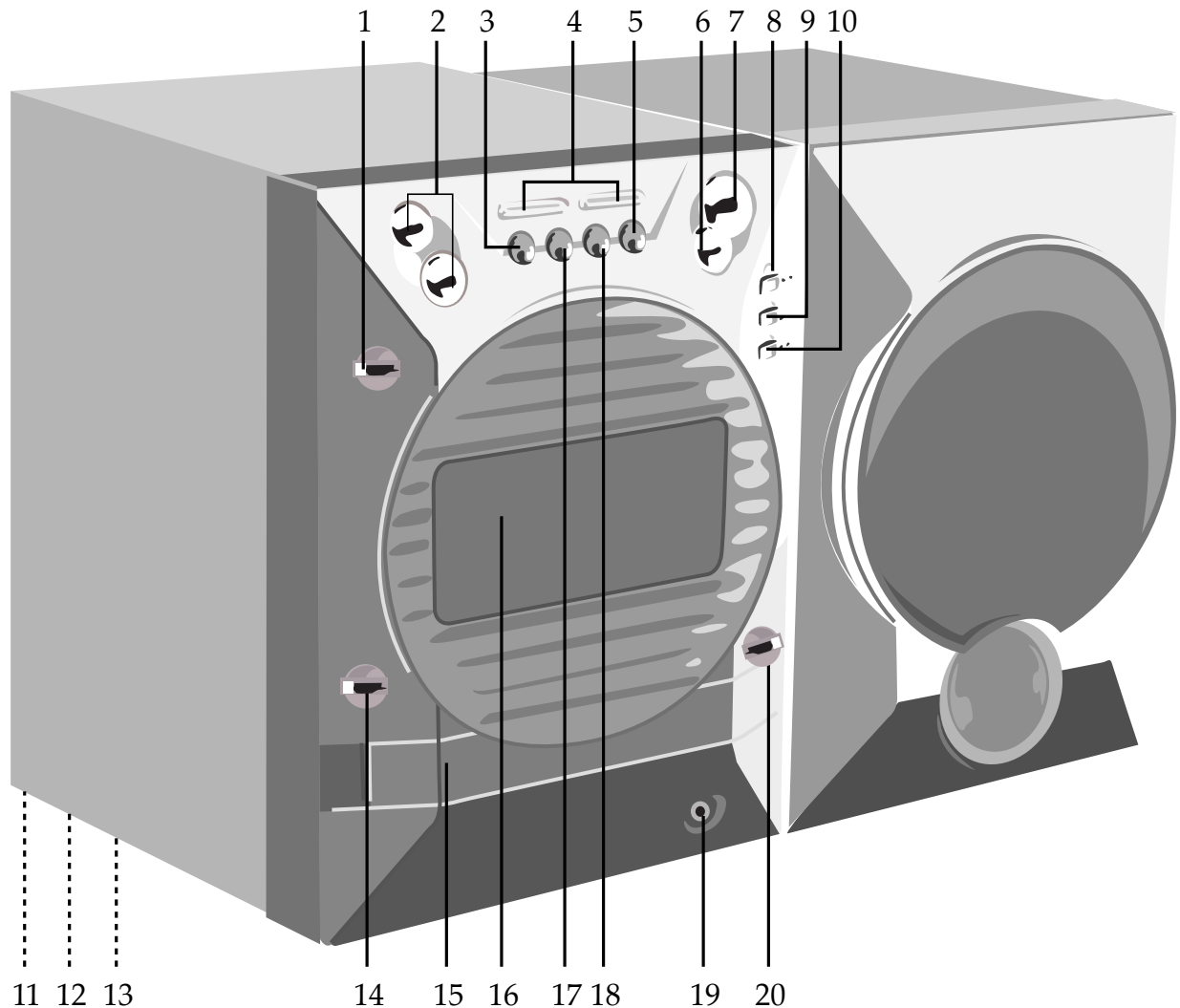

- |                                       |  |
|---------------------------------------|--|
| 1. COLOR MODE Button                  | 11. Speaker/Speaker Light Jacks (Rear of Unit) |
| 2. VOLUME +/- Buttons                 | 12. AC Cord (Rear of Unit)                     |
| 3. DISPLAY Button                     | 13. FM Antenna (Rear of Unit)                  |
| 4. TUNER/CD Skip/Search ►►/◄◄ Buttons | 14. POWER Button                               |
| 5. MEMORY/CLOCK SET Button            | 15. CD Compartment                             |
| 6. STOP(■) Button                     | 16. Display                                    |
| 7. PLAY/PAUSE Button                  | 17. RANDOM/MEMORY DOWN Button                  |
| 8. CD Function Button                 | 18. REPEAT/MEMORY UP Button                    |
| 9. TUNER/Band Button                  | 19. Headphones Jack                            |
| 10. EQUALIZER Button                  | 20. CD OPEN/CLOSE Button                       |

## LOCATION OF CONTROLS AND INDICATORS

### REMOTE

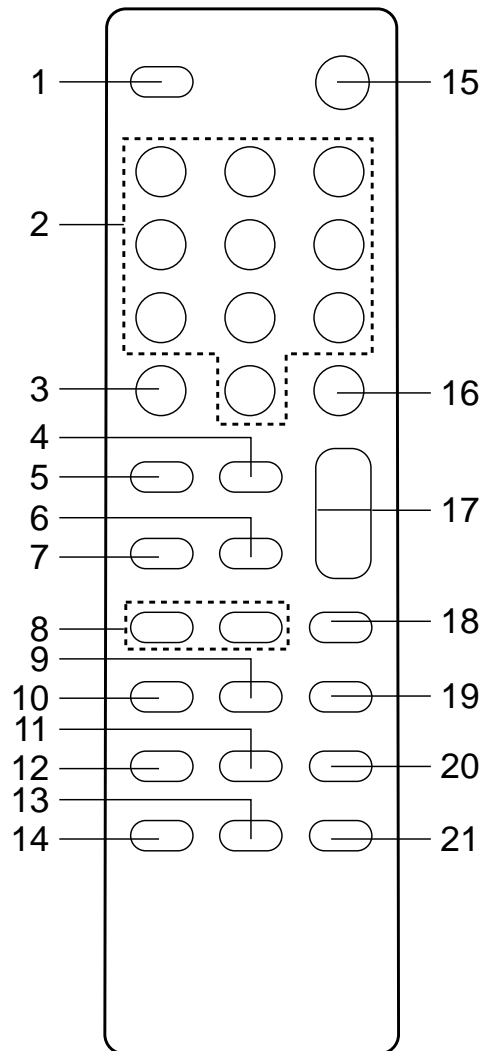

- |                                   |                             |
|-----------------------------------|-----------------------------|
| 1. CD EJECT Button                | 14. COLOR MODE Button       |
| 2. Direct Track Selection Buttons | 15. POWER Button            |
| 3. OVER Button                    | 16. MUTE Button             |
| 4. EQ Button                      | 17. VOLUME UP/DOWN Buttons  |
| 5. EX-BASS Button                 | 18. CD Mode Button          |
| 6. PLAY/PAUSE (▶  ) Button        | 19. TUNER/BAND Button       |
| 7. CD STOP(■) Button              | 20. MEMORY/CLOCK SET Button |
| 8. TUNING DN/UP Buttons           | 21. RANDOM Button           |
| 9. MEMORY UP Button               |                             |
| 10. MEMORY DOWN Button            |                             |
| 11. REPEAT Button                 |                             |
| 12. DISPLAY Button                |                             |
| 13. INTRO Button                  |                             |

## OPERATING INSTRUCTIONS

### SETTING THE CLOCK

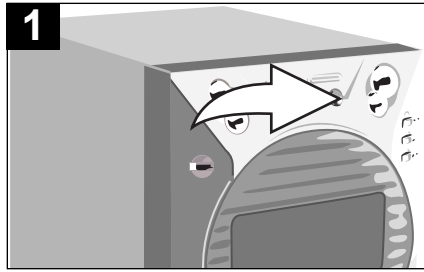

With the power off, press the MEMORY/CLOCK SET button; the hours will blink.

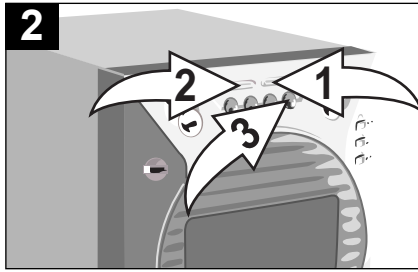

Press the TUNING/CD Skip/Search (▶▶) ① or (◀◀) ② button to set the current hour, then press the MEMORY/CLOCK SET button ③ again; the minute digits will blink.

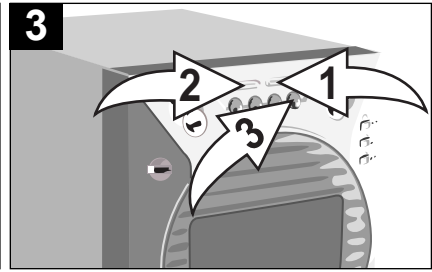

Press the TUNING/CD Skip/Search (▶▶) ① or (◀◀) ② button to set the current minute. Press the MEMORY/CLOCK SET button ③ and the time will be set.

### CHANGING THE LIGHTING IN THE DISPLAY

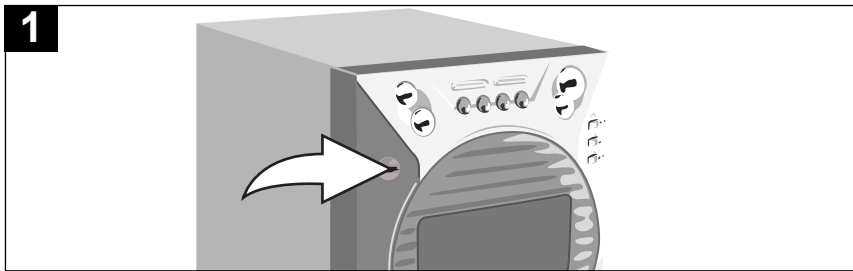

When the unit is first turned on, the display is will cycle through all the colors. Press the COLOR MODE button when the desired color appears and that color will remain. To begin the cycling of the colors, press the COLOR MODE button again.

### X BASS

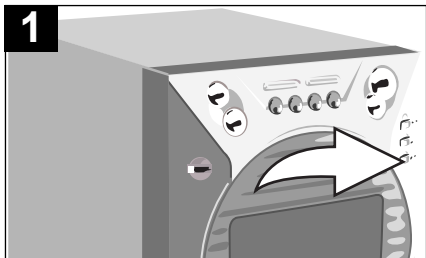

To enhance the overall bass sound, simply press the X BASS button on the remote or press and hold the EQ button on the main unit until the BASS indicator lights.

### DISPLAY BUTTON

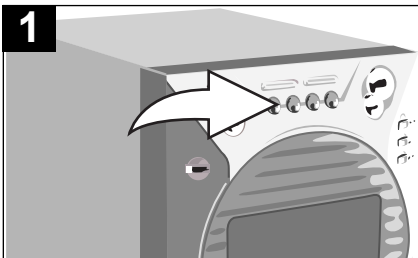

Press to show the clock on the display.

### HEADPHONE JACK

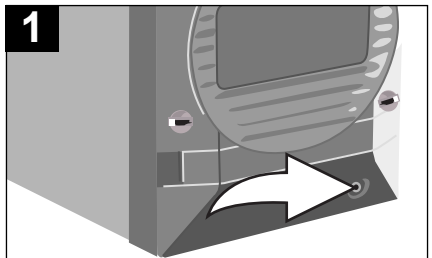

To listen to the unit through headphones, simply insert the headphones (not included) into the Headphones jack. The speakers will be disconnected when the Headphones are plugged in.

## OPERATING INSTRUCTIONS (CONTINUED)

### LISTENING TO THE RADIO

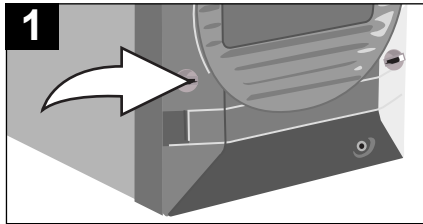

1 Press the POWER button to turn the unit on.

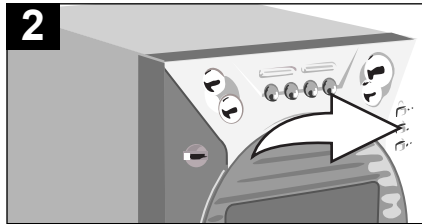

2 Press the TUNER/Band button; "TUNER" will appear in the display.

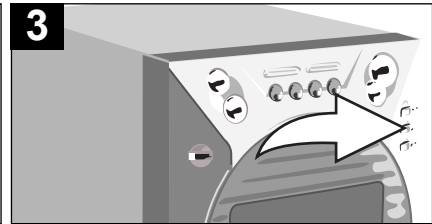

3 Press the TUNER/Band button to select AM or FM.  
**NOTE:** If you select the FM band, be sure to extend the FM Wire Antenna.

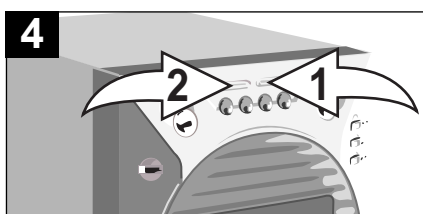

4 Press the TUNING/CD Skip/Search **▶▶ 1** or **◀◀ 2** button to select a station (see Tuning note below).

**NOTE:** If the FM band is selected and you have tuned to an FM Stereo station, the FM Stereo indicator will light in the display.

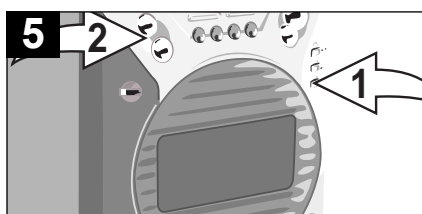

5 Adjust the X-BASS (on remote), EQ **1** and VOLUME **2** buttons as desired.

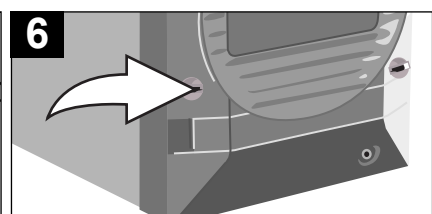

6 When you have finished listening, press the POWER button to turn the unit off.

### TUNING:

**MANUAL TUNING:** Repeatedly press the TUNING/CD Skip/Search **▶▶** or **◀◀** to manually advance the frequency in the display up or down until the desired frequency appears.

**AUTOMATIC TUNING:** Press and hold the TUNING/CD Skip/Search **▶▶** or **◀◀** until the frequency in the display starts to scan, and then release the button; the tuner will search and then stop on the next strong station it finds. Repeat this procedure until the desired frequency appears in the display.

### Hints for Better Reception

FM - Make sure that the FM Wire Antenna is extended to its full length. You may have to vary the direction of the antenna to find the strongest signal for each FM station.

AM - The AM ferrite bar antenna is located inside the unit. It may be necessary to turn the unit slightly so that the internal antenna is pointing in the direction of the AM transmitter. You may have to experiment to find the position that provides the strongest reception for each of your favorite AM stations.

### MUTE

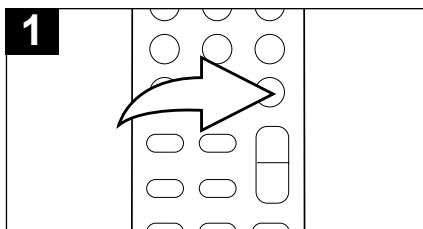

1 To temporarily mute the sound, press the MUTE button on the remote control; the Mute indicator will appear in the display and the sound will be muted. Press the MUTE button again to restore the sound and the Mute indicator will disappear from the display.



# OPERATING INSTRUCTIONS (CONTINUED)

## SETTING RADIO PRESETS

This unit can preset 20 AM and 20 FM radio stations for convenient recall.

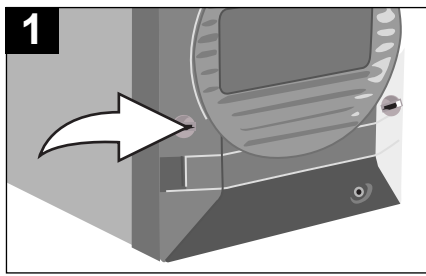
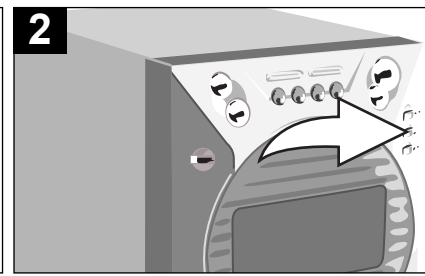
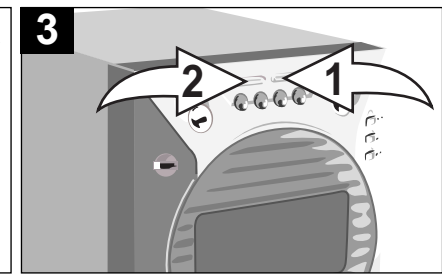
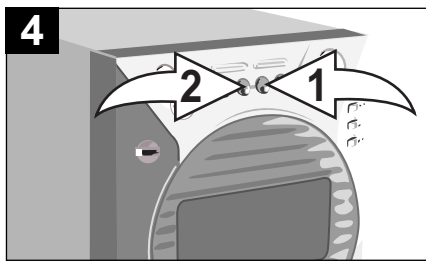
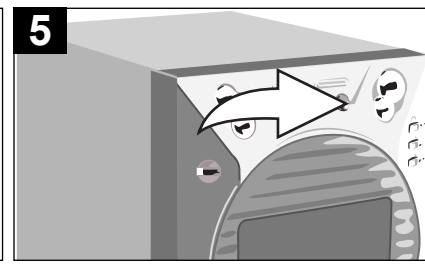
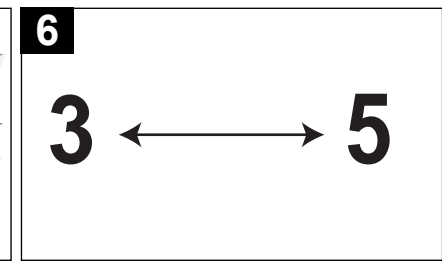
		
<p>Press the POWER button to turn the unit on.</p>	<p>Press the TUNER/Band button; "TUNER" will appear in the display. Press the TUNER/Band button again to select the desired band - FM or AM.</p>	<p>Use the TUNER/CD Skip/Search (▶▶) ① or (◀◀) ② button to select a station.</p>
		
<p>Press the MEMORY/CLOCK SET button ①. Within 4 seconds, press the REPEAT/MEMORY UP button ② until the desired memory number appears on the display.</p>	<p>Press the MEMORY/CLOCK SET button again to set the station in the selected memory.</p>	<p>Repeat steps 3 through 5 to program up to 20 stations in each band, if desired. <b>In case the main power supply is interrupted, the memory presets will be erased.</b></p>

## RECALLING RADIO PRESETS

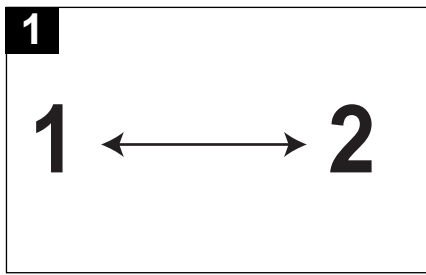
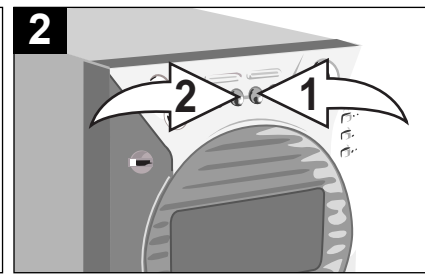
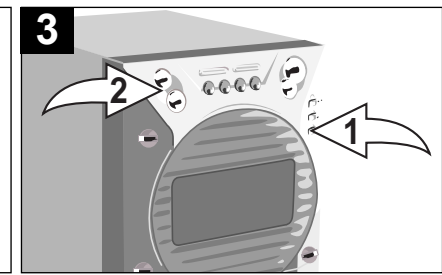
		
<p>Follow steps 1 and 2 above.</p>	<p>Press the REPEAT/MEMORY UP ① or RANDOM/MEMORY DOWN ② button to select a preset; the station will automatically be tuned in.</p>	<p>Adjust the X-BASS (on remote), EQ ① and VOLUME ② buttons as desired.</p>

## OPERATING INSTRUCTIONS (CONTINUED)

### PLAYING COMPACT DISCS NORMAL PLAYBACK

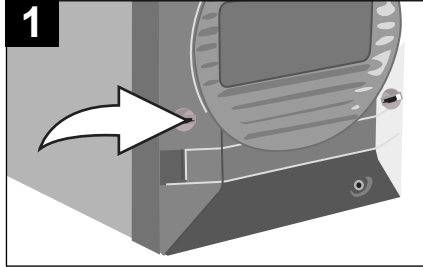

1 Press the POWER button to turn the unit on.

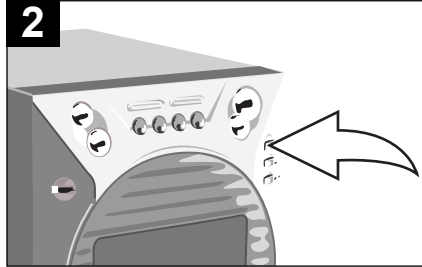

2 Press the CD Function button to select CD.

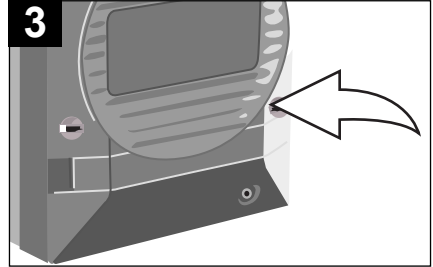

3 Press the OPEN/CLOSE button to open the CD Compartment and insert a CD with the label side facing up.

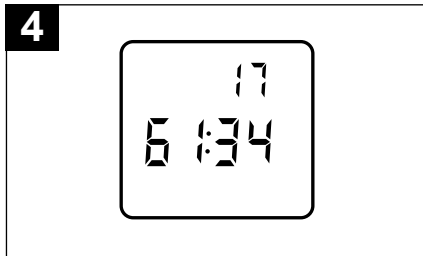

4 The CD player will read the table of contents on the disc and the total number of tracks and total playing time on the disc will appear in the display.

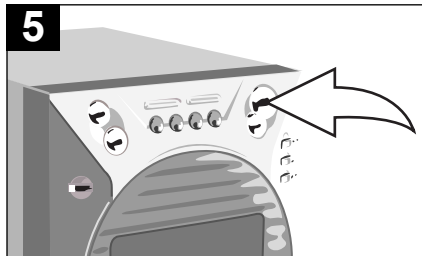

5 Press the PLAY/PAUSE (▶||) button to begin playback on Track 1.

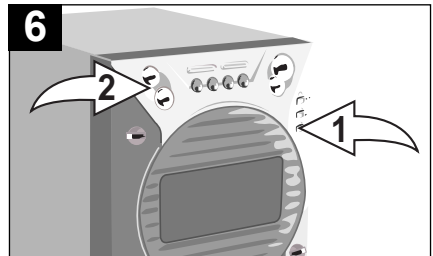

6 Adjust the X-BASS (on remote), EQ ① and VOLUME ② buttons as desired. Playback will continue until all the tracks on the disc have been played.

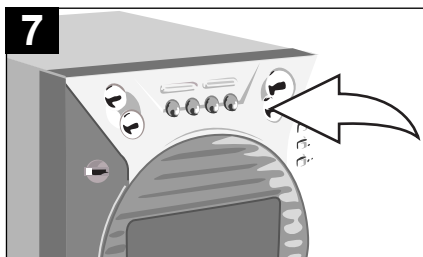

7 To stop playback before the disc ends, press the STOP (■) button. The disc will stop and the display will show the total number of tracks and playing time on the disc.

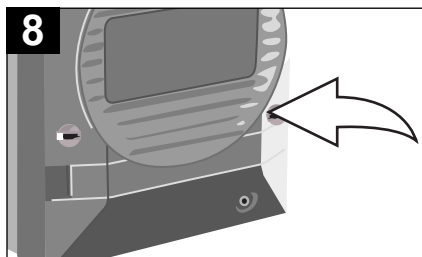

8 After the last track has been played, the disc stops automatically and the display shows the total number of tracks and playing time on the disc. If you are finished listening, press the OPEN/CLOSE button to eject the CD.

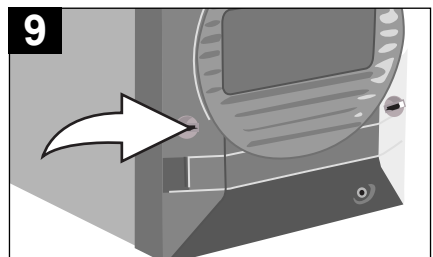

9 Remove your disc and press the POWER button to turn the unit off.

## OPERATING INSTRUCTIONS (CONTINUED)

### CD PAUSE CONTROL

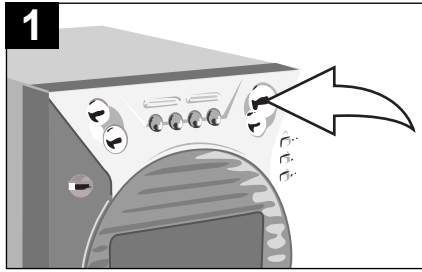

During CD playback, if you wish to pause the disc momentarily, press the PLAY/PAUSE (▶||) button again. Playback stops but the disc continues to spin and the time display will blink.

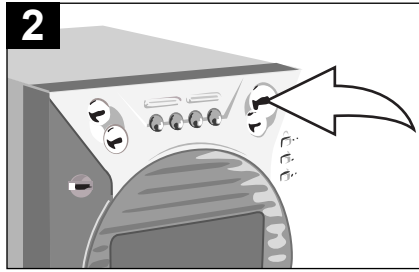

Press the PLAY/PAUSE (▶||) button again to release pause and resume normal CD playback.

### TO BEGIN PLAYBACK FROM A SPECIFIC TRACK

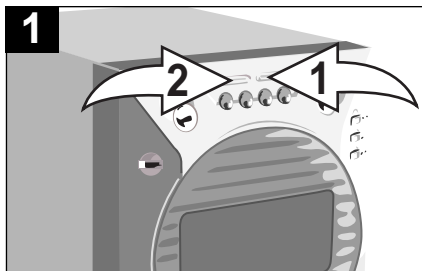

After you insert the disc into the CD player and the total number of tracks appear on the display, you may press either the CD Skip/Search (▶▶) ❶ or (◀◀) ❷ button to select a specific track for playback.

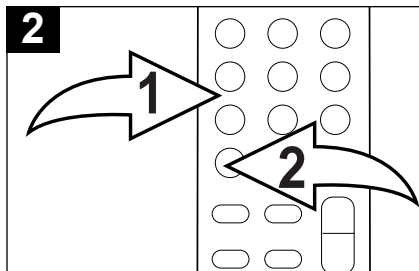

You can also use the Direct Track Selection buttons ❶ on the remote to directly select a track. If the track is over 9, press the OVER button ❷ first.

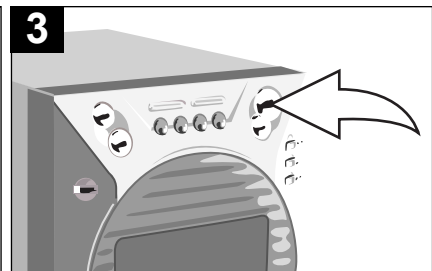

When the desired track number appears in the display, press the PLAY/PAUSE (▶||) button. Playback will begin on the track you selected.

### FORWARD/REVERSE SKIP TRACK AND HIGH-SPEED MUSIC SEARCH (▶▶/◀◀)

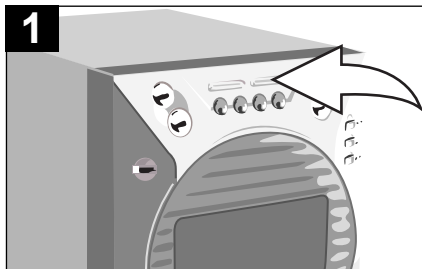

During playback, press the CD Skip/Search (▶▶) button once to advance the player to the beginning of the next track. Press the CD Skip/Search (▶▶) button repeatedly to advance the player to higher number tracks.

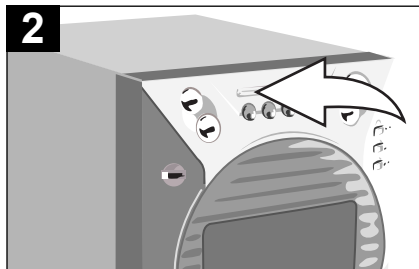

During playback, press the CD Skip/Search (◀◀) button once to move the player back to the beginning of the current track. Press the CD Skip/Search (◀◀) button repeatedly to move the player back to lower numbered tracks.

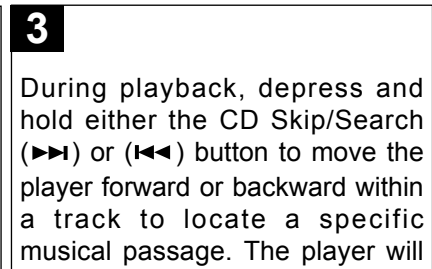

During playback, depress and hold either the CD Skip/Search (▶▶) or (◀◀) button to move the player forward or backward within a track to locate a specific musical passage. The player will move forward or backward at high speed as long as the button is depressed. When you release the CD Skip/Search (▶▶) or (◀◀) button, normal playback will resume at that point.

## OPERATING INSTRUCTIONS (CONTINUED)

### REPEAT PLAYBACK

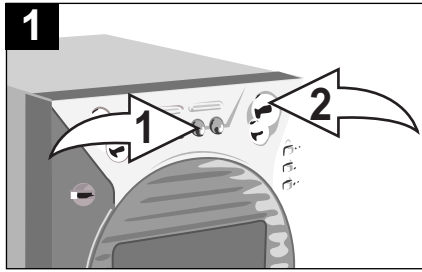

To repeat all of the tracks on a disc continuously, press the REPEAT/MEMORY UP button **1** once; "REPEAT ALL" will light in the display. Press the CD PLAY/PAUSE (**▶||**) button **2** to begin all tracks repeat.

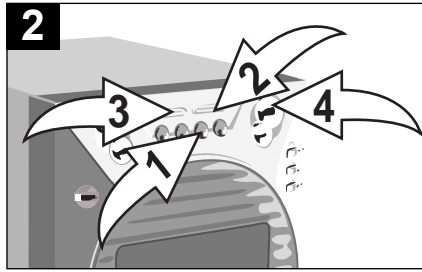

To repeat a single track, press the REPEAT/MEMORY UP button **1** twice; "REPEAT ONE" will light in the display. Press the CD Skip/Search (**▶▶**) button **3** or (**◀◀**) button **4** to select the specific track that you wish to repeat. When the desired track number appears in the display, press the PLAY/PAUSE (**▶||**) button **2** to begin playback. The specific track you selected will be repeated continuously.

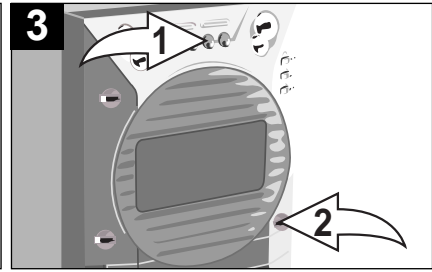

To cancel Repeat Playback, press the REPEAT/MEMORY UP button **1** until "REPEAT" disappears from the display. You can also cancel Repeat Playback by pressing the OPEN/CLOSE button **2**.

### PROGRAMMED PLAYBACK

The CD player in this unit has a 30 track programmable memory that allows you to program up to 20 tracks on any disc for playback in any desired order. You may program 30 different tracks or you may also program certain tracks to play more than once.

To perform programmed playback, proceed as follows:

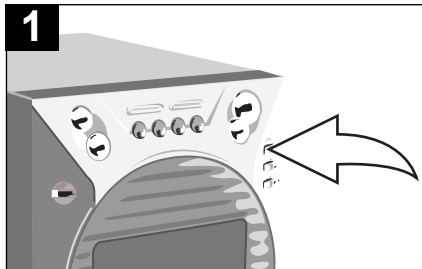

Press the CD Function button to select CD.

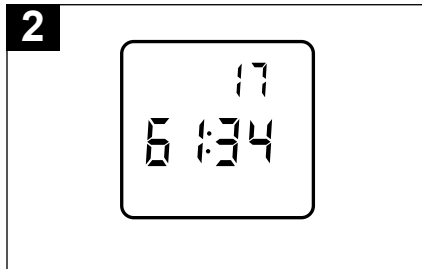

Insert a CD with the label side facing up. Wait for the CD player to read the table of contents and display the total number of tracks and playing time of the disc.

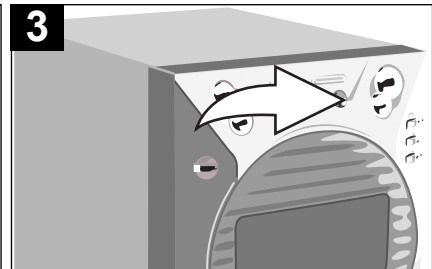

Press the MEMORY/CLOCK SET button. "P-01" (program number), "00" (track number) will appear and "MEMORY" will appear in the display.

PROGRAMMED PLAYBACK SECTION CONTINUED ON NEXT PAGE.

## OPERATING INSTRUCTIONS (CONTINUED)

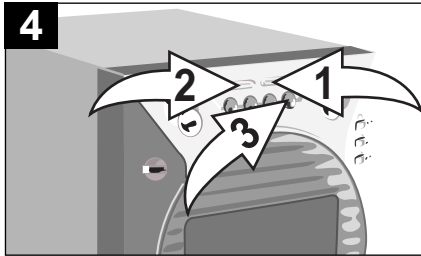

4 Press the CD Skip/Search (▶▶) ❶ or (◀◀) button ❷ to select the first track that you wish to program. When the desired track number appears in the display, press the MEMORY/CLOCK SET button ❸ again.

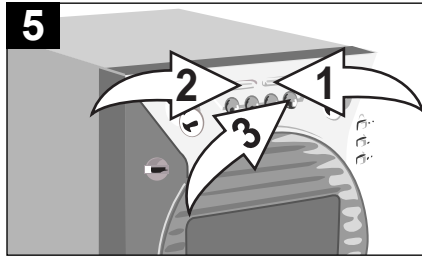

5 Press either the CD Skip/Search (▶▶) ❶ or (◀◀) button ❷ to select the next track you wish to program. When the desired track number appears in the display, press the MEMORY/CLOCK SET button ❸ again.

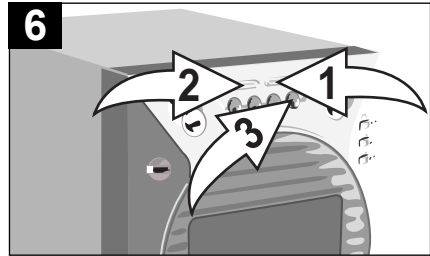

6 Repeat step 5 until you have programmed up to 30 track numbers into the CD Program Memory.

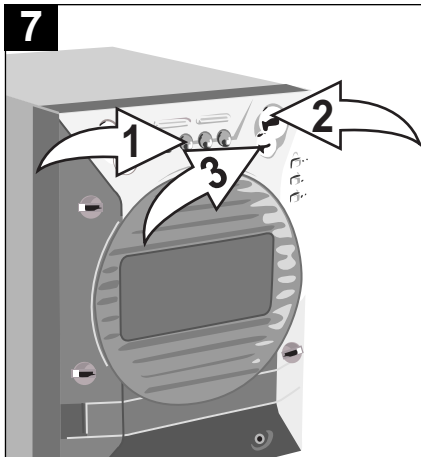

7 After programming up to 30 tracks in the CD Program Memory, press the PLAY/PAUSE (▶||) button ❶ to begin programmed playback. "MEMORY" will appear in the display and playback will begin on the first track that you programmed. The player will continue to play all of the tracks that you programmed in the order in which you programmed them. When the last programmed track has been played, the player will stop and the display will again show the total number of tracks on the disc. If you press the MEMORY/CLOCK SET button ❷ and then press the PLAY/PAUSE (▶||) button ❶ again, playback will start on the first track you programmed and will continue until all the programmed tracks have been played. To cancel the Programmed Playback mode, press the MEMORY/CLOCK SET button ❷ to enter the program mode, and then press the STOP (■) button ❸ twice.

### PROGRAMMED REPEAT

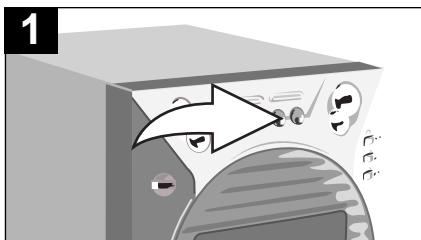

1 It is also possible to use the Program and Repeat functions together to repeat a specific program indefinitely. First, program the tracks you wish to hear in the order you wish to hear them, as described above. Then, press the REPEAT/MEMORY UP button twice. Both the MEMORY and REPEAT indicators will appear in the display.

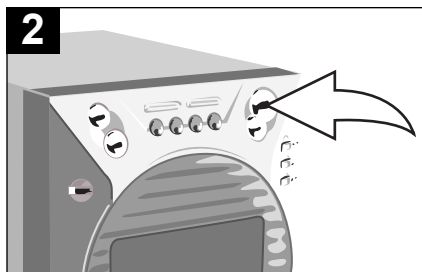

2 Press the PLAY/PAUSE (▶||) button to begin programmed repeat playback. The player will play the tracks you selected in the order in which you programmed them. When the last track in the program has been played, the entire program will begin again.

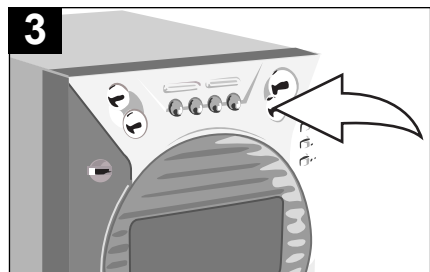

3 Program Repeat operation will continue indefinitely until you press the STOP (■) button.

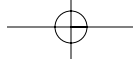

## OPERATING INSTRUCTIONS (CONTINUED)

### RANDOM PLAYBACK

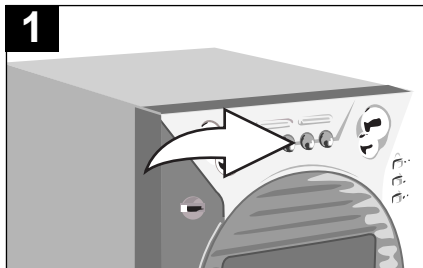

To play the tracks on the CD in a random order, press the RANDOM button.

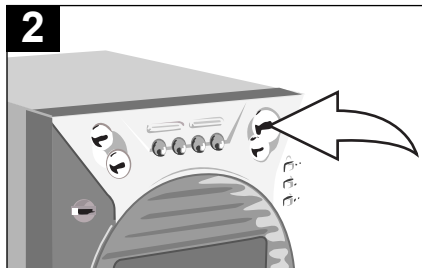

Press the PLAY/PAUSE (▶||) button to begin random playback. All the tracks will play in a random order.

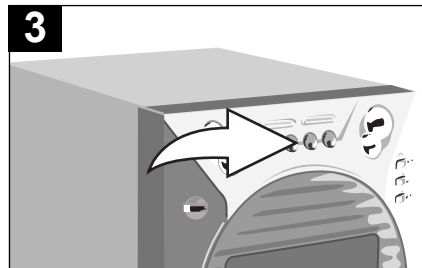

To cancel random playback, press the RANDOM button until "RANDOM" disappears from the display.

## CARE AND MAINTENANCE

### Caring for Compact Discs

- Treat the compact disc carefully. Handle the compact disc only by its edges. Never allow your fingers to come in contact with the shiny, unprinted side of the compact disc.
- Do not attach adhesive tape, stickers, etc. to the compact disc label.
- Clean the compact disc periodically with a soft, lint-free, dry cloth. Never use detergents or abrasive cleaners to clean the compact disc. If necessary, use a CD cleaning kit.
- If a compact disc skips or gets stuck on a section of the compact disc, it is probably dirty or damaged (scratched).
- When cleaning the compact disc, wipe in straight lines from the center of the compact disc to the outer edge of the compact disc. Never wipe in circular motions.

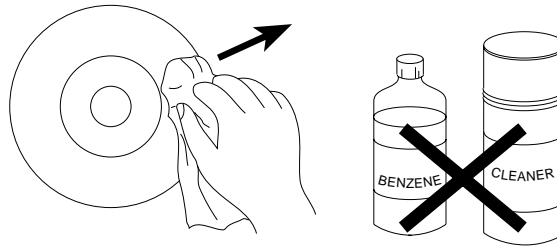
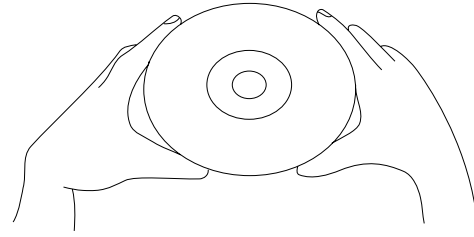

- This unit is designed to play only compact discs bearing the identification logo as shown here. Other compact discs may not conform to the CD standard and may not play properly.
- Compact discs should be stored in their cases after each use to avoid damage.
- Do not expose compact discs to direct sunlight, high humidity, high temperatures, or dust, etc. Prolonged exposure or extreme temperatures can warp the compact disc.
- Do not stick or write anything on either side of the compact disc. Sharp writing instruments, or the ink may damage the surface.



## TROUBLESHOOTING GUIDE

Should this unit exhibit a problem, check the following before seeking service:

Symptom	Possible Cause	Solution
<b>Radio</b>		
Noise or sound distorted on radio broadcasts.	Station not tuned properly for AM or FM.	Retune the AM or FM broadcast station.
	FM: Wire Antenna is not extended.	Extend FM Rod Antenna.
	AM: Unit is not positioned correctly.	Rotate unit until best reception is obtained.
FM STEREO indicator does not light.	Poor FM signal being received.	Retune station or try another station that broadcasts in stereo.
	Station is not broadcasting in stereo.	Change stations.
AM or FM, no sound.	TUNER/Band Function button is not pressed.	Press the TUNER/Band Function button to select Tuner.
	Volume at minimum.	Increase volume.
<b>Compact Disc Player</b>		
CD Player will not play.	CD function is not selected.	Press the CD Function button to select CD.
	CD is not installed or installed incorrectly.	Insert CD with label facing up.
CD skips while playing.	Disc is dirty or scratched.	Wipe disc with cloth or use another disc.
<b>General</b>		
No power.	AC power cord is not connected.	Connect AC power cord.
Remote not working.	Batteries not inserted, or inserted correctly.	Insert batteries correctly.



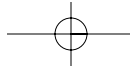

**FOR ADDITIONAL SET-UP OR OPERATING ASSISTANCE, PLEASE VISIT OUR WEBSITE AT  
[WWW.MEMCORPINC.COM](http://WWW.MEMCORPINC.COM)  
OR CONTACT CUSTOMER SERVICE AT 1-800-919-3647.**

**PLEASE KEEP ALL PACKAGING MATERIAL FOR AT LEAST 90 DAYS IN CASE YOU NEED  
TO RETURN THIS PRODUCT TO YOUR PLACE OF PURCHASE OR MEMOREX.**

**FOR PARTS AND ACCESSORIES, CONTACT FOX INT'L AT 1-800-321-6993.**

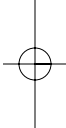
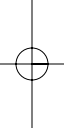
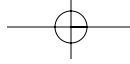

Memcorp, Inc.  
Weston, FL  
Printed in Hong Kong

Visit our website at [www.memcorpinc.com](http://www.memcorpinc.com)



## Free Manuals Download Website

<http://myh66.com>

<http://usermanuals.us>

<http://www.somanuals.com>

<http://www.4manuals.cc>

<http://www.manual-lib.com>

<http://www.404manual.com>

<http://www.luxmanual.com>

<http://aubethermostatmanual.com>

Golf course search by state

<http://golfingnear.com>

Email search by domain

<http://emailbydomain.com>

Auto manuals search

<http://auto.somanuals.com>

TV manuals search

<http://tv.somanuals.com>