



OWNER'S MANUAL
MANUAL DE INSTRUCCIONES

Memorex®

VIDEO CASSETTE RECORDER VIDEOGRABADOR DE CASSETTE

MVR2040A

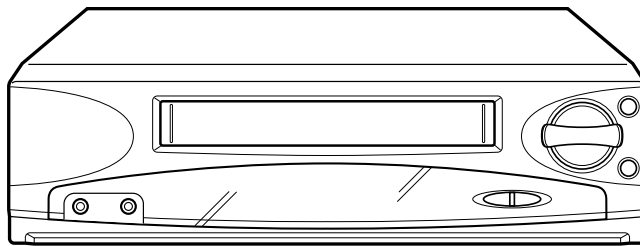
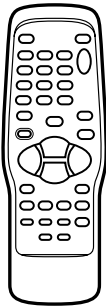

ATTENTION ATENCIÓN

For your protection in the event of theft or loss of this product, please fill in the information listed below which is for your own personal records.

Por su precaución en caso de robo o pérdida de este producto, favor de llenar la información listada abajo que es para sus inscripciones personales de usted.

Date of purchase : _____
Fecha de compra : _____
Serial No. : _____
Número de serie : _____
Place of Purchase : _____
Lugar de compra : _____

TV/CATV MODE SELECTION SELECCION DE MODO DE TV/CATV

When shipped from the factory, the TV/CATV menu option is set to the "CATV" (Cable Television) mode.

If not using CATV (Cable TV), set this menu option to the "TV" mode.

A la salida de fábrica, la opción de menú TV/CATV está en el modo "CATV" (televisión por cable).

Si no se va a utilizar el CATV (TV cable), cambie la opción de este menú al modo TV.





Before operating the unit, please read this manual thoroughly.
Antes de usar la unidad, lea detenidamente este manual del usuario.





ENGLISH

	CAUTION RISK OF ELECTRIC SHOCK DO NOT OPEN	
<p>CAUTION: TO REDUCE THE RISK OF ELECTRIC SHOCK, DO NOT REMOVE COVER (OR BACK). NO USER-SERVICEABLE PARTS INSIDE. REFER SERVICING TO QUALIFIED SERVICE PERSONNEL.</p>		



The lightning flash with arrowhead symbol within an equilateral triangle is intended to alert the user to the presence of uninsulated dangerous voltage within the product's enclosure that may be of sufficient magnitude to constitute a risk of electric shock to persons.



The exclamation point within an equilateral triangle is intended to alert the user to the presence of important operating and maintenance (servicing) instructions in the literature accompanying the appliance.

WARNING: TO REDUCE THE RISK OF FIRE OR ELECTRIC SHOCK, DO NOT EXPOSE THIS APPLIANCE TO RAIN OR MOISTURE.

WARNING: This equipment has been tested and found to comply with the limits for a Class B digital device, pursuant to Part 15 of the FCC Rules. These limits are designed to provide reasonable protection against harmful interference in a residential installation. This equipment generates, uses, and can radiate radio frequency energy and, if not installed and used in accordance with the instructions, may cause harmful interference to radio communications. However, there is no guarantee that interference will not occur in a particular installation. If this equipment does cause harmful interference to radio or television reception, which can be determined by turning the equipment off and on, the user is encouraged to try correcting the interference by one or more of the following measures:

- Reorient or relocate the receiving antenna.
- Increase the separation between the equipment and receiver.
- Connect the equipment into an outlet on a circuit different from that to which the receiver is connected.
- Consult the dealer or an experienced radio/TV technician for help.

CAUTION: Changes or modifications not expressly approved by the party responsible for compliance with the FCC Rules could void the user's authority to operate this equipment.





IMPORTANT SAFEGUARDS

1. READ INSTRUCTIONS

All the safety and operating instructions should be read before the unit is operated.

2. RETAIN INSTRUCTIONS

The safety and operating instructions should be retained for future reference.

3. HEED WARNINGS

All warnings on the unit and in the operating instructions should be adhered to.

4. FOLLOW INSTRUCTIONS

All operating and use instructions should be followed.

5. CLEANING

Unplug this unit from the wall outlet before cleaning. Do not use liquid cleaners or aerosol cleaners.

Use a damp cloth for cleaning.

6. ATTACHMENTS

Do not use attachments not recommended by the unit's manufacturer as they may cause hazards.

7. WATER AND MOISTURE

Do not use this unit near water. For example, near a bathtub, washbowl, kitchen sink, or laundry tub, in a wet basement, or near a swimming pool.

8. ACCESSORIES

Do not place this unit on an unstable cart, stand, tripod, bracket, or table. The unit may fall, causing serious injury, and serious damage to the unit. Use only with a cart, stand, tripod, bracket, or table recommended by the manufacturer.

PORTABLE CART WARNING
(symbol provided by RETAC)



S3126A

8A. An appliance and cart combination should be moved with care. Quick stops, excessive force, and uneven surfaces may cause the appliance and cart combination to overturn.

9. VENTILATION

Slots and openings in the cabinet and in the back or bottom are provided for ventilation and to ensure reliable operation of the unit and to protect it from overheating. These openings must not be blocked or covered. The openings should never be blocked by placing the unit on a bed, sofa, rug, or other similar surface. This unit should never be placed near or over a radiator or heat source. This unit should not be placed in built-in installations such as a bookcase or rack unless proper ventilation is provided or the manufacturer's instructions have been adhered to.

10. POWER SOURCES

This unit should be operated only from the type of power source indicated on the rating plate. If you are not sure of the type of power supply to your home, consult your appliance dealer or local power company. For units intended to operate from battery power, or other sources, refer to the operating instructions.

11. GROUNDING OR POLARIZATION

This unit is equipped with a polarized alternating-current line plug (a plug having one blade wider than the other). This plug will fit into the power outlet only one way. This is a safety feature. If you are unable to insert the plug fully into the outlet, try reversing the plug. If the plug should still fail to fit, contact your electrician to replace your obsolete outlet. Do not defeat the safety purpose of the polarized plug. If your unit is equipped with a 3-wire grounding-type plug, a plug having a third (grounding) pin, this plug will only fit into a grounding-type power outlet. This too, is a safety feature. If you are unable to insert the plug into the outlet, contact your electrician to replace your obsolete outlet.

Do not defeat the safety purpose of the grounding-type plug.



IMPORTANT SAFEGUARDS

(CONTINUED)

12. POWER-CORD PROTECTION

Power-supply cords should be routed so that they are not likely to be walked on or pinched by items placed upon or against them, paying particular attention to cords at plugs, convenience receptacles, and the point where they exit from the appliance.

13. LIGHTNING

To protect your unit from a lightning storm, or when it is left unattended and unused for long periods of time, unplug it from the wall outlet and disconnect the antenna or cable system. This will prevent damage to the unit due to lightning and power line surges.

14. POWER LINES

An outside antenna system should not be located in the vicinity of overhead power lines or other electric light or power circuits, or where it can fall into such power lines or circuits. When installing an outside antenna system, extreme care should be taken to keep from touching such power lines or circuits, as contact with them might be fatal.

15. OVERLOADING

Do not overload wall outlets and extension cords, as this can result in a risk of fire or electric shock.

16. OBJECT AND LIQUID ENTRY

Do not push objects through any openings in this unit as they may touch dangerous voltage points or short out parts that could result in fire or electric shock. Never spill or spray any type of liquid into the unit.

17. OUTDOOR ANTENNA GROUNDING

If an outside antenna or cable system is connected to the unit, be sure the antenna or cable system is grounded so as to provide some protection against voltage surges and built-up static charges. Section 810 of the National Electrical Code, ANSI/NFPA 70, provides information with respect to proper grounding of the mast and supporting structure, grounding of the lead-in wire to an antenna discharge unit, size of grounding conductors, location of antenna discharge unit, connection to grounding electrodes, and requirements for the grounding electrode.

18. SERVICING

Do not attempt to service this unit yourself as opening or removing covers may expose you to dangerous voltage or other hazards. Refer all servicing to qualified service personnel.

19. DAMAGE REQUIRING SERVICE

Unplug this unit from the wall outlet and refer servicing to qualified service personnel under the following conditions:

- a. When the power-supply cord or plug is damaged.
- b. If liquid has been spilled, or objects have fallen into the unit.
- c. If the unit has been exposed to rain or water.
- d. If the unit does not operate normally by following the operating instructions. Adjust only those controls that are covered by the operating instructions, as an improper adjustment of other controls may result in damage and will often require extensive work by a qualified technician to restore the unit to its normal operation.
- e. If the unit has been dropped or the cabinet has been damaged.
- f. When the unit exhibits a distinct change in performance, this indicates a need for service.

20. REPLACEMENT PARTS

When replacement parts are required, be sure the service technician uses replacement parts specified by the manufacturer or those that have the same characteristics as the original parts.

Unauthorized substitutions may result in fire, electric shock or other hazards.





21. SAFETY CHECK

Upon completion of any service or repairs to this unit, ask the service technician to perform safety checks to determine that the unit is in proper operating condition.

22. WALL OR CEILING MOUNTING

The product should be mounted to a wall or ceiling only as recommended by the manufacturer.

23. HEAT

The product should be situated away from heat sources such as radiators, heat registers, stoves, or other products (including amplifiers) that produce heat.

24. NOTE TO CATV SYSTEM INSTALLER

This reminder is provided to call the CATV system installer's attention to Article 820-40 of the NEC that provides guidelines for proper grounding and, in particular, specifies that the cable ground shall be connected to the grounding system of the building, as close to the point of cable entry as practical.

EXAMPLE OF ANTENNA GROUNDING AS PER THE NATIONAL ELECTRICAL CODE

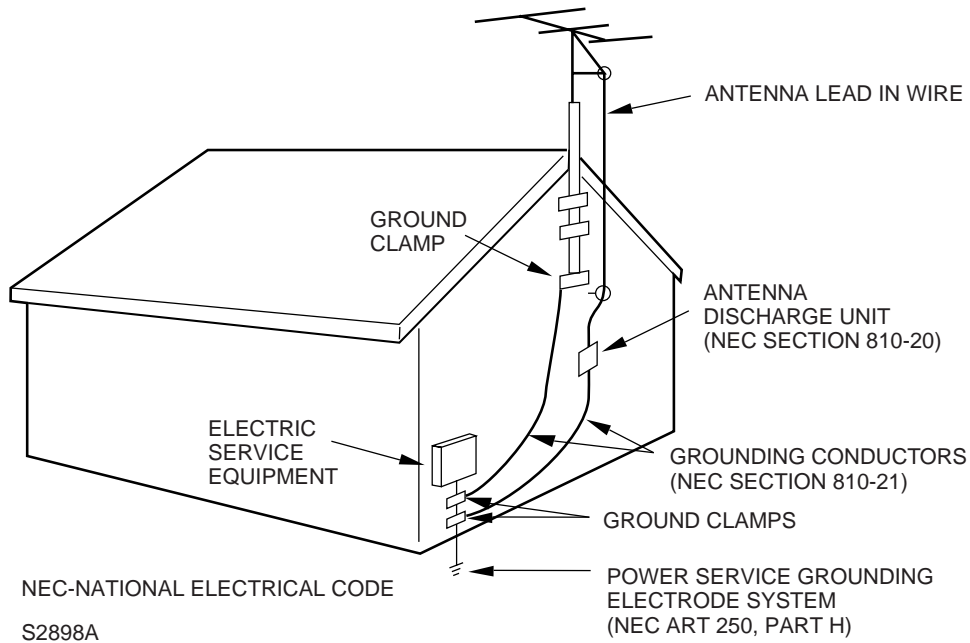



FEATURES

High Quality Picture Technology - This video cassette recorder marked "HQ" incorporates VHS high quality technology. A built-in detail enhancer is used to boost the recorded signal and provide maximum picture quality in playback. It is compatible with other VHS video cassette recorders.

Frequency Synthesized Tuning - Quartz locked direct access tuner automatically locks in each channel for perfect reception.

Full Load Tape Transport - Permits rapid access between modes.

4 Video Head - Provides optimal picture quality for special effects playback.

8-Program/1-Month Programmable Timer with Everyday/Every Week Capability - The built-in timer allows automatic absentee recording of up to 8 TV programs within 1 month. It is also possible to record a program which is broadcast at the same time everyday or every week.

On-Screen Display and Programming - When you select a channel or make other changes, the TV will show an indicator on the screen for a few seconds. Clock settings, timer setting and other set-up operations can be carried out using the on-screen display menu system.

Digital Auto Tracking - Automatically adjusts tracking during playback for the best possible picture.

181 Channel Tuner - Receives standard VHF and UHF broadcast channels and up to 113 cable channels.

One-Touch Timer Recording (OTR) - Simply by pressing the REC/OTR button, the VCR can be programmed for up to 5 hours of recording with an immediate start.

Automatic Power On - When loading a cassette tape, this VCR will automatically turn on.

Automatic Playback - When loading a cassette tape without the erase prevention tab, this VCR will automatically turn on and play back the cassette tape at the correct speed.

Automatic Rewind-Stop-Eject-Power Off - When a tape reaches its end during playback and recording, it will automatically stop, rewind, stop, eject the tape and the VCR will turn off.

Automatic Repeat Play System - When the AUTO REPEAT option is turned on, this VCR will automatically play back the same cassette tape repeatedly.

On-Screen 3 Language Display - You can select one of 3 languages; English, Spanish or French, for on-screen programming.

Frame by Frame Advance - Press the SLOW button during still playback to advance the tape one frame at a time.

Slow Motion - This VCR provide slow motion which offers steady, noise-free playback at 1/10 normal speed.

Real Time Tape Counter - The counter displays on the screen the elapsed time in hours, minutes and seconds and can be used to locate programs.

Channel Skip - An unwanted channel can be deleted when using the CHANNEL ▲ or ▼ button.

Fluorescent Multi-Function Display - Selected functions are immediately indicated on the display.

2 Speed Picture Search - 3 or 5 times normal speed in SP mode (7X or 9X in LP and 9X or 15X in SLP).

3 Speed Record/Playback - Records and plays three tape speeds (SP, LP, SLP).

Skip Search - When the SKIP SEARCH button on the remote control is pressed during playback, the VCR will automatically search forward through approximately 60 seconds of tape, and then return to normal playback.

Auto head Cleaning System - Cleans the video heads automatically when a cassette tape is loaded and ejected.

6



TABLE OF CONTENTS

We recommend that you carefully read the descriptions and operating procedures contained in this Owner's Manual prior to operating your new VCR.

ENGLISH

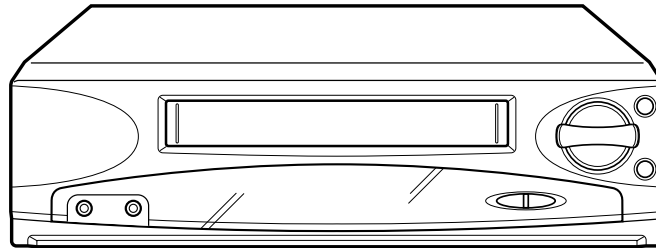

PRECAUTIONS

PRECAUTIONS	8
LOCATION OF CONTROLS	10
REMOTE CONTROL	12
BASIC CONNECTIONS	14
CATV (CABLE TV) CONNECTIONS	18
AUDIO/VIDEO CONNECTIONS	22
SETTING THE VIDEO CHANNEL	23
ON-SCREEN LANGUAGE SELECTION	24
SETTING THE CLOCK	25
SETTING THE CHANNELS	26
NOISE ELIMINATION (BLUE SCREEN)	29

PLAYBACK

LOADING AND UNLOADING VIDEO CASSETTE TAPES	30
PLAYBACK	31
SPECIAL PLAYBACK	33

RECORDING

RECORDING A TV PROGRAM	35
SETTING THE TIMER RECORDING	38
ONE TOUCH TIMER RECORDING (OTR)	41

ADDITIONAL INFORMATION

ON-SCREEN FUNCTION DISPLAY	42
DUPLICATING A VIDEO TAPE	43
VIDEO GLOSSARY	44
BEFORE REQUESTING SERVICE	46
VIDEO HEAD CLEANING	48
SPECIFICATIONS	49





PRECAUTIONS

MOISTURE CONDENSATION

DO NOT OPERATE THIS VCR FOR AT LEAST TWO OR THREE HOURS WHEN MOISTURE IN THE AIR CONDENSES ON THE VCR.

■ WHAT IS MOISTURE CONDENSATION?

When a cold liquid is poured into a glass, for example, water vapor in the air will condense on the surface of the glass. This is called moisture condensation.

■ MOISTURE WILL CONDENSE ON THE UNIT IN THE FOLLOWING CASES;

- When you move this VCR from a cold to a warm place.
- After heating a cold room or under extremely humid conditions.

■ WHEN YOU EXPERIENCE THE ABOVE CONDITIONS,

Plug the power cord into an AC outlet, set the power switch to ON and leave the unit at room temperature until moisture condensation disappears.

Depending on the surrounding conditions, this may take two or three hours.

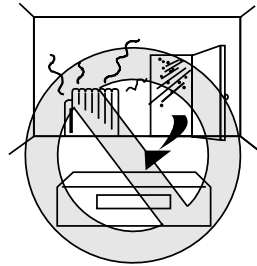
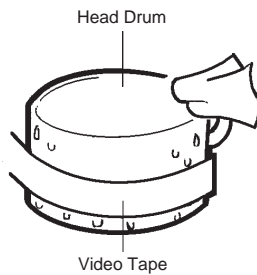

If you cause a static discharge when touching the VCR, and the VCR fails to function, simply unplug the unit from the wall outlet, wait a few minutes and plug it back in. The VCR should return to normal operation.

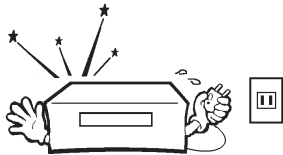

Avoid extreme heat.

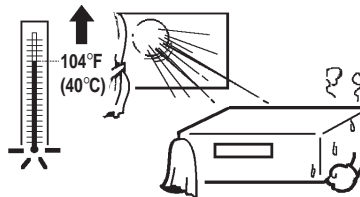

Do not place the VCR on or near appliances which may cause electromagnetic interference, e.g. TV, speakers, etc. Doing so may cause erratic operation of the VCR including picture and/or sound distortion or noise.

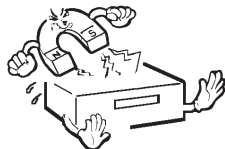

Avoid extreme cold.

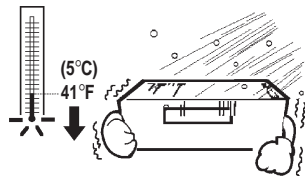



Avoid extreme moisture and dust.

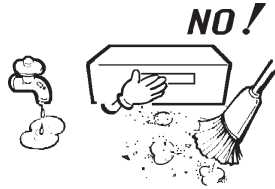

The ventilation holes prevent overheating. Do not block or cover these holes. Especially avoid covering the holes with soft materials such as cloth or paper.

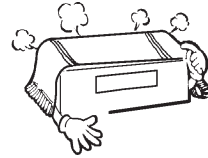

Do not insert fingers or any other objects into the cassette loading slot. Do not spray cleaner or wax directly on the VCR or use forced air to remove dust.

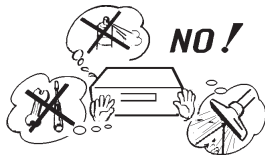

Avoid places subject to strong vibration. Use in a horizontal (flat) position only.

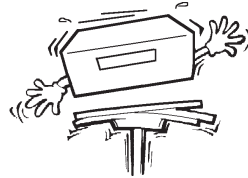

Keep the VCR away from flower vases, sinks, etc. If liquids should be spilled into the VCR, serious damage will result. If you spill any liquids into the VCR, unplug the AC power cord immediately and consult qualified service personnel before attempting to use the VCR again.



When you finish operating the VCR, always unload the cassette and turn off the power.

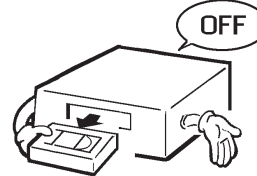

When you leave your home for a long time, unplug the AC power cord.

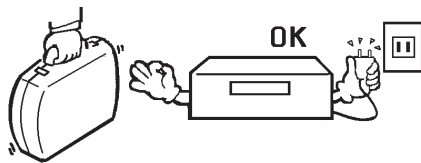

To protect the VCR from a lightning storm, unplug the AC power cord from the wall outlet and disconnect the antenna.



POWER SOURCE

If the polarized AC cord does not fit into a non-polarized AC outlet, do not attempt to file or cut the blade. It is the user's responsibility to have an electrician replace the obsolete outlet.

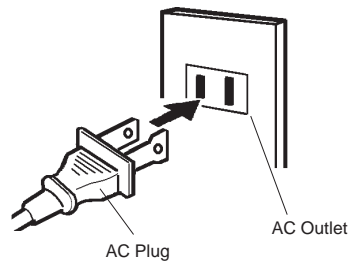



LOCATION OF CONTROLS

FRONT

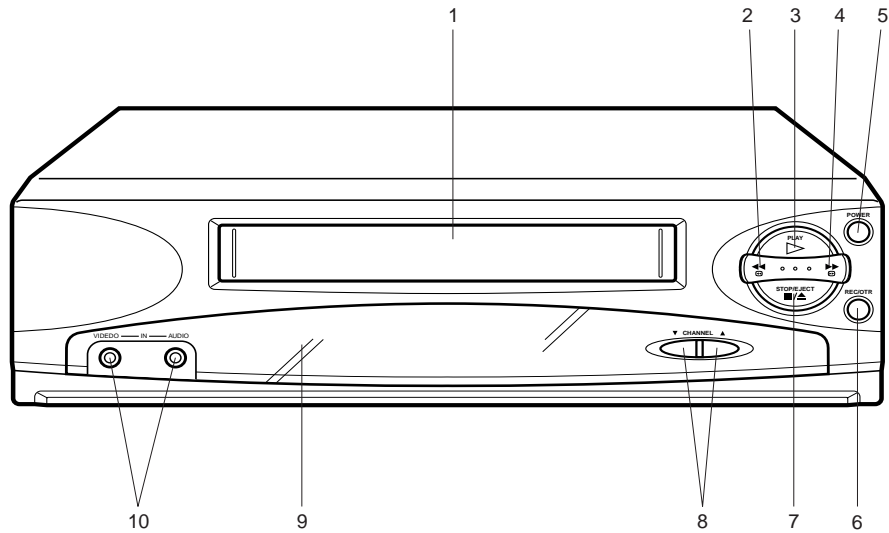

DESCRIPTION OF CONTROLS

- 1. Cassette Loading Slot** - To insert or remove a video tape.
- 2. ◀◀ (Rewind) button** - In the STOP mode, this button rapidly winds the tape backwards. In the PLAY mode, this button activates Reverse Search.
- 3. PLAY button** - Press to play a prerecorded tape.
- 4. ▶▶ (Fast Forward) button** - In the STOP mode, this button rapidly winds the tape forward. In the PLAY mode, this button activates Forward Search.
- 5. POWER button** - Turns the VCR power on and off.
- 6. REC/OTR button** - Press once to start normal recording. Additional presses activate One Touch Recording.
- 7. STOP/EJECT button** - Press once to stop the tape in any mode. Press again (on the VCR) to eject the tape.
- 8. CHANNEL ▲ / ▼ buttons** - Used to select a channel for viewing or recording.
- 9. Remote Sensor** - Signals from the Remote Control are received here.
- 10. AUDIO/VIDEO IN jacks** - Audio and video signal cables from an external source can be connected here.

10





ENGLISH

FLUORESCENT DISPLAY

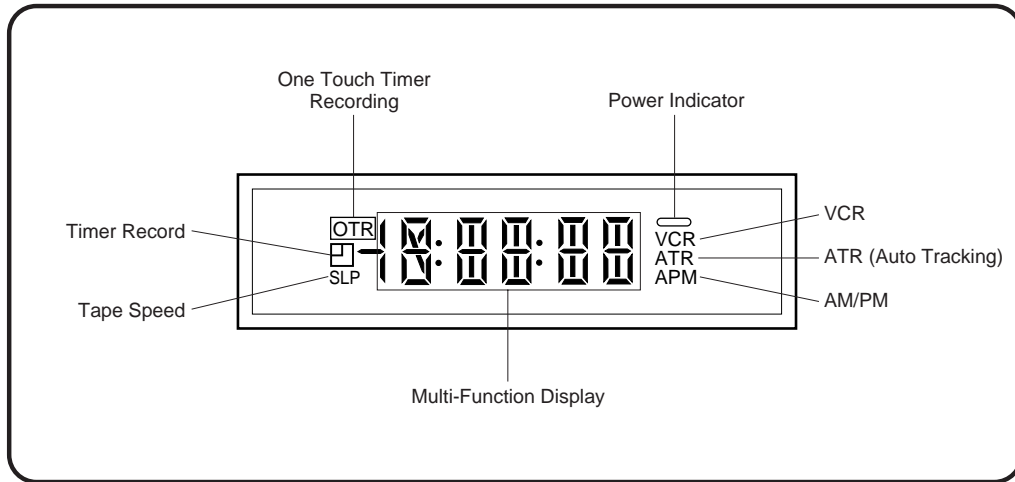

LOCATION OF CONNECTORS

REAR

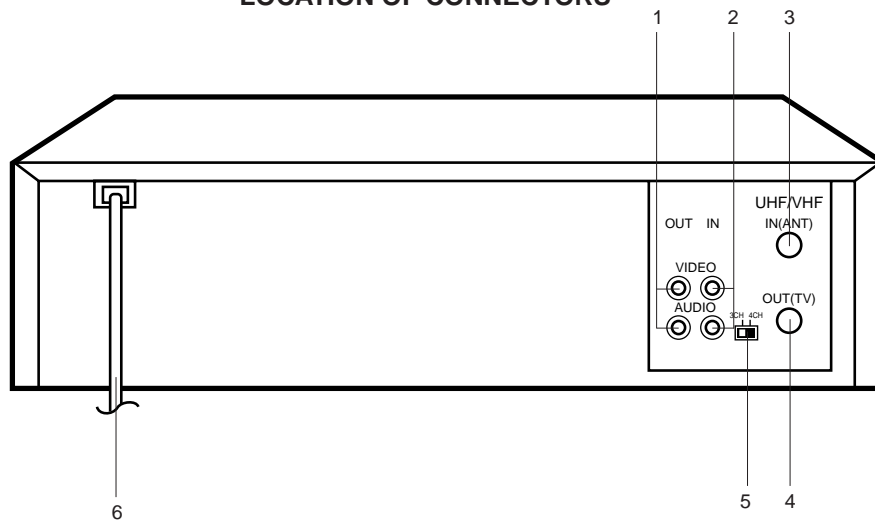

DESCRIPTION OF CONTROLS

- 1. AUDIO/VIDEO OUT Jacks** - Used to output audio and video signals to a TV, amplifier or VCR.
- 2. AUDIO/VIDEO IN Jacks** - Audio and video signal cables from an external source can be connected here.
- 3. VHF/UHF IN (ANT) Jack** - Connect a VHF/UHF antenna or CATV cable to this jack.
- 4. VHF/UHF OUT (TV) Jack** - Used to output VHF/UHF or CATV signals to a TV.
- 5. 3/4 Channel Selector Switch** - Selects the channel through which the VCR outputs its signal to a TV.
- 6. AC Power Cord** - Connect to a 120V 60Hz outlet.





REMOTE CONTROL

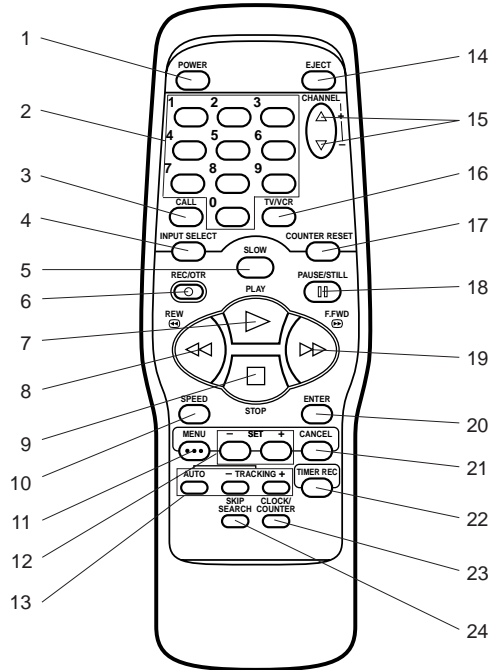

DESCRIPTION OF BUTTONS

- POWER button** - Turns the VCR power on and off.
- Direct Channel Selection buttons (0-9)** - Allow direct access to any channel.
- CALL button** - Displays the present time/day of the week, channel, counter, speed selection and VCR mode on the TV screen.
- INPUT SELECT button** - Switches the program for viewing between the VCR and an external input source.
- SLOW button** - Press to play back a tape in slow motion or to advance the tape one frame at a time during still playback.
- REC/OTR button** - Press once to start normal recording. Additional presses activate One-touch Timer Recording.
- PLAY button** - Press to play a prerecorded tape.
- REW button** - In the STOP mode, this button rapidly winds the tape backwards. In the PLAY mode, this button activates Reverse Search.
- STOP button** - Press once to stop the tape.
- SPEED (SP/LP/SLP) selector button** - Sets the tape speed for recording.
- MENU button** - Press to display the on-screen menu function.
- SET +/- buttons** - Used to set the clock, timer recording, auto repeat, language and noise mute.
- AUTO/Manual TRACKING buttons** - Allow automatic or manual adjustment of tracking to minimize picture noise during playback.
- EJECT button** - Press to eject the tape.
- CHANNEL ▲ / ▼ buttons** - Used to select a channel for viewing or recording.
- TV/VCR selector button** - Switches between TV and VCR.
- COUNTER RESET button** - Resets the Real Time Counter to 00:00:00.
- PAUSE/STILL button** - During recording, this button temporarily stops the tape. The "II" will appear on the screen. During playback, it stops the tape and displays a still image on the TV screen.
- F. FWD button** - In the STOP mode, this button rapidly winds the tape forward. In the PLAY mode, this button activates Forward Search.
- ENTER button** - Used to enter information for timer recording, auto repeat, language and clock setting.
- CANCEL button** - Used to clear the selected timer recording program.
- TIMER REC button** - Used to set the VCR to start recording at a preset time.
- CLOCK/COUNTER selector button** - Switches between the clock and the Real time tape counter.
- SKIP SEARCH button** - Press in playback mode to search forward through approximately 60 seconds of tape.

12



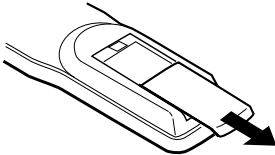
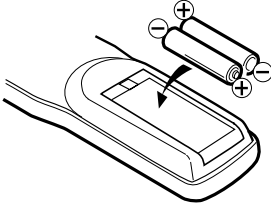
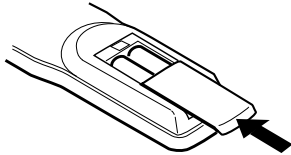

BATTERY INSTALLATION

1 Open the battery compartment cover. 	2 Install two "AAA" (penlight size) batteries. 	3 Replace the cover. 
---	--	---

ENGLISH

BATTERY CAUTIONS

Follow these precautions when using batteries in this device:

1. Use only the size and type of batteries specified.
2. Be sure to follow the correct polarity when installing the batteries as indicated in the battery compartment. Reversed batteries may cause damage to the device.
3. Do not mix different types of batteries together (e.g. Alkaline and Carbon-zinc) or old batteries with fresh ones.
4. If the device is not to be used for a long period of time, remove the batteries to prevent damage or injury from possible battery leakage.
5. Do not try to recharge batteries not intended to be recharged; they can overheat and rupture. (Follow battery manufacturer's directions.)

EFFECTIVE DISTANCE OF THE REMOTE CONTROL

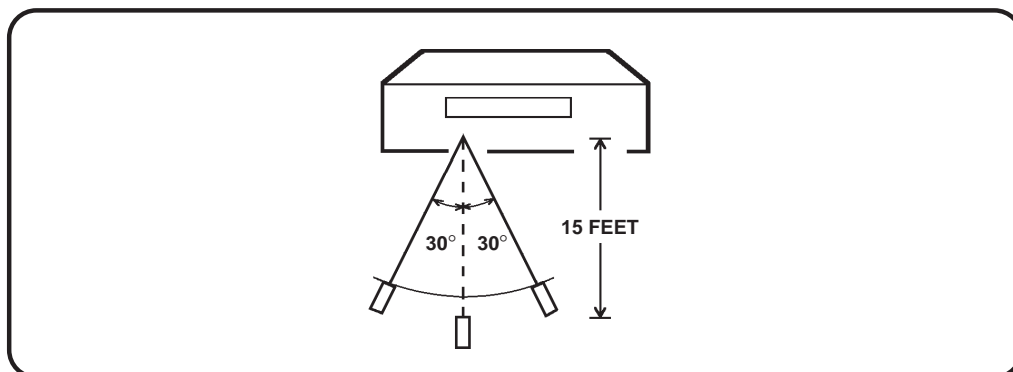

- NOTES:**
- When direct sunlight, an incandescent lamp, fluorescent lamp or any other strong light shines on the Remote Sensor, the remote operation may be unstable.
 - When there is an obstacle between the VCR and the remote control, the remote control may not operate.





BASIC CONNECTIONS

If you are using an antenna system, follow the instructions on pages 14-17. If you are a cable (CATV) subscriber, skip ahead to page 18 for the proper connections.

ANTENNA TO VCR CONNECTION

The VCR must be connected "between" the antenna and the TV. First, disconnect the antenna from the TV and connect it to the VCR. Then connect the VCR to the TV. Below are 3 common methods of connecting an antenna system to a VCR. Find the type of antenna system you are using and follow the connection diagram. After you have connected the antenna to the VCR, follow the instructions on pages 16-17 to connect the VCR to the TV.

1

COMBINATION VHF/UHF ANTENNA WITH 75 OHM COAXIAL CABLE

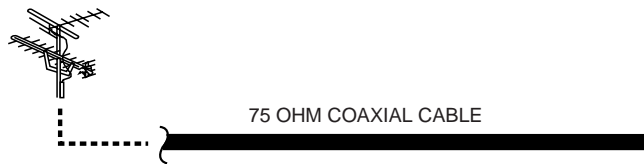

2

COMBINATION VHF/UHF ANTENNA WITH 300 OHM TWIN LEAD (FLAT) WIRE

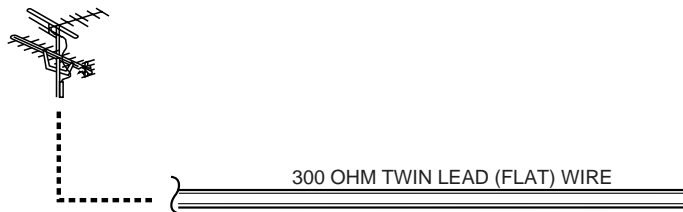

3

SEPARATE VHF AND UHF ANTENNAS

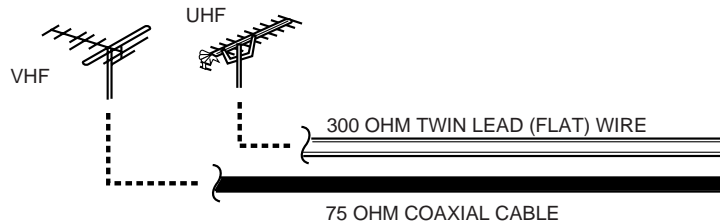

NOTE: If both VHF and UHF antennas have 300 ohm twin lead (flat) wires, use a combiner having two 300 ohm inputs and one 75 ohm output.

- NOTES:**
- A clear picture will not be obtained by the VCR unless the antenna signal is good. Connect the antenna to the VCR properly.
 - For better quality recording, an indoor antenna or a telescopic antenna is not recommended. The use of an outdoor type antenna is required.
 - If you are not sure about the connection, please refer to qualified service personnel.

14





This VCR has a single 75 ohm antenna input for connection to an antenna (VHF/UHF) or cable (CATV) system. If you have separate VHF and UHF antennas (number 3 below), use a combiner to connect the antennas to the VCR.

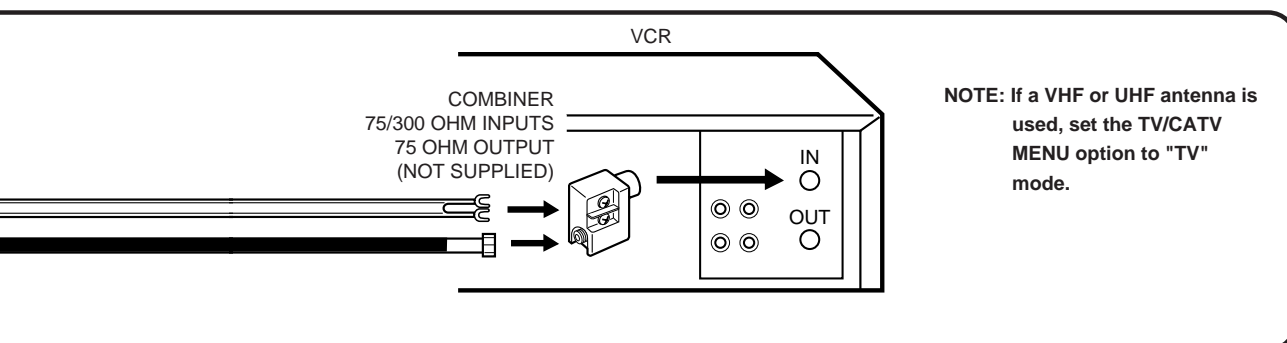
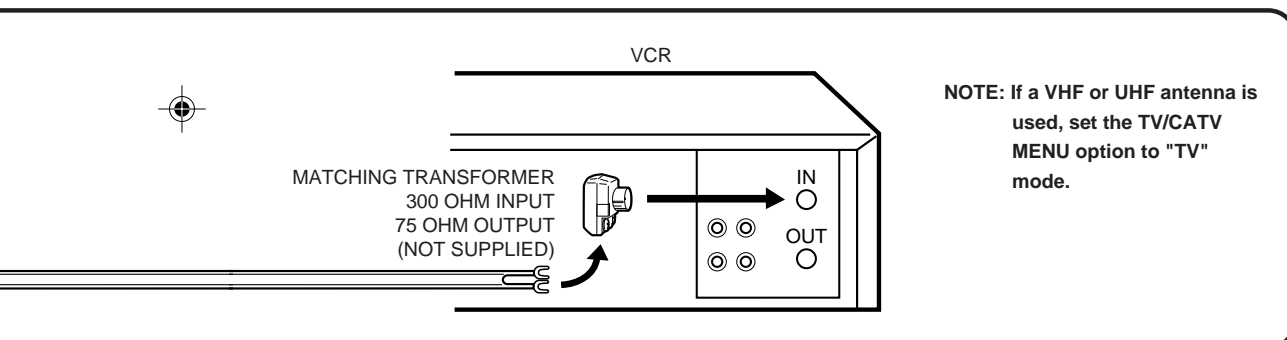
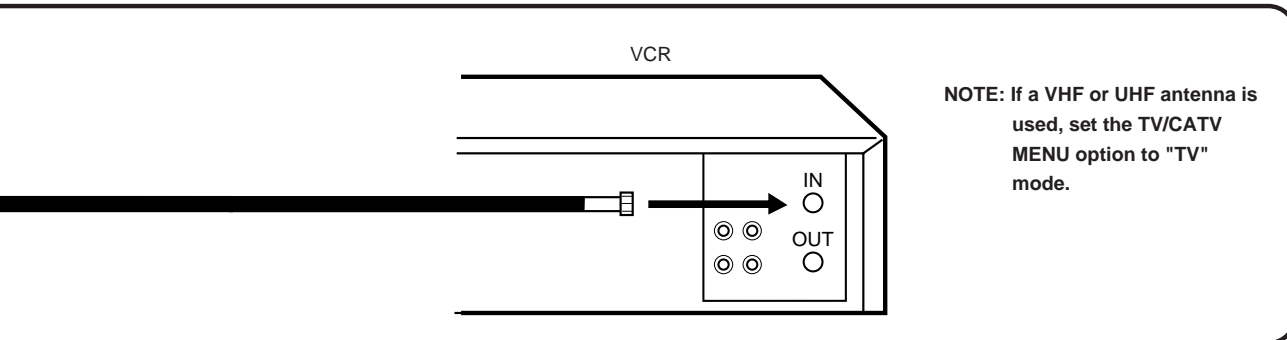



BASIC CONNECTIONS

(CONTINUED)

VCR TO TV CONNECTION

After you have connected the antenna to the VCR (see pages 14 & 15), you must connect the VCR to the TV. Below are 3 common methods of connecting your VCR to a TV. Find the type of TV you are using and follow the connection diagram.

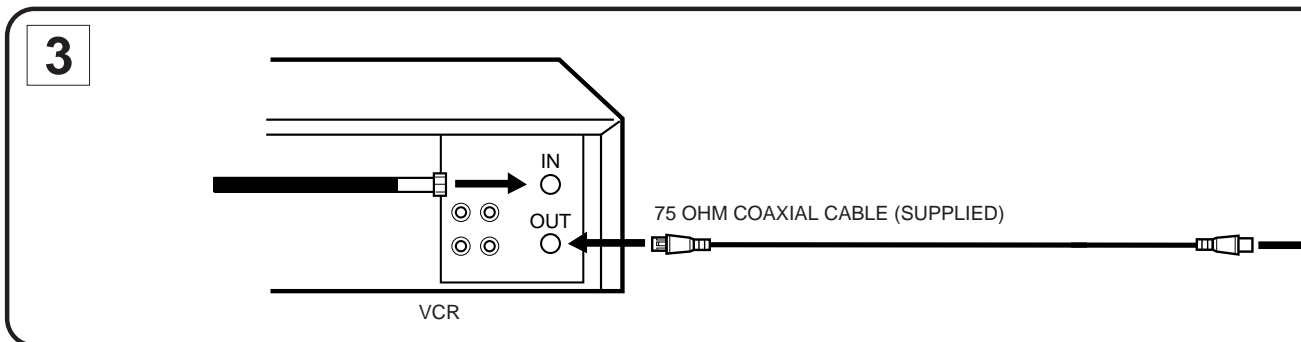
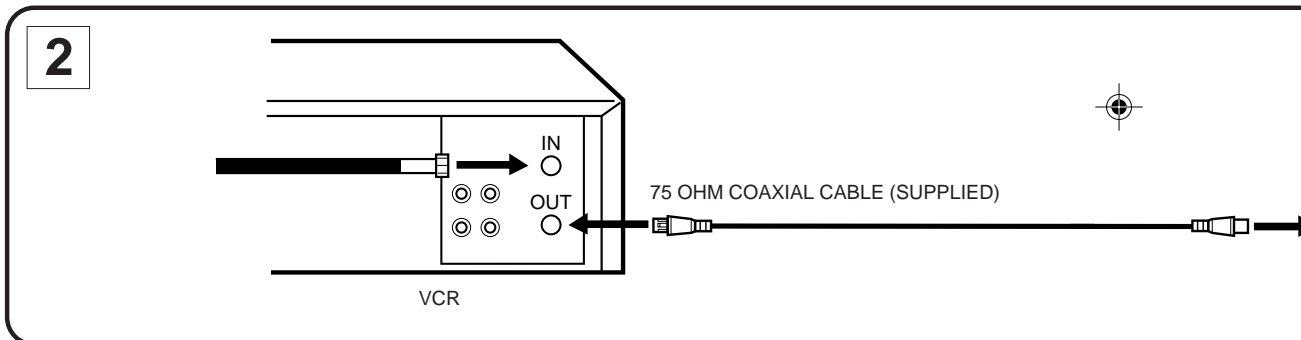
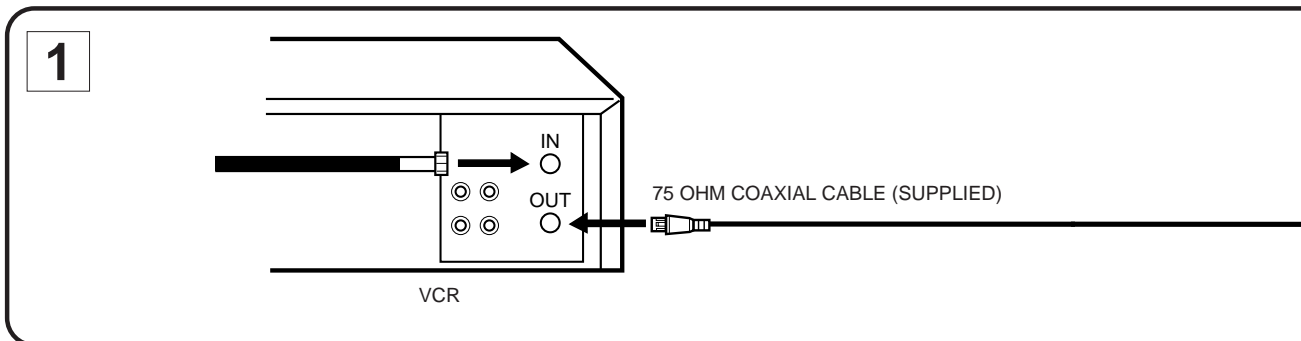



This VCR has a single 75 ohm output for connection to a TV. If your TV has separate VHF and UHF antenna inputs (numbers 2 and 3 below), use a splitter to connect the VCR to the TV for VHF and UHF reception.

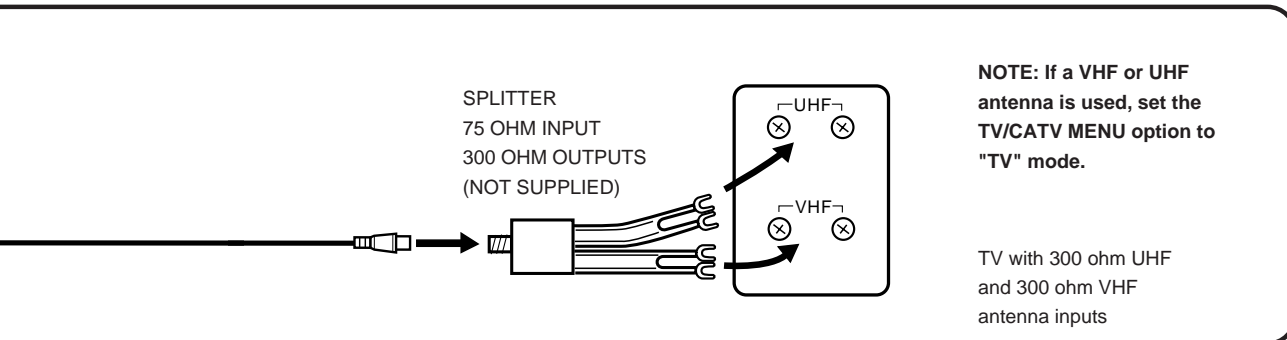
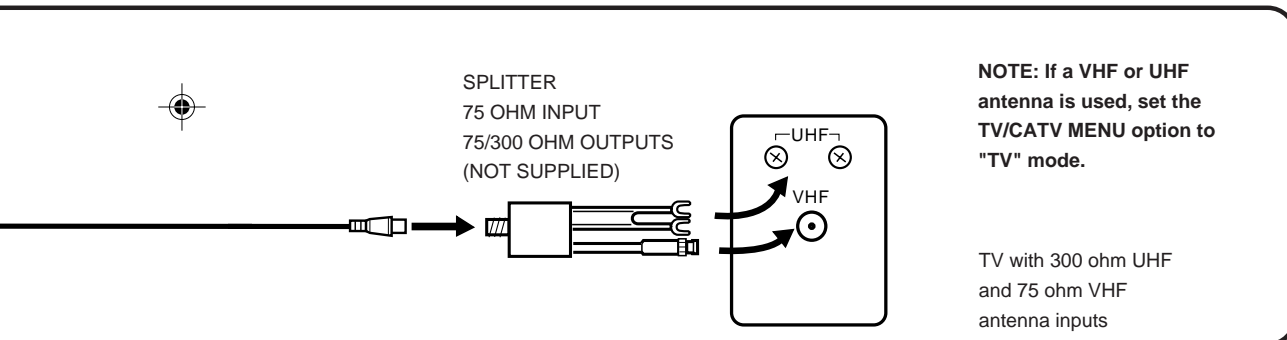
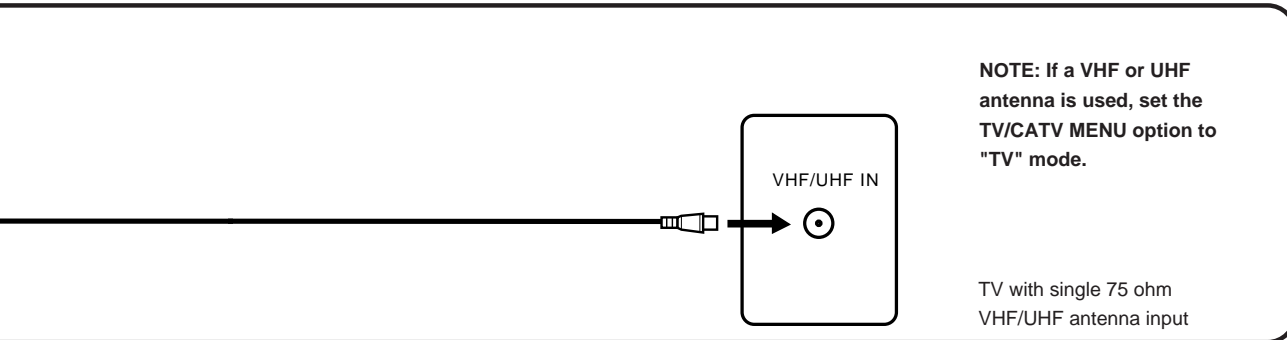



CATV (CABLE TV) CONNECTIONS

Many cable companies offer services permitting reception of extra channels including pay or subscription channels. This VCR has an extended tuning range and can be tuned to most cable channels without using a cable company supplied converter box, except for those channels which are intentionally scrambled. If you subscribe to a special channel which is scrambled, you must have a descrambler box for proper reception.

- 1** IMPORTANT: Make sure the TV/CATV MENU option is set to "CATV" mode.

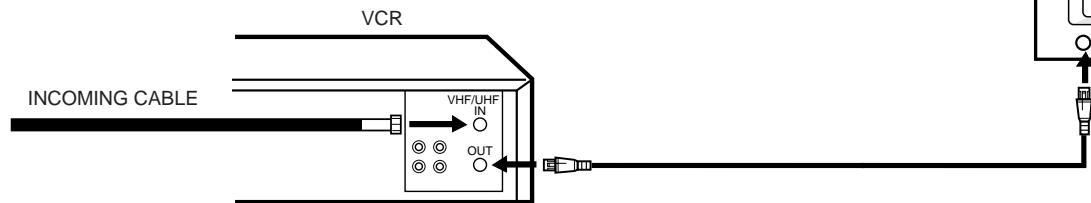

- 2** IMPORTANT: Make sure the TV/CATV MENU option is set to "CATV" mode.

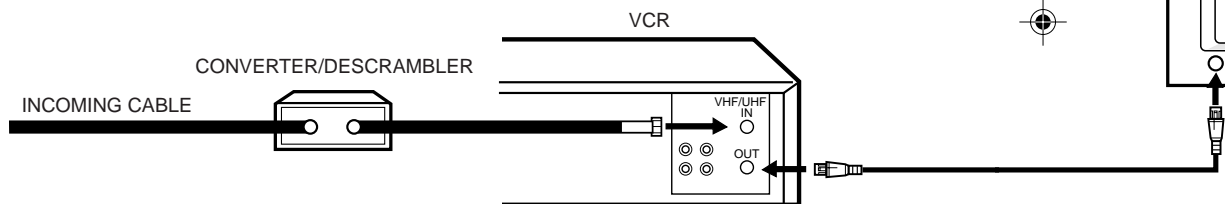

- 3** IMPORTANT: Make sure the TV/CATV MENU option is set to "CATV" mode.

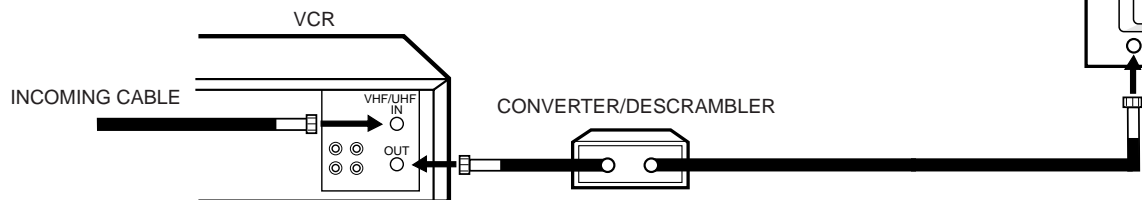

NOTE: WHENEVER A CONVERTER/DESCRAMBLER BOX IS PLACED BEFORE THE VCR, YOU MUST TUNE THE VCR TO THE OUTPUT OF THE CONVERTER/DESCRAMBLER BOX, USUALLY CHANNEL 3 OR 4.





This VCR cannot receive scrambled programs since it does not contain a descrambler. In order to receive scrambled programs, your existing descrambler must be used. Descrambler boxes are available from cable companies. Consult your local cable company for more information concerning connection to their descrambler equipment. There are many ways to connect your VCR to a cable system. Below are six common methods of connection.

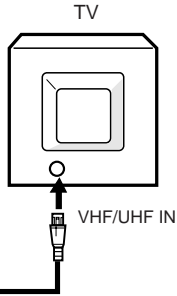

For basic cable service, no premium (scrambled) channels.

ALLOWS:

- * Recording of nonscrambled channels.
- * Use of the programmable timer.
- * Recording of one channel while watching another.

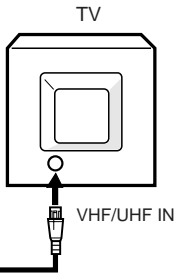

ALLOWS:

- * Recording of channels through the converter box (scrambled and unscrambled).
- * Using the programmable timer to record only the channel selected at the converter box.

PREVENTS:

- * Recording one channel while watching another.
- * Using the VCR tuner to select channels.

NOTE:

To record from converter/descrambler, VCR tuner must be tuned to the converter output channel, usually channel 3 or 4.

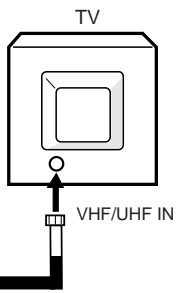

ALLOWS:

- * Recording of unscrambled channels
- * Using the programmable timer.
- * Recording an unscrambled channel while watching any channel selected at the converter box.

PREVENTS:

- * Recording scrambled channels.

NOTE:

If you are playing a tape or using the tuner built into the VCR, the converter must be set to the video channel output of the VCR (either 3 or 4).





CATV (CABLE TV) CONNECTIONS

(CONTINUED)

1

IMPORTANT: Make sure the TV/CATV MENU option is set to "CATV" mode.

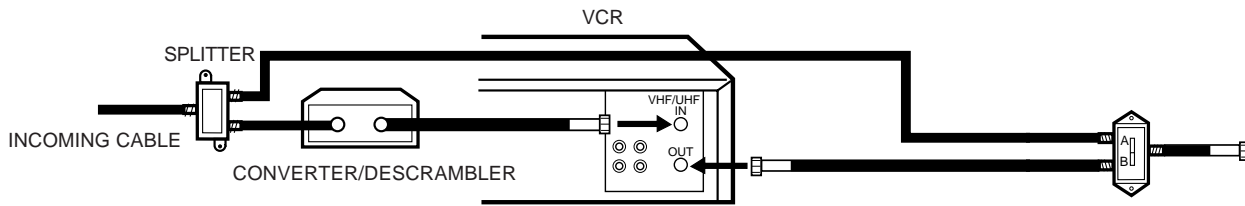

2

IMPORTANT: Make sure the TV/CATV MENU option is set to "CATV" mode.

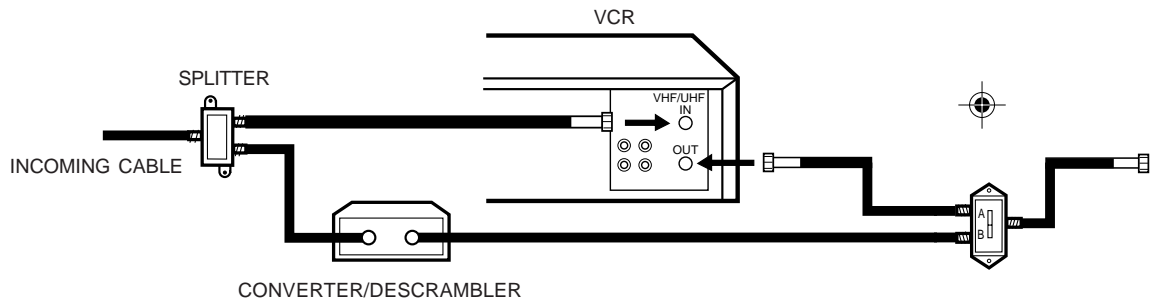

3

IMPORTANT: Make sure the TV/CATV MENU option is set to "CATV" mode.

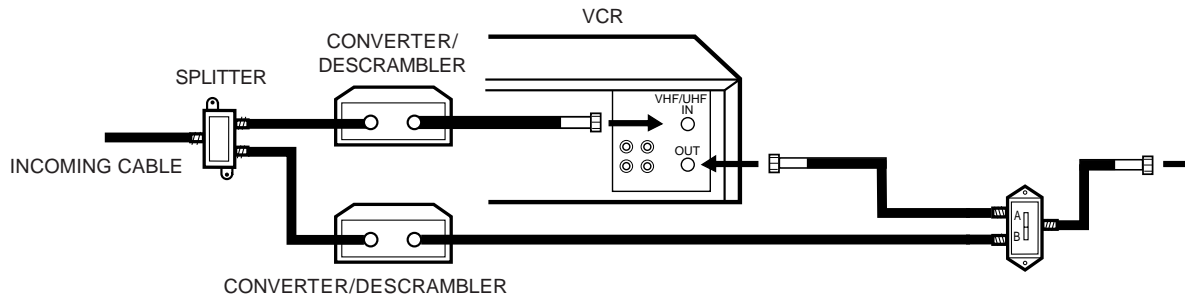

NOTE: WHENEVER A CONVERTER/DESCRAMBLER BOX IS PLACED BEFORE THE VCR, YOU MUST TUNE THE VCR TO THE OUTPUT OF THE CONVERTER/DESCRAMBLER BOX, USUALLY CHANNEL 3 OR 4.



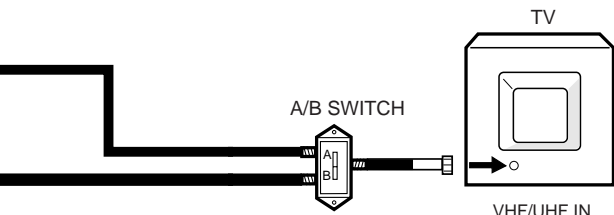

ALLOWS:

- * Recording of all channels through the converter box.
- * Recording of one channel while watching another.
- * Using the programmable timer to record only the channel selected at the converter box.

PREVENTS:

- * Watching scrambled channels while recording another channel.
- * Using the VCR tuner to select channels.

NOTE:

To record from converter/descrambler, VCR tuner must be tuned to the converter output channel, usually channel 3 or 4.

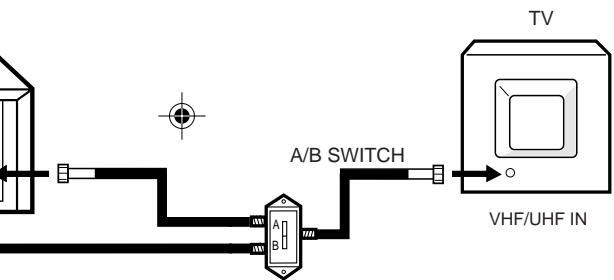

ALLOWS:

- * Recording of nonscrambled channels.
- * Recording of one channel while watching another.
- * Watching premium channels through the converter while recording nonscrambled channels.
- * Using the programmable timer.

PREVENTS:

- * Recording scrambled channels.

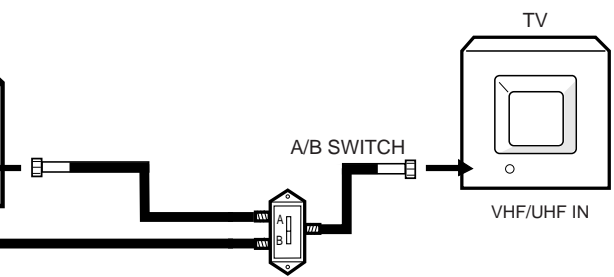

ALLOWS:

- * Recording of all channels through the converter box.
- * Recording a scrambled or unscrambled channel while watching another (scrambled or unscrambled) channel.
- * Using the programmable timer to record only the channel selected at the converter box.

PREVENTS:

- * Using the VCR tuner to select channels.

NOTE:

To record from converter/descrambler, VCR tuner must be tuned to the converter output channel, usually channel 3 or 4.

YOU MUST TUNE CHANNEL 3 OR 4.





AUDIO/VIDEO CONNECTIONS

If your TV has AUDIO IN and VIDEO IN jacks, you can connect your VCR to them to receive a higher quality picture and sound. If you have a stereo, you can connect a stereo amplifier to enjoy powerful sound.

AUDIO/VIDEO CONNECTION

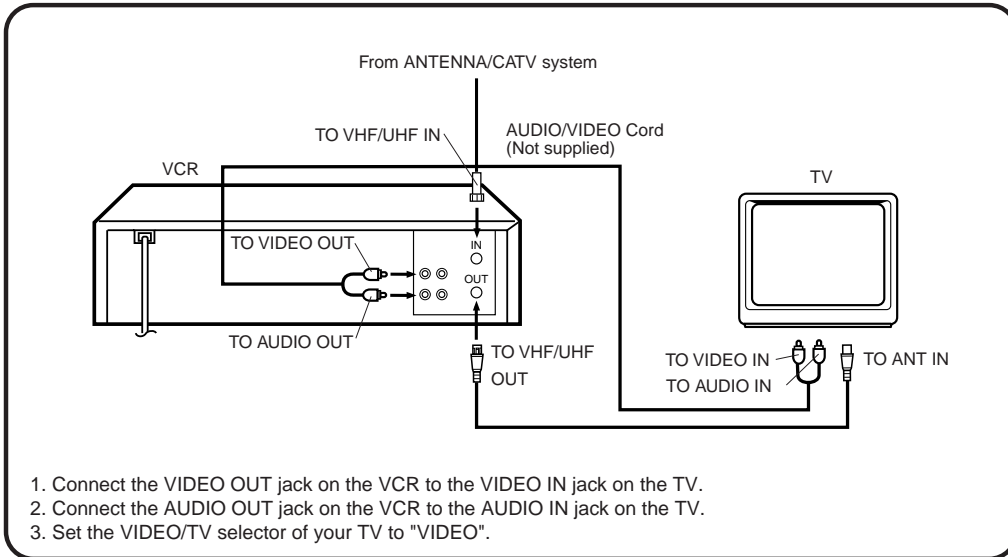

STEREO AMPLIFIER CONNECTIONS

When you connect your VCR to a Stereo Component System, you can view the picture from the VCR while enjoying powerful sound from your audio system.

NOTE: Sound will be monaural.

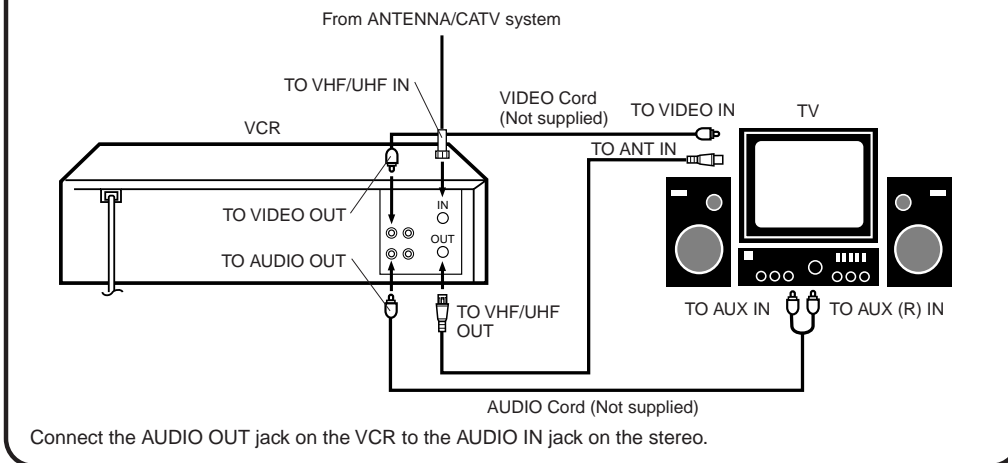





SETTING THE VIDEO CHANNEL

To view playback of a recorded tape, or to watch a program selected by the VCR's channel selector, the TV must be set to channel 3 or 4 (video channel).

When a TV is connected with an antenna cable only.

<p>1 Turn ON the VCR POWER button.</p> 	<p>2 Set the 3/4 Channel selector switch (Rear of the VCR) to CH 3 or 4.</p> 	<p>3 Turn ON the TV and set to CH 3 or 4 to correspond with the channel selected in 2.</p> 
---	---	--

ENGLISH

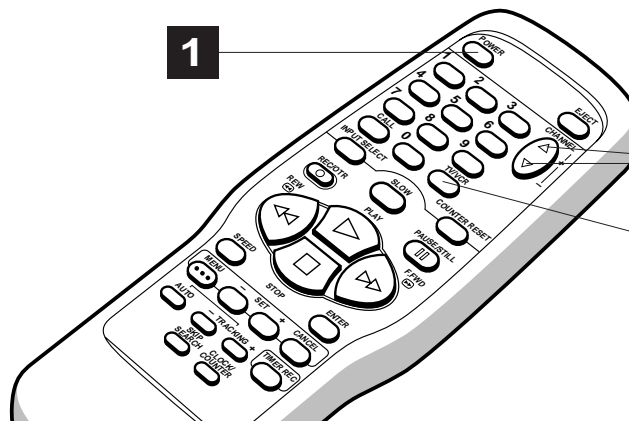

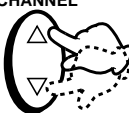
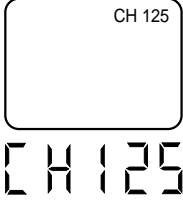
<p>4 Press the TV/VCR selector button to select the VCR position.</p>  <p>VCR</p> <p>The VCR indicator will light in the display.</p>	<p>5 Select any channel to receive a TV station in your area.</p>   <p>The channel number will appear on the screen and display about 4 seconds.</p>
--	--

For a push-button TV tuner

If CH 3 or 4 corresponding to the video channel cannot be tuned on your TV, proceed as follows: set the VCR 3/4 channel selector and the TV to CH 3 or 4, play back a prerecorded tape and tune the TV to receive a sharp color picture from the video cassette recorder. Refer to your TV owner's manual for details.





ON-SCREEN LANGUAGE SELECTION

This VCR can display on the TV screen in the English, Spanish or French languages.

CHECK BEFORE YOU BEGIN

- Turn ON the TV and set to the video channel 3 or 4.
- Turn ON the VCR POWER button.
- Press the TV/VCR selector button to select the VCR mode.

When a TV is connected with an audio/video cable, turn the TV and this VCR on and select the video input mode on the TV.

1 Press the MENU button. Press the SET + or – button to select the SYSTEM SET UP option, then press the ENTER button.

MENU

■ TIMER REC SET

■ CH SET UP

▲ AUTO REPEAT ON OFF

■ SYSTEM SET UP

■ NO NOISE BACKGROUND ON OFF

(+/-)ENTER/MENU

2 Press the SET + or – button to select the LANGUAGE option, then press the ENTER button.

SYSTEM SET UP

■ CLOCK SET

■ LANGUAGE/LENGUA/LANGUE

(+/-)ENTER/MENU

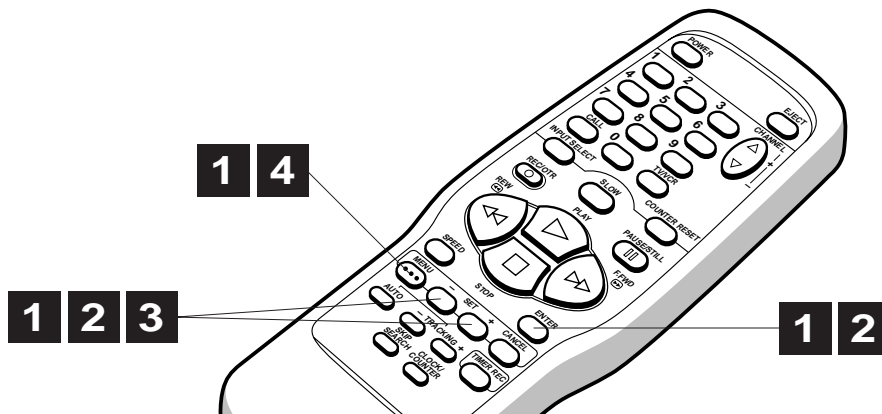

3 Press the SET + or – button to select the desired language: ENGLISH, ESPAÑOL or FRANCAIS.

LANGUAGE/IDIOMA/LANGUE

► ENGLISH

ESPAÑOL

FRANCAIS

(+/-)ENTER/MENU

4 Press the MENU button three times.





SETTING THE CLOCK

EXAMPLE: Setting the clock to "8:30 AM" October, 23 (SAT), 1999.

CHECK BEFORE YOU BEGIN

- Turn ON the TV and set to the video channel 3 or 4.
- Turn ON the VCR POWER button.
- Press the TV/VCR selector button to select the VCR mode.

When a TV is connected with an audio/video cable, turn the TV and this VCR on, and select the video input mode on the TV.

1 Press the MENU button.



2 Press the SET + or – button to select the CLOCK SET option, then press the ENTER button.



SYSTEM SET UP

CLOCK SET

LANGUAGE/LENGUA/LANGUE

(+/-)ENTER/MENU

ENGLISH

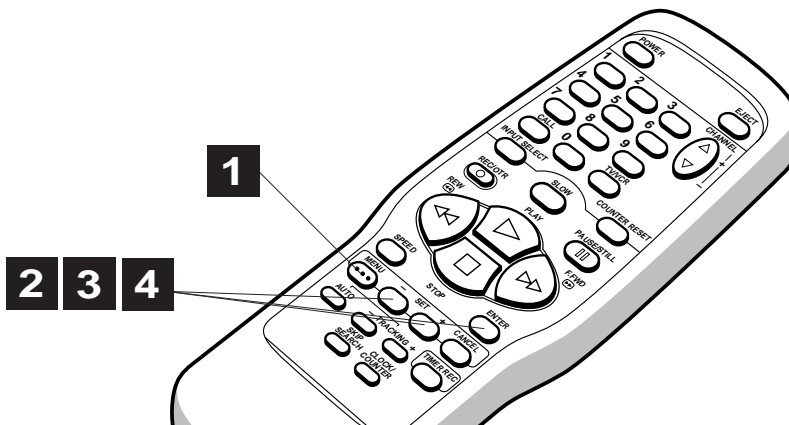

3 Press the SET + or – button to set the month, then press the ENTER button.

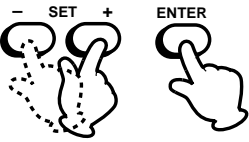

MONTH 10

DAY 1 (SUN)

YEAR 2000

TIME 12 : 00 AM

(+/-)ENTER/CANCEL/MENU

4 Set the day, year and time as in Step 3.

- The day of the week will automatically appear when you set the year.
- Press and hold down the button to increase/decrease the minute by 10.
- Auto date and time start functioning when you finish setting.

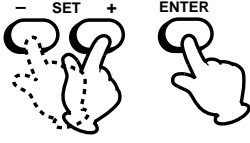

MONTH 10

DAY 23 (SAT)

YEAR 1999

TIME 8 : 30 AM

(+/-)ENTER/CANCEL/MENU

NOTES:

- After a power failure or disconnection of the power, the timer will be lost. In this case, reset the present time.
- Press the CANCEL button to move cursor backward for correction.
- If you want to correct time or date while the clock is functioning, press the MENU button, then press SET + or – button to select the SYSTEM SET UP option, then press the ENTER button. To make any adjustments perform steps 2 through 4.



SETTING THE CHANNELS

This VCR is equipped with a channel memory feature which allows channels to skip up or down to the next channel set into memory, skipping over unwanted channels. Before selecting channels, they must be programmed into the VCR's memory. In addition to normal VHF and UHF channels, this VCR can receive up to 113 Cable TV channels. To use this VCR with an antenna, set the TV/CATV menu option to the TV mode. When shipped from the factory, this menu option is in the CATV mode.

TV/CATV SELECTION

1 Press the MENU button.



2 Press the SET + or – button to select the CH SET UP option, then press the ENTER button.

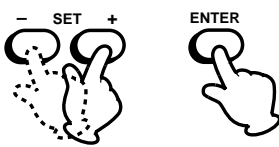

MENU

- ▶ TIMER REC SET
- ▶ CH SET UP
- ▶ AUTO REPEAT ON ▶ OFF
- ▶ SYSTEM SET UP
- ▶ NO NOISE BACKGROUND
- ▶ ON OFF

(+/-)ENTER/MENU

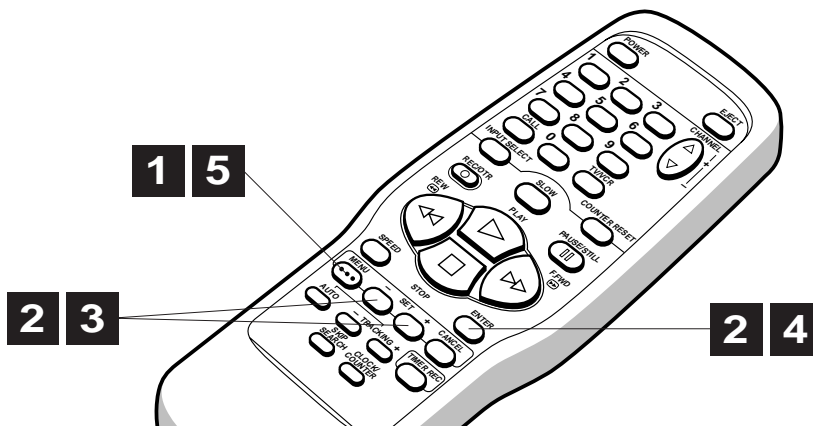

3 Press the SET + or – button to select the TV/CATV mode.

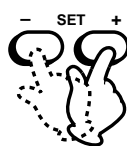

CH SET UP

- ▶ TV ▶ CATV
- ▶ AUTO CH MEMORY
- ▶ ADD/DELETE

(+/-)ENTER/MENU

4 Press the ENTER button to select the TV or CATV mode. The arrow indicates the selected mode.



TV - VHF/UHF channels
CATV - Cable TV channels

5 Press the MENU button twice to return to normal TV viewing.





Your VCR can receive a maximum of 181 channels by presetting the channels into memory.

AUTOMATIC MEMORY TUNING

ENGLISH

CHECK BEFORE YOU BEGIN

- Turn ON the TV and set to the video channel 3 or 4.
- Turn ON the VCR POWER button.
- Press the TV/VCR selector button to select the VCR mode.

When a TV is connected with an audio/video cable, turn the TV and this VCR on, and select the video input mode on the TV.

1

Press the MENU button.

Press the SET + or – button to select the CH SET UP option, then press the ENTER button.

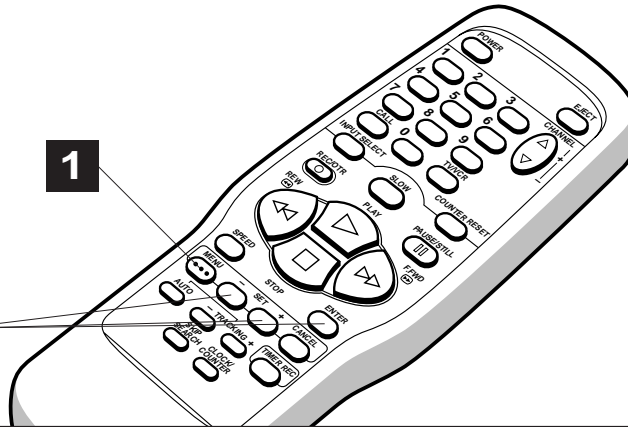
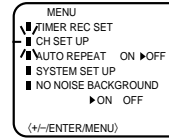

2

Press the SET + or – button to select the AUTO CH MEMORY mode, then press the ENTER button.

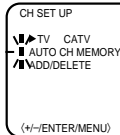
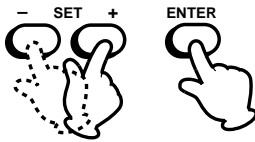

3

The auto tuning will start. The channel display will count up and when finished, the screen returns to normal.

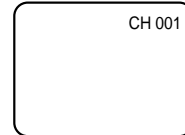

SETTING THE CHANNELS

(CONTINUED)

TO ADD/DELETE CHANNELS

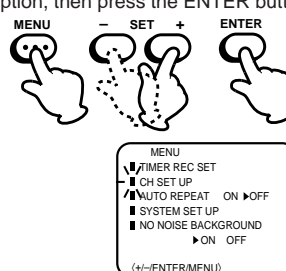
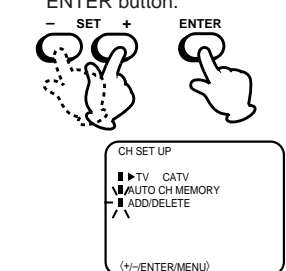
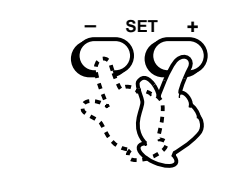
<p>1 Press the MENU button. Press the SET + or – button to select the CH SET UP option, then press the ENTER button.</p>  <p>MENU - SET + ENTER</p> <p>MENU [] TIMER REC SET [] CH SET UP [] AUTO REPEAT ON ▶ OFF [] SYSTEM SET UP [] NO NOISE BACKGROUND ON OFF (+/-)ENTER/MENU)</p>	<p>2 Press the SET + or – button to select the ADD/DELETE mode, then press the ENTER button.</p>  <p>- SET + ENTER</p> <p>CH SET UP [] TV CATV [] AUTO CH MEMORY [] ADD/DELETE (+/-)ENTER/MENU)</p>	<p>3 Select the desired channels to be memorized or deleted using the SET + or – button.</p>  <p>- SET +</p>
---	---	--

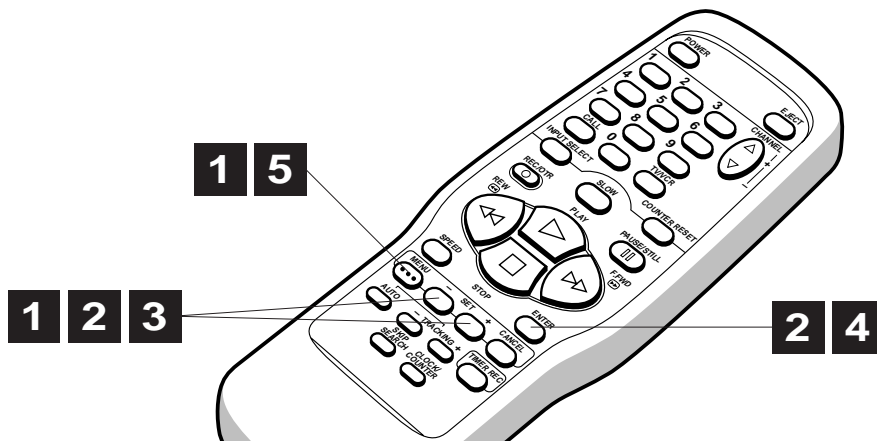

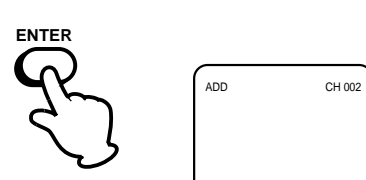
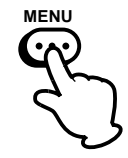
<p>4 Press the ENTER button if you wish to DELETE the channel from memory. Press the ENTER button if you wish to ADD the unmemorized channel. Repeat Steps 3 and 4 for each channel to be added or deleted.</p>  <p>ENTER</p> <p>ADD CH 002 (+/-)ENTER/MENU)</p>	<p>5 Press the MENU button three times after adding or deleting all of the desired channels, to return to normal TV viewing.</p>  <p>MENU</p>
--	--



NOISE ELIMINATION (BLUE SCREEN)

When you don't want to receive a weak signal broadcast, the Blue back screen can be obtained by selecting the NO NOISE BACKGROUND "ON". When the unit is shipped from the factory, the NO NOISE BACKGROUND is set to the "ON".

ENGLISH

CHECK BEFORE YOU BEGIN

- Turn ON the TV and set to the video channel 3 or 4.
- Turn ON the VCR POWER button.
- Press the TV/VCR selector button to select the VCR mode.

When a TV is connected with an audio/video cable, turn the TV and this VCR on and select the video input mode on the TV.

1

Press the MENU button, then press the SET + or - button to select the NO NOISE BACKGROUND option.

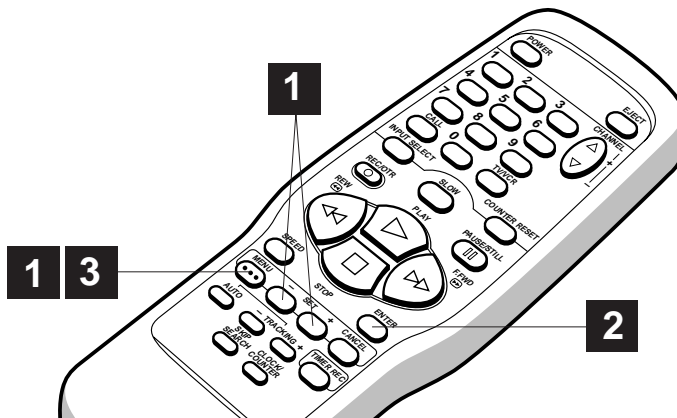
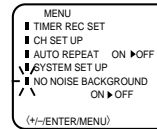

2

Press the ENTER button to select the ON position.

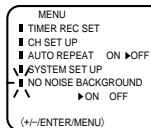

3

Press the MENU button again.





LOADING AND UNLOADING VIDEO CASSETTE TAPES

Use only video cassette tapes marked **VHS**.

LOADING

Push the center of the tape until it is automatically retracted.

AUTOMATIC POWER ON

The VCR will turn on automatically and the POWER indicator will light.

AUTOMATIC PLAY

When loading a cassette tape without the erase prevention tab, playback will start immediately.

Insert the cassette with its labeled side facing you. An inverted cassette cannot be inserted.

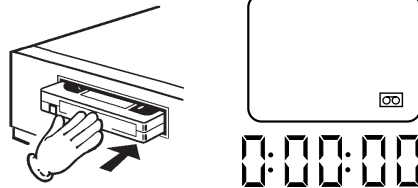
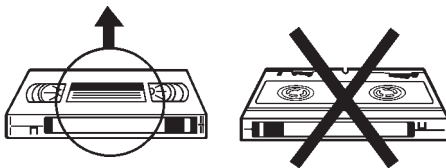

The clock display will change in the counter display.

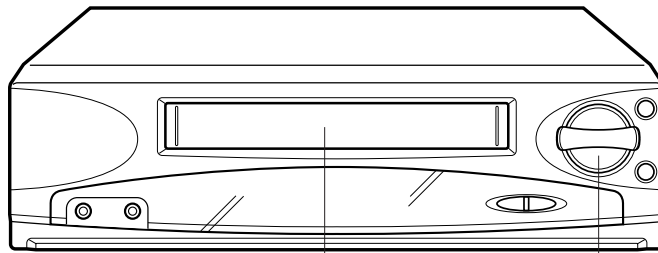

2

1

UNLOADING

1

To unload a cassette, press the EJECT button on the remote control, or press the STOP/EJECT button on the VCR twice. The first press will stop the tape in any mode. The second press will eject the tape. The "▲" will appear on the screen. The EJECT indicator will light in the display.

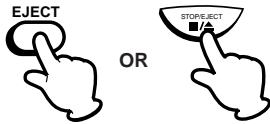

AUTOMATIC EJECT

If the VCR automatically rewinds the tape to the beginning (AUTO REWIND FEATURE), the tape will be ejected automatically (See the NOTE on page 37).

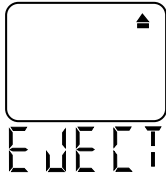

2

Pull the cassette out.

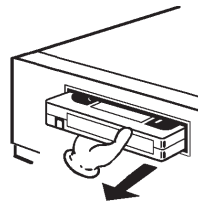

The counter display will change to the clock display.

- NOTES:**
- Always eject the tape when not in use.
 - The cassette can be ejected even if the POWER switch is "OFF".





PLAYBACK

To play a prerecorded cassette tape

TO START PLAYBACK

CHECK BEFORE YOU BEGIN

Turn ON the TV and set to the video channel 3 or 4.

When a TV is connected with an audio/video cable, turn the TV and this VCR on and select the video input mode on the TV.

1

Load a prerecorded tape (When loading a cassette tape without the erase prevention tab, playback will start automatically).

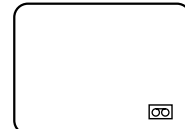
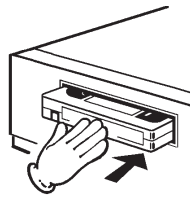

0:00:00

The clock display will change in the counter display.

ENGLISH

2

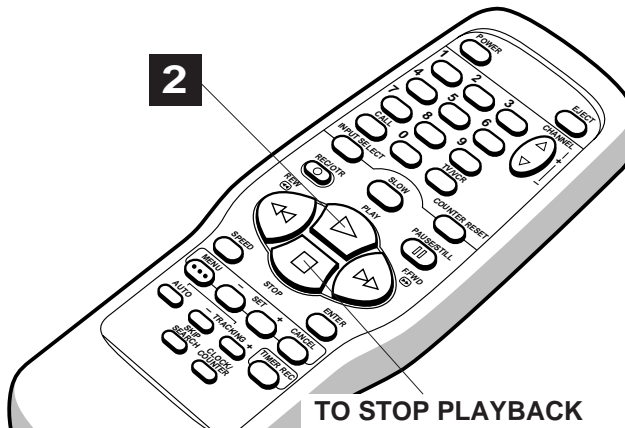

TO STOP PLAYBACK

2

Press the PLAY button. Playback will start.

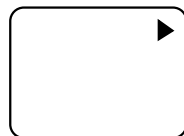

PLAY

The "▶" will appear on the screen about 4 seconds.
The Play indicator will light in the display about 4 seconds.

Press the STOP button once. The tape will stop but remain fully loaded and ready to play.



STOP

The "■" will appear on the screen about 4 seconds.
The STOP indicator will light in the display about 4 seconds.





PLAYBACK

(CONTINUED)

TO REWIND OR FORWARD THE TAPE RAPIDLY

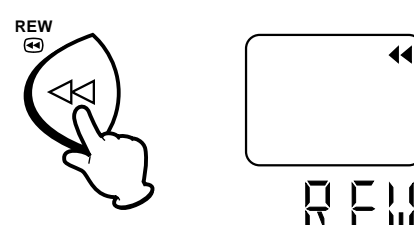
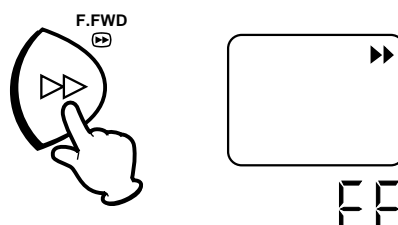
<p>Press the REW button in the STOP mode.</p>  <p>The "◀◀" will appear on the screen about 4 seconds. The REW indicator will light in the display about 4 seconds.</p>	<p>Press the F.FWD button in the STOP mode.</p>  <p>The "▶▶" will appear on the screen about 4 seconds. The F.FWD indicator will light in the display about 4 seconds.</p>
---	--

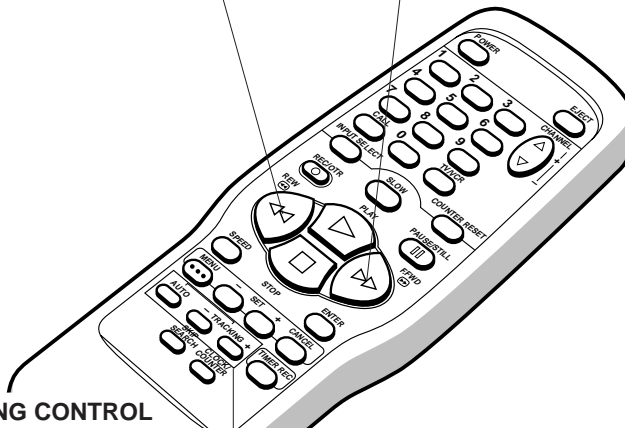

DIGITAL TRACKING CONTROL

When a tape is played, the Digital Auto Tracking System automatically adjusts the tracking to obtain the best possible picture. If noise bars appear during playback, adjust the tracking manually:

- Press the Manual TRACKING + or – button to obtain the best possible picture. To resume automatic tracking, press the AUTO Tracking button.

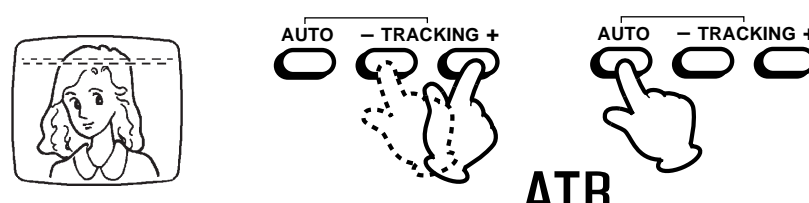

FORWARD/REVERSE PICTURE SEARCH

If you want to see the tape program during REW (F.FWD) mode, press and hold the REW (F.FWD) button again. The backward (forward) visual search picture will be seen on the screen. Release to return to the REW (F.FWD) mode.





SPECIAL PLAYBACK

TO VISUALLY SEARCH FOR DESIRED POINTS

When either the F.FWD or REW button is pressed in the PLAYBACK mode, the speed search picture will appear. When pressed twice, the search picture will increase speed. Speed search time depends upon the speed used (SP, LP or SLP) during recording. To rewind or fast forward a tape, press the STOP button, and then press the REW or F.FWD button.

To visually search backward, press the REW button once or twice in the PLAYBACK mode.

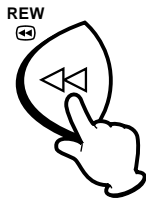

REVIEW

The REVIEW indicator will light in the display about 4 seconds. Press the PLAY button to resume normal viewing speed.

To visually search forward, press the F.FWD button once or twice in the PLAYBACK mode.



CUE

The CUE indicator will light in the display about 4 seconds. Press the PLAY button to resume normal viewing speed.

ENGLISH

SKIP SEARCH

Press the SKIP SEARCH button in the PLAY mode. The VCR will search forward through approximately 60 seconds of the tape (e.g. unwanted commercial time) and then resume normal playback.



CUE 1

The CUE 1 indicator will light in the display. (For example : 1 press).

TO WATCH A STILL PICTURE

Press the PAUSE/STILL button in the PLAYBACK mode.

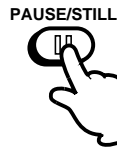

STILL

The STILL indicator will light in the display about 4 seconds. Press the PAUSE/STILL button again to resume normal playback.

SLOW MOTION PLAYBACK

Press the SLOW button in the PLAYBACK mode. Playback will proceed at 1/10th of the normal speed.



SLOW

The SLOW indicator will light in the display about 4 seconds. Press the PLAY button again to resume normal playback.

NOTE: SLOW TRACKING AND VERTICAL LOCK ADJUSTMENT

If noise bars appear in the picture during slow motion, press the Manual TRACKING + or - button to reduce the noise bars. If the still picture jitters excessively, press the Manual TRACKING + or - button to stabilize the still picture.

FRAME BY FRAME ADVANCE

Press the SLOW button during STILL playback.



STILL

The still picture will advance by one frame each time you press the button. Hold the button for continuous frame by frame viewing. Press the PAUSE/STILL button again to resume normal playback.

- NOTES:**
- Best results during speed search playback can be obtained with cassette tapes recorded in the "SP" and "SLP" mode.
 - The audio output is muted during SPEED SEARCH and STILL.
 - A few noise bars will appear on the picture during SPEED SEARCH, STILL, FRAME ADVANCE and SLOW MOTION.
 - To prevent damage to the tape, CUE, REVIEW and STILL playback is automatically changed to the PLAYBACK mode after 5 minutes.





SPECIAL PLAYBACK

(CONTINUED)

TO WATCH A TAPE REPEATEDLY

CHECK BEFORE YOU BEGIN

- Turn ON the TV and set to the video channel 3 or 4.
- Turn ON the VCR POWER button.
- Press the TV/VCR selector button to select the VCR mode.

When a TV is connected with an audio/video cable, turn the TV and this VCR on, and select the video input mode on the TV.

1

Press the MENU button.
Press the SET + or - button to select the AUTO REPEAT option.

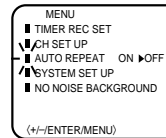
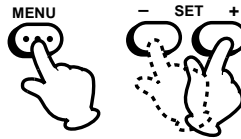

(+/-)ENTER/MENU

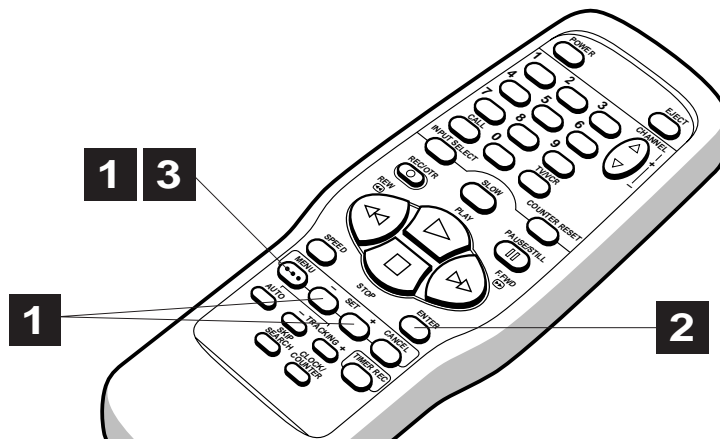

2

Press the ENTER button to select the ON position.

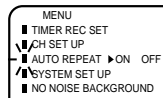

(+/-)ENTER/MENU

3

Press the MENU button.
If you press the PLAY button, the tape will play over and over until the repeat mode is canceled.



"" will appear if you press the CALL button.
To cancel, press the CALL button again.

NOTE: To cancel repeat mode, follow the above steps 1 and 2, then press the ENTER button to select the OFF position. Press the MENU button to return to the TV.

34





RECORDING A TV PROGRAM

RECORDING AND VIEWING THE SAME TV PROGRAM

ENGLISH

CHECK BEFORE YOU BEGIN

- Turn ON the TV and set to the video channel 3 or 4.
- Turn ON the VCR POWER button.
- Press the TV/VCR selector button to select the VCR mode.

When a TV is connected with an audio/video cable, turn the TV and this VCR on and select the video input mode on the TV.

- 1** Load a cassette tape with the erase prevention tab intact.
The VCR will automatically turn on.

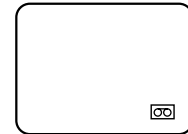
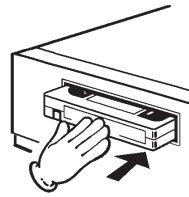

The clock display will change in the counter display.

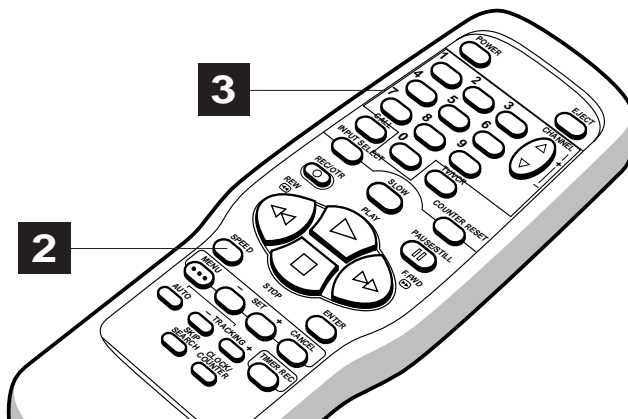

VHF/UHF/CATV CHANNELS

TV	CATV
VHF 2-13	VHF 2-13
UHF 14-69	STD/HRC/IRC 14-36 (A) (W) 37-59 (AA) (WW) 60-85 (AAA) (ZZZ) 86-94 (86) (94) 95-99 (A-5) (A-1) 100-125 (100)(125) 01 (5A)

- 2** Press the SPEED selector button to select the desired tape speed SP, LP or SLP.

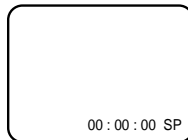

The counter and SP, LP or SLP will appear on the screen about 4 seconds.

- 3** Press the direct channel selection buttons or the CHANNEL ▲ or ▼ button to select the channel to be recorded.

- 1-9 Press 0 twice and then 1-9 as required. (Example; to select 2, press 002.)
- 10-19 Press 0 first and then the remaining 2 digits in order from left to right. (Example; press 018 for 18.)
- 20-99 Press 2 digits in order. (Example; press 22 for 22.)
- 100-125 Press the 3 digits in order. (Example; press 110 for 110.)

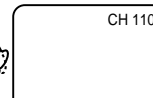
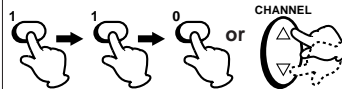

NOTE: Since the VCR has its own TV tuner, it is not actually necessary to have the TV turned on in order to make a recording. Turning on the TV merely allows confirmation of the proper channel settings on your VCR.





RECORDING A TV PROGRAM

(CONTINUED)

TO STOP RECORDING

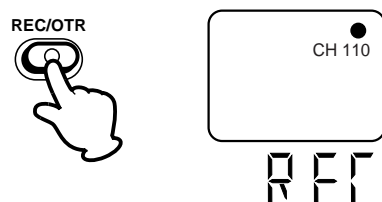
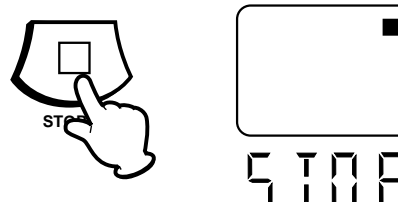
<p>4 Press the REC/OTR button.</p>  <p>"●" will appear on the screen about 4 seconds. The REC indicator will light in the display about 4 seconds.</p>	<p>Press the STOP button to stop recording.</p>  <p>"■" will appear on screen about 4 seconds. The STOP indicator will light in the display about 4 seconds.</p>
--	--

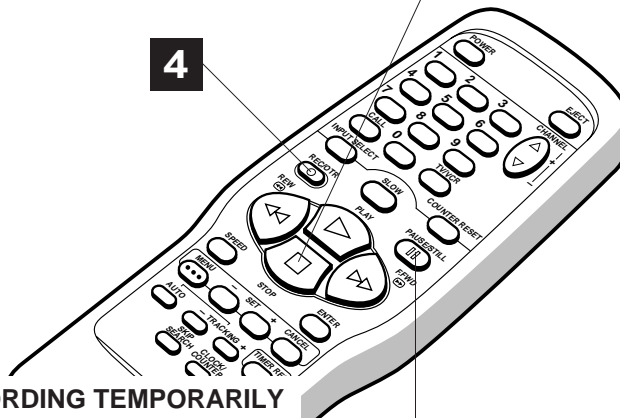

TO STOP RECORDING TEMPORARILY

Press the PAUSE/STILL button to avoid recording unwanted material. Press again to continue the recording.



"||" will appear on screen about 4 seconds and the REC indicator will light in the display to continue pause mode.
NOTE: The pause function will be released after 5 minutes to prevent damage to the tape or the VCR. The VCR will change to the STOP mode.

NOTE: AUTO REWIND FEATURE

This VCR will automatically rewind the tape when the tape has ended (except during OTR and TIMER REC). It will also eject the tape and turn the VCR's power OFF.





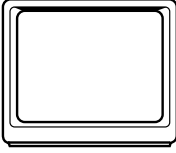

RECORDING ONE PROGRAM WHILE WATCHING ANOTHER

<p>1 While the VCR is recording, press the TV/VCR selector button to select the TV position. The TV/VCR indicator will go off and recording will continue.</p> 	<p>2 Select the TV channel you want to watch by using the TV channel selector.</p> 
---	--

NOTE: Some CATV hookups do not permit viewing one channel while recording another. See pages 18-21.

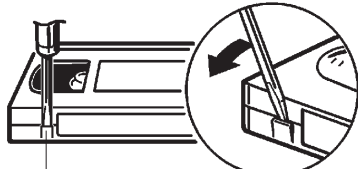
TO PREVENT AN ACCIDENTAL RECORDING TO RECORD AGAIN

<p>After recording, break off the erase prevention tab if you do not wish to record over the tape.</p>  <p>Erase prevention tab</p>	<p>Cover the hole with adhesive tape. Be careful the tape does not extend past the edges of the cassette housing.</p>  <p>Adhesive tape</p>
--	---

TAPE SPEED AND MAXIMUM RECORDING/PLAYBACK TIME

TAPE SPEED	VIDEO CASSETTE TAPE					
	T-210	T-160	T-120	T-90	T-60	T-30
SP (Standard Play)	3-1/2 hours	2-2/3 hours	2 hours	1-1/2 hours	1 hour	30 minutes
LP (Long Play)	7 hours	5-1/3 hours	4 hours	3 hours	2 hours	1 hour
SLP (Super Long Play)	10-1/2 hours	8 hours	6 hours	4-1/2 hours	3 hours	1-1/2 hours





SETTING THE TIMER RECORDING

Timer recording can be programmed on-screen with the remote control. The built-in timer allows automatic unattended recording of up to 8 programs within 1 month.

EXAMPLE: Program a timer recording for the 26th day, channel 125 (CATV), 11:00 - 11:30 PM on timer program number 1. (Tape speed: SLP)

CHECK BEFORE YOU BEGIN

- Turn on the TV and set to the video channel 3 or 4.
- Press the TV/VCR selector button to select the VCR mode.
- Load a video cassette with the erase prevention tab intact. The VCR will automatically turn on.
- Check that the clock and date are correct (see page 25).

When a TV is connected with an audio/video cable, turn the TV and this VCR on and select the video input mode on the TV.

- 1 Press the MENU button. Check the TIMER REC SET option is selected, then press the ENTER button.

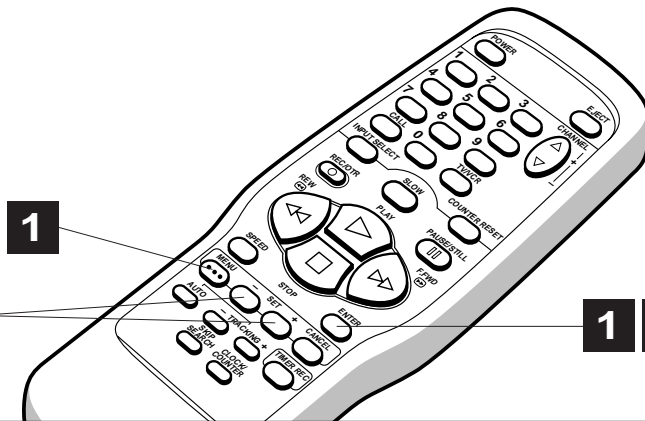
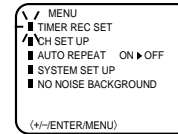
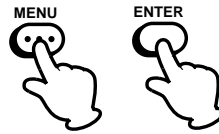

- 2 Press the SET + or - button to select the one of the program line, then press the ENTER button.

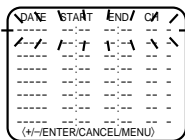
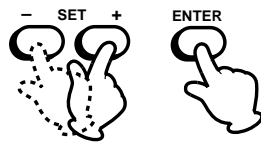

- 3 Press the SET + or - button to select the date, then press the ENTER button.

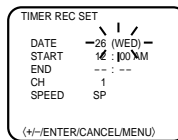
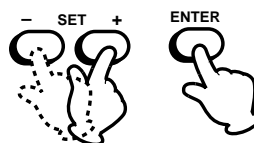

NOTE: To set the timer for other programs, press the MENU button. Check that the TIMER REC SET option is selected, then press the ENTER button. Press the SET + or - button until the next program blinks, then press the ENTER button. Repeat steps 3 to 4 to set the second program.





4 Set the start time, end time, channel and tape speed as in step 3.

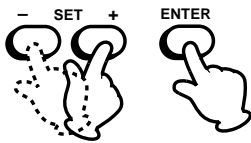

TIMER REC SET	
DATE	26 (WED)
START	11 : 00 PM
END	11 : 30 PM
CH	29
SPEED	SLP

(+)=ENTER/CANCEL/MENU

5 Press the ENTER button to accept them. To enter other programmes, repeat step 2 through 4. Or, press the MENU button twice to return to the normal screen.

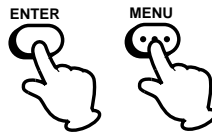

DATE	START	END	CH
26 (WE)	11:00PM	11:30PM	25 SLP
---	---	---	---
---	---	---	---
---	---	---	---
---	---	---	---
---	---	---	---
---	---	---	---
---	---	---	---
---	---	---	---
---	---	---	---

(+)=ENTER/CANCEL/MENU

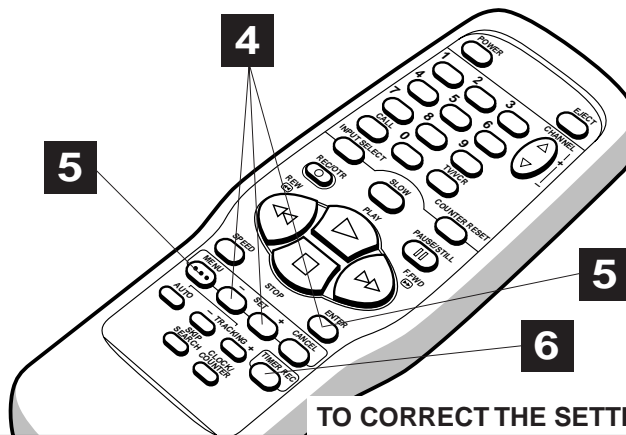

6 Press the TIMER REC button. The power will go off, the Timer Record indicator will light and the VCR stands by for recording.



To cancel timer recording, press the button again and the Timer Record indicator will go out.

TO CORRECT THE SETTINGS

While setting, press the ENTER button to flash the item to correct, then re-enter the setting with the SET + or - button. When finished, press the ENTER button.

- NOTES:**
- The VCR cannot be used while the Timer Record indicator is lit.
 - After a power failure or disconnection of the power plug, all programmed recording settings must be reset upon resumption of power. In this case, reset the clock (see page 25) and reprogram any timer recordings.
 - Press the CANCEL button to move cursor backward for correction.
 - To record from external source set the channel to "L1" or "L2". "L1" and "L2" will appear next to CH 125 (or 69).



Free Manuals Download Website

<http://myh66.com>

<http://usermanuals.us>

<http://www.somanuals.com>

<http://www.4manuals.cc>

<http://www.manual-lib.com>

<http://www.404manual.com>

<http://www.luxmanual.com>

<http://aubethermostatmanual.com>

Golf course search by state

<http://golfingnear.com>

Email search by domain

<http://emailbydomain.com>

Auto manuals search

<http://auto.somanuals.com>

TV manuals search

<http://tv.somanuals.com>