

E 320

E 500

Our company and staff congratulate you on the purchase of your new Mercedes-Benz.

Your selection of our product is a demonstration of your trust in our company name. Further, it exemplifies your desire to own an automobile that will be as easy as possible to operate and provide years of service.

Your Mercedes-Benz represents the efforts of many skilled engineers and craftsmen. To help assure your driving pleasure, and also the safety of you and your passengers, we ask you to make a small investment of time:

- Please read this manual carefully before putting it aside. Then return it to your vehicle where it will be handy for your reference.
- Please follow the recommendations contained in this manual. They are designed to acquaint you with the operation of your Mercedes-Benz.
- Please pay attention to the warnings and cautions contained in this manual. They are designed to help improve the safety of the vehicle operator and occupants.

We extend our best wishes for many miles of safe, pleasurable driving.

Mercedes-Benz USA, LLC
A DaimlerChrysler Company

Contents

Introduction	9	At a glance	19	Problems while driving.....	48
Product information.....	9	Cockpit.....	20	Parking and locking.....	50
Operator's Manual.....	10	Instrument cluster	22	Parking brake	50
Service and warranty information ..	10	Multifunction steering wheel	24	Switching off headlamps.....	51
Important notice for California		Center console	25	Turning off the engine.....	51
retail buyers and lessees of		Upper part	25		
Mercedes-Benz automobiles	11	Lower part	26		
Maintenance	12	Overhead control panel	27	Safety and Security	55
Roadside Assistance	12	Door control panel.....	28	Occupant safety	56
Change of address or ownership....	12			Airbags	57
Operating your vehicle outside				Seat belts	61
the USA or Canada.....	13	Getting started	29	Children in the vehicle	65
Where to find it.....	14	Unlocking	30	Blocking of rear door window	
Symbols.....	15	Unlocking with the SmartKey.....	30	operation	71
Operating safety	16	Unlocking with KEYLESS-GO*	32	Panic alarm	72
Proper use of the vehicle	16	Adjusting	34	Activating.....	72
Problems with your vehicle.....	17	Seats.....	34	Deactivating.....	72
Reporting safety defects.....	18	Steering wheel.....	37	Driving safety systems	73
Reporting safety defects	18	Mirrors.....	38	ABS.....	73
		Driving.....	40	BAS.....	74
		Fastening the seat belts.....	40	ESP	75
		Starting the engine	43	The SBC brake system.....	77
		Switching on headlamps	46	Anti-theft systems	81
		Turn signals and high beam	46	Immobilizer	81
		Windshield wipers.....	47	Anti-theft alarm system	82
				Tow-away alarm	82

Contents

Controls in detail	85	Lighting.....	112	One-touch gearshifting	152
Locking and unlocking	86	Exterior lamp switch.....	112	Gear ranges	153
Keys	86	Combination switch	115	Gear selector lever position	154
SmartKey with KEYLESS-GO*	89	Hazard warning flasher	115	Program mode selector switch	155
Opening the doors from the inside .	93	Interior lighting.....	116	Accelerator position.....	156
Opening the trunk from the inside..	94	Door entry lamps	117	Emergency operation	
Opening the trunk	96	Trunk lamp	117	(Limp home mode).....	156
Closing the trunk.....	96	Instrument cluster	118	Good visibility	157
Trunk lid emergency release	97	Instrument cluster illumination	118	Rear view mirror	157
Separately locking the trunk	98	Coolant temperature display.....	119	Headlamp cleaning system*	158
Separately unlocking the trunk	99	Trip odometer	119	Sun visors	158
Automatic central locking	99	Tachometer	120	Rear window sunshade*	160
Locking and unlocking from		Outside temperature indicator	120	Roller sunblind* in the rear doors	161
the inside	100	Control system	121	Climate control.....	162
Seats.....	102	Multifunction display.....	121	Setting the temperature.....	165
Easy-entry/exit feature*	102	Multifunction steering wheel.....	122	Adjusting air distribution.....	166
Head restraints.....	103	Menus	124	Adjusting air volume	166
Multicontour seat*	104	Standard display menu	126	Defrosting	167
Dynamic driving seat*	105	AUDIO menu	126	Air recirculation mode.....	167
Heated seats*	107	NAVI*	128	Rear window defroster	169
Seat ventilation*	108	Distronic* menu.....	128	Deactivating the climate	
Memory function.....	109	Malfunction memory menu	129	control system	170
Storing positions into memory	110	Settings menu.....	130	Air conditioner	170
Recalling positions from memory .	110	Trip computer menu.....	145	Residual heat and ventilation*	171
Storing parking position	111	TEL menu*	147	Automatic climate control*	172
		Automatic transmission	151	Setting the temperature.....	176

Contents

Adjusting air distribution.....	177	Roof rack	216	Driving off	252
Adjusting air volume	177	Ski sack*	216	Parking	252
Defrosting	178	Split rear bench seat*	219	Tires.....	252
Air recirculation mode.....	178	Folding front passenger seat*	222	Aquaplaning.....	253
Charcoal filter	180	Expanding the cargo area*	223	Tire traction	253
Rear window defroster	180	Loading instructions	224	Tire speed rating.....	254
Air conditioner	181	Cargo tie-down rings.....	225	Winter driving instructions.....	254
Residual heat and ventilation	182	Useful features	226	Standing water	255
Rear air conditioning.....	182	Interior storage spaces	226	Passenger compartment.....	255
Power windows.....	184	Ashtrays.....	231	Traveling abroad	255
Opening and closing the windows	184	Cigarette lighter.....	232	Control and operation of radio	
Synchronizing power windows	186	12-V socket*	232	transmitter.....	256
Sliding/pop-up roof*	187	Heated steering wheel*	233	Catalytic converter	256
Opening and closing the slid-		Telephone*	233	Emission control	257
ing/pop-up roof*	187	Tele Aid*	234	Coolant temperature	258
Synchronizing the		Garage door opener	243	At the gas station	259
sliding/pop-up roof.....	189			Check regularly and before	
Panorama sliding/pop-up roof*	190	Operation	247	a long trip	260
Panorama sliding/pop-up roof* ...	190	The first 1000 miles (1500km)	248	Engine compartment.....	261
Solar panel*	193	Driving instructions	249	Hood.....	261
Driving systems	194	Drive sensibly – save fuel.....	249	Engine oil.....	262
Cruise control	194	Drinking and driving.....	249	Transmission fluid level	264
Distronic*	197	Pedals	249	Coolant level.....	264
AIRMATIC DC (Dual Control)*	209	Power assistance	250	Battery.....	266
PARKTRONIC system*	212	Brakes.....	250	Windshield washer system and	
Loading.....	216			headlamp cleaning system*	267

Contents

Tires and wheels	268		
Important guidelines	268		
Life of tire	269		
Direction of rotation	269		
Checking tire inflation pressure ...	269		
Rotating wheels	272		
Winter driving	273		
Winter tires	273		
Block heater (Canada only)	274		
Snow chains	274		
Maintenance	275		
Flexible Service System PLUS (FSS PLUS)	275		
Clearing the service indicator	275		
Service term exceeded	276		
Calling up the service indicator	276		
Resetting the service indicator	276		
Setting the date for special works	278		
Calling up the service data information	279		
Vehicle care	280		
Cleaning and care of vehicle	280		
		Practical hints	287
		What to do if	288
		Lamps in instrument cluster	288
		Lamp in center console	294
		Messages in the display	295
		Where will I find ...?	324
		First aid kit	324
		Spare wheel	324
		Luggage box	325
		Vehicle tool kit	326
		Unlocking/locking in an emergency ..	327
		Unlocking the vehicle	327
		Locking the vehicle	328
		Changing batteries	328
		Fuel filler flap emergency release	329
		Manually unlocking the transmission selector lever	330
		Opening/closing in an emergency	331
		Sliding/pop-up roof* or panorama sliding/pop-up roof* ...	331
		Replacing bulbs	332
		Bulbs	332
		Replacing bulbs for front lamps ...	334
		Replacing bulbs for rear lamps	336
		Replacing wiper blades	337
		Replacing wiper blades	337
		Flat tire	338
		Preparing the vehicle	338
		Mounting the spare wheel	338
		Batteries	343
		Disconnecting the battery	344
		Removing the battery	344
		Charging and reinstalling the battery	344
		Reconnecting the batteries	345
		Jump starting	346
		Towing the vehicle	348
		Towing the vehicle	348
		Installing towing eye bolt	350
		Fuses	352
		Fuse box in passenger compartment	352

Contents

Technical data	355	Fuels, coolants, lubricants etc.....	366
Spare parts service.....	356	Capacities	366
Warranty coverage.....	357	Engine oils	368
Loss of Service and Warranty		Engine oil additives	368
Information Booklet	357	Air conditioner refrigerant.....	368
Identification labels	358	Brake fluid.....	368
Layout of poly-V-belt drive	359	Premium unleaded gasoline	369
E 320 / E 500	359	Fuel requirements.....	369
Engine.....	360	Gasoline additives.....	369
Rims and tires.....	361	Coolants	370
Same-sized tires.....	361	Windshield and headlamp washer	
Minispare wheel.....	362	system	372
Sport package.....	362	Consumer information.....	373
Electrical system	363	Uniform tire quality grading	373
Main dimensions	364		
Weights.....	365		

Contents

Product information

Please observe the following in your own best interest:

We recommend using Mercedes-Benz original parts as well as conversion parts and accessories explicitly approved by us for your vehicle model.

We have tested these parts to determine their reliability, safety and their special suitability for Mercedes-Benz vehicles.

We are unable to make an assessment for other products and therefore cannot be held responsible for them, even if in individual cases an official approval or authorization by governmental or other agencies should exist. Use of such parts and accessories could adversely affect the safety, performance or reliability of your vehicle. Please do not use them.

Mercedes-Benz original parts as well as conversion parts and accessories approved by us are available at your authorized Mercedes-Benz Center where you will receive comprehensive information, also on permissible technical modifications, and where proper installation will be performed.

Introduction

Operator's Manual

Operator's Manual

This Operator's Manual contains a great deal of useful information. We urge you to read it carefully and familiarize yourself with the vehicle before driving.

For your own safety and longer service life of the vehicle, we urge you to follow the instructions and warnings contained in this manual. Ignoring them could result in damage to the vehicle or personal injury to you or others. Vehicle damage caused by failure to follow instructions is not covered by the Mercedes-Benz Limited Warranty.

Your vehicle may have some or all of the equipment described in this manual. Therefore, you may find explanations for optional equipment not installed in your vehicle. If you have any questions about the operation of any equipment, your authorized Mercedes-Benz Center will be glad to demonstrate the proper procedures.

We continuously strive to improve our product, and ask for your understanding that we reserve the right to make changes in design and equipment. Therefore, information, illustrations and descriptions in this Operator's Manual might differ from your vehicle.

Optional equipment is also described in this manual, including operating instructions wherever necessary. Since they are special-order items, the descriptions and illustrations herein may vary slightly from the actual equipment of your vehicle.

If there are any equipment details that are not shown or described in this Operator's Manual, your authorized Mercedes-Benz Center will be glad to inform you of correct care and operating procedures.

The Operator's Manual and Service Booklet are important documents and should be kept with the vehicle.

Service and warranty information

The Service and Warranty Information Booklet contains detailed information about the warranties covering your Mercedes-Benz, including:

- New Car Limited Warranty,
- Emission System Warranty,
- Emission Performance Warranty,
- California, Maine, Massachusetts, and Vermont Emission Control System Warranty (California, Maine, Massachusetts, and Vermont only),
- State Warranty Enforcement Laws (Lemon Laws).

Important notice for California retail buyers and lessees of Mercedes-Benz automobiles

Under California law you may be entitled to a replacement of your vehicle or a refund of the purchase price or lease price, if Mercedes-Benz USA, LLC and / or its authorized repair or service facilities fail to fix one or more substantial defects or malfunctions in the vehicle that are covered by its express warranty after a reasonable number of repair attempts. During the period of 18 months from original delivery of the vehicle or the accumulation of 18 000 miles (approx. 29 000 km) on the odometer of the vehicle, whichever occurs first, a reasonable number of repair attempts is presumed for a retail buyer or lessee if one or more of the following occurs:

- (1) the same substantial defect or malfunction results in a condition that is likely to cause death or serious bodily injury if the vehicle is driven, that defect or malfunction has been subject to repair two or more times, and you have directly notified Mercedes-Benz USA, LLC in writing of the need for its repair,
- (2) the same substantial defect or malfunction of a less serious nature than category (1) has been subject to repair four or more times and you have directly notified us in writing of the need for its repair, or
- (3) the vehicle is out of service by reason of repair of the same or different substantial defects or malfunctions for a cumulative total of more than 30 calendar days. Written notification should be sent to us, not a dealer, at Mercedes-Benz USA, LLC, Customer Assistance Center, One Mercedes Drive, Montvale, NJ 07645-0350.

Introduction

Operator's Manual

Maintenance

The Service Booklet describes all the necessary maintenance work which should be performed at regular intervals.

Always have the Service Booklet with you when you take the vehicle to your authorized Mercedes-Benz Center for service. The service advisor will record each service in the booklet for you.

Roadside Assistance

The Mercedes-Benz Roadside Assistance Program provides factory trained technical help in the event of a breakdown. Calls to the toll-free Roadside Assistance number

1-800-FOR-MERcedes (in the USA)
1-800-387-0100 (in Canada)

will be answered by Mercedes-Benz Customer Assistance Representatives 24 hours a day, 365 days a year.

For additional information refer to the Mercedes-Benz Roadside Assistance Program brochure in your glove box.

Change of address or ownership

If you change your address, be sure to send in the "Change of Address Notice" found in the Service and Warranty Information Booklet, or simply call the Mercedes-Benz Customer Assistance Center (in the USA) at 1-800-FOR-MER-Cedes, or Customer Service (in Canada) at 1-800-387-0100. It is in your own interest that we can contact you should the need arise.

If you sell your Mercedes, please leave all literature with the vehicle to make it available to the next operator.

If you bought this vehicle used, be sure to send in the "Notice of Purchase of Used Car" found in the Service and Warranty Information Booklet, or call the Mercedes-Benz Customer Assistance Center (in the USA) at 1-800-FOR-MERcedes, or Customer Service (in Canada) at 1-800-387-0100.

Operating your vehicle outside the USA or Canada

If you plan to operate your vehicle in foreign countries, please be aware that:

- service facilities or replacement parts may not be readily available,
- unleaded gasoline for vehicles with catalytic converters may not be available; the use of leaded fuels will damage the catalyts,
- gasoline may have a considerably lower octane rating, and improper fuel can cause engine damage.

Certain Mercedes-Benz models are available for delivery in Europe under our European Delivery Program. For details, consult your authorized Mercedes-Benz Center or write to:

In the USA:

Mercedes-Benz USA, LLC
European Delivery Department
One Mercedes Drive
Montvale, NJ 07645-0350

In Canada:

Mercedes-Benz Canada, Inc.
European Delivery Department
849 Eglinton Avenue East
Toronto, Ontario M4G 2L5

Introduction

Where to find it

Where to find it

This Operator's Manual is designed to provide comprehensive support information for you, the vehicle operator. For you to find information quickly each section has its own reference color:

At a glance

Here you will find an overview of all the controls that can be operated from the driver's seat.

Getting started

Here you will find all the information you need for your first drive. You should read this section first if this is your first Mercedes-Benz vehicle or if you are renting or borrowing this vehicle.

Safety and Security

Here you will find descriptions of the safety features of your vehicle.

Controls in detail

Here you will find detailed information about the equipment installed in your vehicle. This section expands on the "Getting started" section and also describes technical innovations. If you are already familiar with the basic functions of your vehicle, this section will be of particular interest to you.

Operation

Here you will find all the information you need for the proper operation of your vehicle.

Practical hints

This section provides fast assistance for dealing with problems you may encounter.

Technical data

All important technical data for your vehicle can be found in this section.

Indexes

The glossary provides explanations of the most important technical terms.

The table of contents and the index are designed to help you find information quickly and easily.

The following publications are part of your vehicle documentation:

- this Operator's Manual
- the Service Booklet

Separate operating instructions will be provided as required depending on the equipment options installed in your vehicle.

Symbols

The following symbols are found in this Operator's Manual:

- * Optional equipment is identified with an asterisk. Since standard equipment varies between models, the descriptions and illustrations in this manual may differ slightly from the actual equipment of your vehicle.

Warning!



Warning notices draw your attention to hazards that may endanger your health or life, or the health or life of others.



Highlights hazards that may result in damage to your vehicle.



Helpful hints or further information you may find useful.

- ▶ This symbol points to instructions for you to follow.
- ▶ A number of these symbols appearing in succession indicates a multiple-step procedure.
 - ▷ Page This symbol tells you where to look for further information on a topic.
 - ▷▷ This continuation symbol marks an interrupted procedure which will be continued on the next page.
 - > In the glossary of technical terms, this symbol is used to cross-reference term definitions.
 - Display Words appearing in the multi-function display are printed in the type shown here.

Introduction

Operating safety

Operating safety

Warning!



Work improperly carried out on electronic components and associated software could cause them to cease functioning. Because the vehicle's electronic components are interconnected, any modification made may produce an undesired effect on other systems.

Electronic system malfunctions could seriously impair the operating safety of your vehicle.

Ensure that any repairs or modifications to electronic components are carried out by an authorized Mercedes-Benz Center.

Other improper work or modifications on the vehicle could also have a negative impact on the operating safety of the vehicle.

Some safety systems only function while the engine is running. You should therefore never turn off the engine while driving.

Proper use of the vehicle

Proper use of the vehicle requires that you are familiar with the following information and rules:

- the safety precautions in this manual
- the "Technical data" section in this manual
- traffic rules and regulations
- motor vehicle laws and safety standards

Problems with your vehicle

If you should experience a problem with your vehicle, particularly one that you believe may affect its safe operation, we urge you to immediately contact your authorized Mercedes-Benz Center to have the problem diagnosed and corrected if required. If the matter is not handled to your satisfaction, please discuss the problem with the Mercedes-Benz Center management, or if necessary contact us at one of the following addresses:

In the USA:

Customer Assistance Center
Mercedes-Benz USA, LLC
One Mercedes Drive
Montvale, NJ 07645-0350

In Canada:

Customer Relations Department
Mercedes-Benz Canada, Inc.
849 Eglinton Avenue East
Toronto, Ontario, M4G 2L5

Introduction

Reporting safety defects

Reporting safety defects

For the USA only:

The following text is published as required of manufacturers under Title 49, Code of U.S. Federal Regulations, Part 575 pursuant to the "National Traffic and Motor Vehicle Safety Act of 1966".

Reporting safety defects

If you believe that your vehicle has a defect which could cause a crash or could cause injury or death, you should immediately inform the National Highway Traffic Safety Administration (NHTSA) in addition to notifying Mercedes-Benz USA, LLC.

If NHTSA receives similar complaints, it may open an investigation, and if it finds that a safety defect exists in a group of vehicles, it may order a recall and remedy campaign. However, NHTSA cannot become involved in individual problems between you, your dealer, or Mercedes-Benz USA, LLC.

To contact NHTSA, you may either call the Auto Safety Hotline toll-free at 1-888-327-4236 (or 366-0123 in Washington, D.C. area) or write to: NHTSA, U.S. Department of Transportation, Washington, D.C. 20590. You can also obtain other information about motor vehicle safety from the Hotline.



At a glance

Cockpit

Instrument cluster

Multifunction steering wheel

Center console

Overhead control panel

Door control panel

At a glance

Cockpit

Cockpit

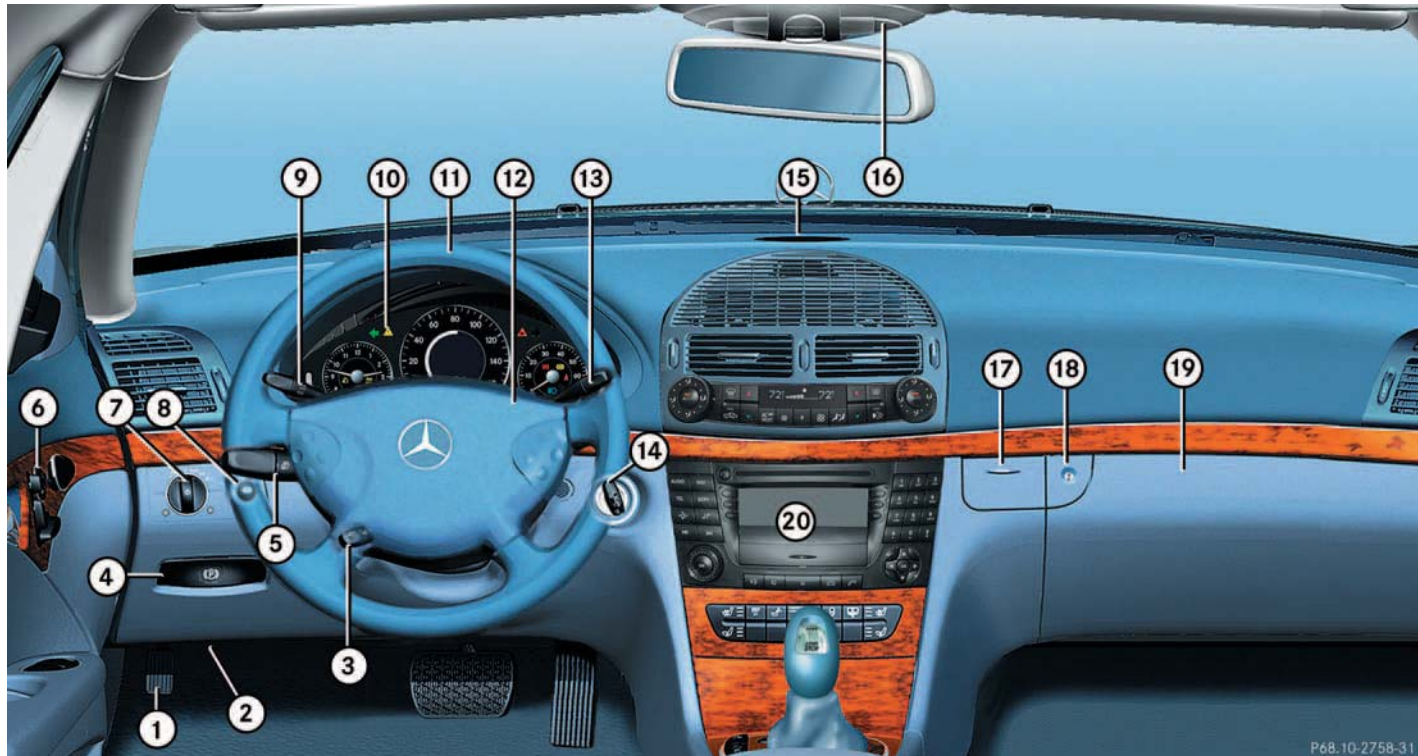

20

At a glance

Cockpit

Item	Page
1 Parking brake pedal	45, 50
2 Hood lock release	261
3 Steering wheel adjustment stalk	38
Heated steering wheel*	233
4 Parking brake release	45
5 Combination switch	
• Turn signals	46
• Windshield wipers	47
• High beam	47
6 Door control panel	28
7 Exterior lamp switch	112

Item	Page
8 Headlamp washer button*	158
9 Cruise control lever	
• Cruise control	201
• Distronic*	197
10 Instrument cluster	22, 118
11 Multifunction steering wheel	24, 122
12 Horn	
13 Lever for voice recognition system*, see separate operating instructions	

Item	Page
14 Starter switch	31
15 Front Parktronic* warning indicator	212
16 Overhead control panel	27
17 Mobile phone/Glasses box	226
18 Glove box lid release, glove box lock	226
19 Glove box	226
20 Center console	25

At a glance





Instrument cluster

Instrument cluster











At a glance

Instrument cluster

	Item	Page
1	 Left turn signal indicator lamp	
2	 Electronic Stability Program (ESP) warning lamp	288
3	Speedometer	
4	Multifunction display with:	
	Basic display with outside temperature display	126
	Status indicator with malfunction warning message	
	Trip odometer	119
5	 Distance warning lamp ¹	289
6	 Right turn signal indicator lamp	

¹ Vehicles without DISTRONIC*: Warning lamp without function. It illuminates with key in starter switch position 2. It should go out when the engine is running.

	Item	Page
7	Coolant temperature display with:	
	 Coolant temperature warning lamp	292
8	Tachometer with:	
	 Supplemental restraint system indicator lamp	290
	 Antilock Brake System (ABS) malfunction indicator lamp	289
	 Seat belt nonusage warning lamp	293
	 High beam headlamp indicator	115
9	Main odometer with:	
	• Selector lever position	43
	• Program mode	155





	Item	Page
10	Clock with:	
	 Brake warning lamp, except Canada	291
	 Brake warning lamp, Canada only	291
	 Engine malfunction indicator lamp	293
11	Fuel display with:	
	 Fuel reserve warning lamp	293
12	Reset knob for:	
	• Resetting trip odometer	119
	• Adjusting instrument cluster illumination	118
	• Confirming new time settings	136



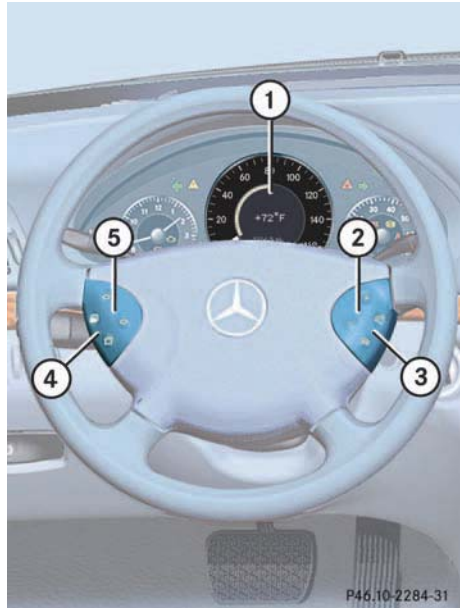

At a glance

Multifunction steering wheel

Multifunction steering wheel



Item	Page
1 Multifunction display in speedometer	121
Operating control system	122
2 Selecting the submenu or setting the volume	
 down/to decrease	
 up/to increase	
3 Telephone*: Press button	
 to take a call to dial a call	
 to end a call to reject an incoming call	

Item	Page
4 Menu systems: Press button	
 for next system	
 for previous system	
5 Moving within a menu: Press button	
 for next display	
 for previous display	

At a glance

Center console

Center console

Upper part



Item	Page
1 Automatic climate control*	172
2 Audio system, see separate operating instructions	
3 Seat heater*, front passenger side	107
4 Rear window sunshade*	160
5 Central locking switch	100
6 Opening/closing button for storage tray or CD changer*, see separate operating instructions	227
7 Rear seat head restraints switch, folding down	104

Item	Page
8 Electronic Stability Program (ESP) control switch	76
9 Seat heater*, driver's side	107
10 Hazard warning flasher switch	115
11 PASSENGER AIRBAG OFF warning lamp	67

At a glance

Center console

Lower part

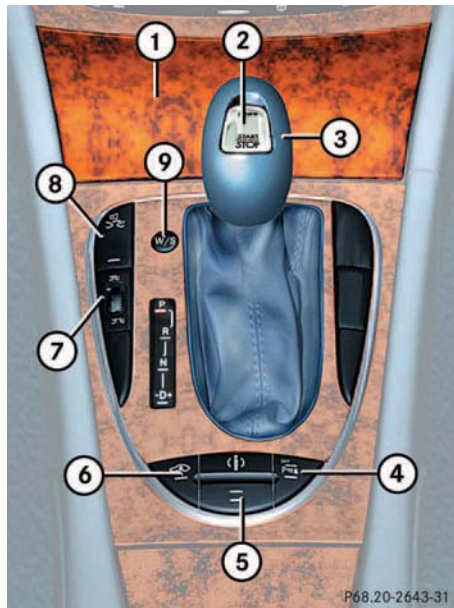

Item	Page
1 Ashtray	231
2 KEYLESS-GO* start/stop button	33
3 Selector lever for automatic transmission	43, 151
4 Parking assist (Parktronic system)* deactivation switch	212
5 Adaptive damping system (ADS)* switch	209

Item	Page
6 Vehicle level control switch*	209
7 Thumbwheel for setting distance for DISTRONIC*	204
8 Distance warning function* on/off switch	205
9 Program mode selector for automatic transmission	155

At a glance

Overhead control panel

Overhead control panel

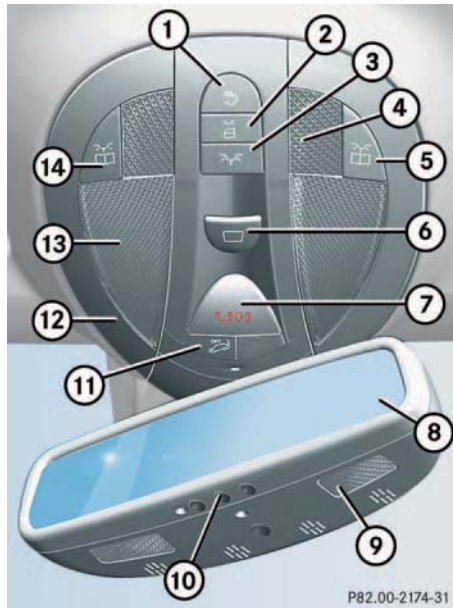

Item	Page
1 Rear interior lighting on/off	116
2 Automatic interior lighting	116
3 Front interior lighting on/off	116
4 Temperature sensor	
5 Right reading lamp on/off	116
6 Sliding/pop-up roof* or panorama sliding/pop-up roof*	187, 190

Item	Page
7 Tele Aid (emergency call system) button	234
8 Rear view mirror	157
9 Reading lamps	116
10 Garage door opener	243
11 Tow-away alarm button	82
12 Ambient lighting	140
13 Interior lighting	
14 Left reading lamp on/off	117

At a glance

Door control panel

Door control panel

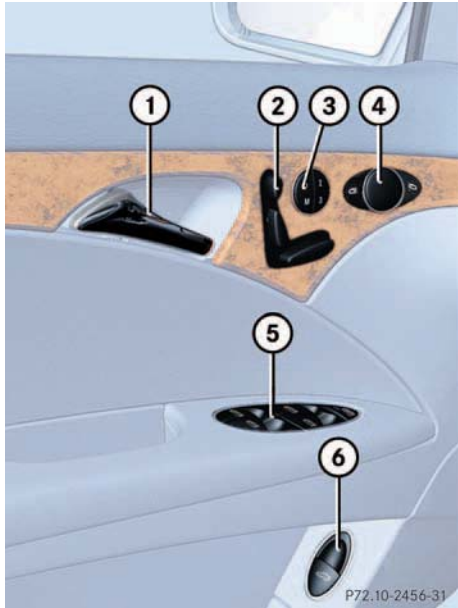

Item	Page
1 Door handle	93
2 Seat adjustment	35
3 Memory function (for storing seat, mirror and steering wheel settings)	109
4 Exterior rear view mirror adjustment	39
5 Switches for opening/closing front and rear side windows, rear window override switch	184
6 Trunk lid release switch, Trunk lid opening/closing system*	94

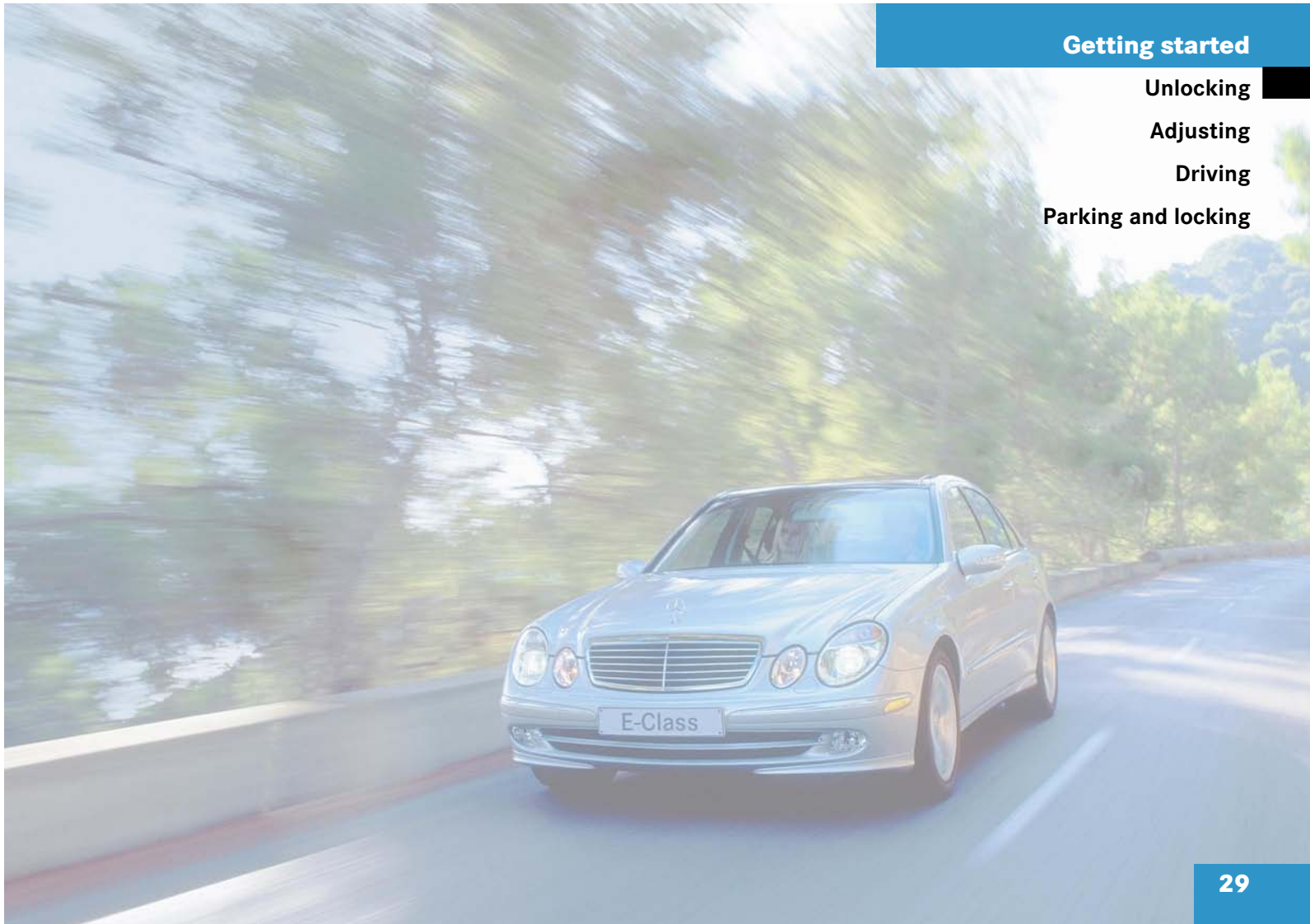

Getting started

Unlocking

Adjusting

Driving

Parking and locking

Getting started

Unlocking

The "Getting started" section provides an overview of the vehicle's most basic functions. First-time Mercedes-Benz owners should pay special attention to the information given here.



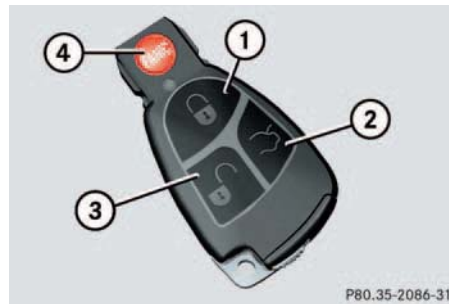

If you are already familiar with the basic functions described here, the "Controls in detail" section will help you with further information. The corresponding page references are at the end of each segment.

Unlocking

Unlocking with the SmartKey



SmartKey with remote control

- 1  Lock button
- 2  Unlock button for trunk lid
- 3  Unlock button
- 4  Panic button (▷ page 72)

- ▶ Press unlock button  on the key.
All turn signal lamps blink once. The locking knobs in the doors move up.
- ▶ Get in the vehicle and insert the key in the starter switch.

More information can be found in the "Controls in detail" section (▷ page 86).

Starter switch positions



Starter switch

- 0** For removing key
- 1** Power supply to some electrical consumers, such as seat adjustment
- 2** Ignition (power supply for all electrical consumers) and driving position
- 3** Starting position

Warning!



When leaving the vehicle always remove the key from the starter switch, take the SmartKey with KEYLESS-GO* (if so equipped) with you and lock the vehicle. Do not leave children unattended in the vehicle, or with access to an unlocked vehicle. Unsupervised use of vehicle equipment may cause serious personal injury.



The SmartKey can only be removed from the starter switch with the gear selector lever in position **P**.



If the key is left in starter switch position **0** for an extended period of time, it can no longer be turned in the starter switch.

- ▶ Remove the key from the starter switch and reinsert.

If the key can still not be turned, the battery may not be sufficiently charged.

- ▶ Check the battery and charge it if necessary (▷ page 266).
- ▶ Get a jump start (▷ page 346).

To prevent accelerated battery discharge or a completely discharged battery, always remove the key from the starter switch.

Getting started

Unlocking

Unlocking with KEYLESS-GO*

Your vehicle comes supplied with two SmartKeys with remote controls and a removable mechanical key. The locking tabs for the mechanical key portion of the two keys are a different color to help distinguish each key unit.

The function of the SmartKey overrides the KEYLESS-GO function.

If you have the KEYLESS-GO function, your vehicle checks whether the SmartKey with KEYLESS-GO is valid when you grasp the door handle. If your key is valid, the doors will unlock, and you can open them.



To unlock the vehicle, the SmartKey with KEYLESS-GO must be outside the vehicle, no further than approx. 3 feet (1 meter) away from the door.

Warning!



When leaving the vehicle always take the key and the SmartKey with KEYLESS-GO with you, and lock the vehicle. Do not leave children unattended in the vehicle, or with access to an unlocked vehicle. Unsupervised use of vehicle equipment may cause serious personal injury.

- ▶ Grasp the door handle.

The turn signal lamps blink once. The locking knobs on the doors move up.

Pressing the KEYLESS-GO start/stop button on the selector lever corresponds to turning the key to the various starter switch positions.

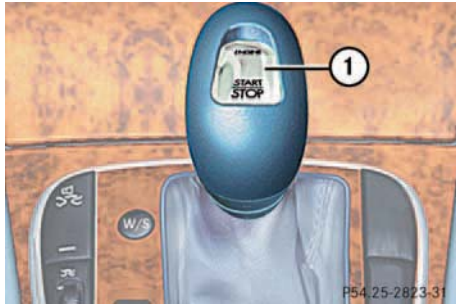

1 KEYLESS-GO start/stop button

Before you press the KEYLESS-GO start/stop button, the vehicle's on-board electronics have status **0** (as with key removed).

Make sure the gear selector lever is set to **P**.

Do not depress the brake pedal.

Position 1

- ▶ Press the KEYLESS-GO start/stop button once.

This supplies power to some electrical consumers, such as seat adjustment.



If you now press the KEYLESS-GO start/stop button twice, the power supply is again switched off.

Ignition (or position 2)

- ▶ Press the KEYLESS-GO start/stop button twice.

This supplies power to all electrical consumers. All the lights in the instrument cluster light up.



If you now press the KEYLESS-GO start/stop button once, the power supply is again switched off.

More information can be found in the "Controls in detail" section (▷ page 89). For information on starting the engine using the KEYLESS-GO start/stop button, see "Starting with KEYLESS-GO" (▷ page 44).

Getting started

Adjusting

Adjusting

Warning!



All seat, head restraint, steering wheel, and rear view mirror adjustments, as well as fastening of seat belts, must be done before the vehicle is put into motion.

Seats

Warning!



Do not adjust the driver's seat while driving. Adjusting the seat while driving could cause the driver to lose control of the vehicle.

Never ride in a moving vehicle with the seat back reclined. Sitting in an excessively reclined position can be dangerous. You could slide under the seat belt in a collision. If you slide under it, the belt would apply force at the abdomen or neck. That could cause serious or fatal injuries. The seat back and seat belts provide the best restraint when the wearer is in an upright position and belts are properly positioned on the body.

Your seat must be adjusted so that you can correctly fasten your seat belt (▷ page 40).

Never place hands under the seat or near any moving parts while a seat is being adjusted.

Warning!



When leaving the vehicle always remove the key from the starter switch, take the Smart-Key with KEYLESS-GO* (if so equipped) with you, and lock your vehicle.

The power seats can also be operated with the driver's or passenger door open. Do not leave children unattended in the vehicle, or with access to an unlocked vehicle. Unsupervised use of vehicle equipment may cause serious personal injury.

Warning!



Children 12 years old and under must never ride in the front seat, except in a Mercedes-Benz authorized BabySmart™ compatible child seat, which operates with the BabySmart™ system installed in the vehicle to deactivate the passenger front airbag when it is properly installed. Otherwise they will be struck by the airbag when it inflates in a crash. If this happens, serious or fatal injury will result.

According to accident statistics, children are safer when properly restrained in the rear seating positions than in the front seating positions. Infants and small children must ride in back seats and be seated in an appropriate infant or child restraint system, which is properly secured with the vehicle's seat belt, fully in accordance with the child seat manufacturer's instructions.

Infants and small children must be seated in an appropriate infant or child restraint system, which is properly secured with the vehicle's seat belt, fully in accordance with the child seat manufacturer's instructions.

A child's risk of serious or fatal injuries is significantly increased if the child restraints are not properly secured in the vehicle and the child is not properly secured in the child restraint.

Seat adjustment

The seat adjustment switches are located in each door.

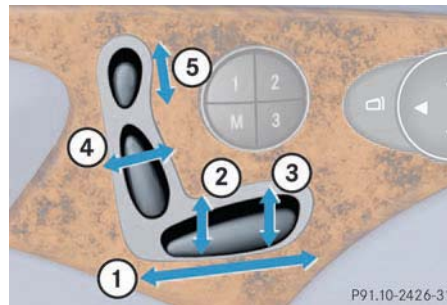

- 1 Seat fore and aft adjustment
- 2 Seat height
- 3 Seat cushion tilt
- 4 Backrest tilt
- 5 Head restraint height

- ▶ Turn the key in the starter switch to position **1** or **2**.
or
- ▶ Press the KEYLESS GO* start/stop button once or twice.
or

Getting started

Adjusting

- ▶ Open the driver's or passenger door.

Seat height

- ▶ Press the switch up or down in the direction of arrow **2**.

Seat fore and aft adjustment

- ▶ Press the switch forward or backward in the direction of arrow **1**.

Adjust to a comfortable seating position that still allows you to reach the accelerator / brake pedal safely. The position should be as far to the rear as possible, consistent with ability to properly operate controls.



When moving the seat, be sure that there are no items in the footwell or behind the seats. Otherwise you could damage the seats.

Getting started

Adjusting

Seat cushion tilt

- ▶ Press the switch up or down in the direction of arrow **3** until your upper legs are lightly supported.

Backrest tilt

- ▶ Press the switch forward or backward in the direction of arrow **4** until your arms are slightly angled when holding the steering wheel.

Front head restraint height

Warning!



For your protection, drive only with properly positioned head restraints.

Adjust head restraint to support the back of the head approximately at ear level.

Do not drive the vehicle without the seat head restraints. Head restraints are intended to help reduce injuries during an accident.

- ▶ Press the switch up or down in the direction of arrow **5**.

Front head restraint tilt

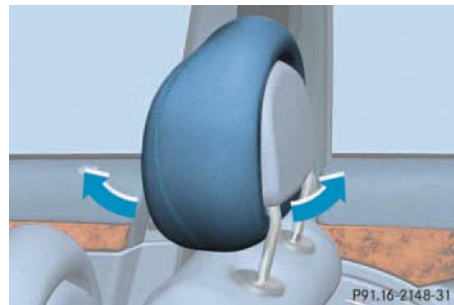

- ▶ Manually adjust the angle of the head restraint. Push or pull on the lower edge of the head restraint cushion.

More information can be found in the "Controls in detail" section (▷ page 102).

Rear seat head restraints

The rear seat head restraints can be folded backward for increased visibility.

Warning!



For safety reasons, always drive with the rear head restraints in the upright position when the rear seats are occupied.

Keep the area around head restraints clear of articles (e.g. clothing) to not obstruct the folding operation of the head restraints.



The rear seat head restraints cannot be adjusted.

Folding rear head restraints back with switch in the center console

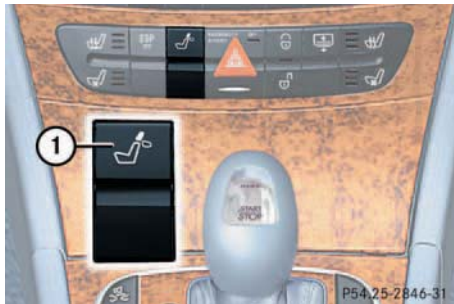

1 Head restraint release switch

- ▶ Turn the electric key in starter switch to position **1** or **2**.
- ▶ Press the symbol-side on rocker switch **1** to release the head restraints. The head restraints will fold backward.

Placing rear head restraints upright



- ▶ Pull the head restraint forward until it locks into position.

Steering wheel

Warning!



Do not adjust the steering wheel while driving. Adjusting the steering wheel while driving could cause the driver to lose control of the vehicle.

When leaving the vehicle always remove the key from the starter switch, take the Smart-Key with KEYLESS-GO* (if so equipped) with you and lock your vehicle.

The electrical steering wheel adjustment feature can also be operated with the driver's door open. Do not leave children unattended in the vehicle, or with access to an unlocked vehicle. Unsupervised use of vehicle equipment may cause serious personal injury.

Getting started

Adjusting

Steering wheel adjustment

The stalk is located on the steering column (lower left).

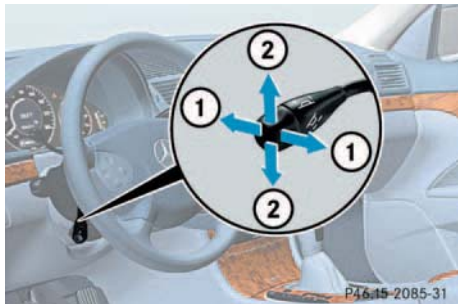

- 1 Steering column stalk, adjusts length
- 2 Steering column stalk, adjusts height

- ▶ Turn the key in the starter switch to position **1** or **2**.
or
- ▶ Press the KEYLESS GO* start/stop button once or twice.
or
- ▶ Open the driver or passenger door.

Steering column, lengthen or shorten

- ▶ Move stalk forward or backward in the direction of arrow **1** until a comfortable steering wheel position is reached with your arms slightly bent at the elbow.

Steering column, height

- ▶ Move the stalk up or down in the direction of arrow **2**. Make sure that your legs can move freely and that all the displays (including malfunction and indicator lamps) on the instrument cluster are clearly visible.

Mirrors

Adjust the inside and exterior rear view mirrors before driving so that you have a good view of the road and traffic conditions.

Warning!



In the case of an accident liquid electrolyte may escape the mirror housing if the mirror glass breaks.

Electrolyte has an irritating effect. Do not allow the liquid to come into contact with eyes, skin, clothing, or respiratory system. In case it does, immediately flush affected area with water, and seek medical help if necessary.

Inside rear view mirror

- ▶ Manually adjust the inside rear view mirror.

More information can be found in the "Controls in detail" section (> page 157).

Exterior rear view mirror

Warning!

Exercise care when using the passenger side exterior rear view mirror. The mirror surface is convex (outwardly curved surface for a wider field of view). Objects in mirror are closer than they appear. Check your inside rear view mirror or glance over your shoulder before changing lanes.



Electrolyte drops coming into contact with the vehicle paint finish can only be completely removed while in their liquid state and by applying plenty of water.

The buttons are on the driver's door.

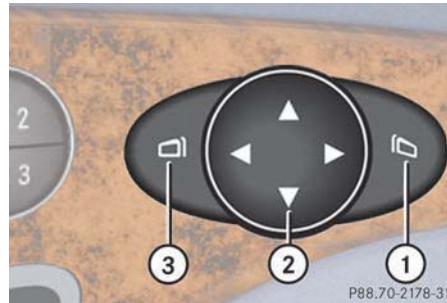

- 1 Passenger side mirror
- 2 Adjustment button
- 3 Driver's side mirror

- ▶ Make sure that the ignition is switched on.
All the lights in the instrument cluster light up.
- ▶ Press button **3** for the left mirror or button **1** for the right mirror.
- ▶ Push adjustment button **2** up, down, left or right according to the setting desired.



If an exterior rear view mirror housing is forcibly pushed forward or backward, reposition it by applying firm pressure until it snaps into place. The mirror housing is now properly positioned and you can adjust the mirror normally.



At low ambient temperatures, the mirrors will be heated automatically.

More information can be found in the "Controls in detail" section (▷ page 157).

Getting started

Driving

Driving

Warning!



Do not lay any objects in the driver's footwell. Be careful that floor mats or carpets in the driver's footwell have sufficient clearance for the pedals.

During sudden driving or braking maneuvers the objects could get between the pedals. You could then no longer brake or accelerate.

Fastening the seat belts

Warning!



Always fasten your seat belt before driving off. Always make sure your passengers are properly restrained, even those sitting in the rear and pregnant women.

Failure to wear and properly fasten and position your seat belt greatly increases your risk of injuries and their likely severity in an accident. You and your passenger should always wear seat belts.

If you are ever in an accident, your injuries can be considerably more severe without your seat belt properly buckled. Without your seat belt buckled, you are much more likely to hit the interior of the vehicle or be ejected from it. You can be seriously injured or killed.

In the same crash, the possibility of injury or death is lessened if you are wearing your seat belt. The airbags can only protect as expected if the occupants are using their seat belts (▷ page 61).

Warning!



Children 12 years old and under must never ride in the front seat, except in a Mercedes-Benz authorized BabySmart™ compatible child seat, which operates with the BabySmart™ system installed in the vehicle to deactivate the passenger front airbag when it is properly installed. Otherwise they will be struck by the airbag when it inflates in a crash. If this happens, serious or fatal injury will result.

According to accident statistics, children are safer when properly restrained in the rear seating positions than in the front seating positions. Infants and small children must ride in back seats and be seated in an appropriate infant or child restraint system, which is properly secured with the vehicle's seat belt, fully in accordance with the child seat manufacturer's instructions.

A child's risk of serious or fatal injuries is significantly increased if the child restraints are not properly secured in the vehicle and the child is not properly secured in the child restraint.

Warning!



Never let more people ride in the vehicle than there are seat belts available. Be sure everyone riding in the vehicle is correctly restrained with a separate seat belt.

Warning!



Never ride in a moving vehicle with the backrest reclined. Sitting in an excessively reclined position can be dangerous. You could slide under the seat belt in a collision. If you slide under it, the belt would apply force at the abdomen or neck. That could cause serious or even fatal injuries. The backrest and seat belt provide the best restraint when the wearer is in an upright position and the belt is properly positioned on the body.

Warning!



Read and observe the additional warning notices printed in the "Safety and security" section (▷ page 61).

Getting started

Driving



- 1 Retractor
- 2 Latch plate
- 3 Buckle
- 4 Release button

Getting started

Driving

- ▶ Place the belt over your shoulder.
- ▶ Push latch plate **2** into buckle **3** until it clicks.
- ▶ If necessary, tighten the lap portion to a snug fit by pulling shoulder portion up.

Belt outlet height adjustment

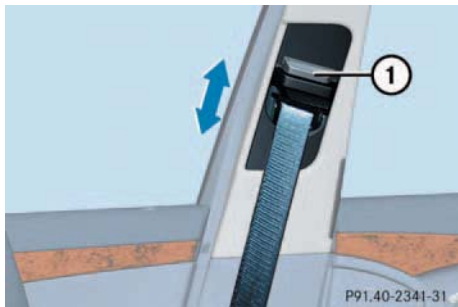

1 Release button

- ▶ Press release button **1** and move the seat belt height adjuster upward or downward.

Proper use of seat belts

- Do not twist the belt when fastening.
- Adjust seat belt so that the shoulder portion is located as close as possible to the middle of the shoulder (it should not touch the neck or pass under the arm).
- Position the lap belt as low as possible on your hips (over hip joint) and not across the abdomen.
- Place the seat backrest in a nearly upright position.
- Each seat belt should never be used for more than one person at a time.
- Do not fasten a seat belt around a person and another object at the same time.
- Check your seat belt during travel to ensure that it is properly positioned.
- Ensure that the seat belt is always fitted snugly. You should avoid wearing bulky clothing, such as winter coats, when traveling in the vehicle.

Warning!

Do not pass belts over sharp edges. They could tear.

Do not allow the belt to get caught in the door or in the seat adjustment mechanism. This could damage the belt.

Never attempt to make modifications to seat belts. This could impair the effectiveness of the belts.

Damaged seat belts or belts that were highly stressed in an accident must be replaced by an authorized Mercedes-Benz Center.

Starting the engine**Warning!**

Inhalation of exhaust gas is hazardous to your health. All exhaust gas contains carbon monoxide, and inhaling it can cause unconsciousness and lead to death.

Do not run the engine in confined areas (such as a garage) which are not properly ventilated. If you think that exhaust gas fumes are entering the vehicle while driving, have the cause determined and corrected immediately. If you must drive under these conditions, drive only with at least one window fully open.

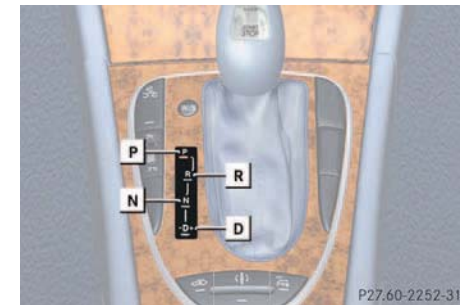
Automatic transmission**Gearshift pattern for automatic transmission**

- P** Park position with selector lever lock
- R** Reverse gear
- N** Neutral
- D** Drive position

- ▶ Make sure that the gear selector lever is set to **P**.

More information can be found in the "Controls in detail" section (▷ page 151).

Getting started

Driving

Starting with the key

- ▶ Turn the key in the starter switch to position **3** and hold until the engine starts (▷ page 31).



You can also use the "touch-start" function. Turn the key to position **3** and release it again immediately. The engine then starts automatically.

- ▶ Depress the brake pedal.

The selector lever lock is released.

For information on turning off the engine with the key, see "Turning off the engine" (▷ page 51).

Starting with KEYLESS-GO*

You can start your vehicle without a key using the KEYLESS-GO start/stop button on the gear selector lever.

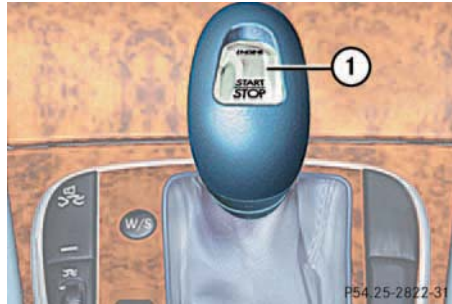

1 KEYLESS-GO start/stop button

- ▶ Depress the brake pedal during the starting procedure. Do not depress accelerator.

The selector lever lock is released.

- ▶ Press KEYLESS-GO start/stop button **1** once.

The engine starts automatically.

For information on turning off the engine with KEYLESS-GO, see "Turning off with KEYLESS-GO*" (▷ page 53).

Starting difficulties



Ensure that the brake pedal is depressed when starting the engine.

If the engine does not start as described, carry out the following steps:

- ▶ If you are starting the engine with the key, turn key in starter switch to position **0** and repeat starting procedure.
- ▶ If you are starting the engine with KEYLESS-GO*: Close any doors that may be open to allow for better detection of the SmartKey with KEYLESS-GO*. Or:
Start the engine with the key as radio signals from another source may be interfering with the SmartKey with KEYLESS-GO*.
- ▶ Repeat the starting procedure (▷ page 43). Remember that extended starting attempts can drain the battery.

- ▶ Get a jump start (▷ page 346).

If the engine does not start after several starting attempts, there could be a malfunction in the engine electronics or in the fuel supply system.

- ▶ Notify an authorized Mercedes-Benz Center.

Parking brake



- 1 Parking brake pedal
- 2 Parking brake release handle

Warning!



When leaving the vehicle always remove the key from the starter switch, take the Smart-Key with KEYLESS-GO* (if so equipped) with you and lock the vehicle. Do not leave children unattended in the vehicle, or with access to an unlocked vehicle. Children could release the parking brake, which could result in an accident or serious injury.

- ▶ Release the parking brake by pulling on handle **2**.

The indicator lamp **BRAKE** (USA only) or  (Canada only) in the clock goes out.

Driving

- ▶ Depress the brake pedal.
- ▶ Move selector lever to position **D** or **R**.

Getting started

Driving



Wait for the gear selection process to complete before setting the vehicle in motion.

- ▶ Release the brake pedal.
- ▶ Carefully depress the accelerator pedal.

Once the vehicle is in motion, the automatic central locking system engages and the locking knobs drop down.



You can open a locked door from the inside. Open door only when conditions are safe to do so.



If you hear a warning signal when driving off, you have forgotten to release the parking brake.

Release the parking brake.

Getting started

Driving

After a cold start the automatic transmission engages at a higher revolution. This allows the catalytic converter to reach its operating temperature earlier.

Warning!



On slippery road surfaces, never downshift in order to obtain braking action. This could result in drive wheel slip and reduced vehicle control. Your vehicle's ABS will not prevent this type of loss of control.

Warning!



It is dangerous to shift the selector lever out of **P** or **N** if the engine speed is higher than idle speed. If your foot is not firmly on the brake pedal, the vehicle could accelerate quickly forward or in reverse. You could lose control of the vehicle and hit someone or something. Only shift into gear when the engine is idling normally and when your right foot is firmly on the brake pedal.

46

More information on driving can be found in the "Operation" section (▷ page 249).

Switching on headlamps



Exterior lamp switch

- 1 Off
 - 2 Low beam headlamps on
- Turn the switch to .

More information can be found in the "Controls in detail" section (▷ page 112).

Turn signals and high beam

The combination switch is on the left of the steering column.

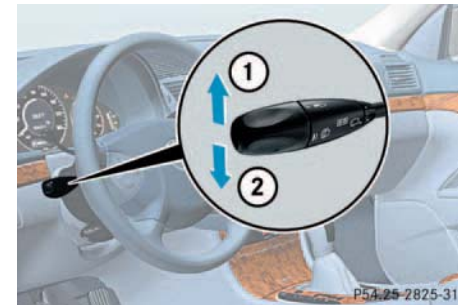

Combination switch

- 1 Turn signals, right
- 2 Turn signals, left

- Press the combination switch up **1** or down **2**.



To signal minor directional changes, move combination switch to point of resistance only and release. The turn signal blinks three times.

High beam

- ▶ Push the combination switch forward. The high beam headlights are switched on. The high beam symbol  in the tachometer lights up.

More information can be found in the "Controls in detail" section (▷ page 115).

Windshield wipers

The combination switch is on the left of the steering column.

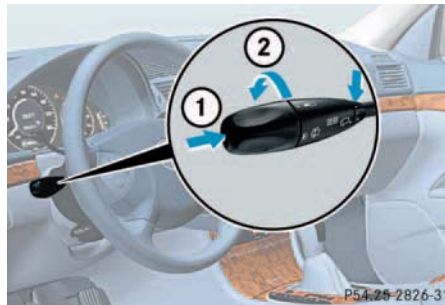

Combination switch

- 1 Single wipe
 - 2 Switching on windshield wipers
- ▶ Make sure that the ignition is switched on.

Switching on windshield wipers

- ▶ Turn the combination switch to the desired position depending on the intensity of the rain.

Getting started

Driving

- 0 Windshield wipers off
- I Intermittent wiping (interval dependent on wetness of windshield)
- II Normal wiper speed
- III Fast wiper speed



The intermittent wiping interval is dependent on wetness of windshield. Wiping will not occur with a door open. Do not leave windshield wipers in intermittent setting when vehicle is taken to an automatic car wash or during windshield cleaning. Wipers will operate in the presence of water sprayed on the windshield, and wipers may be damaged as a result. The switch should not be left in intermittent setting as the wipers will wipe the windshield once every time the engine is started. Dust that accumulates on the windshield might scratch the glass when wiping occurs on a dry windshield.

Getting started

Driving

Single wipe

- ▶ Press switch briefly in the direction of arrow 1.

The windshield wipers wipe one time without washer fluid.

Wiping with windshield washer fluid

- ▶ Push switch in the direction of arrow 1 past the resistance point.

The windshield wiper operates with washer fluid.

Information on filling up the washer reservoir can be found in the "Operation" section (▶ page 267).



If leaves, snow, etc. block the windshield wipers, switch off the wipers.

- For safety reasons, withdraw key from starter switch. Remove blockage.
- Turn the windshield wipers on again.

If windshield wipers fail to function at all in switch position I,

- Set the combination switch to the next highest wiper speed.
- Have the windshield wipers checked at the nearest authorized Mercedes-Benz Center.

Problems while driving

The engine runs erratically and misfires

- An ignition cable may be damaged.
 - The engine electronics may not be operating properly.
 - Unburned gasoline may have entered the catalytic converter and damaged it.
- ▶ Give very little gas.
 - ▶ Have the problem repaired by an authorized Mercedes-Benz Center as soon as possible.

The coolant temperature is over 248°F (120°C)

The coolant is too hot and is no longer cooling the engine.

- ▶ Stop the vehicle as soon as possible and turn off the engine. Allow engine and coolant to cool.
- ▶ Check the coolant level and add coolant if necessary (▷ page 264).

In case of accident

If the vehicle is leaking gasoline:

- ▶ Do not start the engine under any circumstances.
- ▶ Notify local fire and/or police authorities.

If the extent of the damage cannot be determined:

- ▶ Notify an authorized Mercedes-Benz Center.

If no damage can be determined on the

- major assemblies
 - fuel system
 - engine mount
- ▶ Start the engine in the usual manner.

Getting started

Parking and locking

Parking and locking

You have now completed your first drive. You have properly stopped and parked your vehicle. End your drive as follows.

Warning!



Wait until the vehicle is stationary before removing the key from the starter switch. The vehicle cannot be steered when the key is removed.

Warning!



With the engine not running, there is no power assistance for the brake and steering systems. In this case, it is important to keep in mind that a considerably higher degree of effort is necessary to stop or steer the vehicle.

Warning!



Do not park this vehicle in areas where combustible materials such as grass, hay or leaves can come into contact with the hot exhaust system, as these materials could be ignited and cause a vehicle fire.

To reduce the risk of personal injury as a result of vehicle movement, before turning off the engine and leaving the vehicle always:

- Keep right foot on brake pedal.
- Firmly depress parking brake pedal.
- Move the selector lever to position **P**.
- Slowly release brake pedal.
- When parked on an incline, turn front wheel towards the road curb.
- Turn the key to starter switch position **0** and remove, or press start-/ stop button (vehicles with KEYLESS-GO*).
- Take the key or the SmartKey with KEYLESS-GO* (if so equipped) and lock vehicle when leaving.

Parking brake

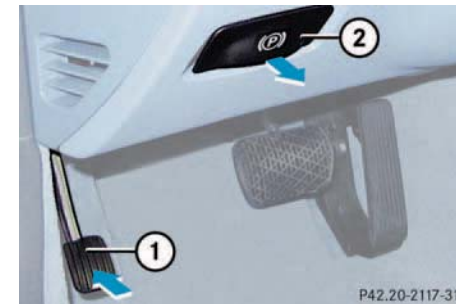

- 1** Parking brake
- 2** Release handle

- Step firmly on parking brake **1**.

When the engine is running, the indicator lamp **BRAKE** (USA only) or  (Canada only) in the instrument cluster will be illuminated.

Warning!



When leaving the vehicle always remove the key from the starter switch, take the Smart-Key with KEYLESS-GO* (if so equipped) with you and lock the vehicle. Do not leave children unattended in the vehicle, or with access to an unlocked vehicle. Children could release the parking brake and/or move the gear selector lever from position **P**, either of which could result in an accident or serious injury.

Warning!



Getting out of your vehicle with the selector lever not fully engaged in position **P** is dangerous. Also, when parked on an incline, position **P** alone may not prevent your vehicle from moving, possibly hitting people or objects.

Always set the parking brake in addition to shifting to position **P**.

When parked on an incline, turn front wheels towards the road curb.

Switching off headlamps

- ▶ Turn the switch to **0** (▷ page 46).

More information can be found in the "Controls in detail" section (▷ page 112).

Turning off the engine

- ▶ Place the gear selector lever in position **P**.



Always set the parking brake in addition to shifting to position **P**.

On steep slopes, turn the front wheels towards the curb.

Getting started

Parking and locking

Turning off with the key

- ▶ Turn the key in the starter switch to position **0** and remove it. The immobilizer is activated.
- ▶ Press the seat belt release button (▷ page 41).



The SmartKey or the SmartKey with KEYLESS-GO* (if so equipped) can only be removed from the starter switch with the gear selector lever in position **P**.



With the SmartKey removed and the driver's door open, a warning sounds if the vehicle's exterior lamps are not switched off.

Warning!



To prevent possible personal injury, always keep hands and fingers away from the door openings when closing the doors. Be especially careful when small children are around.

Before closing doors, ensure that there is no possibility of someone getting caught in a door during closing.

- ▶ After exiting the vehicle press the lock button  on the key (▷ page 30).

The locking knobs on the doors move down. The turn signal indicators light up briefly.

Warning!



When leaving the vehicle always remove the key from the starter switch and lock your vehicle. Do not leave children unattended in the vehicle, or with access to an unlocked vehicle. Unsupervised use of vehicle may cause serious personal injury.

More information can be found in the "Controls in detail" section (▷ page 86).

Turning off with KEYLESS-GO*

- ▶ Place the gear selector lever in **P**.
- ▶ Press the KEYLESS-GO start/stop button until the engine shuts off.

With the driver's door closed, the starter switch is now in position **1**. With the driver's door opened, the starter switch is set to position **0**, same as key removed from starter switch (▷ page 31).

- ▶ Press the seat belt release button (▷ page 41).



If you hear a warning signal you have either

- forgotten to turn off the lights, or
- not put the gear selector lever in **P** before opening the driver's door.

Turn off the lights or place the gear selector lever in **P**.

Warning!



To prevent possible personal injury, always keep hands and fingers away from the door openings when closing the doors. Be especially careful when small children are around.

Before closing doors, ensure that there is no possibility of someone getting caught in a door during closing.

Getting started

Parking and locking

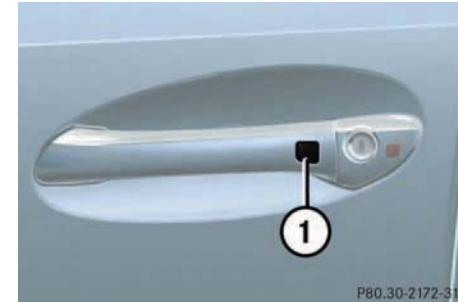

1 Lock button on the door handle

- ▶ After exiting the vehicle, press lock button **1** on the door handle or on the trunk lid.

The locking knobs on the doors move down. The turn signal indicators light up briefly

Getting started

Parking and locking

Warning!



When leaving the vehicle always remove the key from the starter switch, take the Smart-Key with KEYLESS-GO* (if so equipped) with you, and lock your vehicle. Do not leave children unattended in the vehicle, or with access to an unlocked vehicle. Unsupervised use of vehicle equipment may cause serious personal injury.

More information can be found in the "Controls in detail" section (▷ page 89).



Safety and Security

Occupant safety

Panic alarm

Driving safety systems

Anti-theft systems

Safety and Security

Occupant safety

In this section you will learn the most important facts about the restraint systems of the vehicle.

The restraint systems are

- Seat belts
- Emergency tensioning device
- Airbags
- Child seats
- Child seat recognition

As independent systems their protective effects work in conjunction with each other.



For information on infants and children traveling with you in the vehicle and restraint systems for infants and children, see "Children in the vehicle" (▷ page 65).

Occupant safety

The **SRS** warning lamp in the instrument cluster lights up for about 4 seconds when you turn the key in the starter switch to position **1** or **2** or press the KEYLESS-GO* (if so equipped) start/stop button once or twice. It goes out when you start the engine. This shows that the restraint systems are operational.

If the lamp does not come on at all or if it fails to extinguish after approximately 4 seconds or if it comes on thereafter, a malfunction in the system has been detected.

More information can be found in the "Practical hints" section (▷ page 290).

Warning!



In the event that the SRS malfunction indicator lamp lights up during driving or does not come at all, the SRS may not be operational. For your safety, we strongly recommend that you visit an authorized Mercedes-Benz Center immediately to have the system checked; otherwise the SRS may not be activated when needed in an accident, which could result in serious or fatal injury, or it might deploy unexpectedly and unnecessarily which could also result in injury.

Improper work on the restraint systems, including incorrect installation and removal, can lead to possible injury through an unintended activation of the SRS.

In addition, through improper work there is a risk of rendering the SRS inoperative or causing unintended airbag deployment. Work on the SRS must therefore only be performed by an authorized Mercedes-Benz Center.

Airbags

Warning!



Airbags are designed to reduce the potential of injury in certain frontal (front airbags) impacts, or side (side impact and head protection window curtain airbags) impacts which may cause significant injuries. However, no system available today can totally eliminate injuries and fatalities.

The activation of the SRS temporarily releases a small amount of dust from the airbags. This dust, however, is neither injurious to your health, nor does it indicate a fire in the vehicle. The dust might cause some temporary breathing difficulty for people with asthma or other breathing trouble. To avoid this, you may wish to get out of the vehicle as soon as it is safe to do so. If you have any breathing difficulty but cannot get out of the vehicle after the airbag inflates, then get fresh air by opening a window or door.

Warning!



To reduce the risk of injury when the front airbags inflate, it is very important for the driver and front passenger to always be in a properly seated position and to wear your seat belt.

For maximum protection in the event of a collision always be in normal seated position with your back against the backrest. Fasten your seat belt and ensure that it is properly positioned on your body.

Since the airbag inflates with considerable speed and force, a proper seating and hands on steering wheel position will help to keep you at a safe distance from the airbag. Occupants who are unbelted, out of position or too close to the airbag can be seriously injured by an airbag as it inflates with great force in the blink of an eye:

- Sit properly belted in an upright position with your back against the backrest.

- Adjust the driver seat as far as possible rearward, still permitting proper operation of vehicle controls. The distance from the center of the driver's breastbone to the center of the airbag cover on the steering wheel must be at least ten inches (25 cm) or more. You should be able to accomplish this by a combination of adjustments to the seat and steering wheel. If you have any problems, please see your authorized Mercedes-Benz Center.
- Do not lean with your head or chest close to the steering wheel or dashboard.
- Keep hands on the outside of steering wheel rim. Placing hands and arms inside the rim can increase the risk and potential severity of hand/arm injury when driver front airbag inflates.
- Adjust the front passenger seat as far as possible rearward from the dashboard when the seat is occupied.

Safety and Security

Occupant safety

- Occupants, especially children, should never lean their heads in the area of the door where the side airbag inflates. This could result in serious injuries or death should the airbag be triggered. Always sit upright, properly use the seat belts and appropriate size infant or child restraint system.
- Children 12 years old and under must never ride in the front seat, except in a Mercedes-Benz authorized BabySmart™ compatible child seat, which operates with the BabySmart™ system installed in the vehicle to deactivate the passenger front airbag when it is properly installed. Otherwise they will be struck by the airbag when it inflates in a crash. If this happens, serious or fatal injury will result.

Failure to follow these instructions can result in severe injuries to you or other occupants.

If you sell your vehicle you are responsible to make the buyer aware of these points. Be sure to give the buyer this Operator's Manual.

Warning!



Accident research shows that the safest place for children in an automobile is in the rear seat. Should you choose to place a child 12 years old or under in the front passenger seat of your vehicle, you must properly use a BabySmart™ child restraint which will turn off the passenger front airbag. BabySmart™ will not, however, turn off any side impact airbag.

It should be noted that with respect to both front and rear side impact airbags there is a possibility for a side airbag related injury if occupants, especially children, are not properly seated or restrained when next to a side airbag which needs to deploy rapidly in a side impact in order to do its job.

To help avoid the possibility of injury, please follow these guidelines:

- (1) Occupants, especially children, should never place their bodies or lean their heads in the area of the door where the side airbag inflates. This could

result in serious injuries or death should the side airbag be activated.

- (2) Always sit upright, properly use the seat belts and use an appropriately sized infant or child restraint system for all children 12 years old or under.
- (3) Always wear seat belts properly.

If you believe that, even with the use of these guidelines, it would be safer for your rear seat occupants to have the rear mounted side airbags deactivated, then deactivation can be accomplished upon your written request to do so at your authorized Mercedes-Benz Center at an additional cost.

Please contact your local authorized Mercedes-Benz Center or call our Customer Assistance Center at 1-800-FOR-MERCEdes (1-800-367-6372) for details.



Airbags are designed to activate only in certain frontal impacts (front air bags), side impacts (side impact and head protection window curtain airbags) which exceed preset thresholds and in rollovers (head protection window curtain airbags). Only during these events will they provide their supplemental protection.

The driver and passengers should always wear their seat belts. Otherwise it is not possible for airbags to provide their supplemental protection.

In case of other types of impacts and impacts below air bag deployment thresholds, airbags will not be activated. The driver and passenger will then be protected to the extent possible by a properly fastened seat belt. A properly fastened seat belt is also needed to provide the best possible protection in a rollover.

We caution you not to rely on the presence of the airbags in order to avoid wearing your seat belt.

Your vehicle was originally equipped with airbags that are designed to activate in certain impacts exceeding a preset threshold to reduce the potential and severity of injury. It is important to your safety and that of your passengers that you replace deployed airbags and repair any malfunctioning airbags to ensure that the vehicle will continue to provide supplemental crash protection for occupants.

Safety guidelines for the seat belt, emergency tensioning device and airbag

Warning!



- Damaged seat belts or belts that were highly stressed in an accident must be replaced and their anchoring points must also be checked. Use only belts installed or supplied by an authorized Mercedes-Benz Center.
- Airbags and ETDs are designed to function on a one-time-only basis. An airbag

Safety and Security

Occupant safety

or emergency tensioning device (ETD) that was activated must be replaced.

- No modifications of any kind may be made to any components or wiring of the SRS. This includes changing or removing any component or part of the SRS, the installation of additional trim material, badges etc. over the steering wheel hub, front passenger airbag cover, door trim panels, or door frame trims, and installation of additional electrical/electronic equipment on or near SRS components and wiring. Keep area between airbags and occupants free from objects (e.g. packages, purses, umbrellas, etc.).
- Do not pass belts over sharp edges. They could tear.
- Do not make any modification that could change the effectiveness of the belts.
- Do not hang items such as coat hangers from the coat hooks or handles over the door. These items may turn into projectiles and cause head and other injuries when curtain airbag is deployed.

- An airbag system component within the steering wheel gets hot after the airbag has inflated. Do not touch.
- Improper work on the system, including incorrect installation and removal, can lead to possible injury through an unintended activation of the SRS.
- In addition, through improper work there is a risk of rendering the SRS inoperative or causing unintended airbag deployment. Work on the SRS must therefore only be performed by an authorized Mercedes-Benz Center.
- For your protection and the protection of others, when scrapping the airbag unit or emergency tensioning device, our safety instructions must be followed. These instructions are available from your authorized Mercedes-Benz Center.
- Given the considerable deployment speed and the textile structure of the airbags, there is the possibility of abrasions or other injuries resulting from airbag deployment.

When you sell your vehicle we strongly urge you to give notice to the subsequent owner that it is equipped with an SRS by alerting them to the applicable section in the Operator's Manual.

Front airbags



- 1 Driver airbag
- 2 Passenger airbag

Driver and passenger airbags are deployed:

- in the event of a frontal impact
- if impact exceeds a preset deployment threshold

- independently of the side impact airbags

The airbags will not deploy in impacts which do not exceed the system's deployment thresholds. You will then be protected by the fastened seat belts.

The front passenger airbag will only be deployed if:

- the front passenger seat is occupied
- the PASSENGER AIRBAG OFF indicator lamp in the center console is not lit (▷ page 67)



Do not place objects heavier than 20 lbs (9 kg) on the front passenger seat. This could cause the front or side impact airbag on the front passenger side to deploy in a crash which exceeds the system's deployment threshold.

Side impact airbags, window curtain airbags

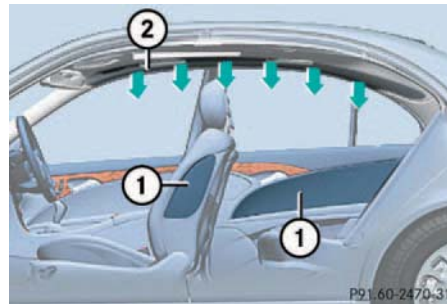

- 1 Side impact airbags
- 2 Window curtain airbag

The side impact airbags and window curtain airbags are deployed:

- on the impacted side of the vehicle
- in impacts exceeding a preset deployment threshold
- independently of the front airbags

The front passenger side airbag will only deploy if the system senses that the front passenger seat is occupied.

The side impact airbags are not deployed in impacts which do not exceed the system's deployment threshold.

Seat belts

The seat belt nonusage warning lamp  in the instrument cluster lights up and a warning sounds for a short time when you turn the key in the starter switch to position **2** or press the KEYLESS-GO* (if so equipped) start/stop button twice and the driver's seat belt is not fastened.

After starting the engine the seat belt nonusage warning lamp blinks for a brief period to remind the driver and passengers to fasten the seat belts.

The use of seat belts and infant and child restraint systems is required by law in most states and all Canadian provinces. Even where this is not the case, all vehicle occupants should have their seat belts fastened whenever the vehicle is in motion.

Safety and Security

Occupant safety

Information on fastening seat belts is found in the "Getting started" section (▷ page 40).



For information on infants and children traveling with you in the vehicle and restraint systems for infants and children, see "Children in the vehicle" (▷ page 65).

Warning!



Always fasten your seat belt before driving off. Always make sure your passengers are properly restrained, even those sitting in the rear and pregnant women.

Failure to wear and properly fasten and position your seat belt greatly increases your risk of injuries and their likely severity in an accident. You and your passengers should always wear seat belts.

If you are ever in an accident, your injuries can be considerably more severe without your seat belt properly buckled. Without your seat belt buckled, you are much more likely to hit the interior of the vehicle or be ejected from it. You can be seriously injured or killed.

In the same crash, the possibility of injury or death is lessened if you are properly wearing your seat belt. Airbags can only protect as they are designed if the occupants are properly wearing their seat belts.

Warning!



Never ride in a moving vehicle with the backrest reclined. Sitting in an excessively reclined position can be dangerous. You could slide under the seat belt in a collision. If you slide under it, the belt would apply force at the abdomen or neck. That could cause serious or even fatal injuries. The backrest and seat belt provide the best restraint when the wearer is in an upright position and the belt is properly positioned on the body.

Warning!



Never let more people ride in the vehicle than there are seat belts available. Be sure everyone riding in the vehicle is correctly restrained with a separate seat belt.

Warning!



Damaged seat belts or belts that were highly stressed in an accident must be replaced and their anchoring points must also be checked.

Only use seat belts which have been approved by Mercedes-Benz.

Do not make any modifications to the seat belts. This can lead to unintended activation or to failure.

Have all work carried out only by an authorized Mercedes-Benz Center.

Warning!



USE SEAT BELTS PROPERLY

- Seat belts can only work when used properly. Never wear seat belts in any other way than as described in this section, as that could result in serious injuries in case of an accident.
- Each occupant should wear their seat belt at all times, because seat belts help reduce the likelihood of and potential severity of injuries in accidents, including rollovers. The integrated restraint system includes SRS (driver airbag, front passenger airbag, side impact airbags, head protection window curtain airbags for side windows), ETD (seat belt emergency tensioning device), and front seat knee bolsters. The system is designed to enhance the protection offered to properly belted occupants in certain frontal (front airbags) and side (side impact and window curtain airbags) impacts which exceed preset deployment thresholds.

- Never wear the shoulder belt under your arm, against your neck or off your shoulder. In a crash, your body would move too far forward. That would increase the chance of head and neck injuries. The belt would also apply too much force to the ribs or abdomen, which could severely injure internal organs such as your liver or spleen.
- Never wear belts over rigid or breakable objects in or on your clothing, such as eyeglasses, pens, keys etc., as these might cause injuries.
- Position the lap belt as low as possible on your hips and not across the abdomen. If the belt is positioned across your abdomen, it could cause serious injuries in a crash.

Safety and Security

Occupant safety

- Each seat belt should never be used for more than one person at a time. Do not fasten a seat belt around a person and another person or other objects.
- Belts should not be worn twisted. In a crash, you wouldn't have the full width of the belt to manage impact forces. The twisted belt against your body could cause injuries.
- Pregnant women should also use a lap-shoulder belt. The lap belt portion should be positioned as low as possible on the hips to avoid any possible pressure on the abdomen.
- Never place your feet on the instrument panel or on the seat. Always keep both feet on the floor in front of the seat.

Emergency tensioning device (ETD), seat belt force limiter

The seat belts for the front and rear outer seats are equipped with emergency tensioning devices and belt force limiters.

The ETD is designed to activate in the following cases when the seat belts are fastened:

- In frontal or rear-end impacts exceeding a preset severity level
- If the ignition is switched on

In an impact, emergency tensioning devices remove slack from the belts in such a way that the seat belts fit more snugly against the body. Belt force limiters reduce the force exerted by the seat belts on occupants during a crash.

Warning!



An emergency tensioning device (ETD) that was activated must be replaced.

When scrapping the emergency tensioning device, our safety instructions must be followed. These are available at your authorized Mercedes-Benz Center.



Do not place objects heavier than 20 lbs (9 kg) on the front passenger seat. This could cause the front or side impact airbag on the front passenger side to deploy in a crash which exceeds the system's deployment threshold.

Automatic comfort-fit feature seat belt

An automatic comfort-fit feature for front seats reduces the retracting force of the seat belts when they are in normal use.

Children in the vehicle

If an infant or child is traveling with you in the vehicle:

- Secure the child using an infant or child restraint appropriate to the age and size of the child and recommended for use by Mercedes-Benz.
- Ensure that the infant or child is properly secured by a belt at all times while the vehicle is in motion.

Infant and child restraint seats and information on choosing an appropriate restraint system can be obtained from any Mercedes-Benz Center.

Infant and child restraint systems

Use only a BabySmart™ compatible child restraint for the front passenger seat in this vehicle.

We recommend all infants and children be properly restrained at all times while the vehicle is in motion.

All lap-shoulder belts except the driver's seat belt have special seat belt retractors for secure fastening of child restraints.

To fasten a child restraint, follow child restraint instructions for mounting. Then pull the shoulder belt out completely and let it retract. During seat belt retraction, a ratcheting sound can be heard to indicate that the special seat belt retractor is activated. The belt is now locked. Push down on child restraint to take up any slack.

To deactivate, release seat belt buckle and let seat belt retract completely. The seat belt can again be used in the usual manner.



Information on child seats with mounting fittings for tether anchorages (> page 69).

For information on LATCH-type child seat mounts (> page 70).

BabySmart™ is a trademark of Siemens Automotive Corp.

Safety and Security

Occupant safety

Warning!



Never release the seat belt buckle while the vehicle is in motion, since the special seat belt retractor will be deactivated.



The use of infant or child restraints is required by law in all 50 states, the District of Columbia, the U.S. territories and all Canadian provinces.

Infants and small children should be seated in an appropriate infant or child restraint system properly secured by a lap-shoulder belt or, if so equipped, a child restraint lower anchorage system that complies with U.S. Federal Motor Vehicle Safety Standards 213 and 225 and Canadian Motor Vehicle Safety Standard 213.

A statement by the child restraint manufacturer of compliance with this standard can be found on the instruction label on the restraint and in the instruction manual provided with the restraint.

When using any infant or child restraint system, be sure to carefully read and follow all manufacturer's instructions for installation and use.

Please read and observe warning labels affixed to the inside of the vehicle and to infant or child restraints.

Warning!



Children 12 years old and under must never ride in the front seat, except in a Mercedes-Benz authorized BabySmart™ compatible child seat, which operates with the BabySmart™ system installed in the vehicle to deactivate the passenger front airbag when it is properly installed. Otherwise they will be struck by the airbag when it inflates in a crash. If this happens, serious or fatal injury will result.

According to accident statistics, children are safer when properly restrained in the rear seating positions than in the front seating positions. Infants and small children must ride in back seats and be seated in an appropriate infant or child restraint system, which is properly secured with the vehicle's seat belt, fully in accordance with the child seat manufacturer's instructions.

Safety and Security

Occupant safety

Infants and small children should never share a seat belt with another occupant. During an accident, they could be crushed between the occupant and seat belt.

A child's risk of serious or fatal injuries is significantly increased if the child restraints are not properly secured in the vehicle and the child is not properly secured in the child restraint.

Children too big for child restraint systems must ride in back seats using regular seat belts. Position shoulder belt across chest and shoulder, not face or neck. A booster seat may be necessary to achieve proper belt positioning for children from 41 lbs. to the point where a lap/shoulder belt fits properly without one.

When the child restraint is not in use, remove it from the vehicle or secure it with the seat belt to prevent the child restraint from becoming a projectile in the event of an accident.

Do not leave children unattended in the vehicle, even if the children are secured in a child restraint system. Unsupervised children in a child restraint system may use vehicle equipment and may cause serious personal injury.

BabySmart™ airbag deactivation system

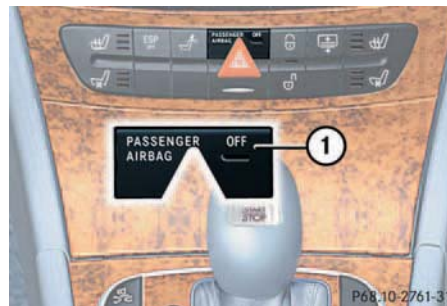

1 Indicator lamp

Special BabySmart™ compatible child seats, designed for use with the Mercedes-Benz system and available at any authorized Mercedes-Benz Center are required for use with the BabySmart™ airbag deactivation system. With the special child seat properly installed, the passenger front airbag will not deploy.

The PASSENGER AIRBAG OFF indicator lamp **1** located in the center console will be illuminated, except with the key removed or in starter switch position **0**.



The system does not deactivate the side impact airbag.

BabySmart™ is a trademark of Siemens Automotive Corp.

Safety and Security

Occupant safety

Self-test BabySmart™ without special child seat installed

After turning the key in the starter switch to position **1** or **2** or pressing the KEYLESS-GO* (if so equipped) start/stop button once or twice, PASSENGER AIRBAG OFF indicator lamp **1** located in the center console lights up for approx. 6 seconds and then goes out.

If the indicator lamp should not come on or is continuously lit, the system is not functioning. You must see an authorized Mercedes-Benz Center before seating any child on the passenger seat.

More information can be found in the "Practical hints" section (▷ page 294).

Warning!



The BabySmart™ airbag deactivation system will ONLY work with a special child seat designed to operate with it. It will not work with child seats which are not BabySmart™ compatible.

Never place anything between seat cushion and child seat (e.g. pillow), since it reduces the effectiveness of the deactivation system. The bottom of the child seat must make full contact with the passenger seat cushion. An incorrectly mounted child seat could cause injuries to the child in case of an accident, instead of protecting the child.

Follow the manufacturer's instructions for installation of special child seats.

Warning!



When using a BabySmart™ compatible child seat on the front passenger seat, the front passenger airbag will not deploy only if the PASSENGER AIRBAG OFF indicator lamp remains illuminated.

Please be sure to check the indicator every time you use the special system child seat. Should the light go out while the restraint is installed, please check installation. If the light remains out, do not use the BabySmart™ restraint to transport children on the front passenger seat until the system has been repaired.

Warning!



Do not place powered-on laptops, cell phones and like electronic devices on the front passenger seat. Signals from such devices may interfere with the BabySmart™ system. Such signal interference may cause the PASSENGER AIRBAG OFF indicator lamp not to come on during self-test or be continuously lit, indicating that the system is not functioning.

Installation of infant and child restraint systems

This vehicle is equipped with tether anchorages for a top tether strap at each of the rear seating positions.



For safety, make sure that the hook **2** has attached to the ring **3** beyond the safety catch.

Not foldable rear seat backrest

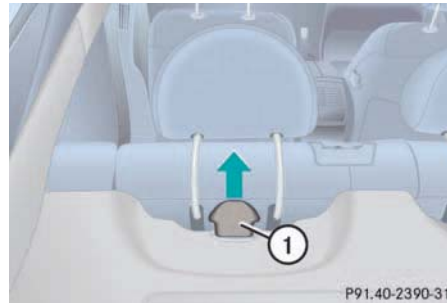

Vehicles without foldable rear seat backrests

- ▶ Remove cover **1** from anchorage ring.
- ▶ Guide tether strap between head restraints.
- ▶ Securely fasten the hook **2** to the anchorage ring **3**.

Foldable rear seat backrest*

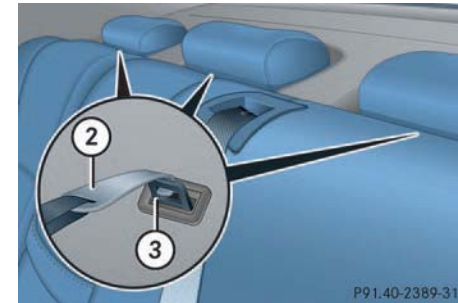

Vehicles with foldable rear seat backrests

- ▶ Fold rear seat backrest slightly forward.
- ▶ Guide tether strap between head restraints.
- ▶ Securely fasten the hook **2** to the anchorage ring **3**.
- ▶ Swing rear seat backrest to the rear until it engages.
- ▶ Check the rear seat backrest to be locked in its upright position (▷ page 302).

Safety and Security

Occupant safety

Child seat anchors - "LATCH" type

This vehicle is equipped with two LATCH (Lower Anchors and Tethers for Children) type anchors (at each of the outer rear seats) for the installing of a "LATCH" child seat with the matching anchor fittings.

The anchors are located behind an upholstery blend.

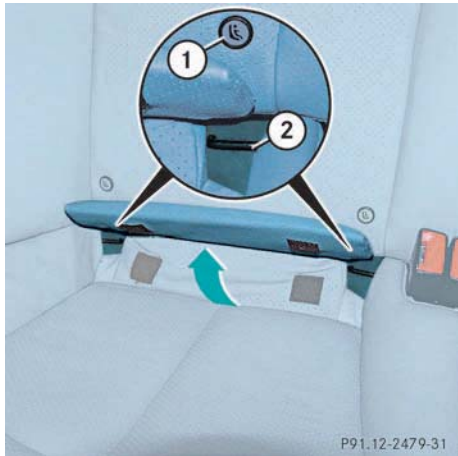

- 1 Indicates the position of the anchors
- 2 Anchors

- ▶ Install child seat according to the manufacturer's instructions.



Make sure that the seat belt for the center seat can operate freely with a child seat installed.



Non-"LATCH" type child seats may also be used and can be installed using the vehicle's seat belt system. Install child seat according to the manufacturer's instructions.

Warning!



Children too big for child restraint systems must ride in back seats using regular seat belts. Position shoulder belt across chest and shoulder, not face or neck. A booster seat may be necessary to achieve proper belt positioning for children from 41 lbs. to

the point where a lap/shoulder belt fits properly without one.

Install child seat according to manufacturer's instructions.

The child seat must be firmly attached in the right and left side anchors **2**.

An incorrectly mounted child seat may come loose during an accident which could result in serious injury or death to your child.

Damaged or impact damaged child seats or child seat mounting fittings must be replaced.

Do not leave children unattended in the vehicle, even if the children are secured in a child restraint system.

Blocking of rear door window operation



- 1 Override switch
- 2 Indicator lamp

- ▶ Press override switch **1**.

Indicator lamp **2** lights up. The rear door windows can no longer be operated using the switches located in the rear doors.



Operation of the rear door windows with the switches located on the door control panel of the driver's door is still possible.

Warning!



Activate the override switch when children are riding in the back seats of the vehicle. The children may otherwise injure themselves, e.g. by becoming trapped in the window opening.

When leaving the vehicle, always remove the key from the starter switch, and lock the vehicle. Do not leave children unattended in the vehicle, or with access to an unlocked vehicle. Unsupervised use of vehicle equipment can cause serious personal injury.

For more information on power windows, see the "Controls in detail" section (▶ page 184).

Safety and Security

Panic alarm

Panic alarm

An audible alarm and blinking exterior lamps will operate for approximately 2½ minutes.

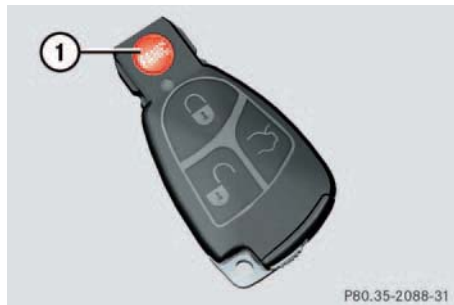

1 **PANIC** button

Activating

- ▶ Press and hold button **1** for at least one second.

Deactivating

- ▶ Press button **1** again.
- or
- ▶ Insert key in starter switch.

i

For operation in the USA only: This device complies with Part 15 of the FCC Rules. Operation is subject to the following two conditions:

- (1) This device may not cause harmful interference, and
- (2) this device must accept any interference received, including interference that may cause undesired operation.

Any unauthorized modification to this device could void the user's authority to operate the equipment.

Driving safety systems

In this section you will find information on the following driving safety systems:

- ABS (Antilock Brake System)
- BAS (Brake Assist System)
- ESP (Electronic Stability Program)
- SBC (Sensotronic Brake Control)



In winter operation, the maximum effectiveness of the ABS and the ESP is only achieved with winter tires (M+S tires), or snow chains as required.

Warning!



The following factors increase the risk of accidents:

- Excessive speed, especially in turns
- Wet and slippery road surfaces
- Following another vehicle too closely

The ABS, BAS, ESP and SBC cannot reduce this risk.

Always adjust your driving style to the prevailing road and weather conditions.

ABS

Warning!



Do not pump the brake pedal. Use firm, steady brake pedal pressure instead. Pumping the brake pedal defeats the purpose of the ABS and significantly reduces braking effectiveness.

The ABS regulates the brake pressure so that the wheels do not lock during braking. This allows you to maintain the ability to steer your vehicle.

The ABS is functional above a speed of approximately 5 mph (8 km/h) independent of road surface conditions.

On slippery road surfaces, the ABS will respond even with light brake pressure.

If the ABS activates during braking, the ESP warning lamp  in the instrument cluster dial flashes. Because of the SBC brake system, you will not feel any pulsation in the brake pedal.

Safety and Security

Driving safety systems

Continuous steady brake pedal pressure yields the advantages provided by the ABS, namely braking power and ability to steer the vehicle.



To alert following vehicles to slippery road conditions you discover, operate your hazard warning flashers as appropriate.

The  warning lamp in the instrument cluster lights up when you turn the key in the starter switch to position **2** or press the KEYLESS-GO* (if so equipped) start/stop button twice. It goes out when the engine is running.

Warning!



The ABS cannot prevent the natural laws of physics from acting on the vehicle, nor can it increase braking or steering efficiency beyond that afforded by the condition of the vehicle brakes and tires or the traction. The ABS cannot prevent accidents, including those resulting from excessive speed in turns, following another vehicle too closely, or aquaplaning. Only a safe, attentive, and skillful driver can prevent accidents. The capabilities of an ABS equipped vehicle must never be exploited in a reckless or dangerous manner which could jeopardize the user's safety or the safety of others.

More information can be found in the "Practical hints" section (▷ page 289).

BAS

The Brake Assist System (BAS) operates in emergency situations. If you apply the brakes very quickly, the BAS automatically provides full brake boost, thereby potentially reducing the braking distance. Apply continuous full braking pressure until the emergency braking situation is over. The ABS will prevent the wheels from locking.

When you release the brake pedal, the brakes function again as normal. The BAS is then deactivated.

Safety and Security

Driving safety systems

Warning!





The BAS cannot prevent the natural laws of physics from acting on the vehicle, nor can it increase braking efficiency beyond that afforded by the condition of the vehicle brakes and tires or the traction. The BAS cannot prevent accidents, including those resulting from excessive speed in turns, following another vehicle too closely, or aquaplaning. Only a safe, attentive, and skillful driver can prevent accidents. The capabilities of a BAS equipped vehicle must never be exploited in a reckless or dangerous manner which could jeopardize the user's safety or the safety of others.

ESP

The Electronic Stability Program (ESP) monitors the vehicle's traction (force of adhesive friction between the tires and the road surface) and handling.

The ESP recognizes when a wheel is spinning or if the vehicle starts to skid. By applying brakes to the appropriate wheel and by limiting engine output, the ESP works to stabilize the vehicle. The ESP is especially useful during take-off and on wet or slippery road surfaces.

The ESP warning lamp  in the instrument cluster flashes when the ESP is engaged.

The ESP warning lamp  in the instrument cluster lights up when you turn the key in the starter switch to position **2** or press the KEYLESS-GO* (if so equipped) start/stop button twice. It goes out when the engine is running.

Warning!



Never switch off the ESP when you see the ESP warning lamp  flashing in the instrument cluster. In this case proceed as follows:

- While driving off, apply as little throttle as possible
- While driving ease up on the accelerator
- Adapt your speed and driving style to the prevailing road conditions

Failure to observe these guidelines could cause the vehicle to skid.

The ESP cannot prevent accidents resulting from excessive speed.

Safety and Security

Driving safety systems

Warning!



The ESP cannot prevent the natural laws of physics from acting on the vehicle, nor can it increase the traction afforded. The ESP cannot prevent accidents, including those resulting from excessive speed in turns, or aquaplaning. Only a safe, attentive, and skillful driver can prevent accidents. The capabilities of an ESP equipped vehicle must never be exploited in a reckless or dangerous manner which could jeopardize the user's safety or the safety of others.



Because of the ESP's automatic operation, the engine must be shut off (key in starter switch position **0** or **1**) when:

- the parking brake is being tested on a brake test dynamometer
- the vehicle is being towed with the front axle raised

Active braking action through the ESP may otherwise seriously damage the rear axle brake system.

The ESP will only function properly if you use wheels of the recommended tire size.

More information can be found in the "Practical hints" section (> page 288).

Switching off the ESP

Warning!



The ESP should not be switched off during normal driving other than in the circumstances described below. Disabling of the system will reduce vehicle stability in standard driving maneuvers.

To improve the vehicle's traction, turn off the ESP in driving situations where it would be advantageous to have wheels cut into surfaces for better grip such as:

- starting out on slippery surfaces and in deep snow in conjunction with snow chains
- in sand or gravel

The switch is located on the center console.



1 ESP off/on

- ▶ Press button 1.

The ESP warning lamp , located in the instrument cluster comes on.

Some functions of the ESP remain active, even when the button is in the OFF position.

The ESP warning lamp  in the instrument cluster starts to flash at any speed as soon as the tires lose traction.



Avoid spinning of one drive wheel for an extended period with the ESP switched off. This may cause serious damage to the drive train which is not covered by the Mercedes-Benz Limited Warranty.

Warning!



When the ESP warning lamp  is illuminated continuously, the ESP is switched off.

Adapt your speed and driving to the prevailing road conditions and to the non-operating status of the ESP.

Switching on the ESP

- ▶ Press button 1.

The ESP warning lamp  in the instrument cluster goes out. You are now again in normal driving mode.

The SBC brake system

The SBC brake system combines a hydraulic brake circuit with electronically controlled brake servo assistance. You have increased braking safety and improved braking comfort.

Warning!



Never ignore a brake malfunction indicated in the speedometer display, for example by the **BRAKE** (USA only) or  (Canada only) indicator lamp. Refer to the "Practical hints" section (▷ page 291). Also read and observe the messages in the instrument cluster display (▷ page 295).

Safety and Security

Driving safety systems

Warning!



The SBC brake system requires electrical power to operate.

A malfunction in the vehicle's power supply or electrical system may impair brake system operation and switch it into its limp-home (emergency operation) mode. In such a case, the red brake warning lamp (▷ page 291) and warning messages in the instrument cluster (▷ page 305) light up while driving. To brake, the driver must then apply significantly greater brake pedal pressure and depress the pedal much further to obtain the expected braking effect. If necessary, apply full pressure to the brake pedal. Brakes are only applied to the front wheels. Stopping distance is increased!

If there is a malfunction in the SBC brake system, we recommend that the vehicle be transported with all wheels off the ground using flatbed or appropriate wheel lift/dolly equipment. A tow bar must be used if circumstances do not permit the use of the recommended towing methods and the vehicle requires towing with all four wheels on the ground. Towing the vehicle with all four wheels on the ground is only permissible for distances up to 30 miles (50 km) and at a speed not to exceed 30 mph (50 km/h). For more information, refer to "Towing the vehicle" (▷ page 348).

The SBC brake system is automatically activated when you:

- unlock the vehicle with the key or the KEYLESS-GO*
- open the driver's or passenger door
- turn the key in the starter switch to position **1**
- in vehicles with KEYLESS-GO*, press start/stop button on selector lever once
- depress the brake pedal
- release the parking brake



If the SBC brake system is activated when the brake pedal is first depressed, you may feel a reduced pedal resistance and longer pedal travel than normal. When releasing the pedal, you may also feel the brake pedal pulsate and you may hear a sound which is caused by the activation of the SBC pump. This is normal and not an indication of a malfunction. Pedal travel returns to normal when you release the brake pedal and the sound soon ceases.

Warning!



Have brake pad replacement and other work on the SBC brake system carried out by qualified technicians only. Contact your authorized Mercedes-Benz Center for further information. The SBC brake system must be deactivated prior to working on the system. High pressure is intermittently built up in the system as part of its automatic self-test. In addition, the system is automatically activated when the vehicle is unlocked by remote control, when the driver or passenger door is opened, when the key in the starter switch is turned to position **1**, when the brake pedal is depressed or when the parking brake is released. Failure to deactivate the system prior to maintenance will cause brake pistons to extend and brake fluid to leak, which may result in injuries (contusions and acid burns). Extended brake pistons may also cause injury.

Safety and Security

Driving safety systems

The SBC brake servo assistance switches off automatically when you:

- turn the key in the starter switch to position **0** or remove the key (after approximately two minutes)
- lock the vehicle with the SmartKey from outside (after approximately 20 seconds)

Note on driving with the SBC

- Following extended periods of only minor loads to your brake system, you should occasionally apply the brakes when traveling at high speeds. This improves the grip of the brake pads.

Warning!



Be very careful not to endanger other road users when you apply the brakes.

Safety and Security

Driving safety systems

- After driving on wet or snow-covered roads, you should apply your brakes firmly before parking your vehicle. This produces heat which serves to dry the brake disks and help prevent corrosion.
- On long and steep grades, shift to a lower gear (gear range **1, 2** or **3**) to prevent the brakes from overheating and to reduce brake wear.
- After hard braking, it is advisable to drive on for some time so that the air stream will cool down the brakes faster.
- Only Mercedes-Benz approved components (e.g. brake pads) should be installed on your vehicle. Brake pads not approved by Mercedes-Benz may impair the safety of your vehicle.

Anti-theft systems

Immobilizer

The immobilizer prevents unauthorized persons from starting your vehicle.

Activating

- With the key: Removing the key from the starter switch activates the immobilizer.
- With KEYLESS-GO*: Turning off the engine by means of the KEYLESS-GO start/stop button on the gear selector lever activates the immobilizer.

Deactivating

- With the key: Inserting the key in the starter switch deactivates the immobilizer.
- With KEYLESS-GO*: Starting the engine by means of the KEYLESS-GO start/stop button on the gear selector lever deactivates the immobilizer.



In case the engine cannot be started (yet the vehicle's battery is charged), the system is not operational. Contact an authorized Mercedes-Benz Center or call 1-800-FOR-MERCEdes (in the USA), or 1-800-387-0100 (in Canada).

Safety and Security

Anti-theft systems

Anti-theft alarm system

Once the alarm system has been armed, a visual and audible alarm is triggered when someone opens

- a door
- the trunk
- the hood.

The alarm system will also be triggered when

- someone attempts to raise the vehicle
- the vehicle is opened with the mechanical key



If the alarm stays on for more than 20 seconds, an emergency call is initiated automatically by the Tele Aid system* (▷ page 234), provided that the Tele Aid service was subscribed to and properly activated.

Arming the alarm system



The alarm system is armed within approx. 10 seconds after locking the vehicle. The indicator lamp in the button for the tow-away alarm will then blink.

Disarming the alarm system

The alarm system is disarmed when you unlock your vehicle with the remote control or KEYLESS-GO*.

Canceling the alarm

With the key

- ▶ Insert the key in the starter switch.
- or
- ▶ Press the  or  button on the key.

*With KEYLESS-GO**

- ▶ Grasp the outside door handle.
- or
- ▶ Press the KEYLESS-GO* start/stop button.

Tow-away alarm

Once the tow-away alarm is armed, a visual and audible alarm will be triggered when someone attempts to raise the vehicle.



The tow-away protection alarm is triggered, for example, if the vehicle is lifted on one side.

If the alarm stays on for more than 20 seconds, an emergency call is initiated automatically by the Tele Aid system* (▷ page 234), provided that the Tele Aid service was subscribed to and properly activated, and that necessary cellular service and GPS coverage are available.

Safety and Security

Anti-theft systems

Arming the tow-away alarm

When you lock your vehicle, the tow-away alarm is automatically armed after about 30 seconds.

When you unlock your vehicle, the tow-away protection disarms automatically.

Disarming the tow-away alarm

To prevent triggering the tow-away alarm feature, switch off the tow-away alarm before towing the vehicle, or when parking on a surface subject to movement, such as a ferry or auto train.

The button is located on the overhead control panel.



1 Tow-away alarm off button

- ▶ Turn off the ignition and remove the key.



You cannot disarm the tow-away alarm if the ignition is turned on.

- ▶ Press button 1.

The indicator lamp in the button lights up briefly.



- ▶ Lock your vehicle with the key or (vehicles with KEYLESS-GO*) the lock button at each door handle.

The tow-away alarm remains disarmed until you lock your vehicle again.

Canceling the alarm

- ▶ Insert the key in the starter switch.

or

- ▶ Press the  or  button on the key.





Controls in detail

Locking and unlocking

Seats

Memory function

Lighting

Instrument cluster

Control system

Automatic transmission

Good visibility

Climate control

Automatic climate control*

Power windows

Sliding/pop-up roof*

Panorama sliding/pop-up roof*

Driving systems

Loading

Useful features

Controls in detail

Locking and unlocking

In the "Controls in detail" section you will find detailed information on how to operate the equipment installed on your vehicle. If you are already familiar with the basic functions of your vehicle, this section will be of particular interest to you.

To quickly familiarize yourself with the basic functions of the vehicle, refer to the "Getting started" section of this manual. The corresponding page numbers are given at the beginning of each segment.

Locking and unlocking

Keys

Your vehicle comes supplied with two SmartKeys with remote controls and a removable mechanical key. The locking tabs for the mechanical key portion of the two keys are a different color to help distinguish each key unit.

The SmartKey provides an extended operating range. To prevent theft, however, it is advisable to only unlock the vehicle when you are in close proximity to it.

The Smartkey centrally locks and unlocks

- the doors
- the trunk
- the fuel filler flap



You can also open and close the power windows (▷ page 184) and sliding/pop-up roof* (▷ page 187) or panorama sliding/pop-up roof* (▷ page 192) using the SmartKey.

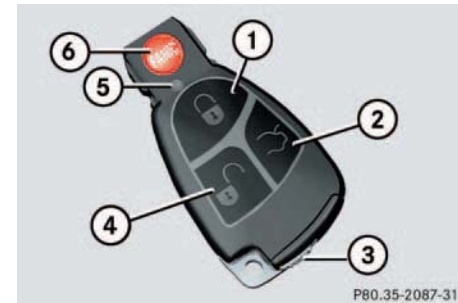

SmartKey with remote controls

- 1 Lock button
- 2 Unlock button for the trunk lid
- 3 Mechanical key locking tab
- 4 Unlock button
- 5 Battery check lamp
- 6 PANIC button (▷ page 72).



To prevent possible malfunction, avoid exposing the key to high levels of electromagnetic radiation.

Factory setting

Global unlocking

- ▶ Press button .

All turn signal lamps blink once. The locking knobs in the doors move up.

The vehicle will lock again automatically within approximately 40 seconds of unlocking if neither door nor trunk is opened, the SmartKey is not inserted in the starter switch, or the central locking switch is not activated.



Global locking

- ▶ Press button .

All turn signal lamps blink three times. The locking knobs in the doors move down.

Selective setting

If you frequently travel alone, you may wish to reprogram the key so that pressing  only unlocks the driver's door and the fuel filler flap.

- ▶ Press and hold buttons  and  simultaneously for about five seconds until battery check lamp **5** blinks twice.

The key will then function as follows:

Unlocking driver's door and fuel filler flap

- ▶ Press button  once.

Global unlocking

- ▶ Press button  twice.



Global locking

- ▶ Press button .

Controls in detail

Locking and unlocking

Restoring to factory setting

- ▶ Press and hold buttons  and  simultaneously for about six seconds until battery check lamp **5** blinks twice.

Warning!



When leaving the vehicle always remove the key from the starter switch, take the SmartKey with KEYLESS-GO (if so equipped) with you and lock the vehicle. Do not leave children unattended in the vehicle, or with access to an unlocked vehicle. It is possible for children to open a locked door from the inside, which could result in an accident or serious injury.

Controls in detail

Locking and unlocking



If you can no longer lock or unlock the vehicle with the key, then either the batteries in the SmartKey are discharged or the key is malfunctioning.

- Check the batteries in the key (▷ page 88) and replace them if necessary (▷ page 328).
or
- Use the mechanical key to lock and unlock the doors (▷ page 327) and the trunk lid (▷ page 98) as required.

If the key is malfunctioning, contact an authorized Mercedes-Benz Center.

Checking the batteries

- ▶ Press button or .

Battery check lamp **5** lights up briefly to indicate that the key batteries are in order.



If battery check lamp **5** does not light up briefly during check, then the key batteries are discharged.

Replace the batteries (▷ page 329).

You can obtain the required batteries at any authorized Mercedes-Benz Center.

Unlocking the trunk lid

You can unlock the trunk separately.

A minimum height clearance of 5.75 ft. (1.75 m) is required to open the trunk lid.

- ▶ Press and hold button until trunk opens.



The trunk lid swings upwards automatically. Always make sure that there is sufficient overhead clearance.

The trunk can also be opened from its inside in an emergency, see "Trunk lid emergency release" (▷ page 97).



If the vehicle was previously centrally locked, the trunk lid will lock automatically when closed (▷ page 96). The turn signals will flash three times to confirm locking.

If the vehicle was previously separately locked (▷ page 98), the trunk lid will remain locked.

Loss of SmartKey or mechanical key

If you lose a SmartKey or mechanical key, you should do the following:

- ▶ Have the SmartKey deactivated by an authorized Mercedes-Benz Center.
- ▶ Report the loss of the SmartKey or the mechanical key immediately to your car insurance company.
- ▶ If necessary, have the mechanical lock replaced.

Your authorized Mercedes-Benz Center will be glad to supply you with a replacement.

SmartKey with KEYLESS-GO*

The KEYLESS-GO function is integrated into the SmartKey. On these vehicles, the validity of the SmartKey with KEYLESS-GO is checked every time you grasp a door handle.

If the SmartKey with KEYLESS-GO* is valid, your vehicle unlocks

- the doors
- the trunk lid
- the fuel filler flap

Controls in detail

Locking and unlocking

Warning!



When leaving the vehicle always remove the key from the starter switch, take the SmartKey with KEYLESS-GO (if so equipped) with you and lock the vehicle. Do not leave children unattended in the vehicle, or with access to an unlocked vehicle. Unsupervised use of vehicle equipment may cause serious personal injury.



To prevent possible malfunction, avoid exposing the SmartKey with KEYLESS-GO to high levels of electromagnetic radiation.

Important notes on using KEYLESS-GO

- You can also use the SmartKey with KEYLESS-GO like a normal key (▷ page 86).
- You can combine KEYLESS-GO functions with normal key functions (e.g. unlocking with KEYLESS-GO and locking with the remote control).
- Always carry the SmartKey with KEYLESS-GO with you.
- Never store the SmartKey with KEYLESS-GO together with:
 - Electronic items such as a cellular phone or another SmartKey with KEYLESS-GO
 - Metallic objects such as coins or metal foilDoing so could impair the function of the KEYLESS-GO system.
- To lock or unlock the vehicle, the key must be located outside the vehicle within approximately 3 ft. (1 m) of a door or the trunk.
- In order to start the engine with the SmartKey with KEYLESS-GO:
 - The SmartKey with KEYLESS-GO must be located in the vehicle.
 - All the doors must be closed.
- If you have started the engine with the KEYLESS-GO start/stop button, you can only turn it off again with this button, even if you have put the key in the starter switch in the meantime.
- This does not apply if, after starting, the selector lever is still in position **P**. The SmartKey will then have priority over the KEYLESS-GO function and the vehicle's electrical system will operate according to the position of the key in the starter switch, even stopping the engine.
- If the SmartKey with KEYLESS-GO is positioned farther away from the vehicle (e.g. inside clothing or briefcase) and can no longer be recognized by the

system, the vehicle cannot be locked or the engine started via the KEYLESS-GO system.

- If the SmartKey with KEYLESS-GO is removed from the vehicle while the ignition is switched on (e.g. if passenger exits the vehicle with the key), the message *Key not recognized!* will appear in the multifunction display.

Find the key or change its present location immediately (e.g. place it on the front passenger seat or insert it in shirt pocket).

- Remember that the engine can be started by anyone with a SmartKey with KEYLESS-GO that is left inside the vehicle. If you leave the card behind when exiting and locking the vehicle, the message *Key recognized in vehicle!* will appear in the multifunction display.

Factory setting

Global unlocking

- ▶ Grasp the door handle.

The vehicle will lock again automatically within approximately 40 seconds if neither door nor trunk is opened.



The vehicle could be inadvertently unlocked if the SmartKey with KEYLESS-GO is within 3 ft. (1 m) of the vehicle and

- the door handle is splashed with water, or
- you attempt to clean the door handle.

Global locking

- ▶ Press lock button at door handle (▷ page 53) or trunk lid (▷ page 92).



If you cannot lock or unlock the vehicle with the SmartKey with KEYLESS-GO, then either the batteries of the key are discharged or the key is malfunctioning.

- Check the batteries of the SmartKey with KEYLESS-GO (▷ page 88) and replace them if necessary (▷ page 328).
- Use the mechanical key to unlock the driver's door (▷ page 327) and trunk lid (▷ page 328) as required.

Lock the vehicle using the mechanical key (▷ page 328).

If your SmartKey with KEYLESS-GO is malfunctioning, contact your authorized Mercedes-Benz Center.

Controls in detail

Locking and unlocking

Unlocking the trunk lid

The handle is located in the rear license plate recess.



- ▶ Pull on the handle and lift up the trunk lid.

The vehicle unlocks the trunk lid only.

If the vehicle was previously separately locked or locked with the SmartKey, the trunk lid will remain locked.



The trunk lid swings open upwards automatically. Always make sure that there is sufficient overhead clearance.



If the vehicle was previously centrally locked with the SmartKey, the trunk lid will lock automatically after closing it. The turn signals will flash three times to confirm locking.

If you have left the SmartKey with KEYLESS-GO in the trunk, the trunk lid will not close.

The trunk can also be opened from the inside in an emergency, see "Trunk lid emergency release" (▷ page 97).

Locking the vehicle



1 Lock button at trunk

- ▶ Press the lock button at door (▷ page 53) or trunk.

Closing the side windows and sliding/pop-up roof*

- ▶ Press and hold lock button at door (▷ page 53) or trunk until the side windows and the sliding/pop-up roof are closed.

Warning!



When closing the windows and the sliding/pop-up roof, be sure that there is no danger of anyone being harmed by the closing procedure.

If potential danger exists, proceed as follows:

- Release the lock button.
- Pull on the door handle or trunk lid handle and hold firmly. The side windows and the sliding/pop-up roof will open.

Loss of the SmartKey with KEYLESS-GO

If you lose your SmartKey with KEYLESS-GO, you should do the following:

- ▶ Have the SmartKey with KEYLESS-GO deactivated by an authorized Mercedes-Benz Center.
- ▶ Report the loss immediately to your car insurance company.
- ▶ Have the mechanical lock replaced if necessary.

Your authorized Mercedes-Benz Center will be glad to supply you with a replacement.

Controls in detail

Locking and unlocking

Opening the doors from the inside

You can open a locked door from the inside. Open door only when conditions are safe to do so.

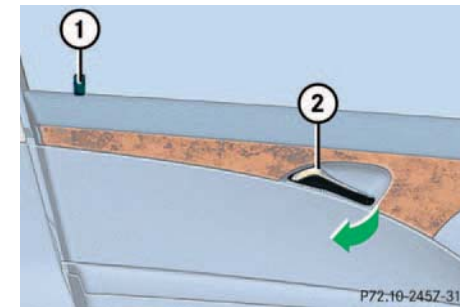

1 Locking knob

2 Inside door handle

- ▶ Pull on door handle **2**.

If door was locked, locking knob **1** will move up.

Controls in detail

Locking and unlocking



If the vehicle has previously been locked from the outside, opening a door from the inside will trigger the anti-theft alarm system. To cancel the alarm, do one of the following:

- Press button or on the SmartKey.
- Insert the SmartKey in the starter switch.

Opening the trunk from the inside

You can open the trunk from the inside if the vehicle is stationary.

A minimum height clearance of 5.75 ft. (1.75 m) is required to open the trunk lid.

The switch is located on the driver's door.

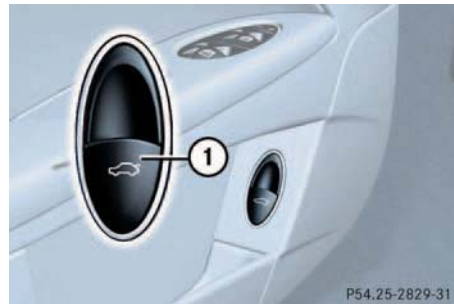

1 Remote trunk lid release switch with indicator lamp

- ▶ Pull remote trunk lid release switch **1**.

The trunk opens. The indicator lamp in the switch lights up and remains lit as long as the trunk is open.



The trunk lid swings open upwards automatically. Always make sure that there is sufficient overhead clearance.

The trunk can also be opened using the SmartKey (▷ page 88) or from its inside in an emergency, see "Trunk lid emergency release" (▷ page 97).



If the vehicle was previously centrally locked, the trunk lid will lock automatically when closed (▷ page 96). The turn signals will flash three times to confirm locking.

If the vehicle was previously separately locked (▷ page 98), the trunk lid will remain locked.

Trunk lid opening/closing system*

The switch for opening and closing the trunk is located on the driver's door.

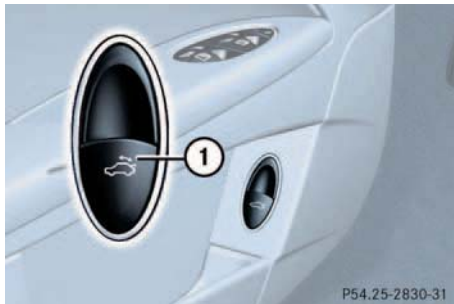

1 Remote control switch

- ▶ Pull remote control switch 1 until the trunk begins to open.

The trunk lid opens automatically.

The indicator lamp in the switch lights up and remains lit until the trunk is closed again by pressing remote control switch 1.



The trunk lid swings open upwards automatically. Always make sure that there is sufficient overhead clearance. To stop the opening procedure, pull or press the remote control switch for the trunk lid.

If the vehicle was previously separately locked (▶ page 98), the trunk lid will remain locked.

Controls in detail

Locking and unlocking

Activating opening height restriction of trunk lid

If the opening height restriction of trunk lid is activated, the trunk lid opens to below the roof line of the vehicle.



1 Trunk lid closing switch

- ▶ Press the trunk lid closing switch 1 for approx. 5 seconds.

The opening height restriction is activated.

- ▶ Press the trunk lid closing switch 1 again for approx. 5 seconds.

The opening height restriction is deactivated.

Controls in detail

Locking and unlocking

Opening the trunk

A minimum height clearance of 5.75 ft. (1.75 m) is required to open the trunk lid.

The handle is located above the rear license plate recess.



- ▶ Pull on the handle and lift up the trunk lid.

The trunk lid swings open upwards automatically. Always make sure that there is sufficient overhead clearance.



The vehicle must be unlocked.

Closing the trunk



1 Handle

- ▶ Lower trunk lid using handle 1.

Warning!



To prevent possible personal injury, always keep hands and fingers away from the trunk opening when closing the trunk. Be especially careful when small children are around.

Vehicles with trunk lid opening/closing system*

Closing from the inside

- ▶ Press the remote control switch until the indicator lamp in the switch goes out and the trunk lid is closed.

When closing, if the trunk lid comes into contact with an object (e.g. luggage that has been piled too high) in the upper motion sequence, the closing procedure is stopped and the trunk re-opens slightly.

Warning!



Monitor the closing procedure carefully to ensure that no one is in danger of being injured. To prevent possible personal injury, always keep hands and fingers away from the trunk opening when closing the trunk. Be especially careful when small children are around. To stop the closing procedure, let go of the remote control switch for the trunk.

Controls in detail

Locking and unlocking

Closing from outside



1 Trunk closing switch

- ▶ Press the closing switch briefly.

The trunk lid closes automatically.

When closing, if the trunk lid comes into contact with an object (e.g. luggage that has been piled too high) in the upper motion sequence, the closing procedure is stopped and the trunk re-opens slightly.

Warning!



Monitor the closing procedure carefully to ensure that no one is in danger of being injured. To prevent possible personal injury, always keep hands and fingers away from the trunk opening when closing the trunk. Be especially careful when small children are around. To stop the closing procedure, press the remote control switch for the trunk lid or the  key on the remote control.



Do not place the key in the open trunk. You may lock yourself out.

Vehicles with KEYLESS-GO*:
To prevent a possible inadvertent lock-out, the trunk lid will open automatically if a SmartKey with KEYLESS-GO is recognized in the area of the rear shelf or inside the trunk.

Trunk lid emergency release

The emergency release button is located on the inside of the trunk lid.



1 Emergency release button

- ▶ Briefly press the emergency release button.

The trunk unlocks and the trunk lid opens.



The emergency release button unlocks and opens the trunk while the vehicle is standing or driving.

Controls in detail

Locking and unlocking

Illumination of the emergency release button:



- The button will blink for 30 minutes after opening the trunk.
- The button will blink for 60 minutes after closing the trunk.



The emergency release button does not open the trunk lid if the vehicle battery is discharged or disconnected.



If the emergency release button is pressed and the vehicle was centrally locked, the exterior lamps will flash and the alarm will sound.

To cancel the alarm, insert the key in the starter switch or press button  or  on the key.

Separately locking the trunk



To deny any unauthorized person access to the trunk, lock it separately with the mechanical key. Leave only the SmartKey without its mechanical key inside the vehicle.

The lock is located next to the recessed handle.

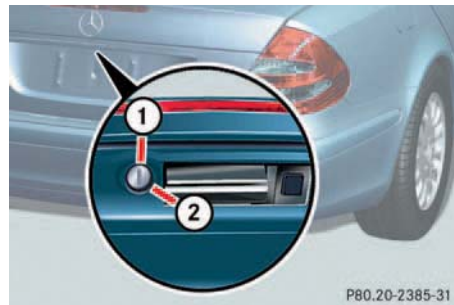

1 Unlocked

2 Locked

- ▶ Close the trunk lid (▷ page 96).
- ▶ Pull the mechanical key out of the SmartKey (▷ page 329).
- ▶ Insert the mechanical key in the trunk lid lock.
- ▶ Turn the key completely to the right to position 2.

The trunk remains locked even when the vehicle is centrally unlocked.



You can only cancel the separate trunk locking mode by means of the mechanical key.



Separately unlocking the trunk

- ▶ Pull the mechanical key out of the SmartKey (▷ page 329).
- ▶ Insert the mechanical key in the trunk lid lock.
- ▶ Turn the key completely to the left to position **1**, see above.

You can now open the trunk (▷ page 96).



Unlocking the trunk with the mechanical key will trigger the anti-theft alarm system. To cancel the alarm, do one of the following:

- Press button  or  on the SmartKey.
- Insert the SmartKey in the starter switch.

Automatic central locking

The doors and the trunk automatically lock when the ignition is switched on and the wheels are turning at vehicle speeds of approximately 9 mph (15 km/h) or more.

You can open a locked door from the inside. Open door only when conditions are safe to do so.



The doors unlock automatically after an accident if the force of the impact exceeds a preset threshold.

The vehicle automatically locks when the ignition is switched on and the wheels are turning at vehicle speeds of approximately 9 mph (15 km/h) or more. You could therefore lock yourself out when the vehicle

- is pushed
- is on a test stand

You can deactivate the automatic locking mode over the control system (▷ page 142).

Controls in detail

Locking and unlocking

Locking and unlocking from the inside

You can lock or unlock the doors and the trunk from inside using the central locking switch. This can be useful, for example, if you want to lock the vehicle before starting to drive.

The fuel filler flap cannot be locked or unlocked with the central locking switch.

Warning!



When leaving the vehicle, always remove the key from the starter switch, take it with you and lock the vehicle. Do not leave children unattended in the vehicle, or with access to an unlocked vehicle. Unsupervised use of vehicle equipment may cause serious personal injury.

The switch is located in the center console.

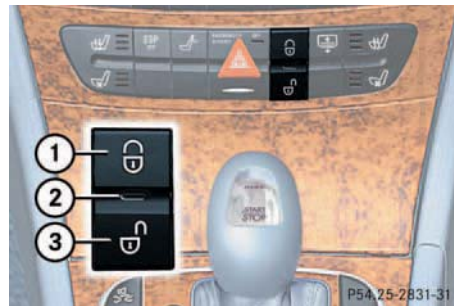

Central locking switch

- 1 Locking
- 2 Indicator lamp
- 3 Unlocking

Locking

- ▶ Press upper half **1** of the central locking switch.

If both front doors are closed, the vehicle locks.

Unlocking

- ▶ Press lower half **2** of the central locking switch.

The vehicle unlocks.



You can open a locked door from the inside. Open door only when conditions are safe to do so.

If the vehicle was previously centrally locked using the SmartKey, it will not unlock using the central locking switch.

If the vehicle was previously locked with the central locking switch

- while in the selective remote control mode, only the door opened from the inside is unlocked.
- while in the global remote control mode, the complete vehicle is unlocked when a door is opened from the inside.

Locking the vehicle from the trunk*

Vehicles with trunk lid opening/closing system* and KEYLESS-GO* can be centrally locked using a switch in the trunk lid.



1 Central locking

- ▶ Press button **1**.

The vehicle is centrally locked.

Controls in detail

Seats

Seats

Information on seat adjustment can be found in the "Getting started" section (▷ page 35).

Easy-entry/exit feature*

With the easy-entry/exit feature activated, the steering wheel tilts upwards and the driver's seat moves to the rear.

This allows easier entry into and exit from the vehicle when the driver's door is opened. However, the engine must be turned off.

When the SmartKey is inserted in the starter switch and the driver's door is closed, the steering wheel and the driver's seat return to their last set positions.

Warning!



You must ensure that no one can become trapped or injured by the moving steering wheel and driver's seat when the easy-entry/exit feature is activated, the driver's door is being opened and the engine is turned off or the SmartKey removed from the starter switch. Do not leave children unattended in the vehicle, or with access to an unlocked vehicle. Unsupervised use of vehicle equipment may cause serious personal injury.

You can activate the following functions:

- Steering column:
Only the steering column is adjusted.
- Steering column and seat:
The steering column and the seat are adjusted.

The easy-entry/exit feature can be switched on or off in the individual setting menu Convenience-Easy-entry feature activate (▷ page 143).



To cancel seat/steering wheel movement, do one of the following:

- Press seat adjustment switch (▷ page 28).
- Move steering column stalk (▷ page 38).
- Press the memory switch (▷ page 28).

Head restraints

Information on head restraint adjustment can be found in the "Getting started" section (▷ page 36).

Warning!



For your protection, drive only with properly positioned head restraints.

Adjust head restraint to support the back of the head approximately at ear level.

Do not drive the vehicle without the seat head restraints. Head restraints are intended to help reduce injuries during an accident.



Tilt the backrest to the rear for easier removal and installation of the head restraints.

Front seat head restraints



Removing front head restraints

- ▶ Press switch **1** upwards and hold until the head restraint is fully extended.
- ▶ Pull out head restraint.

Installing front head restraints:

- ▶ Press switch **1** upwards and hold for about five seconds.
- ▶ Push the head restraint down until it engages.
- ▶ Adjust head restraint to desired position (▷ page 36).

Rear seat head restraints

Warning!



For safety reasons, always drive with the rear head restraints in the upright position when the rear seats are occupied.

Keep the area around head restraints clear of articles (e.g. clothing) to not obstruct the folding operation of the head restraints.

Controls in detail

Seats

Folding rear head restraints back



- ▶ Make sure the starter switch is in position **1** or **2**.
- ▶ Push switch **1**.

The rear head restraints will fold backward.

Placing rear head restraints upright



- ▶ Pull the rear head restraint forward until it locks into position.

Multicontour seat*

The multicontour seat has a movable seat cushion and inflatable air cushions built into the backrest to provide additional lumbar and side support.

The seat cushion movement, backrest cushion height and curvature can be continuously varied with regulators on the right side of the seat after turning the SmartKey in the starter switch to position **2**.

Controls in detail

Seats



- 1 Seat cushion depth
- 2 Backrest bottom
- 3 Backrest center
- 4 Side bolster adjustment

Adjusting the multicontour seat in the order listed above is recommended.

- ▶ Make sure that the ignition is switched on.
All lamps in the instrument cluster light up.

Adjusting backrest contour

- ▶ Adjust the seat cushion depth to the length of your upper leg using switch **1**.

- ▶ Adjust the backrest contour to the contour of your back using **+** or **-**.
- ▶ Move the backrest support to the bottom by using button **2** or to the center by using button **3**.
- ▶ Adjust the side bolsters so that they provide good lateral support using button **4**.

Dynamic driving seat*

The dynamic driving seat automatically adjusts the lateral support provided by the backrest to your driving style.

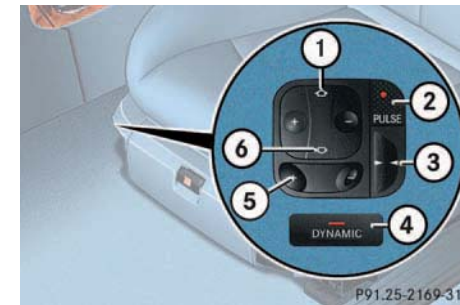

- 1 Backrest center
- 2 Massage function
- 3 Backrest side bolsters
- 4 Activate dynamic driving function
- 5 Seat cushion depth
- 6 Backrest bottom

The dynamic driving seat electronically controls the air pressure in the air chambers of the backrest side bolsters. This function improves driving comfort and pleasure.

Controls in detail

Seats

Activating

- ▶ Press button **4**.

The indicator lamp in the button lights up.



You can adjust the characteristics of the dynamic driving seat using the control system (▷ page 145).

Deactivating

- ▶ Press button **4** again.

The indicator lamp in the button goes out.



When the engine is turned off, the last cushion setting is retained in memory, and the cushion is automatically adjusted to this setting when the engine is restarted.

Massage function (PULSE)

The massage function can help prevent muscle tension during long drives.

- ▶ Press button **2**.

The indicator lamp in button **2** lights up. The air cushions in the lumbar area pulsate.



The massage function turns off automatically after approximately 5 minutes.

Heated seats*

Both switches for the front seats are located in the center console. The red indicator lamps in the switch light up to show which heating level you have selected.



1 Seat heating

Level	
3	3 indicator lamps lit The seat heater automatically switches to level 2 after approximately 5 minutes
2	2 indicator lamps lit The seat heater automatically switches to level 1 after approximately 10 minutes
1	1 indicator lamp lit The seat heater automatically switches off after approximately 20 minutes
off	No indicator lamps lit

- Make sure that the ignition is switched on.

All the lamps in the instrument cluster light up.



The seat heater may switch off if the battery voltage is too low. One or more indicator lamps will blink.

Switching seat heating on

- Press button **1** repeatedly until the desired heating level is set.

Switching seat heating off

- Press button **1** repeatedly until all indicator lamps go out.

Controls in detail

Seats

Seat ventilation*

The seat ventilation switch is located on the center console. The blue indicator lamps in the switch show which ventilation level you have selected.



1 Seat ventilation

Level	
3	3 indicator lamps lit
2	2 indicator lamps lit
1	1 indicator lamp lit
off	No indicator lamps lit



The seat ventilation may switch off if the battery voltage is too low.

- ▶ Make sure that the ignition has been switched on.

All lamps in the instrument cluster light up.

Switching seat ventilation on

- ▶ Press button **1** repeatedly until the desired ventilation level is set.

Switching seat ventilation off

- ▶ Press button **1** repeatedly until all indicator lamps go out.



If seat ventilation is activated through the summer opening function, seat ventilation is automatically set to the highest level.

Memory function



Prior to operating the vehicle, the driver should check and adjust the seat height, seat position fore and aft, and backrest angle if necessary, to ensure adequate control, reach and comfort. The head restraint should also be adjusted for proper height. Also see the section on airbags (▷ page 57) for more information on proper seat positioning.

In addition, adjust the steering wheel to ensure adequate control, reach, operation and comfort. Both the inside and outside rear view mirrors should be adjusted for adequate rear vision.

Fasten seat belts. Infants and small children should be seated in a properly secured restraint system that complies with U.S. Federal Motor Vehicle Safety Standard 213 and Canadian Motor Vehicle Safety Standard 213.

You can store up to three different settings per key.

The following settings are saved for each stored position:

- Driver's seat and backrest position
- Steering wheel position
- Driver's side exterior rear view mirror position
- Passenger side exterior rear view mirror position
- Front passenger seat position

These key-dependent memory settings can be deactivated if desired (▷ page 110).

Controls in detail

Memory function

Warning!



Do not activate the memory function while driving. Activating the memory function while driving could cause the driver to lose control of the vehicle.

Controls in detail

Memory function

The memory button is located on the door.



M Memory button

1,2,3 Stored positions

- ▶ Be sure that the ignition is switched on or the relevant door is open and the SmartKey is inserted in the starter switch.

Storing positions into memory

- ▶ Adjust the seats, steering wheel and rear view mirrors to the desired position (▷ page 34).
- ▶ Press memory button **M**.
- ▶ Release memory button and press stored position button **1**, **2** or **3** within three seconds.

All the settings are stored at the selected position.

Recalling positions from memory

- ▶ On memory button, press and hold stored position button **1**, **2** or **3** until the seat, steering wheel and rear view mirrors have fully moved to the stored positions.



Releasing the button immediately stops movement to the stored positions.

Warning!



Do not operate the power seats using the memory button if the backrest is in an excessively reclined position. Doing so could cause damage to front or rear seats.

First move backrest to an upright position.

Storing parking position

For easier parking you can adjust the passenger exterior rear view mirror so that you can see the right rear wheel as soon as you engage reverse gear **R**.

The exterior rear view mirror returns to its previously stored driving position

- 10 seconds after you put the gear selector lever out of position **R**
- immediately once you exceed a speed of approx. 6 mph (10 km/h)
- immediately when you press the button for the driver's side mirror

You can store a parking position for the passenger exterior rear view mirror for each key using the memory button.

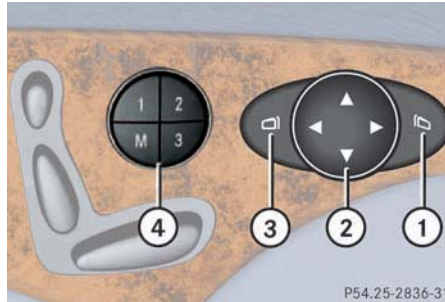

- 1 Passenger side, exterior rear view mirror
- 2 Adjustment button
- 3 Driver's side, exterior rear view mirror
- 4 Memory button

- ▶ Stop the vehicle.
- ▶ Switch ignition on (if not already on).
- ▶ Press button **1**.

The passenger side exterior rear view mirror is selected.

Controls in detail

Memory function

- ▶ Adjust the exterior rear view mirror with button **2** so that you see the rear wheel and the curb.
- ▶ Press memory button "M" **4** on the door.
- ▶ Within three seconds, press bottom of adjustment button **2**.

The parking position is stored if the mirror does not move.



If the mirror does move, repeat the above steps. After the setting is stored, you can move the mirror again.

Controls in detail

Lighting

Lighting

For notes on how to switch on the headlamps and use the turn signals, see the "Getting started" section (▷ page 46).

Exterior lamp switch

The exterior lamp switch is located on the dashboard to the left of the steering wheel.



- 0** Off
- AUTO** Automatic headlamp mode
- P<->** Parking lamps (also side marker lamps, tail lamps, license plate lamps, instrument panel lamps)
Canada only:
When engine is running, the low beam is also switched on.
- P<->** Parking lamps plus low beam or high beam headlamps (combination switch pushed forward).
- P<->** Standing lamps, right (turn left one stop)
- +P<->** Standing lamps, left (turn left two stops)

i

If you remove the key and open the driver's door while the parking lamps or low beam headlamps are switched on, then

- a warning sounds
-  appears in the multifunction display
- the message `Turn off lamps!` appears in the multifunction display

i

With the daytime running lamp mode activated and the engine running, the low beam headlamps cannot be switched off manually.

Manual headlamp mode

The low beam headlamps and parking lamps can be switched on and off with the exterior lamp switch (▷ page 112).

Automatic headlamp mode

The parking lamps, low beam headlamps and license plate lamps switch on and off automatically depending on the brightness of the ambient light.

- ▶ Turn the exterior lamp switch to **AUTO**.

Warning!



In automatic headlamp mode, the headlamps will not be automatically switched on under foggy conditions. To minimize risk to you and to others, activate headlamps by turning exterior lamp switch to

The driver is responsible for the operation of the vehicle's lights at all times. The automatic headlamp feature is only an aid to the driver. Switch on the vehicle lights by hand when driving or when traffic conditions require you to do so.



With the daytime running lamp mode activated, the low beam headlamps will not be switched off automatically.

Controls in detail

Lighting



Front fog lamps and rear fog lamp can not be switched on manually with exterior lamp switch in position **AUTO**. To activate the fog lamps, turn exterior lamp switch to position



If you drive in countries where vehicles drive on the other side of the road than the country where the vehicle is registered, you must have the headlamps modified for symmetrical low beams. Relevant information can be obtained at your authorized Mercedes-Benz Center.

Controls in detail

Lighting

Daytime running lamp mode

- ▶ Turn exterior lamp switch to position **0** or **AUTO**.

When the engine is running, the low beam headlamps are automatically switched on. In low ambient light conditions the parking lamps will also switch on.

Canada only

When you shift from a driving position to position **N** or **P**, the low beam switches off (with a three-minute delay).

For nighttime driving you should turn the exterior lamp switch to position  to permit activation of the high beam headlamps.

USA only

The high beam headlamps can also be activated when driving with the daytime running lamp mode activated and exterior lamp switch in position **0**.

To activate the daytime running lamp mode, see "Setting daytime running lamp mode" (▷ page 139).



See notes on the exterior lamp switch (▷ page 112).

Locator lighting and night security illumination

Locator lighting and night security illumination are described in the control system section under "Setting locator lighting" (▷ page 139) and "Setting night security illumination" (▷ page 140).

Switching on front fog lamps

- ▶ Check that the low beam headlamps are switched on.
- ▶ Pull out exterior lamp switch to first stop.

The green indicator lamp  in the lamp switch lights up.



Fog lamps will operate with the parking lamps and/or the low beam headlamps on. Fog lamps should only be used in conjunction with low beam headlamps. Consult your State or Province Motor Vehicle Regulations regarding allowable lamp operation.

Switching on rear fog lamp

- ▶ Check that the low beam headlamps are switched on.
- ▶ Pull out exterior lamp switch to second stop.

The yellow indicator lamp  in the lamp switch lights up.

Combination switch

The combination switch is located on the left side of the steering column.

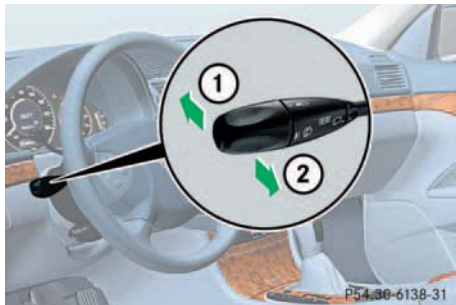

- 1 High beam
- 2 High beam flasher

Switching on high beams

- ▶ Turn exterior lamp switch to position  (▷ page 112).
- ▶ Push the combination switch in direction 1.

The high beam symbol is illuminated on the instrument cluster.

High beam flasher

- ▶ Pull the combination switch briefly in direction 2.

Hazard warning flasher

The hazard warning flasher can be activated with the ignition switched on or off. It is activated automatically when an airbag is deployed.

The switch is located on the center console.



- 1 Hazard warning flasher switch

Switching on the hazard warning flasher

- ▶ Press the hazard warning flasher switch.

All turn signals will blink.



With the hazard warning flasher activated and the combination switch set for either left or right turn, only the respective left or right turn signals will operate when the key in the starter switch is in position 1 or 2.

Switching off the hazard warning flasher

- ▶ Press hazard warning flasher switch again.

Controls in detail

Lighting

Interior lighting

The controls are located in the overhead control panel.



- 1 Switch for reading lamp, left
- 2 Switch for rear compartment lighting
- 3 Switch for automatic function
- 4 Switch for interior lighting in front
- 5 Switch for reading lamp, right
- 6 Ambient lighting
- 7 Interior lighting

8 Reading lamps



If the door remains open, the interior lamps switch off automatically after approximately five minutes when the key is removed or in starter switch position **0**.

An interior lamp switched on manually does not go out automatically.

Activating automatic control

- ▶ Press button **3**.

Interior lamps are switched on in darkness, when

- unlocking the vehicle
- opening a door
- removing the SmartKey from the starter switch

The interior lamps are switched off following an adjustable time delay (▷ page 141).

Deactivating automatic control

- ▶ Press button **3**.

The interior lighting remains switched off, even when

- centrally unlocking the vehicle
- opening a door
- removing the SmartKey from the starter switch

Manual control

Switching rear interior lights on and off

- ▶ Press button **2**.

The lights in the rear passenger compartment go on.

- ▶ Press button **2** again.

The lights in the rear passenger compartment go out.

Switching left front reading lamp on and off

- ▶ Press button **1**.
The left reading lamp goes on.
- ▶ Press button **1** again.
The left reading lamp goes out.

Switching right front reading lamp on and off

- ▶ Press button **5**.
The right reading lamp goes on.
- ▶ Press button **5** again.
The right reading lamp goes out.

Door entry lamps

The appropriate door entry lamp switches on if a door is opened in darkness and if the interior lighting is switched to the automatic function.

The entry lamp goes out automatically when the door is closed.



If you turn the key in the starter switch to position **0** or remove the key, the door entry lamps will remain lit for approximately five minutes.

Trunk lamp

The trunk lamp switches on if the trunk lid is opened.

If you leave the trunk open for an extended period of time, the trunk lamp will switch off automatically after approximately ten minutes.

Controls in detail

Instrument cluster

Instrument cluster

A full view illustration of the instrument cluster can be found in the "At a glance" section of this manual (▷ page 22).

The instrument cluster is activated when you

- open a door
- turn on the ignition
- press the reset knob (▷ page 22)
- switch on the exterior lamps

You can change the instrument cluster settings in the instrument cluster submenu of the control system (▷ page 134).

Instrument cluster illumination

Use the reset knob (▷ page 22) to adjust the illumination brightness for the instrument cluster.



The instrument cluster illumination is dimmed or brightened automatically to suit ambient light conditions.

The instrument cluster illumination will also be adjusted automatically when you switch on the vehicle's exterior lamps.

To brighten illumination

- ▶ Turn the reset knob in the instrument cluster clockwise (▷ page 22).
The instrument cluster illumination will brighten.

To dim illumination

- ▶ Turn the reset knob in the instrument cluster counterclockwise (▷ page 22).
The instrument cluster illumination will dim.

Coolant temperature display

Warning!



- Driving when your engine is badly overheated can cause some fluids which may have leaked into the engine compartment to catch fire. You could be seriously burned.
- Steam from an overheated engine can cause serious burns and can occur just by opening the engine hood. Stay away from the engine if you see or hear steam coming from it.

Turn off the engine, get out of the vehicle and do not stand near the vehicle until it cools down.



Excessive coolant temperatures trigger a warning in the multifunction display.

During severe operating conditions and stop-and-go city traffic, the coolant temperature may rise close to 248°F (120°C).

The engine should not be operated with the coolant temperature above 248°F (120°C). Doing so may cause serious engine damage which is not covered by the Mercedes-Benz Limited Warranty.

Trip odometer

- ▶ Check to see that the trip odometer and main odometer (▷ page 121) appear in the multifunction display.
- ▶ Press and hold the reset knob on the instrument cluster (▷ page 22) until the trip odometer is reset.

Controls in detail

Instrument cluster

Tachometer

The red marking on the tachometer denotes excessive engine speed.



Avoid driving at excessive engine speeds, as it may result in serious engine damage that is not covered by the Mercedes-Benz Limited Warranty.

To help protect the engine, the fuel supply is interrupted if the engine is operated within the red marking.

Outside temperature indicator

Warning!



The outside temperature indicator is not designed to serve as an ice-warning device and is therefore unsuitable for that purpose.

Indicated temperatures just above the freezing point do not guarantee that the road surface is free of ice. The road may still be icy, especially in wooded areas or on bridges.

The temperature sensor is located in the front bumper area. Due to its location, the sensor can be affected by road or engine heat during idling or slow driving. This means that the accuracy of the displayed temperature can only be verified by comparison to a thermometer placed next to the sensor, not by comparison to external displays (e.g. bank signs etc.).

When moving the vehicle into colder ambient temperatures (e.g. when leaving your garage), you will notice a delay before the lower temperature is displayed.

A delay also occurs when ambient temperatures rise. This prevents inaccurate temperature indications caused by heat radiated from the engine during idling or slow driving.

Control system

The control system is activated as soon as the key in the starter switch is turned to position **1**. The control system enables you to

- call up information about your vehicle
- change vehicle settings.

For example, you can use the control system to find out when your vehicle is next due for service, to set the language for messages in the instrument cluster display, and much more.



The displays for the audio systems (radio, CD player, cassette player) will appear in English, regardless of the language selected.

Warning!



A driver's attention to the road must always be his/her primary focus when driving.

For your safety and the safety of others, selecting features through the multifunction steering wheel should only be done by the driver when traffic and road conditions permit it to be done safely.

Bear in mind that at a speed of just 30 mph (approximately 50 km/h), your vehicle is covering a distance of 44 feet (approximately 13.5 m) every second.

The control system relays information to the multifunction display.

Controls in detail

Control system

Multifunction display



- 1 Segment ring
- 2 Standard display
- 3 Trip odometer

Controls in detail

Control system

Multifunction steering wheel

The displays in the multifunction display and the settings in the control system (▷ page 121) are controlled by the buttons on the multifunction steering wheel.

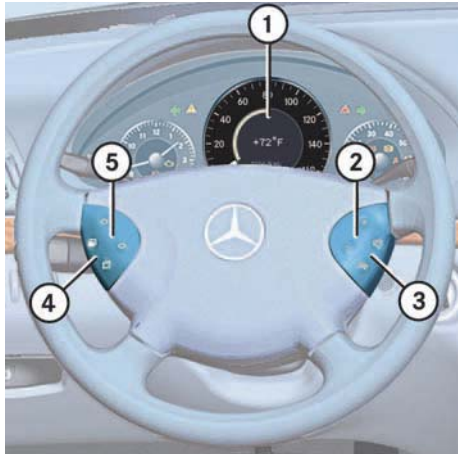

Pressing any of the buttons on the multifunction steering wheel will alter what is shown in the multifunction display.

1 Multifunction display in the speedometer

Operating the control system

2 Selecting the submenu or setting the volume

— down / to decrease

+ up / to increase

3 Telephone*

☎ to take a call

☎ to end a call

4 Menu systems

⏪ for next menu

⏩ for previous menu

5 Moving within a menu





⬆ for next display

⬆ for previous display

The information available in the multifunction display is arranged in menus, each containing a number of functions or sub-menus.

The individual functions are then found within the relevant menu (radio or CD operations under *Audio*, for example). These functions serve to call up relevant information or to customize the settings for your vehicle.

It is helpful to think of the menus, and the functions within each menu, as being arranged in a circular pattern.

- If you press button  or  often enough, you will pass through each menu one after the other.
- If you press button  or  often enough, you will pass through each function display, one after the other, in the current menu.

In the *Settings* menu, instead of functions you will find a number of submenus for calling up and changing settings. For instructions on using these submenus, see the "Settings menu" section (▷ page 131).

The number of menus available in the system depends on which optional equipment is installed in your vehicle.

The menus are described on the following pages.

Controls in detail

Control system

Menus

This is what you will see when you scroll through the menus.

The table on the next page provides an overview of the individual menus.

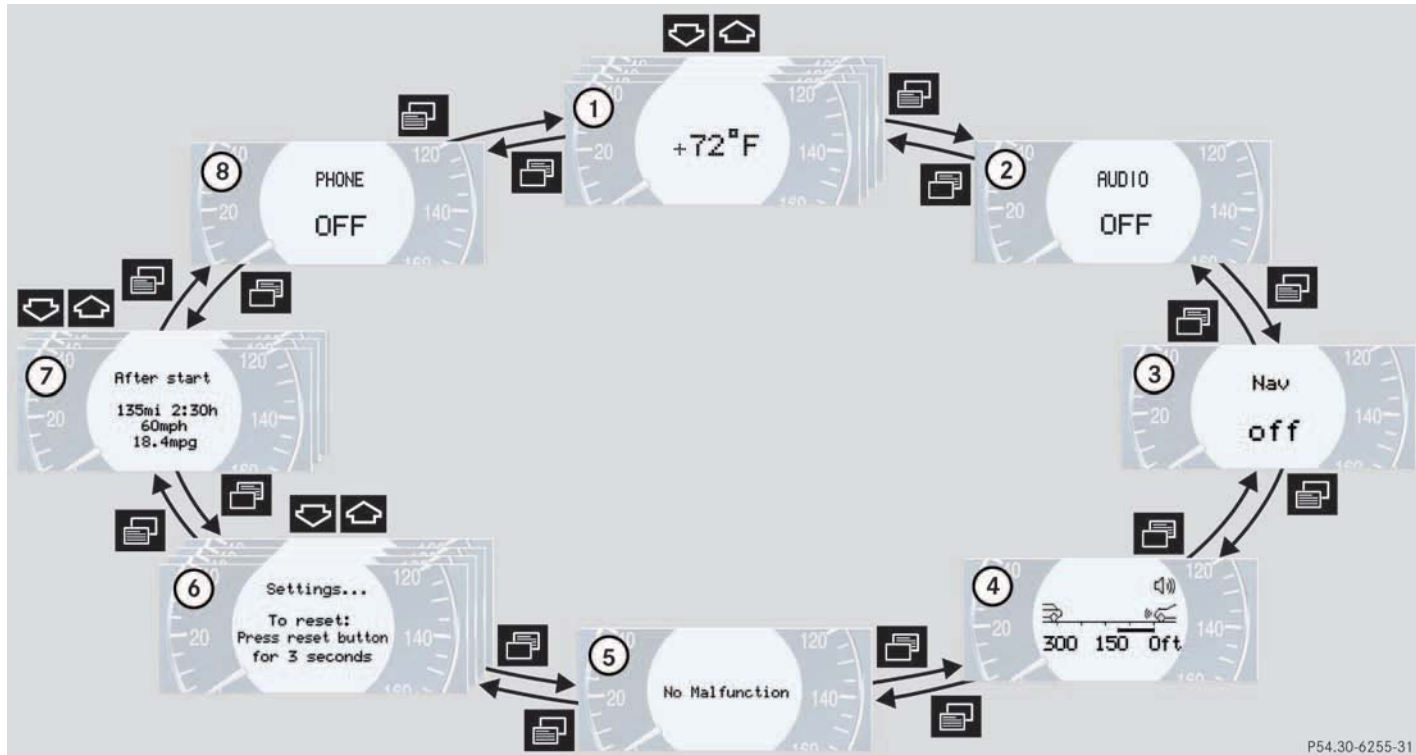

Menus, submenus and functions

	Menu 1	Menu 2	Menu 3	Menu 4	Menu 5	Menu 6	Menu 7	Menu 8
Commands / submenus	Standard display	AUDIO	NAVI*	Distronic*	Malfunction memory	Settings	Trip computer	Telephone
	Digital speedometer	Select radio station	Activate route guidance	Call up settings	Call up malfunction messages	Reset to factory settings	Fuel consumption statistics after start	Load phone book
	Call up FSS PLUS	Operate CD player*				Instrument cluster submenu	Fuel consumption statistics since the last reset	Search for name in phone book
	Check tire pressure*	Operate cassette player				Time/Date submenu	Call up range	
	Check engine oil level					Lighting submenu Vehicle submenu Convenience submenu Dynamic driving seat* submenu		

Controls in detail

Control system



The headings used in the menus table are designed to facilitate navigation within the system and are not necessarily identical to those shown in the control system displays.

The first function displayed in each menu will automatically show you which part of the system you are in.

Standard display menu

You can select the functions in the standard display menu with button or .

The following functions are available:

Function	Page
Call up digital speedometer	see below
Call up FSS PLUS	275
Check tire pressure*	270
Check engine oil level	262

Display digital speedometer

- ▶ Press button twice.

The current vehicle speed is shown in the multifunction display.

AUDIO menu



The functions in the *Audio* menu operate the audio equipment which you currently have turned on.

If no audio equipment is currently turned on, the message *AUDIO OFF* is shown in the display.

The following functions are available:

Function	Page
Select radio station	127
Operate CD player*	127
Operate cassette player	128

Select radio station

- ▶ Turn on the radio. Refer to separate operating instructions.
Vehicles with COMAND*:
Refer to separate operating instructions.
- ▶ Press button  or  repeatedly until you see the currently tuned station in the display.

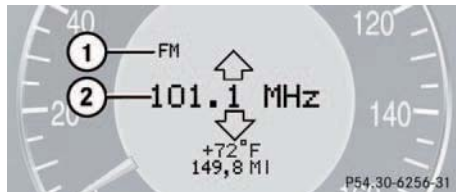

- 1 Waveband setting
- 2 Station frequency

- ▶ Press button  or  repeatedly until the desired station is found.





You can only store new stations using the corresponding feature on the radio, see separate operating instructions.

Vehicles with COMAND*:
Refer to separate operating instructions.

You can also operate the radio in the usual manner.

Operate the CD player*

- ▶ Turn on the radio and select the CD player. Refer to separate operating instructions.
Vehicles with COMAND*:
Refer to separate operating instructions.
- ▶ Press button  or  repeatedly until the settings for the CD currently being played are shown in the display.

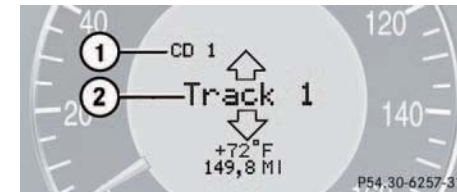

- 1 Current CD (for CD changer*)
- 2 Current track

- ▶ Press button  or  repeatedly until the desired track is selected.

Controls in detail

Control system

Controls in detail

Control system



To select a CD from the magazine, press a number on the audio system or the COMAND* system key pad located in the center dashboard.

Operate the cassette player

- ▶ Turn on the radio and select the cassette player, see separate operating instructions.
Vehicles with COMAND*: Refer to separate operating instructions.
- ▶ Press button or repeatedly until the settings for the cassette currently being played are shown in the display.



1 Current side

- ▶ Press button to fast forward to the next track.
- ▶ Press button to rewind the cassette to the beginning of the current track.



To select the reverse side of the tape, press button below track number on the audio system display, or enter request on the COMAND* system located in the center dashboard.

NAVI*

Refer to separate COMAND* operating instructions.

Distronic* menu

Use the Distronic menu to display the current settings for your Distronic system. What information is shown in the display depends on whether the Distronic system is active or inactive.

Please refer to the "Driving systems" section of this manual (▷ page 197) for instructions on how to activate Distronic.

- ▶ Press button or repeatedly until you see one of the following two pictures in the display.

Distronic deactivated

When DISTRONIC is deactivated, you will see the standard display in the display.

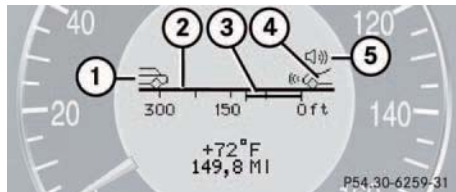

- 1 Vehicle ahead, if detected
- 2 Actual distance to vehicle ahead
- 3 Should-be distance to vehicle ahead
- 4 Your vehicle
- 5 Symbol for activated distance warning function

Distronic activated

When DISTRONIC is activated, DISTRONIC and the set speed are seen in the display.

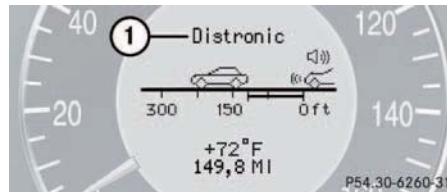

- 1 DISTRONIC activated

Malfunction memory menu

Use the malfunction memory menu to scan malfunction and warning messages that may be stored in the system. What information is shown in the display depends on whether malfunctions have actually occurred.



Warning!



Malfunction and warning messages are only indicated for certain systems and displayed at a low level of detail. The malfunction and warning messages are simply a reminder with respect to the operation of certain systems and do not replace the driver's responsibility to maintain the vehicle's operating safety by having all required maintenance and safety checks performed on the vehicle and by bringing the vehicle to an authorized Mercedes-Benz Center to address the malfunction and warning messages (▷ page 295).

Controls in detail

Control system

- ▶ Press button  or  repeatedly until you see the malfunction message memory in the display.



No malfunction messages

If no malfunctions have occurred, the message in the display is:
No Malfunction

Malfunctions have occurred

If malfunctions have occurred, you will see the number of malfunctions in the display:



- ▶ Press button  or .

The stored messages will now be displayed in order. See the "Practical hints" section for malfunction and warning messages (▶ page 295).



Should any malfunctions occur while driving, the number of malfunctions will reappear in the display when the key in the starter switch is turned to position **0** or removed from the starter switch.



The message memory will be cleared when you turn the key in the starter switch to position **1** or **2**. You will then only see high priority malfunctions. These are highlighted by red background (▶ page 295).

Settings menu

In the Settings menu there are two functions:

- The function To reset: Press reset button for 3 seconds, with which you can reset all the settings to the original factory settings.
 - A collection of submenus with which you can make individual settings for your vehicle.
- ▶ Press button  or  repeatedly until the Settings menu is seen in the display.

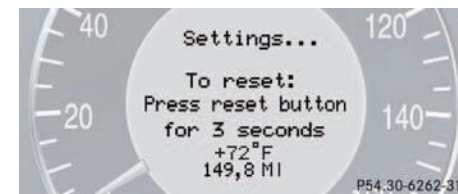

Resetting all settings

You can reset all the functions of all submenus to the factory settings.

- ▶ Press the reset knob in the instrument cluster (▷ page 22) for approximately three seconds.

In the display you will see the request to press the reset knob again to confirm.

- ▶ Press the reset knob again.

The functions of all the submenus will reset to factory settings.



The settings you have changed will not be reset unless you confirm the action by pressing the reset knob a second time.

Submenus in the Settings menu

- ▶ Press button or .

In the display you see the collection of the submenus.



- ▶ Press button .

The selection marker moves to the next submenu.

The submenus are arranged by hierarchy. Scroll down with the button, scroll up with the button.

Move within the submenus with the or button to the individual functions.

The settings themselves are made with button or .

Resetting the functions of a submenu

For each submenu you can reset all the functions to the factory settings.

- ▶ Move to a function in the submenu.
- ▶ Press the reset knob (▷ page 22) in the instrument cluster for approximately three seconds.

In the display you will see the request to press the reset knob again to confirm.

- ▶ Press the reset knob again.

All functions of the submenu will reset to factory settings.

Controls in detail

Control system

The table below shows what settings can be changed within the various menus. Detailed instructions on making individual settings can be found on the following pages.

INSTRUMENT CLUSTER	TIME/DATE	LIGHTING	VEHICLE
Select temperature display mode	Set time (hours)	Set daytime running lamp mode (USA only)	Set automatic locking
Select speedometer display mode	Set time (minutes)	Set locator lighting	
Select language	Set date (month)	Ambient lighting	
Select display (speed display or outside temperature) for status line	Set date (day)	Exterior lamps delayed switch-off	
Tire pressure unit display*	Set date (year)	Interior lighting delayed switch-off	

Controls in detail

Control system

CONVENIENCE	DYNAMIC SEAT*
Activate easy-entry/exit feature	Set level for dynamic seat, driver
Set key dependency	Set level for dynamic seat, passenger
Set parking position for exterior rear view mirror	

Controls in detail



Control system

Instrument cluster submenu

Access the Instr. cluster submenu via the Settings menu. Use the Instr. cluster submenu to change the instrument cluster display settings. The following functions are available:

Function	Page
Select temperature display mode	134
Select speedometer display mode	134
Select language	135
Select display (speed display or outside temperature) for status display	135
Select display (speed display or outside temperature) for basic display	136
Tire pressure display*	136

Selecting temperature display mode

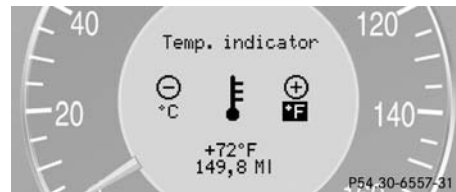

- ▶ Move the selection marker with the **+** or **-** button to the Instr. cluster submenu.
- ▶ Press button  or  repeatedly until you see this message in the display: Temp. indicator.

The selection marker is on the current setting.



- ▶ Press **+** or **-** to set the temperature unit to degrees Celsius (°C) or degrees Fahrenheit (°F).

Selecting speedometer display mode

- ▶ Move the selection marker with the **+** or **-** button to the Instr. cluster submenu.
- ▶ Press button  or  repeatedly until you see this message in the display: Display unit.

The selection marker is on the current setting.

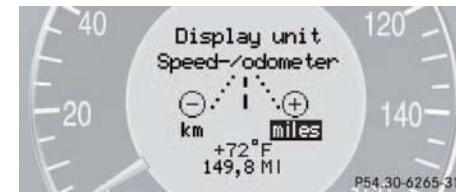

- ▶ Press **+** or **-** to set speedometer unit to km or miles.

Controls in detail

Control system

Selecting language

- ▶ Move the selection marker with the **+** or **-** button to the Instr. cluster submenu.
- ▶ Press button **▲** or **▼** repeatedly until you see this message in the display: Language.

The selection marker is on the current setting.



- ▶ Press **+** or **-** to select the language to be used for the multifunction display messages.

Available languages:

- German
- English
- Italian
- French
- Spanish

Selecting display (speed display or outside temperature) for status display

- ▶ Move the selection marker with the **+** or **-** button to the Instr. cluster submenu.
- ▶ Press button **▲** or **▼** repeatedly until you see this message in the display: Status line display.

The selection marker is on the current setting.



- ▶ Press **+** or **-** to select the status line to degrees Fahrenheit (°F) or miles.



You will see the status indicator when you have called up a different display from the standard display.

Controls in detail

Control system

Selecting display (speed display or outside temperature) for basic display

- ▶ Move the selection marker with the **+** or **-** button to the Instr. cluster submenu.
- ▶ Press button **↕** or **↓** repeatedly until you see this message in the display: Basic display.

The selection marker is on the current setting.

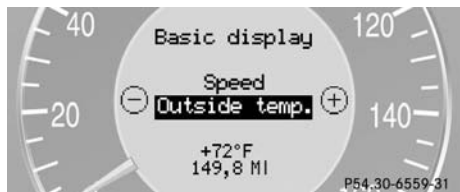

- ▶ Press **+** or **-** to select the display permanently shown in the multi-function display.

Tire pressure display*

Use this function to set the unit for the tire pressure display.

- ▶ Move the selection marker with the **+** or **-** button to the Instr. cluster submenu.
- ▶ Press button **↕** or **↓** repeatedly until you see this message in the display: Display unit Tire pressure.

The selection marker is on the current setting.



- ▶ Press **+** or **-** to select the desired tire pressure unit.

Time/Date submenu

Access the Time/Date submenu via the Settings menu. Use the Time/Date submenu to change the time and date display settings. The following functions are available:

Function	Page
Set time (hours)	137
Set time (minutes)	137
Set date (month)	137
Set date (day)	138
Set date (year)	138

Set time (hours)

- ▶ Move the selection marker with the **+** or **-** button to the Time/Date submenu.
- ▶ Press button **↶** or **↷** repeatedly until you see this message in the display: Clock, hours.

The selection marker is on the hour setting.



- ▶ Press **+** or **-** to set the hour.
- ▶ Confirm by pressing reset knob.

Set time (minutes)

- ▶ Move the selection marker with the **+** or **-** button to the Time/Date submenu.
- ▶ Press button **↶** or **↷** repeatedly until you see this message in the display: Clock, minutes.

The selection marker is on the minute setting.



- ▶ Press **+** or **-** to set the minutes.
- ▶ Confirm by pressing reset knob.

Set date (month)

- ▶ Move the selection marker with the **+** or **-** button to the Time/Date submenu.
- ▶ Press button **↶** or **↷** repeatedly until you see this message in the display: Set date month.

The selection marker is on the month setting.



- ▶ Press **+** or **-** to set the month.

Controls in detail

Control system

Set date (day)

- ▶ Move the selection marker with the **+** or **-** button to the Time/Date submenu.
- ▶ Press button **↕** or **↔** repeatedly until you see this message in the display: Set date day.

The selection marker is on the day setting.



- ▶ Press **+** or **-** to set the day.

Set date (year)

- ▶ Move the selection marker with the **+** or **-** button to the Time/Date submenu.
- ▶ Press button **↕** or **↔** repeatedly until you see this message in the display: Set date year.

The selection marker is on the year setting.



- ▶ Press **+** or **-** to set the year.

Lighting submenu

Access the Lighting submenu via the Settings menu. Use the Lighting submenu to change the lamp and lighting settings on your vehicle. The following functions are available:

Function	Page
Set daytime running lamp mode (USA only)	see below
Set locator lighting	139
Ambient light level	140
Exterior lamps delayed switch-off	140
Interior lighting delayed switch-off	141

Setting daytime running lamp mode (USA only)

- ▶ Move the selection marker with the **+** or **-** button to the Lighting submenu.
- ▶ Press button **▲** or **▼** repeatedly until you see this message in the display: Lamp circuit headlamp.

The selection marker is on the current setting.



- ▶ Press **+** or **-** to select manual or daytime running lamp (constant) mode. This function is not available in countries where daytime running lamps are mandatory.

With daytime running lamp mode selected and the exterior lamp switch at position **0**, the following lamps will come on automatically when the engine is turned on:

- Parking lamps and low beam headlamps
- License plate lamps (in low ambient light conditions)



If you turn the exterior lamp switch to another position, the corresponding lamp(s) will switch on.

For safety reasons, resetting the Lighting submenu to factory settings (▷ page 131) will not reset the daytime running lamp mode.

In the display you will then see the message: Lighting

Setting locator lighting

During darkness, the following lamps will come on when the locator lighting feature is activated and the vehicle is unlocked by remote control:

- Parking lamps
- Tail lamps
- License plate lamps
- Front fog lamps

The exterior lamp switch must be set to position **AUTO** (▷ page 112).

The locator lighting switches off when the driver's door is opened. It switches off automatically after a period of approximately 40 seconds.

- ▶ Move the selection marker with the **+** or **-** button to the Lighting submenu.
- ▶ Press button **▲** or **▼** repeatedly until you see this message in the display: Function Surround lighting.

Controls in detail

Control system



The selection marker is on the current setting.

- ▶ Press **+** or **-** to select the desired setting.
- ▶ Turn the exterior lamp switch to position **AUTO**.

The locator lighting will be switched on or off.

Ambient light level

Using this function, you can adjust the brightness of the ambient lighting.

- ▶ Move the selection marker with the **+** or **-** button to the Lighting submenu.



- ▶ Press button **▲** or **▼**, repeatedly until you see the message Ambient light Level in the display.

The selection marker is on the current setting.

- ▶ Press **+** or **-** to select the brightness of the lighting. 1 represents the darkest setting and 5 represents the brightest setting.

The ambient light is switched off below setting 1 or above setting 5. The selection marker points to off.

Setting night security illumination (Exterior lamps delayed switch-off)

Use the Headlamps delayed shut-off function to set whether and for how long you would like the exterior lamps to illuminate during darkness after all doors are closed. When the delayed switch-off feature is activated, the following lamps will remain lit after you remove the key from the starter switch:

- Parking lamps
- Tail lamps
- License plate lamps
- Front fog lamps

The exterior lamp switch must be set to position **AUTO** (▷ page 112).



You can reactivate this function within ten minutes by opening a door.

If you do not open a door after removing the key, the lamps will automatically switch off after 60 seconds.

- ▶ Move the selection marker with the **+** or **-** button to the Lighting submenu.
- ▶ Press button **▲** or **▼** repeatedly until you see this message in the display: Headlamps delayed shut-off.

The selection marker is on the current setting.



- ▶ Press **+** or **-** to select the desired lamp-on period.

You can select:

- 0 s, the delayed switch-off feature is deactivated.
 - 15 s, 30 s, 45 s or 60 s, the delayed switch-off feature is activated.
- ▶ Turn the exterior lamp switch to position **AUTO**.

You can temporarily deactivate the delayed switch-off feature:

- ▶ Before leaving the vehicle, turn the key in the starter switch to position **0**.
- ▶ Then turn it to position **2** and back to **0**.

The delayed switch-off feature is deactivated. It will reactivate as soon as you reinsert the key in the starter switch.

For vehicles with KEYLESS-GO*:

- ▶ Press the KEYLESS-GO start/stop button on the gear selector lever (▷ page 33).

Interior lighting delayed switch-off

Use this function to set whether and for how long you would like the interior lighting to remain lit during darkness after the key is removed from the starter switch.

- ▶ Move the selection marker with the **+** or **-** button to the Lighting submenu.
- ▶ Press button **▲** or **▼** repeatedly until you see this message in the display: Interior lamp delayed shut-off.

The selection marker is on the current setting.

Controls in detail

Control system



- ▶ Press **+** or **-** to select the desired lamp-on time period. You can select:
 - 0 s, the delayed switch-off feature is deactivated.
 - 5 s, 10 s, 15 s or 20 s, the delayed switch-off feature is activated.

Vehicle submenu



Access the Vehicle submenu via the Settings menu. Use the Vehicle submenu to make general vehicle settings. The following functions are available:

Function	Page
Set automatic locking	see below

Setting automatic locking

Use this function to activate or deactivate the automatic central locking. With the automatic central locking system activated, the vehicle is centrally locked at vehicle speeds of approximately 9 mph (15 km/h).

- ▶ Move the selection marker with the **+** or **-** button to the Vehicle submenu.

- ▶ Press button  or  repeatedly until you see this message in the display: Automatic door lock.

The selection marker is on the current setting.



- ▶ Press **+** or **-** to switch Automatic door lock on or off.

Convenience submenu

Access the Convenience submenu via the Settings menu. Use the Convenience submenu to change the settings for a number of convenience features. The following functions are available:

Function	Page
Activate easy-entry/exit feature	see below
Set key dependency	144
Set parking position for exterior rear view mirror	144

Activating easy-entry/exit feature*

Use this function to activate and deactivate the easy-entry/exit feature. When the feature is activated, the steering wheel and driver's seat will move back to facilitate exiting when you

- remove the key from the starter switch
- open the driver's door

However, the engine must be turned off.

Warning!



You must ensure that no one can become trapped or injured by the moving steering wheel and the driver's seat when the easy-entry/exit feature is in operation and the driver's door is being opened or the key is removed from the starter switch. Do not leave children unattended in the vehicle, or with access to an unlocked vehicle. Unsupervised use of vehicle equipment may cause serious personal injury.

Do not leave children unattended in the vehicle, or with access to an unlocked vehicle. Children could open the driver's door and unintentionally activate the easy-entry/exit feature, which could result in an accident or serious injury.

After entering the vehicle, the steering wheel and seat will move into the position stored in memory when

- the driver's door is closed
- you put the key in the starter switch

Controls in detail

Control system

- you press the appropriate stored position button on the memory switch (▷ page 110).



To cancel seat/steering wheel movement, do one of the following:

- Press seat adjustment switch (▷ page 35).
 - Move the steering column stalk (▷ page 38).
 - Press the memory switch (▷ page 110).
- ▶ Move the selection marker with the **+** or **-** button to the Convenience submenu.
- ▶ Press button **↶** or **↷** repeatedly until you see this message in the display: Function Easy-entry feature. The selection marker is on the current setting.

Controls in detail

Control system





- ▶ Press **+** or **-** to change the easy-entry/exit setting.

The following settings are available for the easy-entry/exit feature:

off	The easy-entry/exit feature is deactivated.
Steering col.	Only the steering column is moved.
Steer. col. + seat	Both the steering column and the seat are moved.

Setting key dependency

Use this function to set whether the memory settings for the seats, the steering wheel and the mirrors should be stored separately for each key (▷ page 86).

- ▶ Move the selection marker with the **+** or **-** button to the Convenience submenu.
- ▶ Press button  or  repeatedly until you see this message in the display: Key-dependent.

The selection marker is on the current setting.



- ▶ Press **+** or **-** to set key dependency to on or off.

Setting parking position for exterior rear view mirror

Use the Mirror adjustment parking aid function to select whether the passenger-side exterior rear view mirror should be turned downward during parking maneuvers (when reverse gear is engaged) (▷ page 111).

The exterior rear view mirror will return to its previous position when you

- shift out of reverse (after 10 seconds)
- exceed a speed of 6 mph (10 km/h), regardless of which gear is engaged
- press the driver's side mirror button (immediately) (▷ page 28).

- ▶ Move the selection marker with the **+** or **-** button to the Convenience submenu.
- ▶ Press button **↕** or **↔** repeatedly until you see this message in the display: Mirror adjustment parking aid.
The selection marker is on the current setting.



- ▶ Press **+** or **-** to switch function on or off.

Dynamic seat* submenu

Access the Dynamic Seat submenu via the Settings menu. Use the Dynamic Seat submenu to change the settings for the dynamic seats. The following functions are available:

Function	Page
Adjust driver seat	141
Adjust passenger seat	141

Adjusting the dynamic seat

The function dynamic seat adjustment lets you determine the way the seat adjusts while driving.

- ▶ Move the selection marker with the **+** or **-** button to the Dynamic Seat submenu.
- ▶ Press button **↕** or **↔** repeatedly until you see this message in the display: Dyn. Multi-cont. Seat, driver for the driver seat or Dyn. Multi-cont. Seat, fr. pass. for the passenger seat.

The selection marker is on the current setting.

Controls in detail

Control system



- ▶ Press **+** or **-** to switch function Level 1 or Level 2.

Trip computer menu





Use the trip computer menu to call up statistical data on your vehicle. The following information is available:

Function	Page
Fuel consumption statistics after start	see below
Fuel consumption statistics since last reset	146
Call up range (distance to empty)	147

Controls in detail

Control system



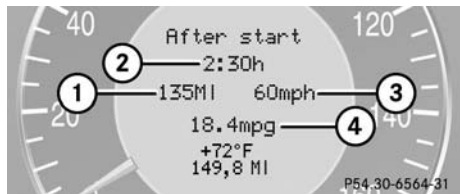

Fuel consumption statistics after start

- ▶ Press button  or  repeatedly until you see the first function of the Trip computer menu.
- ▶ Press button  or  repeatedly until you see this message in the left display: After start.



- 1 Distance driven since start
- 2 Time elapsed since start
- 3 Average speed since start
- 4 Average fuel consumption since start

Fuel consumption since last reset

- ▶ Press button  or  repeatedly until you see the first function of the Trip computer menu.
- ▶ Press button  or  repeatedly until you see this message in the display: After reset.

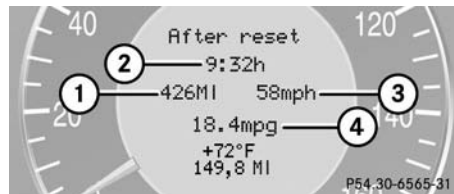





- 1 Distance driven since last reset
- 2 Time elapsed since last reset
- 3 Average speed since last reset
- 4 Average fuel consumption since last reset

i





All statistics stored since the last engine start will be reset approximately four hours after the key in the starter switch is turned to position **0** or removed from the starter switch.

Resetting will not occur if you turn the key back to position **1** or **2** within this time period.

Resetting fuel consumption statistics

- ▶ Press button  or  repeatedly until you see the first function of the Trip computer menu.
- ▶ Press button  or  repeatedly until you see the reading that you want to reset in the display.
- ▶ Press and hold the reset knob in the instrument cluster (▷ page 22) until the value is reset to 0.

Call up range (distance to empty)

- ▶ Press button  or  repeatedly until you see the first function of the Trip computer menu.
- ▶ Press button  or  repeatedly until you see this message in the display: Range :

In the display you will see the calculated range based on the current fuel tank level.



TEL menu*

Warning!



A driver's attention to the road must always be his/her primary focus when driving. For your safety and the safety of others, we recommend that you pull over to a safe location and stop before placing or taking a telephone call. If you choose to use the telephone while driving, please use the hands-free device and only use the telephone when road and traffic conditions permit.

Some jurisdictions prohibit the driver from using a cellular telephone while driving a vehicle.



Bear in mind that at a speed of just 30 mph (approximately 50 km/h), your vehicle is covering a distance of approximately 44 feet (approximately 13.5 m) every second.

Controls in detail

Control system

Never operate radio transmitters equipped with a built-in or attached antenna (i.e. without being connected to an external antenna) from inside the vehicle while the engine is running. Doing so could lead to a malfunction of the vehicle's electronic system, possibly resulting in an accident and personal injury.

You can use the functions in the TEL menu to operate your telephone, provided it is connected to a hands-free system and switched on.

- ▶ Switch on the telephone and COMAND*.
- ▶ Press button  or  on the steering wheel repeatedly until you see the Tel menu in the display.

Which messages will appear in the display field depends on whether your telephone is switched on or off:

- If the telephone is off, the message in the multifunction display is: PHONE OFF.

- If the telephone is on:

The telephone will then search for a network. During this time the display is empty.

As soon as the telephone has found a network, this is indicated in the display.



This standby message indicates that your telephone is ready for use and you can operate it using the control system.

Answering a call

When your telephone is ready to receive calls, you can answer a call at any time. In the display you will then see the message:



- ▶ Press button .

You have answered the call. In the display you see the length of the call.



If you do not wish to accept a call, press button .





Ending a call

- ▶ Press button .

You have ended the call. In the display you will again see the standby message.



Dialing a number from the phone book

If your telephone is ready to receive calls, you may select and dial a number from the phone book at any time.

- ▶ Press button  or  repeatedly until you see the Tel menu in the display.
- ▶ Press button  or .



The control system reads the phone book which is stored in the telephone. This may take up to 30 seconds. In the display you will see the message `Please wait`.

When the message `Please wait` disappears, the phone book has been loaded.

- ▶ Press button  or  repeatedly until the desired name appears in the display.

The stored names are displayed in increasing or decreasing alphabetical order.



If you press and hold  or  for longer than one second, the system scrolls rapidly through the list of names until you release the button again.

Cancel the quick search mode by pressing .

- ▶ Press button .

The system dials the selected phone number.

- If the connection is successful, the name of the party you called and the duration of the call will appear in the display.

Controls in detail



Control system



- If no connection is made, the control system stores the dialed number in the redial memory.

Redialing

The control system stores the most recently dialed phone numbers. This eliminates the need to search through your entire phone book.



- ▶ Press button  or  repeatedly until you see the Tel menu in the display.

Controls in detail

Control system

- ▶ Press button .

In the display you see the first number in the redial memory.

- ▶ Press button  or  repeatedly until the desired name appears in the display.

- ▶ Press button .

The control system dials the selected phone number.

Automatic transmission

Information for driving with an automatic transmission is found in the "Getting started" section (▷ page 43).

Your transmission adapts its gear shifting process to your individual driving style by continually adjusting the shift points up or down. These shift point adjustments are performed based on current operating and driving conditions.

If the operating conditions change, the automatic transmission reacts by adjusting its gear shift program.



During the brief warm-up, the transmission upshifting is delayed. This allows the catalytic converter to heat up more quickly to operating temperatures.

The automatic transmission selects individual gears automatically, depending on

- the selector lever position **D** with gear ranges **4, 3, 2, 1** (▷ page 153)
- the selected shift program (**W/S**) (▷ page 155)
- the position of the accelerator pedal (▷ page 156)
- the vehicle speed

The current selector lever position and shift program (**W/S**) appear in the speedometer display (▷ page 121).

An additional indication of the current selector lever position can be found on the cover of the shifting-gate. The indicators come on when you activate a switch (e.g. unlocking the vehicle or opening a door) and go out after approximately 15 minutes.

Controls in detail

Automatic transmission

Warning!



It is dangerous to shift the selector lever out of P or N if the engine speed is higher than idle speed. If your foot is not firmly on the brake pedal, the vehicle could accelerate quickly forward or reverse. You could lose control of the vehicle and hit someone or something. Only shift into gear when the engine is idling normally and when your right foot is firmly on the brake pedal.

When the selector lever is in position **D**, you can influence transmission shifting by

- limiting the gear range
- changing gears yourself

Controls in detail

Automatic transmission

One-touch gearshifting

Even with an automatic transmission you can change the gears yourself when the selector lever is in position **D**.

Downshifting

- ▶ Briefly press the selector lever to the left in the **D-** direction.

The transmission will shift from the current gear to the next lower gear. This action simultaneously limits the gear range of the transmission (> page 153).

Warning!



On slippery road surfaces, never downshift in order to obtain braking action. This could result in drive wheel slip and reduced vehicle control. Your vehicle's ABS will not prevent this type of loss of control.



To avoid overrevving the engine when the selector lever is moved to the **D-** direction, the transmission will not shift to a lower gear if the engine's max. speed would be exceeded.

Upshifting

- ▶ Briefly press the selector lever to the right in the **D+** direction.

The transmission will shift from the current gear to the next higher gear as permitted by the shift program. This action simultaneously extends the gear range of the transmission.

Canceling gear range limit

- ▶ Press and hold the selector lever in the **D+** direction until **D** reappears in the tachometer display field.

The transmission will shift from the current gear range directly to gear range **D**.

Shifting into optimal gear range

- ▶ Press and hold the gear selector lever in the **D-** direction.

The transmission will automatically select the gear range suited for optimal acceleration and deceleration. This will involve shifting down one or more gears.

Gear ranges

With the selector lever in position **D**, you can limit the transmission's gear range by pressing the lever to the left (**D-**), and reverse the gear range limit by pressing the lever to the right (**D+**).

The selected gear range will appear in the tachometer display field. If you press on the accelerator when the engine has reached its rpm limit, the transmission will upshift beyond any gear range limit selected.

Gear range

4

Effect

The transmission shifts through fourth gear only.

3

The transmission shifts through third gear only.

With this selection you can use the braking effect of the engine.

Gear range

2

Effect

The transmission shifts through second gear only.

Allows the use of the engine's braking power when driving

- on steep downgrades
- in mountainous regions
- under extreme operating conditions

1

The transmission operates only in first gear.

For maximum use of the engine's braking effect on very steep or lengthy downgrades.

Controls in detail

Automatic transmission

Controls in detail

Automatic transmission

Gear selector lever position

Effect

P Park position

Selector position when the vehicle is parked. Only place selector lever in position **P** when vehicle is stopped. The park position is not intended to serve as a brake when the vehicle is parked. Rather, the driver should always set the parking brake in addition to placing the selector lever in position **P** to secure the vehicle.

The key can only be removed from the starter switch with the selector lever in position **P**. With the key removed the selector lever is locked in position **P**.

Effect

R Reverse gear

Place selector lever in position **R** only when vehicle is stopped.

N Neutral

No power is transmitted from the engine to the drive axle. When the brakes are released, the vehicle can be moved freely (pushed or towed).

To avoid damage to the transmission, never engage **N** while driving.

If the ESP is deactivated or malfunctioning:

Only move selector lever to **N** if the vehicle is in danger of skidding (e.g. on icy roads).

D Drive

The transmission shifts automatically. All five forward gears are available.



Coasting the vehicle, or driving for any other reason with selector lever in **N** can result in transmission damage that is not covered by the Mercedes-Benz Limited Warranty.

Warning!



Getting out of your vehicle with the selector lever not fully engaged in position **P** is dangerous. Also, position **P** alone is not intended to or capable of preventing your vehicle from moving, possibly hitting people or objects.

Always set the parking brake in addition to shifting to position **P** (▷ page 45).

When parked on an incline, turn the front wheels towards the road curb.

Warning!



When leaving the vehicle always remove the key from the starter switch, take the Smart-Key with KEYLESS-GO* (if so equipped) with you and lock the vehicle. Do not leave children unattended in the vehicle, or with access to an unlocked vehicle. Children could move the selector lever from position **P**, which could result in an accident or serious injury.

Program mode selector switch

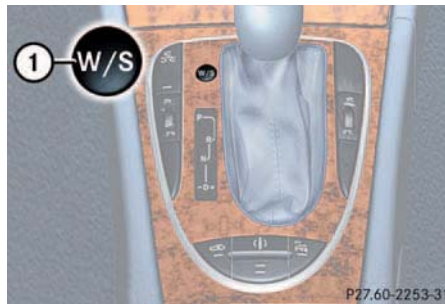

1 Program mode selector switch

S Standard For regular driving

W Winter For winter driving



Never change the program mode when the selector lever is out of position **P**. It could result in a change of driving characteristics for which you may not be prepared.

Controls in detail

Automatic transmission

- ▶ Press the program mode selector switch repeatedly until the letter of the desired shift program appears in the speedometer display field (▷ page 121).

Select **W** for winter driving:

- The vehicle starts out in second gear (both forward and reverse) for gentler starts. This does not apply if full throttle is applied or gear range **1** is selected.
- Traction and driving stability are improved on icy roads.
- Upshifts occur earlier even when you give more gas. The engine then operates at lower rpms and the wheels are less likely to spin.
- The power transmission ratio for selector lever position **R** changes depending on the program mode selected (**W** or **S**).

Controls in detail

Automatic transmission

Accelerator position

Your driving style influences the transmission's shifting behavior:

Less throttle	Earlier upshifting
More throttle	Later upshifting

Kickdown

Use kickdown when you want maximum acceleration.

- ▶ Press the accelerator past the point of resistance.

The transmission shifts into a lower gear.

- ▶ Ease on the accelerator when you have reached the desired speed.

The transmission shifts up again.

Emergency operation (Limp home mode)

If vehicle acceleration worsens or the transmission no longer shifts, the transmission is most likely operating in limp home (emergency operation) mode. In this mode, only 2nd gear and reverse gear can be activated.

- ▶ Stop the vehicle.
- ▶ Move selector lever to **P**.
- ▶ Turn off the engine.
- ▶ Wait at least ten seconds before re-starting.
- ▶ Restart the engine.
- ▶ Move selector lever to position **D** (for 2nd gear) or **R**.
- ▶ Have the transmission checked at an authorized Mercedes-Benz Center as soon as possible.

Good visibility

Information on the windshield wipers (▷ page 47) and for setting the rear view mirrors (▷ page 38) is found in the "Getting started" section.

Rear view mirror

Automatic antiglare rear view mirror

The reflection brightness of the exterior rear view mirror on the driver's side and the inside rear view mirror will respond automatically to glare when:

- the ignition is switched on, and
- incoming light from headlamps falls on the sensor in the inside rear view mirror

The rear view mirror will not react if

- reverse gear is engaged
- the interior lighting is turned on

Warning!



The automatic antiglare function does not react if incoming light is not aimed directly at sensors in the inside rear view mirror.

The inside rear view mirror and the exterior rear view mirror on the driver's side do not react.

Glare can endanger you and others.

Warning!



In the case of an accident liquid electrolyte may escape from the mirror housing if the mirror glass breaks.

Controls in detail

Good visibility

Electrolyte has an irritating effect. Do not allow the liquid to come into contact with eyes, skin, clothing, or respiratory system. In case it does, immediately flush affected area with water, and seek medical help if necessary.

Warning!



Exercise care when using the passenger side exterior rear view mirror. The mirror surface is convex (outwardly curved surface for a wider field of view). Objects in mirror are closer than they appear. Check your inside rear view mirror or glance over your shoulder before changing lanes.



Electrolyte drops coming into contact with the vehicle paint finish can be completely removed only while in the liquid state by applying plenty of water.

Controls in detail

Good visibility

Parking position*

For easier parking you can store a parking position for the passenger exterior rear view mirror (▷ page 111).

To activate the automatic mirror setting, see "Setting parking position for exterior rear view mirror" (▷ page 144).

If the passenger side mirror is selected (▷ page 111) the exterior rear view mirror will be turned downward in the stored position as soon as you engage reverse gear **R**.

The exterior rear view mirror returns to its previously stored driving position

- 10 seconds after you put the gear selector lever out of position **R**
- immediately once you exceed a speed of approx. 6 mph (10 km/h)
- immediately when you press the button for driver's side mirror (▷ page 39)

Headlamp cleaning system*

The button is located on the left side of the dashboard.



1 Headlamp washer button

- ▶ Switch on ignition.
- ▶ Press button **1**.

The headlamps are cleaned with a high-pressure water jet.

Information on filling up the washer reservoir can be found in the "Operation" section (▷ page 267).

Sun visors

The sun visors protect you from sun glare while driving.

Warning!



Do not use the vanity mirror while driving.

Keep the mirrors in the sun visors closed while vehicle is in motion. Reflected glare can endanger you and others.

- ▶ Swing sun visors down when you experience glare.

Controls in detail

Good visibility

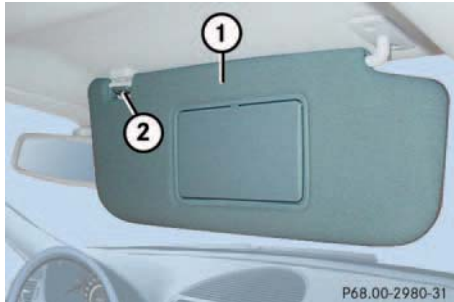

- 1 Sun visor
- 2 Mounting

- ▶ Swing sun visor **1** down when you experience glare.

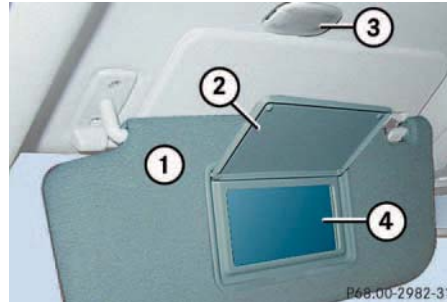

- 1 Sun visor
- 2 Mirror cover
- 3 Mirror lamp
- 4 Vanity mirror

- ▶ Make sure that the sun visor is properly engaged in the mounting.
- ▶ Lift the mirror cover to access the mirror.
- Lamp **3** switches on.

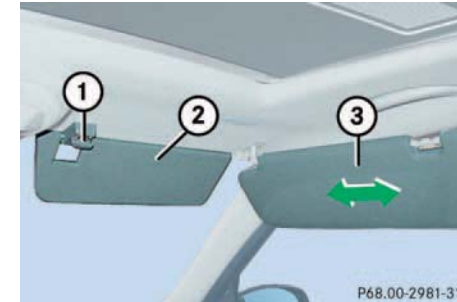

- 1 Mounting
- 2 Additional visor*
- 3 Sun visor

If sunlight enters through a side window:

- ▶ Disengage sun visor from mounting **1**.
- ▶ Pivot sun visor to the side.

The sun visors are extendable.

- ▶ Adjust the sun visors by pushing or pulling in the direction of the arrows.

Controls in detail

Good visibility



If sunlight enters through a side window, disengage sun visor from mounting **1** and pivot to the side.

Mirror lamp **3** will switch off.

Rear window sunshade*

The switch is located in the center console.

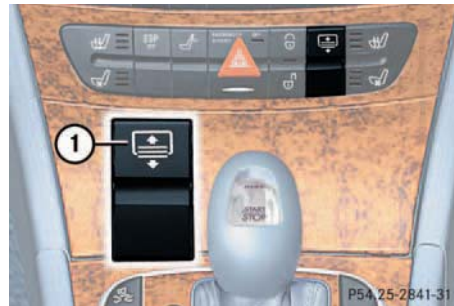

- ▶ Turn the key to starter switch position **1** or **2**. Vehicles with KEYLESS-GO*: press the start/stop button once or twice.
- ▶ Press the switch briefly at **1** to raise the sunshade.
- ▶ Press the switch briefly at **1** to lower the sunshade.

Always raise the sunshade fully for its support against the window frame.

Warning!



When operating the rear window sunshade, be sure that there is no danger of anyone being harmed by the raising or lowering procedure.

The raising or lowering procedure can be immediately halted by briefly pressing the upper or lower half of the switch.

Briefly press upper or lower half of the switch again to raise or lower the rear window sunshade completely.

Warning!



When leaving the vehicle, always remove the SmartKey from starter switch, and lock your vehicle. Do not leave children unattended in the vehicle, or with access to an unlocked vehicle. Unsupervised use of vehicle equipment can cause serious personal injury.

Roller sunblind* in the rear doors

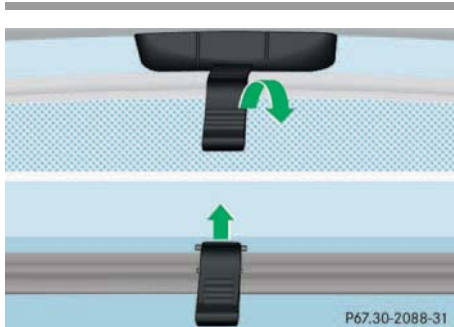

- ▶ Pull the roller sunblind out using the hooks.
- ▶ Attach the hooks at the top.



Always guide the sunblind by hand. Do not let it snap back, as the retractor could be damaged.

Controls in detail

Climate control

Climate control

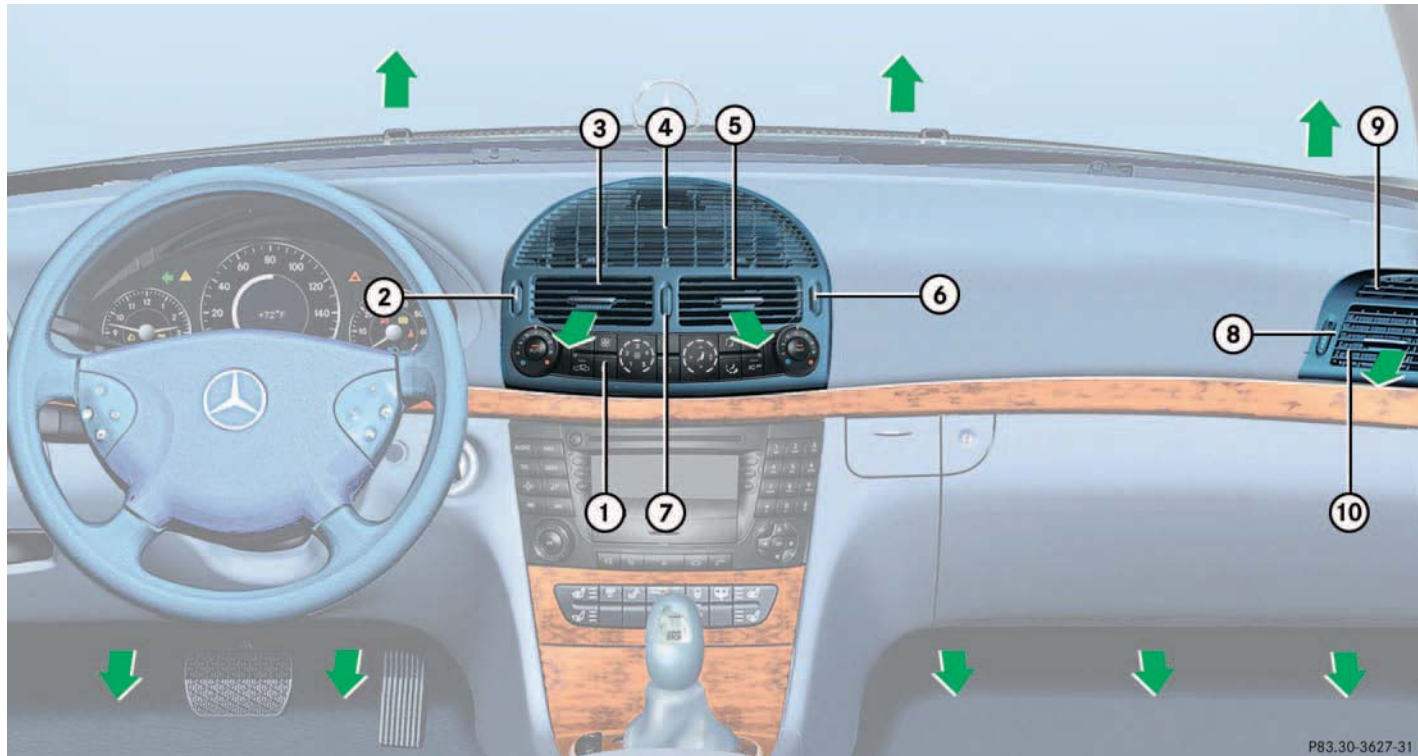

Controls in detail

Climate control

Item
1 Control panel
2 Thumbwheel, left center air outlet
3 Swiveling left center air outlet
4 Center air outlet
5 Swiveling right center air outlet
6 Thumbwheel, right center air outlet
7 Thumbwheel for adding cold air
8 Swiveling side air outlet
9 Side air defroster outlet, fixed
10 Side air outlet, adjustable

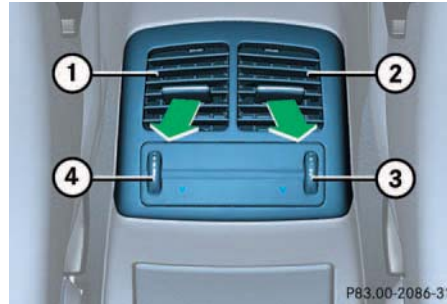

Rear air outlets

Item
1 Swiveling left rear center air outlet
2 Swiveling right rear center air outlet
3 Thumbwheel, right rear center air outlet
4 Thumbwheel, left rear center air outlet

The storage compartment between the front seats can be ventilated (▷ page 229).



For draft-free ventilation, move the sliders for the center outlets to the middle position.

Controls in detail

Climate control



1 Temperature, left

2 Windshield defroster

3 Increase airflow

4 MAX COOL display

5 Air distribution rocker switch

6 Rear window defroster

7 Temperature, right

8 Residual heat

9 Economy mode (no cooling)

10 Air distribution display

11 On/off

12 Airflow display

13 Decrease airflow

14 Air recirculation button

15 Air distribution and air volume (automatic)

The climate control is operational whenever the engine is running. You can operate the climate control system in either the automatic or manual mode. The system cools or heats the interior depending on the selected interior temperature and the current outside temperature.

Nearly all dust particles, pollutants and odors are filtered out before outside air enters the passenger compartment through the air distribution system.

The air conditioning will not engage (no cooling) if the **AC^{OFF}** mode is selected (▷ page 170).

Warning!



Follow the recommended settings for heating and cooling given on the following pages. Otherwise the windows could fog up, impairing visibility and endangering you and others.



If the vehicle interior is hot, ventilate the interior before driving off.

Keep the air intake grille in front of the windshield free of snow and debris.

Do not obstruct air flow by placing objects on the air flow-through exhaust slots below the rear window.

Setting the temperature

Use temperature controls **1** and **7** to separately adjust the air temperature on each side of the passenger compartment. You should raise or lower the temperature setting in small increments, preferably starting at 72°F (22°C).

Increasing

- ▶ Turn the control slightly to the right.
The climate control system will correspondingly adjust the interior air temperature.

Decreasing

- ▶ Turn the control slightly to the left.
The climate control system will correspondingly adjust the interior air temperature.





Controls in detail

Climate control

Adjusting air distribution

Adjusting manually

Use air distribution control **5** (▷ page 164) to adjust the air distribution.

Symbol	Function
	Directs air through the center, side and rear passenger compartment air outlets
	Directs air to the windows
	Directs air into the entire vehicle interior
	Directs air to the footwells

- ▶ Press air distribution rocker switch **5** (▷ page 164).

The indicator lamp on the **AUTO** button goes out.

The current air distribution appears in the air distribution display **10**.

Adjusting automatically

- ▶ Press the **AUTO** button.

The indicator lamp on the button comes on. The air distribution and volume is adjusted automatically.

Adjusting center air outlets:

The thumbwheels for left **2** and right **6** center air outlets are automatically positioned for optimum interior airflow. In this position, center air outlet **4** and swiveling left and right center outlets **3** and **5** are fully opened.

Heating:

Only in manual mode is it possible to lower the temperature in the headroom by regulating the cold-airflow using thumbwheel **7** (▷ page 162).



Windshield fogged on the outside

- ▶ Switch the windshield wipers on.
- ▶ Press the **AUTO** button.

Adjusting air volume

Adjusting manually

Five blower speeds are available.

- ▶ Press  to decrease or  to increase air volume to the desired level.

The **Auto** display disappears and the automatic mode is switched off. The selected blower speed is shown in the display.

Adjusting automatically

- ▶ Press the **AUTO** button.
The air volume is adjusted automatically.

Maximum cooling MAX COOL

If the left air distribution/airflow volume control **15** (▷ page 164) is set to **AUTO** and there is a high need for cooling, the display "MAX COOL" **4** (▷ page 164) appears in the climate control.

This provides the fastest possible cooling of the vehicle interior (when windows and sliding/pop-up roof are closed).

Defrosting



These settings should only be selected for a short time.

Activating

- ▶ Press button .
The indicator lamp on the button comes on.
- or
- ▶ Switch off air recirculation, if selected. Press button .
The indicator lamp on the button goes out.
- ▶ Close center air outlets.
- ▶ Open left and right side air outlets and adjust side air outlets upwards.

Deactivating

- ▶ Press button .

Controls in detail

Climate control

The indicator lamp on the button goes out. Defrosting is turned off.

Air recirculation mode

Switch to air recirculation mode to prevent unpleasant odors from entering the vehicle from the outside. This setting cuts off the intake of outside air and recirculates the air in the passenger compartment.

Warning!



When the outside temperature is below 41°F (5°C), only switch to air recirculation mode for short periods to prevent window fogging.

Controls in detail

Climate control

Activating

- ▶ Press button .

The indicator lamp on the button comes on.



If you keep button  pressed, the side windows and sliding/pop-up roof* will be closed.



The air recirculation mode is activated automatically at high outside temperatures.

If you have turned off the air conditioner (▶ page 170) or the outside temperature is below 41°F (5°C), the air recirculation mode will not switch on automatically.

Warning!



Never operate the windows or sliding/pop-up roof* if there is the possibility of anyone being harmed by the opening or closing procedure.

In case the procedure causes potential danger, the procedure can be immediately halted by releasing the control button. To reverse direction of movement press button  for opening or  for closing.

Deactivating

- ▶ Press button .

The indicator lamp on the button goes out.



If you keep button  pressed, the side windows and sliding/pop-up roof* will be returned to their previous position.

The air recirculation mode is deactivated automatically:

- after five minutes if the outside temperature is below approximately 41°F (5°C)

- after five minutes if the air conditioner is turned off
- after 30 minutes if the outside temperature is above approximately 41°F (5°C)

At outside temperatures above 79°F (26°C), the system will not automatically switch back to outside air. A quantity of outside air is added after approximately 30 minutes.

Rear window defroster

The rear window defroster uses a large amount of power. To keep the battery drain to a minimum, switch off the defroster as soon as the rear window is clear. The defroster is automatically deactivated after approximately 6 to 17 minutes of operation depending on the outside temperature.

Activating

- ▶ Press button .

The indicator lamp on the button comes on.

Deactivating

- ▶ Press button  again.

The indicator lamp on the button goes out.

Controls in detail

Climate control

Warning!



Any accumulation of snow and ice should be removed from the rear window before driving. Visibility could otherwise be impaired, endangering you and others.



If the rear window defroster switches off too soon and the indicator lamp starts blinking, this means that too many electrical consumers are operating simultaneously and there is insufficient voltage in the battery. The system responds automatically by deactivating the rear window defroster.

As soon as the battery has sufficient voltage, the rear window defroster automatically turns itself back on.

Controls in detail

Climate control

Deactivating the climate control system

Deactivating

- ▶ Press button **0** (▷ page 164).

Reactivating

- ▶ Press button **0** again (▷ page 164).
or
- ▶ Press any button on the climate control panel (▷ page 164).

Air conditioner

The air conditioner is operational while the engine is running and cools the interior air to the temperature set by the operator.



Condensation may drip out from underneath the vehicle. This is normal and not an indication of a malfunction.

Deactivating

It is possible to deactivate the air conditioning (cooling) function of the climate control system. The air in the vehicle will then no longer be cooled or dehumidified.

- ▶ Press button **AC^{OFF}** (▷ page 164).

The indicator lamp on the button **AC^{OFF}** comes on.

Activating

Moist air can fog up the windows. You can dehumidify the air with the air conditioner.

- ▶ Press **AC^{OFF}** again (▷ page 164).

The indicator lamp on the button **AC^{OFF}** goes out.

The air conditioner uses the refrigerant R134a. This refrigerant is free of CFCs which are harmful to the ozone layer.



If the air conditioner cannot be turned on again, this indicates that the air conditioner is losing refrigerant. The compressor has turned itself off.

Have the air conditioner checked at the nearest authorized Mercedes-Benz Center.

Residual heat and ventilation*

With the engine switched off, it is possible to continue to heat or ventilate the interior for up to 30 minutes. This feature makes use of the residual heat produced by the engine.

Activating

- ▶ Turn the key in the starter switch to position **1** or remove it from the starter switch.
- ▶ Press button **REST** (▷ page 164).

The indicator lamp on button **REST** comes on.

Deactivating

- ▶ Press button **REST** (▷ page 164).

The indicator lamp on button **REST** goes out.

The residual heat is automatically turned off:

- when the ignition is switched on
- after about 30 minutes
- if the battery voltage drops



How long the system will provide heating depends on the coolant temperature and the temperature set by the operator. The blower will run at speed setting **1** regardless of the air distribution control setting.

Controls in detail

Automatic climate control*

Automatic climate control*

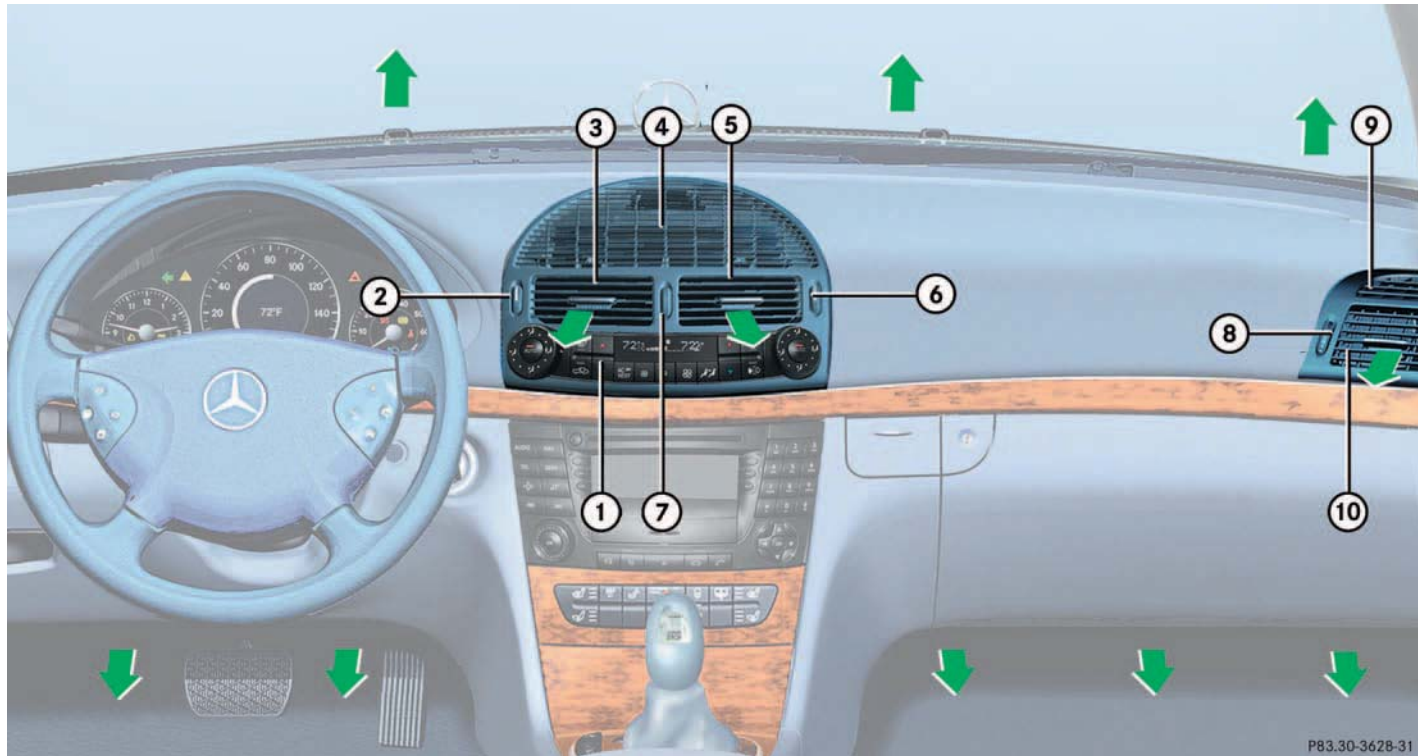

- 1 Automatic climate control panel
- 2 Thumbwheel center air outlet, left
- 3 Adjustable center air outlet, left
- 4 Air outlet
- 5 Adjustable center air outlet, right
- 6 Thumbwheel center air outlet, right
- 7 Thumbwheel for adding cold air
- 8 Adjustable side air outlet
- 9 Side air defroster outlet, fixed
- 10 Side air outlet, adjustable

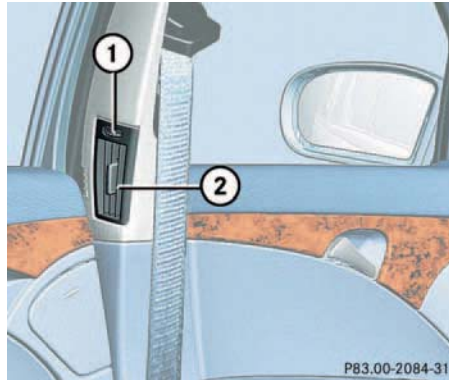

- 1 Thumbwheel for side air outlet
- 2 Adjustable side air outlet

Controls in detail

Automatic climate control*

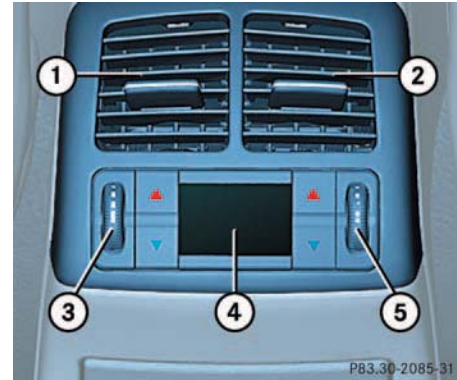

- 1 Adjustable center air outlet, left
- 2 Adjustable center air outlet, right
- 3 Thumbwheel for center air outlet, left
- 4 Control panel for rear air conditioning
- 5 Thumbwheel for center air outlet, right

Controls in detail

Automatic climate control*

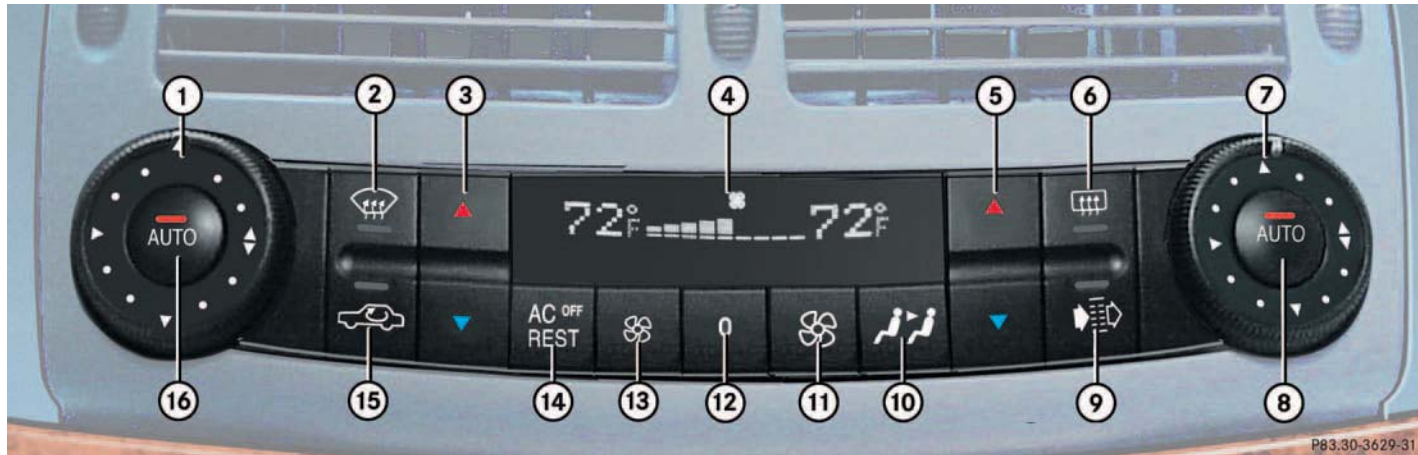

- 1 Air distribution, left
- 2 Windshield defroster
- 3 Temperature rocker switch, left
- 4 Display
- 5 Temperature rocker switch, right
- 6 Rear window defroster
- 7 Air distribution, right

- 8 Automatic air distribution, right and blower speed
- 9 Activated charcoal filter
- 10 Rear air-conditioning remote control
- 11 Increase airflow
- 12 On/off

- 13 Decrease airflow
- 14 Economy mode (no cooling)
Residual heat
- 15 Air recirculation button
- 16 Automatic air distribution, left and blower speed

The automatic climate control is a 4-zone intelligent climate control system. Your vehicle interior is divided into 4 zones.

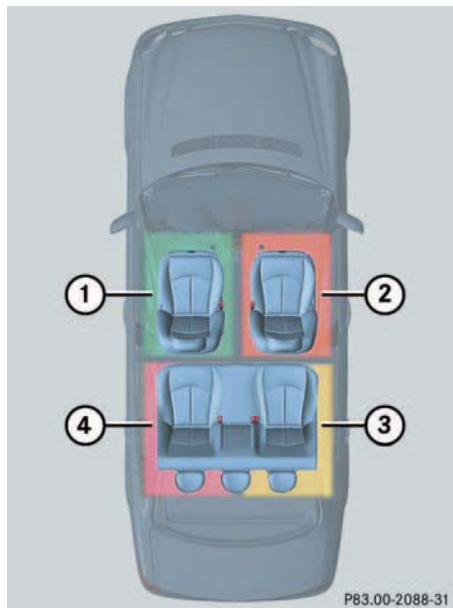

With the help of a sun sensor, the automatic climate control determines the relation of the sun to the vehicle and automatically adjusts the inside temperature for every individual zone.

You can set the temperature for each of the 4 zones separately. These settings can be assigned to a key and stored in memory (▷ page 144).

The automatic climate control is operational whenever the engine is running. It cools the vehicle's interior according to the angle and intensity of the sun's rays, the outside temperature and the selected temperature.



Condensation may drip from underneath the vehicle. This is normal and not an indication of a malfunction.

Controls in detail

Automatic climate control*

The activated charcoal filter, when switched on, markedly reduces odors and removes pollutants from the air entering the passenger compartment.



If the interior has been heated, air the vehicle out before driving.

Keep the air intake between the hood and the windshield free of snow.

Do not cover the ventilation slot between the rear shelf and the rear window.

The automatic climate control is operational whenever the engine is running. You can operate the climate control system in either the automatic or manual mode. The system cools or heats the interior depending on the selected interior temperature and the current outside temperature.

Controls in detail

Automatic climate control*

Nearly all dust particles, pollutants and odors are filtered out before outside air enters the passenger compartment through the air distribution system.

The air conditioning will not engage (no cooling) if the economy mode **AC^{OFF}** is selected (▷ page 174).

Warning!



Follow the recommended settings for heating and cooling given on the following pages. Otherwise the windows could fog up, impairing visibility and endangering you and others.



If the vehicle interior is hot, ventilate the interior before driving off.

Keep the air intake grille in front of the windshield free of snow and debris.

Do not obstruct air flow by placing objects on the air flow-through exhaust slots below the rear window.

Setting the temperature

Use temperature control **3** for the left side or **5** for the right side to separately adjust the air temperature on each side of the passenger compartment. You should raise or lower the temperature setting in small increments, preferably starting at 72°F (22°C).



When operating the climate control system in automatic mode, you will only rarely need to adjust the temperature, air volume and air distribution.

Increasing

- ▶ Push top of temperature control rocker switch **3** and/or **5**.

The automatic climate control system will correspondingly adjust the interior air temperature.

Decreasing

- ▶ Push bottom of temperature control rocker switch **3** and/or **5**.

The automatic climate control system will correspondingly adjust the interior air temperature.

Heating:









Only in manual air distribution mode is it possible to lower the temperature in the headroom by adding outside air using thumbwheel **7** (▷ page 172) in the dashboard.

Adjusting air distribution

Adjusting manually

- ▶ Turn air distribution controls **1** and **7** (▷ page 174) to manually adjust to the desired air distribution on each side of the passenger compartment.

The indicator lamp in the **AUTO** button goes out.

Symbol		Function
Set 1	Set 2	
		Directs air through the center, side and rear passenger compartment air outlets
		Directs air to the windows
		Directs air into the entire vehicle interior
		Directs air to the footwells

The following pages use symbol set 1 to explain the operation of the air distribution control. Please see above chart for reference to the corresponding function of symbol set 2 should your vehicle show those on the air distribution control switch.

Adjusting automatically

- ▶ Press left or right **AUTO** button again.
The indicator lamp in the **AUTO** button illuminates. The air distribution is adjusted automatically



Windshield fogged on the outside

- ▶ Switch the windshield wipers on.
- ▶ Press the left or right **AUTO** button.

Adjusting air volume

Adjusting manually

Nine blower speeds are available.

- ▶ Press  to decrease or  to increase air volume to the desired level.

The Auto display disappears and the automatic mode is switched off. The selected blower speed is shown in the display.

Adjusting automatically

- ▶ Press left or right **AUTO** button.
The air volume is adjusted automatically.

Maximum cooling MAX COOL

If the left and right air distribution controls as well as the airflow volume control are set to **AUTO** and there is a high need for cooling, the display "MAX COOL" appears in the front and rear display.

Controls in detail

Automatic climate control*

This provides the fastest possible cooling of the vehicle interior (when windows and sliding/pop-up roof are closed).

Defrosting



These settings should only be selected for a short time.

Activating

- ▶ Press button

The indicator lamp on the button comes on.

- ▶ Switch off air recirculation, if selected.
 - ▶ Press button
- The indicator lamp on the button goes out.
- ▶ Close center air outlets.
 - ▶ Adjust side air outlets upwards.

Deactivating

- ▶ Press button

The indicator lamp on the button goes out. Defrosting is turned off.

Air recirculation mode

Switch to air recirculation mode to prevent unpleasant odors from entering the vehicle from the outside. This setting cuts off the intake of outside air and recirculates the air in the passenger compartment.

Warning!



When the outside temperature is below 41°F (5°C), only switch to air recirculation mode for short periods to prevent window fogging.

Activating

- ▶ Press button

The indicator lamp on the button comes on.



If you keep button pressed, the side windows and the sliding/pop-up roof* will be closed.

The air recirculation mode is activated automatically:



- at high outside temperatures
- if the concentration of carbon monoxide and nitrogen oxide in the outside air increases, for example in a tunnel (charcoal filter activated (▷ page 180))

If you have turned off the air conditioner (▷ page 170) or the outside temperature is below 41°F (5°C), the air recirculation mode will not switch on automatically.

Warning!



Never operate the windows or sliding/pop-up roof* if there is the possibility of anyone being harmed by the opening or closing procedure.

In case the procedure causes potential danger, the procedure can be immediately halted by releasing the control button. To reverse direction of movement press button  for opening or  for closing.

Deactivating

- ▶ Press button .

The indicator lamp on the button goes out.



If you keep button  pressed, the side windows and the sliding/pop-up roof* will be returned to their previous position.

Controls in detail

Automatic climate control*

The air recirculation mode is deactivated automatically:

- after five minutes if the outside temperature is below approximately 41°F (5°C)
- after five minutes if the air conditioner is turned off (**AC^{OFF}**)
- after 30 minutes if the outside temperature is above approximately 41°F (5°C)

At outside temperatures above 79°F (26°C) the system will not automatically switch back to outside air. A quantity of outside air is added after approximately 30 minutes.

Controls in detail

Automatic climate control*

Charcoal filter

An activated charcoal filter markedly reduces bad odors and removes pollutants from air entering the passenger compartment.

Activating

- ▶ Press button .

The indicator lamp on the button lights up.

The system switches automatically to the air recirculation mode if the carbon monoxide (CO) or nitrogen oxide (NO_x) concentration of the outside air increases beyond a predetermined level.



If you keep button  pressed, the side windows and the sliding/pop-up roof* will be closed.

Deactivating

- ▶ Press button .

The indicator lamp on the button goes out.



If you keep button  pressed, the side windows and the sliding/pop-up roof* will be returned to their previous position.

The automatic air recirculation mode does not function if economy mode **AC^{OFF}** is selected or if the outside temperature has fallen below 41°F (5°C).

The activated charcoal filter should be switched off when windows fog up on the inside, or if the passenger compartment needs to be quickly heated or cooled down.

Rear window defroster

The rear window defroster uses a large amount of power. To keep the battery drain to a minimum, switch off the defroster as soon as the rear window is clear. The defroster is automatically deactivated after approximately 6 to 17 minutes of operation depending on the outside temperature.

Activating

- ▶ Press button .

The indicator lamp on the button comes on.

Deactivating

- ▶ Press button  again.

The indicator lamp on the button goes out.

Warning!



Any accumulation of snow and ice should be removed from the rear window before driving. Visibility could otherwise be impaired, endangering you and others.



If the rear window defroster switches off too soon and the indicator lamp starts blinking, this means that too many electrical consumers are operating simultaneously and there is insufficient voltage in the battery. The system responds automatically by deactivating the rear window defroster.

As soon as the battery has sufficient voltage, the rear window defroster automatically turns itself back on.

Air conditioner

The air conditioner is operational while the engine is running and cools the interior air to the temperature set by the operator.



Condensation may drip out from underneath the vehicle. This is normal and not an indication of a malfunction.

Deactivating

It is possible to deactivate the air conditioning (cooling) function of the automatic climate control system. The air in the vehicle will then no longer be cooled or dehumidified.

- ▶ Press button **AC^{OFF}**.

The indicator lamp on the button **AC^{OFF}** lights up.

Controls in detail

Automatic climate control*

Activating

Moist air can fog up the windows. You can dehumidify the air with the air conditioner.

- ▶ Press **AC^{OFF}** again.

The indicator lamp on the **AC^{OFF}** button goes out.

The air conditioner uses the refrigerant R134a. This refrigerant is free of CFCs which are harmful to the ozone layer.



If the air conditioner cannot be turned on again, this indicates that the air conditioner is losing refrigerant. The compressor has turned itself off.

Have the air conditioner checked at the nearest authorized Mercedes-Benz Center.

Controls in detail

Automatic climate control*

Residual heat and ventilation

With the engine switched off, it is possible to continue to heat or ventilate the interior for up to 30 minutes. This feature makes use of the residual heat produced by the engine.

Activating

- ▶ Turn the key in the starter switch to position **1** or remove it from the starter switch.
- ▶ Press button **REST**.
The indicator lamp on button **REST** comes on.

Deactivating

- ▶ Press button **REST**.
The indicator lamp on button **REST** goes out.

The residual heat is automatically turned off

- when the ignition is switched on
- after about 30 minutes
- if the battery voltage drops



How long the system will provide heating depends on the coolant temperature and the temperature set by the operator. The blower will run at speed setting **1** regardless of the air distribution control setting.

Rear air conditioning

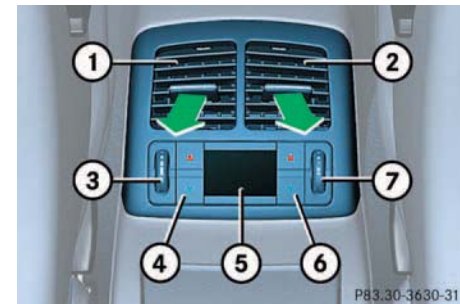

- 1 Swiveling left rear center air outlet
- 2 Swiveling right rear center air outlet
- 3 Thumbwheel, left rear center air outlet
- 4 Temperature rocker switch, left
- 5 Display
- 6 Temperature rocker switch, right
- 7 Thumbwheel, right rear center air outlet

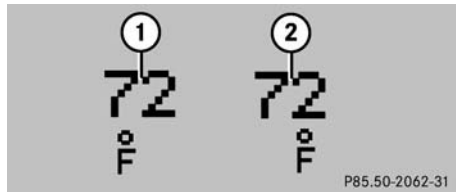

Display

- 1 Temperature, left
- 2 Temperature, right

Basic settings

We recommend setting the temperature on both the left- and right-hand sides to 72°F. This ensures a pleasant temperature in the rear of the vehicle.

The temperatures for the left- and right-hand sides can be set using temperature rocker switches **4** and **6**.



The rear air conditioning will not cool the air when economy mode **AC^{OFF}** has been selected in the front control panel.

Adjusting the rear settings with the front control panel

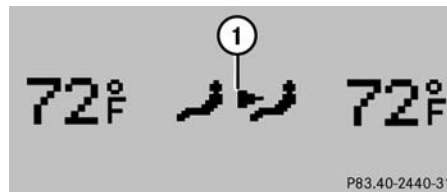

Display

- ▶ Press the  button (> page 174).

The display switches over.

The temperature for the rear left- and right-hand sides of the vehicle can be set with temperature rocker switches **3** and **5**.

Controls in detail

Automatic climate control*

The temperature display disappears approximately 5 seconds after the last key confirmation and switches back to the normal display.



The normal display will appear when the  button is pressed again.

Controls in detail

Power windows

Power windows

Opening and closing the windows

The side windows can be opened and closed electrically. The switches for all of the side windows are on the driver's door. The switches for the respective windows are on the front passenger and the rear doors.

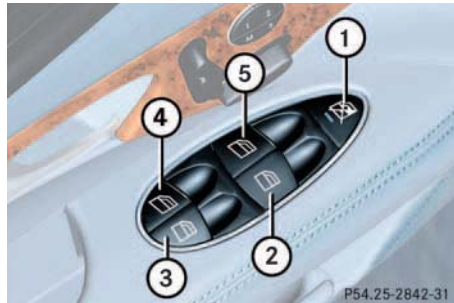

- 1 Rear window override switch
(▷ page 71)
- 2 Right front window
- 3 Right rear window
- 4 Left rear window
- 5 Left front window

Warning!



When closing the windows, be sure that there is no danger of anyone being harmed by the closing procedure.

In case of obstruction, the automatic reversal will not operate if a door window is being closed by pulling the switch and holding it, or when using the SmartKey.

The closing procedure of door windows can be immediately reversed by either pressing or pulling the switch, or pressing button  on the SmartKey and holding it.

When leaving the vehicle, always remove the key from starter switch, take it with you, and lock your vehicle. Do not leave children unattended in the vehicle, or with access to an unlocked vehicle. Unsupervised use of vehicle equipment can cause serious personal injury.

- ▶ Turn key in the starter switch to position **1** or **2**.

Opening the windows

- ▶ Press switch to resistance point.
The window will move downwards until you release the switch.

Closing the windows

- ▶ Pull on switch.
The window will move upwards until you release the switch.

Fully opening windows

- ▶ Press switch past resistance point and release.
The window opens completely.

Fully closing windows

- ▶ Pull switch past resistance point and release.

The window closes completely.

If the upward movement of the window is blocked during the closing procedure, the window will stop and open slightly.

Warning!



Driver's door only:



If within five seconds switch 1 is again pulled past the resistance point and released, the automatic reversal will not operate.

Stopping windows

- ▶ Press or pull respective switch again.



You can also open or close the windows using the following:

- SmartKey (summer opening/convenience feature), see below
- Button  in the control panel of the climate control (▷ page 164) or automatic climate control (▷ page 174)
- Button  in the control panel of the automatic climate control (▷ page 174)



Opening and closing the windows with the Smartkey

The sliding/pop-up roof* will also be opened or closed when the power windows are operated with the key (▷ page 188).

Warning!



Never operate the windows or sliding/pop-up roof* if there is the possibility of anyone being harmed by the opening or closing procedure.

In case the procedure causes potential danger, the procedure can be immediately halted by releasing the control button. To reverse direction of movement press button  for opening or  for closing.

- ▶ Aim transmitter eye at the front door handle.

Controls in detail

Power windows

Opening (Summer opening feature)

- ▶ Press and hold button  after unlocking the vehicle.
The windows and sliding/pop-up roof* begin to open after approximately one second.
- ▶ Release transmit button to interrupt procedure.

Closing (Convenience feature)

- ▶ Press and hold button  after locking the vehicle.
The windows and sliding/pop-up roof* begin to close after approximately one second.
- ▶ Release transmit button to interrupt procedure.

Ensure that all side windows and the sliding/pop-up roof* are properly closed before leaving the vehicle.

Synchronizing power windows

The power windows must be resynchronized each time after the battery has been disconnected.

- ▶ Pull the power window switches until the side windows are closed and hold the switches for approximately one second.

Sliding/pop-up roof*

Opening and closing the sliding/pop-up roof*

The sliding/pop-up roof can be opened and closed electrically. The switch for the sliding/pop-up roof is on the overhead control panel.



- 1 Push back to slide roof open
- 2 Push forward to slide roof closed
- 3 Push up to raise roof at rear
- 4 Pull down to lower roof at rear

With the roof closed or tilted open, a screen can be slid into the roof opening to guard against sun rays. When sliding the roof open, the screen will also retract.

Warning!



When closing the sliding/pop-up roof, be sure that there is no danger of anyone being harmed by the closing procedure.

The closing procedure of the sliding/pop-up roof can be immediately reversed by either moving the switch in any direction, or pressing button  on the key and holding it.

When leaving the vehicle, always remove the key from starter switch, take it with you, and lock your vehicle. Do not leave children unattended in the vehicle, or with access to an unlocked vehicle. Unsupervised use of vehicle equipment can cause serious personal injury.

Controls in detail

Sliding/pop-up roof*

- ▶ Turn the key in the starter switch to position **1** or **2**.

Opening and closing the sliding/pop-up roof

- ▶ To open, close, raise or lower the sliding/pop-up roof, move the switch to the resistance point in the required direction.

Release the switch when the roof has reached the required position.

Opening and closing the sliding/pop-up roof automatically

- ▶ Move the switch past the resistance point in the direction required and release.

The sliding/pop-up roof opens or closes completely.

Controls in detail

Sliding/pop-up roof*



Stopping the sliding/pop-up roof

- ▶ Move the switch in any direction.

If the movement of the sliding/pop-up roof is blocked during the closing procedure, the roof will stop and reopen slightly.



You can also open or close the sliding/pop-up roof using the following:

- SmartKey, see below
- Button  in the control panel of the climate control (▷ page 164) or automatic climate control (▷ page 174)
- Button  in the control panel of the automatic climate control (▷ page 174)



To avoid damaging the seals, do not transport any objects with sharp edges which can stick out of the sliding/pop-up roof.

Open the sliding/pop-up roof only if the roof is clear of snow or ice.

The sliding/pop-up roof can be opened or closed manually should an electrical malfunction occur (▷ page 331).

Opening and closing the sliding/pop-up roof with the SmartKey



The power windows will also be opened or closed when the sliding/pop-up roof is operated with the key (▷ page 185).

Warning!



Never operate the windows or sliding/pop-up roof if there is the possibility of anyone being harmed by the opening or closing procedure.

In case the procedure causes potential danger, the procedure can be immediately halted by releasing the remote control button.

To reverse direction of movement press  for opening or  for closing.

- ▶ Aim transmitter eye at the front door handle.

Controls in detail

Sliding/pop-up roof*

Opening (Summer opening feature)

- ▶ Press and hold button  after unlocking the vehicle.

The windows and sliding/pop-up roof begin to open after approximately one second.

- ▶ Release transmit button to interrupt procedure.

Closing (Convenience feature)

- ▶ Press and hold button  after locking the vehicle.

The windows and sliding/pop-up roof begin to close after approximately one second.

- ▶ Release transmit button to interrupt procedure.

Ensure that all side windows and the sliding/pop-up roof are properly closed before leaving the vehicle.

Synchronizing the sliding/pop-up roof

The power sliding/pop-up roof must be re-synchronized each time

- after the battery has been disconnected
- the sliding/pop-up roof has been closed manually (▷ page 331)
- the sliding/pop-up roof does not open smoothly
- a malfunction

Synchronizing

- ▶ Turn the key in the starter switch to position **1** or **2**.
- ▶ Press the switch in the "raise" direction until the sliding/pop-up roof is fully raised at the rear (▷ page 187).

Hold the switch for approximately one second.

Controls in detail

Panorama sliding/pop-up roof*

Panorama sliding/pop-up roof*

Panorama sliding/pop-up roof*

Warning!



When closing the panorama sliding/pop-up roof, ensure that no one is in danger of being injured.

If the panorama sliding/pop-up roof is closed with the convenience closing feature and becomes blocked, it will not open automatically.

Should this occur, press the release button on the key and hold it down; the panorama sliding/pop-up roof opens again.

Make sure to remove the key from the ignition lock even when leaving the vehicle for only a brief period of time.

In the event of an accident, the glass in vehicles with a glass roof may shatter.

If the vehicle rolls over, there is a danger of occupants without fastened seat belts being thrown out of the opening.

In this case there is an increased risk of injury even for passengers with fastened seat belts, as entire body parts or portions of them may protrude from the passenger compartment.

Opening and closing the roller sunblind

The roller sunblinds can only be opened or closed when the panorama sliding/pop-up roof is closed. The front and rear roller sunblind cannot be operated individually.



Panorama sliding/pop-up roof switch

- 1 Open
- 2 Close



Roller sunblind switch, rear

- 1 Open
- 2 Close

- ▶ Make sure that the ignition is turned on or press the KEYLESS-GO start/stop button*.
- ▶ Press the switch in the desired direction.
The sun roller sunblinds open.
- ▶ Release the switch when the roller sunblinds have reached the desired position.

Warning!



When closing the roller sunblinds, make sure that no one is in danger of being injured by the closing procedure.

Opening the roller sunblinds automatically

- ▶ Press the switch past the resistance point in direction **1** and release it again.
The roller sunblinds open completely.

Stopping the roller sunblinds

- ▶ Press the switch again in any direction.

Controls in detail

Panorama sliding/pop-up roof*

Opening and closing the panorama sliding/pop-up roof



- 1 Push back to slide roof open
- 2 Push forward to slide roof closed
- 3 Push back to raise roof
- 4 Push forward to lower roof

- ▶ Make sure that the ignition is turned on or press the KEYLESS-GO start/stop button*.
- ▶ Push the switch to the resistance point in the required direction.
The panorama sliding/pop-up roof opens.

Controls in detail

Panorama sliding/pop-up roof*

- ▶ Release the switch once the roof has reached the desired position.

Opening and closing the panorama sliding/pop-up roof automatically

- ▶ Press the switch past the resistance point in the desired direction.

The panorama sliding/pop-up roof opens completely.



Do not transport any objects that protrude out of the panorama sliding/pop-up roof as the seals could be damaged.

Stopping the panorama sliding/pop-up roof

- ▶ Press the switch again in any direction.



Opening and closing windows and panorama sliding/pop-up roof with the SmartKey

The power windows will also be opened or closed when the panorama sliding/pop-up roof is operated with the key (▷ page 185).

Warning!



Never operate the windows or sliding/pop-up roof if there is the possibility of anyone being harmed by the opening or closing procedure.

In case the procedure causes potential danger, the procedure can be immediately halted by releasing the remote control button. To reverse direction of movement press  for opening or  for closing.

- ▶ Aim transmitter eye at the front door handle.

Opening (Summer opening feature)

If roller blinds are closed:

- ▶ Press and hold button  after unlocking the vehicle.

The windows and roller blinds begin to open after approximately one second.

- ▶ Press and hold button  again.

The panorama sliding/pop-up roof tilts and opens.

If roller blinds are already open:

- ▶ Press and hold button  after unlocking the vehicle.

The windows move down and the panorama sliding/pop-up roof tilts and opens after approximately one second.

- ▶ Release transmit button to interrupt procedure.

Closing (Convenience feature)

- ▶ Press and hold button  after locking the vehicle.

The windows and panorama sliding/pop-up roof begin to close after approximately one second.

- ▶ Press and hold button  again.

The roller blinds close.

- ▶ Release transmit button to interrupt procedure.

Ensure that all side windows and the panorama sliding/pop-up roof are properly closed before leaving the vehicle.

Synchronizing the panorama sliding/pop-up roof

It is necessary to resynchronize the panorama sliding/pop-up roof after:

- voltage supply interruption due to a disconnected or discharged battery
 - the roof has been closed manually
 - the roof has been opened with an abrupt movement
 - a malfunction
- ▶ Remove the fuse from the main fuse box.
 - ▶ Replace the fuse in the main fuse box.
 - ▶ Turn the ignition on.
 - ▶ Press the switch in direction 3.
 - ▶ Wait until the panorama sliding/pop-up roof is raised and then keep the switch pressed for approximately 1 second.

Solar panel*

Combined with the panorama sliding/pop-up roof a solar panel is available. The solar cells convert natural light into electrical energy. When the engine is switched off, the energy generated automatically switches on the ventilation fan. The constant air flow creates a cooler temperature for cars parked in the sunlight.

The air flow depends on the intensity of the solar radiation. The ventilation starts 2 minutes after switching off the engine.

Controls in detail

Driving systems

Driving systems

The following driving systems are explained on the following pages:

- Cruise control
- DISTRONIC*
- AIRMATIC DC*
- Park assist (Parktronic*)

The BAS, ABS, ESP and SBC driving systems are described in the "Safety and Security" section (▷ page 73).

Cruise control

Cruise control automatically maintains the speed you set for your vehicle.

Use of cruise control is recommended for driving at a constant speed for extended periods of time. You can set any speed over 20 mph (30 km/h).

The cruise control function is operated by means of the cruise control lever.

The cruise control lever is the uppermost lever found on the left-hand side of the steering column (▷ page 20).

Warning!



Cruise control is a convenience system designed to assist the driver during vehicle operation. The driver must always remain responsible for the vehicle speed and for safe brake operation.

Only use cruise control if the traffic and weather conditions make it advisable to travel at a steady speed.

- The use of cruise control can be dangerous on winding roads or in heavy traffic because conditions do not allow safe driving at a steady speed.
- The use of cruise control can be dangerous on slippery roads. Rapid changes in tire traction can result in wheel spin and loss of control.
- Deactivate cruise control when driving in fog.

The "Resume" function should only be operated if the driver is fully aware of the previously set speed and wishes to resume this particular preset speed.

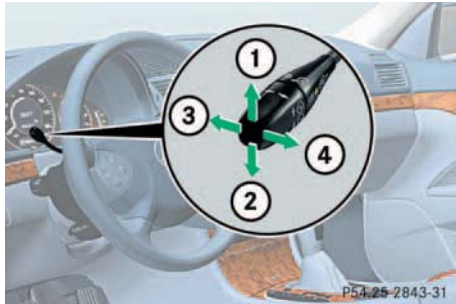

- 1 Set current or higher speed
- 2 Set current or lower speed
- 3 Cancel cruise control
- 4 Resume at previously set speed

Saving current speed

- ▶ Accelerate or decelerate to the desired speed.
- ▶ Briefly lift **1** or depress **2** the cruise control lever.
The current speed is set.
- ▶ Remove your foot from the accelerator pedal.
Cruise control is activated.



On uphill or downhill grades, cruise control may not be able to maintain the set speed. Once the grade eases, the set speed will be resumed.

Canceling cruise control

There are several ways to cancel cruise control:

- ▶ Step on the brake pedal.
- or
- ▶ Briefly push the cruise control lever to position **3**.

Cruise control will be canceled. The last speed set will be stored for later use.



Vehicles with automatic transmission:
Moving gear selector lever to position **N** while driving also cancels cruise control. However, the gear selector lever should not be moved to position **N** while driving except to coast when the vehicle is in danger of skidding (e.g. on icy roads).



Vehicles with manual transmission:
The set cruise controlled speed is switched off when declutching exceeds four seconds during downshifting a gear.



The last stored speed is canceled when you turn off the engine.

Controls in detail

Driving systems

Setting stored speed ("Resume" function)

Warning!



The speed stored in memory should only be set again if prevailing road conditions permit. Possible acceleration or deceleration differences arising from returning to preset speed could endanger yourself and others.

- ▶ Briefly push the cruise control lever to position **4**.
The cruise control will resume the last previously set speed.
- ▶ Remove your foot from the accelerator pedal.

Setting a higher speed

- ▶ Lift the cruise control lever to position **1** and hold it up until the desired speed is reached.
- ▶ Release the cruise control lever.
The new speed is set.



Depressing the accelerator pedal does not deactivate cruise control. After brief acceleration (e.g. for passing), cruise control will resume the last speed set.

Setting a lower speed

- ▶ Depress the cruise control lever to position **2** and hold it down until the desired speed is reached.
- ▶ Release the cruise control lever.
The new speed is set.



Vehicles with automatic transmission:
When you use the cruise control lever to decelerate, the transmission will automatically downshift if the engine's braking power does not brake the vehicle sufficiently.

Fine adjustment in 0.6 mph (1 km/h) increments

Faster

- ▶ Briefly tip the cruise control lever in the direction of arrow **1**.

Slower

- ▶ Briefly tip the cruise control lever in the direction of arrow **2**.

Distronic*

When activated, the Distronic adaptive cruise control system increases driving convenience afforded by the cruise control during travel on expressways and other major roads.

- If the Distronic distance sensor detects a slower moving vehicle directly ahead, your vehicle speed will be reduced so that you follow that vehicle at a preset distance.
- If there is no vehicle directly ahead of you, Distronic will function in the same way as cruise control (> page 201).

Warning!



Distronic adaptive cruise control is no substitute for active driving involvement. It does not react to stationary objects, nor recognize or predict the curvature and lane layout or the movement of vehicles ahead. Distronic can only apply a maximum of 20% of the vehicle's braking power.

It is the driver's responsibility at all times to be attentive to traffic and road conditions and to provide the steering, braking and other driving inputs necessary to retain control of the vehicle.

Warning!



Distronic is a convenience system. Its speed adjustment reduction capability is intended to make cruise control more effective and usable when traffic speeds vary. However, it is not intended to, nor does it, replace the need for extreme care. The responsibility for the vehicle speed and the distance to the vehicle ahead, including most importantly brake operation to assure safe stopping distance, always rests with the driver.

Distronic cannot take street and traffic conditions into account.

Controls in detail

Driving systems

Warning!



Distronic requires familiarity with its operational characteristics. We strongly recommend that you review the following information carefully before operating the system.



For operation in the USA only: This device complies with Part 15 of the FCC Rules. Operation is subject to the following two conditions:

- This device may not cause harmful interference, and
- this device must accept any interference received, including interference that may cause undesired operation.

Any unauthorized modification to this device could void the user's authority to operate the equipment.

Controls in detail

Driving systems

Warning!



Distronic cannot take street and traffic conditions into account. Only use DISTRONIC if the weather and traffic conditions make it advisable to travel at a steady speed.

Warning!



Use of DISTRONIC can be dangerous on slippery roads. Rapid changes in tire traction can result in wheel spin and loss of control.

DISTRONIC does not act upon adverse sight distance conditions. Do not use DISTRONIC during conditions of fog and heavy rain, snow or sleet.

Warning!



Close attention to road and traffic conditions is imperative at all times, regardless of whether or not DISTRONIC is activated.

Use of DISTRONIC can be dangerous on winding roads or in heavy traffic because conditions do not allow safe driving at a steady speed.

DISTRONIC will not react to stationary objects in the roadway (e.g. a stopped vehicle in a traffic jam or a disabled vehicle). DISTRONIC will also not respond to oncoming vehicles.

Switch off DISTRONIC:

- when changing from the left to the right lane if vehicles are moving more slowly in the left lane
- when entering a turn lane or highway off ramp
- in complex driving situations, such as in highway construction zones

In these situations, DISTRONIC will continue to maintain the set speed unless deactivated.

DISTRONIC is designed and intended only to maintain a set speed and keep a set distance from moving objects in front of it.

Warning!



The "Resume" function should only be operated if the driver is fully aware of the previously set speed and wishes to resume this particular preset speed.

Distronic displays in the speedometer dial



1 Set speed

If DISTRONIC is activated, one or two segments light up around the set speed.



The vehicle speed displayed on the speedometer can briefly vary from the speed setting on the DISTRONIC system.



1 Segments

If DISTRONIC detects a vehicle directly ahead, the segments from the speed of the vehicle ahead to the set speed light up.

If DISTRONIC calculates that there is a danger of collision:

- The DTR warning lamp  in the instrument cluster lights up red.
- An intermittent warning sounds.
- ▶ Immediately brake the vehicle to avoid a collision.

Under no circumstances should the driver await the intermittent warning sound before braking. See warning note on the next page.

The intermittent warning sound ceases and the red DTR warning lamp  goes out when the necessary distance to the vehicle ahead is again established.

Controls in detail

Driving systems

Warning!



An intermittent warning sounds and the DTR warning lamp in the instrument cluster is illuminated if the Distronic system calculates that the distance to the vehicle ahead and your vehicle's current speed indicate that Distronic will not be capable of slowing the vehicle sufficiently to maintain the preset following distance, which creates a danger of a collision.

Immediately brake the vehicle to increase the distance to the vehicle in front of you. The warning sound is intended as a final caution that you have not interceded with your own braking inputs to avoid a potentially dangerous situation. Do not wait for the operation of the warning signal to intercede with your own braking, as that will result in potentially dangerous emergency braking which will not always result in an impact being avoided.

Tailgating increases the risk of an accident.

Warning!



Distronic brakes your vehicle with a maximum deceleration of 6.5 ft/s² (2 m/s²). This corresponds to about 20% of the maximum deceleration ability of your vehicle.



Distronic brakes the vehicle in an effort to restore the preset distance or to maintain the speed. The brake pedal is automatically applied as this happens which results in the brake pedal moving.

Keep driver's foot area clear at all times, including the area under the brake pedal. Objects stored in this area may impair pedal movement which could interfere with the braking ability of the Distronic system.

Do not place your foot under the brake pedal – your foot could become caught.

Distronic menu in the control system

In the Distronic menu you can read the current settings for Distronic. What appears in the display depends on whether Distronic and the distance warning function are turned on or off.

- ▶ Press button  or  repeatedly until you see one of the following displays.

Controls in detail

Driving systems

Distronic deactivated

If DISTRONIC is deactivated you can see the standard display of DISTRONIC in the multifunction display.

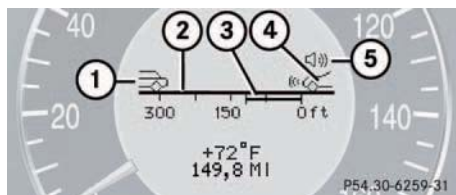

- 1 Vehicle ahead, if detected
- 2 Actual distance to vehicle ahead
- 3 Should-be distance to vehicle ahead
- 4 Your vehicle
- 5 Symbol for activated distance warning function

Distronic activated

If you turn DISTRONIC on, you will see the set speed in the multifunction display for about five seconds. If DISTRONIC is activated, you can see the following display in the multifunction display.

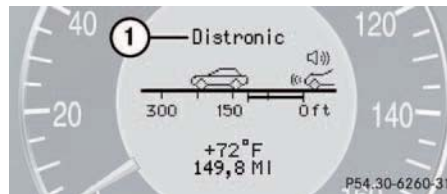

- 1 DISTRONIC activated

Cruise control lever

The DISTRONIC system is operated by means of the cruise control lever.

The cruise control lever is the uppermost lever found on the left-hand side of the steering column.

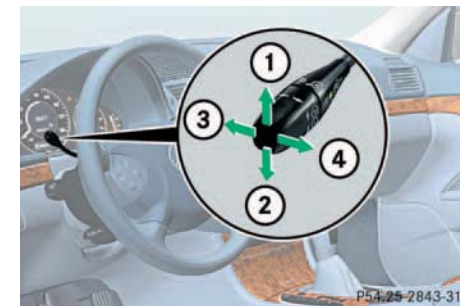

- 1 Set current or higher speed
- 2 Set current or lower speed
- 3 Deactivate DISTRONIC
- 4 Resume at previously set speed

Controls in detail

Driving systems

Activating Distronic

You can activate Distronic if:

- you are driving between 25 mph (Canada: 40 km/h) and 110 mph (Canada: 180 km/h)
- the ESP is activated (▷ page 75)

If Distronic has not been activated after pressing the cruise control lever you will see the message --- in the multifunction display.

In the following cases you cannot activate Distronic:

- Up to two minutes after starting the engine
- When you brake
- If you have set the parking brake
- If the gear selector lever is in position **P**, **R** or **N**
- If the ESP is switched off

Setting the current speed

- ▶ Accelerate or decelerate to the desired speed.
- ▶ Briefly lift or depress the cruise control lever.

Distronic is activated and the current speed is set.

- ▶ Remove your foot from the accelerator pedal.



If you do not take your foot off of the accelerator completely, the following message will appear in the multifunction display:
Distronic override. The distance to a slower moving vehicle in front of you will not be set. Your vehicle speed will then be determined only by the accelerator pedal position.

Setting a higher speed

- ▶ Briefly tip the cruise control lever in the direction of arrow **1** (▷ page 201) to increase vehicle speed in increments of 5 mph (Canada: 10 km/h).

The new speed is set.

The stored speed is displayed in the multifunction display for approximately five seconds (▷ page 201), and one or two segments around the stored speed light up on the speedometer (▷ page 199).



Depressing the accelerator pedal does not deactivate Distronic. After brief acceleration (e.g. for passing), cruise control will resume the last speed set.

Setting a lower speed

- ▶ Briefly tip the cruise control lever in the direction of arrow **2** (▷ page 201) to decrease vehicle speed in increments of 5 mph (Canada: 10 km/h).

The new speed is set.

The stored speed is displayed in the multifunction display for approximately five seconds (▷ page 199), and one or two segments around the stored speed light up on the speedometer (▷ page 199).



When you use the cruise control lever to decelerate, the transmission will automatically downshift if the rate of deceleration is too low.

Fine adjustment in 1 mph (Canada: 1 km/h) increments

Faster

- ▶ Briefly tip the cruise control lever in the direction of arrow **4** (▷ page 201).

Resetting stored speeds

Warning!



The speed stored in memory should only be set again if prevailing road conditions permit. Possible acceleration or deceleration differences arising from returning to preset speed could endanger yourself and others.

- ▶ Briefly tip the cruise control lever in the direction of arrow **4** (▷ page 201).
Distronic is set to the last stored speed.
- ▶ Remove your foot from the accelerator pedal.

Controls in detail

Driving systems

Deactivating Distronic

There are several ways to deactivate the Distronic system:

- ▶ Briefly tip the cruise control lever in the direction of arrow **3** (▷ page 201).

or

- ▶ Step on the brake pedal.

Distronic will be deactivated. The last speed set will be stored into memory.



The following message will appear in the multifunction display for approximately five seconds: *Distronic off*.

The last stored speed is deleted when you turn off the engine.

Distronic deactivates automatically when:

- you set the parking brake
- you drive slower than 25 mph (Canada: 40 km/h)
- the ESP is active (▷ page 75) or you deactivate the ESP
- you move the transmission selector lever into position **N**

A signal will sound. The *Distronic off* message appears in the multifunction display for approximately five seconds.

Warning!



Distronic switches off and releases the brakes when the vehicle decelerates below the minimum speed of approx. 25 mph (40 km/h) by operation of the system. At that time the driver must apply the brakes in order to reduce vehicle speed further or bring it to a stop.

Setting the following distance in Distronic

You can set the specified following distance for Distronic by varying the time setting between 1.0 and 2.0 seconds. Using this time setting and the current speed of your vehicle, Distronic calculates and sets the required following distance to the vehicle ahead. The set distance will be shown in the multifunction display field.

The thumbwheel for making the time setting is located on the lower section of the center console.

Warning!



It is up to the driver to exercise discretion to select the appropriate setting given road conditions, traffic, driver's preferred driving style and applicable laws and driving recommendations for safe following distance.



- 1 Distance warning function on/off switch
- 2 Control lamp
- 3 Thumbwheel for setting distance

Increasing distance

Increasing the distance setting tells Distronic to maintain a greater following distance to the vehicle ahead.

- ▶ Turn thumbwheel **3** towards .

Decreasing distance

Decreasing the distance setting tells Distronic to maintain a shorter following distance to the vehicle ahead.

- ▶ Turn thumbwheel **3** towards .

Distance warning function

When Distronic is deactivated, this function will continue to warn you when recognizing a stationary obstacle or a slower vehicle moving in the vehicle's path and the danger of a collision exists:

- The distance warning lamp  in the instrument cluster comes on.
- An intermittent warning sounds.

If these warnings are issued, you must brake manually to maintain a safe distance and avoid a collision with the vehicle ahead.

When pressing the brake pedal, the warning sound stops. The warning sound also stops when the distance to the vehicle

ahead is sufficient again without applying the brake pedal. In this case the distance warning lamp also extinguishes.

Warning!



If the DTR warning lamp  in the instrument cluster lights up while driving and/or an intermittent warning sounds, immediate attention on the part of the driver is required.

As required by the traffic situation, apply the brakes and navigate around a possible obstacle. However, do not drive by relying on the distance warning function, as this will result in an emergency braking application. Especially depending on road surface conditions and driver reaction, this will not always enable you to avoid a collision.



Complex driving situations are not always fully recognized by Distronic. This could result in wrong or missing distance warnings.

Controls in detail

Driving systems

Activating

- ▶ Press button **1**.

Indicator lamp **2** on the button lights up. A loudspeaker symbol appears in the multifunction display (▷ page 201).

Deactivating

- ▶ Press button **1**.

Indicator lamp **2** on the button goes out. No loudspeaker symbol appears in the multifunction display.

Driving with DISTRONIC

This section describes a number of driving situations where special precaution is required on the part of the driver. Be prepared to brake in such situations. This will deactivate the DISTRONIC system.

Warning!



DISTRONIC works to maintain the speed selected by the driver unless a moving obstacle proceeding directly ahead of it in the same travel direction is detected (e.g. following another vehicle ahead of you at a distance set by DISTRONIC). This means that:

- your vehicle can pass another vehicle after you change lanes
- while in a sharp turn or if the vehicle in front is in a sharp turn, DISTRONIC could lose sight of a vehicle traveling in front of it, then your vehicle could accelerate to the previously selected speed.

DISTRONIC regulates only the distance between your vehicle and those directly ahead of it, but does not register stationary objects in the road, e.g.:

- a stopped vehicle in a traffic jam
- a disabled vehicle
- an oncoming vehicle

The driver must always be on the alert, observe all traffic and intercede as required by steering or braking the vehicle.

Warning!



DISTRONIC should not be used in snowy or icy road conditions.

Controls in detail

Driving systems

The most likely cause for a malfunctioning system is a dirty sensor (located behind the hood grille), especially at times of snow and ice or heavy rain. In such a case, Distronic will switch off, and the message *Distronic - Clean sensor! see oper. Manual* appears in the multifunction display.

For cleaning and care of the Distronic sensor, see "Cleaning the Distronic system sensor" (▷ page 283).



If the message "Distronic - clean sensor!" See oper. manual disappears during driving and the last speed stored flashes for approximately five seconds, the dirt (e.g. slush) has dissolved; Distronic works again.

Turns and bends

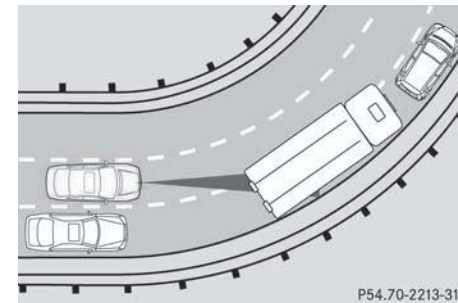

In turns or bends, Distronic may not detect a moving vehicle in front, or it may detect one too soon. This may cause your vehicle to brake late or unexpectedly.

Controls in detail

Driving systems

Offset driving

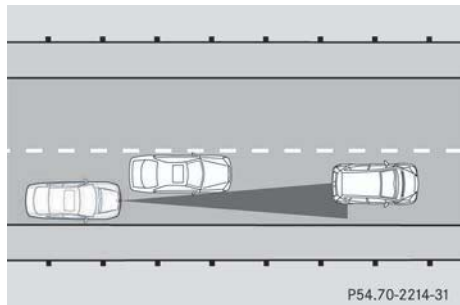

A vehicle traveling in your lane but offset from your direct line of travel may not be detected by Distronic. There will be insufficient distance to the vehicle ahead.

Lane changing

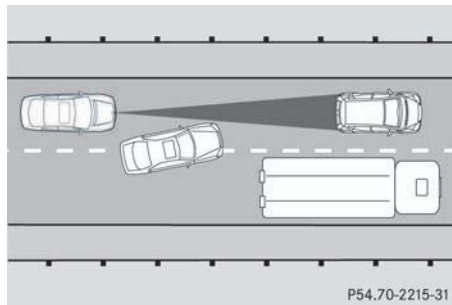

Distronic has not yet detected the vehicle changing lanes. There will be insufficient distance to the lane-changing vehicle.

Narrow vehicles

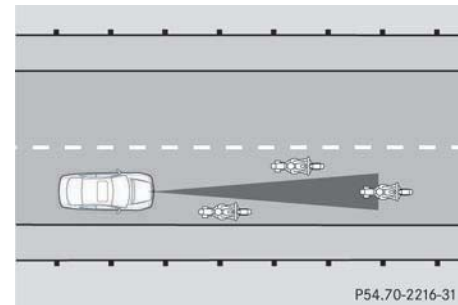

Because of its narrow profile, the vehicle traveling near the edge of the roadway has not yet been detected by Distronic. There will be insufficient distance to the vehicle ahead.

AIRMATIC DC (Dual Control)*

Vehicle level control

Your vehicle automatically adjusts its ride height to

- reduce fuel consumption
- increase vehicle safety

The following vehicle chassis ride heights are possible:

- Normal
- Raised
- Lowered

The vehicle chassis ride height is raised or lowered according to the selected level setting and to the vehicle speed:

- With increasing speed, ride height is reduced automatically by up to approximately 0.6 inch (15 mm) "Lowered" level.

- With decreasing speed, the ride height is again raised to the "Normal" level.



These height adjustments are so small that you may not notice any change.

Select the "Raised" level only when required by current driving conditions. Otherwise

- fuel consumption may increase
- handling may be impaired

Controls in detail

Driving systems

Warning!



To help avoid personal injury, keep hands and feet away from wheel housing area, and stay away from under the vehicle when lowering the vehicle chassis.

Controls in detail

Driving systems

The following vehicle level settings can be selected when the vehicle is stationary and the engine is running:

Vehicle level when stationary	Use for	Ride height increase over normal	Automatic lowering	Indicator lamp (▷ page 210)
Normal	Normal operation	None	Max. approx. 0.6 in (15 mm)	Lamp off
Raised	Driving with snow chains or very rough road surface conditions	Approx. 1 in (25 mm)	Max. approx. 1 in (25 mm)	Lamp on

The switch is located in the lower section of the center console.

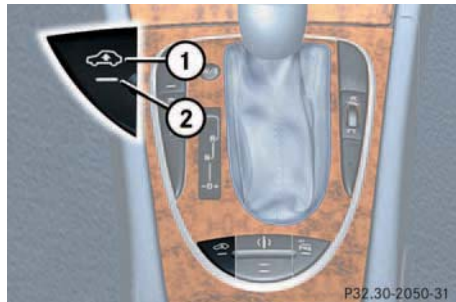

- 1 Vehicle level control switch
- 2 Indicator lamp

- ▶ Briefly press switch **1** to change from "Normal" level to "Raised" level. When vehicle is at "Raised" level, pressing the switch will return the vehicle to "Normal" level.



At a speed of approx. above 75 mph (120 km/h) or if the speed amounts to between 50 mph (80 km/h) and 75 mph (120 km/h) for approx. five minutes the setting "Raised" is canceled. The message *Level selec. canceled* appears in the multifunction display.

If you do not drive in this speed range, the "Raised" level remains stored even if the key is removed from the ignition.

Comfort-/Sport setting

The AIRMATIC DC (Dual Control) consists of two components:

- Adaptive-Damping-System (ADS)
- Suspension style

The ADS automatically selects the optimum damping for the respective driving conditions. At the same time the suspension style is set to either sporty or regular.

The suspension tuning is set according to:

- your driving style
- road surface conditions
- your choice of suspension style, "sporty I", "sporty II" or "regular", which you select using the damping switch.

The selected suspension style is stored in memory, even after the key is removed from the starter switch.



In the sporty suspension style the vehicle is lowered 0.6 in (15 mm).

Controls in detail

Driving systems

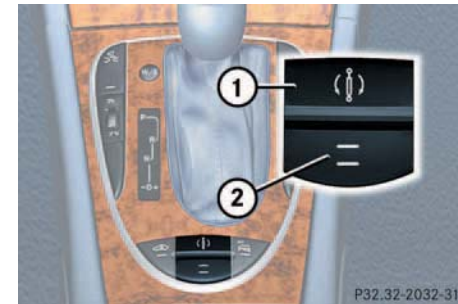

1 Damping button

2 Indicator lamps

- ▶ Start the engine.

Controls in detail

Driving systems

Suspension for sporty driving style I

The setting for sporty driving I is selected when one indicator lamp **2** is illuminated.

- ▶ Press button **1**.
One indicator lamp **2** comes on.

Suspension for sporty driving style II

The setting for sporty driving II is selected when two indicator lamps **2** are illuminated.

- ▶ Press button **1** twice.
Two indicator lamps **2** come on.

Suspension for regular driving style

The setting for regular driving is selected when the two indicator lamps **2** are off.

- ▶ Press button **1** repeatedly until all indicator lamps go out.
The indicator lamps **2** go out.

PARKTRONIC system*

Warning!



Parktronic is a supplemental system. It is not intended to, nor does it replace, the need for extreme care. The responsibility during parking and other critical maneuvers always rests with the driver.

Special attention must be paid to objects having smooth surfaces or low silhouettes (e.g. trailer couplings, painted posts, or street curbs). Such objects may not be detected by the system and can damage the vehicle.

The operational function of the Parktronic can be affected by dirty sensors, especially at times of snow and ice. See "Cleaning the Parktronic system sensors" (▷ page 284).

Interference caused by other ultrasonic signals (e.g. working jackhammers or the air brakes of trucks) can cause the system to send erratic indications, and should be taken into consideration.

Warning!



Be sure that no persons or animals are in the area in which you are maneuvering. You could otherwise injure them.

The Parktronic system is an electronic aid designed to assist the driver during parking maneuvers. It visually and audibly indicates the relative distance between the vehicle and an obstacle.

The Parktronic system is automatically activated when you switch on the ignition and release the parking brake. The Parktronic system deactivates at speeds over 11 mph (18 km/h). At lower speeds the Parktronic system turns on again.

Controls in detail

Driving systems

The Parktronic system monitors the surroundings of your vehicle with six sensors in the front bumper and four sensors in the rear bumper.

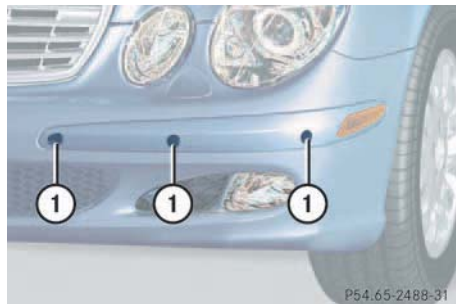

1 Sensors in the front bumper

Range of the sensors

To function properly, the sensors must be free of dirt, ice, snow and slush. Clean the sensors regularly, being careful not to scratch or damage the sensors.

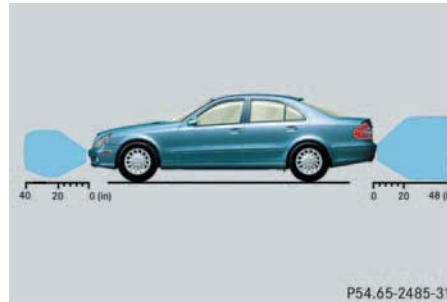

Front sensors

Center	approx. 40 in (100 cm)
Corners	approx. 23 in (60 cm)

Rear sensors

Center	approx. 48 in (120 cm)
Corners	approx. 32 in (80 cm)



During parking maneuvers, pay special attention to objects located above or below the height of the sensors (e.g. planters or trailer hitches). The Parktronic system will not detect such objects at close range and damage to your vehicle or the object may result.

Ultrasonic signals from outside sources (e.g. truck air brakes or jackhammers) may impair the operation of the Parktronic system.

Minimum distance

Center	approx. 8 in (20 cm)
Corners	approx. 6 in (15 cm)

If the system encounters an obstacle in this range, all the warning lamps light up and you hear a warning signal. If the obstacle is closer than the minimum distance, the actual distance may no longer be indicated by the system.

Controls in detail

Driving systems

Warning indicators

Visual signals indicate to the driver the relative distance between the sensors and an obstacle. The warning indicator for the front area is located above the center air outlets in the dashboard. The warning indicator for the rear area is integrated in the rear trim.

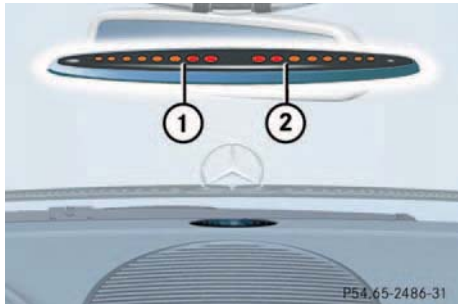

Front area warning indicator

- 1 Left side of the vehicle
- 2 Right side of the vehicle

Each warning indicator is divided into six yellow and two red segments for either side of the vehicle. The Parktronic system is ready when the border around the indicator is illuminated.

The position of the gear selector lever determines which warning indicators will be activated.

Selector lever position	Warning indicator
D	Front area activated
R or N	Rear area activated
P	Neither activated

As your vehicle approaches an object, one or more segments will light up, depending on the distance. When the eighth segment lights up, you have reached the minimum distance.

- Front area: An intermittent acoustic warning will sound as the seventh segment lights up and a constant acoustic warning lasting a maximum of three seconds will sound for the eighth segment.
- Rear area: An intermittent acoustic warning will sound when the first segment lights up. This signal quickens with each additional segment lit. When the eighth segment illuminates, the acoustic warning becomes a constant signal. The signal is canceled when the selector lever is placed in position **D** or **P**.

Switching the Parktronic system on/off

You can switch off the Parktronic system manually.

The Parktronic switch is located in the lower section of the center console.

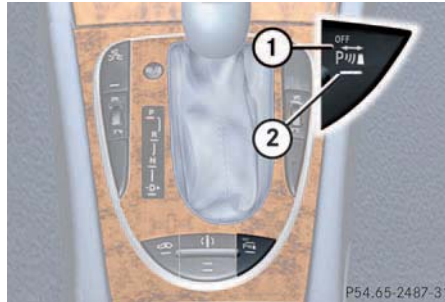

- 1 Parktronic on/off
- 2 Indicator lamp

Controls in detail

Driving systems

Switching off the Parktronic system

- ▶ Press button **1**.
- Indicator lamp **2** comes on.

Switching on the Parktronic system

- ▶ Press button **1** again.
- Indicator lamp **2** goes out.

Controls in detail

Loading

Loading

Roof rack*

Warning!



Use only those roof racks approved by Mercedes-Benz for your vehicle model to avoid damage to the vehicle. Follow manufacturer's installation instructions.

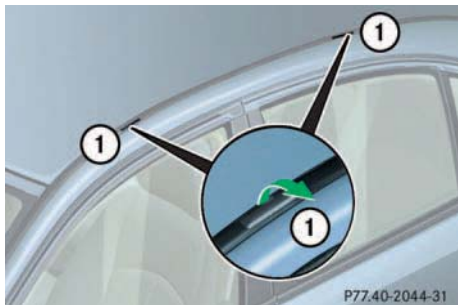

1 Trim

Preparing roof rack installation

- ▶ Open trim 1 at the trim strips in the roof.
- ▶ Secure the roof rack according to manufacturer's instructions for installation.



Be sure to stack a load on the roof rack so that the vehicle cannot be damaged while driving.

Make sure that:

- you can fully raise the sliding/pop-up roof*
- you can fully open the trunk

Ski sack*

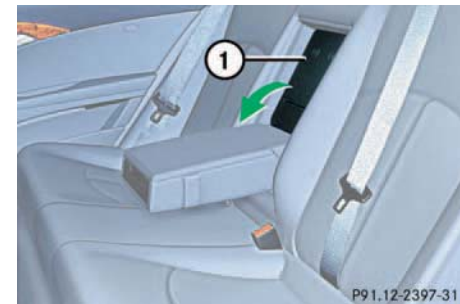

Unfolding and loading

- ▶ Fold armrest down (arrow).
- ▶ Swing cover 1 down.

Controls in detail

Loading



- ▶ Open hook and loop strap **1**.
- ▶ Pull ski sack into passenger compartment and unfold.



- ▶ From trunk, slide skis into ski sack.

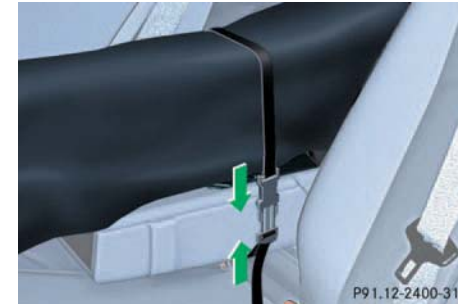

- ▶ Wrap strap around ski sack and arm-rest.
- ▶ Close clasp (arrows) and pull strap tight to immobilize skis.

Warning!



The ski sack is designed for up to four pairs of skis. Do not load the ski sack with other objects.

Always fasten the ski sack securely. In an accident, an unfastened ski sack can cause injury to vehicle occupants.

Controls in detail

Loading

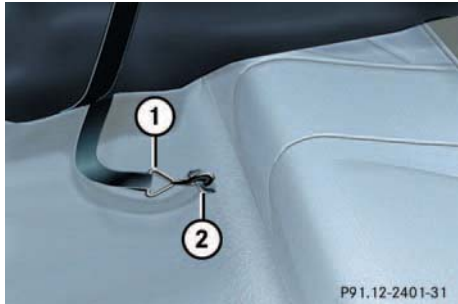

- ▶ Connect snap hook **1** of front strap to eye **2** located on center tunnel in front of rear seat bench.

Unloading and folding



- ▶ Loosen strap, open clasp by pressing tabs together (arrows).
- ▶ Unload skis.
- ▶ Close flap in trunk.
- ▶ Fold and flatten ski sack lengthwise and place folded ski sack inside recess of backrest.



- ▶ Close ski sack compartment cover.

Removal of ski sack

For removal of the ski sack we recommend that you contact an authorized Mercedes-Benz Center.

Warning!



Never drive vehicle with trunk open while the ski sack is removed. Deadly carbon monoxide (CO) gases may enter vehicle interior, resulting in unconsciousness and death.



To prevent unauthorized persons from access to the trunk, always close the cover.

Split rear bench seat*

To expand the trunk, you can fold down the left and right rear seat backrests.

The two sections can be folded down separately to enlarge the trunk.

When transporting long items, the folding front passenger seat* can be folded forward, and you can remove the rear seat cushions.

Warning!



When expanding the luggage compartment, always fold the seat cushions fully forward.

Unless you are transporting cargo, the backrests must remain properly locked in the upright position.

In an accident, during hard braking or sudden maneuvers, loose items will be thrown around inside the vehicle, and cause injury to vehicle occupants unless the items are securely fastened in the vehicle.

Always use the cargo tie down rings (▷ page 225).

Controls in detail

Loading

Folding the backrest forward

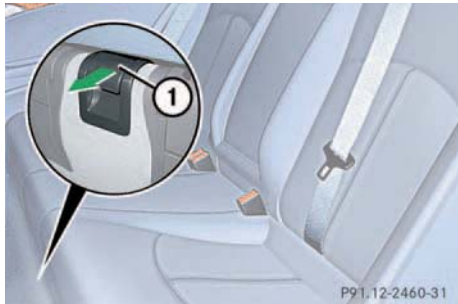

1 Release handle

- ▶ Pull release handle **1**.
The seat cushion automatically springs upward slightly.

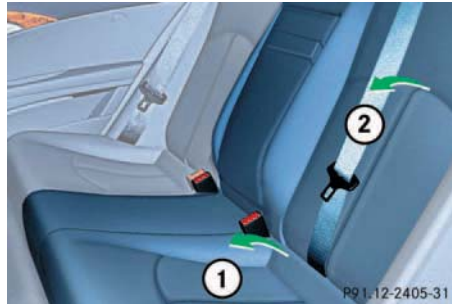

1 Seat cushion
2 Seat backrest

- ▶ Grip the back of seat cushion **1** and fold forward.
- ▶ Push the rear seat head restraints all the way in.

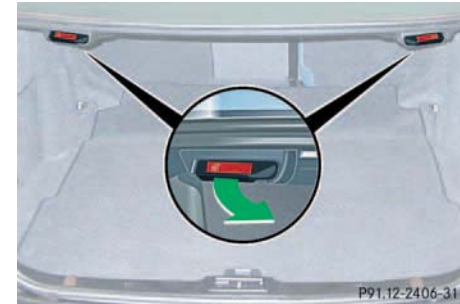

- ▶ Pull the handle in the trunk.
The seat backrest is released and the head restraints fold back.
- ▶ Fold the seat backrest forward.

Controls in detail

Loading

Returning seat backrest to original position

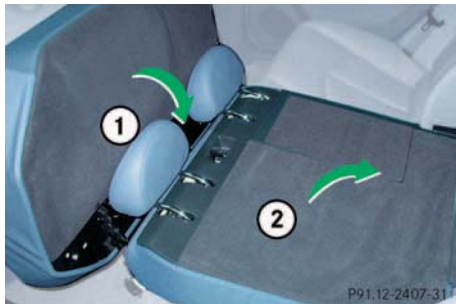

- 1 Seat cushion
- 2 Seat backrest

- ▶ Swing seat backrest **2** to the rear until it engages.
- ▶ Swing seat cushion **1** to the rear and press the center front of the cushion until it audibly engages.



- ▶ Swing the head restraint forward by hand until it engages.

Warning!



Always lock backrest in its upright position when rear seat bench is occupied, or the extended trunk compartment is not in use. Check for secure locking by pushing and pulling on the backrest.

In an accident, during hard braking or sudden maneuvers, loose items will be thrown around inside the vehicle, and cause injury to vehicle occupants unless the items are securely fastened in the vehicle.

To help avoid personal injury during a collision or sudden maneuver, exercise care when transporting cargo.

Controls in detail

Loading

Folding front passenger seat*

Folding front passenger seat forward



1 Release handle

- ▶ Press the right-hand side of release handle 1.
The handle folds out.
- ▶ Pull the left-hand side of the release handle.

The front passenger seat backrest is released and can be folded forward.

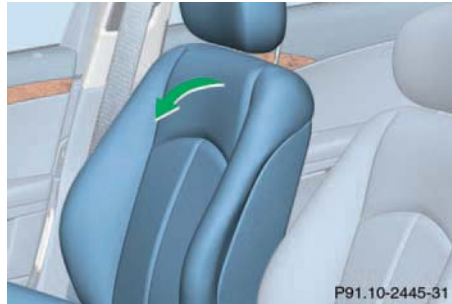

- ▶ Fold the backrest all the way forward.
- ▶ Press the backrest lightly downward until it is resting on the seat cushion.

Warning!



Make sure that the backrest engages and locks when folding it back into place.

Folding front passenger seat back



1 Release handle

- ▶ Using release handle 1, pull the backrest to its original position. Pull the handle until the backrest has reached an angle of approximately 45°.

Controls in detail

Loading

Expanding the cargo area*

Removing the rear seat cushions will provide you with a larger, flat cargo area.

- ▶ Fold the seat cushions and the backrests forward.
- ▶ Remove the head restraints. (Raise the seat backrest and fold the head restraints forward.)



1 Release catch

- ▶ Press head restraint release catch **1** and pull the head restraints out of the guides.

- ▶ Fold the backrest into the vertical position.

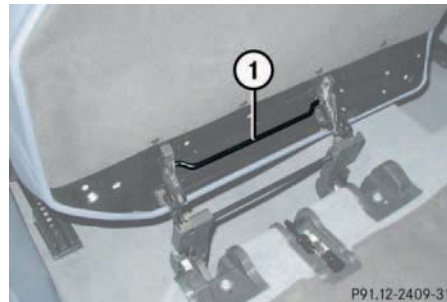

1 Release lever

- ▶ Pull seat cushion release lever **1** and remove the seat cushion by pulling it upward.



Leave the seat cushion hinge in this position. The upholstery could be damaged if you fold the hinge back.

Controls in detail

Loading

Loading instructions

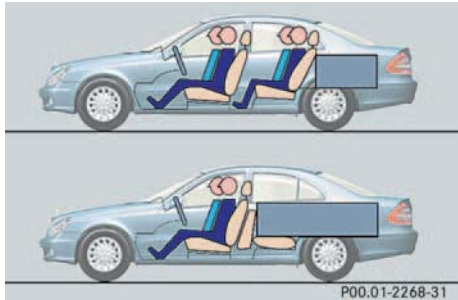

The total load weight including vehicle occupants and luggage/cargo should not exceed the vehicle capacity weight indicated on the certification tag which can be found on the left door pillar.

The handling characteristics of a fully loaded vehicle depend greatly on the load distribution. It is therefore recommended to load the vehicle according to the illustrations shown, with the heaviest items being placed towards the front of the vehicle.

Always place items being carried against front or rear seat backrests, and fasten them as securely as possible.

The heaviest portion of the cargo should always be kept as low as possible since it influences the handling characteristics of the vehicle.

Warning!



Always fasten items being carried as securely as possible.

In an accident, during hard braking or sudden maneuvers, loose items will be thrown around inside the vehicle and can cause injury to vehicle occupants unless the items are securely fastened in the vehicle.

To help avoid personal injury during a collision or sudden maneuver, exercise care when transporting cargo. Put luggage or cargo in the trunk if possible. Do not pile luggage or cargo higher than the seat backs. Do not place anything on the shelf below the rear windows.

Never drive vehicle with trunk open. Deadly carbon monoxide (CO) gases may enter vehicle interior resulting in unconsciousness and death.

Cargo tie-down rings*

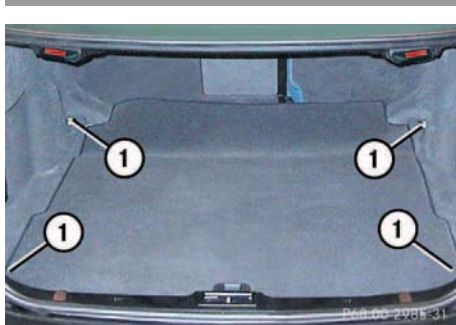

Four rings **1** are located in the cargo compartment.

- ▶ Carefully secure cargo by applying even load on all rings with rope of sufficient strength to hold down the cargo.

Always follow loading instructions (▷ page 224).

Rear seat

There is a cargo tie-down ring located on each side of the footwell under the rear seat.



Controls in detail

Useful features

Useful features

Interior storage spaces

Warning!



To help avoid personal injury during a collision or sudden maneuver, exercise care when stowing objects in the vehicle. Put luggage or cargo in the trunk if possible. Do not pile luggage or cargo higher than the seat backs. Do not place anything on the shelf below the rear window.

Luggage nets cannot secure hard or heavy objects.

Keep compartment lids closed. This will help to prevent stored objects from being thrown about and injuring vehicle occupants during an accident.

Parcel net in front passenger footwell

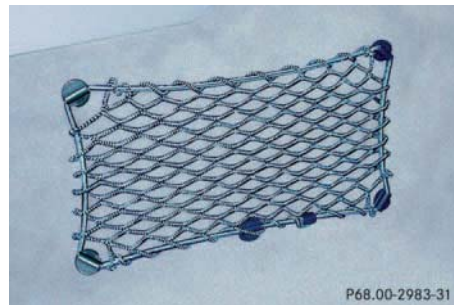

A small convenience parcel net is located in the front passenger footwell. It is for small and light items, such as road maps, mail, etc.

Warning!



The parcel net is intended for storing light-weight items only.

Heavy objects, objects with sharp edges or fragile objects may not be transported in the parcel net.

The parcel net cannot protect transported goods in the event of an accident.

Glove box

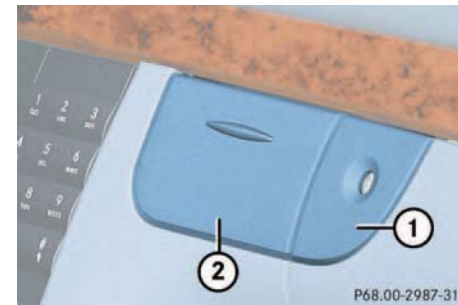

1 Glove box lid release

2 Compartment for mobile phone/glasses

Opening the glove box

- ▶ Push lid release **1**.

The glove box lid opens downward.

Closing the glove box

- ▶ Push lid up to close.



Prior to closing the glove box, close the compartment for glasses first.

Storage compartment in the center console



1 Opening/closing button



The storage compartment in the center console cannot be opened if the cassette tray is open.

► Press button 1 to open.

The control panel swings out upward and the storage compartment extends out.



Never place any medications in the storage compartment. If there is a power failure, the storage compartment cannot be opened.

► Press button 1 to close.

Storage compartment in front of the armrest



Controls in detail

Useful features

Opening

► Briefly press the marking in the back of the cover.

The cover opens.

Cup holder in the center console



► Briefly press marking on the cup holder.

The cup holder extends automatically.

Controls in detail

Useful features



The cup holder can be removed for cleaning. Clean the cup holder only with clear, lukewarm water.

Make sure to insert the cup holder in the guides when reinstalling it.

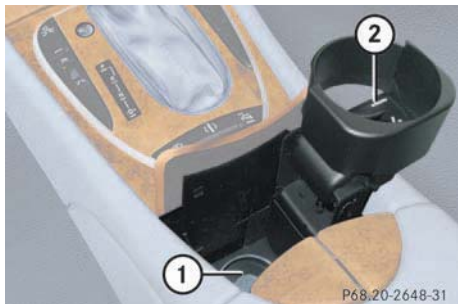

- 1 Left cup holder
- 2 Right cup holder

Warning!



When not in use, keep the cup holder closed while traveling. Place only containers that fit into the cup holder to prevent spills. Use lids on open containers and do not fill containers to a height where the contents, especially hot liquids, could spill during vehicle maneuvers.

Storage space under armrest

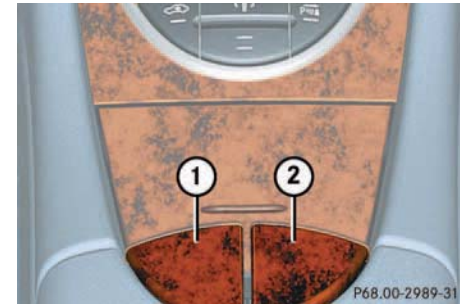

- 1 Storage compartment
- 2 Storage tray

Opening storage tray

- ▶ Pull handle 2.

Opening storage compartment

- ▶ Pull handle 1.

Controls in detail

Useful features

Front center console storage compartment ventilation

The front center console storage compartment under the armrest has its own air outlet. The air temperature is about the same as that of the dashboard air outlets.

The lever is located in the front center outlet.



1 Lever

- ▶ To open air outlet slide the lever up.
- ▶ To close air outlet slide the lever down.



The compartment can get very warm due to its confined space. When storing heat sensitive objects (e.g. groceries) in the compartment, close the air outlet while heating the passenger compartment

Storage compartment in the rear center console



- ▶ Briefly press the top of the compartment. It extends automatically.

Controls in detail

Useful features

Ruffled storage bags



Ruffled storage bags are located on the back of the front seats.

Warning!



Do not transport hard objects in the storage bags.

Storage compartment in the rear armrest

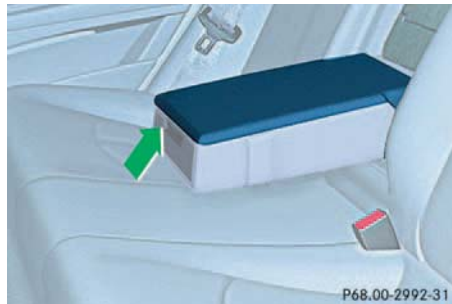

- ▶ Press the handle upward and fold the armrest up.

Rear cup holder

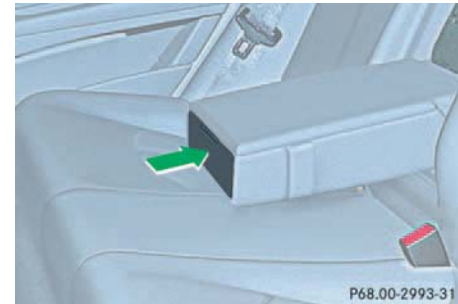

- ▶ Briefly press the front of the center armrest.
The cup holder extends automatically.

Warning!



When not in use, keep the cup holder closed while traveling. Place only containers that fit into the cup holder to prevent spills. Use lids on open containers and do not fill containers to a height where the contents, especially hot liquids, could spill during vehicle maneuvers.

Ashtrays

Center console ashtray

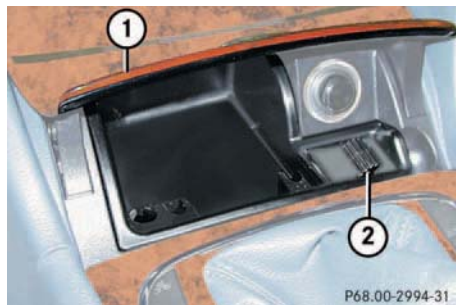

Opening ashtray

- ▶ Briefly press the marking on the bottom of cover **1**.
The ashtray opens automatically.

Removing ashtray insert

Warning!



Remove front ashtray only with vehicle standing still. Set the parking brake to secure vehicle from movement. Move gear selector lever to position **N**. With gear selector lever in position **N** turn off the engine.

- ▶ Secure vehicle from movement by setting the parking brake. Move the selector lever to position **N**.
Now you have more room to take out the insert.
- ▶ Push sliding button **2** to the right and hold.
- ▶ Grip and remove insert from ashtray frame.

Reinstalling ashtray insert

- ▶ Install insert by pushing it back into frame until it engages again.

Rear seat ashtray



Opening ashtray

- ▶ Briefly press the top of the ashtray.
The ashtray opens.

Controls in detail

Useful features

Cigarette lighter

The cigarette lighter is located in the center console compartment in front of the armrest (▷ page 26).

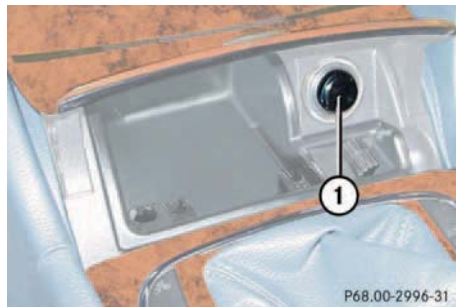

1 Cigarette lighter

- ▶ Turn key in the starter switch to position **1** or **2**.
- ▶ Push in cigarette lighter **1**.
The lighter will pop out automatically when hot.

Warning!



Never touch the heating element or sides of the lighter; they are extremely hot. Hold the knob only.

When leaving the vehicle always remove the key from the starter switch, and lock your vehicle. Do not leave children unattended in the vehicle, or with access to an unlocked vehicle. Unsupervised use of vehicle equipment may cause serious personal injury.



The lighter socket can be used to accommodate electrical accessories up to a maximum 85 W.

12-V socket**



The socket is located in the rear of the center console storage compartment.

The socket can be used for accessories up to a maximum of 180 W.

Heated steering wheel*

The control lever for the steering wheel heating is on the lower left-hand side of the steering wheel.

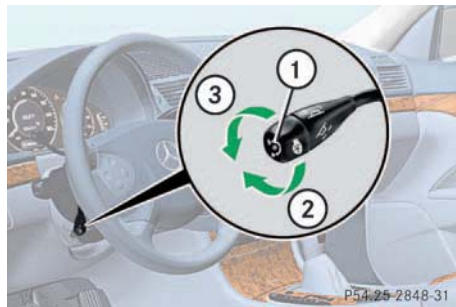

- 1 Indicator lamp
- 2 Heated steering wheel off
- 3 Heated steering wheel on

Switching on

- ▶ Check that the ignition is switched on. All lamps in the instrument cluster light up.
- ▶ Turn the control lever in direction of arrow **3**.
The steering wheel gets warm. The indicator lamp **1** lights up.

Switching off

- ▶ Turn the control lever in direction of arrow **2**.
The heated steering wheel is switched off. The indicator lamp **1** switched off.



The heated steering wheel do not switch off automatically.

Telephone*

Warning!



Never operate radio transmitters equipped with a built-in or attached antenna (i.e. without being connected to an external antenna) from inside the vehicle while the engine is running. Doing so could lead to a malfunction of the vehicle's electronic system, possibly resulting in an accident and personal injury.

Radio transmitters, such as a portable telephone or a citizens band unit, should only be used inside the vehicle if they are connected to an antenna that is installed on the outside of the vehicle.

The external antenna must be approved by Mercedes-Benz. Please contact an authorized Mercedes-Benz Center for information on the installation of an approved external antenna. Refer to the radio transmitter operation instructions regarding use of an external antenna.

Controls in detail

Useful features

Warning!





Please do not forget that your primary responsibility is to drive the vehicle. A driver's attention to the road must always be his/her primary focus when driving. For your safety and the safety of others, we recommend that you pull over to a safe location and stop before placing or taking a telephone call.

If you choose to use the telephone¹ while driving, please use the hands-free device and only use the telephone when road and traffic conditions permit. Some jurisdictions prohibit the driver from using a cellular telephone while driving a vehicle.

Only operate the COMAND* (Cockpit Management and Data System)¹ if road and traffic conditions permit.

¹ Observe all legal requirements.

Bear in mind that at a speed of just 30 mph (approximately 50 km/h), your vehicle is covering a distance of approx. 44 feet (approximately 13.5 m) every second.

You can take and place telephone calls using the  and  buttons on the steering wheel. To carry out other telephone functions, use the control system (▷ page 121).

See separate operating manual for instructions on how to use the telephone.

Warning!



Some jurisdictions prohibit the driver from using a cellular telephone while driving a vehicle. Whether or not prohibited by law, for safety reasons, the driver should not use the cellular telephone while the vehicle is in motion.

Stop the vehicle in a safe location before answering or placing a call.

Tele Aid*



The initial activation of the Tele Aid system may only be performed by completing the subscriber agreement and placing an acquaintance call using the SOS button. Failure to complete either of these steps will result in a system that is not activated. If the system is not activated, the indicator lamp in the SOS button stays on after turning the key in the starter switch to position **2** and the message *Tele Aid - not activated* will be shown in the multifunction display for approx. 10 seconds.

If you have any questions regarding activation, please call the Response Center at 1-800-756-9018 (in the USA) or 1-888-923-8367 (in Canada).



The Tele Aid system



(Telematic Alarm Identification on Demand)

The Tele Aid system consists of three types of response:

- Automatic and manual emergency
- Roadside Assistance and
- Information



The Tele Aid system is operational providing that the vehicle's battery is charged, properly connected, not damaged and cellular and GPS coverage is available.

The speaker volume of a Tele Aid call can be adjusted when using the volume control on the multifunction steering wheel. To raise, press button  and to lower, press button .

- ▶ To activate, press the SOS button, the Roadside Assistance button  or the Information button , depending on the type of response required.





The SOS button is located above the inside rear view mirror.

The Roadside Assistance button  and the Information button  are located below the center armrest cover.

Shortly after the completion of your acquaintance call, you will receive a user ID and password via first call mail. By visiting www.mbusa.com and selecting "Tele Aid" (USA only), you will have access to account information, remote door unlock, Info Services¹ profile and more.

System self-check

Initially, after turning the key in starter switch to position **2**, malfunctions are detected and indicated (the indicator lamps in the SOS button, the Roadside Assistance button  and the Information button  stay on longer than 10 seconds or do not come on). The message TELE AID - VISIT WORKSHOP! appears for approx. 10 seconds in the multifunction display.

¹ Available only with COMAND*

Controls in detail

Useful features



If the indicator lamps in the SOS button, in the "Roadside Assistance" button and in the "Information" button remain illuminated constantly in red and/or the message TELE AID - VISIT WORKSHOP! is displayed in the multifunction display after the system self-check, a malfunction in the system has been detected.

If a malfunction is indicated as outlined above, the system may not operate as expected. Have the system checked at the nearest Mercedes-Benz Center as soon as possible.

Emergency calls

An emergency call is initiated automatically:

- following an accident in which the emergency tensioning devices (ETDs) or airbags deploy
- if the anti-theft alarm or the tow-away alarm stays on for more than 20 seconds. See anti-theft alarm system (▷ page 82) and tow-away alarm (▷ page 82)

An emergency call can also be initiated manually by opening the cover next to the inside rear view mirror labeled SOS, then briefly pressing the button located under the cover. See below for instructions on initiating an emergency call manually.

Once the emergency call is in progress, the indicator lamp in the SOS button will begin to flash. The message EMERGENCY CALL - CONNECTING CALL appears in the multifunction display. When the connection is established, the message EMERGENCY CALL - CALL CONNECTED appears in the multifunc-

tion display. All information relevant to the emergency, such as the location of the vehicle (determined by the GPS satellite location system), vehicle model, identification number and color are generated.

A voice connection between the Response Center and the occupants of the vehicle will be established automatically soon after the emergency call has been initiated. When a voice connection is established, the audio system is muted and the message TELE AID - EMERGENCY CALL ACTIVE appears in the multifunction display. The Response Center will attempt to determine more precisely the nature of the accident provided they can speak to an occupant of the vehicle.

The Tele Aid system is available if:

- it has been activated and is operational. Activation requires a subscription for monitoring services, connection and cellular air time
- the relevant cellular phone network and GPS signals are available and pass the information on to the response center



Location of the vehicle on a map is only possible if the vehicle is able to receive signals from the GPS satellite network and pass the information on to the response center.

Warning!



If the indicator lamp in the SOS button is illuminated continuously and there was no voice connection to the Response Center established, then the Tele Aid system could not initiate an emergency call (e.g. the relevant cellular phone network is not available). The message EMERGENCY CALL - CALL FAILED appears in the multifunction display for approx. 10 seconds.

Should this occur, assistance must be summoned by other means.

Controls in detail

Useful features

Initiating an emergency call manually

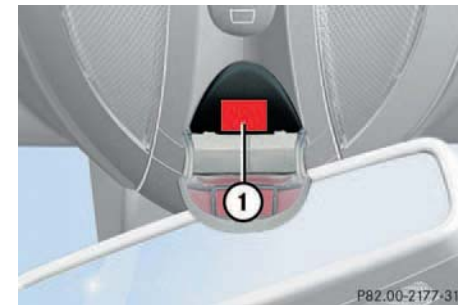

1 SOS button

- ▶ Press SOS button **1** briefly.
The indicator lamp in SOS button **1** will flash until the emergency call is concluded.
- ▶ Wait for a voice connection to the Response Center.
- ▶ Close cover after the emergency call is concluded.

Controls in detail

Useful features

Warning!



If you feel at any way in jeopardy when in the vehicle (e.g. smoke or fire in the vehicle, vehicle in a dangerous road location), please do not wait for voice contact after you have pressed the emergency button. Carefully leave the vehicle and move to a safe location. The Response Center will automatically contact local emergency officials with the vehicle's approximate location if they receive an automatic SOS signal and cannot make voice contact with the vehicle occupants.

Roadside Assistance button

Located below the center armrest cover is the Roadside Assistance button .

- ▶ Press and hold the button for more than 2 seconds.

A call to a Mercedes-Benz Roadside Assistance dispatcher will be initiated. The button will flash while the call is in progress. The message **ROADSIDE ASSISTANCE - CONNECTING CALL** will appear in the multifunction display.

When the connection is established, the message **ROADSIDE ASSISTANCE - CALL CONNECTED** appears in the multifunction display. The Tele Aid system will transmit data generating the vehicle identification number, model, color and location (subject to availability of cellular and GPS signals).

A voice connection between the Roadside Assistance dispatcher and the occupants of the vehicle will be established. When a voice connection is established, the audio system is muted and the message

TELE AID - ROADSIDE ASSISTANCE CALL ACTIVE appears in the multifunction display.

- ▶ Describe the nature of the need for assistance.

The Mercedes-Benz Roadside Assistance dispatcher will either dispatch a qualified Mercedes-Benz technician or arrange to tow your vehicle to the nearest authorized Mercedes-Benz Center. For services such as labor and/or towing, charges may apply. Refer to the Roadside Assistance manual for more information.



These programs are only available in the USA:

- Sign and Drive services: Services such as a jump start, a few gallons of fuel or the replacement of a flat tire with the vehicle spare tire are obtainable.
- Remote Vehicle Diagnostics: This function permits the Mercedes-Benz Roadside Assistance dispatcher to download malfunction codes and actual vehicle data.

Controls in detail

Useful features



The indicator lamp in the Roadside Assistance button  remains illuminated in red for approx. 10 seconds during the system self-check after turning the key in the starter switch to position **2** (together with the SOS button and the Information button ).

See system self-check (▷ page 235) when the indicator lamp does not light up in red or stays on longer than approximately 10 seconds.

If the indicator lamp in the Roadside Assistance button  is illuminated continuously and there was no voice connection to the Response Center established, then the Tele Aid system could not initiate a Roadside Assistance call (e.g. the relevant cellular phone network is not available). The message `ROADSIDE ASSISTANCE - CALL FAILED` appears in the multifunction display.

Roadside Assistance calls can be terminated using the  button on the multifunction steering wheel.

Information button

Located below the center armrest cover is the Information button .

- ▶ Press and hold the button for more than 2 seconds.

A call to the Customer Assistance Center will be initiated. The button will flash while the call is in progress. The message `INFO - CONNECTING CALL` will appear in the multifunction display.



When the connection is established, the message `INFO - CALL CONNECTED` appears in the multifunction display. The Tele Aid system will transmit data generating the vehicle identification number, model, color and location (subject to availability of cellular and GPS signals).

A voice connection between the Customer Assistance Center representative and the occupants of the vehicle will be estab-

lished. When a voice connection is established, the audio system is muted and the message `TELE AID - INFO CALL ACTIVE` appears in the multifunction display. Information regarding the operation of your vehicle, the nearest authorized Mercedes-Benz Center or Mercedes-Benz USA products and services is available to you.

For more details concerning the Tele Aid system, please visit www.mbusa.com and use your ID and password (sent to you separately) to learn more (USA only).





The indicator lamp in the Information button  remains illuminated in red for approx. 10 seconds during the system self-check after turning key in the starter switch to position **2** (together with the SOS button and the Roadside Assistance button .

Controls in detail

Useful features

See system self-check (▷ page 235) when the indicator lamp does not light up in red or stays on longer than approximately 10 seconds.

If the indicator lamp in the Information button  is illuminated continuously and there was no voice connection to the Response Center established, then the Tele Aid system could not initiate an Information call (e.g. the relevant cellular phone network is not available). The message INFO - CALL FAILED appears in the multifunction display.

Information calls can be terminated using the  button on the multifunction steering wheel.



If the indicator lamps do not start flashing after pressing one of the buttons or remain illuminated (in red) at any time, the Tele Aid system has detected a fault or the service is not currently active, and may not initiate a call. Visit your authorized Mercedes-Benz Center and have the system checked or contact the Response Center at 1-800-756-9018 (in the USA) or 1-888-923-8367 (in Canada) as soon as possible.

Upgrade signals

The Tele Aid system processes calls using the following priority:

- Automatic emergency – First priority
- Manual emergency – Second priority
- Roadside assistance – Third priority
- Information – Fourth priority

Should a higher priority call be initiated while you are connected, an upgrade (alternating) tone will be heard, and the appropriate indicator lamp will flash. If certain information such as vehicle identification number or customer information is not available, the operator may need to retransmit.

During this time you will hear a beep and voice contact will be interrupted. Voice contact will resume once the retransmission is completed. Once a call is concluded, a beep will be heard and the appropriate indicator lamp will stop flashing. The COMAND* system operation will resume.

Controls in detail

Useful features



If the indicator lamp continues to flash or the system does not reset, contact the Response Center at 1-800-756-9018 (in the USA) or 1-888-923-8367 (in Canada), or Mercedes-Benz Customer Assistance at 1-800-FOR-MERCEdes (1-800-367-6372) in the USA or Customer Service at 1-800-387-0100 in Canada.



The indicator lamp in the respective button flashes until the call is concluded. Calls can only be terminated by a Response Center or Customer Assistance Center representative except Roadside Assistance and Information calls, which can also be terminated by pressing button  on the multifunction steering wheel.



When a Tele Aid call has been initiated, the audio system or the COMAND* system audio is muted and the selected mode (radio, tape or CD) pauses. The optional cellular phone (if installed) switches off. If you must use this phone, the vehicle must be parked. Disconnect the coiled cord and place the call. The COMAND* navigation system (if engaged) will continue to run. The display in the instrument cluster is available for use, and spoken commands are only available by pressing the RPT button on the COMAND* unit. A pop-up window will appear in the COMAND* display to indicate that a Tele Aid call is in progress.

Remote door unlock

In case you have locked your vehicle unintentionally (e.g. key inside vehicle), and the reserve key is not handy:

- ▶ Contact the Mercedes-Benz Response Center at 1-800-756-9018 (in the USA) or 1-888-923-8367 (in Canada).

You will be asked to provide your password which you provided when you completed the subscriber agreement.

- ▶ Then return to your vehicle and pull the trunk recessed handle for a minimum of 20 seconds until the SOS button is flashing.

The message EMERGENCY CALL - CALL CONNECTED appears in the multifunction display.

As an alternative, you may unlock the vehicle via Internet using the ID and password sent to you shortly after the completion of your acquaintance call.

Controls in detail

Useful features

The Response Center will then unlock your vehicle with the remote door unlocking feature.



The remote door unlock feature is available if the relevant cellular phone network is available.

The SOS button will flash and the message **EMERGENCY CALL - CALL CONNECTED** will appear in the multifunction display to indicate receipt of the door unlock command.

Once the vehicle is unlocked, a Response Center specialist will attempt to establish voice contact with the vehicle occupants.

If the trunk recessed handle was pulled for more than 20 seconds before door unlock authorization was received by the Response Center, you must wait 15 minutes before pulling the trunk recessed handle again.

Stolen vehicle tracking services

In the event your vehicle was stolen:

- ▶ Report the incident to the police.

The police will issue a numbered incident report.

- ▶ Pass this number on to the Mercedes-Benz Response Center along with your password issued to you when you subscribed to the service.

The Response Center will then attempt to covertly contact the vehicle's Tele Aid system. Once the vehicle is located, the Response Center will contact the local law enforcement and you. The vehicle's location will only be provided to law enforcement.

Info Services* (except Canada)

Info Services categories include news, sports, stocks, weather and calendar reminders. Choices can be selected via www.mbusa.com or by calling 1-800-For-MERcedes (1-800-367-6372).

To request Info Services:

- ▶ Press the SVC button on the COMAND* system.
- ▶ Select **SEND NEW REQUEST FOR INFO SERVICE**.

NEW INFO SERVICE REQUEST TRANSMITTED will appear in the COMAND* display and call status messages will appear in the multifunction display.

Once information is available, the message **NEW INFO RECEIVED! READ LATER WHEN STOPPED?** will appear.

- ▶ Select **YES**.
- ▶ With the vehicle stopped in a safe location, press **SVC**.

- Select View Info Service Of mm.dd.yyyy hh:mm.

Messages will be retained for 30 minutes once the ignition is switched off.

Warning!



A driver's attention to the road must always be his/her primary focus when driving.

For your safety and the safety of others, we recommend that you pull over to a safe location and stop the vehicle before requesting or receiving any info services.

Bear in mind that at a speed of just 30 mph (approximately 50 km/h), your vehicle is covering a distance of approximately 44 feet (approximately 13.5 m) every second.



The Tele Aid system utilizes the cellular network for communication and the GPS (Global Positioning System) satellites for vehicle location. If either of these signals are unavailable, the Tele Aid system may not function and if this occurs, assistance must be summoned by other means.

Warning!



If the indicator lamp in the SOS button does not illuminate during the system self-check or remains illuminated afterwards, or if the message TELE AID - VISIT WORKSHOP! appears in the multifunction display, the system may not operate properly. Have the system checked at the nearest authorized Mercedes-Benz Center as soon as possible.

Controls in detail

Useful features

Garage door opener

The built-in remote control is capable of operating up to three separately controlled objects.

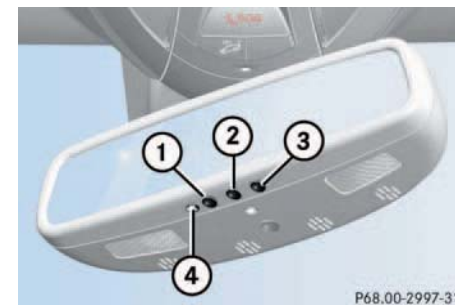

- 1 Signal transmitter button
- 2 Signal transmitter button
- 3 Signal transmitter button
- 4 Indicator lamp

Controls in detail

Useful features

Warning!



When programming a garage door opener, the door moves up or down.

When programming or operating the remote control make sure there is no possibility of anyone being harmed by the moving door.



Certain types of garage door openers are incompatible with the integrated opener. If you should experience difficulties with programming the transmitter, contact your authorized Mercedes-Benz Center, or call Mercedes-Benz Customer Assistance Center (in the USA only) at 1-800-FOR-MERCEDES, or Customer Service (in Canada) at 1-800-387-0100.



For operation in the USA only: This device complies with Part 15 of the FCC Rules. Operation is subject to the following two conditions:

- (1) This device may not cause harmful interference, and
- (2) this device must accept any interference received, including interference that may cause undesired operation.

Any unauthorized modification to this device could void the user's authority to operate the equipment.

Programming or reprogramming the integrated remote control

- ▶ Turn key in the starter switch to position **1** or **2**.
- ▶ Hold the end of the hand-held transmitter of the device you wish to train approximately 2 to 5 inches (5 cm to 12 cm) away from the surface of the integrated remote control located on the inside rear view mirror, keeping the indicator lamp in view.
- ▶ Using both hands, simultaneously push the hand-held transmitter button and the desired integrated remote control button. Do not release the buttons until completing the next step.
- ▶ The indicator lamp on the integrated remote control will flash, first slowly and then rapidly. The rapid flashing lamp indicates successful programming of the new frequency signal.
- ▶ When the indicator lamp flashes rapidly, release both buttons.

- ▶ To program the remaining two buttons, repeat the above steps.



If, after several attempts, you do not successfully program the integrated remote control device to learn the signal of the hand-held transmitter, the garage door opener could be equipped with the "rolling code feature".

Rolling code programming

To train a garage door opener (or other rolling code devices) with the rolling code feature, follow these instructions after completing the "Programming" portion of this text. (A second person may make the following training procedures quicker and easier.)

- ▶ Locate training button on the garage door opener motor head unit.

Exact location and color of the button may vary by garage door opener brand. If there is difficulty locating the transmitting button, refer to garage door opener operator's manual.

- ▶ Press "training" button on the garage door opener motor head unit.
The "training light" is activated.

You have 30 seconds time to initiate the following step.

- ▶ Firmly press and release the programmed integrated remote control transmit button.
- ▶ Press and release same button a second time to complete the training process.

Some garage door openers may require you to do this procedure a third time to complete the training.

- ▶ Confirm the garage door operation by pressing the programmed button on the integrated remote control transmitter.

Canadian programming

During programming, your hand-held transmitter may automatically stop transmitting.

- ▶ Continue to press and hold the integrated remote control transmitter button (refer to steps two through four in the "Programming" portion) while you press and re-press ("cycle") your hand-held transmitter every two seconds until the frequency signal has been learned.

Upon successful training, the indicator lamp will flash slowly and then rapidly after several seconds.

Controls in detail

Useful features

Operating the remote control

- ▶ Turn key in starter switch to position **1** or **2**.
- ▶ Select and press the appropriate button to activate the remote controlled device.

The integrated remote control transmitter continues to send the signal as long as the button is pressed – up to 20 seconds.

Erasing the remote control memory

- ▶ Turn key in starter switch to position **1** or **2**.
- ▶ Simultaneously hold down the left and right side buttons for approximately 20 seconds, or until the indicator lamp blinks rapidly.

The codes of all three channels are erased.



If you sell your vehicle, erase the codes of all three channels.

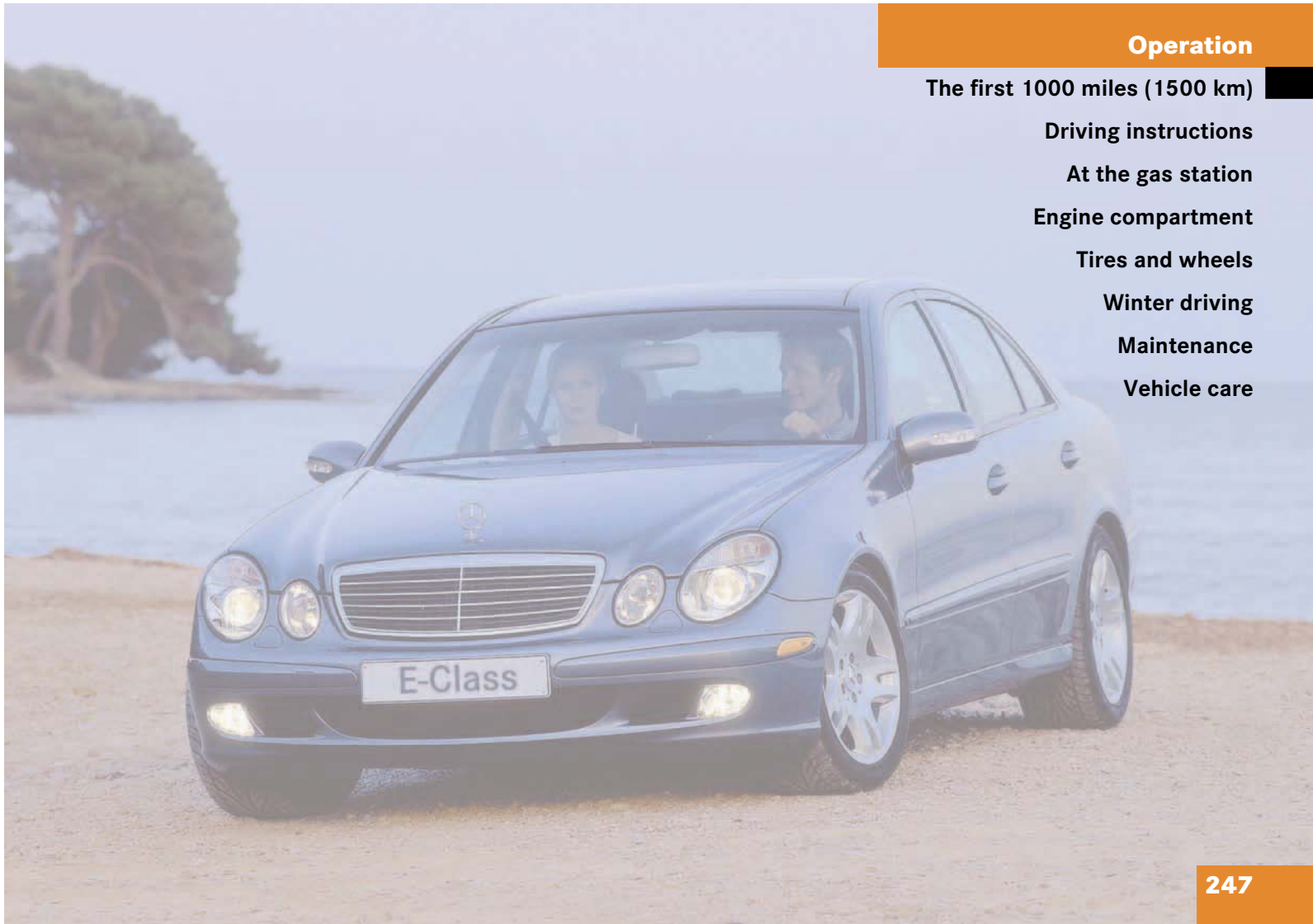

Operation

The first 1000 miles (1500 km)

Driving instructions

At the gas station

Engine compartment

Tires and wheels

Winter driving

Maintenance

Vehicle care

Operation

The first 1000 miles (1500 km)

In the "Operation" section you will find detailed information on operating, maintaining and caring for your vehicle.

The first 1000 miles (1500 km)

The more cautiously you treat your vehicle during the break-in period, the more satisfied you will be with its performance later on.

- Drive your vehicle during the first 1000 miles (1500 km) at varying but moderate vehicle and engine speeds.
- During this period, avoid heavy loads (full throttle driving) and excessive engine speeds (no more than $\frac{2}{3}$ of maximum rpm in each gear).

- Avoid accelerating by kick-down.
- Do not brake the vehicle by shifting to a lower gear using the selector lever.
- Select positions **3**, **2** or **1** only when driving at moderate speeds (for hill driving).

After 1000 miles (1500 km) you may gradually increase vehicle and engine speeds to the permissible maximum.

Driving instructions

Drive sensibly – save fuel

Fuel consumption, to a great extent, depends on driving habits and operating conditions.

To save fuel you should:

- Keep tires at the recommended inflation pressures.
- Remove unnecessary loads.
- Remove roof rack when not in use.
- Allow engine to warm up under low load use.
- Avoid frequent acceleration and deceleration.
- Have all maintenance work performed at regular intervals by an authorized Mercedes-Benz Center.

Fuel consumption is also increased by driving in cold weather, in stop-and-go traffic, on short trips and in hilly country.

Drinking and driving

Warning!



Drinking or taking drugs and driving can be a very dangerous combination. Even a small amount of alcohol or drugs can affect your reflexes, perceptions and judgement.

The possibility of a serious or even fatal accident is sharply increased when you drink or take drugs and drive.

Please don't drink or take drugs and drive or allow anyone to drive after drinking or taking drugs.

Pedals

Warning!



Keep driver's foot area clear at all times. Objects stored in this area may impair pedal movement.

Operation

Driving instructions

Power assistance

Warning!



The brake system requires electrical energy for operation.

A malfunction in the vehicle's power supply or electrical system may impair brake system operation and switch it into its limp-home (emergency operation) mode. In such a case, the red brake warning lamp (▷ page 291) and warning messages in the instrument cluster (▷ page 303) light up while driving. To brake, the driver must then apply significantly greater brake pedal pressure and depress the pedal much further to obtain the expected braking effect. If necessary, apply full pressure to the brake pedal. Brakes are only applied to the front wheels. Stopping distance is increased! If there is a malfunction in the SBC brake system, we recommend that the vehicle be transported

with all wheels off the ground using flatbed or appropriate wheel lift/dolly equipment. A tow bar must be used if circumstances do not permit the use of the recommended towing methods and the vehicle requires towing with all four wheels on the ground. Towing the vehicle with all four wheels on the ground is only permissible for distances up to 30 miles (50 km) and at a speed not to exceed 30 mph (50 km/h). For more information, refer to "Towing the vehicle" (▷ page 348). For more information see SBC brake system (▷ page 77).

With the engine not running, there is no power assistance for the steering system. In this case, it is important to keep in mind that a considerably higher degree of effort is necessary to steer the vehicle.

Brakes

Warning!



After driving in heavy rain for some time without applying the brakes or through water deep enough to wet brake components, the first braking action may be somewhat reduced and increased pedal pressure may be necessary to obtain expected braking effect. Be sure to maintain a safe distance from vehicles in front.

Resting your foot on the brake pedal will cause excessive and premature wear of the brake pads.

It can also result in the brakes overheating, thereby significantly reducing their effectiveness. It may not be possible to stop the vehicle in sufficient time to avoid an accident.

To help prevent brake disk corrosion after driving on wet road surfaces (particularly salted roads), it is advisable to brake the vehicle with considerable force prior to parking. The heat generated serves to dry the brakes.

If your brake system is normally only subjected to moderate loads, you should occasionally test the effectiveness of the brakes by applying above-normal braking pressure at higher speeds. This will also enhance the grip of the brake pads.



Be very careful not to endanger other road users when you apply the brakes.

Refer to the description of the Brake Assist System (BAS) (▷ page 74).

If the parking brake is released and the brake warning lamp in the instrument cluster stays on, there is a malfunction in the SBC brake system (▷ page 77) or the brake fluid level in the reservoir is too low.

Brake pad wear or a leak in the system may be the reason for low brake fluid in the reservoir.

Have the brake system inspected at an authorized Mercedes-Benz Center immediately.

All checks and service work on the brake system should be carried out by an authorized Mercedes-Benz Center.

Only install brake pads and brake fluid recommended by Mercedes-Benz.

Warning!



If other than recommended brake pads are installed, or other than recommended brake fluid is used, the braking properties of the vehicle can be degraded to an extent that safe braking is substantially impaired. This could result in an accident.

Be certain to read and observe the warning notices on brake pad replacement (▷ page 305).



When driving down long and steep grades, relieve the load on the brakes by shifting into a lower gear to use the engine's braking power. This helps prevent overheating of the brakes and reduces brake pad wear.

After hard braking, it is advisable to drive on for some time, rather than immediately parking, so that the air stream will cool down the brakes faster.

Operation

Driving instructions

Driving off

Apply the brakes to test them briefly after driving off. Perform this procedure only when the road is clear of other traffic.

Warm up the engine smoothly. Do not place full load on the engine until the operating temperature has been reached.

When starting off on a slippery surface, do not allow one drive wheel to spin for an extended period with the ESP switched off. Doing so may cause serious damage to the drive train which is not covered by the Mercedes-Benz Limited Warranty.

Parking



Set the parking brake whenever parking or leaving the vehicle. In addition, move selector lever to position **P**. In addition, when parking on hills, always set the parking brake and turn front wheel against curb.

Warning!



Do not park this vehicle in areas where combustible materials such as grass, hay or leaves can come into contact with the hot exhaust system, as these materials could be ignited and cause a vehicle fire.

To reduce the risk of personal injury as a result of vehicle movement, before turning off the engine and leaving the vehicle always:

- Keep right foot on brake pedal.
- Firmly depress parking brake pedal.
- Move the selector lever to position **P**.
- Slowly release brake pedal.
- When parked on an incline, turn front wheel towards the road curb.
- Turn the key to starter switch position **0** and remove, or press KEYLESS-GO* start/stop button (vehicles with KEYLESS-GO*).
- Take the key or the SmartKey with KEYLESS-GO* (if so equipped) with you and lock vehicle when leaving.

Tires

Warning!



If you feel a sudden significant vibration or ride disturbance, or you suspect that possible damage to your vehicle has occurred, you should turn on the hazard warning flashers, carefully slow down, and drive with caution to an area which is a safe distance from the road.

Inspect the tires and under the vehicle for possible damage. If the vehicle or tires appear unsafe, have it towed to the nearest Mercedes-Benz Center or tire dealer for repairs.

Tread wear indicators (TWI) are required by law. These indicators are located in six places on the tread circumference and become visible at a tread depth of approximately $\frac{1}{16}$ in (1.5 mm), at which point the tire is considered worn and should be replaced.

The tread wear indicator appears as a solid band across the tread.

Warning!



Do not allow your tires to wear down too far. As tread depth approaches $\frac{1}{16}$ in (1.5 mm), the adhesion properties on a wet road are sharply reduced.

Depending upon the weather and/or road surface (conditions), the tire traction varies widely.

Specified tire pressures must be maintained. This applies particularly if the tires are subjected to high loads (e.g. high speeds, heavy loads, high ambient temperatures).

Warning!



Do not drive with a flat tire. A flat tire affects the ability to steer or brake the vehicle. You may lose control of the vehicle. Continued driving with a flat tire or driving at high speed with a flat tire will cause excessive heat build-up and possibly a fire.

Aquaplaning

Depending on the depth of the water layer on the road, aquaplaning may occur, even at low speeds and with new tires. Reduce vehicle speed, avoid track grooves in the road and apply brakes cautiously in the rain.

Operation

Driving instructions

Tire traction

The safe speed on a wet, snow covered or icy road is always lower than on a dry road.

You should pay particular attention to the condition of the road whenever the outside temperatures are close to the freezing point.

Warning!



If ice has formed on the road, tire traction will be substantially reduced. Under such weather conditions, drive, steer and brake with extreme caution.

Mercedes-Benz recommends M+S rated radial-ply tires for the winter season for all four wheels to insure normal balanced handling characteristics. On packed snow, they can reduce your stopping distance compared to summer tires. Stopping distance, however, is still considerably greater than when the road is not covered with snow or ice. Exercise appropriate caution.

Operation

Driving instructions

Tire speed rating

Warning!



Even when permitted by law, never operate a vehicle at speeds greater than the maximum speed rating of the tires.

Exceeding the maximum speed for which tires are rated can lead to sudden tire failure, causing loss of vehicle control and resulting in personal injury and possible death.

Your vehicle is factory equipped with "H"-rated tires, which have a speed rating of 130 mph (210 km/h).

An electronic speed limiter prevents your vehicle from exceeding the speed rating.

Regardless of the tire rating, local speed limits should be obeyed. Use prudent driving speeds appropriate to prevailing conditions.

Winter driving instructions

The most important rule for slippery or icy roads is to drive sensibly and to avoid abrupt acceleration, braking and steering maneuvers. Do not use the cruise control system under such conditions.

When the vehicle is in danger of skidding, move selector lever to position **N** or in case you have a manual transmission, de-clutch. Try to keep the vehicle under control by corrective steering action.



For more information on driving with snow chains, see "Snow chains" (> page 274).

Warning!



On slippery road surfaces, never downshift in order to obtain braking action. This could result in drive wheel slip and reduced vehicle control. Your vehicle's ABS will not prevent this type of loss of control.

Road salts and chemicals can adversely affect braking efficiency. Increased pedal force may become necessary to produce the normal braking effect.

We therefore recommend depressing the brake pedal periodically when traveling at length on salt-strewn roads.

This can bring road salt impaired braking efficiency back to normal. A prerequisite is, however, that this be done without endangering other drivers on the road.

If the vehicle is parked after being driven on salt-treated roads, the braking efficiency should be tested as soon as possible after driving is resumed while observing the safety rules in the previous paragraph.

Warning!



If the vehicle becomes stuck in snow, make sure that snow is kept clear of the exhaust pipe and from around the vehicle with the engine running. Otherwise, deadly carbon monoxide (CO) gases may enter vehicle interior resulting in unconsciousness and death.

To assure sufficient fresh air ventilation, open a window slightly on the side of the vehicle not facing the wind

Warning!



The outside temperature indicator is not designed to serve as an ice-warning device and is therefore unsuitable for that purpose. Indicated temperatures just above the freezing point do not guarantee that the road surface is free of ice.

For more information on winter driving, see "Winter driving" (▷ page 273)

Standing water



Do not drive through flooded areas or water of unknown depth.

If you must drive through standing water, drive slowly to prevent water from entering the passenger compartment or the engine compartment. Water in these areas could cause damage to electrical components or wiring of the engine or transmission, or could result in water being ingested by the engine through the air intake causing severe internal engine damage. Any such damage is not covered by the Mercedes-Benz Limited Warranty.

Passenger compartment

Warning!



Always fasten items being carried as securely as possible.

In an accident, during hard braking or sudden maneuvers, loose items will be thrown around inside the vehicle, and cause injury to vehicle occupants unless the items are securely fastened in the vehicle.

The trunk is the preferred place to carry objects.

Traveling abroad

Abroad, there is a widely-spread Mercedes-Benz service network at your disposal. If you plan to travel into areas which are not listed in the index of your Mercedes-Benz Center directory, you should request pertinent information from your authorized Mercedes-Benz Center.

Operation

Driving instructions

Control and operation of radio transmitter

COMAND*, radio and telephone*

Warning!



Please do not forget that your primary responsibility is to drive the vehicle. Only operate the COMAND (Cockpit Management and Data System), radio or telephone¹ if road and traffic conditions permit.

Bear in mind that at a speed of just 30 mph (approximately 50 km/h), your vehicle is covering a distance of approximately 44 feet (approximately 13.5 m) every second.

¹ Observe all legal requirements

Telephones and two-way radios

Warning!



Never operate radio transmitters equipped with a built-in or attached antenna (i.e. without being connected to an external antenna) from inside the vehicle while the engine is running. Doing so could lead to a malfunction of the vehicle's electronic system, possibly resulting in an accident and personal injury.

Radio transmitters, such as a portable telephone or a citizens band unit should only be used inside the vehicle if they are connected to an antenna that is installed on the outside of the vehicle.

Refer to the radio transmitter operation instructions regarding use of an external antenna.

Catalytic converter

Your Mercedes-Benz is equipped with monolithic type catalytic converters, an important element in conjunction with the oxygen sensors to achieve substantial control of the pollutants in the exhaust emissions. Keep your vehicle in proper operating condition by following our recommended maintenance instructions as outlined in your Service Booklet.



To prevent damage to the catalytic converters, use only premium unleaded gasoline in this vehicle.

Any noticeable irregularities in engine operation should be repaired promptly. Otherwise, excessive unburned fuel may reach the catalytic converter, causing it to overheat, which could start a fire.

Warning!



As with any vehicle, do not idle, park or operate this vehicle in areas where combustible materials such as grass, hay or leaves can come into contact with the hot exhaust system, as these materials could be ignited and cause a vehicle fire.

Emission control

Certain systems of the engine serve to keep the toxic components of the exhaust gases within permissible limits required by law.

These systems, of course, will function properly only when maintained strictly according to factory specifications. Any adjustments on the engine should, therefore, be carried out only by qualified Mercedes-Benz Center authorized technicians. Engine adjustments should not be altered in any way. Moreover, the specified service jobs must be carried out regularly according to Mercedes-Benz servicing requirements. For details refer to the Service Booklet.

Warning!



Inhalation of exhaust gas is hazardous to your health. All exhaust gas contains carbon monoxide, and inhaling it can cause unconsciousness and lead to death.

Do not run the engine in confined areas (such as a garage) which are not properly ventilated. If you think that exhaust gas fumes are entering the vehicle while driving, have the cause determined and corrected immediately. If you must drive under these conditions, drive only with at least one window fully open.

Operation

Driving instructions

Coolant temperature

During severe operating conditions and stop-and-go city traffic, the coolant temperature may rise close to approx. 248°F (120°C).

The engine should not be operated with the coolant temperature over 248°F (120°C). Doing so may cause serious engine damage which is not covered by the Mercedes-Benz Limited Warranty.

Warning!



- Driving when your engine is badly overheated can cause some fluids, which may have leaked into the engine compartment, to catch fire. You could be seriously burned.
- Steam from an overheated engine can cause serious burns and can occur just by opening the engine hood. Stay away from the engine if you see or hear steam coming from it.

Turn off the engine, get out of the vehicle and do not stand near the vehicle until it cools down.

At the gas station

Warning!



Gasoline is highly flammable and poisonous. It burns violently and can cause serious injury. Whenever you are around gasoline, avoid inhaling fumes and skin contact, extinguish all smoking materials. Never allow sparks, flame or smoking materials near gasoline!

The fuel filler flap is located on the right-hand side of the vehicle towards the rear. Locking/unlocking the vehicle with the remote control or the SmartKey with KEYLESS-GO* automatically locks/unlocks the fuel filler flap.

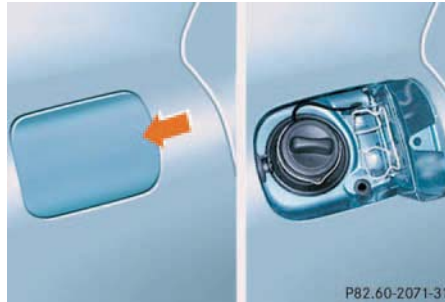

- ▶ Remove the key from the starter switch.
- ▶ Open the fuel filler flap by pushing at the point indicated by the arrow.
The fuel filler flap springs open.
- ▶ Turn the fuel cap to the left and hold on to it until possible pressure is released.
- ▶ Take off the cap and set it in the recess on the fuel filler flap.

To prevent fuel vapors from escaping into the open air, fully insert filler nozzle unit.

Operation

At the gas station

- ▶ Only fill your tank until the filler nozzle unit cuts out – **do not top up or overfill**.

Warning!



Overfilling of the fuel tank may create pressure in the system which could cause a gas discharge. This could cause the gas to spray back out when removing the fuel pump nozzle, which could cause personal injury.

- ▶ Replace the fuel cap by turning it to the right.
You will hear when the fuel cap is tightened.
- ▶ Close the fuel filler flap.

Operation

At the gas station



Use only premium unleaded gasoline with a minimum Posted Octane Rating of 91 (average of 96 RON / 86 MON). Information on gasoline quality can normally be found on the fuel pump.

More information on gasoline can be found in the Factory Approved Service Products Pamphlet.



Leaving the engine running and the fuel cap open can cause the **CHECK ENGINE** lamp to illuminate.

Check regularly and before a long trip

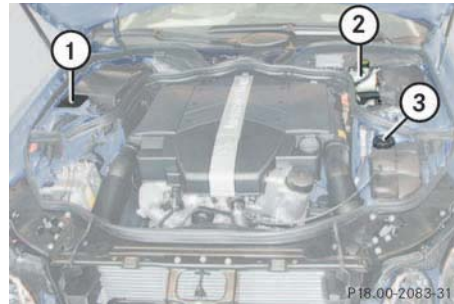

1 Windshield washer and headlamp cleaning system

For more information on refilling the reservoir, see the "Operation" section (▷ page 267).

2 Brake fluid

More information on brake fluid can be found in the "Technical data" section (▷ page 368).

3 Coolant level

More information on the coolant level can be found in the "Operation" section (▷ page 264).

Engine oil level

More information on engine oil can be found in the "Operation" section (▷ page 262).

See also "Opening hood" (▷ page 261).

Vehicle lighting

Check function and cleanliness. For more information on replacing light bulbs, see the "Practical hints" section (▷ page 332).

See also the section on the exterior lamp switch (▷ page 112).

Tire inflation pressure

More information on tire inflation pressure can be found in the "Operation" section (▷ page 269).

Engine compartment

Hood

Warning!



Do not pull the release lever while the vehicle is in motion. Otherwise the hood could be forced open by passing air flow.

Opening

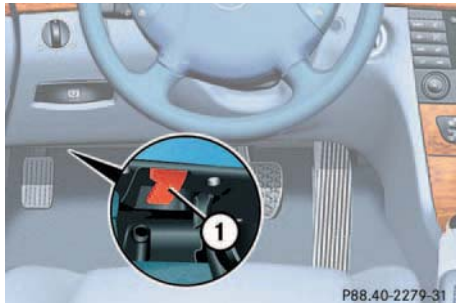

1 Hood release

- ▶ Pull lever **1** downwards.

The hood is unlocked and handle **2** will extend out of the radiator grille.



To avoid damage to the windshield wipers or hood, never open the hood if the wiper arms are folded forward away from the windshield.



2 Handle for opening the hood

Operation

Engine compartment

- ▶ Pull handle **2** to its stop out of radiator grille.
- ▶ Pull up on the hood (do not pull up on the handle) and then release it.

The hood will be automatically held open at shoulder height by gas-filled struts.

Warning!



To help prevent personal injury, stay clear of moving parts when the hood is open and the engine is running. Be sure the hood is properly closed before driving. When closing the hood, use extreme caution not to catch hands or fingers.

The radiator fan may continue to run for approximately 30 seconds or even restart after the engine has been turned off. Stay clear from fan blades.

Operation

Engine compartment

Warning!



If you see flames or smoke coming from the engine compartment, or if the coolant temperature gauge indicates that the engine is overheated, do not open the hood. Move away from vehicle and do not open the hood until the engine has cooled. If necessary, call a fire department.

Warning!



The engine is equipped with a transistorized ignition system. Because of the high voltage it is dangerous to touch any components (ignition coils, spark plug sockets, diagnostic socket) of the ignition system

- with the engine running
- while starting the engine
- if ignition is "on" and the engine is turned manually

Closing

Warning!



Be careful that you do not close the hood on anyone.

- ▶ Let the hood drop from a height of approximately 1 ft (30 cm).

The hood will lock audibly.

- ▶ Check to make sure that the hood is fully closed.

If you can raise the hood at a point above the headlamps, then it is not properly closed. Open it again and let it drop with somewhat greater force.

Engine oil

The amount of oil your engine needs will depend on a number of factors, including driving style. Higher oil consumption can occur when

- the vehicle is new
- the vehicle is driven frequently at higher engine speeds

Engine oil consumption checks should only be made after the vehicle break-in period.

Checking engine oil level



When checking the oil level the vehicle must

- be parked on level ground
- be at normal operating temperature
- have been stationary for at least five minutes with the engine turned off

You can check the engine oil level on the multifunction display.

- ▶ Turn the key in the starter switch to position **2**.

The standard display (▷ page 121) should appear in the multifunction display.

- ▶ Press button  or , on the steering wheel until the following message is seen in the multifunction display:

Engine oil level - Measuring now!
Measurement correct only if veh.
level

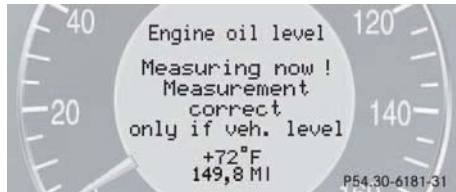

One of the following messages will subsequently appear in the indicator:

- Engine oil level ok
- Add 1.0 qt. to reach max. oil level!
(Canada: 1.0 liter)
- Add 1.5 qts. to reach max. oil level!
(Canada: 1.5 liters)
- Add 2.0 qts. to reach max. oil level!
(Canada: 2.0 liters)

- ▶ If necessary, add engine oil.

Adding engine oil



1 Filler neck

- ▶ Unscrew the cap from filler neck **1**. Be careful not to overfill with oil.

Be careful not to spill any oil when adding. Avoid environmental damage caused by oil entering the ground or water.

- ▶ Screw the cap back on the filler neck.



Excessive oil must be siphoned or drained off. It could cause damage to the engine and catalytic converter not covered by the Mercedes-Benz Limited Warranty.

Operation

Engine compartment

Other display messages

If there is excessive engine oil with the engine at normal operating temperature, the following message will appear:

Engine oil level Reduce oil level!

- ▶ Have excess oil siphoned.

If the key is not turned to position **2** in the starter switch:

Turn on ignition to see engine oil level!

- ▶ Switch on the ignition.

If you see the message:

Observe waiting time



- ▶ Wait five minutes before repeating check procedure.

If you see the message:

Engine oil level Not when engine on!

- ▶ Turn off the engine. If engine is at normal operating temperature, wait five minutes before checking oil. If the engine is not yet at normal operating temperature, you must wait 30 minutes before checking oil.



If you want to interrupt the checking procedure, press the  or  button on the multifunction steering wheel.

See "Practical hints" (▷ page 299) if the engine oil level indicator lights up in the display while the engine is running.

More information on engine oil can be found in the "Technical data" (▷ page 368).

Transmission fluid level

The transmission fluid level does not need to be checked. If you notice transmission fluid loss or gear shifting malfunctions, have an authorized Mercedes-Benz Center check the transmission.

Coolant level

The engine coolant is a mixture of water and anticorrosion/antifreeze. To check the coolant level, the vehicle must be parked on level ground and the engine must be cool.

The coolant expansion tank is located on the driver's side of the engine compartment.

Warning!



In order to avoid any possibly serious burns:

- Use extreme caution when opening the hood if there are any signs of steam or coolant leaking from the cooling system, or if the coolant temperature gauge indicates that the coolant is overheated.
- Do not remove pressure cap on coolant reservoir if engine temperature is above 194°F (90°C). Allow engine to cool down before removing cap. The coolant reservoir contains hot fluid and is under pressure.
- Using a rag, slowly open the cap approximately $\frac{1}{2}$ turn to relieve excess pressure. If opened immediately, scalding hot fluid and steam will be blown out under pressure.
- Do not spill antifreeze on hot engine parts. Antifreeze contains ethylene glycol which may burn if it comes into contact with hot engine parts.



1 Coolant expansion tank

- ▶ Using a rag, turn the cap slowly approximately one half turn to the left to release any excess pressure.
- ▶ Continue turning the cap to the left and remove it.

Operation

Engine compartment

The coolant level is correct if the level:

- for cold coolant: reaches the black top part of the reservoir
- for warm coolant: is approx. 0.6 in (1.5 cm) higher

- ▶ Add coolant as required.
- ▶ Replace and tighten cap.

More information on coolant can be found in the "Technical data" section (▷ page 370).

Operation

Engine compartment

Battery

Your vehicle is equipped with two batteries:

- Auxiliary battery (located in the engine compartment).
- Main battery (starter and electrical consumers; located in the trunk).

These batteries should always be sufficiently charged in order to achieve their rated service life.

If you use your vehicle mostly for short distance trips, you will need to have the battery charge checked more frequently.

When replacing batteries, always use batteries approved by Mercedes-Benz.

If you do not intend to operate your vehicle for an extended period of time, consult an authorized Mercedes-Benz Center about steps you need to observe.



Observe all safety instructions and precautions when handling automotive batteries.



Risk of explosion



Keep flames or sparks away from battery. Do not smoke.



Battery acid is caustic. Do not allow it to come into contact with skin, eyes or clothing.

In case it does, immediately flush affected area with clear water and seek medical help if necessary.



Wear eye protection.



Keep children away.



Follow the instructions in this Operator's Manual.

Batteries contain materials that can harm the environment if disposed of improperly. Recycling of batteries is the preferred method of disposal. Many states require sellers of batteries to accept old batteries for recycling.

Windshield washer system and headlamp cleaning system*

Fluid for the windshield washer system and the headlamp cleaning system is supplied from the windshield washer reservoir. It has a capacity of:

- Vehicles without headlamp cleaning system: approx. 4.8 US qt (4.5 l).
- Vehicles with headlamp cleaning system: approx. 7.4 US qt (7 l).

During all seasons, add MB Windshield Washer Concentrate "S" to water. Premix the windshield washer fluid in a suitable container.

- ▶ Refill the reservoir with MB Windshield Washer Concentrate and water (or commercially available premixed windshield washer solvent / antifreeze, depending on ambient temperatures).

Always use washer solvent/antifreeze where temperatures may fall below freezing. Failure to do so could result in damage to the washer system/reservoir.

Warning!



Washer solvent / antifreeze is highly flammable. Do not spill washer solvent / antifreeze on hot engine parts, because it may burn. You could be seriously burned.

More information can be found in the "Technical data" section (▷ page 372).

Operation

Engine compartment

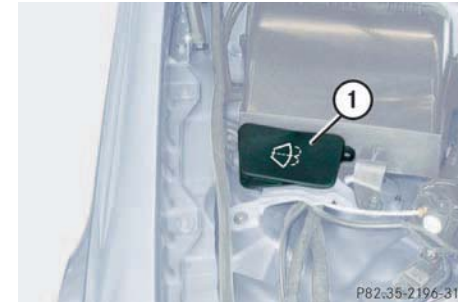

1 Washer fluid reservoir



Only use washer fluid which is suitable for plastic lenses. Improper washer fluid can damage the plastic lenses of the headlamps.

Operation

Tires and wheels

Tires and wheels

See your authorized Mercedes-Benz Center for information on tested and recommended rims and tires for summer and winter operation. They can also offer advice concerning tire service and purchase.

Warning!



Replace rims or tires with the same designation, manufacturer and type as shown on the original part. See your authorized Mercedes-Benz Center for further information. If incorrectly sized rims and tires are mounted

- the wheel brakes or suspension components can be damaged
- the correct operating clearance of the wheels and the tires are no longer guaranteed

Warning!



Worn, old tires can cause accidents. If the tire tread is badly worn, or if the tires have sustained damage, replace them.

When replacing rims, use only genuine Mercedes-Benz wheel bolts specified for the particular rim type. Failure to do so can result in the bolts loosening and possibly an accident.

Retread tires are not tested or recommended by Mercedes-Benz, since previous damage cannot always be recognized on retreads. Mercedes-Benz can therefore not assure the operating safety of the vehicle when such tires are used.

See your authorized Mercedes-Benz Center for information on tested and recommended rims and tires for summer and winter operation.

Important guidelines

- Use only sets of tires and rims of the same type and make.
- Tires must be of the correct size for the rim.
- Break in new tires for approximately 60 miles (100 km) at moderate speeds.
- Regularly check the tires and rims for damage.
- If vehicle is heavily loaded, check tire pressure and correct as required.
- Do not allow your tires to wear down too far. Adhesion properties on wet roads are sharply reduced at tread depths under $\frac{1}{8}$ in (3 mm).
- When replacing individual tires, you should mount new tires on the front wheels first (on vehicles with same-sized wheels all around).

Life of tire

The service life of a tire is dependent upon varying factors including but not limited to:

- Driving style
- Tire pressure
- Distance driven

Warning!



Tires and spare tire should be replaced after six years, independently of the remaining tread.



Keep unmounted tires in a cool, dry place with as little exposure to light as possible. Protect tires from contact with oil, grease and gasoline.

Direction of rotation

Unidirectional tires offer added advantages, such as better aquaplaning performance. To benefit, however, you must ensure that the tires rotate in the direction specified.

An arrow on the sidewall indicates the intended direction of tire rotation.

Checking tire inflation pressure

Warning!



If the tire pressure repeatedly drops:

- Check the tires for punctures from foreign objects
- Check to see whether air is leaking from the valves or from around the rim.

Regularly check your tire pressure at intervals of no more than 14 days.

Correct the tire pressure only when tires are cold.

If the tires are warm you should only correct the tire pressure if it is too low for current operating conditions.

A table on the fuel filler flap lists the specified tire inflation pressures for warm and cold tires as well as for various operating conditions.



The pressures listed for light loads are minimum values offering high driving comfort.

Increased inflation pressures listed for heavier loads may also be used for light loads. These higher pressures produce favorable handling characteristics. The ride of the vehicle, however, will be somewhat harder. Never exceed the maximum values or inflate tires below the minimum values listed in the fuel filler flap.

Operation

Tires and wheels

Tire pressure changes by approximately 1.5 psi (0.1 bar) per 18°F (10°C) of air temperature change. Keep this in mind when checking tire pressure where the temperature is different from the outside temperature.

Tire temperature and tire pressure are also increased while driving, depending on the driving speed and the tire load.

Check the spare tire periodically for condition and inflation. Spare tires will age and become worn over time even if never used, and thus should be inspected and replaced when necessary.

Warning!



Do not overinflate tires. Overinflating tires can result in sudden deflation (blowout) because they are more likely to become punctured or damaged by road debris, potholes etc. Follow recommended inflation pressures.

Do not overload the tires by exceeding the specified vehicle capacity weight (as indicated by the label on the pillar in the driver's door opening). Overloading the tires can overheat them, possibly causing a blowout.

Checking tire pressure electronically*

The tire inflation pressure monitor only functions on wheels that are equipped with the proper electronic sensors. It monitors the tire inflation pressure, as selected by the driver, in all four tires. A warning is issued to alert you to a decrease in pressure in one or more of the tires.

Tire pressure inquiries are made using the multifunction display (▷ page 121). The present inflation pressures are displayed only after a few minutes' travel time.

You can select the unit of measurement used for the tire inflation pressure by changing the setting in the control system (▷ page 136).

i

Possible differences between the readings of a tire pressure gauge of an air hose, e.g. gas station equipment, and the vehicle's control system can occur. The readings issued by the control system are more precise.

- ▶ Switch on ignition.
- ▶ Press the  button until the current inflation pressures for each tire appear in the multifunction display.

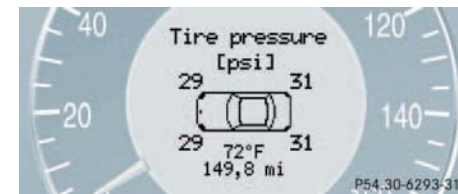

Warning!



The tire inflation pressure monitor does not indicate a warning for wrongly selected inflation pressures. Always adjust tire inflation pressure according to the label affixed on the fuel filler cap.



The tire inflation pressure monitor is not able to issue a warning due to a sudden loss of pressure (e.g. tire puncture caused by a foreign object). In this case bring the vehicle to a halt by carefully applying the brakes and avoiding abrupt steering maneuvers.



Operating radio transmission equipment (e.g. wireless headsets, two-way radios) in or near the vehicle could cause the tire inflation pressure monitor to malfunction.

Activating the tire inflation pressure monitor

You must activate the tire inflation pressure monitor in the following cases:

- If you have changed the tire pressure
 - If you have replaced the wheels or tires
 - If you have installed new wheels or tires
- ▶ Be sure that the tire pressure is correctly set.
- ▶ Press the  button on the steering wheel repeatedly until the standard display menu appears (▷ page 126).
- ▶ Press the  button until the inflation pressure of each tire appears in the multifunction display.



If transporting a deflated road wheel or additional wheel sensors in the vehicle, the tire inflation pressure monitor should not be reactivated until the deflated wheel or additional wheel sensors have been removed from the vehicle. Otherwise, the deflated wheel or additional sensors could confuse the tire inflation pressure monitor system and cause it to malfunction.

- ▶ Press the reset knob (▷ page 22).

The following message will appear in the multifunction display:
Check current tire pressure?.

- ▶ Press the  button for Yes.

The following message will appear in the multifunction display:

Tire pressure
monitor activated
Press. display after
driving a few mins.

Operation

Tires and wheels

If you wish to cancel activation:

- ▶ Press the  button.

If the following message appears in the multifunction display:

Tire pressure monitoring Reactivate
or
Tire pressure monitoring Check tires!

- ▶ Check the tire inflation pressures and correct them if necessary.
- ▶ Restart the activation of the tire inflation pressure monitor.

Rotating wheels

Warning!



Rotate front and rear wheels only if they are of the same size.

On vehicles with the same wheel size all around, wheels can be rotated every 3000 to 6000 miles (5000 to 10000 km), or sooner if necessary, according to the degree of tire wear. The same direction of tire rotation must be retained.

Rotate the wheels before the characteristic tire wear pattern becomes visible (shoulder wear on front wheels and tread center wear on rear wheels).

Thoroughly clean the inner side of the wheels after each rotation. Check and ensure proper tire inflation pressure.



If your vehicle is equipped with a tire inflation pressure monitor*, electronic components are located on the wheel. To prevent damage or incorrect installation, have the tires changed at an authorized Mercedes-Benz Center.

Warning!



Have the tightening torque checked after changing a wheel. Wheels could become loose if not tightened with a torque of 96 ft.lb. (130 Nm).

Use only genuine Mercedes-Benz wheel bolts specified for your vehicle's rims.

Winter driving

Before the onset of winter, have your vehicle winterized at an authorized Mercedes-Benz Center. This service includes:

- Check of anticorrosion and antifreeze concentration.
- Addition of cleaning concentrate to the water of the windshield and headlamp cleaning system. Add MB Concentrate "S" to a premixed windshield washer solvent / antifreeze which is formulated for below freezing temperatures (▷ page 371).
- Battery test. Battery capacity drops with decreasing ambient temperature. A well charged battery helps to ensure that the engine can be started, even at low ambient temperatures.
- Tire change. We recommend M+S rated radial-ply tires on all four wheels for the winter season.

Winter tires

Always use winter tires at temperatures below 39°F (4°C) and whenever wintry road conditions prevail. Use of winter tires is the only way to achieve the maximum effectiveness of the ABS and the ESP in winter operation.

For safe handling, ensure that all mounted winter tires are of the same make and have the same tread design.

Warning!



Winter tires having a tread depth under 0.16 in (4 mm) must be replaced. They are no longer suitable for winter operation.

Always observe the speed rating of the winter tires installed on your vehicle. If the maximum speed for which your tires are rated is below the speed rating of your vehicle, you must place a notice to this effect where it will be seen by the driver. Such notices are available from your tire dealer or from any authorized Mercedes-Benz Center.

Warning!



If you use your spare tire when winter tires are fitted on the other wheels, be aware that the difference in tire characteristics may very well impair turning stability and that overall driving stability may be reduced. Adapt your driving style to this.

Have the spare tire replaced with a winter tire at the nearest authorized Mercedes-Benz Center.

Operation

Winter driving

Block heater (Canada only)

The engine is equipped with a block heater.

The electrical cable may be installed at your authorized Mercedes-Benz Center.

Snow chains

When driving with snow chains, always select the raised level of the level control system AIRMATIC DC* (▷ page 209). Other settings may result in damage to your vehicle.

Snow chains should only be driven on snow-covered roads at speeds not to exceed 30 mph (50 km/h). Remove chains as soon as possible when driving on roads without snow.



When driving with snow chains, you may wish to deactivate the ESP (▷ page 76) before setting the vehicle in motion. This will improve the vehicle's traction.

Please observe the following guidelines when using snow chains:

- Use of snow chains is not permissible with all wheel/tire combinations.
- Chains should only be used on the rear wheels. Follow the manufacturer's mounting instructions.
- Only use snow chains that are approved by Mercedes-Benz. Your authorized Mercedes-Benz Center will be glad to advise you on this subject.



Use of snow chains is not permissible with tire size 245 / 45 R17 (▷ page 361).

Maintenance

Flexible Service System PLUS (FSS PLUS)

We strongly recommend that you have your vehicle serviced by your authorized Mercedes-Benz Center, in accordance with the Service Booklet at the times called for by the FSS PLUS (Flexible Service System PLUS).

Failure to have the vehicle maintained in accordance with the Service Booklet at the designated times/mileage called for by the FSS PLUS may result in vehicle damage not covered by the Mercedes-Benz Limited Warranty.

FSS PLUS will notify you when your next service is due.

Approximately one month before your next service is due, one of the following messages will appear in the multifunction display while you are driving or when you switch on the ignition (example service A):

Service A in XXXX miles (km)
Service A in XX days
Service A in X day

Service A due now!

The type of service due is indicated in the speedometer display field:

from Service A
(Minor service)
to Service H
(Major service)

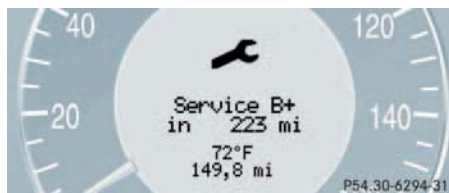

Operation

Maintenance



The additional + after the type of service indicates the degree of wear of the brake pads.

The brake pads may reach their wear limit in the time period up to the next service interval.

Have the brake pads checked and, if necessary, replaced by an authorized Mercedes-Benz Center during your next service appointment.



The interval between services depends on your driving habits. A gentle driving style, moderate engine speeds and the avoidance of short distance trips will lengthen the interval between services.

Clearing the service indicator

You can clear the service indicator

- ▶ Press the  button on the multifunction steering wheel.

Operation

Maintenance

The service indicator is cleared and the standard display appears in the multifunction display.

Service term exceeded

If you have exceeded the suggested service term, you will see the following message in the multifunction display:

Service A exceeded by XXXXX miles (km)

Service A exceeded by XXX days



Service A exceeded by X day

An authorized Mercedes-Benz Center will reset the service indicator following a completed service.

Calling up the service indicator

- ▶ Switch the ignition on.

The standard display of the control system appears (▷ page 121).

- ▶ Press button  or  on the multifunction steering wheel until the FSS PLUS indicator appears in the multifunction display.



If the battery is disconnected, the days of disconnection will not be included in the count shown by the service indicator. To arrive at the true service deadline, you will need to subtract these days from the days shown in the service indicator.



Do not confuse the service indicator with the engine oil level indicator .

Resetting the service indicator

In the event that a service on your vehicle is not carried out by an authorized Mercedes-Benz Center, you can reset the service indicator yourself.

- ▶ Switch the ignition on.

The standard display of the control system appears (▷ page 121).

- ▶ Press button  or  on the multifunction steering wheel until the FSS PLUS indicator appears in the multifunction display.
- ▶ Press the reset knob (▷ page 22) for about five seconds.

The SERVICE MENU appears in the multifunction display.



- ▶ Select the CONFIRMATION menu with the **+** or **-** button.
- ▶ Press the  button.

The service indicator now displays the CONFIRMATION menu.

The selection marker is on CONFIRM.



- ▶ Press the  button.
- The service indicator now displays the CONFIRM menu.

The selection maker is on STANDARD OIL.

- ▶ Press the  button.

The words SERVICE CONFIRMED appear in the multifunction display.



The service indicator is reset.

- ▶ Press button  on the multifunction steering wheel until the standard display appears in the multifunction display.

FSS PLUS now recalculates the values. You cannot call up the service display or the service menu during this time.



If the service indicator was inadvertently reset, have an authorized Mercedes-Benz Center correct it.



Only reset if the proper service has been performed. Resetting the system without proper service as called for by the FSS PLUS will cause the FSS PLUS to incorrectly determine the next service interval which will result in engine damage not covered by the Mercedes-Benz Limited Warranty.

Operation

Maintenance

Setting the date for special works

You can enter appointments for exhaust gas analysis and general inspection over FSS PLUS.



- ▶ Switch ignition on.
The standard display of the control system appears (▷ page 121).
- ▶ Press button  or  on the multifunction steering wheel until the FSS PLUS indicator appears in the multifunction display.
- ▶ Press the reset knob (▷ page 22) for about five seconds.

The SERVICE MENU appears in the multifunction display.

- ▶ Select the SPECIAL WORK menu with the  or  button.
- ▶ Press the  button.

The service indicator now displays the SPECIAL WORK menu.





- ▶ Select the EXH.-GAS ANALYSIS or GENERAL INSPECTION menu with the  or  button.
- ▶ Press the  button.

The service indicator now displays the NEXT DUE DATE menu.



- ▶ Select the MONTH and YEAR with the  or  button.

- ▶ Press button  or  on the multifunction steering wheel to set the month and year.

- ▶ Select DATE CONFIRMED with the  or  button.

- ▶ Press the  button.

The new date is set.

- ▶ Press button  on the multifunction steering wheel until the standard display appears in the multifunction display.





FSS PLUS now recalculates the values. You cannot call up the service display or the service menu during this time.

Calling up the service data information

FSS PLUS shows the service type (letters A-H) in the multifunction display approximately one month before the service appointment is due in miles (distance criterion) or in days (time criterion). This service type is based on the service items to be carried out. The service items are described in the Service Booklet.

The service items to be carried out under the corresponding service type can be displayed in the multifunction display.

Calling up the service item menu

- ▶ Switch ignition on.
The standard display of the control system appears (▷ page 121).
- ▶ Press button  or  on the multifunction steering wheel until the FSS PLUS indicator appears in the multifunction display.
- ▶ Press the reset knob (▷ page 22) for about five seconds.
The SERVICE MENU appears in the multifunction display (▷ page 121).
- ▶ Select the ITEMS menu with the  or  button.
- ▶ Press the  button.

The service indicator now displays the ITEMS menu.



The service items to be carried out are shown in this menu.

Please refer to the Service Booklet for a description of each service item.

- ▶ Press button  on the multifunction steering wheel until the standard display appears in the multifunction display.

Operation

Vehicle care

Vehicle care

Cleaning and care of vehicle

Warning!



Many cleaning products can be hazardous. Some are poisonous, others are flammable. Always follow the instructions on the particular container. Always open your vehicle's doors or windows when cleaning the inside.

Never use fluids or solvents that are not designed for cleaning your vehicle.

In operation, your vehicle is subjected to varying external influences which, if gone unchecked, can attack the paintwork as well as the undercarriage and cause lasting damage.

Such damage is caused not only by extreme and varying climatic conditions, but also by:

- Air pollution
- Road salt
- Tar, gravel and stone chipping

To avoid paint damage, you should immediately remove:

- Grease and oil
- Fuel
- Coolant
- Brake fluid
- Insects
- Tree resins etc.

Frequent washing reduces and / or eliminates the aggressiveness and potency of the above adverse influences.

More frequent washings are necessary to deal with unfavorable conditions, for example:

- Near the ocean
- In industrial areas (smoke, exhaust emissions)
- During winter operation

You should check your vehicle from time to time for stone chipping or other damage. Any damage should be repaired as soon as possible to prevent the start of corrosion.

In doing so, do not neglect the underside of the vehicle. A prerequisite for a thorough check is a washing of the undercarriage followed by a thorough inspection. Damaged areas need to be reundercoated.

Your vehicle has been treated at the factory with a wax-base rustproofing in the body cavities which will last for the lifetime of the vehicle. Post-production treatment is neither necessary nor recommended by Mercedes-Benz because of the possibility of incompatibility between materials used in the production process and others applied later.

We have selected car-care products and compiled recommendations which are specially matched to our vehicles and which always reflect the latest technology. You can obtain Mercedes-Benz approved car-care products at your authorized Mercedes-Benz Center.

Scratches, corrosive deposits, corrosion or damage due to negligent or incorrect care cannot always be removed or repaired with the car-care products recommended here. In such cases it is best to seek aid at your authorized Mercedes-Benz Center.

The following topics deal with the cleaning and care of your vehicle and give important "how-to" information as well as references to Mercedes-Benz approved car-care products.

Additional information can be found in the booklet entitled "Vehicle Care Guide".

Power washer

When using a power washer for cleaning the vehicle always observe the manufacturer's operating instructions.



Vehicles with KEYLESS-GO*:
If a door handle is hit by a strong jet of water, and a SmartKey with KEYLESS-GO* is in close proximity, i.e. within approx. 3 ft. (approx. 1 m), the vehicle could be inadvertently locked or unlocked.



Never use a round nozzle to power wash tires. The intense jet of water can result in damage to the tire.

Always replace a damaged tire.

Always keep the jet of water moving across the surface. Do not aim directly at electrical parts, electrical connectors, seals, or other rubber parts.

Tar stains

Quickly remove tar stains before they dry and become more difficult to remove. A tar remover is recommended.

Paintwork, painted body components

Mercedes-Benz approved Paint Care should be applied when water drops on the paint surface do not "bead up", normally in 3 to 5 months, depending on climate and washing detergent used.

Mercedes-Benz approved Paint Cleaner should be applied if the paint surface shows signs of embedded dirt (i.e. loss of gloss).

Do not apply any of these products or wax if your vehicle is parked in the sun or if the hood is still hot.

Use the appropriate MB-Touch-Up Stick for quick and provisional repairs of minor paint damage (i.e. chips from stones, vehicle doors, etc.).

Operation

Vehicle care

Engine cleaning

Prior to cleaning the engine compartment, make sure to protect electrical components and connectors from contact with water and cleaning agents.

Corrosion protection, such as MB Anticorrosion Wax should be applied to the engine compartment after every engine cleaning. Before applying, all control linkage bushings and joints should be lubricated. The poly-V-belt and all pulleys should be protected from any wax.

Vehicle washing

Do not use hot water or wash your vehicle in direct sunlight. Use only a mild car wash detergent, such as Mercedes-Benz approved Car Shampoo.

Thoroughly spray the vehicle with a diffused jet of water. Direct only a very weak spray towards the ventilation intake. Use plenty of water and rinse the sponge and chamois frequently.

Rinse with clear water and thoroughly wipe dry with a chamois. Do not allow cleaning agents to dry on the finish.

Due to the width of the vehicle, fold in outside mirrors prior to running the vehicle through an automatic car wash to prevent damage to the mirrors.

In the winter, thoroughly remove all traces of road salt as soon as possible.

When washing the undercarriage, do not forget to clean the inner sides of the wheels.



Vehicles with KEYLESS-GO*:
If a door handle is hit by a strong jet of water, and a SmartKey with KEYLESS-GO* is in close proximity, i.e. within approx. 3 ft. (approx. 1 m), the vehicle could be inadvertently locked or unlocked.

Ornamental moldings

For regular cleaning and care of very dirty chrome-plated parts, use a chrome cleaner.

Headlamps, tail lamps, turn signal lenses

Use a mild car wash detergent, such as Mercedes-Benz approved Car Shampoo, with plenty of water.

To prevent scratches, never apply strong force and use only a soft, non-scratchy cloth when cleaning the lenses. Do not attempt to wipe dirty lenses with a dry cloth or sponge.

Wiper blades

Clean the wiper blade inserts with a clean cloth and detergent solution.



For safety reasons, switch off wipers and remove key from starter switch before cleaning the wiper blades. Otherwise the wiper motor can suddenly turn on and cause injury.



Fold the windshield wiper arms away from the windshield in a vertical position only. They could otherwise damage the hood (▷ page 337).

Fold the windshield wiper arms back onto the windshield before turning the key in the starter switch.

Window cleaning

Use a window cleaning solution on all glass surfaces. An automotive glass cleaner is recommended.



For safety reasons, switch off wipers and remove key from starter switch before cleaning the windshield. Otherwise the wiper motor can suddenly turn on and cause injury.



Fold the windshield wiper arms away from the windshield in a vertical position only. They could otherwise damage the hood (▷ page 337).

Fold the windshield wiper arms back onto the windshield before turning the key in the starter switch.

Cleaning the Distronic* system sensor cover

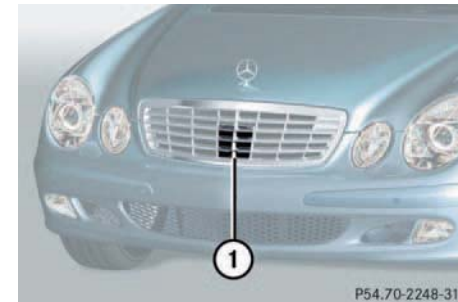

1 Distronic system sensor cover

Use a mild car wash detergent, such as Mercedes-Benz approved Car Shampoo, with plenty of water to clean sensor cover **1**.

Operation

Vehicle care

To prevent scratches, never apply strong force and use only a soft, non-scratchy cloth when cleaning the sensor cover. Do not attempt to wipe dirty sensors with a dry cloth or sponge.



Restart the engine after cleaning sensor cover **1**.

Cleaning the Parktronic* system sensors

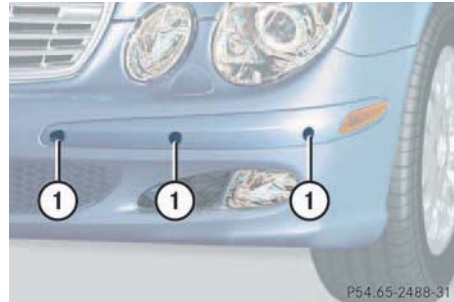

1 Parktronic* sensors

Use a mild car wash detergent, such as Mercedes-Benz approved Car Shampoo with plenty of water.

When using a steam cleaner or power washer, aim nozzle only briefly from a minimum distance of 4 in. (10 cm) at sensors **1**.

To prevent scratches, never apply strong force and use only a soft, non-scratchy cloth when cleaning the sensor. Do not attempt to wipe dirty sensors with a dry cloth or sponge.

Light alloy wheels

Mercedes-Benz approved Wheel Care should be used for regular cleaning of the light alloy wheels.

If possible, clean wheels once a week with Mercedes-Benz approved Wheel Care, using a soft bristle brush and a strong spray of water.

Follow the instructions on the container.



Use only acid-free cleaning materials. Acid could lead to corrosion.

Instrument cluster

Use a gentle dishwashing detergent or mild detergent for delicate fabrics as a washing solution. Wipe with a cloth moistened in a lukewarm solution. Do not use scouring agents.

Steering wheel and gear selector lever

Wipe with a damp cloth and dry thoroughly or clean with Mercedes-Benz approved Leather Care.

Cup holder

Use a gentle dishwashing detergent or mild detergent for delicate fabrics as a washing solution. Wipe with a cloth moistened in lukewarm solution. Do not use scouring agents.

Hard plastic trim items

Pour Mercedes-Benz approved Interior Care onto a soft, lint-free cloth and apply with light pressure.

Headliner and shelf below rear window

Clean with a soft bristle brush, or use a dry-shampoo cleaner in case of excessive dirt.

Seat belts

The webbing must not be treated with chemical cleaning agents. Use only clear, lukewarm water and soap. Do not dry the webbing at temperatures above 176°F (80°C) or in direct sunlight.

Warning!

Do not bleach or dye seat belts as this may severely weaken them. In a crash they may not be able to provide adequate protection.

Leather upholstery

Using aftermarket seat covers or wearing clothing that have the tendency to give off coloring (e.g. when wet, etc.) may cause the upholstery to become permanently discolored. By lining the seats with a proper intermediate cover, contact-discoloration will be prevented.

Wipe leather upholstery with a damp cloth and dry thoroughly or clean with Mercedes-Benz approved Leather Care. Exercise particular care when cleaning perforated leather as its underside should not become wet.

MB Tex upholstery

Pour Mercedes-Benz approved Interior Care onto a soft, lint-free cloth and apply with light pressure.

Plastic and rubber parts

Do not use oil or wax on these parts.



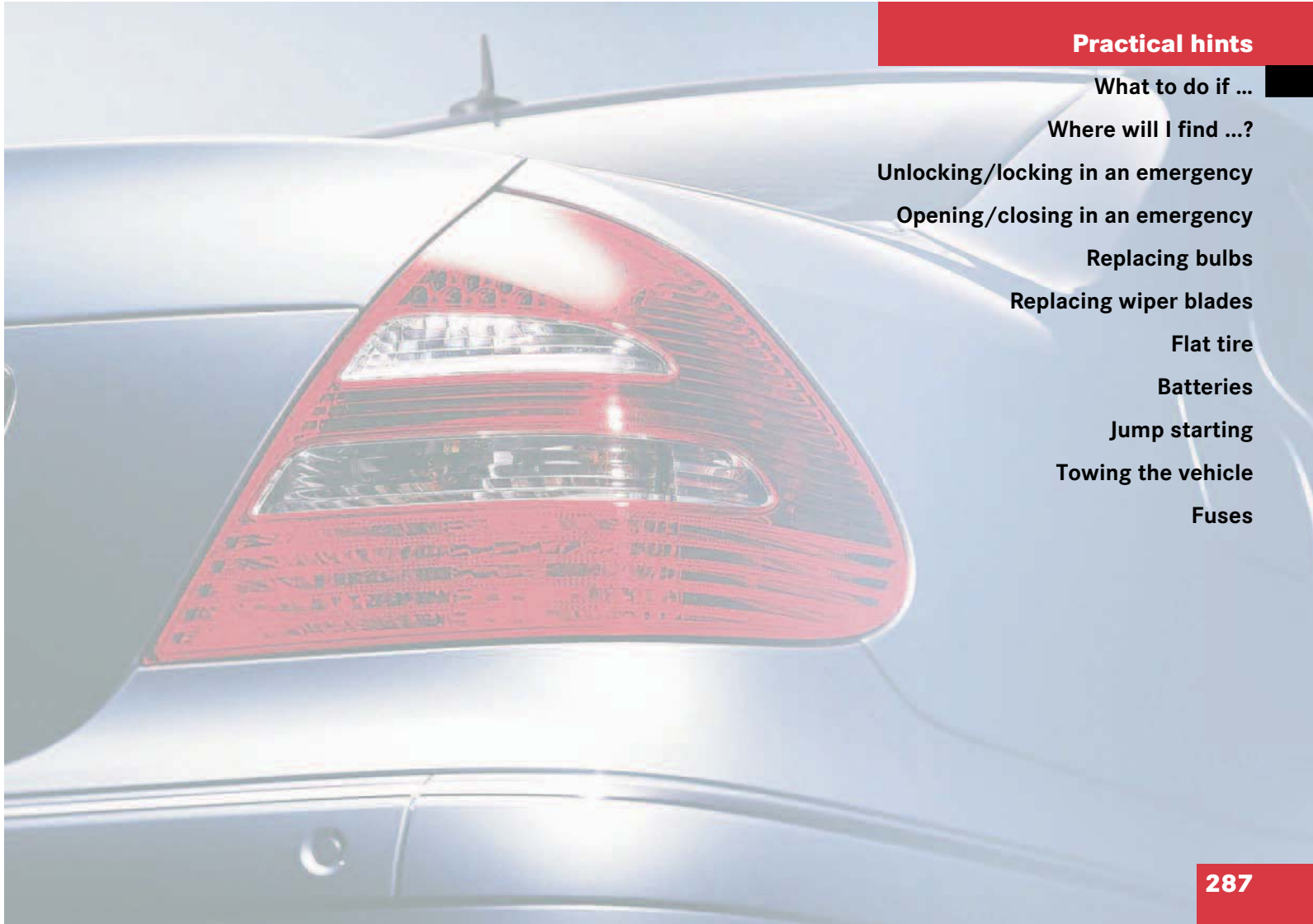

Practical hints

What to do if ...

Where will I find ...?

Unlocking/locking in an emergency

Opening/closing in an emergency

Replacing bulbs

Replacing wiper blades

Flat tire

Batteries

Jump starting

Towing the vehicle

Fuses

Practical hints

What to do if ...



What to do if ...

Lamps in instrument cluster

General information:



If a bulb in the instrument cluster fails to light up during the bulb self-check when

turning the SmartKey in the starter switch to position 2, have it checked and replaced if necessary.

Problem	Possible cause	Suggested solution
 The yellow ESP warning lamp lights up while driving.	The ESP is deactivated. Risk of accident! Adapt your speed and driving to the prevailing road conditions.	<ul style="list-style-type: none"> ▶ Turn the ESP back on (> page 77). If the ESP cannot be turned back on, have the system checked at an authorized Mercedes-Benz Center as soon as possible.
 The yellow ESP warning lamp flashes while driving.	The ESP or traction control has come into operation because of detected traction loss in at least one tire. Distronic* is deactivated. DISTRONIC* is switched off.	<ul style="list-style-type: none"> ▶ When driving off, apply as little throttle as possible. ▶ While driving, ease up on the accelerator. ▶ Adapt your speed and driving to the prevailing road and weather conditions. ▶ Do not deactivate the ESP. Exceptions: (> page 77). Failure to follow these instructions increases the risk of accidents.

Practical hints

What to do if ...

Problem	Possible cause	Suggested solution
 The yellow ABS malfunction indicator lamp comes on while driving.	<p>The ABS has detected a malfunction and has switched off. The BAS and the ESP are also switched off (see messages in display).</p> <p>The SBC brake system is still functioning normally but without the ABS available.</p>	<ul style="list-style-type: none"> ▶ Continue driving with added caution. Wheels will lock during hard braking, reducing steering capability. ▶ Have the system checked at an authorized Mercedes-Benz Center as soon as possible. <p>Failure to follow these instructions increases the risk of accidents.</p>
 The red DTR indicator lamp lights up while driving.	<p>You are too close to the vehicle in front of you to maintain selected speed.</p>	<ul style="list-style-type: none"> ▶ Apply the brakes immediately to increase the following distance.
 The red DTR indicator lamp comes on while driving and you hear a warning sound.	<ul style="list-style-type: none"> • You are gaining too rapidly on the vehicle ahead of you. • The distance warning system has recognized a stationary obstacle on your probable line of travel. 	<ul style="list-style-type: none"> ▶ Apply the brakes immediately. ▶ Carefully observe the traffic situation. You may need to brake or maneuver to avoid hitting an obstacle.

Practical hints

What to do if ...

Problem	Possible cause	Suggested solution
SRS The red SRS indicator lamp lights up while driving.	There is a malfunction in the restraint systems. The airbags or emergency tensioning devices (ETDs) could deploy unexpectedly or fail to activate in an accident.	► Drive with added caution to the nearest authorized Mercedes-Benz Center.



Warning!



In the event a malfunction of the SRS is indicated as outlined above, the SRS may not be operational. For your safety, we strongly recommend that you visit an authorized Mercedes-Benz Center immediately to have the system checked; otherwise the SRS may not be activated when needed in an accident, which could result in serious or fatal injury, or it might deploy unexpectedly and unnecessarily which could also result in injury.

Practical hints

What to do if ...

Problem	Possible cause	Suggested solution
 (Canada only)  (USA only) The red brake warning lamp lights up while driving and you hear a warning sound. The red brake warning lamp lights up while driving.	You are driving with the parking brake set. or There is a malfunction in the SBC brake system. There is insufficient brake fluid in the reservoir.	<ul style="list-style-type: none"> ▶ Release the parking brake. ▶ Read and observe the message in the display. ▶ Risk of accident! Carefully stop the vehicle and notify an authorized Mercedes-Benz Center. Do not add brake fluid! This will not solve the problem.

Warning!



Driving with the last message displayed can result in an accident. Have your brake system checked immediately if the brake warning lamp stays on.



Don't add brake fluid before checking the brake system. Overfilling the brake fluid reservoir can result in spilling brake fluid on hot engine parts and the brake fluid catching fire. You can be seriously burned.



If you find that the brake fluid in the brake fluid reservoir has fallen to the minimum mark or below, have the brake system checked for brake pad thickness and leaks.

Practical hints

What to do if ...

Problem	Possible cause	Suggested solution
 <p>The red coolant warning lamp lights up when the engine is running.</p>	<p>There is insufficient coolant in the reservoir.</p> <p>If this warning lamp lights up frequently, there is a leak in the cooling system.</p> <p>If the coolant level is correct, the electric radiator fan may be broken.</p>	<ul style="list-style-type: none"> ▶ Immediately add coolant to prevent engine from overheating (▷ page 264). ▶ Have the cooling system checked. ▶ If the coolant temperature is below 257 °F (125 °C), you can continue driving to the nearest authorized Mercedes-Benz Center. ▶ Avoid high engine loads (e.g. driving uphill) and stop-and-go driving.
 <p>The red coolant warning lamp lights up while driving and you hear a warning sound.</p>	<p>The coolant temperature has exceeded 257 °F (125 °C).</p>	<ul style="list-style-type: none"> ▶ Stop as soon as possible and allow the engine and coolant to cool down.

Warning!



Driving when your engine is badly overheated can cause some fluids which may have leaked into the engine compartment to



catch fire. You could be seriously burned.

Steam from an overheated engine can cause serious burns and can occur just by opening the engine hood. Stay away from the engine if you see or hear steam coming from it.

Turn off the engine, get out of the vehicle and do not stand near the vehicle until it cools down.

Practical hints

What to do if ...

Problem	Possible cause	Suggested solution
 The yellow "CHECK ENGINE" malfunction indicator lamp comes on while driving.	There is a malfunction in: <ul style="list-style-type: none"> • The fuel injection system • The ignition system • The exhaust system • The fuel system Such malfunctions may result in excessive emissions values and may switch the engine to its limp-home (emergency operation) mode.	► Have the vehicle checked as soon as possible by an authorized Mercedes-Benz Center. An on-board diagnostic connector is used by the service station to link the vehicle to the shop diagnostics system. It allows the accurate identification of system malfunctions through the readout of diagnostic trouble codes. It is located in the front left area of the footwell next to the parking brake.
	Your gas tank is empty.	► After refuelling, start the engine three or four times in succession. The limp-home mode is canceled. You do not need to have your vehicle checked.
 The red seat belt warning lamp blinks for a brief period after starting the engine.	The warning lamp reminds you to fasten seat belts.	► Fasten your seat belt.
 The yellow fuel tank reserve warning lamp lights up while driving.	The fuel level has gone below the reserve mark. Gas cap not closed tight.	► Refuel at the next gas station (▷ page 259). ► Close gas cap

Practical hints

What to do if ...

Lamp in center console

Problem	Possible cause	Suggested solution
PASSENGER AIRBAG OFF The indicator lamp lights up.	A BabySmart™ child seat is installed on the front passenger seat. Therefore, the front passenger airbag is switched off. The system is malfunctioning when there is no BabySmart™ child seat installed on the front passenger seat.	<ul style="list-style-type: none">▶ Have the system checked as soon as possible by an authorized Mercedes-Benz Center.
PASSENGER AIRBAG OFF The indicator lamp does not light up with a BabySmart™ child seat properly installed on the front passenger seat.	The system is malfunctioning.	<ul style="list-style-type: none">▶ Make sure that there is nothing between seat cushion and child seat and check installation of the child seat.▶ If the light remains out, have the system checked as soon as possible by an authorized Mercedes-Benz Center. Do not use the BabySmart™ restraint to transport children on the front passenger seat until the system has been repaired.

Messages in the display

The control system shows warning and malfunction messages in the multifunction display.

Certain warning and malfunction messages are accompanied by an audible signal.

Address these messages accordingly and follow the additional instructions given in this Operator's Manual.

Selecting the malfunction memory menu in the control system (▷ page 121) displays both cleared and uncleared messages.

High-priority messages appear in the multifunction display with a red background.

Warning!



All messages contain important information which should be taken note of and, where a malfunction is indicated, addressed as soon as possible at an authorized Mercedes-Benz Center.

Failure to repair condition noted may cause damage not covered by the Mercedes-Benz Limited Warranty, or result in property damage or personal injury.

Warning!



No messages will be displayed if either the instrument cluster or the multifunction display is inoperative.

Contact your nearest authorized Mercedes-Benz Center.

Practical hints

What to do if ...



Turning the key in the starter switch to position **2**, or pressing the KEY-LESS-GO* start/stop button twice to position **2** causes all lamps as well as the multifunction display to come on. Ensure that they are all in working order before starting your journey.

On the pages that follow, you will find a compilation of all the messages that may appear in the display.

Practical hints

What to do if ...

Display	Possible cause	Suggested solution
ABS	defective! Visit workshop!	<p>The ABS has detected a malfunction and has switched off. The ESP and the BAS are also deactivated. The SBC brake system is still functioning normally but without the ABS available.</p> <ul style="list-style-type: none">▶ Continue driving with added caution. Wheels will lock during hard braking, reducing steering capability.▶ Have the system checked at an authorized Mercedes-Benz Center as soon as possible. <p>Failure to follow these instructions increases the risk of accident.</p>
ABS	Display defective Visit workshop!	<p>The ABS or the ABS display is malfunctioning.</p> <ul style="list-style-type: none">▶ Continue driving with added caution.▶ Visit an authorized Mercedes-Benz Center as soon as possible. <p>Failure to follow these instructions increases the risk of accident.</p>

Practical hints

What to do if ...

Display		Possible cause	Suggested solution
ABS	Braking system not working!	<p>The charging voltage has fallen below 10 volts and the ABS has switched off.</p> <p>The brake system is still functioning normally but without the ABS available.</p>	<ul style="list-style-type: none"> ▶ When the voltage is above this value again, the ABS is operational again. ▶ Continue driving with added caution. Wheels will lock during hard braking, reducing steering capability. ▶ Have the system checked at an authorized Mercedes-Benz Center as soon as possible. <p>Failure to follow these instructions increases the risk of accident.</p>
BAS	defective! Visit workshop!	The BAS has detected a malfunction and switched off. The SBC brake system is still functioning normally but without the BAS available.	<ul style="list-style-type: none"> ▶ Continue driving with added caution. ▶ Visit an authorized Mercedes-Benz Center as soon as possible. <p>Failure to follow these instructions increases the risk of accident.</p>
BAS	Display malfunction Visit workshop!	The BAS or the BAS display is malfunctioning.	<ul style="list-style-type: none"> ▶ Continue driving with added caution. ▶ Visit an authorized Mercedes-Benz Center as soon as possible. <p>Failure to follow these instructions increases the risk of accident.</p>

Practical hints

What to do if ...

Display	Possible cause	Suggested solution
BAS not available! See operator's manual	<p>The charging voltage has fallen below 10 volts and the BAS has switched off.</p> <p>The brake system is still functioning normally but without the BAS available.</p>	<ul style="list-style-type: none"> ▶ When the voltage is above this value again, the BAS is operational again. ▶ Have the system checked at an authorized Mercedes-Benz Center if you see the warning message for a longer period of time. <p>Failure to follow these instructions increases the risk of accident.</p>
ESP Malfunction! Visit workshop!	<p>The ESP is deactivated because of a malfunction or interrupted power supply. The SBC brake system is still functioning normally. The ABS may still be operational.</p>	<ul style="list-style-type: none"> ▶ With the vehicle stationary, turn the steering wheel completely to the left and then to the right to synchronize the ESP. <p>If the ESP message does not go out:</p> <ul style="list-style-type: none"> ▶ Continue driving with added caution. ▶ Visit an authorized Mercedes-Benz Center as soon as possible. <p>Failure to follow these instructions increases the risk of accident.</p>





Practical hints

What to do if ...

Display	Possible cause	Suggested solution
ESP Display defective Visit workshop!	The BAS or the BAS display is malfunctioning.	<ul style="list-style-type: none"> ▶ Continue driving with added caution. ▶ Visit an authorized Mercedes-Benz Center as soon as possible. <p>Failure to follow these instructions increases the risk of accident.</p>
ESP not available! See operator's manual	The ESP is deactivated because of a malfunction or interrupted power supply. The SBC brake system is still functioning normally. The ABS may still be operational.	<ul style="list-style-type: none"> ▶ With the vehicle stationary, turn the steering wheel completely to the left and then to the right to synchronize the ESP. <p>If the ESP message does not go out:</p> <ul style="list-style-type: none"> ▶ Continue driving with added caution. ▶ Visit an authorized Mercedes-Benz Center as soon as possible. <p>Failure to follow these instructions increases the risk of accident.</p>
 Engine oil level Stop, engine off!	There is no oil in the engine. There is a danger of engine damage.	<ul style="list-style-type: none"> ▶ Carefully bring the vehicle to a halt as soon as possible. ▶ Turn off the engine. ▶ Add engine oil.

Practical hints

What to do if ...

Display	Possible cause	Suggested solution
 Engine oil level Check level!	The engine oil level is too low.	▶ Check the engine oil level (▷ page 262) and add oil as required.
 Engine oil level Reduce oil level!	You have added too much engine oil. There is a risk of damaging the engine or the catalytic converter.	▶ Have oil siphoned. Observe all legal requirements with respect to its disposal.
 Engine oil Visit workshop!	The engine oil has dropped to a critical level. There is water in the oil.	▶ Check the engine oil level (▷ page 262) and add oil as required. ▶ If you must add engine oil frequently, have the engine checked for possible leaks. ▶ Have the oil checked.
 Engine oil level Visit workshop!	The measuring system is malfunctioning.	▶ Have the measuring system checked by an authorized Mercedes-Benz Center.
Distronic	External interference Reactivate!	The Distronic* is switched off and is temporarily unavailable.
	Clean sensor! see oper. Manual	The Distronic* is switched off because the Distronic* cover in the radiator grille is dirty.
	Visit workshop!	The Distronic* is malfunctioning or the display is malfunctioning.
		▶ Try activating the Distronic* again later. ▶ Clean the Distronic* cover in the radiator grille (▷ page 283). ▶ Restart the vehicle. ▶ Visit an authorized Mercedes-Benz Center as soon as possible.

Practical hints

What to do if ...

Display	Possible cause	Suggested solution
P	Gear selector lever in P You have turned off the engine with the KEYLESS-GO* start/stop button* and opened the driver's door.	▶ Place the selector lever in position P .
Cruise control	Visit workshop! Cruise control or Distronic* is malfunctioning.	▶ Have the cruise control or Distronic* checked by an authorized Mercedes-Benz Center.
SRS	Restraint system malfunction Visit workshop! The system is malfunctioning.	▶ Drive with added caution to the nearest authorized Mercedes-Benz Center.
	Vehicle rising! Your vehicle is adjusting to your level selection.	
	Level selec. canceled The "Raised" level setting is canceled at vehicle speeds of over 75 mph (120 km/h).	▶ Reactivate the "Raised" level setting.

Warning!





In the event a malfunction of the SRS is indicated as outlined above, the SRS may not be operational. For your safety, we strongly recommend that you visit an authorized Mercedes-Benz Center immediately to have the system checked; otherwise the

SRS may not be activated when needed in an accident, which could result in serious or fatal injury, or it might deploy unexpectedly and unnecessarily which could also result in injury.







Practical hints

What to do if ...

Display	Possible cause	Suggested solution
	Stop, car too low!	<p>The car level control is malfunctioning.</p> <p>Avoid excessive steering input. The fender or tires could otherwise be damaged. Listen for scraping noises. Do not drive faster than 50 mph (80 km/h).</p> <ul style="list-style-type: none"> ▶ Drive to the side of the road and select a higher vehicle level. Depending on the type of malfunction, this may raise the vehicle's level. <p>There is otherwise danger of an accident.</p>
	Visit workshop!	<p>The system is functional only to a limited extent.</p> <p>The system display or the system is malfunctioning.</p> <ul style="list-style-type: none"> ▶ Do not drive faster than 50 mph (80 km/h). ▶ Have the vehicle checked at an authorized Mercedes-Benz Center.
	Backrest, rear right not locked	<p>The rear seat backrest is not engaged.</p> <ul style="list-style-type: none"> ▶ Adjust the rear seat backrest until it is fully engaged in position.
	Backrest, rear left not locked	<p>The rear seat backrest is not engaged.</p> <ul style="list-style-type: none"> ▶ Adjust the rear seat backrest until it is fully engaged in position.



Practical hints

What to do if ...

Display	Possible cause	Suggested solution
 Display defective	The instrument cluster display is malfunctioning.	<ul style="list-style-type: none"> ▶ Continue driving with added caution. ▶ Visit an authorized Mercedes-Benz Center as soon as possible.
 Display defective Visit workshop!	The displays for several systems have malfunctioned. Some systems themselves may also have malfunctioned.	▶ Have the electronic systems checked by an authorized Mercedes-Benz Center.
 Visit workshop!	One or more main functions of the Tele Aid system are malfunctioning.	▶ Have the Tele Aid system checked by an authorized Mercedes-Benz Center.
 Malfunction Electrical consumers switched off	The consumer battery has insufficient voltage and can no longer supply the convenience functions such as seat ventilation*.	The electrical consumers will come back online as soon as on-board voltage is sufficient.
 Battery/Alternator Stop vehicle!	The battery is malfunctioning. The SBC brake system requires electrical energy and therefore has only limited operation. Considerably greater brake pedal force is required and the stopping distance is increased.	<ul style="list-style-type: none"> ▶ Stop the vehicle as soon as it is safe to do so. Adjust driving to be consistent with reduced braking responsiveness. ▶ Notify an authorized Mercedes-Benz Center.
 Undervoltage Charge battery	The battery has insufficient voltage.	▶ Start the engine (> page 43).





Practical hints

What to do if ...

Display	Possible cause	Suggested solution
 Undervoltage Switch off consumers	The battery has insufficient voltage.	▶ Turn off unnecessary electrical consumers.
 Battery/Alternator Visit workshop!	<p>The battery was charged with a battery charger or jump started.</p> <p>The battery is no longer charging. Possible causes:</p> <ul style="list-style-type: none"> • Alternator malfunctioning • Broken poly-V-belt <p>Do not forget that the brake system requires electrical energy and may be operating with restricted capability. Considerably greater brake pedal force is required and the stopping distance is increased.</p>	<p>▶ Have the battery checked at a service station.</p> <p>▶ Stop immediately and check the poly-V-belt.</p> <p>If it is broken:</p> <ul style="list-style-type: none"> ▶ Do not continue to drive. Notify an authorized Mercedes-Benz Center. <p>If it is in order:</p> <ul style="list-style-type: none"> ▶ Drive immediately to the nearest authorized Mercedes-Benz Center. Adjust driving to be consistent with reduced braking responsiveness.

Practical hints

What to do if ...

Display	Possible cause	Suggested solution
 Brake wear Visit workshop!	The brake pads have reached their wear limit.	<ul style="list-style-type: none"> ▶ Brake pad thickness must be visually inspected at the intervals specified in the Service Booklet. ▶ Have the brake pads replaced as soon as possible.
 Brake malfunction Stop vehicle	The SBC brake system is in the limp-home (emergency operation) mode. Considerably greater brake pedal force is required and the stopping distance is increased. Do not exceed a speed of 55 mph (90 km/h).	<ul style="list-style-type: none"> ▶ Do not drive any further. ▶ Significantly greater force must be applied to the brake pedal. ▶ Call for roadside assistance.
Except Canada:  Canada only: 	Reduced braking effect Start engine! Increased braking distance Start engine!	<ul style="list-style-type: none"> ▶ Start the engine. The message disappears when sufficient voltage is available



Practical hints

What to do if ...

Display	Possible cause	Suggested solution
Except Canada: BRAKE Canada only: ⓘ	Reduced braking effect Visit workshop! Increased braking distance Visit workshop! Brake fluid Visit workshop!	The SBC brake system is in the limp-home (emergency operation) mode. Considerable brake pedal force is required and the stopping distance is increased. There is insufficient brake fluid in the reservoir.
		<ul style="list-style-type: none"> ▶ Continue driving with added caution. ▶ Adjust driving to be consistent with reduced braking responsiveness. ▶ Risk of accident! Stop the vehicle and notify an authorized Mercedes-Benz Center. Do not add brake fluid! This will not solve the problem.
Except Canada: BRAKE Canada only: ⓘ	Service brake Visit workshop!	There are malfunctions, but the SBC brake system is operating normally.
		<ul style="list-style-type: none"> ▶ Visit an authorized Mercedes-Benz Center as soon as possible.

Practical hints

What to do if ...

Display	Possible cause	Suggested solution
Except Canada:  Canada only: 	Brakes overheated! Drive carefully!	The brake system is overheated due to an excessive load on the brakes.
		<ul style="list-style-type: none"> ▶ Relieve the load on the brake system. ▶ Drive more smoothly and think ahead to avoid unnecessary braking. ▶ When driving down slopes, shift into a lower gear to use the engine's braking power (▷ page 153). ▶ Cautiously continue driving so that the air stream will cool down the brakes.

Warning!



Driving while these messages are displayed can result in an accident. Have your brake system checked immediately.

If there is a malfunction in the SBC brake system, we recommend that the vehicle be transported with all wheels off the ground using flatbed or appropriate wheel lift/dolly equipment. A tow bar must be used if circumstances do not permit the use of the

recommended towing methods and the vehicle requires towing with all four wheels on the ground. Towing the vehicle with all four wheels on the ground is only permissible for distances up to 30 miles (50 km) and at a speed not to exceed 30 mph (50 km/h). For more information, refer to "Towing the vehicle" (▷ page 348).

If the SBC brake system enters its limp-home (emergency operation) mode, the driver must apply significantly greater

brake pedal pressure and depress the pedal much further than normal to obtain braking effect. If necessary, apply full pressure to the brake pedal. Brakes are only applied to the front wheels. Stopping distance is increased!

Low brake fluid in the reservoir may cause the braking system to fail!

Don't add brake fluid before checking the brake system. Overfilling the brake fluid

Practical hints

What to do if ...

reservoir can result in spilling brake fluid on hot engine parts and the brake fluid catching fire. You can be seriously burned.







If you find that the brake fluid in the brake fluid reservoir has fallen to the minimum mark or below, have the brake system checked for brake pad thickness and leaks.



Brake pad thickness must be visually inspected at the intervals specified in the Service Booklet.







Practical hints

What to do if ...

Display	Possible cause	Suggested solution	
	Key Check battery!	The batteries in the KEYLESS-GO* key are discharged. ▶ Change the batteries (▷ page 328).	
	Key not recognized!	The KEYLESS-GO* key is not recognized while the engine is running because <ul style="list-style-type: none"> • the card is not in the vehicle • there is strong radio-frequency interference 	▶ Stop the vehicle as soon as it is safe to do so. ▶ Search for the card or continue to operate the vehicle with the key. Otherwise the vehicle cannot be centrally locked nor can the engine be started again after the engine is stopped.
		The KEYLESS-GO* key is momentarily not recognized.	▶ Change the position of the card in the vehicle. ▶ Operate the vehicle with the key if necessary.
	Function Not available!	This display appears if button  or  on the multifunction steering wheel is pressed and the vehicle is not equipped with a telephone.	



Practical hints

What to do if ...

Display	Possible cause	Suggested solution	
	Key recognized in vehicle!	A KEYLESS-GO* key left in the vehicle was recognized while locking the vehicle from the outside.	▶ Take the key out of the vehicle.
	Key Visit workshop!	The KEYLESS-GO* system is malfunctioning.	▶ Visit an authorized Mercedes-Benz Center as soon as possible.
	Key do not forget key	This display appears (for a maximum of 60 seconds) if the driver's door is opened with the engine shut off and no key in the starter switch. This message is only a reminder.	▶ Insert key in the starter switch.
	Entry position Do not drive!	Seat, mirrors and steering wheel have not yet moved to their preset driving positions.	▶ Wait until the seat, mirrors and steering wheel have moved to their driving positions. The message disappears.
Except Canada:  Canada only: 	Release park. brake!	You are driving with the parking brake set.	▶ Release the parking brake (▷ page 45).
	Visit workshop!	The seat belt system is malfunctioning.	▶ Visit an authorized Mercedes-Benz Center as soon as possible.
	Trunk open!	This message will appear whenever the trunk lid is open.	▶ Close the trunk lid.

Practical hints

What to do if ...

Display	Possible cause	Suggested solution
 Washer fluid Check level	The fluid level has dropped to about $\frac{1}{3}$ of total reservoir capacity.	▶ Add washer fluid (▷ page 267).
 Coolant Check level	The coolant level is too low.	▶ Add coolant (▷ page 264). ▶ If you have to add coolant frequently, have the cooling system checked by an authorized Mercedes-Benz Center.
 Coolant Visit workshop!	The cooling fan for the coolant is malfunctioning.	▶ Observe the coolant temperature display. ▶ Have the fan replaced as soon as possible.

Warning!



Do not spill antifreeze on hot engine parts. Antifreeze contains ethylene glycol which may burn if it comes into contact with hot engine parts. You can be seriously burned.



Do not ignore the low engine coolant level warning. Extended driving with the message and symbol displayed may cause serious engine damage not covered by the Mercedes-Benz Limited Warranty.

Do not drive without sufficient amount of coolant in the cooling system. The engine will overheat causing major engine damage.

Practical hints

What to do if ...

Display	Possible cause	Suggested solution
 Coolant Stop, engine off!	The coolant is too hot. The poly-V-belt could be broken.	<ul style="list-style-type: none">▶ Stop the vehicle.▶ Only start the engine again after the message disappears. You could otherwise damage the engine.▶ Stop immediately and check the poly-V-belt.▶ If it is broken, do not drive any further. Notify an authorized Mercedes-Benz Center. If it is in order, drive immediately to the nearest authorized Mercedes-Benz Center.

Warning!







Driving when your engine is badly overheated can cause some fluids which may have leaked into the engine compartment to

catch fire. You could be seriously burned. Steam from an overheated engine can cause serious burns and can occur just by opening the engine hood. Stay away from the engine if you see or hear steam coming from it. Turn off the engine, get out of the vehicle

and do not stand near the vehicle until it cools down. The engine should not be operated with the coolant temperature above 266°F (130°C). Doing so may cause serious engine damage which is not covered by the Mercedes-Benz Limited Warranty.

Practical hints

What to do if ...

Display	Possible cause	Suggested solution
 Reserve fuel	The fuel level has dropped below the reserve mark.	▶ Refuel at the next gas station (▷ page 259).
 Hood open!	You are driving with the hood open.	▶ Close the hood (▷ page 261).
 Remove key!	You have forgotten to remove the key.	▶ Remove the key from the starter switch.
	Replace key	▶ Visit an authorized Mercedes-Benz Center as soon as possible.
 Lamp sensor Visit workshop!	The lamp sensor is malfunctioning. The headlamps switch on automatically.	▶ In the control system, set lamp operation to manual mode (▷ page 130). ▶ Switch on headlamps using the exterior lamp switch.
	Low beam, left	▶ Visit an authorized Mercedes-Benz Center as soon as possible.
	Low beam, right	▶ Visit an authorized Mercedes-Benz Center as soon as possible.

Practical hints

What to do if ...

Display	Possible cause	Suggested solution
 Display defective Visit workshop!	The display for the lamps or the system is malfunctioning.	▶ Visit an authorized Mercedes-Benz Center as soon as possible.
Turn signal, rear left Substitute lamp on!	The left rear turn signal lamp is malfunctioning. A backup bulb is being used.	▶ Replace the bulb as soon as possible.
Turn signal, rear right Substitute lamp on!	The right rear turn signal lamp is malfunctioning. A backup bulb is being used.	▶ Replace the bulb as soon as possible.
Turn sig. left mirror	The left turn signal in the side mirror is malfunctioning. This message will only appear if all light emitting diodes have stopped working.	▶ Have the LEDs replaced as soon as possible.
Marker light, front left	The front left side marker lamp is malfunctioning.	▶ Replace the bulb as soon as possible.
Marker light front right	The front right side marker lamp is malfunctioning.	▶ Replace the bulb as soon as possible.
Re, left marker lamp	The rear left side marker lamp is malfunctioning.	▶ Replace the bulb as soon as possible.
Re, right marker lamp	The rear right side marker lamp is malfunctioning.	▶ Replace the bulb as soon as possible.

Practical hints

What to do if ...

Display	Possible cause	Suggested solution	
	Turn sig. right mirror	The right turn signal in the side mirror is malfunctioning. This message will only appear if all light emitting diodes have stopped working.	► Have the LEDs replaced as soon as possible.
	Turn sig. front left Back-up light on!	The left front turn signal lamp is malfunctioning. A backup bulb is being used.	► Replace the bulb as soon as possible.
	Turn sig. front right Back-up light on!	The right front turn signal lamp is malfunctioning. A backup bulb is being used.	► Replace the bulb as soon as possible.
	Brake light Visit workshop!	Stop lamp illumination is delayed or lamp is permanently on.	► Visit an authorized Mercedes-Benz Center as soon as possible.
	Turn off lamps!	Lamps have been turned on although the key in the starter switch is in position 0 .	► Visit an authorized Mercedes-Benz Center as soon as possible.
	Brake light, left	The left brake lamp is malfunctioning. A backup bulb is being used.	► Visit an authorized Mercedes-Benz Center as soon as possible.
	Brake light, right	The right brake lamp is malfunctioning. A backup bulb is being used.	► Visit an authorized Mercedes-Benz Center as soon as possible.



Practical hints

What to do if ...

Display		Possible cause	Suggested solution
	3rd stop lamp	The high mounted brake lamp is malfunctioning.	► Visit an authorized Mercedes-Benz Center as soon as possible.
	High beam, left	The left high beam lamp is malfunctioning.	► Replace the bulb as soon as possible.
	High beam, right	The right high beam lamp is malfunctioning.	► Replace the bulb as soon as possible.
	License plate lamp, left	The left license plate lamp is malfunctioning.	► Replace the bulb as soon as possible.
	License plate lamp, right	The right license plate lamp is malfunctioning.	► Replace the bulb as soon as possible.
	Front foglight, left	The left front fog lamp is malfunctioning.	► Replace the bulb as soon as possible.
	Front foglight, right	The right front fog lamp is malfunctioning.	► Replace the bulb as soon as possible.
	Rear foglight	The rear fog lamp is malfunctioning. A backup bulb is being used.	► Replace the bulb as soon as possible.
	Back-up lamp, left	The left backup lamp is malfunctioning.	► Replace the bulb as soon as possible.



Practical hints

What to do if ...

Display	Possible cause	Suggested solution	
	Back-up lamp, right	The right backup lamp is malfunctioning.	▶ Replace the bulb as soon as possible.
	Tail light, left	The left tail lamp is malfunctioning. A backup bulb is being used.	▶ Visit an authorized Mercedes-Benz Center as soon as possible.
	Tail light, right	The right tail lamp is malfunctioning. A backup bulb is being used.	▶ Visit an authorized Mercedes-Benz Center as soon as possible.
	Park. light, front left Back-up light on!	The left parking lamps are malfunctioning. A backup bulb is being used.	▶ Visit an authorized Mercedes-Benz Center as soon as possible.
	Park. light, front right Back-up light on!	The right parking lamps are malfunctioning. A backup bulb is being used.	▶ Visit an authorized Mercedes-Benz Center as soon as possible.
	Seat belt system Visit workshop!	The seat belt system is malfunctioning.	▶ Visit an authorized Mercedes-Benz Center as soon as possible.

Practical hints

What to do if ...

Display		Possible cause	Suggested solution
	Front passenger seat belt Please fasten belt!	The display reminds you and your passengers to fasten seat belts.	► Fasten the seat belts.
	Driver's seat belt Fasten seat belt!	The display reminds you and your passengers to fasten seat belts.	► Fasten the seat belts.
	Steering oil Visit workshop!	The steering gear oil level is too low. There is a danger of steering gear damage.	► Have the system checked by an authorized Mercedes-Benz Center.

Warning!



If the level of steering gear oil in reservoir is too low, the steering power assistance could fail. Much greater effort will then be needed to turn the steering wheel.

Do not add steering oil without checking the steering system.

Do not drive the vehicle. Have the system checked at your authorized Mercedes-Benz Center as soon as possible.

Practical hints

What to do if ...

Display	Possible cause	Possible solution
 Tire pressure monitoring activated	The tire pressure is being checked.	
Tire pressure monitoring Reactivate	The tire inflation pressure monitor* is deactivated.	▶ Activate the tire inflation pressure monitor* (> page 271).
Tire pressure monitoring currently inactive	The tire inflation pressure monitor* is unable to monitor the tire pressure due to <ul style="list-style-type: none">• the presence of several wheel sensors in the vehicle.• excessive wheel sensor temperatures.• a nearby radio interference source.• unrecognized wheel sensors mounted.	▶ Check the tire pressure at the next service station.

Warning!



Do not drive with a flat tire. A flat tire affects the ability to steer or brake the vehicle.

You may lose control of the vehicle. Continued driving with a flat tire will cause excessive heat build-up and possibly a fire.

Practical hints

What to do if ...

Display	Possible cause	Possible solution
 <p>Tire pressure monitoring Visit workshop!</p>	<p>The tire inflation pressure monitor is malfunctioning.</p> <p>A wheel without proper sensor was installed.</p>	<ul style="list-style-type: none"> ▶ Have the tire inflation pressure monitor checked by an authorized Mercedes-Benz Center. ▶ Change the wheel.
<p>Tire pressure, rear left Caution tire defect!</p>	<p>The left rear tire is rapidly deflating.</p>	<ul style="list-style-type: none"> ▶ Carefully bring the vehicle to a halt, avoiding abrupt steering and braking maneuvers. ▶ Change the wheel (▷ page 338).
<p>Tire pressure, rear left Check tires!</p>	<p>The left rear tire pressure is low.</p>	<ul style="list-style-type: none"> ▶ Carefully bring the vehicle to a halt. ▶ Check the tire pressure. ▶ Change the wheel (▷ page 338).

Warning!



Do not drive with a flat tire. A flat tire affects the ability to steer or brake the vehicle. You may lose control of the vehicle.

Continued driving with a flat tire will cause excessive heat build-up and possibly a fire.

Practical hints

What to do if ...

Display	Possible cause	Possible solution
 Tire pressure, rear right Caution tire defect!	The right rear tire is rapidly deflating.	<ul style="list-style-type: none">▶ Carefully bring the vehicle to a halt, avoiding abrupt steering and braking maneuvers.▶ Change the wheel (▷ page 338).
Tire pressure, rear right Check tires!	The right rear tire pressure is low.	<ul style="list-style-type: none">▶ Carefully bring the vehicle to a halt.▶ Check the tire pressure.▶ Change the wheel (▷ page 338).
Tire pressure, front left Caution tire defect!	The left front tire is rapidly deflating.	<ul style="list-style-type: none">▶ Carefully bring the vehicle to a halt, avoiding abrupt steering and braking maneuvers.▶ Change the wheel (▷ page 338).

Warning!



Do not drive with a flat tire. A flat tire affects the ability to steer or brake the vehicle. You

may lose control of the vehicle. Continued driving with a flat tire will cause excessive heat build-up and possibly a fire.

Practical hints

What to do if ...

Display	Possible cause	Possible solution
 Tire pressure, front left Check tires!	The right rear tire pressure is low.	<ul style="list-style-type: none"> ▶ Carefully bring the vehicle to a halt. ▶ Check the tire pressure. ▶ Change the wheel (▷ page 338).
Tire pressure, front right Caution tire defect!	The right front tire is rapidly deflating.	<ul style="list-style-type: none"> ▶ Carefully bring the vehicle to a halt, avoiding abrupt steering and braking maneuvers. ▶ Change the wheel (▷ page 338).
Tire pressure, front right Check tires!	The right front tire pressure is low.	<ul style="list-style-type: none"> ▶ Carefully bring the vehicle to a halt. ▶ Change the wheel (▷ page 338).

Warning!







Do not drive with a flat tire. A flat tire affects the ability to steer or brake the vehicle.

You may lose control of the vehicle. Continued driving with a flat tire will cause excessive heat build-up and possibly a fire.

Practical hints

What to do if ...

Display	Possible cause	Possible solution
	Remove key!	You have forgotten to remove the key. ▶ Remove the key from the starter switch.
	Replace key	The batteries in the key are dead. ▶ Change the batteries (▷ page 328).
	Automat. light on Remove key!	▶ Remove the key from the starter switch.
	Reserve fuel	The fuel level has dropped below the reserve mark. ▶ Refuel at the next filling station (▷ page 259).
	Door open	You are attempting to drive with one or more doors open. ▶ Close the doors.
	Visit workshop!	There may be a malfunction in the: <ul style="list-style-type: none"> • fuel injection system • ignition system • exhaust system • fuel system ▶ Have the measuring system checked by an authorized Mercedes-Benz Center.
	Display defective Visit workshop!	Certain electronic systems are unable to relay information to the control system. The following systems may have failed: <ul style="list-style-type: none"> • Coolant temperature display • Tachometer • Cruise control display ▶ Have the electronic systems checked by an authorized Mercedes-Benz Center.

Practical hints

Where will I find ...?

Where will I find ...?

First aid kit

The first aid kit is in the storage compartment at the front edge of the front passenger seat.

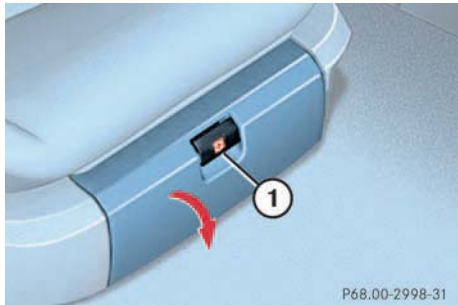

- ▶ Pull tab **1** upward.
- ▶ Fold the covering forward.
- ▶ Remove the first aid kit.



Check expiration dates and contents for completeness at least once a year and replace missing/expired items.

Spare wheel

The spare wheel is located under the trunk floor.

- ▶ Lift the trunk floor and engage the handle in the upper edge of trunk.
- ▶ Remove the luggage box (▷ page 325).

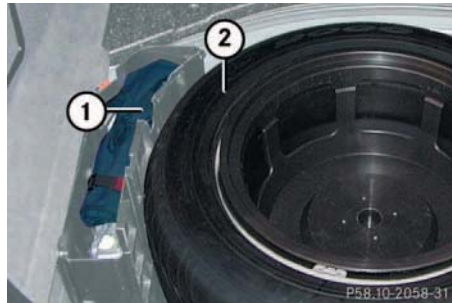

- 1** Toolkit
 - Wheel bolt wrench
 - Jack
- 2** Spare wheel

Removing the spare wheel

- ▶ Turn luggage bowl counterclockwise.
- ▶ Remove spare wheel **2**.

Storing the spare wheel

- ▶ Place spare wheel **2** in wheel well.
- ▶ Turn luggage bowl clockwise to its stop to secure the spare wheel.



Always lower trunk floor before closing trunk lid.

Minispare wheel

Warning!



The dimensions of the Minispare* wheel are different from those of the road wheels. As a result, the vehicle handling characteristics change when driving with a Minispare* wheel mounted.

The spare wheel should only be used temporarily, and replaced with a regular road wheel as quick as possible.

In the case of a flat tire, you may temporarily use the Minispare* wheel when observing the following restrictions:

- Do not exceed a vehicle speed of 50 mph (80km/h).
- Drive to the nearest tire repair facility to have the flat tire repaired or replaced as appropriate.
- Do not operate vehicle with more than one spare wheel mounted.

More information can be found in the "Technical data" section (▷ page 362).

Luggage box

Remove luggage box

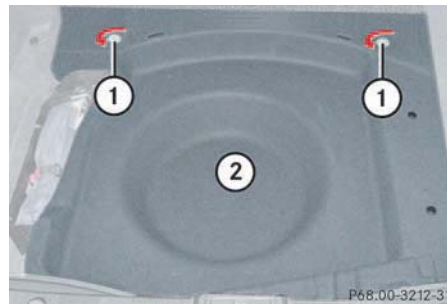

- 1 Fastening clip
- 2 Luggage box

- ▶ Turn fastening clips **1** to the left upwards from fastening bolts.
- ▶ Lift luggage box in the area of the fastening bolts and remove it from trunk.

Practical hints

Where will I find ...?

Install luggage box



- ▶ Insert luggage box into trunk so that fastening clips are in line with fastening bolts.
- ▶ Push front edge of luggage box in direction of arrow under cover of trunk sill.
- ▶ Press fastening clips onto fastening bolts until they lock into place.

Practical hints

Where will I find ...?

Vehicle tool kit

The vehicle tool kit is located in the storage tray on top of the spare wheel (▷ page 324).

The following is included:

- Vehicle tool kit
- Towing eye bolt
- Wheel wrench
- Alignment bolt
- Vehicle jack
- Special fuse extractor
- Spare fuses

Unlocking/locking in an emergency

Unlocking/locking in an emergency

Unlocking the vehicle

In case of a malfunction in the central locking system, you can unlock the trunk separately (▷ page 88).

Unlocking the driver's door

If you are unable to unlock the driver's door using the SmartKey, open the door using the mechanical key.

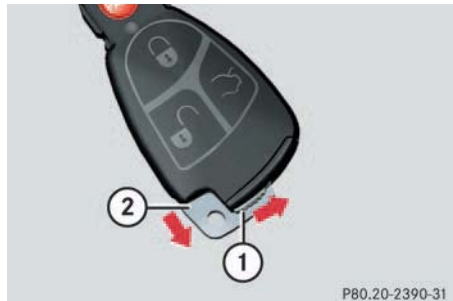

1 Mechanical key locking tab
2 Mechanical key

- ▶ Move locking tab **1** in the direction of the arrow and slide mechanical key **2** out of the housing.

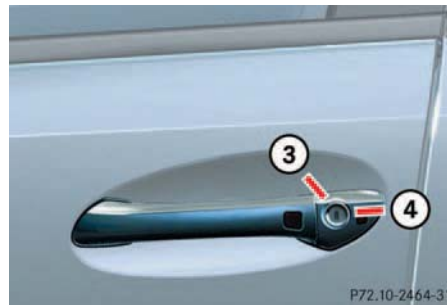

3 Unlocking
4 Locking

- ▶ Unlock the door with the mechanical key. To do so, push the mechanical key in the lock until it stops and turn it to the left **4**.

i

Unlocking your vehicle with the mechanical key will trigger the anti-theft alarm system. To cancel the alarm, do one of the following:

- Press button or on the SmartKey.
- Insert the key in the starter switch.

Practical hints

Unlocking/locking in an emergency

Unlocking the trunk

The trunk can no longer be locked with the key.

Lock and unlock the trunk with the mechanical key as follows:



Trunk lid lock

- 1 Unlocking
- 2 Locking

- ▶ Insert the mechanical key in the trunk lid lock.
- ▶ Turn the key to the left in position 1 and hold it in this position.
- ▶ Pull on the trunk lid handle and lift the trunk lid.

Locking the vehicle

If you are unable to lock the vehicle with the SmartKey, lock it with the mechanical key as follows:

- ▶ Close the passenger doors and the trunk.
- ▶ Press the central locking switch in the cockpit (▷ page 100).
- ▶ Check to see whether the locking knobs on the passenger doors are still visible. If necessary, push them down manually.
- ▶ Lock the driver's door with the mechanical key (▷ page 327).
- ▶ Check if the trunk is locked. If necessary lock the trunk with the mechanical key (▷ page 98).

Changing batteries

If the batteries in the SmartKey are discharged, the vehicle can no longer be locked or unlocked. It is recommended to have the batteries replaced at an authorized Mercedes-Benz Center.

Warning!



Keep the batteries out of reach of children.
If a battery is swallowed, seek medical help immediately.

Batteries contain materials that can harm the environment if disposed of improperly. Recycling of batteries is the preferred method of disposal. Many states require sellers of batteries to accept old batteries for recycling.



When changing batteries, always replace both batteries.

The required replacement batteries are available at any authorized Mercedes-Benz Center.

SmartKey/SmartKey with KEY-LESS-GO*



- 1 Mechanical key
- 2 Battery compartment

Replacement batteries: Lithium, type CR 2025 or equivalent.

- ▶ Remove mechanical key 1 (▷ page 327).
- ▶ Insert the mechanical key in the side opening and push the gray slide. Battery compartment 2 is unlatched.
- ▶ Pull battery compartment 2 out of the key housing in direction of arrow.

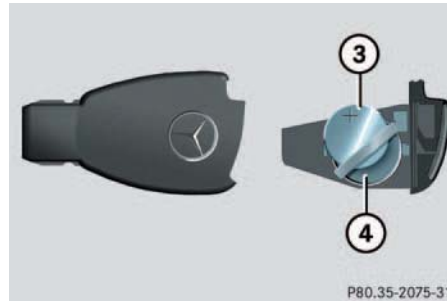

- 3 Battery
- 4 Contact spring

Practical hints

Unlocking/locking in an emergency

- ▶ Remove the batteries.
- ▶ Using a lint-free cloth, insert new batteries under the contact spring with the plus (+) side facing up.
- ▶ Return battery compartment into housing until it locks into place.

Fuel filler flap emergency release

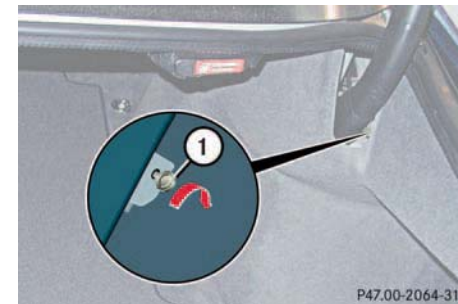

- 1 Release knob

- ▶ Remove right-side tail trim.
- ▶ Turn release knob 1 clockwise (arrow). The fuel filler flap can now be opened.

Practical hints

Unlocking/locking in an emergency

Manually unlocking the transmission selector lever

In the case of power failure, the transmission selector lever can be manually unlocked, e.g. to tow the vehicle.



1 Pin

The selector lever can be manually unlocked from position P in the event of an electrical failure, e.g. to tow the vehicle.

- ▶ Open the storage compartment in the center console (▷ page 229).
- ▶ Take out the cup holder*.

Using two fingers in the horizontal slot at the upper rear side of the cup holder, lift cup holder upwards to remove.

- ▶ Hold the cover at a 45° angle.
- ▶ Insert a suitable object 1 (e.g. a pin) through the hole and press the pin downward.
- ▶ Remove pin 1.



The selector lever is locked again when moving it to position **P**.

Opening/closing in an emergency

Opening/closing in an emergency

Sliding/pop-up roof* or panorama sliding/pop-up roof*

You can open or close the sliding/pop-up roof manually should an electrical malfunction occur.

The sliding/pop-up roof drive is located behind lens 1 of the interior overhead light.

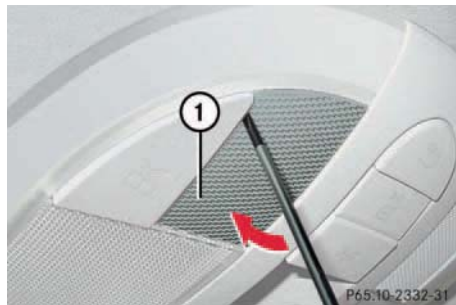

1 Screen

- ▶ Fold screen 1 down.

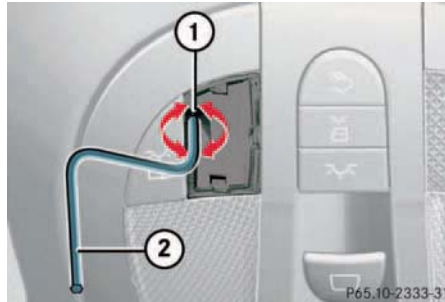

Do not disconnect the electrical connectors.

- ▶ Obtain crank 2.
- ▶ Insert crank 2 through hole 1.
- ▶ Turn crank 2 clockwise to:
 - Slide roof closed
 - Raise roof at the rear
- ▶ Turn crank 2 counterclockwise to:
 - slide roof open
 - lower roof at the rear

The sliding/pop-up roof must be resynchronized after being operated manually (▷ page 189).

Practical hints

Replacing bulbs

Replacing bulbs

Safe vehicle operation depends on proper exterior lighting and signaling. It is therefore essential that all bulbs and lamp assemblies are in good working order at all times.

Correct headlamp adjustment is extremely important. Have headlamps checked and readjusted at regular intervals and when a bulb has been replaced. See your authorized Mercedes-Benz Center for headlamp adjustment.



Backup bulbs will be brought into use when the following lamps malfunction:

- Standing lamps
- Tail lamps

Bulbs

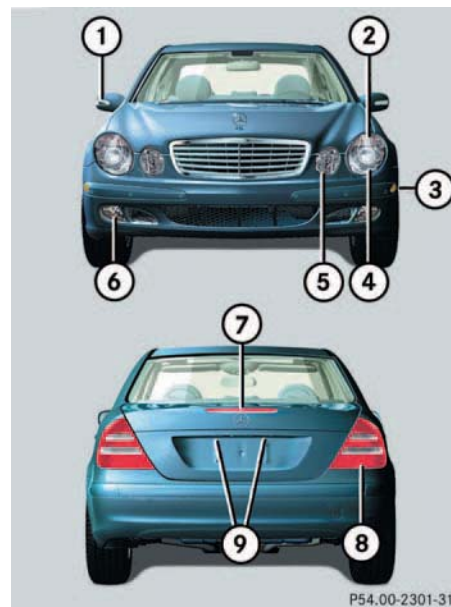

P54.00-2301-31

Front lamps

Lamp	Type
1 Additional turn signal lamps	LED
2 Turn signal lamp	1156 NA
3 Side marker lamp	W 5 W
4 Low beam	H7 (55 W) Bi-Xenon* ¹ D2S-35 W
5 High beam	H7 (55 W)
Parking and standing lamps	W 5 W
6 Fog lamp	HB4/9006 (55 W)

¹ Vehicles with Bi-Xenon headlamps*: Low beam and high beam use the same D2S-35W lamp. For safety reasons (high voltage), do not replace the Bi-Xenon bulb yourself. See your authorized Mercedes-Benz Center.

Rear lamps

Lamp	Type
7 High mounted brake lamp	LED
8 Tail, parking and standing lamp	HiP
9 License plate lamps	C 5 W

Notes on bulb replacement

Warning!



Keep bulbs out of reach of children.

Bulbs and bulb sockets can be very hot. Allow the lamp to cool down before changing a bulb.

Halogen lamps contain pressurized gas. A bulb can explode if you:

- touch or move it when hot
- drop the bulb
- scratch the bulb

Wear eye and hand protection.

Because of high voltage in Bi-Xenon lamps, it is dangerous to replace the bulb or repair the lamp and its components. We recommend that you have such work done by a qualified technician.

Practical hints

Replacing bulbs

- Use only 12-volt bulbs of the same type and with the specified watt rating.
- Switch lights off before changing a bulb to prevent short circuits.
- Always use a clean lint-free cloth when handling bulbs.
- Your hands should be dry and free of oil and grease.
- If the newly installed bulb does not light up, visit an authorized Mercedes-Benz Center.
- Have the LEDs and bulbs for the following lamps replaced by an authorized Mercedes-Benz Center:
 - Additional turn signal lamps in the exterior rear view mirrors
 - High mounted brake lamp
 - Bi-Xenon lamps
 - Front fog lamps

Practical hints

Replacing bulbs

Replacing bulbs for front lamps

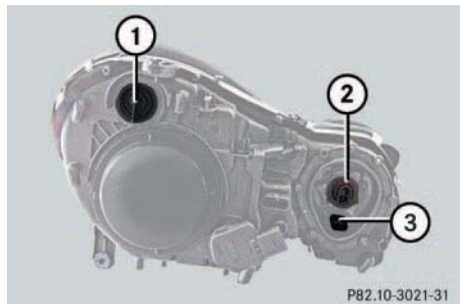

- 1 Bulb socket for turn signal lamp
- 2 High beam bulb
- 3 Bulb socket for parking and standing lamp

High beam bulb (Halogen headlamps only)

- ▶ Switch off the lights.
- ▶ Open the hood (▷ page 261).
- ▶ Press the clamp and remove headlamp cover.
- ▶ Pull electrical connector off.

- ▶ Turn the locking mechanism counter-clockwise and take out the high beam bulb **2**.
- ▶ Insert the new high beam bulb so that the base is in the recess of the holder.
- ▶ Turn the locking mechanism clockwise.
- ▶ Plug the connector onto the high beam bulb.
- ▶ Align headlamp cover and click into place.

High beam bulb (Bi-Xenon* headlamps only)

Warning!



Because of high voltage in Bi-Xenon lamps, it is dangerous to replace the bulb or repair the lamp and its components. We recommend that you have such work done by a qualified technician.

- ▶ Switch off the lights.
- ▶ Open the hood (▷ page 261).
- ▶ Press the clamp and remove headlamp cover.
- ▶ Pull electrical connector off.
- ▶ Turn the locking mechanism counter-clockwise and take out the high beam bulb **2**.
- ▶ Insert the new high beam bulb so that the base is in the recess of the holder.
- ▶ Turn the locking mechanism clockwise.
- ▶ Plug the connector onto the high beam bulb.
- ▶ Align headlamp cover and click into place.

Practical hints

Replacing bulbs

Front turn signal lamp bulb

- ▶ Switch off the lights.
- ▶ Open the hood (▷ page 261).
- ▶ Twist bulb socket **1** counterclockwise and pull out.
- ▶ Push bulb into socket, turn counterclockwise and remove.
- ▶ Insert new bulb in socket, push in and twist clockwise.
- ▶ Reinsert bulb socket in lamp and twist clockwise.

Parking and standing lamp bulb

- ▶ Switch off the lights.
- ▶ Open the hood (▷ page 261).
- ▶ Press the clamp and remove headlamp cover.
- ▶ Pull out the bulb socket **3** with the bulb.
- ▶ Pull the bulb out of the bulb socket.
- ▶ Insert a new bulb in the socket.
- ▶ Reinstall the bulb socket.
- ▶ Align headlamp cover and click into place.

Side marker lamp bulb



- ▶ Switch off the lights.
- ▶ Carefully slide lamp towards front.
- ▶ Remove rear end first.
- ▶ Twist bulb socket counterclockwise and pull out.
- ▶ Pull bulb out of the bulb socket.
- ▶ Insert new bulb in socket.
- ▶ Reinstall bulb socket, push in and twist clockwise.
- ▶ To reinstall lamp, set rear end in bumper and let front end snap into place.

Practical hints

Replacing bulbs



To prevent scratches, we recommend that you have the sidemarker bulb replaced by an authorized Mercedes-Benz Center.

Replacing bulbs for rear lamps

Tail lamp assemblies

The tail lamps are equipped with HiP bulbs.

Warning!



The bulbs in the tail lamps cannot be replaced individually. The tail lamp bulbs are under pressure and could explode during an attempt to replace them.

If the tail lamps are malfunctioning, have them exchanged at an authorized Mercedes-Benz Center.

License plate lamp

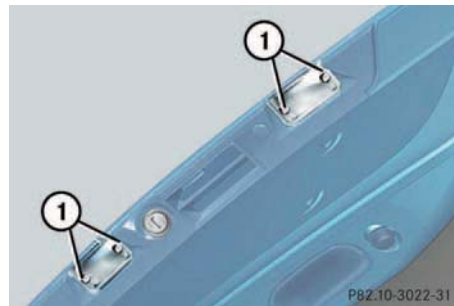

1 Screw

- ▶ Switch off the lights.
- ▶ Loosen both screws **1** and remove lamp.
- ▶ Replace the tubular lamp and reinstall lamp.
- ▶ Retighten the screws.

Replacing wiper blades

Replacing wiper blades



To avoid damage to the hood, the wiper arms should only be folded forward when in the vertical position.

Removal

- ▶ Turn key in starter switch to position **1**.
- ▶ Turn combination switch to wiper setting **II** (▷ page 47).
- ▶ With wiper arm in the vertical position (see above), turn key in starter switch to position **0**.

Warning!



For safety reasons, remove key from starter switch before replacing a wiper blade, otherwise the motor could suddenly turn on and cause injury.

- ▶ Fold the wiper arm forward.

You should hear it snap into place.

- ▶ Turn the wiper blade at a right angle to wiper arm.

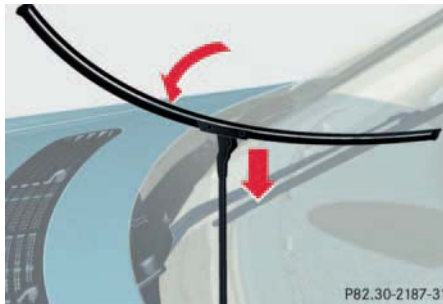

- ▶ Slide the wiper blade sideways out of the retainer.

Practical hints

Replacing wiper blades

Installation

- ▶ Slide wiper blade onto wiper arm until it locks in place.
- ▶ Rotate wiper blade into position parallel to wiper arm.
- ▶ Fold wiper arm back so that blade rests on windshield.



Never open the hood when the wiper arm is folded forward.

Do not allow the wiper arms to contact the windshield glass without a wiper blade inserted.

For your convenience, we recommend that you have this work carried out by an authorized Mercedes-Benz Center.

Practical hints

Flat tire

Flat tire

Preparing the vehicle

- ▶ Park the vehicle as far as possible from moving traffic on a hard surface.
- ▶ Turn on the hazard warning flashers.
- ▶ Engage the steering wheel lock in the straight-ahead position and set the parking brake.
- ▶ Move the selector lever to **P**.
- ▶ Have any passenger exit the vehicle at a safe distance from the roadway.

Mounting the spare wheel

Preparing the vehicle

Prepare the vehicle as described under "Preparing the vehicle" on this page.

- ▶ Take the spare wheel out of the trunk (▷ page 324).

Lifting the vehicle

- ▶ Prevent the vehicle from rolling away by blocking wheels with wheel chocks (not included) or other sizable objects.

When changing wheel on a level surface:

- ▶ Place one chock in front of and one behind the wheel that is diagonally opposite to the wheel being changed.

When changing wheel on a hill:

- ▶ Place chocks on the downhill side blocking both wheels of the other axle.
- ▶ Take the two-piece wheel wrench and the jack out of the trunk (▷ page 326). Assemble wheel wrench.

Warning!



The jack is designed exclusively for jacking up the vehicle at the jack take-up brackets built into either side of the vehicle. To help avoid personal injury, use the jack only to lift the vehicle during a wheel change. Never get beneath the vehicle while it is supported by the jack. Keep hands and feet away from the area under the lifted vehicle. Always firmly set parking brake and block wheels before raising vehicle with jack.

Do not disengage parking brake while the vehicle is raised. Be certain that the jack is

always vertical (plumb line) when in use, especially on hills. Always try to use the jack on level surface. Be sure that the jack arm is fully seated in the jack take-up bracket. Always lower the vehicle onto sufficient capacity jackstands before working under the vehicle.



- ▶ On wheel to be changed, loosen but do not yet remove the wheel bolts (approximately one full turn with wrench).

The jack take-up brackets are located directly behind the front wheel housing and in front of the rear wheel housing.

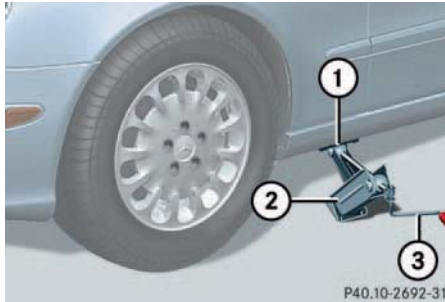

- 1** Jack take-up bracket
- 2** Jack
- 3** Crank

- ▶ Position jack **2** on firm ground under the respective jack take-up bracket **1**.

Practical hints

Flat tire

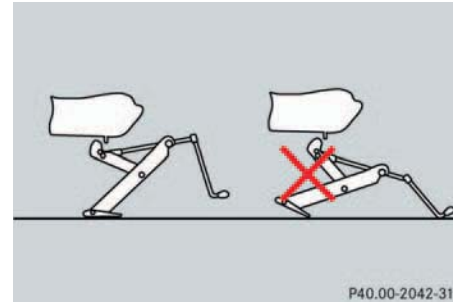

Make sure that the foot of the jack is directly under the take-up bracket so that it is always vertical (plumb-line) as seen from the side, even if the vehicle is parked on an incline

- ▶ Turn crank **3** until the tire is a maximum of 1.2 in (3 cm) off the ground. Never start engine while vehicle is raised.

Practical hints

Flat tire

Warning!



Position the jack only on the jack take-up brackets designed for this purpose. If the jack is not properly positioned, the vehicle may slip off of the jack.

Warning!



The jack is intended only for lifting the vehicle briefly for wheel changes. It is not suited for performing maintenance work under the vehicle. Never lie down under the raised vehicle. Do not start the engine when the vehicle is raised.

Removing the wheel

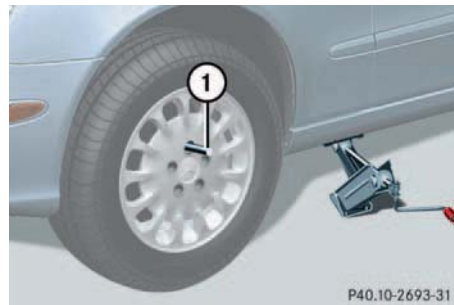

1 Alignment bolt

- ▶ Unscrew the upper-most wheel bolt and remove.
- ▶ Replace this wheel bolt with alignment bolt **1** supplied in the tool kit.
- ▶ Remove the remaining bolts.



Do not place wheel bolts in sand or dirt. This could result in damage to the bolt and wheel hub threads.

- ▶ Remove the wheel.

Mounting the Minispare wheel

- ▶ Clean contact surfaces of wheel and wheel hub.
- ▶ Guide the spare wheel onto the alignment bolt and push it on.
- ▶ Insert wheel bolts and tighten them slightly.



To avoid paint damage, place wheel flat against hub and hold it there while installing first wheel bolt.

Practical hints

Flat tire

Warning!



Always replace wheel bolts that are damaged or rusted.

Never apply oil or grease to wheel bolts.

Damaged wheel hub threads should be repaired immediately. Do not continue to drive under these circumstances! Contact an authorized Mercedes-Benz Center or call Roadside Assistance.

Incorrect mounting bolts or improperly tightened mounting bolts can cause the wheel to come off. This could cause an accident. Be sure to use the correct mounting bolts.

Warning!



Use only genuine equipment Mercedes-Benz wheel bolts. They are identified by the Mercedes star. Other wheel bolts may come loose.

Do not tighten the wheel bolts when the vehicle is raised. Otherwise the vehicle could tip over.



- ▶ Unscrew the alignment bolt, install last wheel bolt and tighten slightly.

Warning!



The dimensions of the Minispare* wheel are different from those of the road wheels. As a result, the vehicle handling characteristics change when driving with a Minispare* wheel mounted.

The spare wheel should only be used temporarily, and replaced with a regular road wheel as quick as possible.

In the case of a flat tire, you may temporarily use the Minispare* wheel when observing the following restrictions:

- Do not exceed a vehicle speed of 50 mph (80km/h).
- Drive to the nearest tire repair facility to have the flat tire repaired or replaced as appropriate.
- Do not operate vehicle with more than one spare wheel mounted.

Practical hints

Flat tire

Lowering the vehicle

- ▶ Lower vehicle by turning crank counterclockwise until vehicle is resting fully on its own weight.
- ▶ Remove the jack.

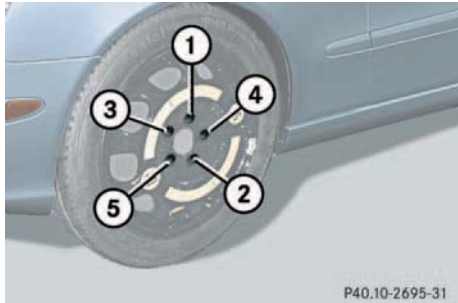

1 - 5 Wheel bolts

- ▶ Tighten the five wheel bolts evenly, following the diagonal sequence illustrated (1 to 5), until all bolts are tight. Observe a tightening torque of 96 ft lb (130 Nm).

Warning!



Have the tightening torque checked after changing a wheel. The wheels could come loose if they are not tightened to a torque of 96 ft lb (130 Nm).

- ▶ Before storing the jack in the trunk, it should be fully collapsed.



Wrap the faulty wheel in the protective film that comes with the spare wheel and put the wheel in the trunk.

You can also place the faulty wheel down into the spare wheel well. In this case, you must stow the holder from the spare wheel well in the trunk.

Do not activate the tire inflation pressure monitor until the depressurized tire is no longer in the vehicle.

Batteries

Your vehicle is equipped with two batteries:

- Auxiliary battery (back-up battery; enables vehicle to shut down electrical systems in a controlled manner should the main battery fail; auxiliary battery is located in the engine compartment)
- The main battery (battery for starter and electrical consumers; located in the trunk).

The main battery is in the trunk under the luggage box. Remove the luggage box (▷ page 325).



Main battery in trunk

- 1 Negative terminal
- 2 Positive terminal

Warning!



Jump starting must only be done using the main battery in the trunk.

Practical hints

Batteries

Warning!



Failure to follow these instructions can result in severe injury or death.

Never lean over batteries while connecting, you might get injured.

Battery fluid contains sulfuric acid. Do not allow this fluid to come in contact with eyes, skin or clothing. In case it does, immediately flush affected area with water and seek medical help if necessary.

A battery will also produce hydrogen gas, which is flammable and explosive. Keep flames or sparks away from battery, avoid improper connection of jumper cables, smoking etc.

Practical hints

Batteries



Never loosen or detach battery terminal clamps while the engine is running or the key is in the starter switch. Otherwise the alternator and other electronic components could be severely damaged.

Have the battery checked regularly by an authorized Mercedes-Benz Center. Contact your authorized Mercedes-Benz Center for further information.

Warning!



Do not place metal objects on the battery as this could result in a short circuit.

Use leak-proof battery only to avoid the risk of acid burns in the event of an accident.

Warning!



With a disconnected battery

- the brake boosting effect is not available. You need more power to brake and brake pedal travel is increased. If necessary, you must depress the brake pedal with full power.
- you can no longer turn the ignition key or, in cars with KEYLESS-GO*, pressing the KEY-LESS-GO button* on the gear selector lever has no effect.
- the gear selector lever is locked in position P.

Disconnecting the battery

- ▶ Depress the parking brake firmly or move the gear selector lever to position **P**.
- ▶ Open the trunk (▷ page 261).
- ▶ Disconnect battery negative lead **1**.

- ▶ Remove cover **2** from the positive terminal.
- ▶ Disconnect the battery positive lead.

Removing the battery

- ▶ Remove the screw-nuts securing the battery.
- ▶ Remove the battery bracket.
- ▶ Take out the battery.

Charging and reinstalling the battery

- ▶ Charge battery in accordance with the instructions of the battery charger manufacturer.
- ▶ Reinstall the charged battery. Follow the previously described steps in reverse order.

Warning!



Never charge a battery while still installed in the vehicle. Gases may escape during charging and cause explosions that may result in paint damage, corrosion or personal injury.

Reconnecting the batteries

- ▶ Turn off all electrical consumers.
- ▶ Connect the positive lead and fasten its cover.
- ▶ Connect the negative lead.



NEVER invert the terminal connections! The battery, its filler caps and the vent tube must always be securely installed when the vehicle is in operation.



The following procedures must be carried out following any interruption of battery power (e.g. due to reconnection):

- Set the clock (▷ page 136) (vehicles with COMAND*: see COMAND operator's manual).
- Resynchronize the front seat head restraints (▷ page 104).
- Resynchronize the ESP (▷ page 75).
- Re-enter the radio code (see radio operating instructions).
- Resynchronize the side windows (▷ page 186).
- Resynchronize the sliding/pop-up roof* (▷ page 189).

Batteries contain materials that can harm the environment if disposed of improperly. Large 12-volt storage batteries contain lead. Recycling of batteries is the preferred method of disposal. Many states require sellers of batteries to accept old batteries for recycling.

Practical hints

Jump starting

Jump starting

Warning!



Failure to follow these directions will cause damage to the electronic components, and can lead to a battery explosion and severe injury or death.

Never lean over batteries while connecting or jump starting, you might get injured.

Battery fluid contains sulfuric acid. Do not allow this fluid to come in contact with eyes, skin or clothing. In case it does, immediately flush affected area with water, and seek medical help if necessary.

A battery will also produce hydrogen gas, which is flammable and very explosive. Keep flames or sparks away from battery, avoid improper connection of jumper cables, smoking etc.

Read all instructions before proceeding.

If the battery is discharged, the engine can be started with jumper cables and the battery of another vehicle. Observe the following:

- Jump starting should only be performed when the engine and catalytic converter are cold.
- Do not start the engine if the battery is frozen. Let the battery thaw out first.
- Only jump start from batteries with the same voltage rating.
- Use only jumper cables with sufficient cross-section, insulated terminal clamps and polarity reversal protection.



Jumper cables with polarity reversal protection are available at any authorized Mercedes-Benz Center.



Jump starting may only be performed on the main battery installed in the trunk.

Avoid repeated and lengthy starting attempts.

Do not attempt to start the engine using a battery quick charge unit.

If the engine does not run after several unsuccessful starting attempts, have it checked at the nearest authorized Mercedes-Benz Center.

Excessive unburned fuel generated by repeated failed starting attempts may damage the catalytic converter.

Make sure the jumper cables do not have loose or missing insulation.

Make sure the cable clamps do not touch any other metal part while the other end is still attached to a battery.

Warning!



Keep flames or sparks away from battery. Do not smoke.

Observe all safety instructions and precautions when handling automotive batteries (▷ page 266).

The battery is located in the trunk on the right hand side underneath the luggage box (▷ page 325). Only jump start the vehicle from the battery in the trunk.

- ▶ Make sure that the two vehicles do not touch.
- ▶ Turn off all electrical consumers.
- ▶ Apply parking brake.
- ▶ Shift selector lever to position **P**.

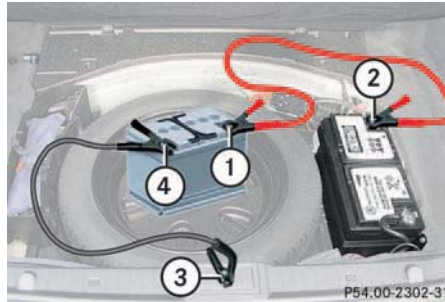

- 1 Positive terminal of charged battery
 - 2 Positive terminal of discharged battery
 - 3 Vehicle ground
 - 4 Negative terminal of charged battery
- ▶ Connect positive terminals **1** and **2** of the batteries with the jumper cables. Clamp cable to charged battery **1** first.
 - ▶ Start engine of the vehicle with the charged battery and run at idle speed.
 - ▶ Connect negative terminal **4** of the charged battery and vehicle ground **3** (lock ring of the trunk lid lock) in the trunk with the jumper cable. Clamp cable to charged battery **4** first.

Practical hints

Jump starting

- ▶ Start the engine of the disabled vehicle.



The message **Malfunction - electric consumers switched off** may appear in the instrument cluster. It will disappear as soon as the battery is sufficiently charged.

Now you can again turn on the electrical consumers. Do not turn on the lights under any circumstances.

- ▶ Remove the jumper cables first from vehicle ground **3** and negative terminal **4** and then from positive terminals **1** and **2**.
- ▶ Have the battery checked at the next authorized Mercedes-Benz Center.



Vehicles with automatic transmission: Do not tow-start the vehicle.

Practical hints

Towing the vehicle

Towing the vehicle

Towing the vehicle

Mercedes-Benz recommends that the vehicle be transported with all wheels off the ground using flatbed or appropriate wheel lift/dolly equipment.



Use flatbed or wheel lift/dolly equipment with key in starter switch turned to position **0**.

Do not tow with sling-type equipment. Towing with sling-type equipment over bumpy roads will damage radiator and supports.

To prevent damage during transport, do not tie down vehicle by its chassis or suspension parts.

Switch off the tow-away alarm and the automatic central locking

When circumstances do not permit the recommended towing methods, the vehicle may be towed with all wheels on the ground or front wheels raised only so far as

to have the vehicle moved to a safe location where the recommended towing methods can be employed.



If the vehicle is towed with the front axle raised, the engine must be shut off (key in starter switch position **0** or **1**). Otherwise, the ESP will immediately be engaged and will apply the rear wheel brakes.

When towing the vehicle with all wheels on the ground, the selector lever must be in position **N** and the key must be in starter switch position **2**. When towing the vehicle with all wheels on the ground, the vehicle may be towed only for distances up to 30 miles (50 km) and at a speed not to exceed 30 mph (50 km/h).



To be certain to avoid a possibility of damage to the transmission, however, we recommend the drive shaft be disconnected at the rear axle drive flange for any towing beyond a short tow to a nearby garage.

Warning!



If circumstances require towing the vehicle with all wheels on the ground, always tow with a tow bar if:

- the engine will not run
- there is a malfunction in the SBC brake system
- there is a malfunction in the power supply or in the vehicle's electrical system

as that will be necessary to adequately control the towed vehicle.

Prior to towing the vehicle with all wheels on the ground, make certain that the key is in starter switch position **2**.

If the key is left in the starter switch position **0** for an extended period of time, it can no longer be turned in the switch. In this case, the steering is locked. To unlock, remove key from starter switch and reinsert.



To signal turns while being towed with the hazard warning flasher in use, turn key in starter switch to position **2** and activate the combination switch for the left or right turn signal in the usual manner – only the selected turn signal will operate.

Upon canceling the turn signal, the hazard warning flasher will operate again.

Practical hints

Towing the vehicle

Warning!



The brake system requires electrical power to operate.

A malfunction in the vehicle's power supply or electrical system may impair brake system operation and switch it into its limp-home (emergency operation) mode. To brake, the driver must then apply significantly greater brake pedal pressure and depress the pedal much further to obtain the expected braking effect. If necessary, apply full pressure to the brake pedal. Brakes are only applied to the front wheels. Stopping distance is increased! Adapt your driving style accordingly. SBC brake system (▷ page 77).

With the engine not running, there is no power assistance for the steering system. In this case, it is important to keep in mind that a considerably higher degree of effort is necessary to steer the vehicle. Adapt your driving accordingly.

Practical hints

Towing the vehicle



When towing the vehicle with all wheels on the ground, please note the following:

With the automatic central locking activated and the key in starter switch position **2**, or KEYLESS-GO* start/stop button (if so equipped) in position **2**, the vehicle doors lock if the left front wheel as well as the right rear wheel are turning at vehicle speeds of approx. 9 mph (15 km/h) or more.

To prevent the vehicle door locks from locking, deactivate the automatic central locking (▷ page 99).

Towing of the vehicle should only be done using the properly installed towing eye bolt. Never attach tow cable, tow rope or tow rod to the vehicle chassis, frame or suspension parts.



The selector lever will remain locked in position **P** and the key will not turn in the starter switch if the battery is disconnected or discharged. See notes on the battery (▷ page 343) or on jump starting (▷ page 346).

Installing towing eye bolt

Front of vehicle

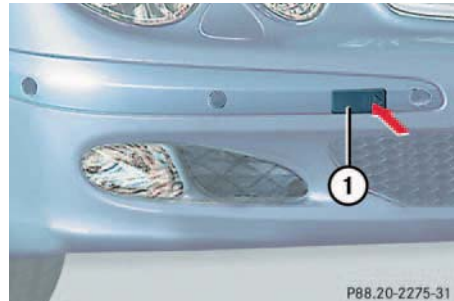

1 Cover on right side of front bumper

To remove cover:

- ▶ Press mark on cover in direction of arrow.
- ▶ Lift cover off to reveal threaded hole for towing eye bolt.

The towing eye bolt is supplied with the tool kit (located in the storage compartment under the trunk floor).

- ▶ Screw towing eye bolt in to its stop and tighten with lug wrench.

To reinstall cover:

- ▶ Fit cover and snap into place.

Practical hints

Towing the vehicle

Rear of vehicle

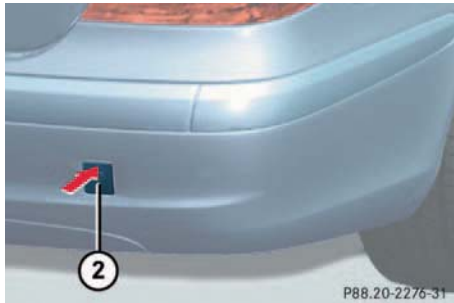

2 Cover on right side of rear bumper

To remove cover:

- ▶ Pull cover in the direction of the arrow.
- ▶ Fold cover down to reveal threaded hole for the towing eye bolt.

The towing eye bolt is supplied with the tool kit (located in the storage compartment under the trunk floor).

- ▶ Screw towing eye bolt in to its stop and tighten with lug wrench.

To reinstall cover:

- ▶ Fit cover and snap into place.

Practical hints

Fuses

Fuses



Only install fuses that have been tested and approved by Mercedes-Benz and that have the specified amperage rating.

Never attempt to repair or bridge a blown fuse. Have the cause determined and remedied by an authorized Mercedes-Benz Center.

Fuse box in passenger compartment

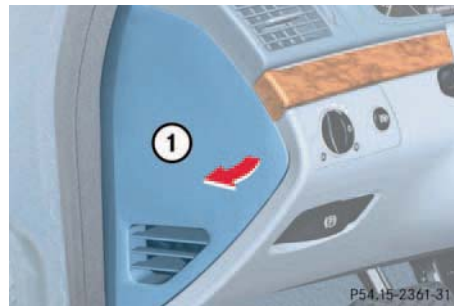

1 Cover

Opening

- ▶ Pull cover 1 open with a screwdriver or similar tool.
- ▶ Remove cover 1 rearward.

Closing

- ▶ Attach cover 1 in the front.
- ▶ Fold cover 1 in until it engages.

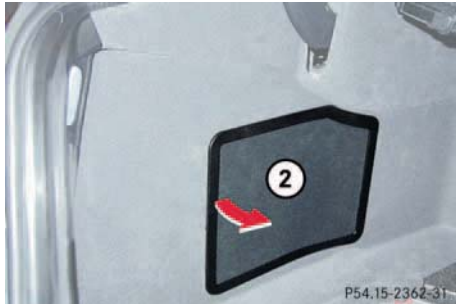

2 An additional fuse box is located on the left-hand side of trunk.

Fuse chart

The fuse chart is found in the fuse box in the passenger compartment. The amperages of the fuses are also given there.

Spare fuses

Spare fuses are found in the vehicle tool kit in the trunk.

Fuse extractor

The fuse extractor is found in the vehicle tool kit in the trunk.

i

Only install fuses that have been tested and approved by Mercedes-Benz and that have the specified amperage rating.

Never attempt to repair or bridge a blown fuse. Have the cause determined and remedied by an authorized Mercedes-Benz Center.



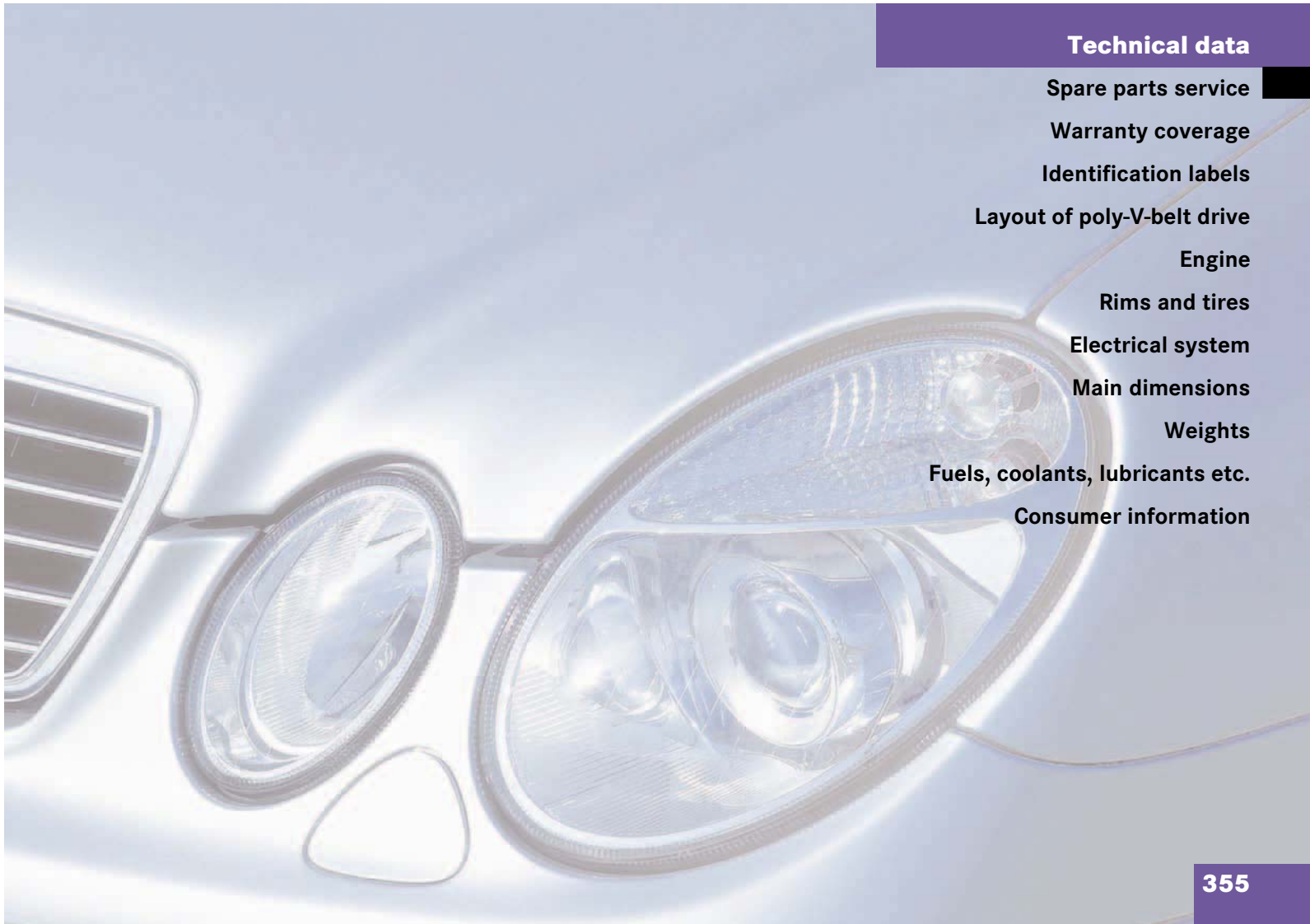

Technical data

Spare parts service

Warranty coverage

Identification labels

Layout of poly-V-belt drive

Engine

Rims and tires

Electrical system

Main dimensions

Weights

Fuels, coolants, lubricants etc.

Consumer information

Technical data

Spare parts service

The "Technical data" section provides the necessary technical data for your vehicle.

Spare parts service

All authorized Mercedes-Benz Centers maintain a stock of original spare parts required for maintenance and repair work. In addition, strategically located parts distribution centers provide quick and reliable parts service.

More than 300 000 different spare parts for Mercedes-Benz models are available.

Mercedes-Benz original spare parts are subjected to stringent quality inspections. Each part has been specifically developed, manufactured or selected for and adapted to Mercedes-Benz vehicles.

Therefore, Mercedes-Benz original spare parts should be installed.



The use of non-genuine parts and accessories not authorized by Mercedes-Benz could damage the vehicle, which is not covered by the Mercedes-Benz Limited Warranty, or could compromise the vehicle's durability or safety.

Warranty coverage

Your vehicle is covered under the terms of the warranties printed in the Service and Warranty Information Booklet. Your authorized Mercedes-Benz Center will exchange or repair any defective parts originally installed on the vehicle in accordance with the terms of the following warranties:

- New Car Limited Warranty
- Emission System Warranty
- Emission Performance Warranty
- California, Maine, Massachusetts, and Vermont Emission Control System Warranty

Replacement parts and accessories are covered by the Mercedes-Benz Spare Parts and Accessories Warranties, copies of which are available at any authorized Mercedes-Benz Center.

Loss of Service and Warranty Information Booklet

Should you lose your Service and Warranty Information Booklet, have your authorized Mercedes-Benz Center arrange for a replacement. It will be mailed to you.

Technical data

Identification labels

Identification labels

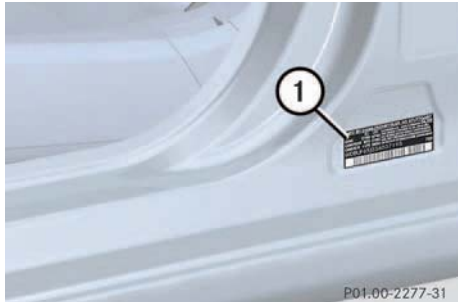

1 Certification label



2 Vehicle Identification Number (VIN)

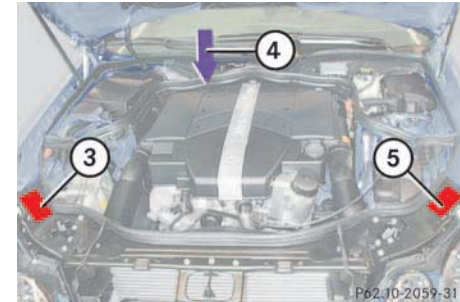

- 3 Information label, California version Vacuum line routing for emission control system
- 4 Engine number (engraved on engine)
- 5 Emission control label

When ordering spare parts, please specify vehicle identification and engine numbers.

Layout of poly-V-belt drive

E 320 / E 500

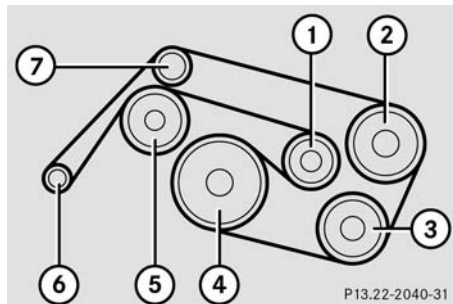

- 1 Automatic belt tensioner
- 2 Power steering pump
- 3 Air conditioner compressor
- 4 Crankshaft
- 5 Coolant pump
- 6 Generator (alternator)
- 7 Idler pulley

Technical data

Engine

Engine

Model	E 320 (211.065 ¹)	E 500 (211.070 ¹)
Engine	112	113
Mode of operation	4-stroke engine, gasoline injection	4-stroke engine, gasoline injection
No. of cylinders	6	8
Bore	3.54 in (89.90 mm)	3.82 in (97.00 mm)
Stroke	3.31 in (84.00 mm)	3.31 in (84.00 mm)
Total piston displacement	195.2 cu.in. (3199 cm ³)	302.9 cu.in. (4966 cm ³)
Compression ratio	10:1	10:1
Output acc. to SAE J 1349	221 hp / 5700 rpm (165 kW / 5700 rpm)	302 hp / 5600 rpm (225 kW / 5600 rpm)
Maximum torque acc. to SAE J 1349	232 ft.lb / 3000 rpm (315 Nm / 3000 rpm)	339 ft.lb / 2700 rpm (460 Nm / 2700 rpm)
Maximum engine speed	6000 rpm	6000 rpm
Firing order	1-4-3-6-2-5	1-5-4-2-6-3-7-8
Poly-V-belt	7 ft 10 in (2390 mm)	7 ft 10 in (2390 mm)

¹ The quoted data apply only to the standard vehicle. See an authorized Mercedes-Benz Center for the corresponding data of all special bodies and special equipment.

Technical data

Rims and tires

Rims and tires

Use only tires and rims which have been specifically developed for your vehicle and tested and approved by Mercedes-Benz. Other tires and rims can have detrimental effects, such as:

- Poor handling characteristics
- Increased noise
- Increased fuel consumption



Moreover, tires and rims not approved by Mercedes-Benz may under load exhibit dimensional variations and different tire deformation characteristics that could cause them to come into contact with the vehicle body or axle parts. Damage to the tires or the vehicle can be the result.



Further information on tires and rims is available at any authorized Mercedes-Benz Center. A tire inflation pressure table is located on the fuel filler cap of the vehicle. The tire pressure should only be adjusted on cold tires. Follow the tire manufacturer's maintenance recommendation included with the vehicle.

Same-sized tires

	E 320	E 500
Rims (light alloy)	8J x 16 ET 39	8½J x 17 ET 38
Wheel offset	1.53 in (39 mm)	1.5 in (38 mm)
Summer tires (radial-ply tires)	225/55 R 16 95 H	245/45 R 17 95 H ¹
Winter tires (radial-ply tires)	225/55 R 16 95 H M+S	245/45 R 17 95 H M+S ¹

¹ Must not be used with snow chains.

Technical data

Rims and tires

Minispare wheel

	E 320 / E 500
Rim	4J x 17 ET 34
Wheel offset	1.34 (34 mm)
Tire	T 155/70 R 17 ¹

¹ Must not be used with snow chains.

Sport package

	E 320* / E 500*
Same-sized tires	
Rims (light alloy)	8J x 17 ET 38
Wheel offset	1.5 in (38 mm)
Summer tires (radial-ply tires)	245/45 R 17 95 H ¹
Winter tires (radial-ply tires)	245/45 R 17 95 M+S ¹

¹ Must not be used with snow chains.

Electrical system

Model	E 320	E 500
Generator (alternator)	14 V/120 A	14 V/120 A
Starter motor	14 V/1.4 KW	14 V/1.7 KW
Battery (auxiliary)	12 V/12 Ah	12 V/12 Ah
Battery (main)	12 V/95 Ah	12 V/95 Ah
Spark plugs	Bosch F8 DPP 332U NGK PFR 5R-11	Bosch F8 DPP 332U NGK PFR 5R-11
Electrode gap	0.039 in (1.00 mm)	0.039 in (1.00 mm)
Tightening torque	18.5 - 22 ft.lb (25 - 30 Nm)	18.5 - 22 ft.lb (25 - 30 Nm)

Technical data

Main dimensions

Main dimensions

Model	E 320	E 500
Overall vehicle length	189.7 in (4818 mm)	189.7 in (4818 mm)
Overall vehicle width	78.3 in (1990 mm)	78.3 in (1990 mm)
Overall vehicle height	57.2 in (1452 mm)	
Overall vehicle height (AIRMATIC DC*) (optional on E320; standard on E500)	56.2 in (1428 mm)	56.3 in (1430 mm)
Wheelbase	112.4 in (2854 mm)	112.4 in (2854 mm)
Track, front	62.1 in (1577 mm)	62.1 in (1577 mm)
Track, rear	61.8 in (1570 mm)	61.8 in (1570 mm)

Weights

Roof load max.	220 lb (100 kg)
Trunk load max.	220 lb (100 kg)

Technical data

Fuels, coolants, lubricants etc.

Fuels, coolants, lubricants etc.

Capacities

Vehicle components and their respective lubricants must match. Therefore use only brands tested and recommended by us.

Please refer to the Factory Approved Service Products Pamphlet, or inquire at your authorized Mercedes-Benz Center.

	Model	Capacity	Fuels, coolants, lubricants etc.
Engine with oil filter	E 320	8.5 US qt (8.0 l)	Recommended engine oils
	E 500	8.0 US qt (7.5 l)	
Automatic transmission		8.0 US qt (7.5 l)	MB Automatic Transmission Oil ¹
Rear axle	E 320	1.06 US qt (1 l)	Hypoid gear oil SAE 85 W 90
	E 500	1.37 US qt (1.3 l)	
Power steering		approx. 1.1 US qt (1.0 l)	MB Power Steering Fluid (Pentosin CHF 11S)
Front wheel hubs		approx. 3.0 oz (85 g) each	High temperature roller bearing grease
Brake system		0.64 US qt (0.6 l)	MB Brake Fluid (DOT 4+)
Cooling system	E 320	approx. 10.7 US qt (10 l)	MB 325.0 Anticorrosion / Antifreeze
	E 500	approx. 11.9 US qt (11.3 l)	
Fuel tank including a reserve of		21.12 US gal (80.0 l)	Premium unleaded gasoline: Posted Octane 91 (Avg. of 96 RON / 86 MON)
		2.38 US gal (9.0 l)	
Air conditioner system			R-134a refrigerant and special PAG lubricant oil (never R-12)

¹ MB part no. 001 989 21 03 10

Technical data

Fuels, coolants, lubricants etc.

	Model	Capacity	Fuels, coolants, lubricants etc.
Windshield washer	E 320, E 500	4.8 US qt (4.5 l)	MB Windshield Washer Concentrate ¹
Windshield washer and headlamp cleaning system	E 320, E 500	7.4 US qt (7.0 l)	MB Windshield Washer Concentrate ¹

¹ Use MB Windshield Washer Concentrate "S" and water for temperatures above freezing or MB Windshield Washer Concentrate "S" and commercially available pre-mixed windshield washer solvent/antifreeze for temperatures below freezing. Follow suggested mixing ratios (▷ page 372).

Technical data

Fuels, coolants, lubricants etc.

Engine oils

Engine oils are specifically tested for their suitability in our engines. Therefore, use only engine oils recommended by Mercedes-Benz. Information on recommended brands is available in the Factory Approved Service Products Pamphlet, or at your authorized Mercedes-Benz Center.

Please follow FSS recommendations for scheduled oil changes. Failure to do so could result in engine damage not covered by the Mercedes-Benz Limited Warranty.

Engine oil additives

Do not blend oil additives with engine oil. They may be harmful to the engine operation.

Damage or malfunctions resulting from blending oil additives are not covered by the Mercedes-Benz Limited Warranty.

Air conditioner refrigerant

R-134a (HFC) refrigerant and special PAG lubricating oil is used in the air conditioner system.

Never use R-12 (CFC) or mineral-based lubricating oil. Otherwise damage to the system will occur.

Brake fluid

During vehicle operation, the boiling point of the brake fluid is continuously reduced through the absorption of moisture from the atmosphere. Under extremely strenuous operating conditions, this moisture content can lead to the formation of bubbles in the system, thus reducing the system's efficiency.

Therefore, the brake fluid must be replaced every two years, preferably in the spring.

Only brake fluid approved by Mercedes-Benz is recommended. Your authorized Mercedes-Benz Center will provide you with additional information.

Premium unleaded gasoline



To maintain the engine's durability and performance, premium unleaded gasoline must be used. If premium unleaded gasoline is not available and low octane fuel is used, follow these precautions:

- Have the fuel tank only partially filled with unleaded regular and fill up with premium unleaded as soon as possible
- Avoid full throttle driving and abrupt acceleration
- Do not exceed an engine speed of 3000 rpm if the vehicle is loaded with a light load such as two persons and no luggage
- Do not exceed 2/3 of maximum accelerator pedal position if the vehicle is fully loaded or operating in mountainous terrain

Fuel requirements

Use only premium unleaded gasoline meeting ASTM standard D 439:

- The octane number (posted at the pump) must be 91 min. It is an average of both the Research (R) Octane Number and the Motor (M) Octane Number: $(R+M) / 2$. This is also known as the ANTI-KNOCK INDEX.

Unleaded gasoline containing oxygenates such as ethanol, IPA, IBA and TBA can be used provided the ratio of any one of these oxygenates to gasoline does not exceed 10%; MTBE is not to exceed 15%.

The ratio of methanol to gasoline must not exceed 3% plus additional cosolvents.

Using mixtures of ethanol and methanol is not allowed. Gasohol, which contains 10% ethanol and 90% unleaded gasoline, can be used.

These blends must also meet all other fuel requirements, such as resistance to spark knock, boiling range, vapor pressure, etc.

Gasoline additives

A major concern among engine manufacturers is carbon build-up caused by gasoline. Mercedes-Benz recommends only the use of quality gasoline containing additives that prevent the build-up of carbon deposits.

After an extended period of using fuels without such additives, carbon deposits can build up especially on the intake valves and in the combustion area, leading to engine performance problems such as:

- Warm-up hesitation
- Unstable idle
- Knocking/pinging
- Misfire
- Power loss

Do not blend any specific fuel additives with fuel. This only results in unnecessary costs and may be harmful to the engine operation.

Technical data

Fuels, coolants, lubricants etc.

Damage or malfunctions resulting from poor fuel quality or from blending specific fuel additives are not covered by the Mercedes-Benz Limited Warranty.

Coolants

The engine coolant is a mixture of water and anticorrosion / antifreeze, which provides:

- Corrosion protection
- Freeze protection
- Boiling protection (by increasing the boiling point)

The cooling system was filled at the factory with a coolant providing freeze protection to approximately -22°F (-30°C) and corrosion protection.

If the antifreeze mixture is effective to -22°F (-30°C), the boiling point of the coolant in the pressurized cooling system is reached at approximately 266°F (130°C).

The coolant solution must be used year-round to provide the necessary corrosion protection and increase boil-over protection. You should have it replaced every 15 years or 150 000 miles (250 000 km), whichever comes first.

Coolant system design and coolant used stipulate the replacement interval. The above replacement interval is only applicable if MB 325.0 anticorrosion/antifreeze solution or other Mercedes-Benz approved products of equal specification (see Factory Approved Service Products pamphlet) are used to renew the coolant concentration or bring it back up to the proper level.

To provide important corrosion protection, the solution must be at least 45% anticorrosion/antifreeze [equivalent to freeze protection to approx. -22°F (-30°C)]. If you use a solution that is more than 55% anticorrosion/antifreeze [freeze protection to approx. -49°F (-45°C)], the engine temperature will increase due to the lower heat transfer capability of the solution. Therefore, do not use more than this amount of anticorrosion/antifreeze.

Technical data

Fuels, coolants, lubricants etc.

If the coolant level is low, water and MB Anticorrosion /Antifreeze should be used to bring it up to the proper level (have cooling system checked for signs of leakage).

The water in the cooling system must meet minimum requirements, which are usually satisfied by normal drinking water. If you are not sure about the water quality, consult your authorized Mercedes-Benz Center.

Anticorrosion/antifreeze

Your vehicle contains a number of aluminum parts. The use of aluminum components in motor vehicle engines necessitates that anticorrosion/antifreeze coolant used in such engines be specifically formulated to protect the aluminum parts. (Failure to use such anticorrosion/antifreeze coolant will result in a significantly shortened service life.)

Therefore, the following product is strongly recommended for use in your vehicle: Mercedes-Benz 325.0 Anticorrosion/Antifreeze Agent.

Before the start of the winter season (or once a year in hot southern regions), you should have the anticorrosion/antifreeze concentration checked. The coolant is also regularly checked each time you bring your vehicle to your authorized Mercedes-Benz Center for service.

Anticorrosion/antifreeze quantity

Model	Approx. freeze protection	
	- 35°F (- 37°C)	- 49°F (- 45°C)
E 320	5.3 US qt (5.0 l)	5.9 US qt (5.5 l)
E 500	6.0 US qt (5.65 l)	6.6 US qt (6.2 l)

Technical data

Fuels, coolants, lubricants etc.

Windshield and headlamp washer system

Both the windshield and headlamp washer systems are supplied from the windshield washer fluid reservoir.

The washer fluid reservoir has a capacity of approx.:

- 7.4 US qt. (7 l) in vehicles with a headlamp cleaning system* or heated reservoir
- 4.8 US qt. (4.5 l) in vehicles without a headlamp cleaning system

- ▶ Refill the reservoir with MB Windshield Washer Concentrate and water (or concentrate and commercially available premixed windshield washer solvent / antifreeze, depending on ambient temperatures).

Warning



Washer solvent / antifreeze is highly flammable. Do not spill washer solvent / antifreeze on hot engine parts, because it may burn. You can be seriously burned.

Windshield and headlamp washer fluid mixing ratio

For temperatures above freezing, use MB Windshield Washer Concentrate "S" and water:

- 1 part "S" to 100 parts water
[40 ml "S" to 1 gallon (4 liters) water].

For temperatures below freezing use MB Windshield Washer Concentrate "S" and commercially available premixed windshield washer solvent / antifreeze:

- 1 part "S" to 100 parts solvent
[40 ml "S" to 1 gallon (4 liters) solvent].

Consumer information

The following text is published as required of all manufacturers of passenger cars under Title 49, Code of U.S. Federal Regulations, Part 575 pursuant to the "National Traffic and Motor Vehicle Safety Act of 1966".

Uniform tire quality grading

Quality grades can be found, where applicable, on the tire sidewall between tread shoulder and maximum section width. For example:

Tread wear	Traction	Temperature
200	AA	A

All passenger car tires must conform to federal safety requirements in addition to these grades.

Tread wear

The tread wear grade is a comparative rating based on the wear rate of the tire when tested under controlled conditions on a specified government test course. For example, a tire graded 150 would wear one and one-half (1½) times as well on the government course as a tire graded 100. The relative performance of tires depends upon the actual conditions of their use, however, and may depart significantly from the norm due to variations in driving habits, service practices and differences in road characteristics and climate.

Technical data

Consumer information

Traction

The traction grades, from highest to lowest, are AA, A, B, and C. Those grades represent the tire's ability to stop on wet pavement as measured under controlled conditions on specified government test surfaces of asphalt and concrete. A tire marked C may have poor traction performance.

Warning



The traction grade assigned to this tire is based on straight ahead braking traction tests, and does not include acceleration, cornering, hydroplaning, or peak traction characteristics.

Technical data

Consumer information

Temperature

The temperature grades are A (the highest), B, and C, representing the tire's resistance to the generation of heat and its ability to dissipate heat when tested under controlled conditions on a specified indoor laboratory test wheel. Sustained high temperature can cause the material of the tire to degenerate and reduce tire life, and excessive temperature can lead to sudden tire failure. Grade C corresponds to a level of performance which all passenger car tires must meet under the Federal Motor Vehicle Safety Standard No. 109. Grades B and A represent higher levels of performance on the laboratory test wheel than the minimum required by law.

Warning



The temperature grade for this tire is established for a tire that is properly inflated and not overloaded. Excessive speed, underinflation, or excessive loading, either separately or in combination, can cause excessive heat build-up and possible tire failure.

ABS

(Antilock Brake System)

Prevents the wheels from locking up during braking so that the vehicle can continue to be steered.

Alignment bolt

Metal pin with thread. The centering pin is an aid used when changing a tire to align the wheel with the wheel hub.

BabySmart™ airbag deactivation system

This system detects if a special system compatible child restraint seat is installed on the front passenger seat. The system will automatically deactivate the passenger front airbag when such a seat is properly installed (PASSENGER AIRBAG OFF indicator lamp located in the center console lights up). See your authorized Mercedes-Benz Center for availability.

BabySmart™ compatible child seats

Special restraint system for children. The sensor system for the passenger seat prevents deployment of the passenger side airbag if a BabySmart™ compatible child seat is installed.

BAS

(Brake Assist System)

System for potentially reducing braking distances in emergency braking situations. The system is activated when it senses an emergency based on how fast the brake is applied.

Bi-Xenon headlamps*

Headlamps which use an electric arc as a light source and produce a more intense light than filament headlamps. Bi-Xenon headlamps produce low beam and high beam.

CAC

(Customer Assistance Center)

Mercedes-Benz customer service center which can help you with any questions about your vehicle and provide assistance in the event of a breakdown.

CAN system

(Controller Area Network)

Data bus network serving to control vehicle functions such as door locking or windshield wiping.

Cockpit

All instruments, switches, buttons and indicator/warning lamps in the passenger compartment needed for vehicle operation and monitoring.

Technical terms

Control system

The control system is used to call up vehicle information and to change component settings. Information and messages appear in the multifunction display. The driver uses the buttons on the multifunction steering wheel to navigate through the system and to adjust settings.

Cruise control

Driving convenience system for automatically maintaining the vehicle speed set by the driver.

Distronic*

A driving convenience cruise control system which helps the driver maintain a pre-selected speed:

- If there is no vehicle directly ahead, the system operates in the same way as conventional ->cruise control.
- If a slower moving vehicle is ahead, Distronic will reduce your vehicle speed to the extent permitted by reduced throttle and up to 20% braking power to maintain the preset minimum following distance.

DTR

(->Distronic*)

Engine number

The number set by the manufacturer and placed on the cylinder block to uniquely identify each engine produced.

Engine oil viscosity

Measurement for the inner friction (viscosity) of the oil at different temperatures. The higher the temperature an oil can tolerate without becoming thin, or the lower the temperature it can tolerate without becoming viscous, the better the viscosity.

ESP

(Electronic Stability Program)
Improves vehicle handling and directional stability.

ETD

(Emergency Tensioning Device)
Device which deploys in certain frontal and rear collisions exceeding the system's threshold to tighten the seat belts.
->SRS

FSS

(Flexible Service System)
Service indicator in the multifunction display that informs the driver when the next vehicle maintenance service is due.

Gear range

Number of gears which are available to the automatic transmission for shifting. The automatic gear shifting process can be adapted to specific operating conditions using the selector lever.

GPS

(Global Positioning System)
Satellite-based system for relaying geographic location information to and from vehicles equipped with special receivers. Employs CD digital maps for navigation.

Instrument cluster

The displays and indicator/warning lamps in the driver's field of vision, including the tachometer, speedometer and fuel gauge.

Kickdown

Depressing the accelerator past the point of resistance shifts the transmission down to the lowest possible gear. This very quickly accelerates the vehicle and should not be used for normal acceleration needs.

Lock button

Button on the door which indicates whether the door is locked or unlocked. Pushing the lock button down on an individual door from inside will lock that door.

Memory function*

Used to store three individual seat, steering wheel and mirror positions for each key.

Technical terms

Menu

The control system displays are arranged in menus. Each menu contains a number of commands for particular systems. In the Audio menu, for example, you will find the commands SELECT RADIO STATION or OPERATE CD PLAYER. Using commands you can directly change the settings for your vehicle.

MON

(Motor Octane Number)

The Motor Octane Number for gasoline as determined by a standardized method. It is an indication of a gasoline's ability to resist undesired detonation (knocking). The average of both the MON (Motor Octane Number) and →RON (Research Octane Number) is posted at the pump, also known as ANTI-KNOCK INDEX.

Multifunction display

The display field in the instrument cluster used to present information provided by the control system.

Multifunction steering wheel

Steering wheel with buttons for operating the control system.

Overspeed range

Engine speeds within the red marking of the tachometer dial. Avoid this engine speed range, as it may result in serious engine damage that is not covered by the Mercedes-Benz Limited Warranty.

Poly-V-belt drive

Drives engine-components (alternator, AC compressor, etc.) from the engine.

Power train

Collective term designating all components used to generate and transmit motive power to the drive axles, including:

- Engine
- Clutch/torque converter
- Transmission
- Transfer case*
- Drive shaft
- Axle shafts/axles

Program mode selector switch

Used to switch the automatic transmission between standard operation **S** and winter operation **W**.

Remote Vehicle Diagnostics

Transmission of vehicle data and current location to the Mercedes-Benz Customer Assistance Center for subscribers to the Tele Aid service.

Restraint systems

Seat belts, belt tensioners, airbags and child restraint systems. As independent systems, their protective functions complement one another.

RON

(Research Octane Number)

The Research Octane Number for gasoline as determined by a standardized method. It is an indication of a gasoline's ability to resist undesired detonation (knocking). The average of both the \rightarrow MON (Motor Octane Number) and RON (Research Octane Number) is posted at the pump, also known as ANTI-KNOCK INDEX.

SBC

(Sensotronic Brake Control)

Electronically controlled hydraulic braking system for increased braking safety and comfort.

Shift lock

When the vehicle is parked, this lock prevents the transmission selector lever from being moved out of position **P** without key turned and brake pedal depressed.

SRS

(Supplemental Restraint System)

Seat belts, emergency tensioning device and airbags. Though independent systems, they are closely interfaced to provide effective occupant protection.

Tele Aid System

(Telematic Alarm Identification on Demand)

The Tele Aid system consists of three types of response: automatic and manual emergency, roadside assistance and information. Tele Aid is initially activated by completing a subscriber agreement and placing an acquaintance call.

The Tele Aid system is operational providing that the vehicle's battery is charged, properly connected, not damaged and cellular and GPS coverage is available.

Telematics*

A combination of the terms "telecommunications" and "informatics".

Tightening torque

Force times lever arm (e.g. a lug wrench) with which threaded fasteners such as wheel bolts are tightened.

Tire speed rating

Part of a tire designation; indicates the speed range for which a tire is approved.

Traction

Force exerted by the vehicle on the road via the tires.

**Vehicle level control**

The ground clearance of the vehicle is automatically controlled according to a selected setting and speed. The driver can set the ground clearance manually for example on very rough roads.

VIN

(Vehicle Identification Number)
The number set by the manufacturer and placed on the body to uniquely identify each vehicle produced.

Voice recognition system*

Voice control system for car phones, portable cell phones and audio systems (radio, CD, etc.).

A

- ABS 73, 375
 - Malfunction indicator lamp 289
 - Messages in display 296
 - Warning lamp 289
- Accelerator position, automatic transmission 156
- Accident
 - In case of 49
- Activating
 - Air conditioning (cooling) 170, 181
 - Air recirculation mode 168, 178
 - Anti-theft alarm system 82
 - Automatic climate control 174
 - Central locking (control system) 142
 - Charcoal filter 180
 - Climate control 164
 - Defrost 167
 - Distance warning function* 206
 - Distronic* 202
 - Easy-entry/exit feature* 143
 - ESP 77
 - Exterior headlamps 46
 - Exterior lamps 113
 - Hazard warning flasher 115
 - Headlamps 46
 - High beams 115
 - Ignition 31
 - Ignition with KEYLESS-GO* start/stop button 33
 - Immobilizer 52, 81
 - Rear fog lamp 113
 - Rear window defroster 169, 180
 - Residual heat 171, 182
 - Tow-away alarm 83
 - Windshield wipers 47
- Adjustable air outlets, rear passenger compartment 182
- Adjusting 34
 - Air distribution 166, 177
 - Air volume 166, 177
 - Backrest tilt 36
 - Exterior rear view mirror 39
 - Head restraint height 36
 - Head restraint tilt 36
 - Inside rear view mirror 38
 - Instrument cluster illumination 118
 - Mirrors 38
 - Multicontour seat* 104
 - Seat cushion depth 105
 - Seat cushion tilt 36
 - Seat fore and aft adjustment 35
- Seat height 35
- Seats 34
- Steering column height 38
- Steering column length 38
- Steering wheel 37
- Air conditioner (cooling)
 - Turning off 170, 181
 - Turning on 170, 181
- Air distribution
 - Adjusting 166, 177
- Air outlets, rear passenger compartment
 - Adjustable 182
- Air recirculation mode 167, 178
 - Activating 168, 178
 - Deactivating 168, 179
- Air volume
 - Adjusting 166, 177
- Airbags 57
 - BabySmart™ airbag deactivation system 67, 375
 - Children 58
 - Front 60
 - Passenger 60
 - Safety guidelines 59
 - Side impact 61
 - Window curtain 61

Index

- AIRMATIC DC (Dual Control) 209
 - Alarm
 - Audible 72, 82
 - Canceling 82
 - Visual 82
 - Alarm system
 - Anti-theft 82
 - Alignment bolt (vehicle tool kit) 340, 375
 - Antiglare
 - Automatic 157
 - Antilock brake system (ABS) 375
 - Anti-theft alarm system
 - Arming 82
 - Canceling alarm 82
 - Disarming 82
 - Anti-theft systems 81
 - Anti-theft alarm system 82
 - Immobilizer 81
 - Tow-away alarm 82
 - Ashtray 231
 - AUDIO menu 126
 - Selecting radio station 127
 - Automatic antiglare for rear view mirror 157
 - Automatic central locking
 - Activating/deactivating (control system) 142
 - Automatic climate control
 - Temperature sensor 27
 - Automatic climate control* 172
 - Adjusting air distribution 177
 - Adjusting air volume 166, 177
 - Air recirculation mode 178
 - Defrosting 178
 - Rear window defroster 169, 180
 - Residual heat utilization 182
 - Residual ventilation 182
 - Setting the temperature 176
 - Automatic headlamp mode 113
 - Automatic lighting control
 - Activating 116
 - Deactivating 116
 - Automatic locking when driving 99
 - Automatic transmission 151
 - Accelerator position 156
 - Emergency operation (Limp Home Mode) 156
 - Gear ranges 153
 - Gear selector lever position 154
 - Gear shifting malfunctions 156
 - Kickdown 156
 - One-touch gearshifting 152
 - Program mode selector switch 155
 - Selector lever position 151
 - Starting the engine 43
 - Winter program mode 155
- B**
- BabySmart™
 - Compatible child seats 375
 - Self-test 68
 - BabySmart™ airbag deactivation system 67, 375
 - Backrest
 - Folding forward 220
 - Folding rearward 221
 - BAS 74, 375
 - Messages in display 297, 298
 - Batteries, SmartKey
 - Changing 329
 - Check lamp 87
 - Checking 88

- Batteries, vehicle
 - Charging 344
 - Disconnecting 344
 - Messages in display 303, 304
 - Reconnecting 345
 - Removing 344
 - Service 343
- Battery discharged
 - Jump starting 346
- Bi-Xenon headlamps* 375
- Blocking
 - Rear window operation 71
- Brake assist system (BAS) 375
- Brake pads
 - Message in display 305
- Brakes
 - Warning lamp 291
- Bulbs, replacing
 - Front lamps 332, 334
 - High beam bulb (Bi-Xenon* headlamps only) 334
 - License plate lamps 336
 - Parking lamps 335
 - Standing lamps 335
 - Tail lamp assemblies 336
- C**
- CAC (Customer Assistance Center) 375
- Calling up
 - Distronic* settings 128
 - Range (distance to empty) 147
- CAN system 375
- Cargo area see Trunk 88
- Cargo tie-down rings 225
- Cassette player
 - Operating 128
- CD player*
 - Operating 127, 128
- Center console
 - Lower part 26
 - PASSENGER AIRBAG OFF indicator lamp 294
 - Upper part 25
- Centigrade
 - Setting temperature units 134
- Central locking
 - Automatic 99
 - From inside 100
 - Switch 100
 - Switching on/off (control system) 142
 - Unlocking from inside 100
- Central locking switch 100
- Changing
 - Batteries (SmartKey) 329
 - Key setting 143
 - Vehicle level 210
- Charcoal filter 180
- Charging
 - Vehicle batteries 344
- Child safety 65
 - Airbags 58
 - Infant and child restraint systems 61, 65
- Child safety switch see Blocking of rear window operation 71
- Cigarette lighter 232
- Cleaning
 - Headlamps 158
 - Parktronic* system sensor 284
 - Windshield 48
- Cleaning and care of the vehicle
 - Distronic system sensor 283
 - MB Tex upholstery 285
- Climate control 162
 - Adjusting 166
 - Defrosting 167
 - Setting the temperature 165

Index

- Clock 137
 - Closing
 - Glove box 226
 - Side windows 184
 - Side windows with KEYLESS-GO* 92
 - Sliding/pop-up roof* 187
 - Sliding/pop-up roof* with KEYLESS-GO* 92
 - Sliding/pop-up roof* with SmartKey 188, 192
 - Trunk lid 96
 - Windows 184
 - Windows with SmartKey 185
 - Cockpit 20, 375
 - COMAND* see separate operating instructions
 - Combination switch 115
 - High beam flasher 47
 - Turn signals 46
 - Windshield wipers 47
 - Consumer information 373
 - Control system 121, 376
 - AUDIO menu 126
 - Convenience submenu 143
 - Display digital speedometer 126
 - Distronic* menu 128
 - Functions 125
 - Instrument cluster submenu 134, 136
 - Lighting submenu 138
 - Malfunction memory menu 129
 - Menus 124, 125, 378
 - Multifunction display 121
 - Multifunction steering wheel 122
 - Selecting radio system 127
 - Settings menu 130
 - Standard display menu 126
 - Submenus 123, 125
 - TEL* menu 147
 - Trip computer menu 145
 - Vehicle submenu 142
 - Convenience submenu 143
 - Activating easy-entry/exit feature* 143
 - Setting key dependency 144
 - Setting parking position for exterior rear view mirror 144
 - Coolant
 - Messages in display 311, 312
 - Temperature display 119
 - Warning lamp 292, 311
 - Cruise control 194, 376
 - Canceling 195
 - Driving downhill 195
 - Driving uphill 195
 - Fine adjustment 196
 - Lever 201
 - Saving current speed 195
 - Setting speeds 196
 - Cruise control lever 194
 - Customer Assistance Center (CAC) 375
- ### D
- Daytime running lamp mode 114
 - Setting 139
 - Deactivating
 - Air conditioner 170
 - Air recirculation mode 168, 179, 180
 - Alarm 82
 - Anti-theft alarm system 82
 - Automatic climate control 169, 174
 - Central locking (control system) 142
 - Climate control 164
 - Cruise control 195
 - Defrost 167, 178
 - Distance warning function* 206
 - Distronic* 204
 - Engine with KEYLESS-GO* 53
 - Engine with the key 52

- ESP 76
- Exterior lamps 113
- Hazard warning flasher 115
- Headlamps 51
- Immobilizer 81
- Interior lighting delayed switch-off 141
- Rear window defroster 169, 180
- Residual heat 171
- Tow-away alarm 83
- Deceleration
 - With Distronic* 200
- Defogging
 - Windshield 166, 177
- Defrosting 167, 178
- Delayed switch-off
 - Interior lighting 141
- Dialing
 - A number (telephone) 149
- Difficulties
 - While driving see Problems while driving 48
 - With starting 44
- Digital speedometer 126
- Discharged battery
 - Jump starting 346
- Display
 - Selecting 135, 136
- Displays
 - Digital speedometer 126
 - Distronic* 199
 - Messages 264
 - Selecting 135
 - Service indicator 275
 - Showing malfunctions 130
- Distance
 - Decreasing in Distronic* 205
 - Increasing in Distronic* 205
 - Warning function 205
- Distance to empty (range)
 - Calling up 145
- Distance warning function* 205
 - Activating 206
 - Deactivating 206
 - DTR* warning lamp 205
 - Intermittent warning sound 205
 - Symbol in multifunction display 129
- Distronic* 197, 376
 - Activated 201
 - Activating 202
 - Calling up settings 128, 200
 - Cleaning sensors 283
 - Cover 283
 - Cruise control lever 201
 - Deactivated 201
 - Deactivating 204
 - Deceleration 200
 - Decreasing distance 205
 - Displays in the speedometer dial 199
 - Distance warning function 205
 - Driving hints 206
 - Fine adjustment 203
 - Increasing distance 205
 - Intermittent signal tone 199
 - Menu 200
 - Messages in display 300
 - Resetting stored speed 203
 - Setting a higher speed 202
 - Setting a slower speed 203
 - Setting the current speed 202
 - Setting the following distance in Distronic 204
 - Warning and indicator lamps 199
- Door entry lamps 117
- Door unlock
 - With Tele Aid* 241

Index

- Doors
 - Message in display 323
 - Opening from inside vehicle 93
 - Opening from outside 87, 91
- Downhill driving
 - Cruise control 195
- Downshifting 152
- Driving
 - General instructions 40
 - Problems 48
 - Safety systems 73
 - With Distronic* 206
- Driving hints
 - SBC brake system 79
- Driving safety systems
 - ABS 73
 - BAS 74
 - ESP 75, 376
 - SBC brake system 77
- Driving systems 194
 - AIRMATIC DC 209
 - Cruise control 194
 - Distronic* 197
 - Driving safety systems 73
 - Vehicle level control 209
- DTR see Distronic* 376
- Dual control
 - AIRMATIC DC 209
- E**
- Easy-entry/exit
 - Message in display 310
- Easy-entry/exit feature* 102
 - Activating 143
 - Interrupting movement 102, 143
- Electrical fuses 352
- Electrical system 363
- Electronic Stability Program see ESP 75, 376
- Emergency call system* 235
- Emergency calls
 - Initiating an emergency call 237
 - With Tele Aid* 236
- Emergency operation (Limp Home Mode) 156
- Emergency operations
 - Releasing trunk lid from inside 97
 - Remote door unlock 241
 - Sliding/pop-up roof* or panorama sliding/pop-up roof* 331
 - Unlocking the vehicle 327
- Emergency tensioning device 377
- Emergency tensioning device see ETD 377
- Ending
 - A call (telephone) 149
- Engine 360
 - Starting 43
 - Starting with KEYLESS-GO* 44
 - Starting with the key 44
 - Turning off with the key 52
- Engine number 376
- Engine oil
 - Adding 263
 - Additives 368
 - Checking level 262
 - Display messages 299, 300
 - Filler neck 263
 - Messages in display 264, 300
 - Viscosity 376
- ESP 75, 376
 - Switching off 76
 - Switching on 77
 - Warning lamp 288
- ETD 377
 - Safety guidelines 59
- Exterior lamp switch 112

Exterior rear view mirrors
 Adjusting 39
 Parking position for 144

F

Fahrenheit
 Setting temperature units 134
 Fastening the seat belts 40
 Fine adjustment
 Cruise control 196
 Distronic* 203
 First aid kit 324
 Flat tire 338
 Spare wheel 338
 Flexible Service System (FSS) 275, 377
 Fog lamp, rear 114
 Fog lamps, front 114
 Messages in display 316
 Replacing bulbs 332
 Switching on 114
 Front airbags 60
 Front lamps 332
 Messages in display 313
 Replacing bulbs 334
 Switching on 112
 Front seat head restraints
 Power seat 103

Front seats
 Heater* 107
 FSS (Flexible Service System) 275, 377
 Fuel 260
 Premium unleaded gasoline 260
 Fuel consumption statistics
 After start 146
 Since last reset 146
 Fuel filler flap 259
 Locking 259
 Unlocking 259
 Fuel reserve tank
 Message in display 313, 323
 Fuel tank
 Filler flap 259
 Fuels, coolants, lubricants etc. 366
 Functions (control system) 125
 Resetting 131
 Fuse chart 353
 Fuses 352
 Fuse chart 353
 Fuse extractor 353
 Spare fuses 353

G

Garage door opener 27, 243
 Erasing in remote control 246
 Integrated remote control 244
 Rolling code programming 245
 Gasoline see Fuel 260
 Gear range 377
 Automatic transmission 153
 Limiting 153
 Shifting into optimal 152
 Gear range limit
 Canceling 152
 Gear selector lever
 Position 154
 Global
 Locking 87
 Locking with KEYLESS-GO* 91
 Unlocking 87
 Unlocking with KEYLESS-GO* 91
 Global Positioning System (GPS) 377
 Glove box 226
 Closing 226
 Opening 226
 Good visibility 157
 GPS 377
 GPS see COMAND* 243

Index

Garage door opener 27

H

Hand-held transmitter

Programming integrated remote control 244

Hazard warning flasher 115

Switching off 115

Switching on 115

Head restraints 103

Headlamps

Automatic control 113

Bi-Xenon 375

Cleaning system* 158

Switching off 51

Switching on 46

Heated seats* 107

Height adjustment

Head restraints 36

Steering wheel 37

Vehicle level 209

High beam flasher 47, 115

High beam headlamps 332

Messages in display 316

Switching on 115

Hood 261

Closing 261

Message in display 313

Opening 261

I

Identification labels 358

Ignition 31, 33

Switching on 44

Immobilizer 81

Activating 81

Deactivating 81

Indicator lamps see Lamps, indicator and warning

Infant and child restraint systems 65

Info services 242

Information

About service and warranty 10

Button for Tele Aid* 239

Inside rear view mirror

Adjusting 38

Instrument 22

Instrument cluster 118, 377

Coolant temperature display 119

Illumination 118

Multifunction display 121

Outside temperature indicator 120

Selecting language 135

Instrument lighting 118, 119

Integrated remote control

Canadian programming 245

Erasing memory 246

Hand-held transmitter 244

Operating 246

Rolling code programming 245

Interior lighting 116

Activating automatic control 116

Deactivating automatic control 116

Delayed switch-off 141

Manual operation 116

Interior storage spaces 226

Glove box 226

J

Jump starting 346

K

Key (SmartKey)

Changing the batteries 329

Key dependency memory

Settings 144

Key positions in starter switch 31

Key, electronic

Messages in display 323

- Key, Mechanical 327
- Key, SmartKey
 - Battery check lamp 87
 - Checking the batteries 88
 - Factory setting 87
 - Global locking 87
 - Global unlocking 87
 - Loss of 89
 - Positions in starter switch 31
 - Remote controls 86
 - Restoring to factory setting 87
 - Selective setting 87
 - Starting the engine 44
 - Turning off the engine 52
 - Unlocking the trunk lid 88
 - Unlocking with 30
- Key, SmartKey with KEYLESS-GO*
 - Turning off the engine 53
- KEYLESS-GO*
 - Activating ignition with 33
 - Closing side windows 92
 - Closing sliding/pop-up roof* 92
 - Factory setting 91
 - Global locking 91
 - Global unlocking 91
 - Important notes 90
- Locking the vehicle 92
- Remote controls 89
- Starting the engine 44
- Turning off engine 53
- Unlocking with 32
- Unlocking, trunk lid 92
- KEYLESS-GO* card
 - Messages in display 309
- Keys 86
- Kickdown 156, 377
- Kilometers/miles in speedometer 134
- Km/h or mph in speedometer 134
- L**
- Lamp bulbs, exterior 332
- Lamps, exterior
 - Front 332
 - Light sensor 313
 - Messages in display 313-??
 - Replacing bulbs for rear 333, 336
- Lamps, indicator and warning
 - ABS 289
 - Airbag Off 61
 - Battery (SmartKey) 87
 - Brakes 291
 - Coolant 292
 - DTR* 199
- ESP 288
- SBC 77
- Seat belts 293
- SRS 56
- Language
 - Multifunction display 135
 - Setting 135
- Layout of poly-V-belt drive 359
- Level control system
 - AIRMATIC DC 209
- Lever
 - Cruise control 201
- License plate lamps 333
 - Messages in display 316
 - Replacing bulbs 336
- Light sensor 313
- Lighter see Cigarette lighter 232
- Lighting 112
 - Automatic headlamp mode 113
 - Combination switch 115
 - Daytime running lamp mode 114
 - Door entry lamps 117
 - Exterior lamp switch 112
 - Front fog lamps 114
 - High beams 115
 - Instrument cluster illumination 118

Index

- Instruments 118, 119
- Interior 116
- Locator lighting 114
- Low beam 112
- Manual headlamp mode 113
- Night security illumination 114
- Parking lamps 112
- Rear fog lamp 114
- Settings (control system) 138
- Trunk lamp 117
- Limiting the gear range 153
- Limp Home Mode 156
- Loading 216
 - Cargo tie-down rings 225
 - Instructions 224
 - Roof rack 216
 - Ski sack* 216
 - Split rear bench seat 219
- Locator lighting 114
 - Setting 139
- Lock button 377
 - Door handle (KEYLESS-GO*) 53
- Locking 50, 86
 - Automatic while driving 99
 - Centrally from inside 100
 - Fuel filler flap 259
 - Global with KEYLESS-GO* 91
 - Global, SmartKey 87
 - Separately the trunk 98
 - Vehicle with KEYLESS-GO* 92
- Loss of keys 89, 93
- Low beam headlamps 332
 - Messages in display 313
- M**
- Main Dimensions 364
- Maintenance 12
- Malfunction
 - Displaying 130
- Malfunction memory 129
 - Calling up 129
 - Clearing 130
- Manual headlamp mode 113
- Manual operations
 - Interior lighting control 116
 - Locking the trunk 98
 - Unlocking the driver's door 327
- MB Tex upholstery
 - Cleaning 285
- Mechanical key 327
- Memory function 109, 377
 - Recalling positions from memory 110
 - Storing exterior rear view mirror parking positions 111
 - Storing key dependent settings 110
- Menus 124
 - AUDIO 126
 - Control system 378
 - Distronic* 128, 200
 - In control system 124, 125
 - Malfunction memory 129
 - Settings menu 130
 - Standard display 126
 - Submenus 123
 - TEL* 147
 - Trip computer 145
- Miles/kilometers in speedometer
 - Setting 134
- Mirrors
 - Adjusting 38
 - Automatic antiglare for rear view mirror 157
 - Automatic antiglare* for inside mirror 157
 - Exterior rear view mirror 39
 - Exterior rear view mirror parking positions 144, 158
 - Inside rear view mirror 38

- Storing exterior mirror parking position 111
- MON 260
- MON (Motor Octane Number) 378
- Mph or km/h in speedometer 134
- Multicontour seat* 104
- Multifunction display 121, 378
 - Selecting language 135
 - Standard display 125
- Multifunction display messages
 - ABS 296
 - BAS 297, 298
 - Batteries 303, 304
 - Brake pads 305
 - Coolant 311, 312
 - Coolant level 311
 - Distronic* 300
 - Doors 323
 - Easy-entry/exit feature 310
 - Engine oil level 300
 - Fuel reserve tank 313, 323
 - Hood 313
 - Key 313, 323
 - KEYLESS-GO* card 309
 - Lamps 313-??
 - Parking brake 310
 - SBC brake system 305, 306
 - Seat belts 310
 - Steering gear oil level 318
 - Telephone* 309
 - Trunk lid 310
 - Washer fluid 311
- Multifunction steering wheel 24, 122, 378
 - Buttons 122
- N**
- Network provider 148
- Night security illumination 114
- O**
- Occupant safety 56
 - Airbags 57
 - Children and airbags 58
 - Children in the vehicle 65
 - Fastening the seat belt 40
 - Infant and child restraint systems 65
 - Seat belts 40, 59
- Oil
 - Viscosity 376
- One-touch gearshifting 152
 - Canceling gear range limit 152
 - Downshifting 152
 - Upshifting 152
- Opening 331
 - Ashtray 231
 - Doors from the inside 93
 - Glove box 226
 - Side windows 184
 - Sliding/pop-up roof* 187
 - Sliding/pop-up roof* with SmartKey 188, 192
 - Trunk 88, 96
 - Trunk from the inside 94
 - Windows 184
 - Windows with SmartKey 185
- Operating
 - Cassette player 128
 - CD player* 127, 128
 - Garage door opener 246
 - Integrated remote control 246
 - Radio 127
 - Safety 16
 - Telephone* 147
 - Vehicle outside the USA and Canada 13
- Operating safety 16
- Operator's Manual 10
- Outside temperature indicator 120

Index

Overhead control panel 27
Garage door opener 243
Overspeed range 378

P

Panic alarm 72
Panic button on SmartKey 72
Parking 50
Parking brake 45, 50
Engaging 50
Message in display 310
Releasing 45
Parking lamps 332
Replacing the bulbs 335
Switching on 112
Parking position
Exterior rear view mirrors 111, 144,
158
Parktronic*
Sensor 284
PASSENGER AIRBAG OFF indicator
lamp 294
Passenger compartment
Inside rear view mirror 38
Interior lighting 116
Passenger safety see Occupant
safety 56

Phone book*
Loading 149
Quick search 149
Phone number*
Dialing 149
Redialing 149
Poly-V-belt drive 378
Positions (Memory function)
Recalling from memory 110
Positions (Memory function*)
Storing into memory 110
Power seat
Adjusting backrest tilt 36
Adjusting head restraint height 36
Adjusting head restraint tilt 36
Adjusting seat cushion tilt 36
Adjusting seat height 35
Memory function 109
Removing/installing head
restraints 103
Seat fore and aft adjustment 35
Power train 378
Power windows 184
Blocking of rear window operation 71
Side windows 184
Synchronizing 186

Practical hints
Lamp in center console 294
Problems
While driving 48
With vehicle 17
Product information 9
Program mode selector switch 378
Automatic transmission 155

Q

Quick search
Phone book* 149

R

Radio
Selecting stations 127
Range (distance to empty)
Calling up 147
Rear bench seat
Foldable 219
Rear fog lamp
Switching on 114
Rear lamps see Tail lamps
Rear passenger compartment
Adjustable air outlets 182
Rear seat head restraints
Folding back with switch 104

- Placing upright 104
- Rear seats 103
- Rear seats
 - Rear seat head restraints 103
- Rear view mirror automatic antiglare 157
- Rear view mirrors see Mirrors
- Rear window
 - Blocking operation 71
- Rear window defroster 169, 180
- Rear window sunshade* 160, 161
- Regular driving style 212
- Remote controls
 - Integrated 244
 - SmartKey 86
 - SmartKey with KEYLESS-GO* 89
- Remote door unlock
 - With Tele Aid* 241
- Remote Vehicle Diagnostics 378
- Removing
 - Ski sack 219
- Replacing
 - Bulbs 332
 - Front lamp bulbs 334
 - Fuses 353
 - High beam bulb (Bi-Xenon* headlamps only) 334
- License plate lamp bulbs 336
- Rear lamp bulbs 333, 336
- Wiper blades 337
- Reporting
 - Safety defects 18
- Reset knob in the instrument cluster 131
- Resetting
 - All functions (control system) 131
 - All functions of a submenu 131
 - Fuel consumption 146
 - Service indicator (FSS) 276, 278, 279
 - Stored speed in DISTRONIC* 203
 - Trip odometer 119
- Residual heat utilization 171, 182
- Residual ventilation 171, 182
- Restraint system see Infant and child restraint systems 65
- Rims and Tires 361
- Roadside assistance 12
- Rolling code programming 245
- RON (Research Octane Number) 260, 379
- Roof rack 216
- S**
- Safety
 - Occupant 56
 - Safety belts see Seat belts 40
 - Safety defects
 - Reporting 18
 - Safety systems
 - Driving 73
 - Saving current speed 195
 - SBC 77
 - SBC brake system 379
 - Activation 78
 - Deactivation 79
 - Driving hints 79
 - Messages in display 305, 306
 - Self-check 79
 - Warning lamp 77
 - Seat belt force limiter 64
 - Seat belts 61
 - Fastening 40
 - Message in display 310
 - Proper use of 42, 63
 - Safety guidelines 59
 - Warning lamp 293
 - Seat cushion depth
 - Adjusting 105
 - Seats 102
 - Adjusting 34

Index

- Easy entry/exit feature* 102
- Heater* 107
- Multicontour seat 104
- Split rear bench seat 219
- Ventilation 108
- Securing cargo
 - Cargo tie-down rings 225
- Selecting
 - Display 135
- Selecting display 136
- Selector lever
 - Lock 43
 - Position 151
- Self-test
 - BabySmart™ airbag deactivation system 68
 - Tele Aid* 235
- Service
 - Batteries 343
 - Calling up the service indicator 276
 - Overdue 276
 - When due 275
- Service and warranty information 10
- Service indicator 275
 - Clearing 275
- Service System see FSS 275
- Setting
 - Convenience functions 132, 143
 - Cruise control 195
 - Daytime running lamp mode 139
 - Exterior rear view mirror parking position 111
 - Higher speed in cruise control 196
 - Higher speed in Distronic* 202
 - Hours (clock) 137
 - Individual vehicle settings 130
 - Instrument lighting 118, 119
 - Interior lighting delayed switch-off 141
 - Key dependent memory 144
 - Lamps and lighting (control system) 138
 - Language, multifunction display 135
 - Locator lighting 139
 - Lower speed in cruise control 196
 - Lower speed in Distronic* 203
 - Miles/kilometers in speedometer 134
 - Minutes (clock) 137, 138
 - Parking position for exterior rear view mirrors 144
 - Slower speed in cruise control 196
 - Slower speed in Distronic* 203
 - Speed in cruise control 196
 - Speed in Distronic* 202
 - Speedometer display mode 134
 - Temperature (interior) 165, 176
 - Temperature indicator 134
 - Tire inflation pressure 136
 - Units
 - Speedometer 134
 - Temperature 134
 - Tire inflation pressure 136
 - Vehicle level control 209
- Settings
 - Calling up Distronic* 128, 200
 - Convenience functions 143
 - Factory, KEYLESS-GO* 91
 - Factory, SmartKey 87
 - Individual (SmartKey) 144
 - Lighting (control system) 138
 - Menus and submenus 123
 - Resetting all (control system) 131
 - Resetting in the submenu 131
 - Selective 87
- Settings menu
 - Functions in 130
 - Individual vehicle settings 130

- Submenus 131
- Shift lock 379
- Shifting
 - Gear selector lever positions 154
 - Into optimal gear range (automatic transmission) 152
- Side impact airbags 61
- Side marker lamps 332, 336
- Side windows
 - Automatic opening 184
 - Closing 184, 185
 - Closing with KEYLESS-GO* 92
 - Closing with SmartKey 185
 - Opening 184, 185
 - Opening fully 184
 - Opening with SmartKey 185
 - Stopping 185
 - Synchronizing power windows 186
- Signal strength (telephone*) 148
- Simultaneous wiping and washing
 - Windshield wipers 48
- Single wipe 48
- Ski sack* 216
 - Removing 219
 - Unfolding and loading 216
 - Unloading and folding 218
- Sliding/pop-up roof* 187
 - Closing 187
 - Closing with KEYLESS-GO* 92
 - Closing with SmartKey 188, 192
 - Opening 187
 - Opening with SmartKey 188, 192
 - Stopping 188
 - Synchronizing 189
- Sliding/pop-up roof* or panorama sliding/pop-up roof*
 - Emergency operations 331
- SmartKey
 - Locking and unlocking 86
 - Opening and closing the sliding/pop-up roof* with 188, 192
 - Opening and closing windows with 185
 - Unlocking with 30
- SmartKey with KEYLESS-GO*
 - Global locking and unlocking 91
 - Locking the vehicle 92
 - Loss of 93
 - Remote controls 89
 - Unlocking with 32
- Snow chains 274
- Spare fuses 353
- Sliding/pop-up roof* 187
- Closing 187
- Closing with KEYLESS-GO* 92
- Closing with SmartKey 188, 192
- Opening 187
- Opening with SmartKey 188, 192
- Stopping 188
- Synchronizing 189
- Sliding/pop-up roof* or panorama sliding/pop-up roof*
 - Emergency operations 331
- SmartKey
 - Locking and unlocking 86
 - Opening and closing the sliding/pop-up roof* with 188, 192
 - Opening and closing windows with 185
 - Unlocking with 30
- SmartKey with KEYLESS-GO*
 - Global locking and unlocking 91
 - Locking the vehicle 92
 - Loss of 93
 - Remote controls 89
 - Unlocking with 32
- Snow chains 274
- Spare fuses 353
- Spare parts service 356
- Spare wheel 324
- Speed
 - Resetting stored speed in Distronic* 203
 - Saving current 195
- Speed settings
 - Cruise control 196
 - Distronic* 202, 203
- Speedometer
 - Displaying gear range 153
 - Displays 199
 - Settings units 134
- Speedometer display mode
 - Selecting 134
- Split rear bench seat 219
- Sporty driving style 212
- SRS 63, 379
 - Indicator lamp 290
- Standing lamps 112
 - Replacing bulbs 335
- Starter switch 31
 - Positions 31
- Starting difficulties 44
- Starting position 31
- Starting the engine 43

Index

- Steering column
 - Height adjustment 38
 - Length adjustment 38
 - Steering gear oil
 - Message in display 318
 - Steering wheel
 - Adjusting 37
 - Electrical adjustment 38
 - Height adjustment 38
 - Stolen vehicle
 - Tracking services 242
 - Stopping
 - Sliding/pop-up roof* 188
 - Windows 185
 - Storage compartments
 - Glove box 226
 - Storing (Memory function*)
 - Positions into memory 110
 - Submenus
 - Convenience 143
 - For settings 123
 - In control system 125
 - Instrument cluster 134, 136
 - Lighting 138
 - Resetting functions in Control system 131
 - Selecting 131
 - Settings menu 131
 - Vehicle 142
 - Sun visors 158
 - Supplemental Restraint System (SRS) 379
 - Suspension tuning
 - For regular driving style 212
 - For sporty driving style 212
 - Switching off
 - Automatic central locking (control system) 142
 - Engine 51
 - ESP 76
 - Hazard warning flasher 115
 - Headlamps 51
 - Switching on
 - Automatic central locking (control system) 142
 - ESP 77
 - Front fog lamps 114
 - Hazard warning flasher 115
 - Headlamps 46
 - High beams 115
 - Rear fog lamp 114
 - Windshield wipers 47
 - Symbol (Distrionic*)
 - Distance warning function* 129
 - Synchronizing
 - Power windows 186
 - Sliding/pop-up roof* 189
- ### T
- Tachometer 120
 - Overspeed range 120
 - Tail lamps 333, 336
 - Tele Aid System 379
 - Tele Aid* 234
 - Emergency calls 236
 - Info services 242
 - Information 239
 - Initiating an emergency call manually 237
 - Remote door unlock 241
 - Roadside assistance 238
 - SOS button 237
 - Stolen vehicle tracking services 242
 - System self-check 235
 - Tele Aid System 235
 - Upgrade signals 240
 - Telematics* 379
 - Telephone* 24, 233
 - Answering a call 148

- Dialing a number from the phone book 149
- Ending a call 149
- Loading phone book* 149
- Messages in display 309
- Operating 147
- Redialing 149
- Temperature
 - Display mode 134
 - Sensor 27
 - Setting interior temperature 165, 176
 - Setting units in display 134
- Tie-down rings (trunk) 225
- Tightening torque 342, 379
- Time
 - Setting hours 137
 - Setting minutes 137, 138
- Tire inflation pressure
 - Setting units 136
- Tire speed rating 379
- Tires 373
- Tools 326
- Tow-away alarm 82
 - Arming 82
 - Disarming 82
- Disarming for transport 82
- Towing eye bolt (vehicle tool kit)
 - Installing 350
- Towing the vehicle 348
- Tracking services
 - For stolen vehicle 242
- Traction 155, 379
- Trip computer 145
- Trip odometer
 - Resetting 119
- Trunk
 - Closing the lid 96
 - Lamp 117
 - Lock button, KEYLESS-GO* 92
 - Message in display 310
 - Opening 88, 96
 - Opening from inside vehicle 94
 - Separately locking 98
 - Tie-down rings 225
 - Trunk lid emergency release 97
 - Unlocking with KEYLESS-GO* 92
- Trunk lid
 - Closing 96
- Turn signals 46
 - Additional in mirrors 332
 - Front bulbs 332
- Turning off
 - Engine 51
- U**
- Units
 - Setting speedometer units 134
 - Setting temperature units 134
 - Setting tire inflation pressure units 136
- Unlocking 30, 86, 327
 - Centrally from inside 100
 - Driver's door in an emergency 327
 - Fuel filler flap 259
 - Global 87
 - Global with KEYLESS-GO* 91
 - Selective settings 87
 - Trunk lid with KEYLESS-GO* 92
 - Vehicle in an emergency 241
 - With KEYLESS-GO* 32
 - With the SmartKey 30
- Upgrade signals
 - Tele Aid* 240
- Uphill driving
 - Cruise control 195
- Upshifting 152
- Useful features 226
 - Ashtrays 231

Index

- Cigarette lighter 232
 - Garage door opener 243
 - Tele Aid* 234
 - Telephone* 233
- V**
- Vehicle
 - Individual settings 130, 132
 - Proper use of 16
 - Towing 348
 - Vehicle care
 - Parktronic* system sensor 284
 - Vehicle level
 - Changing 210
 - Setting 210
 - Automatic 210
 - Manual 210
 - Vehicle level control system
 - AIRMATIC DC 209
 - Vehicle tool kit 326
 - VIN (Vehicle Identification Number) 380
 - Voice recognition system* 380
- W**
- Warning lamps see Lamps, indicator and warning
 - Warning sounds
 - Distance warning function* 205
 - Distronic* 199
 - Drivers seat belts 61
 - Parking brake 45
 - Warranty coverage 357
 - Weights 365
 - Wheel change 338
 - Tightening torque 342
 - Window curtain airbags 61
 - Windshield
 - Defogging 166, 177
 - Windshield washer fluid
 - Message in display 311
 - Wiping with 48
 - Windshield wipers 47
 - Fast wiper speed 47
 - Intermittent wiping 47
 - Replacing wiper blades 337
 - Single wipe 48
 - Switching on 47
 - Wiping with windshield washer fluid 48
 - Winter driving
 - Block heater 274
 - Snow chains 274
 - Tires 273
 - Transmission program mode 155
 - Wiping
 - And washing simultaneously 48
 - Interval 47
 - With windshield washer fluid 48
- X**
- Xenon headlamps
 - Bi-Xenon 375

Service and Literature

Your authorized Mercedes-Benz Center has trained technicians and original Mercedes-Benz parts to service your vehicle properly. For expert advice and quality service, see your authorized Mercedes-Benz Center.

If you are interested in obtaining service literature for your vehicle, please contact your authorized Mercedes-Benz Center. We consider this the best way for you to obtain accurate information for your vehicle.

For further information you can find us on the Mercedes-Benz web-site www.mbusa.com or www.mercedes-benz.ca.

Warning



To help avoid personal injury, be extremely careful when performing any service work or repairs. Improper or incomplete service or the use of incorrect or inappropriate parts or materials may damage the vehicle or its equipment, which may in turn result in personal injury.

If you have any question about carrying out some service, turn to the advice of an authorized Mercedes-Benz Center.

We reserve the right to modify the technical details of the vehicle as given in the data and illustrations of this Operator's Manual. Re-printing, translation and copying, even of excerpts, is not permitted without our prior authorization in writing.

Title illustration no. P00.01-2282-31

Press time 07 / 04 / 02

GSP / SIP

Printed in Germany

Free Manuals Download Website

<http://myh66.com>

<http://usermanuals.us>

<http://www.somanuals.com>

<http://www.4manuals.cc>

<http://www.manual-lib.com>

<http://www.404manual.com>

<http://www.luxmanual.com>

<http://aubethermostatmanual.com>

Golf course search by state

<http://golfingnear.com>

Email search by domain

<http://emailbydomain.com>

Auto manuals search

<http://auto.somanuals.com>

TV manuals search

<http://tv.somanuals.com>