

ML 320

ML 350

ML 500

ML 55 AMG

Our company and staff congratulate you on the purchase of your new Mercedes-Benz.

Your selection of our product is a demonstration of your trust in our company name. Further, it exemplifies your desire to own an automobile that will be as easy as possible to operate and provide years of service.

Your Mercedes-Benz represents the efforts of many skilled engineers and craftsmen. To help assure your driving pleasure, and also the safety of you and your passengers, we ask you to make a small investment of time:

- Please read this manual carefully before putting it aside. Then return it to your vehicle where it will be handy for your reference.
- Please follow the recommendations contained in this manual. They are designed to acquaint you with the operation of your Mercedes-Benz.
- Please pay attention to the warnings and cautions contained in this manual. They are designed to help improve the safety of the vehicle operator and occupants.

We extend our best wishes for many miles of safe, pleasurable driving.

Mercedes-Benz USA, LLC
A DaimlerChrysler Company

Introduction	9
Product information	9
Operator's Manual	10
Service and warranty information ..	10
Important notice for California retail buyers and lessees of	
Mercedes-Benz automobiles	11
Maintenance	12
Roadside Assistance	12
Change of address or ownership....	12
Operating your vehicle outside the USA or Canada.....	13
Where to find it.....	15
Symbols.....	16
Operating safety	17
Proper use of the vehicle	17
Problems with your vehicle.....	18
Reporting safety defects.....	19
Reporting safety defects	19

At a glance	21
Cockpit.....	22
Instrument cluster	24
Center console	27
Upper part	27
Lower part	28
Overhead control panel	29
Getting started	31
Unlocking	32
Remote control with folding key	32
Adjusting	34
Seats.....	34
Steering wheel	37
Mirrors.....	38
Driving.....	40
Fastening the seat belts.....	40
Starting the engine	44
Switching on headlamps	46
Turn signals.....	47
Windshield wipers.....	47
Rear window wiper.....	48
Problems while driving.....	49

Parking and locking.....	50
Parking brake	50
Switching off headlamps.....	51
Turning off engine.....	51

Safety and Security	53
Occupant safety	54
Airbags	55
Seat belts	60
Children in the vehicle	63
Blocking of rear door window operation	69
Panic alarm	70
Activating.....	70
Deactivating.....	70
Driving and safety systems	71
ABS.....	71
BAS.....	73
4-ETS	73
EBP	74
ESP	75
Anti-theft systems	78
Immobilizer.....	78
Anti-theft alarm.....	78

Contents

Tow-away alarm, glass breakage sensor.....	79	Lighting.....	102	Good visibility.....	119
Controls in detail	83	Combination switch.....	102	Rear view mirror.....	119
Locking and unlocking.....	84	Fog lamps.....	105	Headlamp cleaning system*.....	121
Remote control with folding key.....	84	Hazard warning flasher.....	106	Windshield wipers.....	122
Opening the doors		Interior lighting.....	107	Rear window wiper.....	123
from the inside.....	86	Instrument cluster.....	110	Sun visor.....	123
Opening the liftgate.....	87	Instrument cluster illumination....	110	Automatic climate control.....	124
Closing the liftgate.....	88	Coolant temperature gauge.....	111	Automatic mode.....	126
Automatic central locking.....	89	Display in the speedometer.....	111	Adjusting air volume and air distribution manually.....	127
Locking and unlocking		Resetting trip odometer.....	112	Defrosting.....	128
from the inside.....	90	Tachometer.....	112	Air recirculation mode.....	128
Seats.....	91	Outside temperature indicator.....	112	Air conditioning.....	129
Seat heater*.....	91	Setting the clock.....	112	Residual heat and ventilation.....	130
Removing and installing		Automatic transmission.....	113	Rear window defroster.....	131
head restraints.....	92	One-touch gearshifting.....	113	Rear passenger compartment ventilation and rear automatic climate control.....	131
Rear seats.....	93	Gear ranges.....	114	Front and rear air outlets.....	132
Third row seats*.....	96	Gear selector lever position.....	115	Power windows.....	134
Memory function*.....	99	Accelerator position.....	117	Opening and closing the side windows.....	134
Storing positions in memory.....	100	Towing a trailer.....	117	Rear quarter windows*.....	136
Recalling positions from memory.....	100	Emergency operation (Limp Home Mode).....	117	Sliding/pop-up roof*.....	137
Exterior rear view mirror parking position (passenger side).....	100	Transmission control -		Opening and closing the sliding/pop-up roof.....	137
		LOW RANGE mode.....	118		
		Switching on LOW RANGE mode..	118		
		Switching off LOW RANGE mode..	118		

Loading.....	139	Drinking and driving.....	179	Engine compartment.....	202
Loading instructions.....	139	Pedals.....	179	Hood.....	202
Partition net*.....	141	Power assistance.....	179	Engine oil.....	203
Cargo area cover blind*.....	143	Brakes.....	180	Transmission fluid level.....	206
Cargo floor plates.....	144	Driving off.....	181	Coolant.....	206
Roof rack*.....	145	Parking.....	182	Battery.....	207
Driving systems.....	146	Tires.....	182	Windshield washer system and	
Cruise control.....	146	Hydroplaning.....	183	headlamp cleaning system.....	208
Parktronic system*		Tire traction.....	183	Tires and wheels.....	209
(Parking assist).....	149	Tire speed rating.....	184	Important guidelines.....	209
Useful features.....	152	Winter driving instructions.....	184	Life of tire.....	210
Interior storage spaces.....	152	Standing water.....	185	Direction of rotation.....	210
Cup holders.....	154	Off-road driving.....	186	Checking tire inflation pressure....	211
Armrest in rear seat bench.....	155	Trailer towing.....	192	Rotating wheels.....	212
Ashtrays and cigarette lighter.....	156	Passenger compartment.....	196	Winter driving.....	213
Electrical outlet.....	158	Driving abroad.....	197	Winter tires.....	213
Telephone*.....	158	Control and operation of radio		Block heater (Canada only).....	214
Tele Aid*.....	159	transmitters.....	197	Snow chains.....	214
Garage door opener.....	168	Catalytic converter.....	198	Maintenance.....	215
Trip computer*.....	172	Emission control.....	198	Clearing the service indicator.....	215
Operation.....	177	Coolant temperature.....	199	Service term exceeded.....	215
The first 1000 miles (1500 km).....	178	At the gas station.....	200	Calling up the service indicator....	216
Driving instructions.....	179	Check regularly and		Resetting the service indicator....	216
Drive sensibly – save fuel.....	179	before a long trip.....	201	Vehicle care.....	217
				Cleaning and care	
				of the vehicle.....	217

Practical hints	223	Replacing wiper blades.....	254	Technical data	273
What to do if ...	224	Removal	254	Spare parts service.....	274
Lamps in instrument cluster.....	224	Installation	254	Warranty coverage	275
Additional indicators in the		Flat tire	255	Loss of Service and Warranty	
speedometer display	235	Mounting the spare wheel.....	255	Information Booklet	275
Where will I find ...?.....	236	Battery	261	Identification labels	276
First aid kit	236	Disconnecting the battery.....	261	Layout of poly-V-belt drive.....	277
Vehicle tool kit	237	Removing the batteries	262	Engine	278
Electric air pump (ML 55 AMG)	238	Charging and reinstalling		Rims and tires	279
Spare wheel (space-saver tire)	239	batteries.....	262	Rims and tires.....	279
Unlocking/locking in an emergency..	242	Reconnecting the batteries	262	Rims and winter tires*	280
Unlocking the vehicle	242	Jump starting	264	Spare wheel.....	280
Locking the vehicle	243	Towing the vehicle	267	Electrical system	281
Changing batteries	243	Front towing eye	269	Main Dimensions.....	282
Fuel filler flap	244	Rear towing eye	269	Weights	283
Manually unlocking the		Stranded vehicle	270	Fuels, coolants, lubricants etc.....	284
transmission selector lever	245	Fuses	271	Capacities	284
Opening/closing in an emergency	246	Fuse box in engine		Engine oils	286
Sliding/pop-up roof*	246	compartment	271	Engine oil additives	286
Replacing bulbs	247	Auxiliary fuse box in front		Air conditioning refrigerant	286
Bulbs	247	passenger footwell.....	272	Brake fluid.....	286
Replacing bulbs for front lamps....	249			Premium unleaded gasoline	286
Replacing bulbs for rear lamps.....	251			Fuel requirements.....	287
Adjusting headlamp aim	253			Gasoline additives.....	287
				Coolants	287

Anticorrosion/antifreeze.....	288	
Windshield and headlamp washer system.....	290	Technical terms 293
Windshield and headlamp washer fluid mixing ratio.....	290	
Consumer information.....	291	Index 299
Uniform tire quality grading	291	
Temperature	292	

Product information

Please observe the following in your own best interest:

We recommend using Mercedes-Benz original parts as well as conversion parts and accessories explicitly approved by us for your vehicle model.

We have tested these parts to determine their reliability, safety and their special suitability for Mercedes-Benz vehicles.

We are unable to make an assessment for other products and therefore cannot be held responsible for them, even if in individual cases an official approval or authorization by governmental or other agencies should exist. Use of such parts and accessories could adversely affect the safety, performance or reliability of your vehicle. Please do not use them.

Mercedes-Benz original parts as well as conversion parts and accessories approved by us are available at your authorized Mercedes-Benz Light Truck Center where you will receive comprehensive information, also on permissible technical modifications, and where proper installation will be performed.

Operator's Manual

Operator's Manual

This Operator's Manual contains a great deal of useful information. We urge you to read it carefully and familiarize yourself with the vehicle before driving.

For your own safety and longer service life of the vehicle, we urge you to follow the instructions and warnings contained in this manual. Ignoring them could result in damage to the vehicle or personal injury to you or others. Vehicle damage caused by failure to follow instructions is not covered by the Mercedes-Benz Limited Warranty.

Your vehicle may have some or all of the equipment described in this manual. Therefore, you may find explanations for optional equipment not installed in your vehicle. If you have any questions about the operation of any equipment, your authorized Mercedes-Benz Light Truck Center will be glad to demonstrate the proper procedures.

We continuously strive to improve our product, and ask for your understanding that we reserve the right to make changes in design and equipment. Therefore, information, illustrations and descriptions in this Operator's Manual might differ from your vehicle.

Optional equipment is also described in this manual, including operating instructions wherever necessary. Since they are special-order items, the descriptions and illustrations herein may vary slightly from the actual equipment of your vehicle.

If there are any equipment details that are not shown or described in this Operator's Manual, your authorized Mercedes-Benz Light Truck Center will be glad to inform you of correct care and operating procedures.

The Operator's Manual and Service Booklet are important documents and should be kept with the vehicle.

Service and warranty information

The Service and Warranty Information Booklet contains detailed information about the warranties covering your Mercedes-Benz, including:

- New Light Truck Limited Warranty,
- Emission System Warranty,
- Emission Performance Warranty,
- California, Maine, Massachusetts, and Vermont Emission Control System Warranty (California, Maine, Massachusetts, and Vermont only),
- State Warranty Enforcement Laws (Lemon Laws).

Important notice for California retail buyers and lessees of Mercedes-Benz automobiles

Under California law you may be entitled to a replacement of your vehicle or a refund of the purchase price or lease price, if Mercedes-Benz USA, LLC and / or its authorized repair or service facilities fail to fix one or more substantial defects or malfunctions in the vehicle that are covered by its express warranty after a reasonable number of repair attempts. During the period of 18 months from original delivery of the vehicle or the accumulation of 18 000 miles (approx. 29 000 km) on the odometer of the vehicle, whichever occurs first, a reasonable number of repair attempts is presumed for a retail buyer or lessee if one or more of the following occurs:

- (1) the same substantial defect or malfunction results in a condition that is likely to cause death or serious bodily injury if the vehicle is driven, that defect or malfunction has been subject to repair two or more times, and you have directly notified Mercedes-Benz USA, LLC in writing of the need for its repair,
- (2) the same substantial defect or malfunction of a less serious nature than category (1) has been subject to repair four or more times and you have directly notified us in writing of the need for its repair, or
- (3) the vehicle is out of service by reason of repair of the same or different substantial defects or malfunctions for a cumulative total of more than 30 calendar days. Written notification should be sent to us, not a dealer, at Mercedes-Benz USA, LLC, Customer Assistance Center, One Mercedes Drive, Montvale, NJ 07645-0350.

Maintenance

The Service Booklet describes all the necessary maintenance work which should be performed at regular intervals.

Always have the Service Booklet with you when you take the vehicle to your authorized Mercedes-Benz Light Truck Center for service. The service advisor will record each service in the booklet for you.

Roadside Assistance

The Mercedes-Benz Roadside Assistance Program provides factory-trained technical help in the event of a breakdown. Calls to the toll-free Roadside Assistance number

1-800-FOR-MERcedes (in the USA)
1-800-387-0100 (in Canada)

will be answered by Mercedes-Benz Customer Assistance Representatives 24 hours a day, 365 days a year.

Roadside Assistance will be provided in accordance with standard program guidelines which include providing service to the

vehicle up to a reasonable distance from a paved roadway. We will make every effort to assist in a breakdown situation, however, the accessibility of your vehicle will be determined by our authorized Mercedes-Benz Light Truck Center technician or the tow service provider on a case-by-case basis and may be a factor in our ability to respond.

Additional charges may be applicable for a breakdown location determined not to be a reasonably accessible roadside location as determined by our authorized technician and tow service provider.

For additional information refer to the Mercedes-Benz Roadside Assistance Program brochure in your glove box.

Change of address or ownership

If you change your address, be sure to send in the "Change of Address Notice" found in the Service and Warranty Information Booklet, or simply call the Mercedes-Benz Customer Assistance Center (in the USA) at 1-800-FOR-MER-Cedes, or Customer Service (in Canada) at 1-800-387-0100. It is in your own interest that we can contact you should the need arise.

If you sell your Mercedes, please leave all literature with the vehicle to make it available to the next operator.

If you bought this vehicle used, be sure to send in the "Notice of Purchase of Used Car" found in the Service and Warranty Information Booklet, or call the Mercedes-Benz Customer Assistance Center (in the USA) at 1-800-FOR-MERcedes, or Customer Service (in Canada) at 1-800-387-0100.

Operating your vehicle outside the USA or Canada

If you plan to operate your vehicle in foreign countries, please be aware that:

- Service facilities or replacement parts may not be readily available,
- unleaded gasoline for vehicles with catalytic converters may not be available; the use of leaded fuels will damage the catalyts,
- gasoline may have a considerably lower octane rating, and improper fuel can cause engine damage.

Warning!



This Sport Utility Vehicle is designed for both on-road and off-road use. It can go places and perform tasks for which conventional 2-wheel drive passenger cars were not intended. This vehicle will handle and maneuver differently from conventional passenger cars in driving conditions which may occur on streets, highways and off-road use.

This vehicle has a higher ground clearance and a higher center of gravity than many passenger cars. As with other vehicles of this type, if you make sharp turns at excessive speeds or abrupt maneuvers, the vehicle may roll over or may go out of control and crash. Utility vehicles have a significantly higher rollover rate than other types of vehicles. Failure to operate this vehicle safely may result in an accident, rollover of the vehicle, and severe or fatal injury.

Before you start to drive this vehicle, read the Operator's Manual. Take time to become familiar with the driving characteristics of this vehicle. Be sure you are familiar with all vehicle controls. Learn how your vehicle handles on different road surfaces. Do not attempt sharp turns at excessive speeds or abrupt maneuvers or other unsafe driving actions that can cause loss of vehicle control. When driving off-road or working the vehicle hard, do not overload it. And, always wear your seat belts at all times. In a rollover crash, an unbelted person is significantly more likely to die than a person wearing a seat belt.

Where to find it

This Operator's Manual is designed to provide comprehensive support information for you, the vehicle operator. Each section has its own reference color so you can find information quickly.

At a glance

Here you will find an overview of all the controls that can be operated from the driver's seat.

Getting started

Here you will find all the information you need for your first drive. You should read this section first if this is your first Mercedes-Benz vehicle or if you are renting or borrowing this vehicle.

Safety and Security

Here you will find descriptions of the safety features of your vehicle.

Controls in detail

Here you will find detailed information about the equipment installed on your vehicle. This section expands on the "Getting started" section and also describes technical innovations. If you are already familiar with the basic functions of your vehicle, this section will be of particular interest to you.

Operation

Here you will find all the information you need for the proper operation of your vehicle.

Practical hints

This section provides fast assistance for dealing with problems you may encounter.

Technical data

All important technical data for your vehicle can be found in this section.

Indexes

The glossary provides explanations of the most important technical terms.

The table of contents and the index are designed to help you find information quickly and easily.

The following publications are part of your vehicle documentation:

- this Operator's Manual
- the Service Booklet

Separate operating instructions will be provided as required depending on the equipment options installed in your vehicle.

Symbols

Symbols

The following symbols are found in this Operator's Manual:

- * Optional equipment is identified with an asterisk. Since standard equipment varies between models, the descriptions and illustrations in this manual may differ slightly from the actual equipment of your vehicle.

Warning!



Warning notices draw your attention to hazards that may endanger your health or life, or the health or life of others.



Highlights hazards that may result in damage to your vehicle.



Helpful hints or further information you may find useful.

- ▶ This symbol points to instructions for you to follow.
- ▶ A number of these symbols appearing in succession indicates a multiple-step procedure.
- ▷ Page This symbol tells you where to look for further information on a topic.
- ▷▷ This continuation symbol marks an interrupted procedure which will be continued on the next page.
- > In the glossary of technical terms, this symbol is used to cross-reference term definitions.
- Display Words appearing in the multi-function display are printed in the type shown here.

Operating safety

Warning!



Work improperly carried out on electronic components and associated software could cause them to cease functioning. Because the vehicle's electronic components are interconnected, any modification made may produce an undesired effect on other systems.

Electronic system malfunctions could seriously impair the operating safety of your vehicle.

Ensure that any repairs or modifications to electronic components are carried out by an authorized Mercedes-Benz Light Truck Center.

Other improper work or modifications on the vehicle could also have a negative impact on the operating safety of the vehicle.

Some safety systems only function while the engine is running. You should therefore never turn off the engine while driving.

Proper use of the vehicle

Proper use of the vehicle requires that you are familiar with the following information and rules:

- the safety precautions in this manual
- the “Technical data” section in this manual
- traffic rules and regulations
- motor vehicle laws and safety standards

Problems with your vehicle

Problems with your vehicle

If you should experience a problem with your vehicle, particularly one that you believe may affect its safe operation, we urge you to immediately contact your authorized Mercedes-Benz Light Truck Center to have the problem diagnosed and corrected if required. If the matter is not handled to your satisfaction, please discuss the problem with the Mercedes-Benz Light Truck Center management, or if necessary contact us at one of the following addresses:

In the USA:

Customer Assistance Center
Mercedes-Benz USA, LLC
One Mercedes Drive
Montvale, NJ 07645-0350

In Canada:

Customer Relations Department
Mercedes-Benz Canada, Inc.
849 Eglinton Avenue East
Toronto, Ontario, M4G 2L5

Reporting safety defects

For the USA only:

The following text is published as required of manufacturers under Title 49, Code of U.S. Federal Regulations, Part 575 pursuant to the “National Traffic and Motor Vehicle Safety Act of 1966”.

Reporting safety defects

If you believe that your vehicle has a defect which could cause a crash or could cause injury or death, you should immediately inform the National Highway Traffic Safety Administration (NHTSA) in addition to notifying Mercedes-Benz USA, LLC.

If NHTSA receives similar complaints, it may open an investigation, and if it finds that a safety defect exists in a group of vehicles, it may order a recall and remedy campaign. However, NHTSA cannot become involved in individual problems between you, your dealer, or Mercedes-Benz USA, LLC.

To contact NHTSA, you may either call the Auto Safety Hotline toll-free at 1-888-327-4236 (or 366-0123 in Washington, D.C. area) or write to: NHTSA, U.S. Department of Transportation, Washington, D.C. 20590. You can also obtain other information about motor vehicle safety from the Hotline.

At a glance

Cockpit

Instrument cluster

Center console

Overhead control panel



At a glance

Cockpit

Cockpit

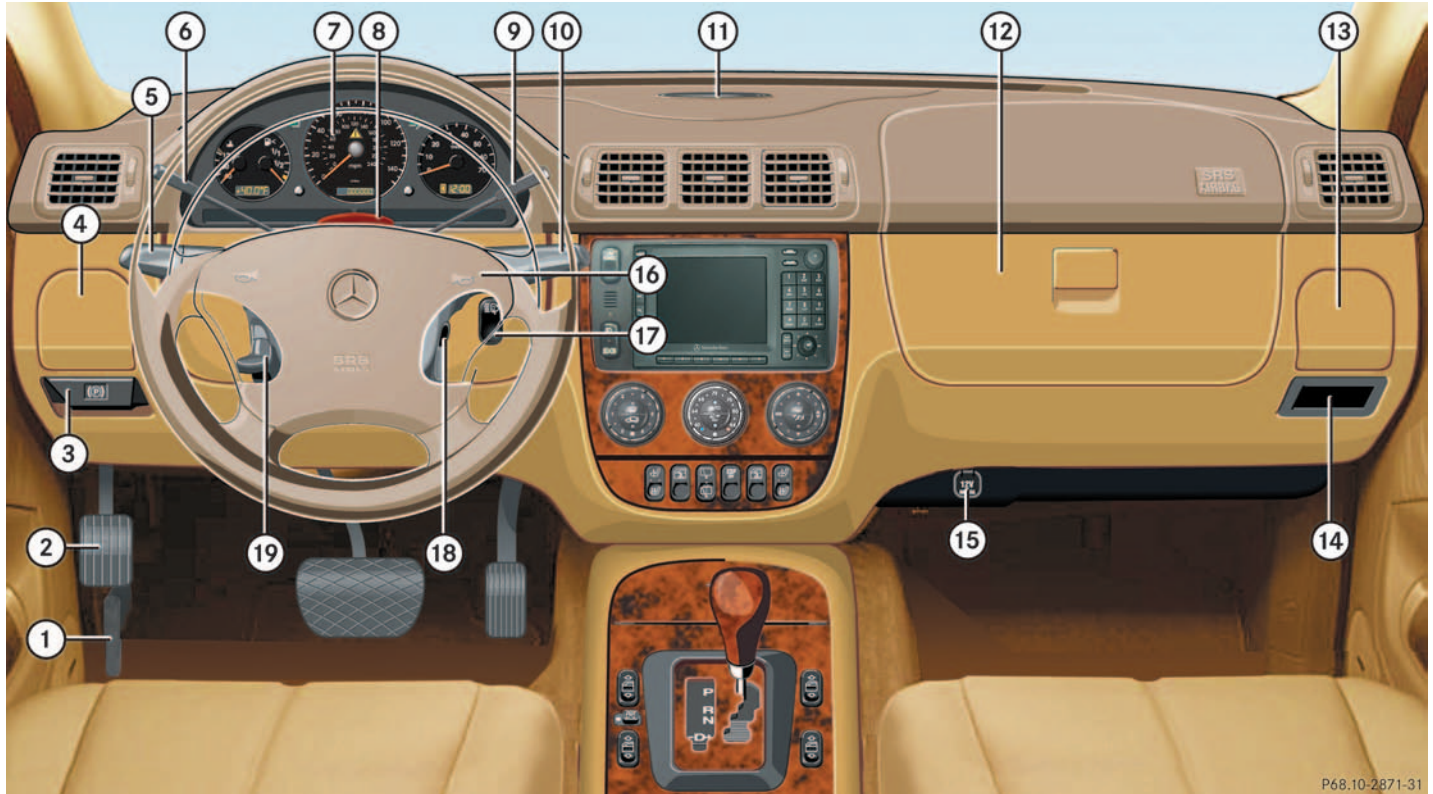

P68.10-2871-31

Item	Page
1 Hood lock release	202
2 Parking brake pedal	50
3 Parking brake release	50
4 Left cup holder	154
5 Combination switch	46
• Turn signals	
• High beam	
6 Cruise control lever	146
7 Instrument cluster	110
8 Hazard warning flasher switch	106
9 Lever for voice control system*, see separate operating instructions	

Item	Page
10 Windshield wiper/washer switch	122
11 Front Parktronic* warning indicator	150
12 Glove box	152
13 Right cup holder	154
14 Storage compartment	
15 Electrical outlet	158
16 Horn	
17 Headlamp washer button*	121
18 Steering lock with ignition	33
19 Steering wheel adjustment stalk	37



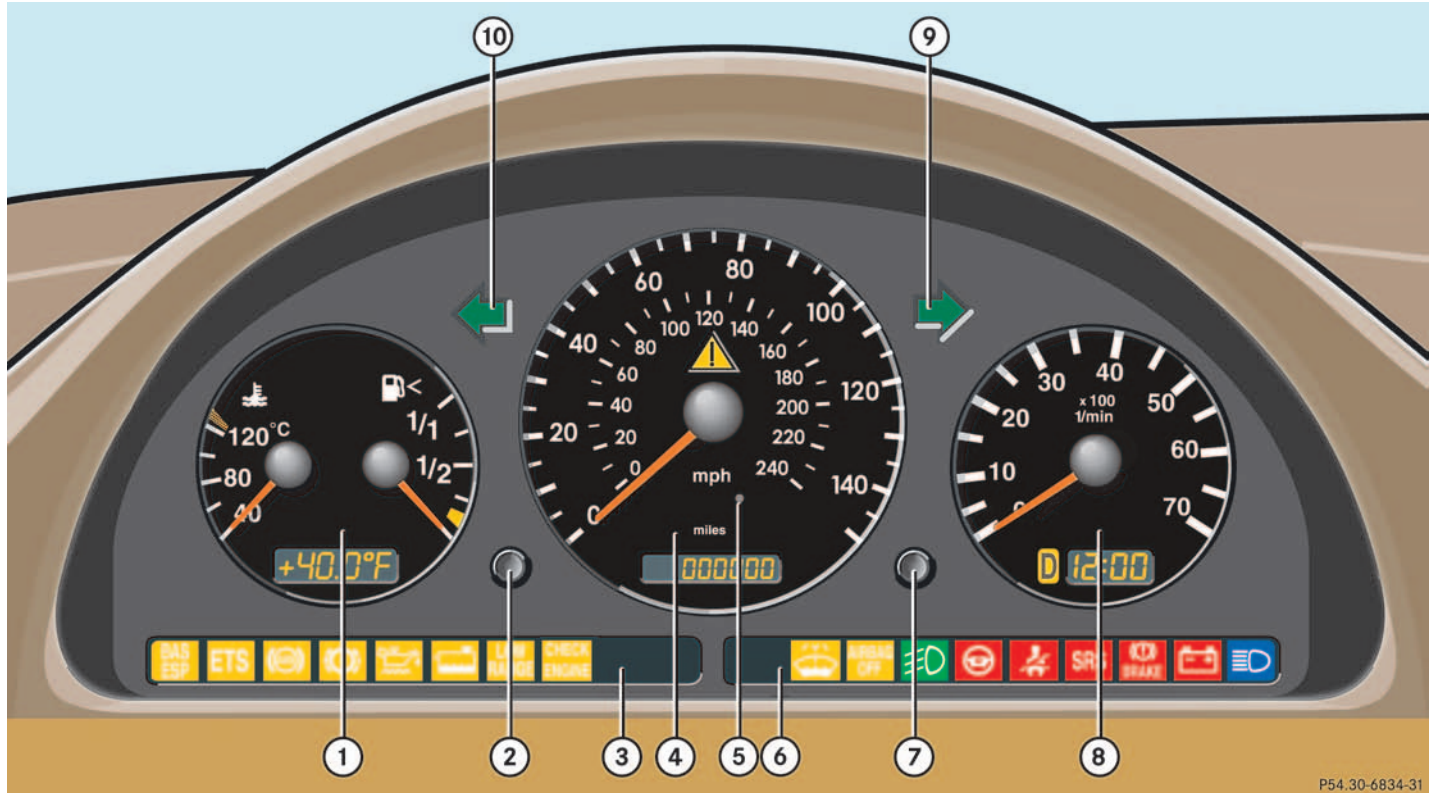

Instrument cluster





Instrument cluster





P54.30-6834-31







Item	Page
1 Gauge for	
Coolant temperature	111
Outside temperature	112
Fuel with fuel reserve warning lamp	233
2 Knob for	
Activating instrument cluster	110
Adjusting intensity of instrument lamps	110
Main odometer	111
Trip odometer read-out/reset	112
Flexible Service System (FSS)	215



Item	Page
3 Left indicator lamps with:	
 Brake Assist System (BAS)/Electronic Stability Program (ESP) malfunction warning lamp	225
 Electronic Traction System (4-ETS) malfunction indicator lamp	226
 Antilock Brake System (ABS) malfunction indicator lamp	225
 Brake pad wear indicator lamp	234
 Low engine oil level warning lamp	229

Item	Page
 Low engine coolant level warning lamp	230
 Low range indicator lamp	226
 Engine malfunction indicator lamp	232
4 Speedometer with:	
 4-ETS (Electronic Traction System)/Electronic Stability Program (ESP) warning lamp	224
Trip/main odometer	111
Flexible Service System (FSS)	215
Engine oil level indicator	204

Instrument cluster

	Item	Page
5	Photo sensor (adjusts the brightness of the digital displays located in 1, 4 and 8)	
6	Right indicator lamps with:	
	 Low wind-shield/headlamp washer system fluid level warning lamp	234
	 Front passenger air-bag switched off	232
	 Front fog lamp switched on	105

	Item	Page
	 Steering wheel adjustment not locked	229
	 Seat belt nonusage warning lamp	234
	 Supplemental Restraint System (SRS) indicator	227
	 Brake warning lamp	228
	 Charge indicator lamp	229
	 High beam headlamp switched on	233
		47

	Item	Page
7	Knob for setting clock	112
8	Tachometer with:	
	Selector lever position	114
	Clock	112
9	 Turn signal indicator lamp right	
10	 Turn signal indicator lamp left	

Center console

Upper part

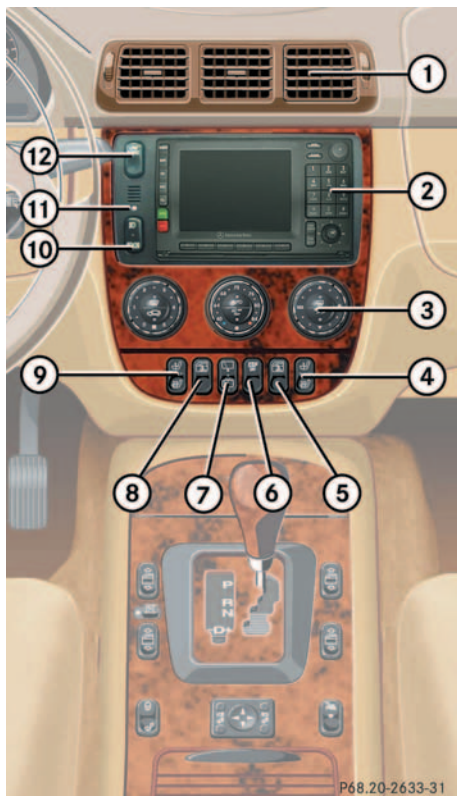

P68.20-2633-31

	Item	Page
1	Air outlets, automatic climate control	132
2	MCS, see separate operating instructions	
3	Automatic climate control	124
	Rear window defroster switch	131
4	Seat heater switch*, passenger side	91
5	Rear quarter window switch*, right	136
6	ESP control switch	75

	Item	Page
7	Rear window wiper/washer switch	123
8	Rear quarter window switch*, left	136
9	Seat heater switch*, driver's side	91
10	Front and rear fog lamp switch	105
11	Indicator lamp for antitheft alarm system	78
12	Transmission control switch, LOW RANGE mode	118

Center console

Lower part

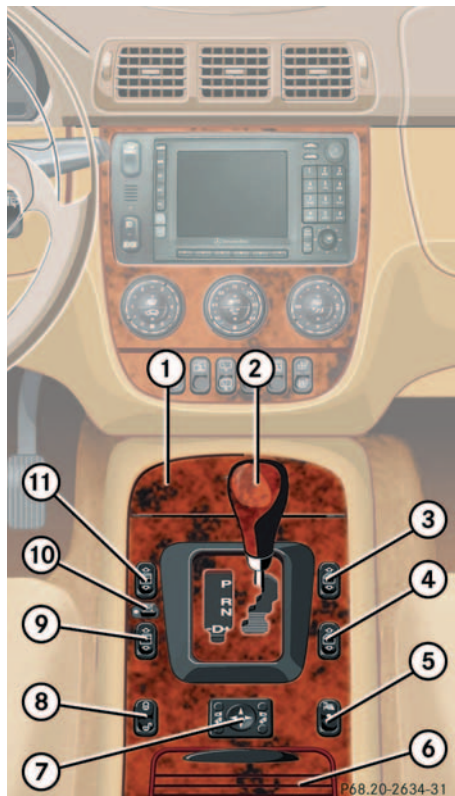

	Item	Page
1	Ashtray with cigarette lighter	156
2	Selector lever for automatic transmission	44
3	Power window switch, right front door	134
4	Power window switch, right rear door	134
5	Parking assist* (Parktronic) deactivation switch	149
6	Storage compartment with cup holder	154

	Item	Page
7	Exterior rear view mirror adjustment switch	38
	Exterior rear view mirror electrically folding*	120
8	Central locking switch	89
9	Power window switch, left rear door	134
10	Switch for rear door window override	69
11	Power window switch, left front door	134

Overhead control panel

Overhead control panel

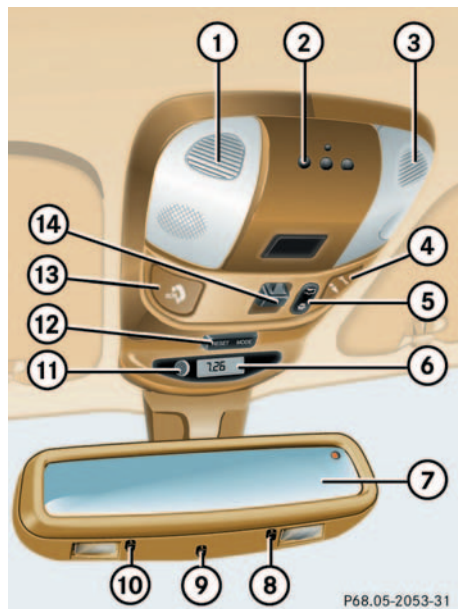

	Item	Page
1	Front left interior lighting	107
2	Signal transmitter keys for garage door opener	168
3	Front right interior lighting	107
4	Roadside Assistance button	163
	Information button	165
5	Interior lighting control	107
6	Trip computer* display	172
7	Rear view mirror	119

	Item	Page
8	Right reading lamp on/off	108
9	Automatic antiglare function* on/off	119
10	Left reading lamp on/off	108
11	Glass breakage sensor	79
12	Trip computer* control	172
	Tow-away alarm switch	80
13	Tele Aid (emergency call system) button	163
14	Sliding/pop-up roof* switch	137

Getting started

Unlocking

Adjusting

Driving

Parking and locking



Unlocking

The “Getting started” section provides an overview of the vehicle’s most basic functions. First-time Mercedes-Benz owners should pay special attention to the information given here.



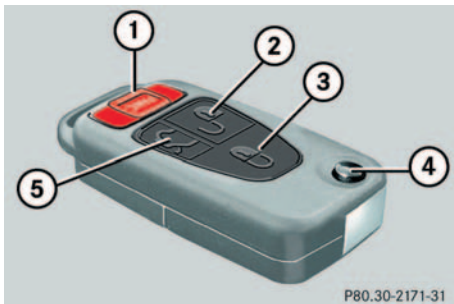

If you are already familiar with the basic functions described here, the “Controls in detail” section will help you with further information. The corresponding page references are at the end of each segment.

Unlocking

Remote control with folding key



Remote control with folding key

- 1 **PANIC** Panic button (▷ page 70)
- 2  Unlock button
- 3  Lock button
- 4  Release button for key
- 5  Unlock button for liftgate

- ▶ Press unlock button  on the remote control.

The indicator lamps light up for a short time. The locking knobs in the doors move up.

- ▶ Press release button **4** on the remote control.
The key folds out.
- ▶ Get in the vehicle and insert the key in the steering lock (▷ page 33).

More information can be found in the “Controls in detail” section (▷ page 84).

Steering lock positions

Warning!



When leaving the vehicle always remove the key from the steering lock and lock the vehicle. Do not leave children unattended in the vehicle, or with access to an unlocked vehicle. Unsupervised use of vehicle equipment may cause an accident and/or serious personal injury.

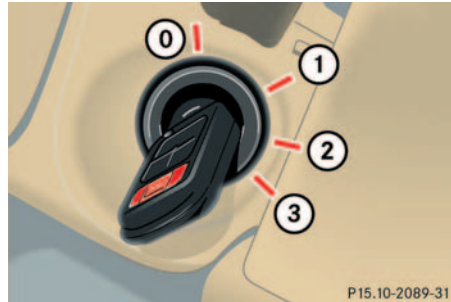

Steering lock

0 For removing key

The steering is locked when the key is removed from the steering lock. If necessary, move steering wheel slightly to allow the locking mechanism to engage.

- 1** Unlocking steering. Power supplies to some electrical consumers, such as seat adjustment
- 2** Ignition (power supply for all electrical consumers) and driving position (selector lever is unlocked)
- 3** Starting position



To prevent accelerated battery discharge and a possible dead battery, always remove the key from the steering lock.



The key can only be withdrawn in position **0**.

If necessary, move steering wheel slightly to allow the key to be turned clockwise to position **1**.

A warning sounds when the driver's door is opened and the key is in steering lock position **0** or **1**.

More information can be found in the "Controls in detail" section (▷ page 84).

Adjusting Adjusting

Warning!



All seat, head restraint, steering wheel, and rear view mirror adjustments, as well as fastening of seat belts, must be done before the vehicle is put into motion.

Seats

Depending on the vehicle's equipment, you can adjust the seats manually or electrically.

Warning!



Do not adjust the driver's seat while driving. Adjusting the seat while driving could cause the driver to lose control of the vehicle.

Never ride in a moving vehicle with the seat back reclined. Sitting in an excessively reclined position can be dangerous. You could slide under the seat belt in a collision. If you slide under it, the belt would apply force at the abdomen or neck.

That could cause serious or fatal injuries. The seat back and seat belts provide the best restraint when the wearer is in an upright position and belts are properly positioned on the body. Your seat must be adjusted so that you can correctly fasten your seat belt (▷ page 40).

Never place hands under the seat or near any moving parts while a seat is being adjusted.

Warning!



When leaving the vehicle always remove the key from the steering lock and lock your vehicle.

Do not leave children unattended in the vehicle or with access to an unlocked vehicle. Unsupervised use of vehicle equipment may cause an accident and/or serious personal injury.

Warning!



Children 12 years old and under must never ride in the front seat, except in a Mercedes-Benz authorized BabySmart™ compatible child seat, which operates with the BabySmart™ system installed in the vehicle to deactivate the passenger side front airbag when it is properly installed. Otherwise they will be struck by the airbag when it inflates in a crash. If this happens, serious or fatal injury will result.

According to accident statistics, children are safer when properly restrained in the rear seating positions than in the front seating positions. Infants and small children must ride in back seats and be seated in an appropriate infant or child restraint system, which is properly secured with the vehicle's seat belt and top tether strap, or secured via lower anchors and top tether strap, fully in accordance with the child seat manufacturer's instructions.

A child's risk of serious or fatal injuries is significantly increased if the child restraints are not properly secured in the vehicle and the child is not properly secured in the child restraint.

Adjusting manual seats



- 1 Seat height
- 2 Seat fore and aft adjustment
- 3 Backrest tilt
- 4 Head restraint height

Seat height

- ▶ Raise lever 1.
- ▶ The seat moves downward.
- ▶ Lean forward to raise the seat.



If necessary, hold onto the steering wheel while adjusting the seat height in order to take weight off the seat.

- ▶ Release lever 1.

Seat fore and aft adjustment

- ▶ Lift handle 2.
- ▶ Slide seat to desired position.

Adjust a comfortable seating position that still allows you to reach the accelerator/brake pedal safely. The position should be as far rearward as possible, consistent with ability to properly operate controls.

- ▶ Release handle 2.

The seat must be properly engaged.

Adjusting

Backrest tilt

- ▶ Turn handwheel **3** until your hands are slightly angled when holding the steering wheel.

Head restraint height

Warning!



For your protection, drive only with properly positioned head restraints.

Adjust head restraint to support the back of the head approximately at ear level.

Do not drive the vehicle without the seat head restraints. Head restraints are intended to help reduce injuries during an accident.

- ▶ Pull up or push down on head restraint until it is in desired position.

Head restraint tilt

- ▶ Manually adjust the angle of the head restraint. Push or pull on the lower edge of the head restraint cushion.

Adjusting power seats*

Warning!



The power seats can also be operated with the appropriate door open. Do not leave children unattended in the vehicle, or with access to an unlocked vehicle. Unsupervised use of vehicle equipment may cause an accident and/or serious personal injury.

The seat adjustment switch is located on the entry side of each front seat base.

- ▶ Switch on the ignition by turning the key in the steering lock to position **2** (▶ page 33).

All the lights in the instrument cluster light up.

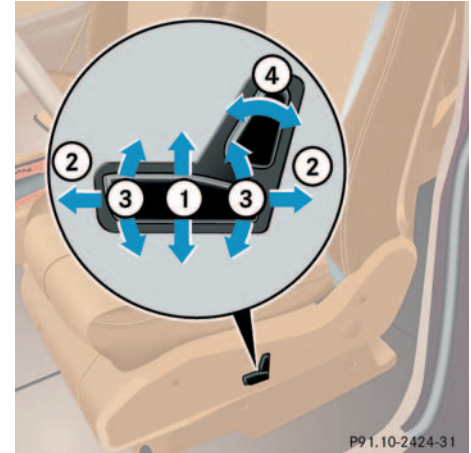

- 1 Seat height
- 2 Seat fore and aft adjustment
- 3 Seat cushion tilt
- 4 Backrest tilt

Seat height

- ▶ Press the switch up or down in the direction of arrow **1**.

Seat fore and aft adjustment

- ▶ Press the switch forward or backward in the direction of arrow **2** until you can comfortably press the pedals all the way to the floor.

Seat cushion tilt

- ▶ Press the switch up or down in the direction of arrow **3** until your upper legs are lightly supported.

Backrest tilt

- ▶ Press the switch forward or backward in the direction of arrow **4** until your hands are slightly angled when holding the steering wheel.



With the front door open, the seats can still be adjusted approx. 30 minutes after the ignition has been turned off.

Head restraint height**Warning!**

For your protection, drive only with properly positioned head restraints.

Adjust head restraint to support the back of the head approximately at ear level.

Do not drive the vehicle without the seat head restraints. Head restraints are intended to help reduce injuries during an accident.

- ▶ Pull up or push down on head restraint until it is in desired position.

Head restraint tilt

- ▶ Manually adjust the angle of the head restraint. Push or pull on the lower edge of the head restraint cushion.

More information can be found in the “Controls in detail” section (▷ page 91).

Steering wheel**Warning!**

Do not adjust the steering wheel while driving. The steering wheel must be locked while driving. Adjusting the steering wheel while driving, or driving without the steering column locked could cause the driver to lose control of the vehicle.

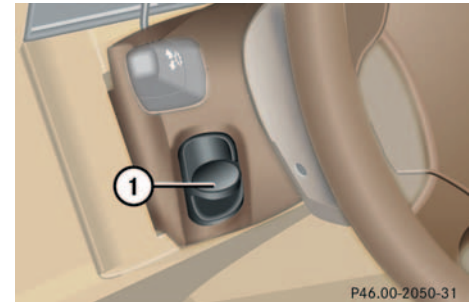

1 Lever

P46.00-2050-31

Adjusting

- ▶ Move lever **1** to its stop down.
- ▶ Move steering wheel up or down to desired position.
- ▶ Move lever **1** to its stop up.
The steering column is locked.



If the indicator lamp  (▷ page 26) comes on while the engine is running, the steering column is not locked properly.

Mirrors

Adjust the inside and exterior rear view mirrors before driving so that you have a good view of the road and traffic conditions.

Warning!



In the case of an accident, liquid electrolyte may escape the mirror housing if the mirror glass breaks.

Electrolyte has an irritating effect. Do not allow the liquid to come into contact with eyes, skin, clothing, or the respiratory system. In case it does, immediately flush affected area with water, and seek medical help if necessary.

Inside rear view mirror

- ▶ Manually adjust the inside rear view mirror.

Exterior rear view mirrors

Warning!



Exercise care when using the passenger side exterior rear view mirror. The mirror surface is convex (outwardly curved surface for a wider field of view). Objects in mirror are closer than they appear. Check your inside rear view mirror or glance over your shoulder before changing lanes.



Electrolyte drops coming into contact with the vehicle paint finish can only be completely removed while in their liquid state and by applying plenty of water.

The buttons are on the lower part of the center console.



- 1 Driver's side mirror
- 2 Passenger side mirror
- 3 Adjustment button

- ▶ Switch on the ignition by turning the key in the steering lock to position **2** (▷ page 33)
All the lights in the instrument cluster light up.
- ▶ Press button **1** for the left mirror or button **2** for the right mirror.
- ▶ Push adjustment button **3** up, down, left or right according to the setting desired.



With the front doors closed, the exterior mirrors can still be adjusted approx. 30 minutes after the ignition has been turned off.

At low outside temperatures, the exterior mirrors will be automatically heated.

More information can be found in the “Controls in detail” section (▷ page 119).

Driving

Driving

Warning!



Do not lay any objects in the driver's footwell. Be careful that floor mats or carpets in the driver's footwell have sufficient clearance for the pedals.

During sudden driving or braking maneuvers the objects could get caught between the pedals. You could then no longer brake or accelerate.

Fastening the seat belts

Warning!



Always fasten your seat belt before driving off. Always make sure your passengers are properly restrained, even those sitting in the rear and pregnant women.

Failure to wear and properly fasten and position your seat belt greatly increases your risk of injuries and their likely severity in an accident. You and your passengers should always wear seat belts.

If you are ever in an accident, your injuries can be considerably more severe without your seat belt properly buckled. Without your seat belt buckled, you are much more likely to hit the interior of the vehicle or be ejected from it. You can be seriously injured or killed.

In the same crash, the possibility of injury or death is lessened if you are wearing your seat belt. The airbags can only protect as expected if the occupants are using their seat belts (▷ page 54).

Warning!



Children 12 years old and under must never ride in the front seat, except in a Mercedes-Benz authorized BabySmart™ compatible child seat, which operates with the BabySmart™ system installed in the vehicle to deactivate the passenger front airbag when it is properly installed. Otherwise they will be struck by the airbag when it inflates in a crash. If this happens, serious or fatal injury will result.

According to accident statistics, children are safer when properly restrained in the rear seating positions than in the front seating positions. Infants and small children must ride in back seats and be seated in an appropriate infant or child restraint system, which is properly secured with the vehicle's seat belt and top tether strap, or secured via lower anchors and top tether strap, fully in accordance with the child seat manufacturer's instructions.

A child's risk of serious or fatal injuries is significantly increased if the child restraints are not properly secured in the vehicle and the child is not properly secured in the child restraint.

Warning!

Never ride in a moving vehicle with the backrest reclined. Sitting in an excessively reclined position can be dangerous. You could slide under the seat belt in a collision. If you slide under it, the belt would apply force at the abdomen or neck. That could cause serious or even fatal injuries. The backrest and seat belt provide the best restraint when the wearer is in an upright position and the belt is properly positioned on the body.

Warning!

Never let more people ride in the vehicle than there are seat belts available. Be sure everyone riding in the vehicle is correctly restrained with a separate seat belt.

Warning!

Read and observe the additional warning notices printed in the "Safety and Security" section (▷ page 57) and (▷ page 60).



- 1 Latch plate
- 2 Buckle
- 3 Release button
- 4 Seat belt housing

Driving

- ▶ With a smooth motion, pull the belt from seat belt housing **4**.
 - ▶ Place the belt over your shoulder.
 - ▶ Push latch plate **1** into buckle **2** until it clicks.
 - ▶ If necessary, tighten the lap portion to a snug fit by pulling shoulder portion up.
 - ▶ If necessary, adjust the seat belt to the correct height (▷ page 43).
- Position the lap belt as low as possible on your hips (over hip joint) and not across the abdomen.
 - Place the seat backrest in a nearly upright position.
 - Each seat belt should never be used for more than one person at a time.
 - Do not fasten a seat belt around a person and another object at the same time.
 - Check your seat belt during travel to ensure that it is properly positioned.
 - Ensure that the seat belt is always fitted snugly. You should avoid wearing bulky clothing, such as winter coats, when traveling in the vehicle.

Proper use of seat belts:

- Do not twist the belt when fastening.
- Adjust the seat belt so that the shoulder portion is located as close as possible to the middle of the shoulder (it should not touch the neck or pass under the arm).

Warning!



Do not pass belts over sharp edges. They could tear.

Do not allow the belt to get caught in the door or in the seat adjustment mechanism. This could damage the belt.

Never attempt to make modifications to seat belts. This could impair the effectiveness of the belts.

Damaged seat belts or belts that were highly stressed in an accident must be replaced by an authorized Mercedes-Benz Light Truck Center.

Seat belt height adjustment

Seat belt height can be adjusted for the following seats:

- Driver's seat
- Passenger seat
- Outer rear seats

Adjust seat belt so that the shoulder portion is located as close as possible to the middle of the shoulder (it should not touch the neck or pass under the arm).

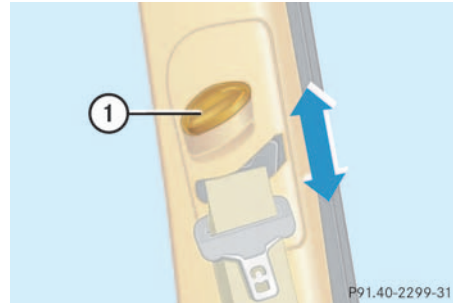

1 Release button

Adjusting seat belt higher

- ▶ Slide belt outlet upward.

The belt outlet engages in various positions.

Adjusting seat belt lower

- ▶ Press and hold release button 1.
- ▶ Slide belt outlet in desired position and let go of release button 1.

Starting the engine

Warning!



Inhalation of exhaust gas is hazardous to your health. All exhaust gas contains carbon monoxide, and inhaling it can cause unconsciousness and lead to death.

Do not run the engine in confined areas (such as a garage) which are not properly ventilated. If you think that exhaust gas fumes are entering the vehicle while driving, have the cause determined and corrected immediately. If you must drive under these conditions, drive only with at least one window fully open.

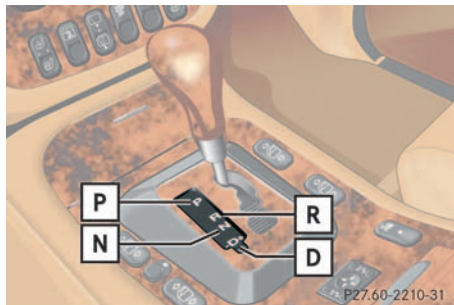

Gearshift pattern for automatic transmission

- P** Park position with selector lever lock
- R** Reverse gear
- N** Neutral
- D** Drive position

For more information on “Automatic transmission” (▷ page 113).

- ▶ Make sure that the gear selector lever is set to **P**.



Do not depress the accelerator.

- ▶ Turn the key in the steering lock to position **3** and hold until the engine starts (▷ page 33).
- ▶ Depress the brake pedal.
The selector lever lock is released.

For information on turning off the engine with the key, see “Turning off engine” (▷ page 51).

Starting difficulties



Ensure that the brake pedal is depressed when starting the engine.

If the engine does not start as described, carry out the following steps:

- ▶ Turn key in starter to position **0** and repeat starting procedure.

Remember that extended starting attempts can drain the battery.

- ▶ Get a jump start (▷ page 264).

If the engine does not start after several starting attempts, there could be a malfunction in the engine electronics or in the fuel supply system.

- ▶ Notify an authorized Mercedes-Benz Light Truck Center.

Parking brake

Warning!



When leaving the vehicle always remove the key from the steering lock and lock the vehicle. Do not leave children unattended in the vehicle, or with access to an unlocked vehicle. Children could release the parking brake, which could result in an accident and/or serious personal injury.

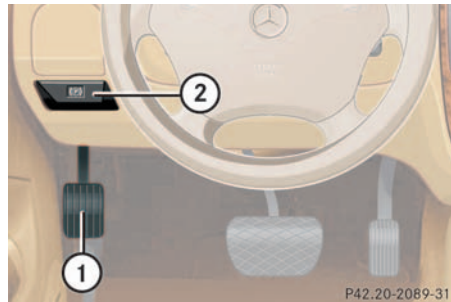

- 1 Parking brake pedal
- 2 Release handle

- ▶ Release the parking brake by pulling on handle **2**.

The indicator lamp  in the instrument cluster goes out.

Driving

- ▶ Place the gear selector lever in position **D** or **R**.



Wait for the gear selection process to complete before setting the vehicle in motion.

- ▶ Release the brake pedal.
- ▶ Carefully depress the accelerator pedal.

Driving



If you hear a warning signal when driving off, you have forgotten to release the parking brake.

Release the parking brake.

After a cold start the transmission engages at a higher revolution. This allows the catalytic converter to reach its operating temperature earlier.

Warning!



It is dangerous to shift the selector lever out of **P** or **N** if the engine speed is higher than idle speed. If your foot is not firmly on the brake pedal, the vehicle could accelerate quickly forward or in reverse. You could lose control of the vehicle and hit someone or something. Only shift into gear when the engine is idling normally and when your right foot is firmly on the brake pedal.

Warning!



On slippery road surfaces, never downshift in order to obtain braking action. This could result in drive wheel slip and reduced vehicle control. Your vehicle's ABS will not prevent this type of loss of control.

More information can be found in the "Operation" section (▷ page 177).

For information on off-road driving, see Driving instructions (▷ page 186).

Switching on headlamps

The combination switch is on the left of the steering column.

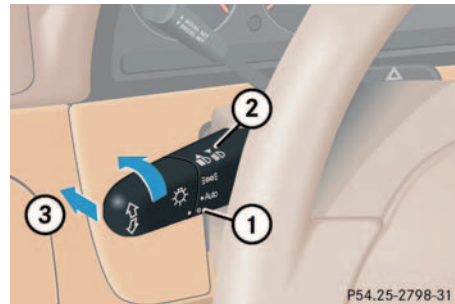

Combination switch

- 1 Off
- 2 Low beam headlamps on
- 3 High beam lamps on

► Turn the switch to . Low beam headlamps on.

High beam

- ▶ Push the exterior lamp switch forward.

The high beam symbol  in the instrument cluster lights up.

More information can be found in the “Controls in detail” section (▶ page 102)

Turn signals

The combination switch is on the left of the steering column.

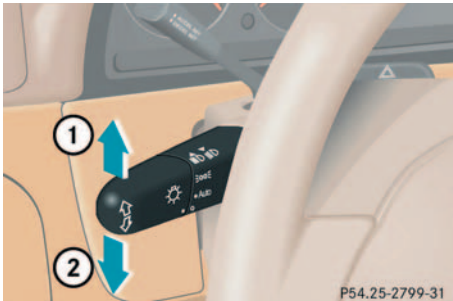

Combination switch

- 1 Turn signals, right
- 2 Turn signals, left

- ▶ Press the combination switch up **1** or down **2**.

The switch is automatically cancelled when the steering wheel is turned to a large enough degree.



To signal minor directional changes, move combination switch to point of resistance only and release. The turn signal blinks three times.

Windshield wipers

The combination switch is on the right of the steering column.

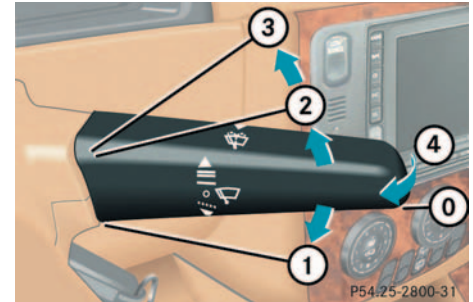

Wiper switch

- 0 Windshield wipers off
- 1 Intermittent wiping
- 2 Normal wiper speed
- 3 Fast wiper speed
- 4 Wiping with windshield wiper fluid

Driving

Switching on windshield wipers

- ▶ Make sure that the ignition is switched on.
- ▶ Turn the wiper switch to the desired position **1**, **2** or **3**, depending on the intensity of the rain.

Single wipe

- ▶ Press switch briefly in the direction of arrow **2**.

The windshield wipers wipe one time without washer fluid.

Wiping with windshield washer fluid

- ▶ Pull and hold wiper switch in direction of arrow **4**.

The windshield wiper operates with washer fluid.

More information on windshield wipers can be found in the “Controls in detail” section (▷ page 122).

Rear window wiper

The button is on the upper part on the center console.



- 1 Intermittent wiping
- 2 Indicator lamp
- 3 Wiping with washer fluid

Switching on intermittent wiping

Make sure that the ignition is switched on.

- ▶ Press upper half **1** of the button.

Switching off intermittent wiping

- ▶ Press upper half **1** of the button again.

Wiping with washer fluid

- ▶ Press and hold lower half **3** of the button.

After releasing the button the wiper operates for additional five seconds.

Problems while driving

The engine runs erratically and misfires

- An ignition cable may be damaged.
- The engine electronics may not be operating properly.
- Unburned gasoline may have entered the catalytic converter and damaged it.
- ▶ Give very little gas.
- ▶ Have the problem repaired by an authorized Mercedes-Benz Center as soon as possible.

The coolant temperature is over 248°F (120°C)

The coolant is too hot and is no longer cooling the engine.

- ▶ Stop the vehicle as soon as possible and turn off the engine. Allow engine and coolant to cool.
- ▶ Check the coolant level and add coolant if necessary (▶ page 206).

In case of accident

If the vehicle is leaking gasoline:

- ▶ Do not start the engine under any circumstances.
- ▶ Notify local fire and/or police authorities.

If the extent of the damage cannot be determined:

- ▶ Notify an authorized Mercedes-Benz Center.

If no damage can be determined on the

- major assemblies
- fuel system
- engine mount:
- ▶ Start the engine in the usual manner.

Parking and locking

Parking and locking

You have now completed your first drive. You have properly stopped and parked your vehicle. End your drive as follows.

Warning!



Wait until the vehicle is stationary before removing the key from the steering lock. The vehicle cannot be steered when the key is removed.

Warning!



With the engine not running, there is no power assistance for the steering system. In this case, it is important to keep in mind that a considerably higher degree of effort is necessary to steer the vehicle.

Warning!



Do not park this vehicle in areas where combustible materials such as grass, hay or leaves can come into contact with the hot exhaust system, as these materials could be ignited and cause a vehicle fire.

To reduce the risk of personal injury as a result of vehicle movement, before turning off the engine and leaving the vehicle always:

- Keep right foot on brake pedal.
- Firmly depress parking brake pedal.
- Move the selector lever to position **P**.
- Slowly release brake pedal.
- When parked on an incline, turn front wheel towards the road curb.
- Turn the key to starter switch position **0** and remove.
- Take the key and lock vehicle when leaving.

Parking brake

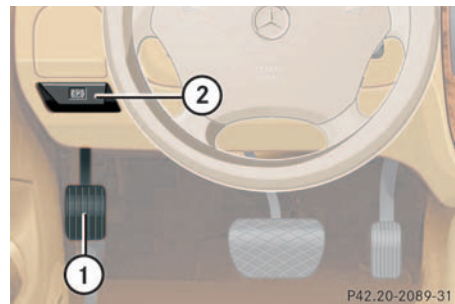

- 1 Parking brake
- 2 Release handle

- ▶ Step firmly on parking brake **1**.

When the engine is running, the indicator lamp  in the instrument cluster will be illuminated.

Warning!

When leaving the vehicle always remove the key from the steering lock and lock the vehicle. Do not leave children unattended in the vehicle, or with access to an unlocked vehicle. Children could release the parking brake and/or move the gear selector lever from position **P**, either of which could result in an accident and/or serious personal injury.

Warning!

Getting out of your vehicle with the selector lever not fully engaged in position **P** is dangerous. Also, when parked on an incline, position **P** alone may not prevent your vehicle from moving, possibly hitting people or objects.

Always set the parking brake in addition to shifting to position **P** (▷ page 50).

When parked on an incline, also turn front wheel towards the road curb.

Switching off headlamps

- ▶ Turn the combination switch to **1** (▷ page 46).

More information can be found in the “Controls in detail” section (▷ page 102).

Turning off engine

- ▶ Place the gear selector lever in **P**.
- ▶ Turn the key in the steering lock (▷ page 33) to position **O** and remove it.

The immobilizer is activated.



Always set the parking brake in addition to shifting to position **P**.



To prevent accelerated battery discharge and a possible dead battery, always remove the key from the steering lock.

Parking and locking



The key can only be removed from the steering lock with the gear selector lever in position **P**.

With the key removed and the driver's door open, a warning sounds if the vehicle's exterior lamps are not switched off.

- ▶ Press the seat belt release button (▷ page 40).
- ▶ Move the steering wheel slightly to allow the locking mechanism to engage.
- ▶ After exiting the vehicle press the lock button  on the remote control (▷ page 32).

The turn signals lamps blink three times and the locking knobs on the doors move down.

Warning!



To prevent possible personal injury, always keep hands and fingers away from the door openings when closing the doors. Be especially careful when small children are around.

Before closing doors, ensure that there is no possibility of someone getting caught in a door during closing.

More information on parking and locking can be found in the "Controls in detail" section (▷ page 84).

The image shows the front of a dark-colored Mercedes-Benz SUV. The Mercedes-Benz logo is prominent on the grille. The car is partially covered by a red protective cover on the left side. The background is a bright, slightly blurred outdoor setting.

Safety and Security

Occupant safety

Panic alarm

Driving and safety systems

Anti-theft systems

Occupant safety

Occupant safety

In this section you will learn the most important facts about the restraint systems of the vehicle.

The restraint systems are

- Seat belts
- Emergency tensioning device
- Airbags
- Child seats
- Child seat recognition
- Lower anchors and tethers for children (LATCH)

As independent systems their protective effects work in conjunction with each other.



For information on infants and children traveling with you in the vehicle and restraint systems for infants and children, see “Children in the vehicle” (> page 63).

The warning lamp **SRS** in the instrument cluster (> page 26) lights up for about 4 seconds when the key is turned to position **2**. It goes out when you start the engine. This shows that the restraint systems are operational.

If the lamp does not come on at all or if it fails to extinguish after approximately 4 seconds or if it comes on thereafter, a malfunction in the system has been detected.

More information can be found in the “Practical hints” section (> page 227).

Warning!



In the event that the SRS malfunction indicator lamp lights up during driving or does not come at all, the SRS may not be operational. For your safety, we strongly recommend that you visit an authorized Mercedes-Benz Light Truck Center immediately to have the system checked; otherwise the SRS may not be activated when needed in an accident, which could result in serious or fatal injury, or it might deploy unexpectedly and unnecessarily which could also result in injury.

Improper work on the restraint systems can lead to unintentional deployment or operational failure.

All work on these systems should therefore only be carried out by an authorized Mercedes-Benz Light Truck Center.

Airbags

Warning!



Airbags are designed to reduce the potential of injury in certain frontal (front airbags) impacts, or side (side impact and head protection window curtain airbags) impacts which may cause significant injuries. However, no system available today can totally eliminate injuries and fatalities.

The activation of the SRS temporarily releases a small amount of dust from the airbags. This dust, however, is neither injurious to your health, nor does it indicate a fire in the vehicle. The dust might cause some temporary breathing difficulty for people with asthma or other breathing trouble. To avoid this, you may wish to get out of the vehicle as soon as it is safe to do so. If you have any breathing difficulty but cannot get out of the vehicle after the airbag inflates, then get fresh air by opening a window or door.

Warning!



To reduce the risk of injury when the front airbags inflate, it is very important for the driver and passenger to always be in a properly seated position and to wear your seat belt.

For maximum protection in the event of a collision always be in normal seated position with your back against the backrest. Fasten your seat belt and ensure that it is properly positioned on your body (▷ page 40).

Since the airbag inflates with considerable speed and force, a proper seating and hands on steering wheel position will help to keep you at a safe distance from the airbag. Occupants who are unbelted, out of position or too close to the airbag can be seriously injured by an airbag as it inflates with great force in the blink of an eye:

- Sit properly belted in an upright position with your back against the backrest.

- Adjust the driver seat as far as possible rearward, still permitting proper operation of vehicle controls. The distance from the center of the driver's breastbone to the center of the airbag cover on the steering wheel must be at least ten inches (25 cm) or more. You should be able to accomplish this by a combination of adjustments to the seat and steering wheel. If you have any problems, please see your authorized Mercedes-Benz Light Truck Center.
- Do not lean with your head or chest close to the steering wheel or dashboard.
- Keep hands on the outside of steering wheel rim. Placing hands and arms inside the rim can increase the risk and potential severity of hand/arm injury when driver front airbag inflates.
- Adjust the passenger seat as far as possible rearward from the dashboard when the seat is occupied.



Occupant safety

- Occupants, especially children, should never lean their heads in the area of the door where the side impact airbag inflates. This could result in serious injuries or death should the airbag be triggered. Always sit upright, properly use the seat belts and appropriate size infant or child restraint system.
- Children 12 years old and under must never ride in the front seat, except in a Mercedes-Benz authorized BabySmart™ compatible child seat, which operates with the BabySmart™ system installed in the vehicle to deactivate the passenger side front airbag when it is properly installed. Otherwise they will be struck by the airbag when it inflates in a crash. If this happens, serious or fatal injury will result.

Failure to follow these instructions can result in severe injuries to you or other occupants.

If you sell your vehicle you are responsible to make the buyer aware of these points. Be sure to give the buyer this Operator's Manual.

Warning



Accident research shows that the safest place for children in an automobile is in the rear seat. Should you choose to place a child 12 years old or under in the passenger seat of your vehicle, you must properly use a BabySmart™ child restraint which will turn off the passenger side front airbag (▷ page 65). BabySmart™ will not, however, turn off any side impact airbag.

It should be noted that with respect to both front and rear side impact airbags there is a possibility for a side airbag related injury if occupants, especially children, are not properly seated or restrained when next to a side airbag which needs to deploy rapidly in a side impact in order to do its job.

To help avoid the possibility of injury, please follow these guidelines: (1) occupants, especially children, should never place their bodies or lean their heads in the area of the door where the side airbag inflates. This could result in serious injuries or death should the side airbag be activated; (2) always sit upright, properly use the seat belts and use an appropriately sized infant or child restraint system for all children 12 years old or under; and (3) always wear seat belts properly.

If you believe that, even with the use of these guidelines, it would be safer for your rear seat occupants to have both rear door mounted side airbags deactivated, then deactivation can be accomplished upon your written election to do so at your authorized Mercedes-Benz Light Truck Center at an additional cost. Please contact your local authorized Mercedes-Benz Light Truck Center or call our Customer Assistance Center at 1-800-FOR-MERCEdes (1-800-367-6372) for details.



Airbags are designed to activate only in certain frontal (front airbags) impacts, or side (side impact and head protection window curtain airbags) impacts which exceed preset thresholds.

Only during these types of impacts, if of sufficient severity to meet the deployment thresholds, will they provide their supplemental protection.

The driver and passenger should always wear their seat belts. Otherwise it is not possible for the airbags to provide their supplemental protection.

In cases of other frontal impacts, angled impacts, roll-overs, other side impacts, rear collisions, or other accidents, the airbags will not be activated. The driver and passengers will then be protected by the fastened seat belts.

We caution you not to rely on the presence of the airbags in order to avoid wearing your seat belt.

Your vehicle was originally equipped with airbags that are designed to activate in certain impacts exceeding a preset threshold to reduce the potential and severity of injury. It is important to your safety and that of your passenger that you replace deployed airbags and repair any malfunctioning airbags to ensure that the vehicle will continue to provide supplemental crash protection for occupants.

Safety guidelines for the seat belt, emergency tensioning device and airbag

Warning



- Damaged seat belts or belts that were highly stressed in an accident must be replaced and their anchoring points must also be checked. Use only belts installed or supplied by an authorized Mercedes-Benz Light Truck Center.
- No modifications of any kind may be made to any components or wiring of the SRS. This includes changing or removing any component or part of the SRS, the installation of additional trim material, badges, etc. over the steering wheel hub, passenger front airbag cover, or door trim panels, and installation of additional electrical/electronic equipment on or near SRS components and wiring. Keep area between airbags and occupants free from objects (e.g. packages, purses, umbrellas, etc.).

Occupant safety

- Airbags and ETDs are designed to function on a one-time-only basis. An airbag or emergency tensioning device (ETD) that was activated must be replaced.
 - Do not pass belts over sharp edges. They could tear.
 - Do not make any modification that could change the effectiveness of the belts.
 - Do not hang items such as coat hangers from the coat hooks or handles over the door. These items may turn into projectiles and cause head and other injuries when curtain airbag is deployed.
 - An airbag system component within the steering wheel gets hot after the airbag has inflated. Do not touch.
 - Improper work on the system, including incorrect installation and removal, can lead to possible injury through an unintended activation of the SRS.
- In addition, through improper work there is a risk of rendering the SRS inoperative or causing unintended airbag deployment. Work on the SRS must therefore only be performed by an authorized Mercedes-Benz Light Truck Center.
 - For your protection and the protection of others, when scrapping the airbag unit or emergency tensioning device, our safety instructions must be followed. These instructions are available from your authorized Mercedes-Benz Light Truck Center.
 - Given the considerable deployment speed and the textile structure of the airbags, there is the possibility of abrasions or other injuries resulting from airbag deployment.

When you sell your vehicle, we strongly urge you to give notice to the subsequent owner that it is equipped with an SRS by alerting them to the applicable section in the Operator's Manual.

Warning!



In the event that the SRS malfunction indicator lamp lights up while driving, the SRS may not be operational. For your safety, we strongly recommend that you visit an authorized Mercedes-Benz Light Truck Center immediately to have the system checked; otherwise the SRS may not be activated when needed in an accident, which could result in serious or fatal injury, or it might deploy unexpectedly and unnecessarily which could also result in injury.

Front airbags

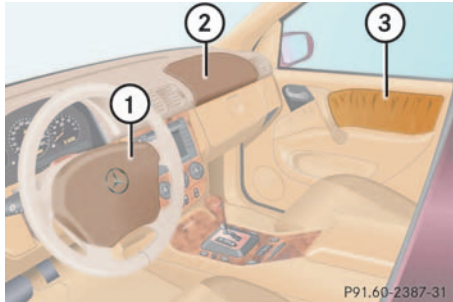

- 1 Driver airbag
- 2 Passenger airbag
- 3 Side impact airbag

Driver and passenger airbags are deployed:

- in the event of a frontal impact
- if impact exceeds a preset deployment threshold
- independently of the side impact airbags

The airbags will not deploy in impacts which do not exceed the system's deployment thresholds. You will then be protected by the fastened seat belts.

The passenger airbag will only be deployed if:

- the passenger seat is occupied
- the **AIRBAG OFF** indicator lamp in the instrument cluster is not lit (▷ page 26)



Do not place objects heavier than 20 lbs (9 kg) on the front passenger seat. This could cause the front or side impact airbag on the front passenger side to deploy in a crash which exceeds the system's deployment threshold.

Side impact airbags and window curtain airbags

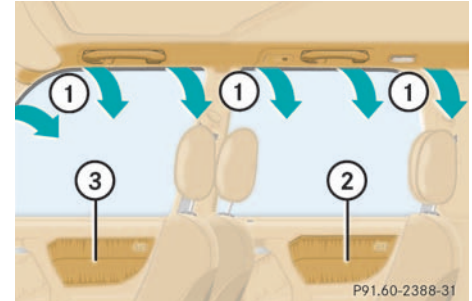

- 1 Window curtain airbags
- 2 Side impact airbag, rear
- 3 Side impact airbag, front

Side impact airbags and window curtain airbags are deployed:

- on the impacted side of the vehicle
- in impacts exceeding a preset deployment threshold
- independently of the front airbags

Occupant safety

The side impact airbags and window curtain airbags are not deployed in impacts which do not exceed the system's deployment threshold.

The passenger airbag will only be deployed if:

- the passenger seat is occupied
- the  indicator lamp in the instrument cluster is not lit (▷ page 26)

Seat belts

After starting the engine, a warning sounds and the seat belt warning lamp  remains illuminated for approx. six seconds if the driver's seat is not fastened.

The use of seat belts and infant and child restraint systems is required by law in all 50 states and all Canadian provinces. Even where this is not the case, all vehicle occupants should have their seat belts fastened whenever the vehicle is in motion.

Information on fastening seat belts is found in the "Getting started" section (▷ page 40).



For information on infants and children traveling with you in the vehicle and restraint systems for infants and children, see "Children in the vehicle" (▷ page 63)

Warning!



Always fasten your seat belt before driving off. Always make sure your passengers are properly restrained, even those sitting in the rear and pregnant women.

Failure to wear and properly fasten and position your seat belt greatly increases your risk of injuries and their likely severity in an accident. You and your passengers should always wear seat belts.

If you are ever in an accident, your injuries can be considerably more severe without your seat belt properly buckled. Without your seat belt buckled, you are much more likely to hit the interior of the vehicle or be ejected from it. You can be seriously injured or killed.

In the same crash, the possibility of injury or death is lessened if you are properly wearing your seat belt. Airbags can only protect as they are designed if the occupants are properly wearing their seat belts.

Warning!



Never ride in a moving vehicle with the backrest reclined. Sitting in an excessively reclined position can be dangerous. You could slide under the seat belt in a collision. If you slide under it, the belt would apply force at the abdomen or neck. That could cause serious or even fatal injuries. The backrest and seat belt provide the best restraint when the wearer is in an upright position and the belt is properly positioned on the body.

Warning!



Never let more people ride in the vehicle than there are seat belts available. Be sure everyone riding in the vehicle is correctly restrained with a separate seat belt.

Warning!



Damaged seat belts or belts that were highly stressed in an accident must be replaced and their anchoring points must also be checked.

Only use seat belts which have been approved by Mercedes-Benz.

Do not make any modifications to the seat belts. This can lead to unintended activation or to failure.

Have all work carried out only by an authorized Mercedes-Benz Light Truck Center.

Warning!



USE SEAT BELTS PROPERLY

- Seat belts can only work when used properly. Never wear seat belts in any other way than as described in this section, as that could result in serious injuries in case of an accident.
- Each occupant should wear their seat belt at all times, because seat belts help reduce the likelihood of and potential severity of injuries in accidents, including rollovers. The integrated restraint system includes SRS (driver airbag, front passenger airbag, front and rear door mounted side impact airbags and window curtain airbags), ETD (seat belt emergency tensioning device for the outboard passenger seats [except in the optional 3rd row seats]), and front seat knee bolsters. The system is designed to enhance the protection offered to properly belted occupants in certain frontal (front airbags) and side (side impact airbags and window curtain airbags) impacts which exceed preset

Occupant safety

deployment thresholds.

- Never wear the shoulder belt under your arm, against your neck or off your shoulder. In a crash, your body would move too far forward. That would increase the chance of head and neck injuries. The belt would also apply too much force to the ribs or abdomen, which could severely injure internal organs such as your liver or spleen.
- Never wear belts over rigid or breakable objects in or on your clothing, such as eyeglasses, pens, keys, etc., as these might cause injuries.
- Position the lap belt as low as possible on your hips and not across the abdomen. If the belt is positioned across your abdomen, it could cause serious injuries in a crash.
- Each seat belt should never be used for more than one person at a time. Do not fasten a seat belt around a person and another person or other objects.

- Belts should not be worn twisted. In a crash, you wouldn't have the full width of the belt to manage impact forces. The twisted belt against your body could cause injuries.
- Pregnant women should also use a lap-shoulder belt. The lap belt portion should be positioned as low as possible on the hips to avoid any possible pressure on the abdomen.
- Never place your feet on the instrument panel or on the seat. Always keep both feet on the floor in front of the seat.

Emergency tensioning device, seat belt force limiter

The front seat belts are equipped with emergency tensioning devices and belt force limiters. The outboard passenger seats belts (except in the third row seats*) are equipped with emergency tensioning devices.

The ETD is designed to activate only when the seat belt is fastened and in the following cases:

- in frontal or rear-end impacts exceeding a preset severity level
- if the restraint systems are operational and functioning correctly, see **SRS** indicator lamp (▷ page 54)

In an impact, emergency tensioning devices remove slack from the belts in such a way that the seat belts fit more snugly against the body. Belt force limiters reduce the force exerted by the seat belts on occupants during a crash.

Warning!

An emergency tensioning device (ETD) that was activated must be replaced.

When scrapping the emergency tensioning device, our safety instructions must be followed. These are available at your authorized Mercedes-Benz Light Truck Center.



Do not place objects heavier than 20 lbs (9 kg) on the front passenger seat. This could cause the front or side impact airbag on the front passenger side to deploy in a crash which exceeds the system's deployment threshold.

Children in the vehicle

If an infant or child is traveling with you in the vehicle:

- Secure the child using an infant or child restraint appropriate to the age and size of the child and recommended for use by Mercedes-Benz.
- Ensure that the infant or child is properly secured by a belt at all times while the vehicle is in motion.

Infant and child restraint seats and information on choosing an appropriate restraint system can be obtained from any Mercedes-Benz Light Truck Center.

Infant and child restraint systems

Use only a BabySmart™ compatible child restraint for the front passenger seat in this vehicle.

We recommend that all infants and children be properly restrained at all times while the vehicle is in motion. All lap-shoulder belts except the driver's seat belt have special seat belt retractors for secure fastening of child restraints.

To fasten a child restraint, follow child restraint instructions for mounting. Then pull shoulder belt out completely and let it retract. During the seat belt retraction a ratcheting sound can be heard to indicate that the special seat belt retractor is activated. The belt is now locked. Push down on child restraint to take up any slack.

To deactivate, release seat belt buckle and let seat belt retract completely. The seat belt can again be used in the usual manner.

BabySmart™ is a trademark of Siemens Automotive Corp.

Occupant safety



Information on child seats with mounting fittings for tether anchorages (▷ page 67).

For information on child seat mounts – “LATCH” type (▷ page 68).

Warning!



Never release the seat belt buckle while the vehicle is in motion, since the special seat belt retractor will be deactivated.



The use of infant or child restraints is required by law in all 50 states, the District of Columbia, the U.S. territories and all Canadian provinces.

Infants and small children should be seated in an appropriate infant or child restraint system properly secured by a lap-shoulder belt or, if so equipped, a child restraint lower anchorage system that complies with U.S. Federal Motor Vehicle Safety Standards 213 and 225 and Canadian Motor Vehicle Safety Standard 213 and 210.2. A statement by the child restraint manufacturer of compliance with this standard can be found on the instruction label on the restraint and in the instruction manual provided with the restraint.

When using any infant or child restraint system, be sure to carefully read and follow all manufacturer's instructions for installation and use.

Please read and observe warning labels affixed to inside of vehicle and to infant or child restraints.

Warning!



Children 12 years old and under must never ride in the front seat, except in a Mercedes-Benz authorized BabySmart™ compatible child seat, which operates with the BabySmart™ System installed in the vehicle to deactivate the passenger front airbag when it is properly installed. Otherwise they will be struck by the airbag when it inflates in a crash. If this happens, serious or fatal injury can result.

According to accident statistics, children are safer when properly restrained in the rear seating positions than in the front seating positions. Infants and small children must ride in back seats and be seated in an appropriate infant or child restraint system, which is properly secured with the vehicle's seat belt and top tether strap, or secured via lower anchors and top tether strap, fully in accordance with the child seat manufacturer's instructions.

Infants and small children should never share a seat belt with another occupant. During an accident, they could be crushed between the occupant and seat belt.

A child's risk of serious or fatal injuries is significantly increased if the child restraints are not properly secured in the vehicle and the child is not properly secured in the child restraint.

Warning!

Children too big for child restraint systems must ride in back seats using regular seat belts. Position shoulder belt across chest and shoulder, not face or neck. A booster seat may be necessary to achieve proper belt positioning for children from 41 lbs. to the point where a lap / shoulder belt fits properly without one.

When the child restraint is not in use, remove it from the vehicle or secure it with the seat belt to prevent the child restraint from becoming a projectile in the event of an accident.

Do not leave children unattended in the vehicle, even if the children are secured in a child restraint system. Unsupervised children in a child restraint system may use vehicle equipment and may cause an accident and/or serious personal injury.

BabySmart™ airbag deactivation system

Special BabySmart™ compatible child seats, designed for use with the Mercedes-Benz system and available at any authorized Mercedes-Benz Center, are required for use with the BabySmart™ airbag deactivation system. With the special seat properly installed, the passenger front airbag will not deploy.

The  indicator lamp located in the instrument cluster will be illuminated, except with the key removed or in the steering lock position **0**.



The system does not deactivate the door mounted side impact airbag, the window curtain airbags and the emergency tensioning device.

Occupant safety

Self-test BabySmart™ without special child seat installed

After turning key in steering lock to position 1 or 2, the  indicator lamp located in the instrument cluster comes on for approximately 6 seconds, extinguishes, then blinks once.

If the indicator lamp should not come on or is continuously lit, the system is not functioning. You must see an authorized Mercedes-Benz Light Truck Center before seating any child on the front passenger seat.

More information can be found in the “Practical hints” section (▷ page 232).

BabySmart™ is a trademark of Siemens Automotive Corp.

Warning!



The BabySmart™ airbag deactivation system will ONLY work with a special child seat designed to operate with it. It will not work with child seats which are not BabySmart™ compatible.

Never place anything between seat cushion and child seat (e.g. pillow), since it reduces the effectiveness of the deactivation system. The bottom of the child seat must make full contact with the passenger seat cushion. An incorrectly mounted child seat could cause injuries to the child in case of an accident, instead of protecting the child.

Follow the manufacturer's instructions for installation of special child seats.

When using a BabySmart™ compatible child seat on the front passenger seat, the front passenger airbag will not deploy only if the  indicator lamp remains illuminated.

Please be sure to check the indicator every time you use the special system child seat.

Should the light go out while the restraint is installed, please check installation. If the light remains out, do not use the BabySmart™ restraint to transport children on the passenger seat until the system has been repaired.

Warning!



Do not place powered-on laptops, cell phones and like electronic devices on the passenger seat. Signals from such devices may interfere with the BabySmart™ system. Such signal interference may cause the  indicator lamp not to come on during self-test or be continuously lit, indicating that the system is not functioning.

Installation of infant and child restraint system

- ▶ Guide top tether strap between head restraint and top of seat back. Head restraint must be installed and positioned such that the top tether strap can pass freely between the head restraint and top of seat back.

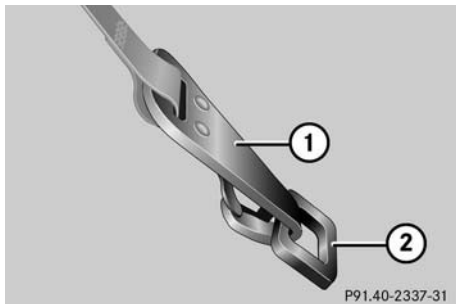

- 1 Hook
- 2 Anchorage ring

- ▶ Securely fasten the hook 1 to the anchorage ring 2.

For safety, make sure that the hook has attached to the ring beyond the safety catch, as illustrated.

Vehicle without third row seats

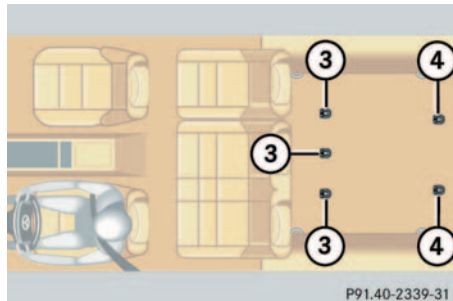

- 3 Anchorage rings for second row seats
- 4 Anchorage rings for third row seats*

This vehicle is provided with three tether anchorages 3 for a top tether strap behind the second row seats.



Do not use the tether anchorages 4 for a top tether strap on a second row seat.

Vehicle with third row seats*

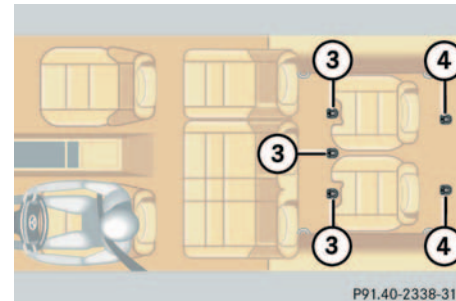

- 3 Anchorage rings for second row seats
- 4 Anchorage rings for third row seats*

This vehicle is provided with tether anchorages for a top tether strap behind the second row seats 3 and the third row seats 4.

When using the third row observe the following:

- Installation of infant and child restraint systems with a top tether strap is allowed only on both third row seats plus the center second row seat.

Occupant safety

- When using the center second row seat for a top tether strap, the left third row seat should only be used for a child restraint system, since exiting the vehicle may not be possible in an emergency due to the routing of the top tether strap.
- When installing an infant or child restraint system with a top tether strap on the left second row seat, the left third row seat should not be occupied.



An infant and child restraint system must not be installed on the right second row seat while a passenger rides in a third row seat. An infant and child restraint system installed on the right second row seat will prevent the use of the easy-entry/exit feature (> page 95).

Child seat anchors – “LATCH” type

This vehicle is provided with two “LATCH” (LOWER Anchors and Tethers for CHildren) type anchors (at each of the outer rear seats and in the optional third row seats) for installation of a “LATCH” seat with matching mounting fittings.



1 Anchors

- ▶ Install a “LATCH” type child seat according to the manufacturer’s instructions.



With a child seat installed in the left rear seat, the seat belt for the center seat occupied by a passenger must operate freely. Guide seat belt between its seat cushion mount and backrest mount along outside of right side child seat mount.

Non-“LATCH” type child seats may also be used and can be installed using the vehicle’s seat belt system. Install child seat according to the manufacturer’s instructions.

Warning!

Install child seat according to manufacturer's instructions.

The child seat must be firmly attached in the right and left side anchors **1**.

An incorrectly mounted child seat may come loose during an accident.

Damaged or impact damaged child seats or child seat mounting fittings must be replaced.

Do not leave children unattended in the vehicle, even if the children are secured in a child restraint system.

Children too big for child restraint systems must ride in back seats using regular seat belts. Position shoulder belt across chest and shoulder, not face or neck. A booster seat may be necessary to achieve proper belt positioning for children from 41 lbs. to the point where a lap / shoulder belt fits properly without one.

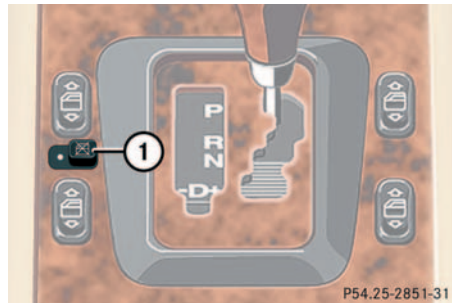
Blocking of rear door window operation**1 Switch for rear door window override**

- Slide the switch to the right.

A dot becomes visible. The rear windows can no longer be operated using the switch in the rear doors.

Warning!

Activate the override switch in the rear when children are riding in the car. The children could otherwise injure themselves, e.g. by becoming trapped in the window opening.

When leaving the vehicle, always remove the key from the steering lock, and lock the vehicle. Do not leave children unattended in the vehicle, or with access to an unlocked vehicle. Unsupervised use of vehicle equipment may cause an accident and/or serious personal injury.

For more information on power windows, see the “Controls in detail” section (▷ page 134).

Panic alarm

Panic alarm

An audible alarm and blinking turn signal lamps will operate for approximately 2½ minutes.



1 **PANIC** button

Activating

- ▶ Press and hold button **1** for at least one second.

Deactivating

- ▶ Press button **1**. again or insert key in steering lock.
- or
- ▶ Insert key in steering lock.



For operation in the USA only: This device complies with Part 15 of the FCC Rules. Operation is subject to the following two conditions:

- This device may not cause harmful interference, and
- this device must accept any interference received, including interference that may cause undesired operation.

Any unauthorized modification to this device could void the user's authority to operate the equipment.

Driving and safety systems

In this section you will find information on the following driving safety systems:

- ABS (Antilock Brake System)
- BAS (Brake Assist System)
- 4-ETS (Electronic Traction System)
- EBP (Electronic Brake Proportioning)
- ESP (Electronic Stability Program)



In winter operation, the maximum effectiveness of the ABS, ESP, EBP and 4-ETS is only achieved with winter tires (M+S tires), or snow chains as required.

Warning!



The following factors increase the risk of accidents:

- Excessive speed, especially in turns
- Wet and slippery road surfaces
- Following another vehicle too closely

ABS, BAS, ESP and 4-ETS cannot reduce this risk.

Always adjust your driving style to the prevailing road and weather conditions.

ABS

Warning!



Do not pump the brake pedal. Use firm, steady brake pedal pressure instead. Pumping the brake pedal defeats the purpose of ABS and significantly reduces braking effectiveness.

The ABS regulates the brake pressure so that the wheels do not lock during braking. This allows you to maintain the ability to steer your vehicle.

The ABS is functional above a speed of approximately 5 mph (8 km/h) independent of road surface conditions.

On slippery road surfaces, the ABS will respond even with light brake pressure.

The  warning lamp in the instrument cluster (▷ page 25) lights up when you turn the key to position **2**. It goes out when the engine is running.

Driving and safety systems

Braking

At the instant one of the wheels is about to lock up, a slight pulsation can be felt in the brake pedal, indicating that the ABS is in the regulating mode.

- ▶ Keep firm and steady pressure on the brake pedal while experiencing the pulsation.

Emergency brake maneuver

- ▶ Keep continuous full pressure on the brake pedal.



With the ABS malfunctioning, the BAS, EBP ESP and 4-ETS are also switched off.

Normal driving and braking functions are still available.

LOW RANGE- ABS

During off-road driving a special low range system for the antilock brake system (ABS) is operational with transmission in LOW RANGE mode (▷ page 118).

When applying the service brakes at speeds below approximately 18 mph (30 km/h), the front wheels are locked cyclically to shorten the braking distance (dig in effect). This affects steering the vehicle.

Warning!



The ABS cannot prevent the natural laws of physics from acting on the vehicle, nor can it increase braking or steering efficiency beyond that afforded by the condition of the vehicle brakes and tires or the traction afforded. The ABS cannot prevent accidents, including those resulting from excessive speed in turns, following another vehicle too closely, or aquaplaning. Only a safe, attentive, and skillful driver can prevent accidents. The capabilities of an ABS equipped vehicle must never be exploited in a reckless or dangerous manner which could jeopardize the user's safety or the safety of others.

More information can be found in the "Practical hints" section (▷ page 225).

BAS

The Brake Assist System (BAS) operates in emergency situations. If you apply the brakes very quickly, the BAS automatically provides full brake boost, thereby potentially reducing braking distance. Apply continuous full braking pressure until the emergency braking situation is over. The ABS will prevent the wheels from locking.

When you release the brake pedal the brakes function again as normal. The BAS is then deactivated.

The  warning lamp in the instrument cluster (▷ page 25) lights up when you turn the key to position **2**. It goes out when the engine is running.

Warning!



The BAS cannot prevent the natural laws of physics from acting on the vehicle, nor can it increase braking efficiency beyond that afforded by the condition of the vehicle brakes and tires or the traction afforded. The BAS cannot prevent accidents, including those resulting from excessive speed in turns, following another vehicle too closely, or aquaplaning. Only a safe, attentive, and skillful driver can prevent accidents. The capabilities of a BAS equipped vehicle must never be exploited in a reckless or dangerous manner which could jeopardize the user's safety or the safety of others.

More information can be found in the "Practical hints" section (▷ page 225).

4-ETS

The 4-Electronic Traction System (4-ETS) improves vehicle's ability to utilize available traction, especially under slippery road conditions. The brakes are applied to the spinning wheel and power is transferred to the wheel(s) with traction.

The traction control engages at vehicle speeds up to approximately 24 mph (40 km/h), and switches off at 50 mph (80 km/h).

The  warning lamp in the instrument cluster (▷ page 25) lights up when you turn the key to position **2**. It goes out when the engine is running.

The 4-ETS/ESP warning lamp , located in the speedometer dial, starts to flash at any vehicle speed, as soon as the tires lose traction and the wheels begin to spin.

Warning!



When you see the 4-ETS/ESP-warning lamp  flashing in the speedometer dial, then proceed as follows:

- While driving off, apply as little throttle as possible.
- While driving ease up on the accelerator.
- Adapt your speed and driving style to the prevailing road conditions.

Failure to observe these guidelines could cause the vehicle to skid.

The 4-ETS cannot prevent accidents resulting from excessive speed.





The engine must be shut off when

- the parking brake is being tested on a brake test dynamometer.
- the vehicle is being towed with the front axle raised.

Otherwise, the 4-ETS will engage the brakes and seriously damage the brake system.



If the yellow 4-ETS malfunction indicator lamp  comes on while the 4-ETS/ESP warning lamp  flashes, the electronic traction system is being switched off temporarily to prevent overheating of the drive wheel brakes.

LOW RANGE 4-ETS

During off-road driving a special low range system for the 4-ETS is operational with transmission in LOW RANGE mode.

More information can be found in the “Practical hints” section (▷ page 224) and (▷ page 226).

EBP



The EBP enhances braking effectiveness by allowing the rear brakes to supply a greater proportion of the braking effort without a loss of vehicle stability.

ESP

The Electronic Stability Program (ESP) monitors the vehicle's traction (force of adhesive friction between the tires and the road surface) and handling.

The ESP recognizes when a wheel is spinning or if the vehicle starts to skid. By applying brakes to the appropriate wheel and by limiting engine output, the ESP works to stabilize the vehicle.

The 4-ETS/ESP warning lamp  in the speedometer dial flashes when the ESP is engaged.

The  warning lamp in the instrument cluster (▷ page 25) and the 4-ETS/ESP warning lamp  in the speedometer light up when you turn the key to position **2**. They go out when the engine is running.

Warning!



Never switch off the ESP when you see the 4-ETS/ESP-warning lamp  flashing in the speedometer dial. In this case proceed as follows:

- While driving off, apply as little throttle as possible.
- While driving ease up on the accelerator.
- Adapt your speed and driving style to the prevailing road conditions.

Failure to observe these guidelines could cause the vehicle to skid.

The ESP cannot prevent accidents resulting from excessive speed.

Warning!



The ESP cannot prevent the natural laws of physics from acting on the vehicle, nor can it increase the traction afforded. The ESP cannot prevent accidents, including those resulting from excessive speed in turns, following another vehicle too closely, or aquaplaning. Only a safe, attentive, and skillful driver can prevent accidents. The capabilities of a ESP equipped vehicle must never be exploited in a reckless or dangerous manner which could jeopardize the user's safety or the safety of others.

Driving and safety systems



The engine must be shut off when

- the parking brake is being tested on a brake test dynamometer.
- the vehicle is being towed with the front axle raised.

Otherwise, the ESP will engage the brakes and seriously damage the brake system.

The ESP will only function properly if you use wheels of the recommended tire size (▷ page 279).

LOW RANGE – ESP

During off-road driving a special low range system for the ESP is operational with transmission in LOW RANGE mode (▷ page 118).

In the LOW RANGE mode ESP operates in a traction improving fashion specifically adapted for off-road driving. At speeds be-

low 27 mph (45 km/h), the ESP assists in over-/understeering, thus improving vehicle traction.

Switching off the ESP

Warning!



The ESP should not be switched off during normal driving other than in the circumstances described below. Disabling of the system will reduce vehicle stability in standard driving maneuvers.

To improve the vehicle's traction, turn off the ESP in driving situations where it would be advantageous to have drive wheels spin and thus cut into surfaces for better grip such as:

- starting out on slippery surfaces and in deep snow in conjunction with snow chains
- in sand or gravel
- when driving off-road

When the ESP is turned off

- engine torque is not limited.
- the drive wheels can spin.

This helps the wheels cut into surfaces for a better grip.



Avoid spinning of a drive wheel for an extended period with the ESP switched off. This may cause serious damage to the drivetrain which is not covered by the Mercedes-Benz Limited Warranty.



Turn ESP on immediately if the aforementioned circumstances do not apply anymore.

The button is located in the upper center console.



1 ESP on/off

- ▶ Press upper half of button.

The 4-ETS/ESP warning lamp  in the speedometer dial comes on.

Even if the ESP has been turned off, it is still active in the following situations:

- when braking
- at vehicle speeds between approximately 24 mph (40 km/h) and 50 mph (80 km/h), if one drive wheel loses traction and begins to spin.

The brake is applied until the wheel regains sufficient traction.

The 4-ETS/ESP warning lamp , located in the speedometer dial, starts to flash at any speed as soon as the tires lose traction.

Warning!



When the 4-ETS / ESP warning lamp  is illuminated continuously, the ESP is switched off.

Adapt your speed and driving to the prevailing road conditions and to the non-operating status of the ESP.

Switching on the ESP

- ▶ Press lower half of button.

The 4-ETS/ESP warning lamp  in the speedometer goes out. You are now again in normal driving mode.

More information can be found in the “Practical hints” section (▶ page 224).

Anti-theft systems

Anti-theft systems

Immobilizer

The immobilizer prevents unauthorized persons from starting your vehicle.

Activating

Removing the key from the steering lock activates the immobilizer.

Deactivating

Switch on the ignition by turning the key in the steering lock to position **2**.



In case the engine cannot be started (vehicle's battery is in order), the system is not operational. Contact an authorized Mercedes-Benz Light Truck Center or call 1-800-FOR-MERCEdes (in the USA), or 1-800-387-0100 (in Canada).

Anti-theft alarm

Once the alarm system has been armed, a visual and audible alarm is triggered when someone:

- opens a door
- opens the liftgate
- opens the hood

The alarm will stay on even if the activating element (a door, for example) is immediately closed.

The alarm system will also be triggered when

- someone attempts to raise the vehicle
- unlocking and opening the driver's door with the mechanical key



If the alarm stays on for more than 20 seconds, an emergency call is initiated automatically by the Tele Aid system (▷ page 159) provided Tele Aid service was subscribed to and properly activated.

Arming the alarm system

The alarm system is armed after locking the vehicle with the remote control. The turn signal lamps blink three times to indicate that the alarm system is activated. A red lamp in the center console will blink after approximately 10 seconds when the alarm system is completely armed (▷ page 27).



If the turn signal lamps do not blink three times, the tow-away - glass-breakage sensor is malfunctioning or one of the following elements may not be properly closed:

- a door
- the liftgate
- the hood

Close the respective element and lock the vehicle again.

Disarming the alarm system

The alarm system is disarmed when you unlock your vehicle with the remote control. The turn signal lamps blink once to indicate that the alarm system is deactivated.





The alarm system will rearm automatically again after approximately 40 seconds if one of the doors or the liftgate is not opened.

Canceling the alarm

To cancel the alarm:

- ▶ Switch on the ignition by turning the key in the steering lock to position **2**.

or

- ▶ Press the  or  button on the remote control.

The alarm is cancelled.

Tow-away alarm, glass breakage sensor

The tow-away alarm and the glass breakage sensor are part of the anti-theft alarm system.

Once the tow-away alarm is armed, a visual and audible alarm will be triggered when someone:

- attempts to raise the vehicle
- breaks a window and reaches into the passenger compartment



The tow-away protection alarm is triggered, for example, if the vehicle is lifted on one side.

If the alarm stays on for more than 20 seconds, an emergency call is initiated automatically by the Tele Aid system (▷ page 159) provided Tele Aid service was subscribed to and properly activated.

Anti-theft systems

Arming tow-alarm and glass breakage sensor

When you lock your vehicle, the tow-away and glass breakage sensor alarm is automatically armed.

Disarming tow-alarm and glass breakage sensor

To prevent triggering the tow-away alarm feature, switch off the tow-away alarm and glass breakage sensor before towing the vehicle, or when parking on a surface subject to movement, such as a ferry or auto train.

Vehicles with trip computer*

The buttons are located in the overhead control panel.



- 1 Reset button
- 2 Mode button
- 3 Display
- 4 Glass breakage sensor

- ▶ Turn key in steering lock to position **1** (▷ page 33).
- ▶ Press button **2**.
- ▶ Return key to position **0** and remove it from the steering lock.
- ▶ Within 30 seconds press button **1** or **2**.
The display shows **OFF**.
- ▶ Exit vehicle and lock vehicle with remote control (▷ page 32).

The tow-away alarm and glass breakage sensor remain switched off until the key is inserted in steering lock and turned to position **1**.

Vehicles without trip computer

The buttons are located in the overhead control panel.

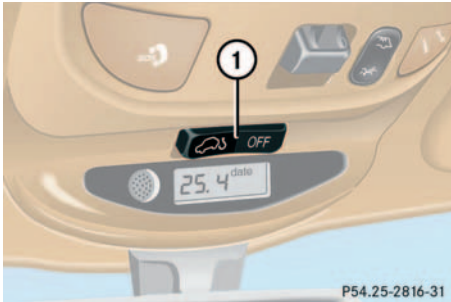

1 Switching off tow-away alarm and glass breakage sensor

- ▶ Turn key in steering lock to position **1** (▷ page 33).
- ▶ Press the button **2**.
- ▶ Return key to position **0** and remove it from the steering lock.
- ▶ Within 30 seconds press button **1** on the right or left side.
- ▶ Exit vehicle and lock vehicle with remote control (▷ page 32).

The tow-away alarm and glass breakage sensor remain switched off until the key is inserted in steering lock and turned to position **1**.

Controls in detail

Locking and unlocking

Seats

Memory function *

Lighting

Instrument cluster

Automatic transmission

Transmission control - LOW RANGE mode

Good visibility

Automatic climate control

Power windows

Sliding/pop-up roof*

Loading

Driving systems

Useful features



Locking and unlocking

In the “Controls in detail” section you will find detailed information on how to operate the equipment installed in your vehicle. If you are already familiar with the basic functions of your vehicle, this section will be of particular interest to you.

To quickly familiarize yourself with the basic functions of the vehicle, refer to the “Getting started” section of this manual. The corresponding page numbers are given at the beginning of each segment.

Locking and unlocking

Remote control with folding key

More information on the remote control with folding key can be found in the “Getting started” section (▷ page 32).

Your vehicle comes supplied with two remote controls with folding key.

The remote control provides an extended operating range. To prevent theft, however, it is advisable to only unlock the vehicle when you are in close proximity to it.

The key centrally locks and unlocks:

- the doors
- the liftgate
- the fuel filler flap



If the key is inserted in the steering lock, the vehicle cannot be locked or unlocked with the remote control.

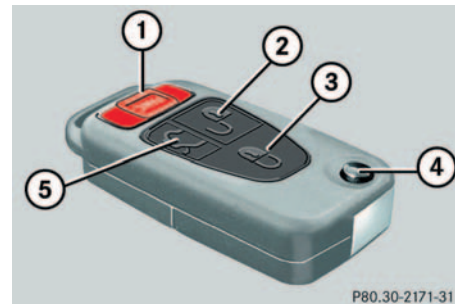

P80.30-2171-31

- 1 Panic button (▷ page 70)
- 2 Unlock button
- 3 Lock button
- 4 Release button for key
- 5 Unlock button for liftgate



To prevent possible malfunction, avoid exposing the key to high levels of electromagnetic radiation.

Unlocking



Unlocking the vehicle with the remote control deactivates the anti-theft alarm.

The vehicle will lock again automatically and reactivate the anti-theft system within approximately 40 seconds of unlocking if neither door nor liftgate is opened.

Unlocking the driver's door and fuel filler flap

- ▶ Press button once.

All turn signal lamps blink once to indicate that the driver's door and the fuel filler flap are unlocked.

Global unlocking

- ▶ Press button twice.

All turn signal lamps blink once to indicate that all doors, fuel filler flap and liftgate are unlocked.

Unlocking the liftgate

- ▶ Press button .

Only the liftgate unlocks.

Locking



Locking the vehicle with the remote control activates the anti-theft alarm.

- ▶ Press button once

All turn signal lamps blink three times to indicate that all doors, the liftgate and the fuel filler flap are unlocked.



If the turn signal lamps do not blink three times, one of the following elements may not be properly closed:

- a door
- the liftgate
- the hood

Close the respective element and lock the vehicle again.

Warning!



When leaving the vehicle, always remove the key from the steering lock, and lock your vehicle. Do not leave children unattended in the vehicle, or with access to an unlocked vehicle. Unsupervised use of vehicle equipment may cause an accident and/or serious personal injury.

Locking and unlocking



If you can no longer lock or unlock the vehicle with the remote control, then the batteries in the remote control are discharged, the remote control is malfunctioning or the vehicle battery is drained.

- Use the folding key to unlock or lock the doors and the liftgate.
- Check the vehicle battery (▷ page 261).
- Replace batteries (▷ page 243).
- Synchronize the remote control (▷ page 244).

If the remote control is malfunctioning, contact an authorized Mercedes-Benz Light Truck Center.

Loss of remote control with folding key

If you lose a remote control or the folding key, you should do the following:

- ▶ Have the remote control deactivated by an authorized Mercedes-Benz Light Truck Center.
- ▶ Report the loss of the remote control or the folding key immediately to your car insurance company.
- ▶ If necessary have the mechanical lock replaced.

Your authorized Mercedes-Benz Light Truck Center will be glad to supply you with a replacement.

Opening the doors from the inside

You can open a locked door from the inside. Open door only when conditions are safe to do so.

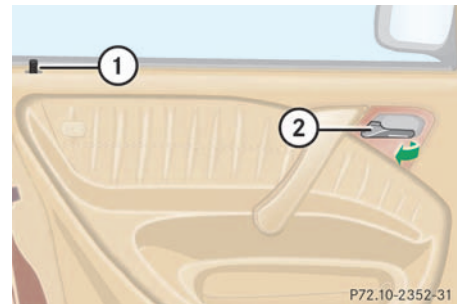

- 1** Locking knob
- 2** Inside door handle

- ▶ Pull on door handle **2**.

If a door was locked, locking knob **1** will move up.



If the vehicle has previously been locked from the outside with the remote control, opening a door from the inside will trigger the alarm.

Opening the liftgate

Warning!



Only drive with the liftgate closed as, among other dangers such as visibility blockage, exhaust fumes may enter the vehicle interior.



A minimum height clearance of 7 ft. (2.15 m) is required to open the liftgate.

Opening the liftgate from outside

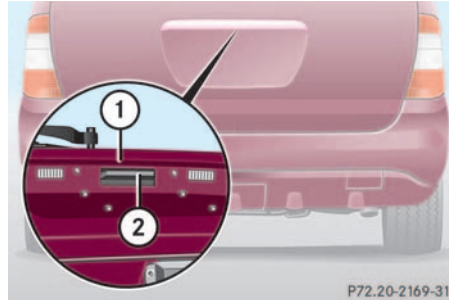

- 1 Grip molding
- 2 Handle

- ▶ Pull on handle 2.
- ▶ Swing the liftgate upward by using the grip molding.

Opening the liftgate from inside

The release lever is located on the inside of the liftgate.

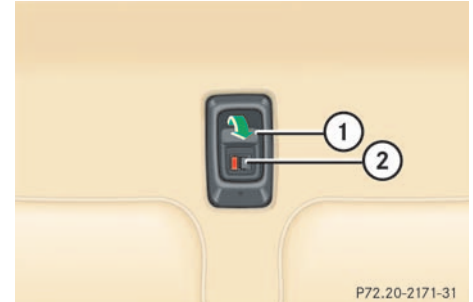

- 1 Handle
- 2 Catch

- ▶ For unlocking the liftgate move the catch 2 to the right.
- ▶ Pull handle 1 down and swing liftgate upward.



For locking the liftgate move the catch 2 to the left.

Locking and unlocking

Warning!



When leaving the vehicle, always remove the key from the steering lock and lock the vehicle. Do not leave children unattended in the vehicle. Children could open the liftgate from inside, which could result in an accident and/or serious personal injury.

Closing the liftgate

Warning!



When closing the liftgate, use extreme caution not to catch hands or fingers. Be especially careful when small children are around.

Do not close the liftgate from the inside by pulling on the handle.

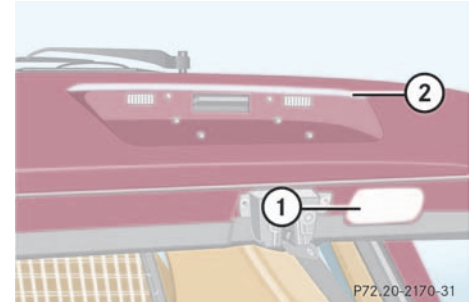

1 Recessed grip

2 Grip molding

- ▶ Pull down on recessed grip **1**.
- ▶ Close liftgate by using grip molding **2**.

Automatic central locking

The doors and the liftgate automatically lock when the ignition is switched on and the left front wheel turns at vehicle speeds of approximately 9 mph (15 km/h) or more.

If one of the front doors is then opened from the inside, the vehicle is unlocked centrally unless only the driver's door was previously unlocked.



The doors unlock automatically after an accident if the force of the impact exceeds a preset threshold.

To prevent the vehicle door locks from locking, deactivate the automatic central locking when the vehicle

- is pushed or
- is on a test stand

The central locking button is located on the lower center console.



Central locking button

- 1 Locking
- 2 Unlocking

Activating

- ▶ Check that the ignition is switched on.
All the lamps in the instrument cluster light up.
- ▶ Press and hold upper part **1** of the central locking button for approximately six seconds.

The automatic central locking is activated.

Deactivating

- ▶ Check that the ignition is switched on.
All the lamps in the instrument cluster light up.
- ▶ Press and hold lower part **2** of the central locking button for approximately six seconds.

The automatic central locking is deactivated.

Locking and unlocking

Locking and unlocking from the inside

You can lock or unlock the vehicle from inside using the central locking switches. This can be useful, for example, if you want to unlock the passenger door from the inside or want to lock the vehicle before starting to drive.



You can open a locked door from the inside. Open door only when conditions are safe to do so.

If you have locked the vehicle with the remote control, the central locking switch does not work.

Locking

- ▶ Press upper part **1** of central locking button (▷ page 89).

If all the doors are closed, the vehicle locks.

Unlocking

- ▶ Press lower part **2** of central locking button (▷ page 89).

The vehicle unlocks, if the vehicle was not previously centrally locked with the remote control.

Warning!



When leaving the vehicle, always remove the key from the steering lock and lock the vehicle. Do not leave children unattended in the vehicle, or with access to an unlocked vehicle. Unsupervised use of vehicle equipment may cause an accident and/or serious personal injury.

Seats

Information on seat adjustment can be found in the “Getting started” section (▷ page 34).

Seat heater*

The seat heaters can only be switched on with the engine running.

The switches are located on the upper center console.



- 1 Normal heating
- 2 Rapid heating

Switching on normal seat heating mode

- ▶ Press upper part **1** of switch.
One indicator lamp in the switch lights up.



The seat heater will be automatically switched off after approximately 20 minutes.

Switching off normal seat heating mode

- ▶ Press upper part **1** of switch again.
The indicator lamp in the switch goes out.

Switching on rapid seat heating mode

- ▶ Press lower part **2** of switch.
Both indicator lamps in the switch light up.



The system switches over to normal heating mode after approximately five minutes. Only one indicator lamp remains lit.

Switching off rapid seat heating mode

- ▶ Press lower part **2** of switch again.
Both indicator lamps in the switch go out.



If one or both of the lamps on the seat heater switch are blinking, there is insufficient voltage available since too many electrical consumers are turned on. The seat heater switches off automatically.

The seat heater will switch back on again automatically as soon as sufficient voltage is available.

Seats

Removing and installing head restraints

Warning!



For your protection, drive only with properly positioned head restraints.

Adjust head restraint to support the back of the head approximately at ear level.

Do not drive the vehicle without the seat head restraints. Head restraints are intended to help reduce injuries during an accident.

Removing head restraint

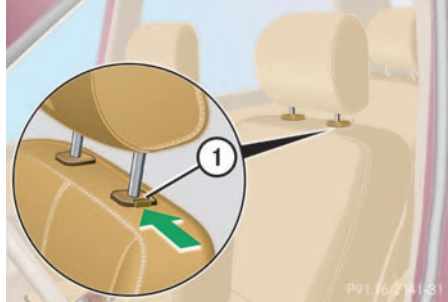

1 Lock button

- ▶ Pull head restraint to its highest position
- ▶ Press lock button **1** and pull out head restraint.



The head restraint(s) should be stored beneath the cargo floor plates (▷ page 144).

Installing head restraint

- ▶ Insert head restraint and push it down to the stop.
- ▶ Press lock button **1** and adjust head restraint down to the desired position (▷ page 36).

Rear seats

Warning!



Do not adjust the rear seats while driving.

Always seat in an upright position and the seat belts are properly positioned on the body. Your seat must be adjusted so that you can correctly fasten your seat belt.

Adjust head restraint to support the back of the head approximately at ear level.

Never place hands under the seat or near any moving parts while a seat is being adjusted.

The rear seats are divided asymmetrically. To enlarge the cargo area you can adjust the left and right part separately. The following changes are possible:

- moving the seat fore and aft
- folding down the backrest
- lowering the seat

Adjusting rear seat fore and aft

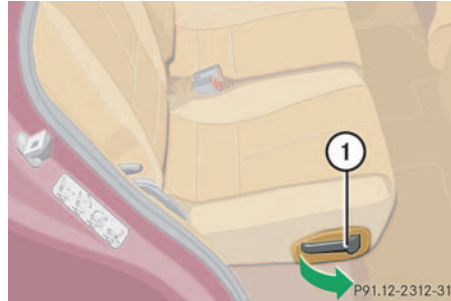

1 Release lever

- ▶ Pull release lever **1** in direction of arrow.
- ▶ Slide seat to the desired position until it locks in place.

Warning!



Failure to assure that seats are locked into place could result in an increased chance of injury in an accident.

Folding down the backrest

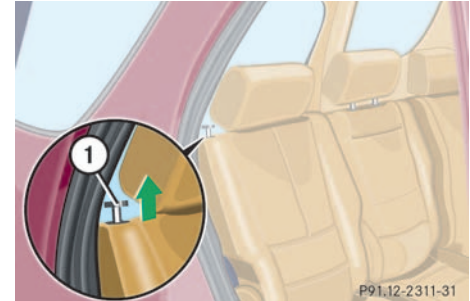

1 Lock button

- ▶ Close cup holder in rear center console (▷ page 155).
- ▶ Move front seats forward. Manual seat (▷ page 35) or power seat (▷ page 37).
- ▶ Slide seat forward.
- ▶ Remove head restraint(s) (▷ page 92).
- ▶ Pull lock button **1** up and fold backrest forward until it locks in place.

The red backrest lock indicator at lock button **1** is not visible in the locked position.

Seats

Folding up the backrest

- ▶ Pull lock button **1** up and unfold backrest until it locks in place.

Make sure that the seat belt is not caught in the seat.

- ▶ Check for secure locking by pulling and pushing on the backrest.

The red backrest lock indicator at lock button **1** is not visible in the locked position.

- ▶ Install head restraint (▷ page 92).
- ▶ Slide seat rearward to desired position (▷ page 93).
- ▶ Adjust front seats to desired position. Manual seats (▷ page 35) and power seats (▷ page 37).

Lowering the rear seat

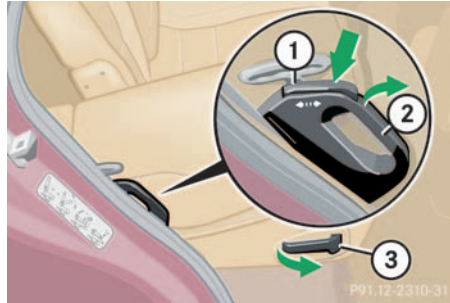

- 1** Release button
- 2** Lever
- 3** Release lever

- ▶ Close cup holder in rear center console (▷ page 155).
- ▶ Move front seats forward. Manual seat (▷ page 35) or power seat (▷ page 37).
- ▶ Press and hold release button **1** to unlock lever **2**.

- ▶ Pull lever **2** in direction of arrow.
- ▶ Pull release lever **3** and push down rear seat until it locks in place.
- ▶ Fold down the backrest (▷ page 93).
- ▶ Adjust front seats to desired position. Manual seats (▷ page 35) and power seats (▷ page 37).

Folding up the rear seat

- ▶ Move front seats forward. Manual seat (▷ page 35) or power seat (▷ page 37).
- ▶ Pull release lever **3** and raise rear seat until it locks in place.

Warning!



Failure to assure that seats are locked into place could result in an increased chance of injury in an accident.

Easy entry/exit feature*

The easy entry/exit feature allows access to the third row seats*. The right cargo floor plate must be removed (▷ page 144).

Warning!



Never drive with the second row right seat folded forward (easy entry/exit feature). It could open and fold back unintentionally.

Folding rear seat forward

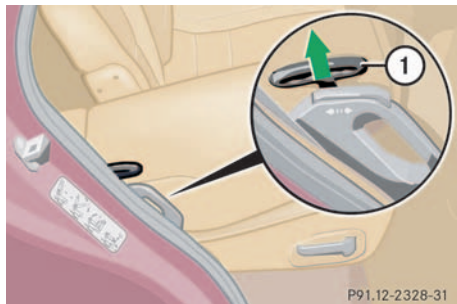

1 Lever

- ▶ Move right seat forward. Manual seats (▷ page 35) and power seats (▷ page 37).
- ▶ Move rear seat forward (▷ page 93).
- ▶ Push head restraint fully down and tilt it forward.
- ▶ Fold backrest forward (▷ page 93).
- ▶ Pull lever **1** up and fold the rear seat forward.

Resetting rear seat

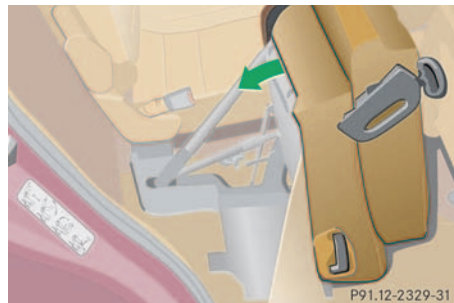

- ▶ Pull down on seat bench until it locks into place.

- ▶ Pull lock button **1** (▷ page 93) up and unfold backrest until it locks into place.
 - ▶ Pull down on seat bench until it locks into place.
 - ▶ Check for secure locking by pulling and pushing on the backrest.
- The red backrest lock indicator at lock button **1** (▷ page 93) is not visible in the locked position.
- ▶ Move the rear and front seats in desired position.
 - ▶ Pull up and adjust head restraint (▷ page 36).

Third row seats*

Warning!



For your protection, drive only with properly positioned head restraints.

Adjust head restraint to support the back of the head approximately at ear level.

Failure to assure that seats are locked into place could result in an increased chance of injury in an accident.

Never place hands under seat or near any moving parts while a seat is being adjusted.

Folding down single seat

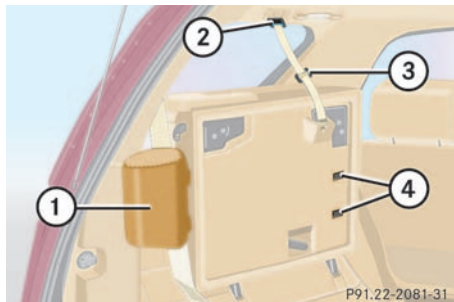

- 1 Head restraint
- 2 Hook
- 3 Tensioner
- 4 Hook and loop strip

- ▶ Remove cargo floor plate (▷ page 144).
- ▶ Remove head restraint **1** from seat cushion.
- ▶ Lift tensioner **3** upward to a horizontal position to release tension of the belt.
- ▶ Disengage hook **2** while holding onto the seat firmly with one hand.

- ▶ Attach belt at hook and loop strip **4** on underside of seat.

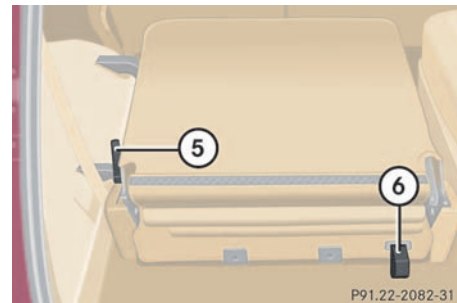

- 5 Backrest release
- 6 Seat release

- ▶ Fold seat down until it locks securely in place.
The red marking on the seat release should **6** not be visible.
- ▶ Store cargo floor plates inside the backrest (▷ page 144).
- ▶ Pull backrest release **5** and unfold backrest until it locks securely in place.
- ▶ Install head restraint **1** in backrest (▷ page 92).

Storing single seat

- ▶ Remove head restraint from backrest (▷ page 92).
 - ▶ Pull backrest release **5** and fold backrest forward until it locks securely in place.
 - ▶ Remove cargo floor plates from the backrest.
 - ▶ Pull seat release **6** (▷ page 96) and fold seat up.
- ▶ Disengage belt and engage hook **2** (▷ page 96) in ceiling mount.
 - ▶ Pull on free end of belt until tight.
 - ▶ Install head restraint in openings provided in seat cushion.
 - ▶ Install cargo floor plates (▷ page 144).

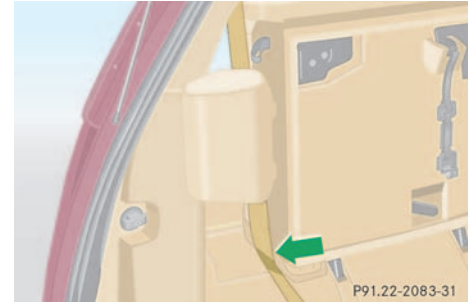
**Warning!**

After folding the seats up, manually place the lap belt portion of the seat belt behind the seat (arrow). Otherwise, the lap belt may be subject to damage and could rip.

Seats

Removing single seat

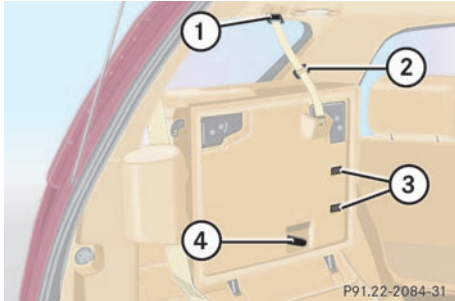

- 1 Hook
- 2 Tensioner
- 3 Hook and loop strip
- 4 Release lever

- ▶ Lift tensioner **2** upward to a horizontal position to release tension of the belt.
- ▶ Disengage hook **2** while holding onto the seat firmly with one hand.
- ▶ Attach belt at hook and loop strip **3** on underside of seat.
- ▶ Move release lever **4** upward and remove seat.

Installing single seat

- ▶ Place seat into the mounting clamps and click the seat into place.

Memory function*



Prior to operating the vehicle the driver should check and adjust the seat height, seat position fore and aft, and seat backrest angle if necessary, to ensure adequate control, reach and comfort. The head restraint should also be adjusted for proper height. Also see air-bag section (> page 55) for proper seat positioning.

In addition, adjust the steering wheel to ensure adequate control, reach, operation and comfort. Both the inside and outside rear view mirrors should be adjusted for adequate rear vision.

Fasten seat belts. Infants and small children should be seated in a properly secured restraint system that complies with U.S. Federal Motor Vehicle Safety Standard 213 and 225 and Canadian Motor Vehicle Safety Standard 213 and 210.2.

With the memory button you can store up to three different settings for the driver- and passenger seat.

Together with the driver's seat you can store the exterior rear view mirrors.

For the front passenger seat you can store the seat position.

Warning!



Do not activate the memory function while driving. Activating the memory function while driving could cause the driver to lose control of the vehicle.

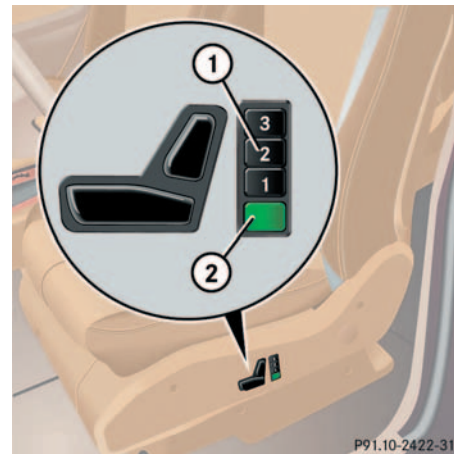

- 1 Position buttons
- 2 Memory button

Memory function*

Storing positions in memory

- ▶ Adjust the seat (▷ page 36) and exterior rear view mirrors (▷ page 38) to the desired position.
- ▶ Push memory button **2**.
- ▶ Release memory button and press one of the position buttons **1** within three seconds.

All the settings are stored at the selected position.

Recalling positions from memory



Do not operate the power seats using the memory button if the seat backrest is in an excessively reclined position. Doing so could cause damage to front or rear seats.

- ▶ Press and hold one of the position buttons **1** until seat and rear view mirrors have fully moved to the stored positions.



Releasing the button immediately stops movement to the stored positions.

Exterior rear view mirror parking position (passenger side)

For easier parking, you can adjust the passenger exterior rear view mirror so that you can see the right rear wheel as soon as you engage reverse gear **R**.

Activating parking position

The buttons are on the lower part of the center console.



- 1 Deactivating parking position
- 2 Activating parking position
- 3 Adjustment button

▶ Switch ignition on (if not already on).

▶ Press button **2**.

The passenger side exterior rear view mirror is selected.

▶ Engage reverse gear **R**.

The passenger side exterior rear view mirror moves automatically to the stored parking position.

The exterior rear view mirror returns to its stored driving position:

- 10 seconds after you put the gear selector lever in position **D**
- immediately once you exceed a speed of approx. 6 mph (10 km/h)
- immediately when you press the button **1** for driver's side mirror



If the button **1** is pressed, the automatic passenger side exterior rear view parking position is deactivated.

Storing parking position

▶ Stop the vehicle.

▶ Switch ignition on (if not already on).

▶ Press button **2**.

The passenger side exterior rear view mirror is selected.

▶ Adjust the exterior rear view mirror with button **3** so that you see the rear wheel and the curb.

▶ Press memory button **2** (▷ page 99).

▶ Within three seconds, press bottom of adjustment button **3**.

The parking position is stored if the mirror does not move.



If the mirror does move, repeat the above steps. After the setting is stored you can move the mirror again.

The selected position will be stored relative to the position button **1** (▷ page 99) pressed.

Lighting

Lighting

For notes on how to switch on the headlamps (▷ page 46) and use the turn signals (▷ page 47), see the “Getting started” section.

Combination switch

The combination switch is on the left of the steering column.

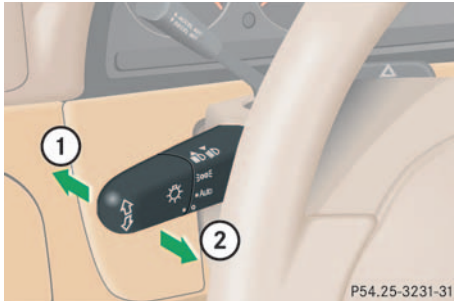

1 High beam

2 High beam flasher

0 Off

AUTO Automatic headlamp mode



Parking lamps, license plate lamps and instrument panel lamps

Canada only: With the engine running, the low beam headlamps additionally switched on.



Low beam or high beam headlamps



Left or right standing lamps (symbol on underside of switch)



If you remove the key and open the driver's door while the parking lamps or low beam headlamps are switched on, then a warning sounds.

Switching on high beams

▶ Turn the switch to

▶ Push the exterior lamp switch forward.

The high beam symbol

High beam flasher

▶ Pull the combination switch briefly in direction **2**.

Automatic headlamp mode

The parking lamps, low beam headlamps and license plate lamps switch on and off automatically depending on the brightness of the ambient light.

Warning!



In automatic headlamp mode, the headlamps will not be automatically switched on under foggy conditions. To minimize risk to you and to others, activate headlamps by turning combination switch to .

The driver is responsible for the operation of the vehicle's lights at all times. The automatic headlamp feature is only an aid to the driver. Switch on the vehicle lights manually when driving or when traffic conditions require you to do so.

- ▶ Turn the combination switch to **AUTO**.



If the automatic headlamp mode is activated, the fog lamps can also be switched on (> page 105). The low beam headlamp and parking lamps are activated simultaneously.



If you drive in countries where vehicles drive on the other side of the road than the country where the vehicle is registered, you must have the headlamps modified for symmetrical low beams. Relevant information can be obtained at your authorized Mercedes-Benz Light Truck Center.

Daytime running lamp mode

Canada only:

- ▶ Turn combination switch to position **0** or **AUTO**.

When the engine is running, the low beam headlamps are automatically switched on. In low ambient light conditions the parking lamps will also switch on.

When you shift from a driving position to position **N** or **P**, the low beam switches off (3 minutes delay).

For nighttime driving you should turn the combination switch to position  to permit activation of the high beam headlamps.



The high beam flasher is always available.

Lighting

Night security illumination

When you turn off the engine and the last door has been closed, the following lamps will remain lit:

- Parking lamps
- Tail lamps
- License plate lamps
- Front fog lamps

The combination switch must be set to position **AUTO** (▷ page 102).



You can reactivate this function within ten minutes by opening a door or the liftgate.

If you do not open a door or the liftgate after turning off the engine, the lamps will automatically switch off after 60 seconds.

Deactivating night security illumination temporarily

- ▶ Before leaving the vehicle turn the key in the steering lock to position **0** then turn it to position **2** and back to **0**.

The night security illumination is deactivated. It will reactivate as soon as you reinsert the key in the steering lock.

Setting illumination time



1 Switch for fog lamps

- ▶ Stop the vehicle.
- ▶ Make sure that the ignition is switched on.
All the lamps in the instrument cluster light up.
- ▶ Turn combination switch to position **0**.
- ▶ Press upper part **1** of switch until the clock, located in the instrument cluster, displays the actual illumination time.
- ▶ Press upper part **1** of switch again.

Each time the switch is pressed, the illumination time increases by 15 seconds. You can set the illumination time between 0 (off) and 60 seconds.

Approximately five seconds after pressing the switch, the illumination time is set and the clock is displayed again.

Locator lighting

During darkness, the following lamps will come on when the vehicle is unlocked by remote control:

- Parking lamps
- Tail lamps
- License plate lamps
- Front fog lamps

The combination switch must be set to position **AUTO** (▷ page 102).

The locator lighting switches off when the driver's door is opened. It switches off automatically after a period of approximately 40 seconds.

Fog lamps



The fog lamps can be switched on with combination switch in position  or U. Consult your state Motor Regulations regarding allowable lamp operation.

The switch is located on the upper center console.



- 1 Front fog lamps
- 2 Indicator lamp
- 3 Front fog lamps and rear fog lamp

Switching on front fog lamps

- ▶ Check that the low beam headlamps are switched on.
- ▶ Press upper part **1** of switch.

The green indicator lamp  in the instrument cluster lights up.

Switching on front fog lamps and rear fog lamp

- ▶ Check that the low beam headlamps are switched on.
- ▶ Press lower part **3** of switch.

The green indicator lamp  in the instrument cluster lights up in addition to the yellow indicator lamp **2** in the switch.

Switching off front fog lamps and rear fog lamp

- ▶ Press lower part **3** of switch.

The green indicator lamp  in the instrument cluster and the yellow indicator lamp **2** in the switch go out.

Lighting

Switching off rear fog lamp

- ▶ Press upper part **1** of switch.

The yellow indicator lamp **2** in the switch goes out.

Switching off front fog lamps

- ▶ Press upper part **1** of switch.

The green indicator lamp **30** in the instrument cluster goes out.

Hazard warning flasher

The hazard warning flasher can be activated with the ignition switched on or off. It is activated automatically when an airbag is deployed.

The switch is located on top of the steering column.

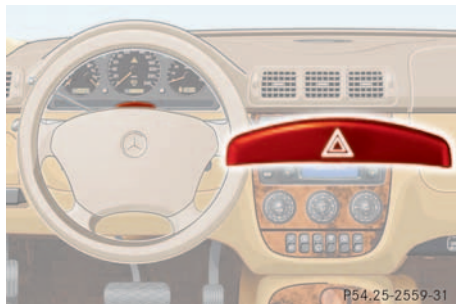

Hazard warning flasher switch

Switching on hazard warning flasher

- ▶ Press the hazard warning flasher switch.

All the turn signals will blink.

Switching off hazard warning flasher

- ▶ Press hazard warning flasher switch again.



If the hazard warning flasher was activated automatically, press the hazard warning flasher switch twice to deactivate.

Interior lighting

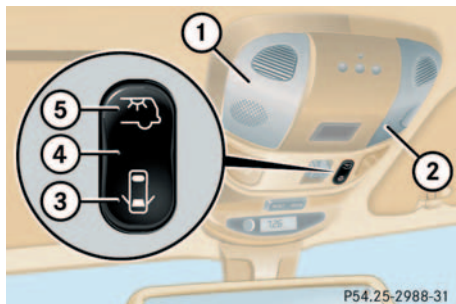

- 1 Left front interior lamp
- 2 Right front interior lamp
- 3 Automatic function off
- 4 Automatic function on
- 5 Rear interior lighting

Automatic control

Activating

- ▶ Bring the rocker switch in center position **4**.

Interior lamps (except cargo compartment lamp) are switched on in darkness when you

- unlock the vehicle
- open a door
- remove the key from the steering lock

In addition, the entry/exit lamps in the door trays will come on when you open a door.

When all doors are closed and no key is inserted in the steering lock, the interior lamps are switched off after a brief delay.



If the door remains open, the interior lamps (except cargo compartment lamp) switch off automatically after approximately 30 minutes.

Deactivating

- ▶ Press lower part **3** of rocker switch .

The interior lighting and the entry/exit lamps remain switched off in darkness, even when you

- unlock the vehicle
- open a door
- remove the key from the steering lock

Lighting

Manual control



If a lamp is switched on manually, it will not go out automatically. This could cause the battery to become discharged.

Switching on front interior lamps

- ▶ Press on lamp lens **1** or **2**.

The respective lamp switches on.

Switching off front interior lamps

- ▶ Press on lamp lens **1** or **2** again.

The respective lamp switches off.

Operating rear interior lighting with rocker switch

- ▶ Press on upper part **5** of rocker switch.

The rear interior lighting goes on.

- ▶ Press on upper part **5** of rocker switch again.

The rear interior lighting goes off.

If the switch is pressed while the rear interior lighting is on, the function is reversed.

Operating rear interior lighting with lamp lens

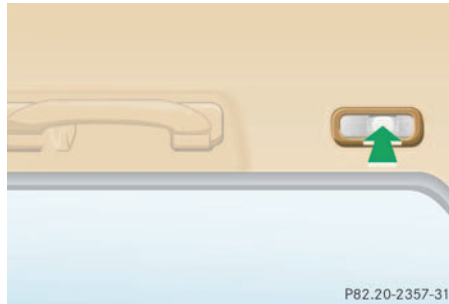

Rear interior lighting

- ▶ Push on lamp lens (arrow) to switch rear interior lighting on or off.

Reading lamps in inside rear view mirror

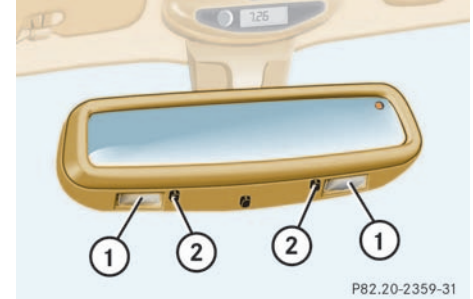

- 1** Reading lamps
- 2** Reading lamps on/off

Switching on reading lamp

- ▶ Press button **2**.

Switching off reading lamp

- ▶ Press button **2** again.

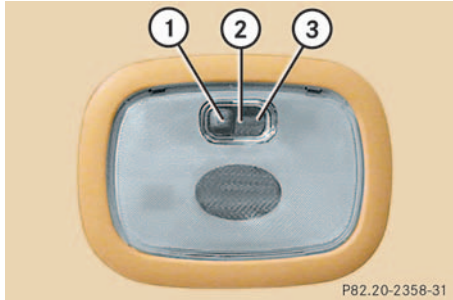
Cargo compartment lamp

- 1 Switched off
- 2 Switched on continuously
- 3 Automatic control

Switching off cargo compartment lamp

- ▶ Slide the switch to position **1**.
The cargo compartment lamp is switched off, even when the liftgate is opened.

Switching on continuous cargo compartment lamp

- ▶ Slide the switch to position **2**.
The cargo compartment lamp is switched on continuously.



To prevent the vehicle battery from being discharged, make sure that the switch is not in position **2** when leaving the vehicle.

Automatic control

- ▶ Slide the switch to position **3**.
The cargo compartment lamp is switched on and off by opening or closing the liftgate.

Instrument cluster

Instrument cluster

A full view illustration of the instrument cluster can be found in the “At a glance” section of this manual (▷ page 24).



- 1 Left knob
- 2 Right knob

The instrument cluster is activated when you:

- open the driver's door
- turn the key in steering lock to position **1** or **2** (▷ page 33)
- press the left knob **1**

Instrument cluster illumination



You can set the instrument cluster illumination with the following lamps on:

- parking lamps
- low beam headlamps
- high beam headlamps

To brighten illumination

- ▶ Turn knob **1** clockwise.

The instrument cluster illumination will brighten.

To dim illumination

- ▶ Turn knob **1** counterclockwise.

The instrument cluster illumination will dim.

Coolant temperature gauge

Under normal driving conditions, the coolant temperature may rise to 248°F (120°C). The coolant temperature may climb to the red marking:

- at high outside temperatures
- during stop-and-go city traffic
- when driving on hilly terrain

The engine should not be operated with the coolant temperature in the red zone. Doing so may cause serious engine damage which is not covered by the Mercedes-Benz Limited Warranty.

Warning!



Driving when your engine is badly overheated can cause some fluids which may have leaked into the engine compartment to catch fire. You could be seriously burned.

Steam from an overheated engine can cause serious burns and can occur just by opening the engine hood. Stay away from the engine if you see or hear steam coming from it.

Turn off the engine, get out of the vehicle and do not stand near the vehicle until it cools down.

Display in the speedometer

Changing display

- ▶ Press the left knob **1** in the instrument cluster (▷ page 110).

The display changes between main odometer and trip odometer.

- ▶ Press the left knob **1** twice.

The next scheduled service is displayed (▷ page 215).

Instrument cluster

Resetting trip odometer

- ▶ Press the left knob **1** (▷ page 110) repeatedly until you see the trip odometer display.
- ▶ Press and hold the left knob **1** until the trip odometer is reset.

Tachometer

To help protect the engine, the fuel supply is interrupted if the engine is operated above its specified limit.

Outside temperature indicator

Warning!



The outside temperature indicator is not designed to serve as an ice-warning device and is therefore unsuitable for that purpose.

Indicated temperatures just above the freezing point do not guarantee that the road surface is free of ice. The road may still be icy, especially in wooded areas or on bridges.

When moving the vehicle into colder ambient temperatures (e.g. when leaving your garage), you will notice a delay before the lower temperature is displayed.

A delay also occurs when ambient temperatures rise. This prevents inaccurate temperature indications caused by heat radiated from the engine during idling or slow driving.

Setting the clock

Hour

- ▶ Pull out the right knob **2** in the instrument cluster (▷ page 110) and turn it counterclockwise.

Minutes

- ▶ Pull out the right knob **2** in the instrument cluster (▷ page 110) and turn it clockwise.



To set the clock by a single hour or a few minutes, turn knob **2** just a few degrees in the direction indicated for hours or minutes.

Automatic transmission

Information for driving with an automatic transmission is found in the “Getting started” section (▷ page 44).

Your transmission adapts its gear shifting process to your individual driving style by continually adjusting the shift points up or down. These shift point adjustments are performed based on current operating and driving conditions.

If the operating conditions change, the automatic transmission reacts by adjusting its gear shift program.

The automatic transmission selects individual gears automatically, dependent upon

- the selector lever position **D** with gear ranges **4, 3, 2, 1**
- the position of the accelerator pedal (▷ page 117)
- the vehicle speed

Warning!



It is dangerous to shift the selector lever out of **P** or **N** if the engine speed is higher than idle speed. If your foot is not firmly on the brake pedal, the vehicle could accelerate quickly forward or reverse. You could lose control of the vehicle and hit someone or something. Only shift into gear when the engine is idling normally and when your right foot is firmly on the brake pedal.

When the selector lever is in position **D**, you can influence transmission shifting by

- limiting the gear range
- changing gears yourself

One-touch gearshifting

Even with an automatic transmission you can change the gears yourself when the selector lever is in position **D**.

Downshifting

- ▶ Briefly press the selector lever to the left in the **D-** direction.

The transmission will shift from the current gear to the next lower gear. This action simultaneously limits the gear range of the transmission (▷ page 114).

Warning!



On slippery road surfaces, never downshift in order to obtain braking action. This could result in drive wheel slip and reduced vehicle control. Your vehicle's ABS will not prevent this type of loss of control.

Automatic transmission



To avoid overrevving the engine when the selector lever is moved to the **D-** direction, the transmission will not shift to a lower gear if the engine's max. speed would be exceeded.

Upshifting

- ▶ Briefly press the selector lever to the right in the **D+** direction.

The transmission will shift from the current gear to the next higher gear as permitted by the shift program. This action simultaneously extends the gear range of the transmission.

Canceling gear range limit

- ▶ Press and hold the selector lever in the **D+** direction until **D** reappears in the tachometer display field.

Shifting into optimal gear range

- ▶ Press and hold the gear selector lever in the **D-** direction.

The transmission will automatically select the gear range suited for optimal acceleration and deceleration. This will involve shifting down one or more gears.

Gear ranges

With the selector lever in position **D**, you can limit the transmission's gear range by pressing the lever to the left (**D-**), and reverse the gear range limit by pressing the lever to the right (**D+**).

The selected gear range will appear in the tachometer display field. If you press on the accelerator when the engine has reached its rpm limit, the transmission will upshift beyond any gear range limit selected.

Gear range	Effect
4	The transmission shifts through fourth gear only.
3	The transmission shifts through third gear only. With this selection you can use the braking effect of the engine.

Gear range	Effect
2	The transmission shifts through second gear only. Allows the use of engine's braking power when driving <ul style="list-style-type: none"> • on steep downgrades • in mountainous regions • under extreme operating conditions
1	The transmission operates only in first gear For maximum use of engine's braking effect on very steep or lengthy downgrades.

Gear selector lever position

	Effect
P	<p>Park position</p> <p>Selector position when the vehicle is parked. Only place selector lever in position P when vehicle is stopped. The park position is not intended to serve as a brake when the vehicle is parked. Rather, the driver should always set the parking brake in addition to placing the selector lever in position P to secure the vehicle.</p> <p>The key can only be removed from the steering lock with the selector lever in position P. With the key removed the selector lever is locked in position P.</p> <p>If the vehicle electrical system is malfunctioning, the selector lever could remain locked in position P (▷ page 245).</p>
R	Place selector lever in position R only when vehicle is stopped.

Automatic transmission

	Effect
N	<p>Neutral</p> <p>No power is transmitted from the engine to the drive axle. When the brakes are released, the vehicle can be moved freely (pushed or towed).</p> <p>To avoid damage to the transmission, never engage N while driving.</p> <p>If the ESP is deactivated or malfunctioning: Only move selector lever to N if the vehicle is in danger of skidding (e.g. on icy roads).</p>
D	<p>The transmission shifts automatically. All five forward gears are available.</p>



Coasting the vehicle, or driving for any other reason with selector lever in **N** can result in transmission damage that is not covered by the Mercedes-Benz Limited Warranty.

Warning!



Getting out of your vehicle with the selector lever not fully engaged in position **P** is dangerous. Also, position **P** alone is not intended to or capable of preventing your vehicle from moving, possibly hitting people or objects.

Always set the parking brake in addition to shifting to position **P** (▷ page 50).

When parked on an incline, turn the front wheels towards the road curb.

Warning!



When leaving the vehicle always remove the key from the steering lock and lock the vehicle. Do not leave children unattended in the vehicle, or with access to an unlocked vehicle. Children could move the selector lever from position **P**, which could result in an accident and/or serious personal injury.

Accelerator position

Your driving style influences the transmission's shifting behavior:

Less throttle	Earlier upshifting
More throttle	Later upshifting

Kickdown

Use kickdown when you want maximum acceleration

- ▶ Press the accelerator past the point of resistance.

The transmission shifts into a lower gear.

- ▶ Ease on the accelerator when you have reached the desired speed.

The transmission shifts up again.

Towing a trailer

If you tow a trailer, note the following points:

- Manually shift to a lower gear range (**4, 3, 2, 1**), if the transmission hunts between gears on inclines (▷ page 114).
A lower gear range and reduction of speed reduces the change to overload or overheat the engine.
- At very steep inclines switch transfer case to **LOW RANGE** mode (▷ page 118).

For more information on trailer towing, see the "Operation" section (▷ page 192).

Emergency operation (Limp Home Mode)

If the vehicle acceleration worsens or the transmission no longer shifts, the transmission is most likely operating in limp home mode. In this mode only 2nd gear and reverse gear can be activated.

- ▶ Stop the vehicle.
- ▶ Move selector lever to position **P**.
- ▶ Turn off the engine.
- ▶ Wait at least ten seconds before re-starting.
- ▶ Move selector lever to position **D** (for 2nd gear) or **R**.
- ▶ Have the transmission checked at an authorized Mercedes-Benz Light Truck Center as soon as possible.

Transmission control – LOW RANGE mode

Transmission control – LOW RANGE mode

In the following situations you should switch to LOW RANGE mode:

- during off-road driving
- when crossing water
- when towing up or down on steep gradients



Only switch the LOW RANGE mode on or off, when the vehicle is

- at a complete standstill
- the engine speed is less than 1500 rpm

Failure to do so may result in transmission or engine damage which is not covered by the Mercedes-Benz Limited Warranty.



You should only operate the vehicle on a single axle dynamometer for briefly testing the brakes.

The key must be in steering lock position 1.

Switching on LOW RANGE mode



LOW RANGE mode switch

- ▶ Stop the vehicle.
- ▶ Move the selector lever to position **N**.

- ▶ Press on the upper part of the switch.

During the changeover the indicator lamp (▷ page 25) blinks three times.

Once the changeover is complete, the indicator lamp lights up continuously.

Switching off LOW RANGE mode

- ▶ Stop the vehicle.
- ▶ Move the selector lever to position **N**.
- ▶ Press on the upper part of the switch.

During the changeover the indicator lamp (▷ page 25) blinks three times.

Once the changeover is complete, the indicator lamp goes out.

For information on driving safety systems during LOW RANGE mode see the “Safety and Security” section (▷ page 71).

Good visibility

Information on the windshield wipers (▷ page 47) and for adjusting the rear view mirrors (▷ page 38) is found in the “Getting started” section.

Rear view mirror

Manually dimming inside rear view mirror

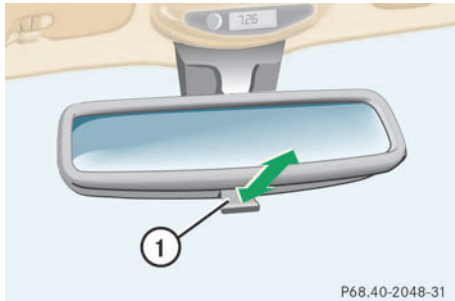

1 Lever

- ▶ Press lever **1** backward.

The interior rear view mirror is dimmed.

Automatic antiglare rear view mirror*

The reflection brightness of the exterior rear view mirror on the driver’s side and the inside rear view mirror will respond automatically to glare when:

- the automatic antiglare function is activated (▷ page 120)
- the ignition is switched on
- incoming light from headlamps falls on the sensor in the inside rear view mirror

The rear view mirror will not react if

- reverse gear is engaged
- the interior light is turned on

Warning!



The automatic antiglare function does not react if incoming light is not aimed directly at sensors in the inside rear view mirror.

The inside rear view mirror and the exterior rear view mirror on the driver’s side do not react, for example, if the cargo area is fully loaded.

Glare can endanger you and others.

Warning!



Exercise care when using the passenger side exterior rear view mirror. The mirror surface is convex (outwardly curved surface for a wider field of view). Objects in mirror are closer than they appear. Check your inside rear view mirror or glance over your shoulder before changing lanes.

Good visibility

Warning!



In the case of an accident, liquid electrolyte may escape the mirror housing if the mirror glass breaks.

Electrolyte has an irritating effect. Do not allow the liquid to come into contact with eyes, skin, clothing, or the respiratory system. In case it does, immediately flush affected area with water, and seek medical help if necessary.



Electrolyte drops coming into contact with the vehicle paint finish can only be completely removed while in their liquid state and by applying plenty of water.

Activating

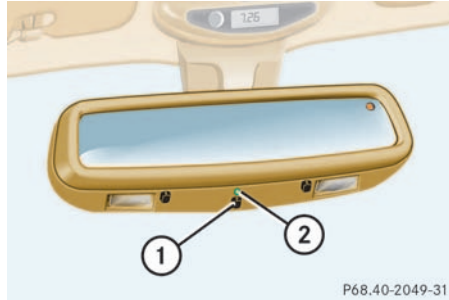

- 1 Button
- 2 Indicator lamp

- ▶ Press button 1.
The indicator lamp 2 comes on.

Deactivating

- ▶ Press button 1 again.
The indicator lamp 2 goes out.

Folding exterior mirrors in and out*

The exterior rear view mirrors can vibrate if they are not completely folded out.

The buttons are located on the upper center console.



- 1 Folds the exterior mirrors in
- 2 Folds the exterior mirrors out

- ▶ Check that the ignition is switched on.
All the lamps in the instrument cluster light up.





With the front doors closed, the exterior mirrors can still be folded in and out approximately 30 minutes after the ignition has been turned off.

Folding in

- ▶ Briefly press button **1**.

The mirrors fold in.



Before you drive the vehicle through an automatic car wash, fold the exterior mirrors in, otherwise they may get damaged.



If you are driving at more than 9 mph (15 km/h), you will not be able to fold the exterior mirrors in.

Folding out

- ▶ Briefly press button **2**.

The mirrors fold out.



If an exterior mirror housing is forcibly pushed forward (hit from the rear), reposition it manually by applying firm pressure until it snaps back into place.

If an exterior mirror is forcibly pushed rearward (hit from the front) press button **1** to fold mirrors in, then press button **2** to fold mirrors out. Do not force mirror by hand.

The mirror housing is now properly positioned and you can adjust the mirror normally.

Headlamp cleaning system*

The switch is located on the right side of the dashboard.



Headlamp washer switch

- ▶ Switch on ignition.
- ▶ Briefly press the upper part of switch.

Good visibility

Windshield wipers

Information on the windshield wipers (▷ page 47) is found in the “Getting started” section.



If leaves, snow, etc. block the windshield wipers, the wiper motor turns off.

- For safety reasons, withdraw key from steering lock. Remove blockage.
- Turn the windshield wipers on again.

If windshield wipers fail to function at all in switch position **1**,

- set the wiper switch to the next highest wiper speed.
- have the windshield wipers checked at the nearest authorized Mercedes-Benz Light Truck Center.

Intermittent wiping



Intermittent wiping is interrupted when the vehicle is at standstill and a front door is opened.

Windshield wipers without rain sensor

At speeds of approximately 105 mph (170 km/h) the wiper switches automatically to continuous wiping. Always obey local speed limits.

*Windshield wipers with rain sensor**

The rain sensor controls the windshield wipers automatically according to the amount of water on the windshield.

- ▶ Switch ignition on.
- ▶ Set the wiper switch to position **1** (▷ page 47).

One initial wipe, pauses between wipes are automatically controlled by the rain sensor monitoring wetness of windshield.



To prevent damage of the windshield wipers, do not leave the wiper switch in intermittent setting, when the vehicle is taken to an automatic car wash or when cleaning the windshield.

The switch should not be left in intermittent setting as the wipers will wipe the windshield once every time the engine is started. Dust that accumulates on the windshield might scratch the glass when wiping occurs on a dry windshield!



When intermittent wiping is on and the key is turned from position **1** to position **2** in the steering lock (▷ page 33), and kept in that position for longer than 2 seconds, the wipe interval will be set to approximately 5 seconds.

Rear window wiper

The rear window wiper will also automatically engage if the windshield wiper is engaged and the gear selector lever is placed in reverse.

Rear window wiper with rain sensor*

Rear window wiper intervals are controlled automatically according to the amount of water on the windshield and the speed of the vehicle, if:

- rear window wiper is switched on
- front windshield wipers are switched to intermittent wiping

The interval for the rear window wiper remains constant when the windshield wiper interval is ten seconds or more.

Sun visor

The sun visors protect you from sun glare while driving.

Warning!



Do not use the vanity mirror while driving.

Keep the mirrors in the sun visors closed while vehicle is in motion. Reflected glare can endanger you and others.

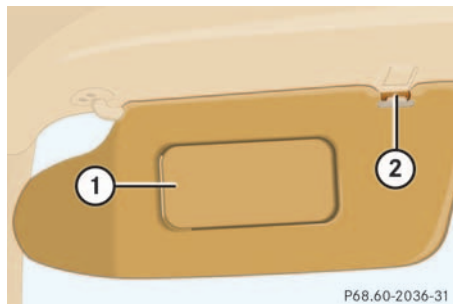

- 1 Mirror cover
- 2 Mounting

- ▶ Swing sun visors down when you experience glare.
- ▶ To use mirror, lift cover **1** up.



If sunlight enters through a side window, disengage sun visor from mounting **2** and pivot to the side.

Illuminated vanity mirrors

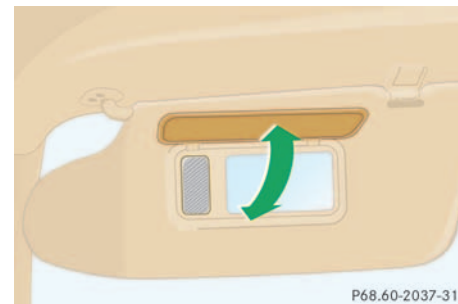

- ▶ Turn the key in steering lock to position **1** (▷ page 33).
- ▶ Lift cover up.
The lamp switches on.

Automatic climate control

Automatic climate control

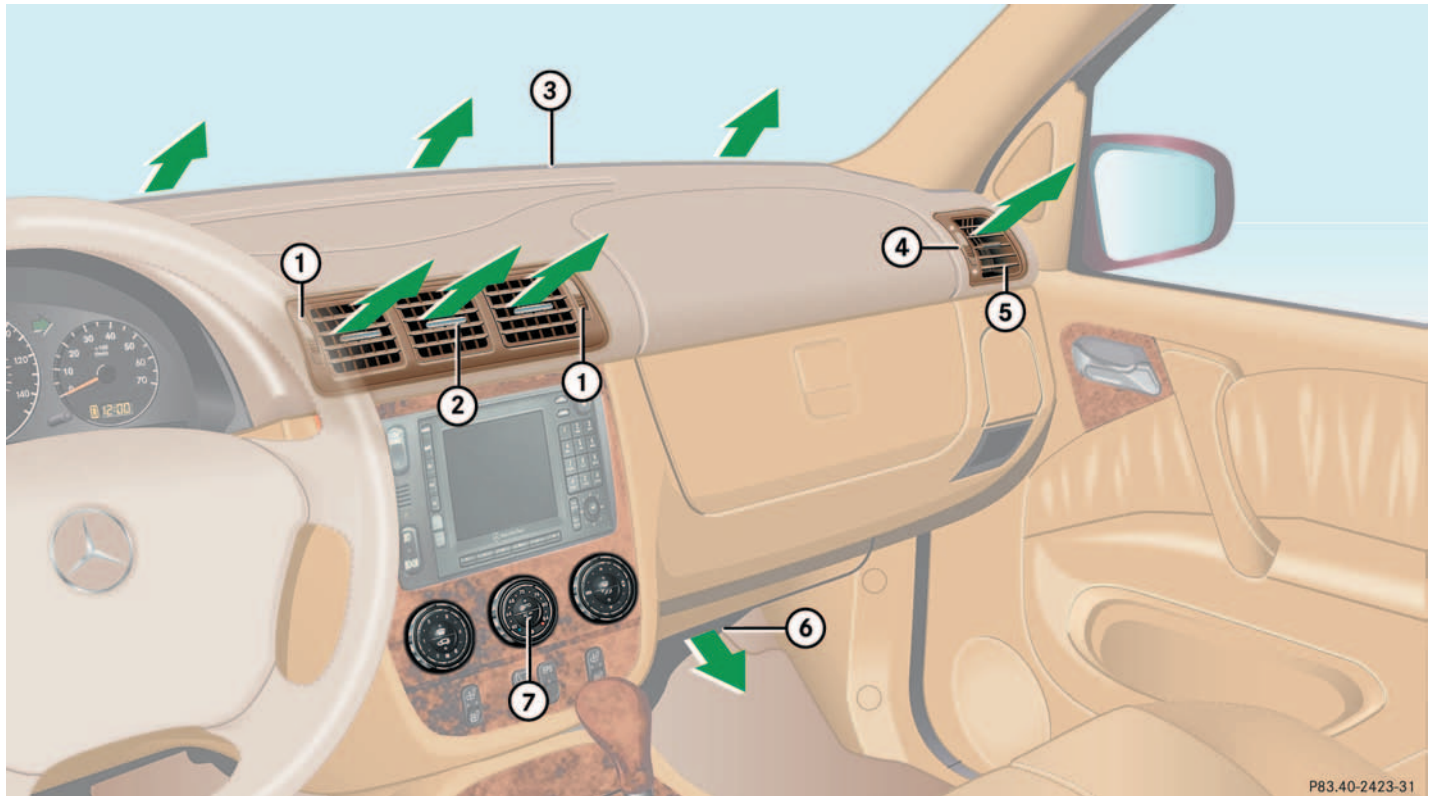

P83.40-2423-31

Automatic climate control

Item
1 Thumbwheel center air outlet
2 Center air outlet, adjustable
3 Defroster air outlet windshield
4 Thumbwheels side air outlet
5 Side air outlet, adjustable
6 Footwell air outlet
7 Automatic climate control

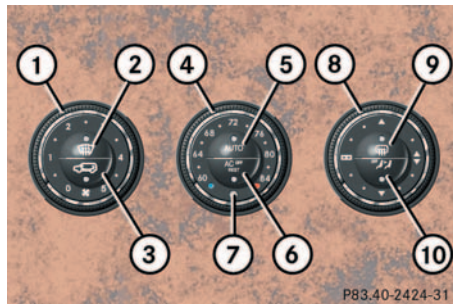

Automatic climate control panel in the front

Item
1 Air volume control
2 Defrosting
3 Air recirculation
4 Temperature control
5 Automatic control (temperature, air distribution, air volume)
6 AC^{OFF} (AC cooling on/off), economy mode Residual heat/ventilation
7 Interior temperature sensor
8 Air distribution control
9 Rear window defroster
10 Rear passenger compartment ventilation on/off

Automatic climate control

The automatic climate control is operational whenever the engine is running. You can operate the climate control system in either the automatic or manual mode. The system cools or heats the interior depending on the selected interior temperature and the current outside temperature.

Nearly all dust particles, pollutants and odors are filtered out before outside air enters the passenger compartment through the air distribution system.

Warning!



Follow the recommended settings for heating and cooling given on the following pages. Otherwise the windows could fog up, impairing visibility and endangering you and others.



Severe conditions (e.g. strong air pollution) may require replacement of the filter before its scheduled interval. A clogged filter will reduce the air volume to the interior.

If the vehicle interior is hot, ventilate the interior before driving off.

Keep the air intake grille in front of the windshield free of snow and debris.

Do not touch the interior temperature sensor to maintain a precise temperature.

The set value is indicated by a lighted segment on the control wheels.

Automatic mode

Switching on

- ▶ Briefly press button **AUTO** (▷ page 125).

The indicator lamp lights up. The temperature, air volume and distribution are controlled automatically.

- ▶ Adjust the temperature with the temperature control **4** (▷ page 125).

Temperature control is switched off in the extreme position (blue or red dot).

Switching off

- ▶ Briefly press button **AUTO** (▷ page 125).

The indicator lamp goes out. The automatic mode is switched off

Air volume control **1** is set to fan speed 2 and air distribution is set to .

Activating basic setting

- ▶ Press button **AUTO** at least three seconds.

All functions are switched to automatic mode and temperature is set to 72°F (22°C).

Changing basic setting

- ▶ Set temperature control **4** (▷ page 125) to desired temperature.
- ▶ Press button **AUTO** for ten seconds. The selected temperature value is stored and set.



Adjust temperature settings in small increments.

Adjusting air volume and air distribution manually



If you turn air volume control **1** (▷ page 125) or air distribution control **8**, the automatic mode switches off. The indicator lamp in the button **AUTO** goes out. The temperature control will still be in automatic mode.

Adjusting air volume

- ▶ Turn air volume control **1** to one of five air volume settings.







When set to 0, the system is fully deactivated and no fresh air is supplied. This setting should only be selected for short periods of time.



Automatic climate control

Adjusting air distribution

- ▶ Turn air distribution control **8** (▷ page 125) to one the following symbols:

Symbol	Function
	Directs air to the center and side air outlets
	Directs air to the windshield and side air outlets
	Directs air into the entire vehicle interior
	Directs air to the footwells and side air outlets

Windshield fogged on the outside

- ▶ Switch the windshield wipers on.
- ▶ Turn air distribution control **8** to  or .

Defrosting



These settings should only be selected for a short time.

When the defrost setting has been selected, only the rear window defroster can be switched on. No other settings are possible.

Activating

- ▶ Press button  (▷ page 125).

The indicator lamp on the button lights up.

Deactivating

- ▶ Press button  again.

or

- ▶ Press button **AUTO** (▷ page 125).

The indicator lamp on the button lights up.

The indicator lamp on the button lights up.

Air recirculation mode

Switch to air recirculation mode to prevent unpleasant odors from entering the vehicle from the outside. This setting cuts off the intake of outside air and recirculates the air in the passenger compartment.

Warning!



When the outside temperature is below 41 °F (5°C), only switch to air recirculation mode for short periods to prevent window fogging.

Activating

- ▶ Press button  (> page 125).

The indicator lamp on the button lights up.



To achieve the fastest possible cooling of the interior, the automatic climate control automatically switches to air recirculation. The indicator lamp in the button  is not illuminated when the system automatically switches to air recirculation.

Deactivating

- ▶ Press button  (> page 125).

The indicator lamp on the button goes out.



The air recirculation mode is activated automatically after

- 30 minutes if the automatic climate control is switched on
- after five minutes if the air conditioning is switched off
- after five minutes if the outside temperature is above approximately 45°F (7°C)

Air conditioning

The air conditioning is operational while the engine is running and cools the interior air to the temperature set by the operator.



Condensation may drip out from underneath the vehicle. This is normal and not an indication of a malfunction.

Deactivating

It is possible to deactivate the air conditioning (cooling) function of the automatic climate control system. The air in the vehicle will then no longer be cooled or dehumidified.

- ▶ Press button  (> page 125).

The indicator lamp on the button  lights up.

Automatic climate control

Activating

Moist air can fog up the windows. You can dehumidify the air with the air conditioning.

- ▶ Press button  again.

The indicator lamp on the button  goes out.

The air conditioning system uses the refrigerant R134A. This refrigerant is free of CFCs which are harmful to the ozone layer.



If the  button on the automatic climate control panel starts to blink, this indicates that the air conditioning system is losing refrigerant. The compressor has turned itself off. The air conditioning cannot be turned on again.

Have the air conditioning system checked at the nearest authorized Mercedes-Benz Light Truck Center.

Residual heat and ventilation

With the engine switched off, it is possible to continue to heat or ventilate the interior for up to 30 minutes. This feature makes use of the residual heat produced by the engine.



How long the system will provide heating depends on the coolant temperature and the temperature set in the climate control. The blower will run at lower speed regardless of the air volume control setting.

Activating

- ▶ Turn the key in the steering lock to position 1.
- ▶ Press button  (▷ page 125).

The indicator lamp on button  comes on.

Deactivating

- ▶ Press button .

The indicator lamp on button  goes out.



The residual heat is automatically turned off:

- when the ignition is switched on
- after about 30 minutes
- if the coolant temperature is too low
- if the battery voltage drops

Rear window defroster

The rear window defroster uses a large amount of power. To keep the battery drain to a minimum, switch off the defroster as soon as the rear window is clear. The defroster is automatically deactivated after approximately 6 to 17 minutes of operation depending on the outside temperature.

Activating

- ▶ Switch ignition on.
- ▶ Press button  (> page 125).
The indicator lamp on the button lights up.

Deactivating

- ▶ Press button  again.
The indicator lamp on the button goes out.

Warning!



Any accumulation of snow and ice should be removed from the rear window before driving. Visibility could otherwise be impaired, endangering you and others.



If the rear window defroster switches off too soon and the indicator lamp starts blinking, this means that too many electrical consumers are operating simultaneously and there is insufficient voltage in the battery. The system responds automatically by deactivating the rear window defroster.

As soon as the battery has sufficient voltage, the rear window defroster automatically turns itself back on.

Rear passenger compartment ventilation and rear automatic climate control

Deactivating

For an improved cooling or heating output in the front passenger compartment, you can switch off the rear passenger compartment ventilation.

- ▶ Press button  (> page 125).

The indicator lamp on the button lights up.

The operation of the rear automatic climate control and the fresh air supply to the rear compartment is shut off.

Activating

- ▶ Press button  again.

The indicator lamp on the button goes out.

The rear automatic climate control switches to automatic mode and fresh air enters the rear compartment.

Automatic climate control

Automatic mode

The automatic climate control panel for the rear is located on the rear center console.

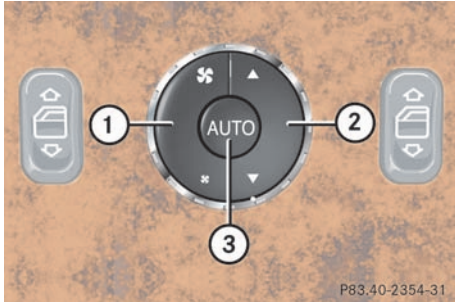

- 1 Air volume control
- 2 Air distribution control
- 3 Automatic control (air distribution, air volume)

- ▶ Press button **AUTO**.

The indicator lamp on the button lights up.

The automatic climate control cools or heats the interior depending on the temperature selected on the front climate control unit.

Adjusting air volume and air distribution manually



When the air volume or air distribution control is pressed, the automatic mode is switched off. The indicator lamp in button **AUTO** is turned off. Temperature setting remains in automatic mode.

Adjusting air volume

- ▶ Press upper part of button

The blower setting is increased each time the button is pressed.

- ▶ Press lower part of button

The blower setting is decreased each time the button is pressed.

Adjusting air distribution

- ▶ Press , upper part of button 2.

Air is directed upwards.

- ▶ Press , lower part of button 2.

Air is directed to the footwell.

Front and rear air outlets





For draft-free ventilation, adjust the air outlets upwards

To allow unrestricted operation of the automatic climate control, the air outlets should remain open.

Adjusting side air outlets

- ▶ Turn thumbwheel **4** (▷ page 125), to one of the following positions:

Symbol	Function
	Open
	Ventilation of side windows in area of exterior mirror
0	Closed

Center air outlets

Opening

- ▶ Turn thumbwheel center air outlet **1** (▷ page 125) upward to position .

Closing

- ▶ Turn thumbwheel center air outlet **1** downward to position **0**.

Use the left thumbwheel to adjust the center air outlets on the left and in the center. Use the right thumbwheel to adjust the right center air outlet.

Rear passenger compartment air outlets

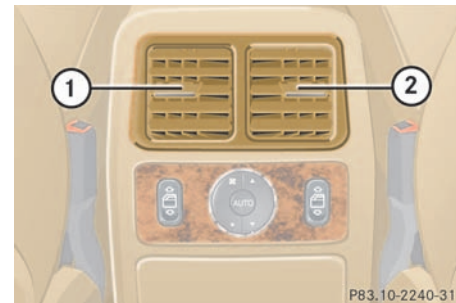

- 1 Adjustable center air outlet, left
- 2 Adjustable center air outlet, right



The temperature at the air outlets for the rear passenger compartment is the same as at the dashboard center air outlets.

Power windows

Power windows

Opening and closing the side windows

The power window switches are on the front center console.

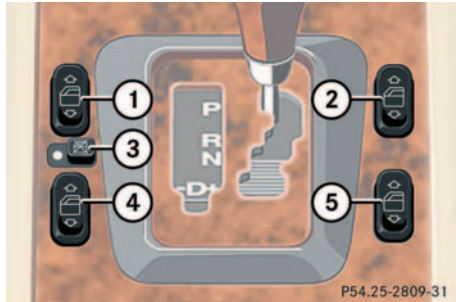

- 1 Left front
- 2 Right front
- 3 Switch for rear door window override
(▷ page 69)
- 4 Left rear
- 5 Right rear

Additional switches for the rear windows are located on the rear center console.



- 6 Left rear
- 7 Right rear

Warning!



When closing the windows, make sure that there is no danger of anyone being harmed by the closing procedure.

When leaving the vehicle, always remove the key from steering lock and lock your vehicle. Do not leave children unattended in the vehicle, or with access to an unlocked vehicle. Unsupervised use of vehicle equipment may cause an accident and/or serious personal injury.

To operate the power windows, turn key to position 2 (▷ page 33) in the steering lock.

Opening the windows

- ▶ Press switch  to resistance point.
The window will move downwards until you release the switch.

Closing the windows

- ▶ Press switch  to resistance point.
The window will move upwards until you release the switch.

Fully opening the windows

- ▶ Press switch  past the point of resistance and release.

Fully closing the windows

- ▶ Press switch  past the point of resistance and release.



If the side window is blocked in the upper area, the closing process is interrupted and the window reopens slightly.

Remove the obstruction, press switch  past the point of resistance again and release.

If the window still does not close without an object having been trapped, then hold the  switch down. The side window will then close without the obstruction sensor function.





If the driver's window cannot be automatically closed without an object having been trapped, press the  switch past the point of resistance again within five seconds and release. The side windows will now close without the obstruction sensor function.

Warning!



When closing the windows, make sure that there is no danger of anyone being harmed by the closing procedure.

Stopping the windows

- ▶ Briefly press switch  or .

Power windows

Synchronizing power windows

The side power windows must be resynchronized

- after the battery has been disconnected
- if the windows cannot be fully opened or closed
- ▶ Switch ignition on.
- ▶ Press switch  until the window is completely closed and hold down for approximately 1 second. Repeat procedure for each window.

Rear quarter windows*

The switches are on the upper part of the center console.

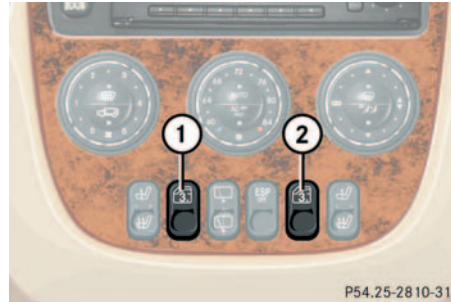

- 1 Left side
- 2 Right side

To operate the power windows, turn key to position **2** (▷ page 33) in the steering lock.

Warning!



When closing the windows, make sure that there is no danger of anyone being harmed by the closing procedure.

When leaving the vehicle, always remove the key from the steering lock, and lock the vehicle. Do not leave children unattended in the vehicle, or with access to an unlocked vehicle. Unsupervised use of vehicle equipment may cause an accident and/or serious personal injury.

Opening the windows

- ▶ Press and hold the upper part of switches **1** or **2**.
The window will open.

Closing the windows

- ▶ Press and hold the lower part of switches **1** or **2**.
The window will close.

Sliding/pop-up roof*

Opening and closing the sliding/pop-up roof

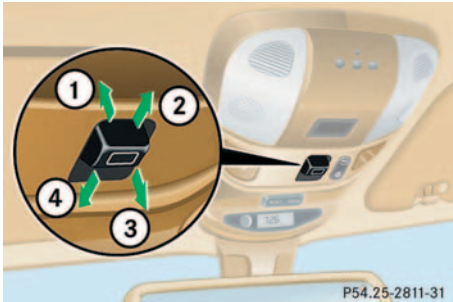

- 1 raise roof at rear
- 2 slide roof open
- 3 lower roof at rear
- 4 slide roof closed

With the roof closed or tilted open, a screen can be slid into the roof opening to guard against sun rays. When sliding the roof open, the screen will also retract.

To operate the sliding/pop-up roof, turn key to position **1** or **2** (▷ page 33) in the steering lock.

Warning!



When closing the sliding/pop-up roof, make sure that there is no danger of anyone being harmed by the closing procedure.

The closing procedure can be immediately reversed by moving the switch in direction **1** or **2**.

When leaving the vehicle, always remove the key from steering lock and lock your vehicle. Do not leave children unattended in the vehicle, or with access to an unlocked vehicle. Unsupervised use of vehicle equipment may cause an accident and/or serious personal injury.

Opening the roof

- ▶ Press and hold the switch in direction **2**.

The sliding/pop-up roof slides open until the switch is released.

Closing the roof

- ▶ Press and hold the switch in direction **4**.

The sliding/pop-up roof closes until the switch is released.

Stopping the roof

- ▶ Briefly press the switch in any direction.

The movement of the roof will stop.

Raising the roof

- ▶ Press and hold the switch in direction **1**.

The roof is raised at rear.

Lowering the roof

- ▶ Pull and hold the switch in direction **3**.

The sliding/pop-up roof is lowered and closed.

Sliding/pop-up roof*

Opening the roof automatically

- ▶ Briefly press the switch in direction **2**.

The roof will not open to the fully open position.

To open the roof fully, press switch again in direction **2**.



To interrupt procedure, briefly move switch in any direction.



To avoid damaging the seals, do not transport any objects with sharp edges which can stick out of the sliding/pop-up roof.

The sliding/pop-up roof can be opened or closed manually should an electrical malfunction occur (▷ page 246).

Synchronizing the sliding/pop-up roof

The power sliding/pop-up roof must be re-synchronized each time after the battery has been disconnected, the sliding/pop-up roof has been closed manually or the sliding/pop-up roof does not open smoothly or malfunctions (▷ page 246).

Loading

Loading instructions

Warning!



Always fasten items being carried as securely as possible using cargo tie-down rings and fastening materials appropriate for the weight and size of the load.

In an accident, during hard braking or sudden maneuvers, loose items will be thrown around inside the vehicle, and can cause injury to vehicle occupants unless the items are securely fastened in the vehicle.

To help avoid personal injury during a collision or sudden maneuver, always use partition net when transporting cargo.

Never drive vehicle with the liftgate open. Deadly carbon monoxide (CO) gases may enter vehicle interior resulting in unconsciousness and death.

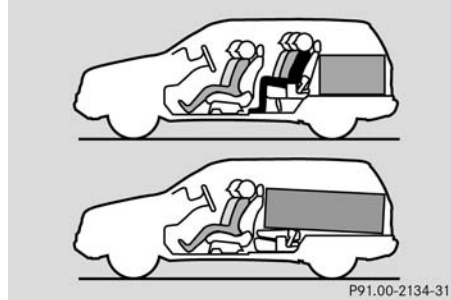

The total load weight including vehicle occupants and luggage / cargo should not exceed the vehicle capacity weight indicated on the certification label which can be found on the left door pillar.

The handling characteristics of a fully loaded vehicle depend greatly on the load distribution. It is therefore recommended to load the vehicle according to the illustrations shown, with the heaviest items being placed towards the front of the vehicle.

Please pay attention to and comply with the following instructions when loading the vehicle and transporting cargo:

- Always place items being carried against front or rear seat backrests, and fasten them as securely as possible.
- The heaviest portion of the cargo should always be kept as low as possible against front or rear seat backrests.

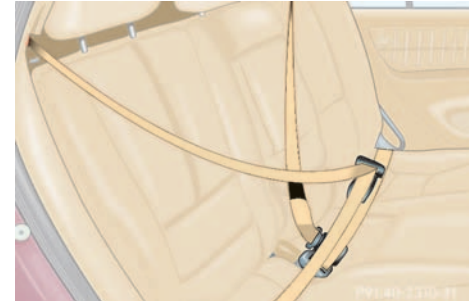

For additional safety when transporting cargo while the rear seats are unoccupied, fasten the outer seat belts crosswise into the opposite side buckles.

Loading



The trunk is the preferred place to carry objects. The enlarged cargo area should only be used for items which do not fit in the trunk alone.

Cargo tie-down rings

The cargo area is provided with four tie-down rings. Additional two rings are located at the rear of front seats.

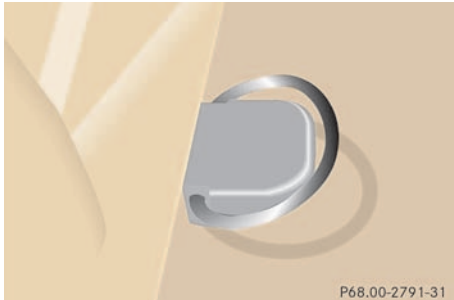

Cargo tie-down ring

Carefully secure cargo by applying even load on all rings with rope of sufficient strength to hold down the cargo.



While the partition net (> page 141) will help protect you from smaller objects, it cannot prevent the movement of large, heavier objects into the passenger area in an accident. Such items must be properly secured using the cargo tie-down rings in the cargo area floor.

Hooks

Four hooks located on the rear compartment trim panels, two on each side.



Hooks

Use the hooks to secure light weight items. The maximum permissible weight per hook is 9 lbs. (4 kg).

Partition net***Warning!**

Always lock backrest in its upright position when rear seat bench is occupied by passengers, or cargo is being carried behind the seat bench.

To help avoid personal injury from smaller objects flying in the occupant area during a collision or sudden maneuver, always use partition net when transporting cargo.

The partition net cannot prevent the movement of large, heavier objects into the passenger area in an accident. Such items must be properly secured using the cargo tie-down rings in the cargo area floor (▷ page 140).

Passenger use of seats behind installed partition net is restricted because of the footwell being taken up by the net.

Use of the partition net is a particularly important safety factor when the vehicle is loaded higher than the top of the seat backrests with smaller objects.

The partition net can be installed behind the backrests of the front or rear seats.

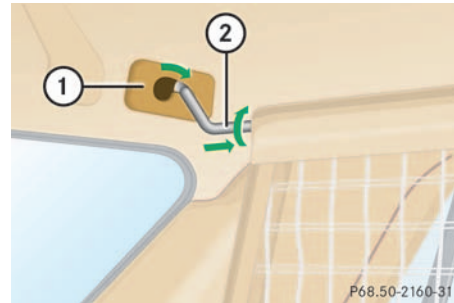
Engaging partition net

1 Holder

2 Mounting hook

- ▶ One after the other, press the two mounting hooks **2** inward against the spring pressure and turn them.

The mounting hooks are locked in this position and you can move the net into position more easily.

- ▶ Turn one of the mounting hooks **2** in the opposite direction.
The spring pressure will push it out.
- ▶ Engage mounting hook **2** in holder **1**.
- ▶ Turn the other mounting hook and engage it in the opposite holder.
- ▶ Push both mounting hooks **2** forward into holder **1**.

Loading

Tightening partition net



Before tightening the partition net, remove the cargo floor plates.

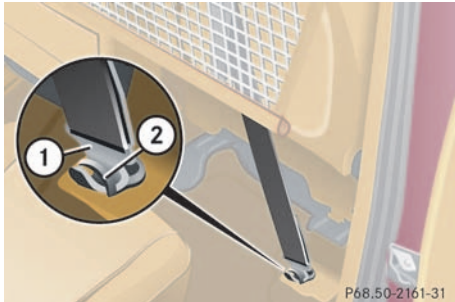

Installation behind the front seats

- 1 Tie-down hook
- 2 Ring

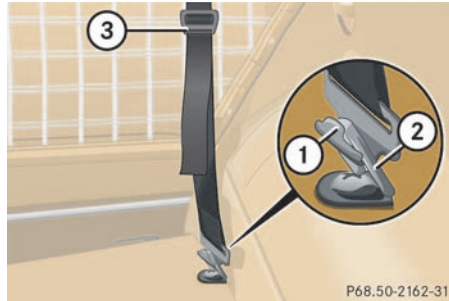

Installation behind the rear seats

- 1 Tie-down hook
- 2 Ring
- 3 Tensioner

- ▶ Insert tie-down hook 1 in rings 2.
- ▶ Pull on loose ends of tie-down straps until net is tight.
- ▶ After driving a short distance, check the tension on the net and retighten if necessary.

Removing partition net

- ▶ Lift tensioner 3 upward to a horizontal position to release tensioning of the strap.
- ▶ Disengage tie-down hooks 1 from rings 2.
- ▶ Remove mounting hooks 2 (> page 141) from holder 1 (> page 141).
- ▶ Roll up and close the partition net.
- ▶ Store partition net behind rear seat bench.

Cargo area cover blind*

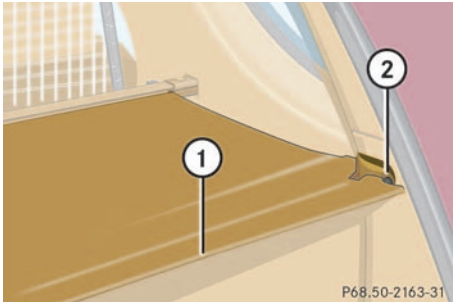

- 1 Handle
- 2 Holder

Warning!



Passenger use of third row seats with cargo area cover blind installed is restricted.

Closing blind

- ▶ Pull blind on handle **1** across the cargo area.
- ▶ Guide blind into holders **2**.

Opening blind

- ▶ Disengage blind and guide retraction by its handle.

Removing blind

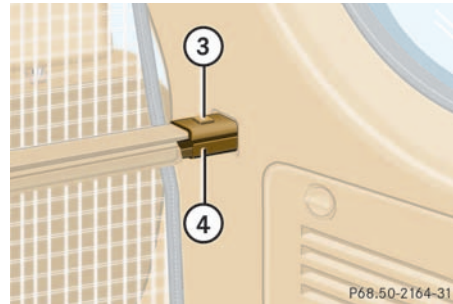

- 3 Button
- 4 Mounting sleeve

- ▶ Roll the blind up.
- ▶ Push mounting sleeve **4** inward against spring pressure until it engages.
- ▶ Remove blind from mounts.

Installing blind

- ▶ Place left side of blind in left mount.
- ▶ Position right side of blind over right mount.
- ▶ Push button **3**, releasing mounting sleeve to slide into mount.

Loading

Cargo floor plates

Removing cargo floor plates



Before you can remove the cargo floor plates, it is possible that the third row seats* (> page 96) must be removed.

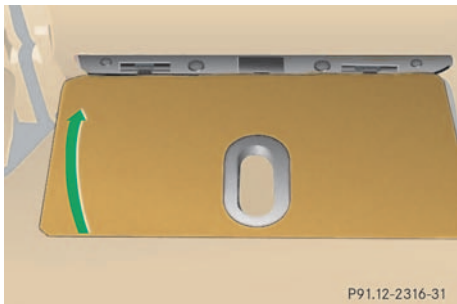

- ▶ Lift cargo floor plate at rear edge (arrow).
Cargo floor plate unhinges automatically.
- ▶ Remove cargo floor plate by pulling it rearwards.

Storing cargo floor plates

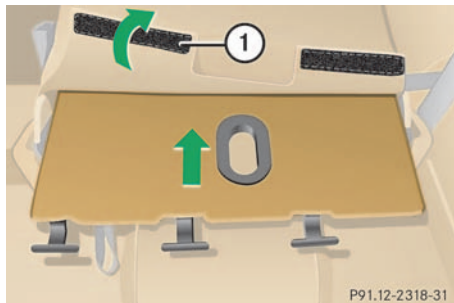

- 1** Hook and loop strip
- ▶ Fold the left cargo floor plate together.
- ▶ Open the hook and loop strip at the bottom of backrest of the third row seats* and insert cargo floor plate.
- ▶ Close the hook and loop strip.

Installing cargo floor plates

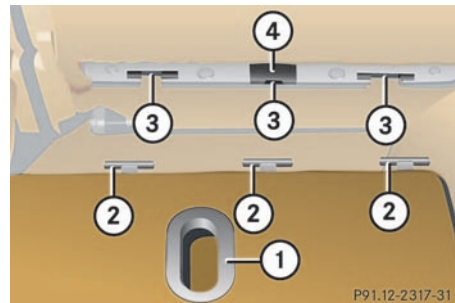

- 1** Opening
- 2** Pins
- 3** Attachment opening
- 4** Latch
- ▶ Grip into opening **1** and guide pins **2** into attachment opening **3**.
The center pin must snap into place in latch **4**.

Roof rack*

Warning!



Take into consideration that when the roof rack is loaded, the handling characteristics are different from those when operating the vehicles without the roof rack loaded.

The maximum roof load when using roof rack systems is 220 lbs. (100 kg).



P77.40-2040-31

Roof rails



Attach roof racks to the roof rails only.

Use only those roof racks approved by Mercedes-Benz for your vehicle model. Follow manufacturer's installation instructions.

The vehicle could otherwise be damaged.

For further information inquire at your Mercedes-Benz Light Truck Center.

Driving systems

Driving systems

The driving systems of your vehicle are described on the following pages:

- Cruise control, with which the vehicle can maintain a preset speed
- Parktronic*, with which you can assist your parking maneuvers.

The driving systems BAS, ABS, ESP, EBB and 4-ETS, are described in the “Safety and Security” section (▷ page 71).

Cruise control

Cruise control automatically maintains the speed you set for your vehicle.

Use of cruise control is recommended for driving at a constant speed for extended periods of time. You can set any speed over 20 mph (30 km/h).

The cruise control function is operated by means of the cruise control lever.

The cruise control lever is the uppermost lever found on the left-hand side of the steering column (▷ page 23).

Warning!



Cruise control is a convenience system designed to assist the driver during vehicle operation. The driver is and must remain responsible for the vehicle speed and for safe brake operation.

Only use cruise control if the road, traffic and weather conditions make it advisable to travel at a steady speed.

- The use of cruise control can be dangerous on winding roads or in heavy traffic because conditions do not allow safe driving at a steady speed.
- The use of cruise control can be dangerous on slippery roads. Rapid changes in tire traction can result in wheel spin and loss of control.
- Deactivate cruise control when driving in fog.

The “Resume” function should only be operated if the driver is fully aware of the previously set speed and wishes to resume this particular preset speed.

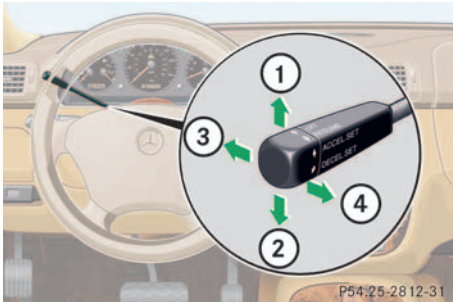

- 1 Set current or higher speed
- 2 Set current or lower speed
- 3 Cancel cruise control
- 4 Resume at previously set speed

Saving current speed

- ▶ Accelerate or decelerate to the desired speed.
- ▶ Briefly lift **1** or depress **2** the cruise control lever.

The current speed is set.

- ▶ Remove your foot from the accelerator pedal.

Cruise control is activated.



On uphill or downhill grades, cruise control may not be able to maintain the set speed. Once the grade eases, the set speed will be resumed.

Canceling cruise control

There are several ways to cancel cruise control:

- ▶ Step on the brake pedal.
- or
- ▶ Briefly push the cruise control lever to position **3**.

Cruise control will be canceled. The last speed set will be stored for later use.



Moving gear selector lever to position **N** while driving also cancels cruise control. However, the gear selector lever should not be moved to position **N** while driving except to coast when the vehicle is in danger of skidding (e.g. on icy roads).



The last stored speed is canceled when you turn off the engine.

Driving systems

Setting stored speed (“Resume” function)

Warning!



The speed stored in memory should only be set again if prevailing road conditions permit. Possible acceleration or deceleration differences arising from returning to preset speed could cause an accident and/or serious injury to you and others.

- ▶ Briefly push the cruise control lever to position **4**.

Cruise control will resume the last previously set speed.

- ▶ Remove your foot from the accelerator pedal.

Setting a higher speed

- ▶ Lift the cruise control lever to position **1** and hold it up until the desired speed is reached.
- ▶ Release the cruise control lever.

The new speed is set.



Depressing the accelerator pedal does not deactivate the cruise control. After brief acceleration (e.g. for passing), cruise control will resume the last speed set.

Setting a lower speed

- ▶ Depress the cruise control lever to position **2** and hold it down until the desired speed is reached.
- ▶ Release the cruise control lever.

The new speed is set.



When you use the cruise control lever to decelerate, the transmission will automatically downshift if the engine's braking power does not brake the vehicle sufficiently.

Fine adjustment in 1.0 mph (1 km/h) increments

Faster

- ▶ Briefly tip the cruise control lever in the direction of arrow **1**.

Slower

- ▶ Briefly tip the cruise control lever in the direction of arrow **2**.

Transmission in **LOW RANGE** mode



The cruise control should not be used during off-road driving.

Parktronic system* (Parking assist)**Warning!**

Parktronic is a supplemental system. It is not intended to nor does it replace the need for extreme care. The responsibility during parking and other critical maneuvers rests always with the driver.

Make sure that no persons or animals are located in the area in which you are maneuvering. They could otherwise be injured.

Special attention must be paid to objects with smooth surfaces or low silhouettes (e.g. trailer couplings, painted posts, or street curbs). Such objects may not be detected by the system and can damage the vehicle.

The operational function of the Parktronic can be affected by dirty sensors, especially at times of snow and ice. For notes on cleaning the Parktronic system sensors (▷ page 220).

Interference caused by other ultrasonic signals (e.g. working jackhammers or the air brakes of trucks) can cause the system to send erratic indications, and should be taken into consideration.

The Parktronic system assists the driver during parking maneuvers. It visually and audibly indicates the distance between the vehicle and an obstacle.

With the ignition on, Parktronic engages automatically at speeds up to approximately 10 mph (15 km/h) and deactivates during higher speeds.

Parktronic monitors your vehicle's environment by means of six sensors in the front bumper and four sensors in the rear bumper.

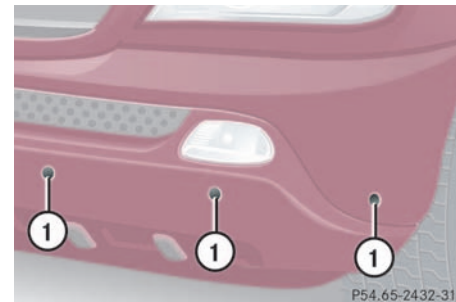

1 Sensors located in front bumper

Driving systems

Monitoring reach of sensors

The sensors must be free of dirt, ice and snow or they will be unable to function properly. Clean the sensors regularly without scratching or damaging them.

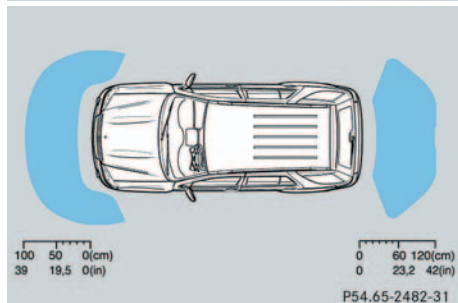
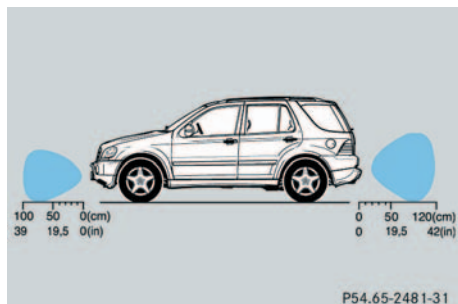

Front sensors

Center	40 in (100 cm)
Corner	24 in (60 cm)

Rear sensors

Center	48 in (120 cm)
Corner	32 in (80 cm)

Minimum distance

Center	6 in (15 cm)
Corner	8 in (20 cm)

When an obstacle is located in this area, all warning displays will light up and a warning tone will sound. If the vehicle moves closer than the minimum distance to an object, the distance may no longer be displayed.

Warning indicators

The warning indicators show the distance between the sensor and the obstacle. The warning indicators for the front area are located above the center air outlets in the dashboard. The warning indicator for the rear area is located in the rear passenger compartment lamp.

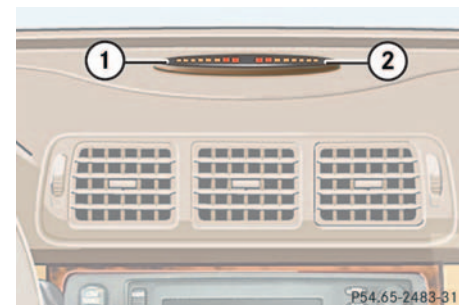

- 1 Segments, left side of vehicle
- 2 Segments, right side of vehicle

Each warning indicator has 6 yellow and 2 red segments.

The selector lever position determines which warning indicator is activated.

Selector lever position	Warning indicator
D	Front area activated
R	Rear area activated
N or P	No area activated

As soon as the sensors detect an obstacle, one or more segments light up, depending on the distance. An intermittent acoustic warning will also sound as the seventh segment lights up and a constant acoustic warning lasting a maximum of 3 seconds will sound for the eighth segment.



If all red segments light up in the warning indicators, a dirty sensor or a ultrasonic signal could be the reason.

- Clean the sensors (▷ page 220).

After cleaning the sensors, switch the ignition on.

Switching Parktronic on/off

You can switch Parktronic off manually.

The switch is located on the lower part of the center console.

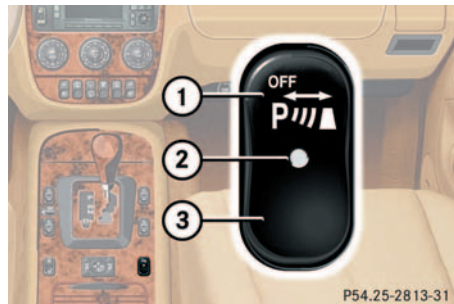

- 1 Switching off
- 2 Indicator lamp
- 3 Switching on



If Parktronic is malfunctioning, all red segments of the warning indicators light up and an additional warning sounds.

Contact your Mercedes-Benz Light Truck Center as soon as possible.

Switching Parktronic off

- ▶ Press switch on the upper part **1**.
Indicator lamp **2** lights up.

Switching Parktronic on

- ▶ Press switch on the upper part **3**.
The indicator lamp **2** goes out.



If you switch the ignition on, Parktronic will be automatically switched on.

The rear Parktronic sensors will not automatically disengage when towing a trailer. Therefore switch Parktronic off.

Useful features

Useful features

Interior storage spaces

Warning!



To help avoid personal injury during a collision or sudden maneuver, exercise care when stowing objects in the vehicle. Put luggage or cargo in the cargo compartment if possible. Do not pile luggage or cargo higher than the seat backs.

Always use partition net when transporting cargo. Partition net cannot secure hard or heavy objects.

Parcel nets cannot secure hard or heavy objects.

Keep compartment lids closed. This will help to prevent stored objects from being thrown about and injuring vehicle occupants during an accident.

Glove box

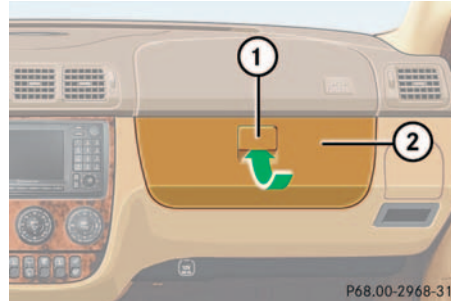

- 1 Glove box lid release
- 2 Glove box lid



The opened glove box is illuminated with the key in steering lock position 1 (▷ page 33).

Opening the glove box

- ▶ Grab in recess and pull lid release 1.
The glove box lid 2 opens downward.

Closing the glove box

- ▶ Push glove box lid up to close.

Storage compartment under front passenger seat*

The storage compartment is lockable with its separate key.

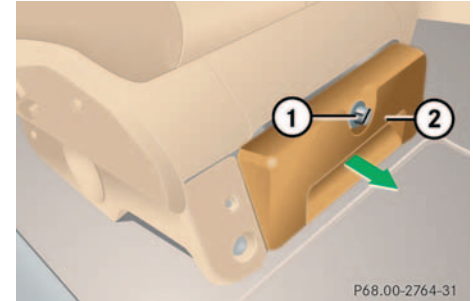

- 1 Lock cylinder
- 2 Handle

Locking and unlocking the storage compartment

- ▶ Turn the key clockwise.
The storage compartment is locked.
- ▶ Turn the key counterclockwise.
The storage compartment is unlocked.

Opening the storage compartment

- ▶ Press the lock cylinder in and pull storage compartment out using handle **2**.

Closing the storage compartment

- ▶ Push the storage compartment in until the lock engages.

Armrest storage spaces

A flat storage tray with a deeper storage compartment underneath is located below the armrest. Both can be opened separately.

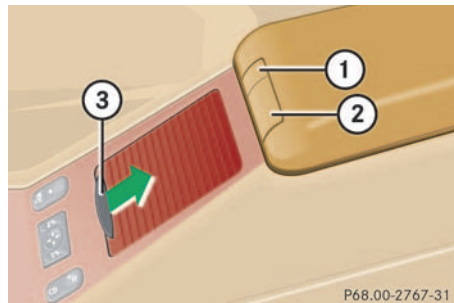

- 1 Button to open storage tray
- 2 Button to open storage compartment
- 3 Open cover

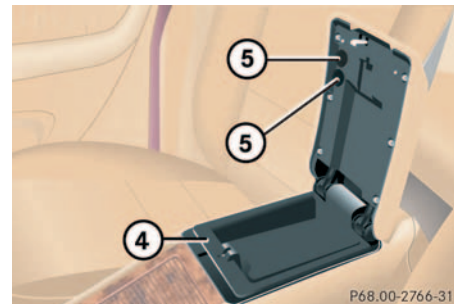

- 4 Storage tray
- 5 Coin holder

Opening the storage tray

- ▶ Press button **1** and lift up armrest.
The armrest contains two coin holders.

Opening the storage compartment

- ▶ Press button **2** and lift up armrest.

Useful features

Opening the storage compartment in front of armrest

- ▶ Slide the cover **3** rearward.

The storage compartment below contains a cup holder (▷ page 155).

Cup holders

Warning!



When not in use, keep the cup holder closed. Place only containers that fit into the cup holder to prevent spills. Use lids on open containers and do not fill containers to a height where the contents, especially hot liquids, could spill during vehicle maneuvers.

Cup holder in instrument panel

A cup holder is located on both the right and left side of the instrument panel.

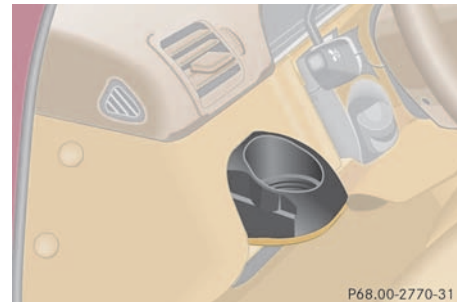

Opening the cup holder

- ▶ Briefly touch top of cover.

The cup holder opens automatically.

Closing the cup holder

- ▶ Fold the cup holder upwards and press on it until it engages.

Cup holder in front of armrest

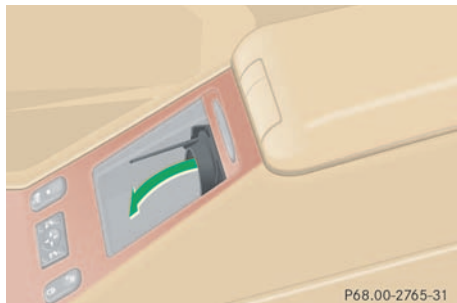

Opening the cup holder

- ▶ Slide cover rearward (▷ page 154).
- ▶ Fold the cup holder forward.

Closing the cup holder

- ▶ Fold the cup holder backward.
- ▶ Slide cover forward.

Cup holder in rear center console



Opening the cup holder

- ▶ Briefly touch the cover.
The cup holder opens automatically.

Closing the cup holder

- ▶ Press the cup holder forward and press on it until it engages.



Close the cup holder before folding the rear seat bench.

Armrest in rear seat bench

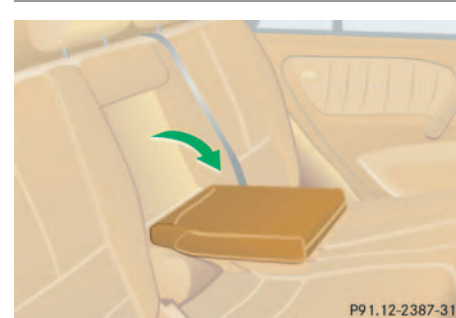

- ▶ Pull the armrest down by its top.

Useful features

Ashtrays and cigarette lighter

Warning!



Never touch the heating element or sides of the cigarette lighter; they are extremely hot. Hold the knob only.

When leaving the vehicle always remove the key from the steering lock. Do not leave children unattended in the vehicle, or with access to an unlocked vehicle. Unsupervised use of vehicle equipment may cause an accident and/or serious personal injury.



The cigarette lighter socket can be used to accommodate electrical accessories up to a maximum of 50 W.

If the engine is off, the battery may become discharged when used for long periods of time.

Ashtray and cigarette lighter in the front center console

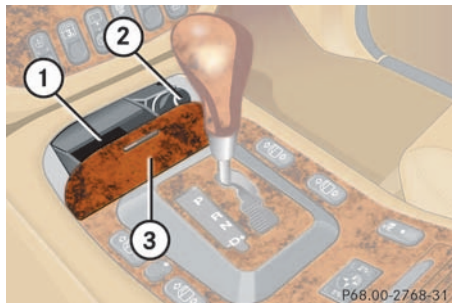

- 1 Ashtray
- 2 Cigarette lighter
- 3 Cover plate

Opening the ashtray

- ▶ Briefly touch cover plate **3**.

The ashtray opens automatically.

Removing ashtray insert

Warning!



Remove ashtray only with vehicle standing still. Set the parking brake to secure vehicle from movement. Move gear selector lever to position **N**. With gear selector lever in position **N**, turn off the engine.

- ▶ Secure vehicle from movement by setting the parking brake. Move the selector lever to position **N**.
Now you have more room to take out the insert.
- ▶ Grip the insert on the sides and pull it out upwards.

Reinstalling ashtray insert

- ▶ Install ashtray insert.
- ▶ Close the ashtray.

Cigarette lighter

- ▶ Switch on the ignition.
- ▶ Push in cigarette lighter **2** (▷ page 156).

The cigarette lighter will pop out automatically when hot.

Ashtray and cigarette lighter in the rear center console



Close the ashtray in the rear center console before folding the rear seat bench.

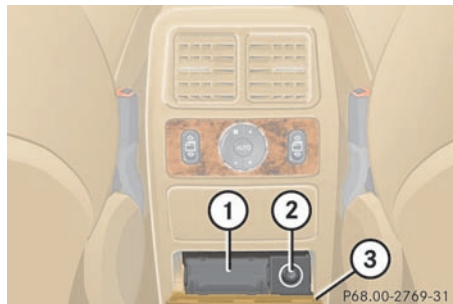

- 1** Ashtray
- 2** Cigarette lighter
- 3** Cover plate

Opening the ashtray

- ▶ Briefly touch cover plate **3**.
- The ashtray opens automatically.

Removing ashtray insert

- ▶ Grip the insert on the sides and pull it out upwards.

Reinstalling ashtray insert

- ▶ Install ashtray insert.
- ▶ Close the ashtray.

Cigarette lighter

- ▶ Switch on the ignition.
- ▶ Push in cigarette lighter **2**.

The cigarette lighter will pop out automatically when hot.

Useful features

Electrical outlet



Electrical outlet

One outlet is located in the front passenger footwell and another on the right-hand side of the luggage compartment.

- ▶ Flip up cover and insert electrical plug (cigarette lighter type).



The outlets function even if the key is not in the ignition.

The electrical outlet can be used to accommodate electrical consumers (e.g. air pump, auxiliary lamps) up to a maximum of 180 W.

If the engine is off, the battery may become discharged if used for long periods of time.

Telephone*

Warning!



Never operate radio transmitters equipped with a built-in or attached antenna (i.e. without being connected to an external antenna) from inside the vehicle while the engine is running. Doing so could lead to a malfunction of the vehicle's electronic system, possibly resulting in an accident and/or serious personal injury.

Radio transmitters, such as a portable telephone or a citizens band unit, should only be used inside the vehicle if they are connected to an antenna that is installed on the outside of the vehicle.

The external antenna must be approved by Mercedes-Benz. Please contact an authorized Mercedes-Benz Light Truck Center for information on the installation of an approved external antenna. Refer to the radio transmitter operation instructions regarding use of an external antenna.

Warning!

Please do not forget that your primary responsibility is to drive the vehicle. A driver's attention to the road must always be his/her primary focus when driving. For your safety and the safety of others, we recommend that you pull over to a safe location and stop before placing or taking a telephone call.

If you choose to use the telephone¹ while driving, please use the hands-free device and only use the telephone when road, weather and traffic conditions permit. Some jurisdictions prohibit the driver from using a cellular telephone while driving a vehicle.

Only operate the MCS (**M**odular **C**ontrol **S**ystem)¹ if road, weather and traffic conditions permit.

Bear in mind that at a speed of just 30 mph (approximately 50 km / h), your vehicle is covering a distance of approx. 44 feet (approximately 13.5 m) every second.

¹ Observe all legal requirements

You can take and place telephone calls using the MCS unit.

See separate instruction manual for information on how to operate the telephone.

Warning!

Some jurisdictions prohibit the driver from using a cellular telephone while driving a vehicle. Whether or not prohibited by law, for safety reasons, the driver should not use the cellular telephone while the vehicle is in motion.

Stop the vehicle in a safe location before answering or placing a call.

Tele Aid*

The initial activation of the Tele Aid system may only be performed by completing the subscriber agreement and placing an acquaintance call using the SOS button. Failure to complete either of these steps will result in a system that is not activated. If the system is not activated, the indicator lamp in the SOS button stays on after turning key in steering lock to position **2** and the message `TELE AID - NOT ACTIVATED` will be shown in the MCS display for approximately 10 seconds.

If you have any questions regarding activation, please call the Response Center at 1-800-756-9018 (in the USA) or 1-888-923-8367 (in Canada).

Useful features

The Tele Aid system



(Telematic Alarm Identification on Demand)

The Tele Aid system consists of three types of response:

- automatic and manual emergency
- roadside assistance and
- information.

The Tele Aid system is operational providing that the vehicle's battery is charged, properly connected, not damaged and cellular and GPS coverage is available.

The speaker volume of a Tele Aid call can be adjusted using the volume control on the MCS unit.

- ▶ To activate, press the SOS button, the Roadside Assistance button  or the Information button , depending on the type of response required.





The SOS button, the Roadside Assistance button  and the Information button  are located in the overhead control panel.

Shortly after the completion of your acquaintance call, you will receive a user ID and password via first call mail. By visiting www.mbusa.com and selecting "Tele Aid" (USA only), you will have access to account information, remote door unlock, profile and more.



The Tele Aid system utilizes the cellular network for communication and the GPS (Global Positioning System) satellites for vehicle location. If either of these signals are unavailable, the Tele Aid system may not function and if this occurs, assistance must be summoned by other means.

System self-check

Initially, after turning the key in the steering lock to position **2**, malfunctions are detected and indicated (the indicator lamps in the SOS button, the Roadside Assistance button  and the Information button  stay on longer than 10 seconds or do not come on). The message `Tele Aid - Visit workshop!` appears for approx. 10 seconds in the MCS display.

Warning!

The Tele Aid control unit is located under the front passenger seat. If there is accumulation of water or other liquid in this area, the Tele Aid control unit could suffer an electrical short circuit making the system inoperative. In this case the indicator lamp in the SOS button will not illuminate during or will remain illuminated after the system self-check. Have the system checked at the nearest Mercedes-Benz Light Truck Center as soon as possible.

If the indicator lamps in the SOS button, in the Roadside Assistance button and/or in the Information button do not come on during the system self-check or if any of these indicators remain illuminated constantly in red and/or the message TELE AID - VISIT WORKSHOP is displayed in the MCS display after the system self-check, a malfunction in the system has been detected.

If a malfunction is indicated as outlined above, the system may not operate as expected. Have the system checked at the nearest Mercedes-Benz Light Truck Center as soon as possible.

Emergency calls

An emergency call is initiated automatically:

- following an accident in which the emergency tensioning detractors (ETDs) or airbags deploy,
- if the anti-theft alarm or the tow-away alarm stays on for more than 20 seconds. See anti-theft alarm system (> page 78) and tow-away alarm (> page 79).

An emergency call can also be initiated manually by opening the cover next to the inside rear view mirror labeled SOS, then briefly pressing the button located under the cover. See below for instructions on initiating an emergency call manually.

Useful features

Once the emergency call is in progress, the indicator lamp in the SOS button will begin to flash. The message **EMERGENCY CALL - CONNECTING CALL** appears in the MCS display. When the connection is established, the message **EMERGENCY CALL - CALL CONNECTED** appears in the MCS display. All information relevant to the emergency, such as the location of the vehicle (determined by the GPS satellite location system), vehicle model, identification number and color are generated.

A voice connection between the Response Center and the occupants of the vehicle will be established automatically soon after the emergency call has been initiated. When a voice connection is established the audio system mutes and the message **TELE AID - EMERGENCY CALL ACTIVE** appears in the MCS display. The Response Center will attempt to determine more precisely the nature of the accident provided they can speak to an occupant of the vehicle.

The Tele Aid system is available if:

- it has been activated and is operational. Activation requires a subscription for monitoring services, connection and cellular air time
- the relevant cellular phone network and GPS signals are available and pass the information on to the response center.



Location of the vehicle on a map is only possible if the vehicle is able to receive signals from the GPS satellite network and pass the information on to the response center.

Warning!



If the indicator lamp in the SOS button is illuminated continuously and there was no voice connection to the Response Center established, then the Tele Aid system could not initiate an emergency call (e.g. the relevant cellular phone network is not available). The message **EMERGENCY CALL - Call FAILED** appears in the MCS display for approx. 10 seconds.

Should this occur, assistance must be summoned by other means.

Initiating an emergency call manually

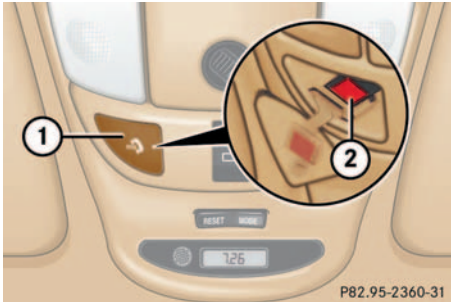

- 1 Cover
- 2 SOS button

- ▶ Briefly press on cover **1**.
The cover will open.
- ▶ Press SOS button **2** briefly.
The indicator lamp in SOS button **2** will flash until the emergency call is concluded.
- ▶ Wait for a voice connection to the Response Center.
- ▶ Close cover **1** after the emergency call is concluded.

Warning!



If you feel at any way in jeopardy when in the vehicle (e.g. smoke or fire in the vehicle, vehicle in a dangerous road location), please do not wait for voice contact after you have pressed the emergency button. Carefully leave the vehicle and move to a safe location. The Response Center will automatically contact local emergency officials with the vehicle's approximate location if they receive an automatic SOS signal and cannot make voice contact with the vehicle occupants.

Roadside Assistance button

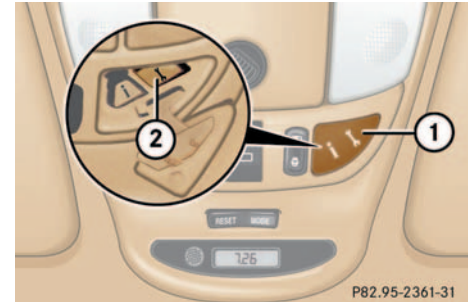

- 1 Cover
- 2 Roadside Assistance button 

- ▶ Briefly press on cover **1**.
The cover will open.
- ▶ Press and hold the button **2** (for longer than 2 seconds)
A call to a Mercedes-Benz Roadside Assistance dispatcher will be initiated. The button will flash while the call is in progress. The message **ROADSIDE ASSISTANCE - CONNECTING CALL** will appear in the MCS display.

Useful features

When the connection is established, the message **ROADSIDE ASSISTANCE - CALL CONNECTED** appears in the MCS display. The Tele Aid system will transmit data generating the vehicle identification number, model, color and location (subject to availability of cellular and GPS signals).



While the call is connected you can change to navigation menu by pressing NAVI button on the MCS unit.

A voice connection between the Roadside Assistance dispatcher and the occupants of the vehicle will be established. When a voice connection is established the audio system mutes and the message **TELE AID - ROADSIDE ASSISTANCE CALL ACTIVE** appears in the MCS display.



- ▶ Describe the nature of the need for assistance.

The Mercedes-Benz Roadside assistance dispatcher will either dispatch a qualified Mercedes-Benz technician or arrange to tow your vehicle to the nearest Mercedes-Benz Light Truck Center. For services such as labor and /or towing, charges may apply. Refer to the Roadside Assistance manual for more information.

These programs are only available in the USA:

- Sign and Drive services: Services such as jump start, a few gallons of fuel or the replacement of a flat tire with the vehicle spare tire are obtainable,
- Remote Vehicle Diagnostics: This function permits the Mercedes-Benz Roadside Assistance dispatcher to download malfunction codes and actual vehicle data.



The indicator lamp in the Roadside Assistance button  remains illuminated in red for approx. 10 seconds during the system self-check after turning the key in the steering lock to position **2** (together with the SOS button and the Information button ).

See system self-check (▷ page 160) when the indicator lamp does not light up in red or stays on longer than approximately 10 seconds.

If the indicator lamp in the Roadside Assistance button  is illuminated continuously and there was no voice connection to the Response Center established, then the Tele Aid system could not initiate a Roadside Assistance call (e.g. the relevant cellular phone network was not available). The message **ROADSIDE ASSISTANCE - CALL FAILED** appears in the MCS display.

Roadside Assistance calls can be terminated using the **END** Button on the MCS unit.

Information button

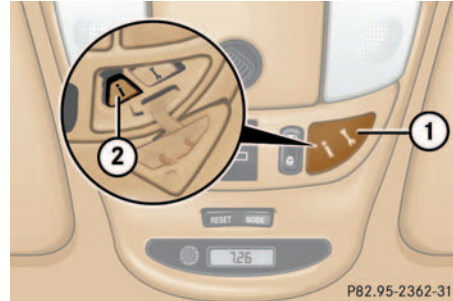

- 1 Cover
- 2 Information button 

- ▶ Briefly press on cover 1.
The cover will open.
- ▶ Press and hold the button (for longer than 2 seconds).
A call to the Customer Assistance Center will be initiated. The button will flash while the call is in progress. The message **INFO - CONNECTING CALL** will appear in the MCS display.

When the connection is established, the message **INFO - CALL CONNECTED** appears in the MCS display. The Tele Aid system will transmit data generating the vehicle identification number, model, color and location (subject to availability of cellular and GPS signals).





While the call is connected, you can change to navigation menu by pressing **NAVI** button on the MCS unit.

A voice connection between the Customer Assistance Center representative and the occupants of the vehicle will be established. When a voice connection is established the audio system mutes and the message **TELE AID - INFO CALL ACTIVE** appears in the MCS display. Information regarding the operation of your vehicle, the nearest Mercedes-Benz Light Truck Center or Mercedes-Benz USA products and services is available to you.

Useful features

For more details concerning the Tele Aid system, please visit www.mbusa.com and use your ID and password (sent to you separately) to learn more (USA only).



The indicator lamp in the Information button  remains illuminated in red for approx. 10 seconds during the system self-check after turning key in the steering lock to position **2** (together with the SOS button and the Roadside Assistance button .

See system self-check (▷ page 160) when the indicator lamp does not light up in red or stays on longer than approximately 10 seconds.

If the indicator lamp in the Information button  is illuminated continuously and there was no voice connection to the Response Center established, then the Tele Aid system could not initiate an Information call (e.g. the relevant cellular phone network is not available).

The message **INFO CALL FAILED** appears in the MCS display.

Information calls can be terminated using the **END** button on the MCS.



If the indicator lamps do not start flashing after pressing one of the buttons or remains illuminated (in red) at any time, the Tele Aid system has detected a fault or the service is not currently active, and may not initiate a call. Visit your Mercedes-Benz Center and have the system checked or contact the Response Center at 1-800-756-9018 (in the USA) or 1-888-923-8367 (in Canada) as soon as possible.

Upgrade signals

The Tele Aid system processes calls using the following priority.

- Automatic emergency – First priority
- Manual emergency – Second priority
- Roadside assistance – Third priority
- Information – Fourth priority

Should a higher priority call be initiated while you are connected, an upgrade (alternating) tone will be heard and the appropriate indicator lamp will flash. If certain information such as vehicle identification number or customer information is not available, the operator may need to retransmit.

During this time you will hear a beep and voice contact will be interrupted. Voice contact will resume once the retransmission is completed. Once a call is concluded, a beep will be heard and the appropriate indicator lamp will stop flashing. The MCS system operation will resume.



If the indicator lamp continues to flash or the system does not reset, contact the Response Center at 1-800-756-9018 (in the USA) or 1-888-923-8367 (in Canada), or Mercedes-Benz Customer Assistance at 1-800-FOR-MERCEdes (1-800-367-6372) in the USA or Customer Service at 1-800-387-0100 in Canada.



The indicator lamp in the respective button flashes until the call is concluded. Calls can only be terminated by a Response Center or Customer Assistance Center representative, except Roadside Assistance and Information calls, which can also be terminated by using the END button on the MCS unit.



When a Tele Aid call has been initiated, the MCS system audio is muted and the selected mode (radio, tape or CD) pauses. The optional cellular phone (if installed) switches off. If you must use this phone, the vehicle must be parked. Disconnect the coiled cord and place the call. The navigation system (if engaged) will continue to run. A pop-up window will appear in the MCS display to indicate that a Tele Aid call is in progress.

Remote door unlock

In case you have locked your vehicle unintentionally (e.g. key inside vehicle), and no other key is available:

- ▶ Contact the Mercedes-Benz Response Center at 1-800-756-9018 (in the USA) or 1-888-923-8367 (in Canada).

You will be asked to provide your password which you provided when you completed the subscriber agreement.

- ▶ Then return to your vehicle and pull outside handle of the liftgate for minimum of 20 seconds until the SOS button is flashing.

The message **EMERGENCY CALL - CALL CONNECTED** appears in the MCS display.

As an alternative, you may unlock the vehicle via Internet using the ID and password sent to you shortly after the completion of your acquaintance call.

Useful features

The Response Center will then unlock your vehicle with the remote door unlocking feature.



The remote door unlock feature is available if the relevant cellular phone network is available.

The SOS button will flash and the message **EMERGENCY CALL - CALL CONNECTED** will appear in the MCS display to indicate receipt of the door unlock command.

Once the vehicle is unlocked, a Response Center specialist will attempt to establish voice contact with the vehicle occupants.

If the outside liftgate handle was pulled for more than 20 seconds before door unlock authorization was received by the Response Center, you must wait 15 minutes before pressing the outside liftgate handle again.

Stolen vehicle tracking services

In the event your vehicle was stolen:

- ▶ Report the incident to the police
The police will issue a numbered incident report.
- ▶ Pass this number on to the Mercedes-Benz Response Center along with your password issued to you when you subscribed to the service.

The Response Center will then attempt to covertly contact the vehicle's Tele Aid system. Once the vehicle is located, the Response Center will contact the local law enforcement and you. The vehicle's location will only be provided to law enforcement.

Garage door opener

The built-in remote control is capable of operating up to three separately controlled objects.

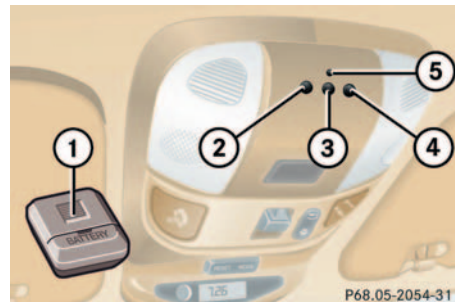

- 1 Hand-held remote control transmitter
- 2, 3, 4 Signal transmitter key
- 5 Indicator lamp

Warning!

When programming a garage door opener, the door moves up or down.

When programming or operating the remote control make sure there is no possibility of anyone being injured by the moving door.



Certain types of garage door openers are incompatible with the integrated opener. If you should experience difficulties with programming the transmitter, contact your authorized Mercedes-Benz Center, or call Mercedes-Benz Customer Assistance Center (in the USA only) at 1-800-FOR-MERCEdes, or Customer Service (in Canada) at 1-800-387-0100.



For operation in the USA only: This device complies with Part 15 of the FCC Rules. Operation is subject to the following two conditions:

- (1) This device may not cause harmful interference, and
- (2) this device must accept any interference received, including interference that may cause undesired operation.

Any unauthorized modification to this device could void the user's authority to operate the equipment.

Programming or reprogramming the integrated remote control

- ▶ Turn key in the steering lock to position **1** or **2**.
- ▶ Hold the end of the hand-held transmitter of the device you wish to train approximately 2 to 5 inches (5 cm to 12 cm) away from the surface of the integrated remote control located on the inside rear view mirror, keeping the indicator lamp in view.
- ▶ Using both hands, simultaneously push the hand-held transmitter button and the desired integrated remote control button. Do not release the buttons until completing next step.
- ▶ The indicator lamp on the integrated remote control will flash, first slowly and then rapidly. The rapid flashing lamp indicates successful programming of the new frequency signal.

Useful features

- ▶ When the indicator lamp flashes rapidly, release both buttons.
- ▶ To program the remaining two buttons, repeat the steps above.



If, after several attempts, you do not successfully program the integrated remote control device to learn the signal of the hand-held transmitter, the garage door opener could be equipped with the “rolling code feature”.

Rolling code programming

To train a garage door opener (or other rolling code devices) with the rolling code feature, follow these instructions after completing the “Programming” portion of this text. (A second person may make the following training procedures quicker and easier.)

- ▶ Locate training button on the garage door opener motor head unit.

Exact location and color of the button may vary by garage door opener brand. If there is difficulty locating the transmitting button, reference to garage door opener operator’s manual.

- ▶ Press “training” button on the garage door opener motor head unit.

The “training light” is activated.

You have 30 seconds time to initiate the following step.

- ▶ Firmly press and release the programmed integrated remote control transmit button.
- ▶ Press and release same button a second time to complete the training process.

Some garage door openers may require you to do this procedure a third time to complete the training.

- ▶ Confirm the garage door operation by pressing the programmed button on the integrated remote control transmitter.

Canadian programming

During programming, your hand-held transmitter may automatically stop transmitting.

- ▶ Continue to press and hold the integrated remote control transmitter button (refer to steps two through four in the “Programming” portion) while you press and re-press (“cycle”) your hand-held transmitter every two seconds until the frequency signal has been learned.

Upon successful training, the indicator lamp will flash slowly and then rapidly after several seconds.

Operation of remote control

- ▶ Turn key in steering lock to position **1** or **2**.
- ▶ Select and press the appropriate button to activate the remote controlled device.

The integrated remote control transmitter continues to send the signal as long as the button is pressed – up to 20 seconds.

Erasing the remote control memory

- ▶ Turn key in steering lock to position **1** or **2**.
- ▶ Simultaneously hold down the left and right side buttons for approximately 20 seconds, or until the indicator lamp blinks rapidly.

The codes of all three channels are erased.



If you sell your vehicle, erase the codes of all three channels.

Useful features

Trip computer*

The trip computer is located in the overhead console.



- 1 RESET
- 2 MODE
- 3 Display

Switching on the trip computer

- ▶ Switch on ignition.
Display **3** shows one of the available functions.
- ▶ If a function display does not appear, press **MODE 2**.



With engine not running, the display switches off automatically 30 seconds after the last entry.

Selecting functions

- ▶ Press **MODE 2** repeatedly until the desired display appears.

The functions are displayed in the following order:

- Date
- Compass
- Stop watch
- Present fuel consumption
- Average fuel consumption
- Distance remaining
- Country
- Switching off trip computer

Setting the date

- ▶ Press **MODE 2** repeatedly until the date appears.
- ▶ Press **RESET 1**.
The month shown blinks.
- ▶ Press **MODE 2** to advance to selected month.
- ▶ Press **RESET 1**.
The day shown blinks.
- ▶ Press **MODE 2** to advance to selected day.
- ▶ Press **RESET 1**.
The year shown blinks.
- ▶ Press **MODE 2** to advance to selected year.
- ▶ Press **RESET 1**.
The display stops blinking and the date is set.

Compass

The compass displays the direction the vehicle is traveling. The display **3** will show you N, NE, E, SE, S, SW, W or NW.

i

The presence of buildings, bridges, power lines and large antenna masts can influence the displayed values. Metallic or magnetic objects in or on the vehicle can influence the accuracy of the compass.

To ensure the display is correct, the compass must be set to the proper geographic zone (▷ page 174). It may also be necessary to calibrate the compass (▷ page 174).

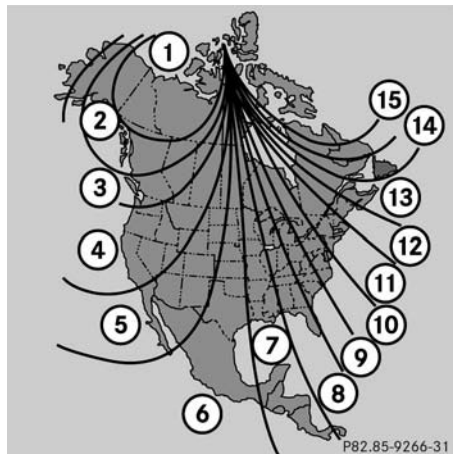

Zone map North America

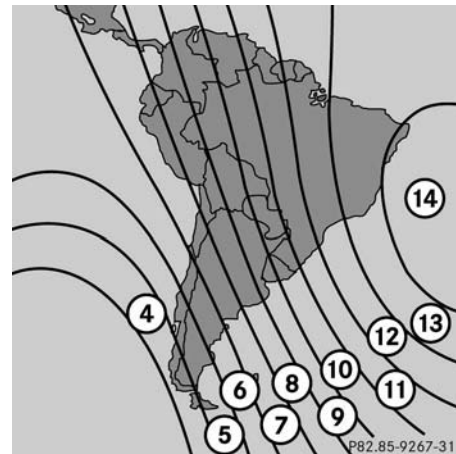

Zone map South America

Useful features

Setting the compass zone

- ▶ Determine the geographical point of the vehicle with the aid of the zone maps.
- ▶ Switch on the ignition.
- ▶ Press **MODE 2** (▷ page 172) repeatedly until the compass display appears in the trip computer display **3**.
- ▶ Press **RESET 1** (▷ page 172) to select the compass zone mode.

The zone selected last is shown in the display.

- ▶ Press **RESET 1** repeatedly until the correct compass zone, as determined from the zone map, is shown in the display.
- ▶ Press **MODE 2** twice.

The new compass zone is activated and the compass display will be shown.

Calibrating the compass

If the vehicle was exposed to a significant magnetic zone, such as high voltage power lines, the compass may have to be calibrated.

To calibrate the compass correctly, observe the following:

- Calibrate the compass in an area free of steel superstructures and power lines.
- Switch off all electrical consumers (e.g. exterior lamps, climate control, rear window defroster etc.).
- Do not open or close the sliding/pop-up roof.
- Close doors and liftgate.



An open liftgate triggers the display - - -.

- ▶ Start and run the engine.
- ▶ Press **MODE 2** (▷ page 172) repeatedly until the compass display appears in the trip computer display **3**.

- ▶ Press **RESET 1** and afterwards press **MODE 2**.

In the display appears **CAL-**.

- ▶ Press and hold **RESET 1** for approximately two seconds.

The calibration mode is activated and the display shows **CAL**.

- ▶ Drive without interruption two full circles at a speed between 3 mph (5 km/h) and 7 mph (10 km/h).

The message **CAL** goes out after a short time. The calibration is now complete.



If CAL remains in the display, calibration was not successfully completed. You have to recalibrate:

- Remove the key from the steering lock.
- Start the vehicle and start the calibration procedure described before.

We recommend that you have the compass calibrated at a Mercedes-Benz Light Truck Center.

Stop watch

- ▶ Press MODE 2 (▷ page 172) repeatedly until the stop watch display appears in the trip computer display 3.

Counting

- ▶ Press RESET 1 (▷ page 172) to start counting.

Stopping

- ▶ Press RESET 1 again to stop counting.

Resetting

- ▶ Press and hold RESET 1 until the display shows "0:00".

Average fuel consumption

- ▶ Press MODE 2 (▷ page 172) repeatedly until the average fuel consumption display appears in the trip computer display 3.

Distance remaining with fuel presently in tank

- ▶ Press MODE 2 (▷ page 172) repeatedly until the distance remaining display appears in the trip computer display 3.



When the fuel supply drops to reserve level the display flashes distance remaining.

- USA only:
The display alternates between FUEL and distance remaining until supply is consistently below the reserve level. When the fuel supply is very low [approximately 1.5 gal (5.5 l)] FUEL is displayed continuously.

Useful features

Country

- ▶ Press **MODE 2** (▷ page 172) repeatedly until the country display appears in the trip computer display **3**.
- ▶ Press and hold **RESET 1** a minimum of five seconds to change the country unit system.

Canada units system selection

You can choose between CAN-English or CAN-French.

Setting CAN-English

- ▶ Press **RESET 1** repeatedly until CAN is displayed.
- ▶ Press **MODE 2** to select -ENG.
- ▶ Press **MODE 2** again to set CAN-English.

Setting CAN-French

- ▶ Press **RESET 1** repeatedly until CAN is displayed.
- ▶ Press **MODE 2**.
-ENG is displayed.
- ▶ Press **RESET 1** to select -Fr.
- ▶ Press **MODE 2** to set CAN-French.

The language selected determines how the various displays are presented, see table.

Display	Language	Date	Cardinal points	Fuel consumption	Distance remaining
GEr	German	DD.MM	S üd, N ord, O st, W est	l/100 km	Kilometer
GB	English	MM.DD	S outh, N orth, E ast, W est	mi/gal (Imperial)	Miles
ESP	Spain	DD.MM	S ur, N orte, E ste, O este	l/100 km	Kilometer
Fr	French	DD.MM	S ud, N ord, E st, O uest	l/100 km	Kilometer
USA	American	MM.DD	S outh, N orth, E ast, W est	mi/gal (US)	Miles
CAN-ENG	American	MM.DD	S outh, N orth, E ast, W est	l/100 km	Kilometer
CAN-Fr	French	DD.MM	S ud, N ord, E st, O uest	l/100 km	Kilometer



Operation

The first 1000 miles (1500 km)

Driving instructions

At the gas station

Engine compartment

Tires and wheels

Winter driving

Maintenance

Vehicle care

The first 1000 miles (1500 km)

In the “Operation” section you will find detailed information on operating, maintaining and caring for your vehicle.

The first 1000 miles (1500 km)

The more cautiously you treat your vehicle during the break-in period, the more satisfied you will be with its performance later on.

- Drive your vehicle during the first 1000 miles (1500 km) at varying but moderate vehicle and engine speeds.
- During this period, avoid heavy loads (full throttle driving) and excessive engine speeds (no more than 2/3 of maximum rpm in each gear).

- Avoid accelerating by kick-down.
- Do not attempt to slow the vehicle down by shifting to a lower gear using the selector lever.
- Select positions **3**, **2** or **1** only when driving at moderate speeds (for hill driving).

After 1000 miles (1500 km) you may gradually increase vehicle and engine speeds to the permissible maximum.

Driving instructions

Drive sensibly – save fuel

Fuel consumption, to a great extent, depends on driving habits and operating conditions.

To save fuel you should:

- Keep tires at the recommended inflation pressures
- Remove unnecessary loads
- Allow engine to warm up under low load use
- Avoid frequent acceleration and deceleration
- Have all maintenance work performed at regular intervals by an authorized Mercedes-Benz Light Truck Center

Fuel consumption is also increased by driving in cold weather, in stop-and-go traffic, on short trips and in hilly country.

Drinking and driving

Warning!



Drinking and driving and/or taking drugs and driving are a very dangerous combination. Even a small amount of alcohol or drugs can affect your reflexes, perceptions and judgement.

The possibility of a serious or even fatal accident is sharply increased when you drink or take drugs and drive.

Don't drink or take drugs and drive or allow anyone to drive after drinking or taking drugs.

Pedals

Warning!



Keep driver's foot area clear at all times. Objects stored in this area may impair pedal movement.

Power assistance

Warning!



When the engine is not running, there is no power assistance for the steering system. In this case, it is important to keep in mind that a considerably higher degree of effort is necessary to steer the vehicle.

Driving instructions

Brakes

Warning!



After driving in heavy rain for some time without applying the brakes or through water deep enough to wet brake components, the first braking action may be somewhat reduced and increased pedal pressure may be necessary to obtain expected braking effect. Maintain a safe distance from vehicles in front.

Resting your foot on the brake pedal will cause excessive and premature wear of the brake pads.

It can also result in the brakes overheating, thereby significantly reducing their effectiveness. It may not be possible to stop the vehicle in sufficient time to avoid an accident.

To help prevent brake disk corrosion after driving on wet road surfaces (particularly salted roads), it is advisable to brake the vehicle with considerable force prior to parking. The heat generated serves to dry the brakes.

If your brake system is normally only subjected to moderate loads, you should occasionally test the effectiveness of the brakes by applying above-normal braking pressure at higher speeds. This will also enhance the grip of the brake pads.



Be very careful not to endanger other road users when you apply the brakes.

Refer to the description of the Brake Assist System (BAS) (▷ page 73).

If the parking brake is released and the brake warning lamp in the instrument cluster stays on and there is no audible warning (EBP), the brake fluid level in the reservoir is too low.

Brake pad wear or a leak in the system may be the reason for low brake fluid in the reservoir.

Have the brake system inspected at an authorized Mercedes-Benz Light Truck Center immediately.

All checks and service work on the brake system should be carried out by an authorized Mercedes-Benz Light Truck Center.

Install only brake pads and brake fluid recommended by Mercedes-Benz.

Warning!

If other than recommended brake pads are installed, or other than recommended brake fluid is used, the braking properties of the vehicle can be degraded to an extent that safe braking is substantially impaired. This could result in an accident.



When driving down long and steep grades, relieve the load on the brakes by shifting into a lower gear to use the engine's braking power. This helps prevent overheating of the brakes and reduces brake pad wear.

After hard braking, it is advisable to drive on for some time, rather than immediately parking, so the air stream will cool down the brakes faster.

Driving off

Apply the brakes to test them briefly after driving off. Perform this procedure only when the road is clear of other traffic.

Warm up the engine smoothly. Do not place full load on the engine until the operating temperature has been reached.

When starting off on a slippery surface, do not allow one drive wheel to spin for an extended period with the ESP switched off. Doing so may cause serious damage to the drivetrain which is not covered by the Mercedes-Benz Limited Warranty.

Driving instructions

Parking



Set the parking brake whenever parking or leaving the vehicle. In addition, move selector lever to position **P**.

In addition, when parking on hills, turn front wheel towards the curb.

Warning!



Do not park this vehicle in areas where combustible materials such as grass, hay or leaves can come into contact with the hot exhaust system, as these materials could be ignited and cause a vehicle fire.

To reduce the risk of personal injury as a result of vehicle movement, before turning off the engine and leaving the vehicle always:

- Keep right foot on brake pedal.
- Firmly depress parking brake pedal.
- Move the selector lever to position **P**.
- Slowly release brake pedal.
- When parked on an incline, turn front wheel towards the road curb.
- Turn the key to steering lock position **O** and remove.
- Take the key and lock vehicle when leaving.

Tires

Warning!



If you feel a sudden significant vibration or ride disturbance, or you suspect that possible damage to your vehicle has occurred, you should turn on the hazard warning flashers, carefully slow down, and drive with caution to an area which is a safe distance from the road.

Inspect the tires and the vehicle underbody for possible damage. If the vehicle or tires appear unsafe, have it towed to the nearest Mercedes-Benz Light Truck Center or tire dealer for repairs.

Tread wear indicators (TWI) are required by law. These indicators are located in six places on the tread circumference and become visible at a tread depth of approximately $\frac{1}{16}$ in (1.5 mm), at which point the tire is considered worn and should be replaced.

The tread wear indicator appears as a solid band across the tread.

Warning!

Do not allow your tires to wear down too far. As tread depth approaches $1/16$ in (1.5 mm), the adhesion properties on a wet road are sharply reduced.

Depending upon the weather and/or road surface (conditions), the tire traction varies widely.

Specified tire pressures must be maintained. This applies particularly if the tires are subjected to high loads (e.g. high speeds, heavy loads, high ambient temperatures).

Warning!

Do not drive with a flat tire. A flat tire affects the ability to steer or brake the vehicle. You may lose control of the vehicle. Continued driving with a flat tire or driving at high speed with a flat tire will cause excessive heat build-up and possibly a fire.

Hydroplaning

Depending on the depth of the water on the road, hydroplaning may occur even at low speeds and with new tires. Reduce vehicle speed, avoid track grooves in the road and apply brakes cautiously in the rain.

Tire traction

The safe speed on a wet, snow covered or icy road is always lower than on a dry road.

You should pay particular attention to the condition of the road whenever the outside temperatures are close to the freezing point.

Warning!

If ice has formed on the road, tire traction will be substantially reduced. Under such weather conditions, drive, steer and brake with extreme caution.

Mercedes-Benz recommends M+S rated radial-ply tires for the winter season for all four wheels to insure normal balanced handling characteristics. On packed snow, they can reduce your stopping distance as compared with summer tires. Stopping distance, however, is still considerably greater than when the road is not covered with snow or ice. Exercise appropriate caution.

Driving instructions

Tire speed rating

Additional information on winter tires can be found under “Winter tires” (▷ page 213).

ML 320, ML 350

Your vehicle is factory equipped with “H”-rated tires, which have a speed rating of 130 mph (210 km/h).

ML 500

Your vehicle is factory equipped with “V”-rated tires, which have a speed rating of 150 mph (240 km/h).

An electronic speed limiter prevents your vehicle from exceeding the speed rating.

ML 55 AMG

Your vehicle is factory equipped with “W”-rated tires, which have a speed rating of 168 mph (270 km/h).

Despite of the tire speed rating, local speed limits should be obeyed. Use prudent driving speeds appropriate to prevailing conditions.

Warning!



Even when permitted by law, never operate a vehicle at speeds greater than the maximum speed rating of the tires.

Exceeding the maximum speed for which tires are rated can lead to sudden tire failure, causing loss of vehicle control and possibly resulting in an accident and/or serious injury and possible death, for you and for others.

Winter driving instructions

The most important rule for slippery or icy roads is to drive sensibly and to avoid abrupt acceleration, braking and steering maneuvers. Do not use the cruise control system under such conditions.

When the vehicle is in danger of skidding, move selector lever to position **N**. Try to keep the vehicle under control by corrective steering action.



Information on driving with snow chains (▷ page 214).

Warning!



On slippery road surfaces, never downshift in order to obtain braking action. This could result in drive wheel slip and reduced vehicle control. Your vehicle’s ABS will not prevent this type of control loss.

Do not use LOW RANGE mode when driving on ice or packed snow. At speeds below 18 mph (30 km/h) vehicle steering is adversely affected by the LOW RANGE ABS (▷ page 72).

Road salts and chemicals can adversely affect braking efficiency. Increased pedal force may become necessary to produce the normal brake effect.

We therefore recommend depressing the brake pedal periodically when traveling at length on salt-strewn roads.

This can bring road salt impaired braking efficiency back to normal. Be very careful that you carry out these braking maneuvers without endangering any other road users.

If the vehicle is parked after being driven on salt-treated roads, the braking efficiency should be tested as soon as possible after driving is resumed while observing the safety rules in the previous paragraph.

Warning!

If the vehicle becomes stuck in snow, make sure that snow is kept clear of the exhaust pipe and from around the vehicle with the engine running. Otherwise, deadly carbon monoxide (CO) gases may enter vehicle interior resulting in unconsciousness and death.

To assure sufficient fresh air ventilation, open a window slightly on the side of the vehicle not facing the wind.

Warning!

The outside temperature indicator is not designed to serve as an ice-warning device and is therefore unsuitable for that purpose. Indicated temperatures just above the freezing point do not guarantee that the road surface is free of ice.

For more information on winter driving (▷ page 213).

Standing water

Do not drive through flooded areas or water of unknown depth. Before driving through water, determine its depth. It should not be deeper than approximately 20 inches (50 cm).

If you must drive through standing water, drive slowly to prevent water from entering the passenger compartment or the engine compartment. Water in these areas could cause damage to electrical components or wiring of the engine or transmission, or could result in water being ingested by the engine through the air intake causing severe internal engine damage. Any such damage is not covered by the Mercedes-Benz Limited Warranty.

Driving instructions

Off-road driving

Warning!



Drive slowly in unknown terrain. This will make it easier to recognize unexpected obstacles and avoid damage to the vehicle.

To help avoid the vehicle rolling over, never turn it around on steep inclines. If the vehicle cannot complete the attempted climb, back it down in reverse gear.

Do not drive along the side of a slope (danger of vehicle rollover). The vehicle might otherwise rollover. If in doing so the vehicle begins to show a tendency to roll, immediately steer into a line of gravity (straight up or downhill).

Never let the vehicle roll backwards in idle or when the clutch is disengaged. You may lose control of the vehicle if you use only the service brake.

Warning!



Sand, dirt, mud and other material having friction property can cause exceptional wear and tear as well as brake failure.

Have the brakes checked for dirt build-up and cleaned. There is otherwise a risk that full braking power may not be available in an emergency.

Read this chapter carefully before you begin off-road travel.

Familiarize yourself with the vehicle characteristics and gear changing before you attempt any difficult terrain off-road driving. We recommend that you start out with easy off-road travel.

Special driving features for off-road driving

The following driving features are available for specific kind of operation:

- LOW RANGE mode (▷ page 118)
- LOW RANGE – ABS (▷ page 72)
- LOW RANGE – 4-ETS (▷ page 74)
- LOW RANGE – ESP (▷ page 76)

Off-road driving rules

Engage the LOW RANGE mode before driving under off-road conditions (▷ page 118).

Fasten items being carried as securely as possible (▷ page 139).



We recommend keeping doors, liftgate, windows, and sliding/pop-up roof* closed whenever driving in off-road mode.



Observe the following during off-road driving:

- Adjust vehicle speed to condition of terrain. The more uneven, rutty and steeper the terrain, the lower the speed should be
- Watch out for obstacles, such as rocks, holes, tree stumps and ruts.
- Be especially careful when driving in unknown territory. It may be necessary to get out of the vehicle and scout the path you intend to take.
- Continuous and speedy driving in sandy soil overcomes the vehicle rolling resistance, and helps to prevent the vehicle from sinking into the ground.

- Do not initiate jumps with the vehicle. It interrupts the forward momentum of the vehicle.
- Always drive onto slopes with the engine running and the vehicle in gear.

Checklist before off-road driving

Tires

- Check the tread depth and maintain specified tire pressure (see tire pressure label inside the fuel filler flap).
- Check tires for possible damage and remove foreign objects.
- Replace missing valve caps.

Rims

- Dented or bent rims can cause tire pressure loss and damage the tire beads. For this reason, check and, if necessary, change rims before driving off-road.

Vehicle tool kit

- Check if the vehicle jack is functional.
- In all cases take the vehicle tool kit, a strong tow rope, a shovel and a small plank (to put under the vehicle jack on sandy soil) with you.

Driving in steep terrain

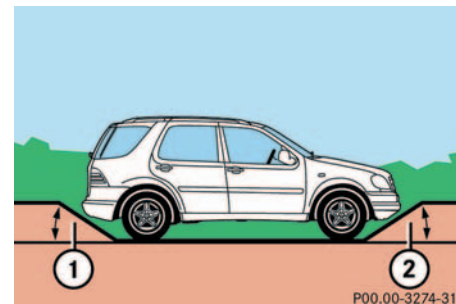

Slope angle

- 1 25° (ML 320, ML 350, ML 500)
21° (ML 55 AMG)
- 2 26° (ML 320, ML 350, ML 500)
23° (ML 55 AMG)

Driving instructions

- Switch to LOW RANGE mode before starting to drive up or down steep inclines (▷ page 118).
- Driving on embankments, slopes and other steep inclines should only be done straight up or downhill, i.e. in the line of gravity. Maximum vehicle climbing ability is a 60% grade.
- Do not drive along the side of a slope (danger of vehicle rollover). If in doing so, the vehicle begins to show a tendency to roll, immediately steer into a line of gravity (straight up or downhill).
- To help avoid the vehicle rolling over, never turn it around on steep inclines. If the vehicle cannot complete the attempted climb, back it down in reverse gear.
- Utilize the engine's braking power when descending a slope, observe the engine speed (do not overrev the engine). Apply the service brake as needed.

- Check the brakes after a lengthy down-grade drive.



Avoid excessive engine speeds – drive with moderate engine speeds (max. 3000 RPM).

Select gear range **2** or **1** on the automatic transmission (▷ page 114).

Traction in steep terrain

- Be easy on the accelerator and watch for continuous wheel traction when driving in steep terrain.

The 4-ETS helps greatly when starting out on a steep incline when the front wheels have then the tendency to slip due to the weight shifting away the front axle.

The 4-ETS recognizes the situation and limits the torque for the front wheels by braking them. Simultaneously the torque for the rear wheels is increased.

Driving across a hilltop

- Decelerate just ahead of a hilltop (do not select gear range **N**), to prevent the vehicle from speeding up too much after climbing a hill.

Use the momentum of the vehicle to drive across the hilltop.

Driving in this manner prevents the vehicle from jumping across the hilltop and thus losing its forward momentum.

Driving downhill

- Select gear range **1** on the automatic transmission (▷ page 114).
- Drive downhill observing the same rules as driving uphill (▷ page 187).
- The special **LOW RANGE – ABS** setting allows for precise and brief (cyclical) blocking of the front wheels, permitting them to dig into loose ground.

Remember that the front wheels when stopped, slide across a surface, thus lose their ability to steer the vehicle.

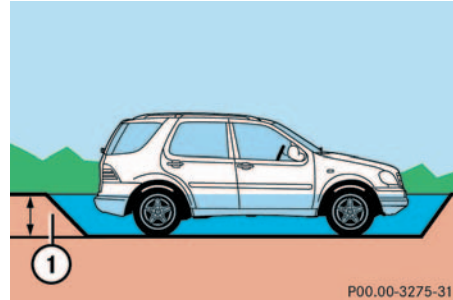
Driving through water

1 20 in (50 cm)

- Before driving through water, determine its depth. It should not be deeper than approximately 20 inches (50 cm).
- Switch to **LOW RANGE** mode before driving through water (▷ page 118).

- Switch off the exterior lamps as well as the climate control.
- Enter the water only at a shallow spot. Never take a running start.
- Drive slowly, avoiding a bow wave.
- Do not stop vehicle immersed in water, and do not shut off the engine.
- To dry the brakes, apply pressure to the brake pedal several times after leaving the water.

Driving instructions

Crossing obstacles



Obstacles can damage the vehicle undercarriage or suspension components. If possible use the assistance of a second person.

After off-road driving or crossing obstacles, inspect vehicle for any damage, especially vehicle undercarriage and suspension components. Failure to do so can adversely affect the vehicle's future performance, including increased chance of an accident.

- Select gear range **1** on the automatic transmission (▷ page 114).
- Check the vehicle clearance before crossing obstacles.
- Cross obstacles (e.g. tree stumps or big rocks) very slowly by aiming one of the front wheels at the center of the obstacle, and repeat same with the rear wheel.
- Special attention is needed when you cross obstacles on a steep incline.

The vehicle could slide sideways as a result of its possible slanted position.

Ruts

A number of off-road tracks or other byways have deep ruts which can cause the undercarriage to come in contact with the ground.

- Select gear range **1** on the automatic transmission (▷ page 114).
- Drive next to the ruts rather than through them if at all possible.

Returning from off-road driving

Warning!



If you feel a sudden significant vibration or ride disturbance, or you suspect that possible damage to your vehicle has occurred, you should turn on the hazard warning flashers, carefully slow down, and drive with caution to an area which is a safe distance from the roadway.

Inspect the tires and under the vehicle for possible damage. If the vehicle or tires appear unsafe, have it towed to the nearest Mercedes-Benz Light Truck Center or tire dealer for repairs.

Off-road driving increases strain on the vehicle.

We recommend that you inspect the vehicle for possible damage after each off-road trip. Recognizing any damage and a subsequent timely repair reduces the chance of a possible breakdown or accident later on.

Proceed as follows:

- Switch off the LOW RANGE mode (▷ page 118).
- Remove excessive dirt from tires, wheels, wheel housings, and underbody.

For instance, after driving in mud, clean the radiator, chassis, engine, brakes, and wheels from extreme dirt using a strong jet of water.

- Inspect frame, oil pan, brake hoses, etc., as well as vehicle underbody for possible damage.
- Check tires for possible damage, clean all exterior lamps, and conduct a brake test.
- Check for brush or branches caught in the undercarriage.

They could increase the possibility of a fire, as well as cut fuel and/or brake lines, puncture rubber bellows of the axles or drive shafts.

- After continued operation in mud, sand, water or other dirty conditions clean the brake discs, wheels, brake pads and check and clean axle joints.

Driving instructions

Trailer towing

Warning!



Failure to use proper equipment and driving technique can result in a loss of vehicle control when towing a trailer.

Improper towing or failure to follow the instructions contained in this guide can result in serious injury. Follow the guidelines below carefully to assure safe trailer operation.

Ask your authorized Mercedes-Benz Light Truck Center should you require an explanation of information contained in this guide.

Trailer hitches

- Only install a trailer hitch receiver approved for your vehicle.

For information on availability and installation, see your authorized Mercedes-Benz Light Truck Center.

- The bumpers on your vehicle are not designed for use with clamp-type hitches.

Do not attach rental hitches or other bumper-type hitches to them.

- To reduce the possibility of damage, remove the hitch ball adaptor from the receiver when not in use.

Electrical connections

The vehicle is prewired to accept the seven-wire harness included in the Mercedes-Benz approved trailer hitch receiver kit.

An additional four-pole conversion plug is included in the Mercedes-Benz supplied trailer hitch receiver kit.

For further information, see your authorized Mercedes-Benz Light Truck Center.

Vehicle and trailer weights and ratings

Gross Vehicle Weight Rating (GVWR) is the maximum permissible vehicle weight: 6614 lbs. (3000 kg).

Gross Vehicle Weight (GVW): Comprises weight of vehicle including fuel, tools, spare wheel, installed accessories, passengers, cargo and trailer tongue. It must never exceed the GVWR.

Gross Axle Weight Rating (GAWR) is the maximum permissible axle weight:

front	2976 lbs.	(1350 kg)
rear	3858 lbs	(1750 kg)

Gross Trailer Weight (GTW) is the maximum permissible trailer weight to be towed:

5000 lbs. (2260 kg)

Trailer Tongue Weight Rating (TWR) is the maximum permissible weight on the trailer tongue:

500 lbs. (225 kg) limit for Mercedes-Benz approved hitch receiver

Loading a trailer

- When loading a trailer, you should observe that neither the permissible GTW, nor the GVWR are exceeded.

Maximum permissible values are listed on the safety compliance certification labels for the vehicle and for the trailer to be towed.

The lowest value listed must be selected when determining how the vehicle and trailer are loaded.

- The tongue weight at the hitch ball must be added to the GVW to prevent exceeding your Mercedes-Benz tow vehicle's rear GAWR.



We recommend loading the trailer in such a manner that it has a tongue weight (TW) between 10% and 15% of the GTW.

Checking weights of vehicle and trailer

- To assure that the tow vehicle and trailer are in compliance with the maximum permissible weight limits have the loaded rig (tow vehicle including driver, passengers and cargo, trailer fully loaded) weighed on a commercial scale.
- Check the vehicle's front and rear Gross Axle Weight (GAW), the GTW and TW.

The values as measured must not be exceeded, according to the weight listed under "Vehicle and trailer weight and ratings".

Driving instructions

Attaching a trailer

Observe maximum permitted trailer dimensions (width and length).

Most states and all Canadian provinces require

- safety chains between your tow vehicle and the trailer.

The chains should be crisscrossed under the trailer tongue. They must be attached to the hitch receiver, and not to the vehicle's bumper or axle.

Be sure to leave enough slack in the chains to permit turning corners.

- a separate brake system at various trailer weights.
- a break-away switch on trailers with a separate brake system.

The switch activates the trailer brakes in the possible event that the trailer might separate from the tow vehicle.



Do not connect a trailer brake system (if trailer is so equipped) directly to the vehicle's hydraulic brake system, as your vehicle is equipped with antilock brakes. If you do, neither the vehicle's brakes nor the trailer's brakes will function properly.



The provided vehicle electrical wiring harness for trailer towing has a brake signal wire (color orange) for hook-up to a brake controller.

You should consider using a trailer sway control system. For further information see your authorized Mercedes-Benz Light Truck Center.

Towing a trailer

There are many different laws, including speed limit restrictions, having to do with trailer towing. Make sure that your rig will be legal, not only for where you reside, but also for where you will be driving. A good source for this information can be the police or local authorities.

Note the following points, when driving with the trailer:

- In order to gain skill and an understanding of the vehicle's behavior, you should practice turning, stopping and backing up in an area which is free from traffic.
- Before you start driving check the
 - trailer hitch
 - break-away switch
 - safety chains
 - electrical connections
 - lighting and tires

Adjust the mirrors to permit unobstructed view beyond rear of trailer.

- If the trailer has electric brakes, start your vehicle and trailer moving slowly, and then apply only the trailer brake controller by hand to be sure the brakes are working properly.
- Always secure items in the trailer to prevent load shifts while driving.
- When towing a trailer, check occasionally to be sure that the load is secure, and that lighting and trailer brakes (if so equipped) are functioning properly.
- Take into consideration that when towing a trailer, the handling characteristics are different and less stable from those when operating the vehicle without a trailer.

It is important to avoid sudden maneuvers.

- The vehicle and trailer combination is heavier, and therefore is limited in acceleration and climbing ability, and requires longer stopping distances.

It is more prone to reacting to side wind gusts, and requires more sensitive steering input.

- If possible, do not brake abruptly, but rather engage the brake slightly at first to permit the trailer to activate its brake. Then increase the braking force.



If the trailer should begin to sway, reduce the vehicle's speed and use the brake controller by hand to straighten out the vehicle and trailer.

In no case should you attempt to straighten out the tow vehicle and trailer by increasing the speed or oversteering and stepping on the brakes.

- If the transmission hunts between gears on inclines, manually shift to a lower gear (select **4**, **3**, **2** or **1**).

A lower gear and reduction of speed reduces the chance of engine overloading and /or overheating.

- On very steep inclines, not manageable with selector lever in position **1**, switch transfer case to LOW RANGE mode (▷ page 118).
- When going down a long hill, shift into a lower gear and use the engine's braking effect.

Avoid riding the brakes, thus overheating the vehicle and trailer brakes.

Driving instructions

- If the engine coolant rises to an extremely high temperature (coolant temperature needle approaching the red zone) when the air conditioning is on, turn off the air conditioning system.

Engine coolant heat can be additionally vented by opening the windows, switching the climate control fan speed to high and setting the temperature control to the maximum hot position.

- Extreme care must be exercised since your vehicle with a trailer will require additional passing distance ahead than when driving without a trailer.

Because your vehicle and trailer is longer than your vehicle alone, you will also need to go much farther ahead of the passed vehicle before you can return to your lane.

Parking

Warning!



To reduce the risk of personal injury, or damage to the vehicle powertrain, as a result of vehicle/trailer movement, always:

- Keep right foot on brake pedal.
- Shift gear selector lever to position **N**.
- Have a second person place wheel chocks on downhill side of left and right trailer wheels.
- Slowly release brake pedal and let vehicle and trailer roll into chocks until stopped.
- Firmly depress parking brake pedal.
- Move gear selector lever to position **P**.
- When parked on an incline, turn front wheel towards the road curb.

Passenger compartment

Warning!



Always fasten items being carried as securely as possible.

In an accident, during hard braking or sudden maneuvers, loose items will be thrown around inside the vehicle, and cause injury to vehicle occupants unless the items are securely fastened in the vehicle.

The trunk is the preferred place to carry objects. Always use partition net when transporting cargo. Partition net cannot secure hard or heavy objects.

Driving abroad

Abroad, there is a widely-spread Mercedes-Benz service network at your disposal. If you plan to drive into areas which are not listed in the index of your Mercedes-Benz Light Truck Center directory, you should request pertinent information from your authorized Mercedes-Benz Light Truck Center.

Control and operation of radio transmitters

MCS, radio and telephone*

Warning!



Do not forget that your primary responsibility is to drive the vehicle. Only operate the MCS, radio or telephone¹ if road, weather and traffic conditions permit.

Bear in mind that at a speed of just 30 mph (approximately 50 km/h), your vehicle is covering a distance of approximately 44 feet (approximately 13.5 m) every second.

¹ Observe all legal requirements.

Telephones and two-way radios

Warning!



Never operate radio transmitters equipped with a built-in or attached antenna (i.e. without being connected to an external antenna) from inside the vehicle while the engine is running. Doing so could lead to a malfunction of the vehicle's electronic system, possibly resulting in an accident and/or personal injury.

Radio transmitters, such as a portable telephone or a citizens band unit should only be used inside the vehicle if they are connected to an antenna that is installed on the outside of the vehicle.

Refer to the radio transmitter operation instructions regarding use of an external antenna.

Driving instructions

Catalytic converter

Your Mercedes-Benz is equipped with monolithic type catalytic converters, an important element in conjunction with the oxygen sensors to achieve substantial control of the pollutants in the exhaust emissions. Keep your vehicle in proper operating condition by following our recommended maintenance instructions as outlined in your Service Booklet.



To prevent damage to the catalytic converters, use only premium unleaded gasoline in this vehicle.

Any noticeable irregularities in engine operation should be repaired promptly. Otherwise, excessive unburned fuel may reach the catalytic converter, causing it to overheat and start a fire.

Warning!



As with any vehicle, do not idle, park or operate this vehicle in areas where combustible materials such as grass, hay or leaves can come into contact with the hot exhaust system, as these materials could be ignited and cause a vehicle fire.

Emission control

Certain engine systems serve to keep the toxic components of the exhaust gases within permissible legal limits.

These systems, of course, will function properly only when maintained strictly according to factory specifications. Any adjustments on the engine should, therefore, be carried out only by qualified Mercedes-Benz Light Truck Center authorized technicians. Engine adjustments should not be altered in any way. Moreover, the specified service jobs must be

carried out regularly according to Mercedes-Benz servicing requirements. For details refer to the Service Booklet.

Warning!



Inhalation of exhaust gas is hazardous to your health. All exhaust gas contains carbon monoxide, and inhaling it can cause unconsciousness and lead to death.

Do not run the engine in confined areas (such as a garage) which are not properly ventilated. If you think that exhaust gas fumes are entering the vehicle while driving, have the cause determined and corrected immediately. If you must drive under these conditions, drive only with at least one window fully open at all times.

Coolant temperature

During severe operating conditions and stop-and-go city traffic, the coolant temperature may rise to approx. 248°F (120°C).

The engine should not be operated with the coolant temperature in the red zone. Doing so may cause serious engine damage which is not covered by the Mercedes-Benz Limited Warranty.

Warning!



- Driving when your engine is badly overheated can cause some fluids which may have leaked into the engine compartment to catch fire. You could be seriously burned
- Steam from an overheated engine can cause serious burns and can occur just by opening the engine hood. Stay away from the engine if you see or hear steam coming from it.

Turn off the engine, get out of the vehicle and do not stand near the vehicle until it cools down.

At the gas station

At the gas station

Warning!



Gasoline is highly flammable and poisonous. It burns violently and can cause serious injury. Whenever you are around gasoline, avoid inhaling fumes and skin contact, extinguish all smoking materials. Never allow sparks, flame or smoking materials near gasoline!.

The fuel filler flap is located on the left-hand side of the vehicle towards the rear. Locking/unlocking the vehicle with the remote control automatically locks/unlocks the fuel filler flap.

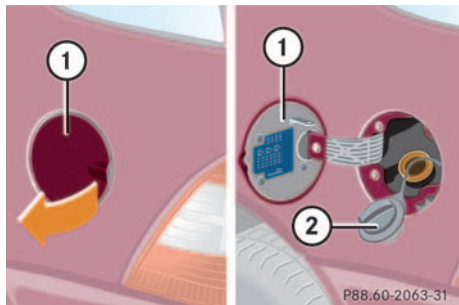

- ▶ Remove the key from the steering lock.
- ▶ Open the fuel filler flap **1** by pulling in direction of the arrow.
- ▶ Turn the fuel cap **2** to the left and hold on to it until possible pressure is released.
- ▶ Take off the cap.



The fuel filler cap is tethered to the fuel filler neck. Do not drop the cap. It could damage the vehicle paint finish.

- ▶ Only fill your tank until the filler nozzle unit cut out – do not top up or overfill.



To prevent damaging the lens of the plastic tail lamp, make certain that no gasoline comes into contact with it.

Warning!



Overfilling of the fuel tank may create pressure in the system which could cause a gas discharge. This could cause the gas to spray back out when removing the fuel pump nozzle, which could cause personal injury.

- ▶ Replace the fuel cap by turning it to the right.
You will hear when the fuel cap is tightened.
- ▶ Close the fuel filler flap.



Use only premium unleaded gasoline with a minimum Posted Octane Rating of 91 (average of 96 RON / 86 MON). Information on gasoline quality can normally be found on the fuel pump.

More information on gasoline can be found in the Factory Approved Service Products pamphlet.

i

Leaving the engine running and the fuel cap open can cause the **CHECK ENGINE** lamp to illuminate.

See also “Practical hints” section (▷ page 232).

Check regularly and before a long trip

- ▶ Open the hood (▷ page 202)

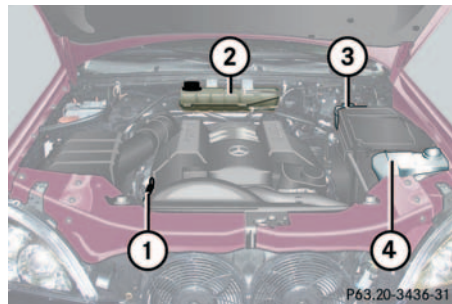
**1 Engine oil level**

More information on engine oil can be found in the “Operation” section (▷ page 203).

2 Coolant level

For normal replenishing, use water (potable water quality). More information on the coolant level can be found in the “Operation” section (▷ page 206).

3 Brake fluid

More information on brake fluid can be found in the “Technical data” section (▷ page 284).

4 Windshield washer and headlamp cleaning system

More information on filling the reservoir can be found in the “Operation” section (▷ page 208).

Vehicle lighting

Check function and cleanliness. More information on replacing light bulbs can be found in the “Practical hints” section (▷ page 247).

Combination switch (▷ page 102).

Tire inflation pressure

More information on tire inflation pressure can be found in the “Operation” section (▷ page 211).

Engine compartment

Engine compartment

Hood

Warning!



Do not pull the release lever while the vehicle is in motion. Otherwise the hood could be forced open by passing air flow.

Opening

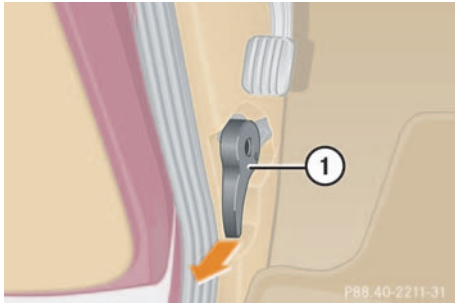

1 Hood release

- ▶ Pull lever **1** downwards.

The hood is unlocked. Handle **2** protrudes slightly from the radiator trim. If not, lift the hood slightly.



To avoid damage to the windshield wipers or hood, never open the hood if the wiper arms are folded forward away from the windshield.

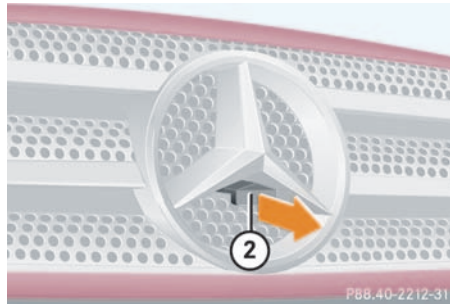

2 Handle for opening the hood

- ▶ Pull handle **2** to its stop out of the radiator grill.

- ▶ Pull up on the hood and then release it.

The hood will be automatically held open at shoulder height by gas-filled struts.

Warning!



To help prevent personal injury, stay clear of moving parts when the hood is open and the engine is running. Make sure the hood is properly closed before driving. When closing the hood, use extreme caution not to catch hands or fingers.

The radiator fan may continue to run for approximately 30 seconds or even restart after the engine has been turned off. Stay clear of fan blades.

Warning!

If you see flames or smoke coming from the engine compartment, or if the coolant temperature gauge indicates that the engine is overheated, do not open the hood. Move away from vehicle and do not open the hood until the engine has cooled. If necessary, call the fire department.

Warning!

The engine is equipped with a transistorized ignition system. Because of the high voltage it is dangerous to touch any components (ignition coils, spark plug sockets, diagnostic socket) of the ignition system

- with the engine running
- while starting the engine
- if ignition is “on” and the engine is turned manually

Closing**Warning!**

Be careful that you do not close the hood on anyone.

- ▶ Let the hood drop from a height of approximately 1 ft (30 cm).

The hood will lock audibly.

- ▶ Check to make sure that the hood is fully closed.

If you can raise the hood at a point above the headlamps, then it is not properly closed. Open it again and let it drop with somewhat greater force.



Do not push the hood closed manually, as this could damage it.

Engine oil

The amount of oil your engine needs will depend on a number of factors, including driving style. Higher oil consumption can occur when

- the vehicle is new
- the vehicle is driven frequently at higher engine speeds.

Engine oil consumption checks should only be made after the vehicle break-in period.

Checking engine oil level

When checking the oil level the vehicle must

- be parked on level ground
- be at normal operating temperature
- have been stationary for at least five minutes with the engine turned off

Engine compartment

Engine oil level display



1 Knob

2 Display in speedometer

- ▶ Switch on the ignition and wait until the display - - - - - appears in the speedometer display 2.
- ▶ Within one second press knob 1 twice.

One of the following messages will subsequently appear in the display:

- OIL i.0

The oil level is correct. Engine oil does not to be added.

- - 1.0 L
 - ▶ Add 1 liter of engine oil.
- - 1.5 L
 - ▶ Add 1.5 liters of engine oil.
- - 2.0 L
 - ▶ Add 2 liters of engine oil.
- OIL HI

The oil level is too high.

- ▶ Have excess oil siphoned.



Excessive oil must be siphoned or drained off. It could cause damage to the engine and catalytic converter not covered by the Mercedes-Benz Limited Warranty.

The display - - - - - flashes in the speedometer display if a proper oil level check cannot be performed.

- ▶ Repeat the engine oil level check after a few minutes.



If the engine oil level check cannot be performed again via the display field, use the dipstick to perform the engine oil level check (▷ page 205).

In this case we recommend that you have the system checked at a Mercedes-Benz Light Truck Center.

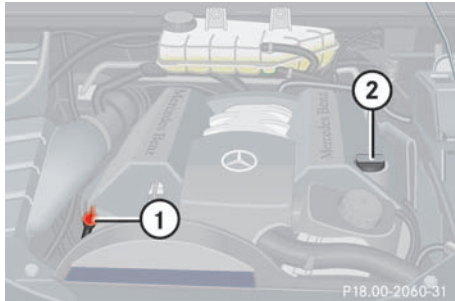
Oil dipstick

- 1 Oil dipstick
- 2 Oil filler cap

- ▶ Remove the oil dipstick 1.
- ▶ Wipe the oil dipstick clean.
- ▶ Fully insert dipstick in tube, and remove after three seconds.

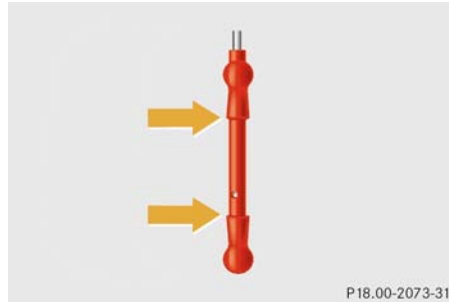

The engine oil level must be between the lower (min) and upper (max) mark of the dipstick.

- ▶ Add engine oil if necessary.



Fill quantity between upper and lower dipstick marking, the level is approximately 2.1 US qt (2.0 l).

Adding engine oil

- ▶ Unscrew the oil filler cap 2 from the filler neck. Be careful not to overfill with oil.

Be careful not to spill any oil when adding. Avoid environmental damage caused by oil entering the ground or water.



Excessive oil must be siphoned or drained off. It could cause damage to the engine and catalytic converter not covered by the Mercedes-Benz Limited Warranty.

- ▶ Screw the oil filler cap back on the filler neck.

More information on engine oil can be found in the “Technical data” section (▷ page 286).

Engine compartment

Transmission fluid level

The transmission fluid level does not need to be checked. If you notice transmission fluid loss or gear shifting malfunctions, have an authorized Mercedes-Benz Light Truck Center check the automatic transmission.

Coolant

The engine coolant is a mixture of water and anticorrosion/antifreeze. To check the coolant level, the vehicle must be parked on level ground and the engine must be cool.

Warning!



In order to avoid any possibly serious burns:

- Use extreme caution when opening the hood if there are any signs of steam or coolant leaking from the cooling system, or if the coolant temperature gauge indicates that the coolant is overheated.
- Do not remove pressure cap on coolant reservoir if engine temperature is above 194°F (90°C). Allow engine to cool down before removing cap. The coolant reservoir contains hot fluid and is under pressure.
- Using a rag, slowly open the cap approximately ½ turn to relieve excess pressure. If opened immediately, scalding hot fluid and steam will be blown out under pressure.
- Do not spill antifreeze on hot engine parts. Antifreeze contains ethylene glycol which may burn if it comes into contact with hot engine parts.

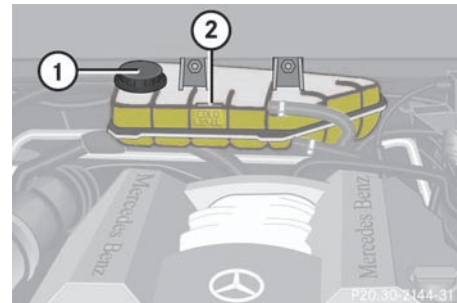

1 Cap

2 COLD LEVEL mark

The coolant level should reach the COLD LEVEL mark **2** in the reservoir.



If the engine is already at its regular operating temperature, the coolant may be approximately 0.6 in (1.5 cm) above the COLD LEVEL mark.

- ▶ Using a rag, turn the cap slowly approximately one half turn to the left to release any excess pressure.



- ▶ Continue turning the cap to the left and remove it.
- ▶ Add coolant as required.
- ▶ Replace and tighten cap.

More information on coolant can be found in the “Technical data” section (▷ page 287).

Battery

The battery is located in the engine compartment.

The battery should always be sufficiently charged in order to achieve its rated service life.

If you use your vehicle mostly for short distance trips, you will need to have the battery charge checked more frequently.

When replacing batteries, always use batteries approved by Mercedes-Benz.

If you do not intend to operate your vehicle for an extended period of time, consult an authorized Mercedes-Benz Light Truck Center about steps you need to observe.



Observe all safety instructions and precautions when handling automotive batteries.



Risk of explosion



Keep flames or sparks away from battery. Do not smoke.



Battery acid is caustic. Do not allow it to come into contact with skin, eyes or clothing.

In case it does, immediately flush affected area with clear water and seek medical help if necessary.



Wear eye protection.



Keep children away.



Follow the instructions in this Operator's Manual.

Batteries contain materials that can harm the environment if disposed of improperly. Recycling of batteries is the preferred method of disposal. Many states require sellers of batteries to accept old batteries for recycling.

Engine compartment

Windshield washer system and headlamp cleaning system

The windshield washer reservoir is located in the engine compartment.

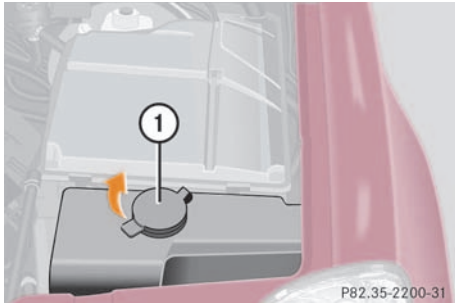

1 Cap

Fluid for the windshield washer system and the headlamp cleaning system* is supplied from the windshield washer reservoir. It has a capacity of 8.0 US qt (7.6 l).

During all seasons, add MB Windshield Washer Concentrate “S” to water. Premix the windshield washer fluid in a suitable container.

- ▶ Use the tab to pull cap 1 upwards (arrow).
- ▶ Refill the reservoir with MB Windshield Washer Concentrate and water (or commercially available premixed windshield washer solvent / antifreeze, depending on ambient temperatures).

Always use washer solvent/antifreeze where temperatures may fall below freezing. Failure to do so could result in damage to the washer system/reservoir.

Warning!



Washer solvent/antifreeze is highly flammable. Do not spill washer solvent/antifreeze on hot engine parts, because it may ignite. You could be seriously burned.

More information can be found in the “Technical data” section (▷ page 290).



Only use washer fluid which is suitable for plastic lenses. Improper washer fluid can damage the plastic lenses of the headlamps.

Tires and wheels

See your authorized Mercedes-Benz Light Truck Center for information on tested and recommended rims and tires for summer and winter operation. They can also offer advice concerning tire service and purchase.

Warning!



Replace rims or tires with the same designation, manufacturer and type as shown on the original part. See your authorized Mercedes-Benz Light Truck Center for further information. If incorrectly sized rims and tires are mounted:

- The wheel brakes or suspension components can be damaged
- The correct operating clearance of the wheels and the tires are no longer guaranteed

Warning!



Worn, old tires can cause accidents. If the tire tread is badly worn, or if the tires have sustained damage, replace them.

When replacing rims, use only genuine Mercedes-Benz wheel bolts specified for the particular rim type. Failure to do so can result in the bolts loosening and possibly an accident.

Retread tires are not tested or recommended by Mercedes-Benz, since previous damage cannot always be recognized on retreads. Mercedes-Benz can therefore not assure the operating safety of the vehicle when such tires are used.

See your authorized Mercedes-Benz Light Truck Center for information on tested and recommended rims and tires for summer and winter operation.

Important guidelines

- Use only sets of tires and rims of the same type and make.
- Tires must be of the correct size for the rim.
- Break in new tires for approximately 60 miles (100 km) at moderate speeds.
- Regularly check the tires and rims for damage.
- If vehicle is heavily loaded, check tire pressure and correct as required.
- Do not allow your tires to wear down too far. Adhesion properties on wet roads are sharply reduced at tread depths under $\frac{1}{8}$ in (3 mm).
- When replacing individual tires, you should mount new tires on the front wheels first.

Tires and wheels



When the wheels are heavily soiled, e.g. after driving through mud, clean the inside of the wheels with a jet of water.

Life of tire

The service life of a tire is dependent upon varying factors including but not limited to:

- Driving style
- Tire pressure
- Distance driven

Warning!



Tires and spare tire should be replaced after six years, regardless of the remaining tread.



Keep unmounted tires in a cool, dry place with as little exposure to light as possible. Protect tires from contact with oil, grease and gasoline.

Direction of rotation

Unidirectional tires offer added advantages, such as better hydroplaning performance. To benefit, however, you must ensure that the tires rotate in the direction specified.

An arrow on the sidewall indicates the intended direction of rotation of the tire.

Checking tire inflation pressure

Warning!



If the tire pressure repeatedly drops:

- Check the tires for punctures from foreign objects
- Check to see whether air is leaking from the valves or from around the rim

Correct the tire pressure only when tires are cold.

Regularly check your tire pressure at intervals of no more than 14 days.

If the tires are warm, you should only correct the tire pressure if it is too low for current operating conditions.

A table on the fuel filler flap lists the specified tire inflation pressures for warm and cold tires as well as for various operating conditions.



The pressures listed for light loads are minimum values offering high driving comfort.

Increased inflation pressures listed for heavier loads may also be used for light loads. These higher pressures produce favorable handling characteristics. The ride of the vehicle, however, will be somewhat harder. Never exceed the max. values or inflate tires below the min. values listed in the fuel filler flap.

Tire pressure changes by approximately 1.5 psi (0.1 bar) per 18°F (10°C) of air temperature change. Keep this in mind when checking tire pressure where the temperature is different from the outside temperature.

Tire temperature and tire pressure are also increased while driving, depending on the driving speed and the tire load.

Warning!



Follow recommended inflation pressures.

Do not overinflate tires. Overinflated tires can result in sudden deflation (blowout) because they are more likely to become punctured or damaged by road debris, potholes etc.

Do not underinflate tires. Underinflated tires wear unevenly, adversely affect handling and fuel economy, and are more likely to fail from being overheated.

Do not overload the tires by exceeding the specified vehicle capacity weight (as indicated by the label on the pillar in the driver's door opening). Overloading the tires can overheat them, possibly causing a blowout.

Check the spare tire periodically for condition and inflation. Spare tire will age and become worn over time even if never used, and thus should be inspected and replaced when necessary.

Tires and wheels

Rotating wheels

Warning!



Rotate front and rear wheels only if they are of the same size,

The wheels can be rotated every 3000 to 6000 miles (5000 to 10000 km) or sooner if necessary, according to the degree of tire wear. The same direction of tire rotation must be retained.

Rotate the wheels before the characteristic tire wear pattern becomes visible (shoulder wear on front wheels and tread center wear on rear wheels).

Thoroughly clean the inner side of the wheels after each rotation. Check and ensure proper tire inflation pressure.

Warning!



Have the tightening torque checked after changing a wheel. Wheels could become loose if not tightened with a torque of 110 ft.lb. (150 Nm).

Use only genuine Mercedes-Benz wheel bolts specified for your vehicle's rims.

Information on changing a wheel can be found in the “Practical hints” section (▷ page 255).

Winter driving

Before the onset of winter, have your vehicle winterized at an authorized Mercedes-Benz Light Truck Center. This service includes:

- Check of anticorrosion and antifreeze concentration.
- Addition of cleaning concentrate to the water of the windshield and headlamp cleaning system. Add MB Concentrate “S” to a premixed windshield washer solvent/antifreeze which is formulated for below freezing temperatures (▷ page 290).
- Battery test. Battery capacity drops with decreasing ambient temperature. A well charged battery helps to ensure that the engine can be started even at low ambient temperatures.
- Tire change. We recommend M+S rated radial-ply tires on all four wheels for the winter season.

Winter tires

Always use winter tires at temperatures below 39°F (4°C) and whenever wintry road conditions prevail. Use of winter tires is the only way to achieve the maximum effectiveness of the ABS, ESP, 4-ETS and EBP in winter operation.

For safe handling, ensure that all winter tires mounted are of the same make and have the same tread design.

Warning!



Winter tires with a tread depth under 0.16 in (4 mm) must be replaced. They are no longer suitable for winter operation.

Always observe the speed rating of the winter tires installed on your vehicle. If the maximum speed for which your tires are rated is below the speed rating of your vehicle, you must place a notice to this effect where it will be seen by the driver. Such notices are available from your tire dealer or from any authorized Mercedes-Benz Light Truck Center.

Warning!



If you use your spare tire when winter tires are fitted on the other wheels, be aware that the difference in tire characteristics may very well impair turning stability and that overall driving stability may be reduced. Adapt your driving style accordingly.

Have the spare tire replaced with a winter tire at the nearest authorized Mercedes-Benz Light Truck Center.

Winter driving

Block heater (Canada only)

The engine is equipped with a block heater.

The electrical cable may be installed at your authorized Mercedes-Benz Center.

Snow chains

Snow chains should only be driven on snow-covered roads at speeds not to exceed 30 mph (50 km/h). Remove chains as soon as possible when driving on roads without snow.



When driving with snow chains, you may wish to deactivate the ESP (▷ page 76) before setting the vehicle in motion. This will improve the vehicle's traction.



ML 55 AMG

Do not use snow chains with tire size 285/50 R 18.

Observe the following guidelines when using snow chains:

- Chains should only be used on all four wheels. With only two chains available, they should be mounted on the rear wheels. Follow the manufacturer's mounting instructions.
- Use only snow chains that are approved by Mercedes-Benz. Your authorized Mercedes-Benz Light Truck Center will be glad to advise you on this subject.

Maintenance

We strongly recommend that you have your vehicle serviced by your authorized Mercedes-Benz Light Truck Center, in accordance with the Service Booklet at the times called for by the FSS (Flexible Service System).



Failure to have the vehicle maintained in accordance with the Service Booklet at the designated times/mileage called for by the FSS may result in vehicle damage not covered by the Mercedes-Benz Limited Warranty.

FSS will notify you when your next service is due.



- 1 Knob
- 2 Display in the speedometer

Approximately one month before your next service is due, the type of service is indicated in the speedometer display **2**:

-  Minor service (A)
-  Major service (B)

The following information, depending on operating conditions throughout the year, is also shown:

- calculated distance remaining
- calculated remaining time in days



The interval between services depends on your driving habits. A gentle driving style, moderate engine speeds and the avoidance of short distance trips will lengthen the interval between services.



Clearing the service indicator

The service indicator is automatically cleared after 10 seconds when you switch on the ignition or when reaching the service threshold while driving. You can also clear it yourself.

- ▶ Press knob **1**.

Service term exceeded

If you have exceeded the suggested service term:

- the  or  symbol appears in the display **2** for 30 seconds and a signal sounds after switching on the ignition.
- it is preceded by a “-” (minus symbol).

The Mercedes-Benz Light Truck Center will reset the service indicator following a completed service.

Calling up the service indicator

- ▶ Within 1 second press knob **1** twice.
The FSS display will appear for ten seconds.

Resetting the service indicator

In the event that the service on your vehicle is not carried out by an authorized Mercedes-Benz Light Truck Center, you can reset the service indicator yourself.

- ▶ Switch ignition on and immediately press knob **1** twice within one second.
The present status for days or distance is displayed.
- ▶ Within ten seconds turn the key in steering lock to position **0** (▷ page 33).
- ▶ Press and hold knob **1** while switching the ignition on.
The present status for days or distance is displayed once more.
- ▶ Continue to hold knob **1**.
After approximately 10 seconds a signal sounds, and the display shows 10 000 miles (Canada: 15 000 km) for approximately 10 seconds.
- ▶ Release knob **1**.



If the service indicator was inadvertently reset, have a Mercedes-Benz Light Truck Center correct it.

Only reset if the proper service has been performed. Resetting the system without performing the proper service as called for by the FSS will cause the FSS to incorrectly determine the next service interval which will result in engine damage not covered by the Mercedes-Benz Limited Warranty.

If the battery is disconnected, the days of disconnection will not be included in the count shown by the service indicator. To arrive at the true service deadline, you will need to subtract these days from the days shown in the service indicator.

Do not confuse the service indicator with the engine oil level indicator .

Vehicle care

Cleaning and care of the vehicle

Warning!



Many cleaning products can be hazardous. Some are poisonous, others are flammable. Always follow the instructions on the particular container. Always open your vehicle's doors or windows when cleaning the inside.

Never use fluids or solvents that are not designed for cleaning your vehicle.

While in operation, even while parked, your vehicle is subjected to varying external influences which, if gone unchecked, can attack the paintwork as well as the underbody and cause lasting damage.

Such damage is caused not only by extreme and varying climatic conditions, but also by:

- Air pollution
- Road salt
- Tar, gravel and stone chipping

To avoid paint damage, you should immediately remove:

- Grease and oil
- Fuel
- Coolant
- Brake fluid
- Bird droppings
- Insects
- Tree resins, etc.

Frequent washing reduces and/or eliminates the aggressiveness and potency of the above adverse influences.

More frequent washings are necessary to deal with unfavorable conditions, for example:

- Near the ocean
- In industrial areas (smoke, exhaust emissions)
- During winter operation

You should check your vehicle from time to time for stone chipping or other damage. Any damage should be repaired as soon as possible to prevent corrosion.

In doing so, do not neglect the underbody of the vehicle. A prerequisite for a thorough check is a washing of the underbody followed by a thorough inspection. Damaged areas need to be re-undercoated.

Vehicle care

Your vehicle has been treated at the factory with a wax-base rustproofing in the body cavities which will last for the lifetime of the vehicle. Post-production treatment is neither necessary nor recommended by Mercedes-Benz because of the possibility of incompatibility between materials used in the production process and others applied later.

We have selected car-care products and compiled recommendations which are specially matched to our vehicles and which always reflect the latest technology. You can obtain Mercedes-Benz approved car-care products at your authorized Mercedes-Benz Light Truck Center.

Scratches, corrosive deposits, corrosion or damage due to negligent or incorrect care cannot always be removed or repaired with the car-care products recommended here. In such cases it is best to seek aid at your authorized Mercedes-Benz Light Truck Center.

The following topics deal with the cleaning and care of your vehicle and give important “how-to” information as well as references to Mercedes-Benz approved car-care products.

Additional information can be found in the booklet entitled “Vehicle Care Guide”.

Power washer

When using a power washer for cleaning the vehicle, always observe manufacturer’s operating instructions.



Never use a round nozzle to power wash tires. The intense jet of water can result in damage to the tire.

Always replace a damaged tire.

Always keep the jet of water moving across the surface. Do not aim directly at electrical parts, electrical connectors, seals, or other rubber parts.

Tar stains

Quickly remove tar stains before they dry and become more difficult to remove. A tar remover is recommended.

Paintwork, painted body components

Mercedes-Benz approved Paint Care should be applied when water drops on the paint surface do not “bead up”, normally every 3 to 5 months, depending on climate and washing detergent used.

Mercedes-Benz approved Paint Cleaner should be applied if the paint surface shows signs of dirt embedding (i.e. loss of gloss).

Do not apply any of these products or wax if your vehicle is parked in the sun or if the hood is still hot.

Use the appropriate MB-Touch-Up Stick for quick and provisional repairs of minor paint damage (i.e. chips from stones, vehicle doors, etc.).

Engine cleaning

Prior to cleaning the engine compartment, make sure to protect electrical components and connectors from the intrusion of water and cleaning agents.

Corrosion protection, such as MB Anticorrosion Wax should be applied to the engine compartment after every engine cleaning. Before applying, all control linkage bushings and joints should be lubricated. The poly-V-belt and all pulleys should be protected from any wax.

Vehicle washing

Do not use hot water or wash your vehicle in direct sunlight. Use only a mild car wash detergent, such as Mercedes-Benz approved Car Shampoo.

Thoroughly spray the vehicle with a diffused jet of water. Direct only a very weak spray towards the ventilation intake. Use plenty of water and rinse the sponge and chamois frequently.

Rinse with clear water and thoroughly dry with a chamois. Do not allow cleaning agents to dry on the finish.

Due to the width of the vehicle, fold in outside mirrors prior to running the vehicle through an automatic car wash to prevent damage to the mirrors.

In the winter, thoroughly remove all traces of road salt as soon as possible.

When washing the underbody, do not forget to clean the inner sides of the wheels.

Vehicle care

Ornamental moldings

For regular cleaning and care of very dirty chrome-plated parts, use a chrome cleaner.

Headlamps, tail lamps, turn signal lenses

Use a mild car wash detergent, such as Mercedes-Benz approved Car Shampoo, with plenty of water.

To prevent scratches, never apply strong force and use only a soft, non-scratchy cloth when cleaning the lenses. Do not attempt to wipe dirty lenses with a dry cloth or sponge.

Cleaning the Parktronic* system sensor

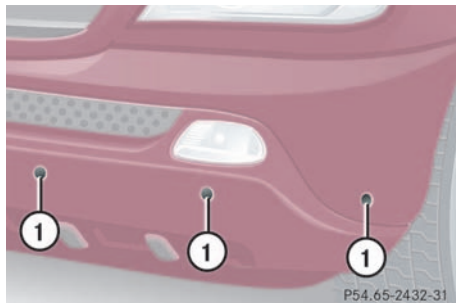

1 Parktronic system sensor

Use a mild car wash detergent, such as Mercedes-Benz approved Car Shampoo, with plenty of water to clean the sensor 1.

When using a steam cleaner or power washer, aim nozzle only briefly from a minimum distance of 4 in. (10 cm) at sensors 1.

To prevent scratches, never apply strong force and use only a soft, non-scratchy cloth when cleaning the sensor. Do not attempt to wipe dirty sensors with a dry cloth or sponge.

Wiper blades

Clean the wiper blade inserts with a clean cloth and detergent solution.



For safety reasons, remove key from steering lock before cleaning the wiper blades, otherwise the wiper motor can suddenly turn on and cause injury.

Window cleaning

Use a window cleaning solution on all glass surfaces. An automotive glass cleaner is recommended.



For safety reasons, switch off wipers and remove key from steering lock before cleaning the windshield, otherwise the wiper motor can suddenly turn on and cause injury.

Light alloy wheels

Mercedes-Benz approved Wheel Care should be used for regular cleaning of the light alloy wheels.

If possible, clean wheels once a week with Mercedes-Benz approved Wheel Care, using a soft bristle brush and a strong spray of water.

Follow instructions on container.



Use only acid-free cleaning materials. The acid could lead to corrosion.

Instrument cluster

Use a gentle dishwashing detergent or mild detergent for delicate fabrics as a washing solution. Wipe with a cloth moistened in lukewarm solution. Do not use scouring agents.

Steering wheel and gear selector lever

Wipe with a damp cloth and dry thoroughly or clean with Mercedes-Benz approved Leather Care.

Cup holder

Use a gentle dishwashing detergent or mild detergent for delicate fabrics as a washing solution. Wipe with a cloth moistened in lukewarm solution. Do not use scouring agents.

Hard plastic trim items

Pour Mercedes-Benz approved Interior Care onto soft lint-free cloth and apply with light pressure.

Headliner

Clean with soft bristle brush, or use a dry-shampoo cleaner in case of excessive dirt.

Seat belts

The webbing must not be treated with chemical cleaning agents. Use only clear, lukewarm water and soap. Do not dry the webbing at temperatures above 176°F (80°C) or in direct sunlight.

Warning!



Do not bleach or dye seat belts as this may severely weaken them. In a crash they may not be able to provide adequate protection.

Vehicle care

Upholstery

Using aftermarket seat covers or wearing clothing that have the tendency to give off coloring (e.g. when wet etc.) may cause the upholstery to become permanently discolored. By lining the seats with a proper intermediate cover, contact-discoloration will be prevented.

Leather upholstery

Wipe leather upholstery with a damp cloth and dry thoroughly or clean with Mercedes-Benz approved Leather Care. Exercise particular care when cleaning perforated leather as its underside should not become wet.

MB Tex upholstery

Pour Mercedes-Benz approved Interior Care onto soft lint-free cloth and apply with light pressure.

Plastic and rubber parts

Do not use oil or wax on these parts.



Practical hints

What to do if ...

Where will I find ...?

Unlocking/locking in an emergency

Opening/closing in an emergency

Replacing bulbs

Replacing wiper blades

Flat tire

Battery

Jump starting

Towing the vehicle

Fuses

What to do if ...



What to do if ...



Lamps in instrument cluster

General information:

If a bulb in the instrument cluster fails to light up during the bulb self-check when

turning the key in steering lock to position **2**, have it checked and replaced if necessary.

Problem	Possible cause	Suggested solution
 The yellow 4-ETS/ESP warning lamp lights up while driving.	The ESP is deactivated. Risk of accident! Adapt your speed and driving to the prevailing road conditions.	<ul style="list-style-type: none"> ▶ Turn the ESP back on (▷ page 77). If the ESP cannot be turned back on, have the system checked at an authorized Mercedes-Benz Center as soon as possible.
 The yellow 4-ETS/ESP warning lamp flashes while driving.	The ESP or 4-ETS has come into operation because of detected traction loss in at least one tire.	<ul style="list-style-type: none"> ▶ During take-off apply as little throttle as possible. ▶ While driving ease up on the accelerator. ▶ Adapt your speed and driving to the prevailing road and weather conditions. ▶ Do not deactivate the ESP (exceptions: (▷ page 76). Failure to follow these instructions increases the risk of accidents.

Problem	Possible cause	Suggested solution
<p> The yellow ABS malfunction indicator lamp comes on while driving.</p>	<p>ABS has detected a malfunction and has switched off. The BAS, ESP, 4-ETS and EBP are also switched off.</p> <p>The brake system is still functioning normally but without ABS available.</p>	<ul style="list-style-type: none"> ▶ Continue driving with added caution. Wheels will lock during hard braking reducing steering capability. ▶ Have the system checked at an authorized Mercedes-Benz Light Truck Center as soon as possible. <p>Failure to follow these instructions increases the risk of an accident.</p>
	<p>The charging voltage has fallen below 10 volts. The ABS has switched off.</p>	<p>When the voltage is above this value again, the ABS is operational again.</p> <ul style="list-style-type: none"> ▶ If necessary, have the generator and the battery checked.
<p> The yellow malfunction indicator lamp comes on while driving.</p>	<p>The ESP is no longer synchronized following a voltage supply interruption (e.g. battery disconnected or discharged).</p>	<p>Synchronize the ESP:</p> <ul style="list-style-type: none"> ▶ Turn the steering wheel from stop limit to stop limit. <p>The indicator lamp goes out.</p>
	<p>The charging voltage has fallen below 10 volts. The BAS and ESP have switched off.</p>	<p>When the voltage is above this value again, the BAS and ESP are operational again.</p> <ul style="list-style-type: none"> ▶ If necessary, have the generator and the battery checked.

What to do if ...



Problem	Possible cause	Suggested solution
BAS ESP The yellow malfunction indicator lamp comes on while driving.	The BAS or ESP is malfunctioning. It is possible that the engine output will be reduced.	▶ Have the BAS/ESP checked at an authorized Mercedes-Benz Light Truck Center as soon as possible.
ETS The yellow malfunction indicator lamp comes on while driving.	4-ETS has switched off to prevent overheating of the brakes. Also see 4-ETS/ESP warning lamp (▷ page 224).	As soon as the brakes have cooled off, 4-ETS switches on again. The indicator lamp goes out.
	4-ETS is malfunctioning and has switched off.	▶ Have the 4-ETS checked at your authorized Mercedes-Benz Light Truck Center as soon as possible.
LOW RANGE The yellow LOW RANGE indicator lamp blinks after one or more switching conditions.	The gear selection conditions have not been adhered to.	▶ Repeat the gear selection process (▷ page 118).
LOW RANGE The yellow LOW RANGE indicator lamp blinks after switching the ignition on.	LOW RANGE mode is malfunctioning.	Have the LOW RANGE mode checked at your authorized Mercedes-Benz Light Truck Center.

Problem	Possible cause	Suggested solution
SRS The red SRS indicator lamp lights up while driving.	There is a malfunction in the restraint systems. The airbags or emergency tensioning device (ETDs) could deploy unexpectedly or fail to activate in an accident.	► Drive with added caution to the nearest authorized Mercedes-Benz Light Truck Center.

Warning!

In the event a malfunction of the SRS is indicated as outlined above, the SRS may not be operational. For your safety, we strongly recommend that you visit an authorized Mercedes-Benz Center immediately to have the system checked, otherwise the SRS may not be activated when needed in an accident, which could result in serious or fatal injury, or it might deploy unexpectedly and unnecessarily which could result in an accident and/or injury to you or to others.

What to do if ...

Problem	Possible cause	Suggested solution
 The red brake warning lamp lights up while driving and you hear a warning sound.	You are driving with the parking brake set.	▶ Release the parking brake (▷ page 45).
 The red brake warning lamp lights up while driving.	There is insufficient brake fluid in the reservoir.	▶ Risk of accident! Carefully stop the vehicle and notify an authorized Mercedes-Benz Light Truck Center. Do not add brake fluid! This will not solve the problem.





Warning!



Driving with the brake warning lamp illuminated can result in an accident. Have your brake system checked immediately if the brake warning lamp stays on. Don't add brake fluid before checking the brake system. Overfilling the brake fluid reservoir can result in spilling brake fluid on hot engine parts and the brake fluid catching fire. You can be seriously burned.



If you find that the brake fluid in the brake fluid reservoir has fallen to the minimum mark or below, have the brake system checked for brake pad thickness and leaks.

Problem	Possible cause	Suggested solution
  <p>The red brake warning lamp lights up in addition to the yellow ABS malfunction lamp and you hear a warning sound.</p>	<p>There is a malfunction in the Electronic Brake Proportioning (EBP) system.</p> <p>The enhanced braking effect is not available.</p>	<p>► Have the system checked immediately at an authorized Mercedes-Benz Light Truck Center.</p> <p>Failure to follow these instructions increases the risk of accidents.</p>
 <p>The yellow warning lamp blinks after starting the engine or while driving.</p>	<p>The engine oil level has sunk to the minimum level. If the engine oil level continues to sink, the warning lamp will light up.</p>	<p>► Add approved oil at the next gas station (▷ page 286).</p> <p>► If oil loss is visible on the engine, have the malfunction corrected as soon as possible at a Mercedes-Benz Light Truck Center.</p>
 <p>The red indicator lamp does not go out after starting the engine.</p>	<p>The adjustable telescoping steering column is not properly locked.</p>	<p>► Lock the adjustable steering column (▷ page 37).</p>
 <p>The green front fog lamp indicator lamp lights up when ignition is turned on.</p>	<p>The front fog lamps are switched on.</p>	<p>► Fog lamps (▷ page 105).</p>

What to do if ...

Problem	Possible cause	Suggested solution
 <p>The yellow coolant warning lamp lights up when the engine is running.</p>	<p>The coolant is too hot.</p> <p>The coolant level is too low.</p>	<ul style="list-style-type: none"> ▶ Stop as soon as possible and allow the engine and coolant to cool down. ▶ Check the coolant level and add coolant if necessary (▷ page 206).
	<p>If the warning lamp lights up frequently, there is a leak in the cooling system.</p>	<ul style="list-style-type: none"> ▶ Have the cooling system checked by an authorized Mercedes-Benz Light Truck Center.
<p>The coolant temperature gauge is above 248 °F (120 °C).</p>	<p>The coolant level is too low.</p>	<ul style="list-style-type: none"> ▶ Stop as soon as possible and allow the engine and coolant to cool down. ▶ Add coolant to prevent engine from overheating (▷ page 206).
	<p>If the coolant level is correct, the electrical radiator fan may be broken.</p>	<ul style="list-style-type: none"> ▶ If the coolant temperature is below the red zone, drive on to the nearest authorized Mercedes-Benz Light Truck Center. <p>Avoid high engine loads (e.g. driving uphill) and stop-and-go driving.</p>

Warning!

Driving when your engine is badly overheated can cause some fluids which may have leaked into the engine compartment to catch fire. You could be seriously burned.

Steam from an overheated engine can cause serious burns and can occur just by opening the engine hood. Stay away from the engine if you see or hear steam coming from it.

Turn off the engine, get out of the vehicle and do not stand near the vehicle until it cools down.

Warning!

Do not spill antifreeze on hot engine parts. Antifreeze contains ethylene glycol which may burn if it comes into contact with hot engine parts. You can be seriously burned.





Do not ignore the coolant warning lamps. Extended driving with the symbol displayed may cause serious engine damage not covered by the Mercedes-Benz Limited Warranty.



Do not drive without sufficient amount of coolant. The engine will overheat, causing major engine damage.

What to do if ...

Problem	Possible cause	Suggested solution
<p>CHECK ENGINE</p> <p>The yellow “CHECK ENGINE” malfunction indicator lamp comes on while driving.</p>	<p>There is a malfunction of:</p> <ul style="list-style-type: none"> • The fuel management system • The ignition system • The emission control system • Systems which affect emissions <p>Such malfunctions may result in excessive emissions values and may switch the engine to its limp-home (emergency operation) mode.</p> <p>The fuel cap is not closed tightly.</p> <p>Your fuel tank is empty.</p>	<p>► Have the vehicle checked as soon as possible by an authorized Mercedes-Benz Light Truck Center. An on-board diagnostic connector is used by the service station to link the vehicle to the shop diagnostics system. It allows the accurate identification of system malfunctions through the readout of diagnostic trouble codes. It is located in the front left area of the footwell next to the parking brake pedal.</p> <p>Check the fuel cap (▷ page 200).</p> <p>► After refuelling start the engine three or four times in succession.</p> <p>The limp-home mode is canceled. You do not need to have your vehicle checked.</p>
<p>AIRBAG OFF</p> <p>The indicator lamp lights up.</p>	<p>A BabySmart™ child seat is installed on the front passenger seat. The front passenger airbag is therefore switched off.</p> <p>The system is malfunctioning when there is no BabySmart™ child seat installed on the front passenger seat.</p>	<p>► Have the system checked as soon as possible by an authorized Mercedes-Benz Light Truck Center.</p>

Problem	Possible cause	Suggested solution
 <p>The indicator lamp does not light up with a BabySmart™ child seat properly installed on the front passenger seat.</p>	<p>The system is malfunctioning.</p>	<ul style="list-style-type: none"> ▶ Make sure that there is nothing between seat cushion and child seat and check installation of the child seat (▷ page 63). ▶ If the light remains out, have the system checked as soon as possible by an authorized Mercedes-Benz Light Truck Center. <p>Do not use the BabySmart™ restraint to transport children on the front passenger seat until the system has been repaired.</p>
<p>The yellow fuel tank reserve warning lamp lights up while driving.</p>	<p>The fuel level has gone below the reserve mark.</p>	<ul style="list-style-type: none"> ▶ Refuel at the next gas station (▷ page 200).
 <p>The red charge indicator lamp lights up when the engine is running.</p>	<p>The battery is no longer charging.</p> <p>Possible causes:</p> <ul style="list-style-type: none"> • alternator malfunctioning • broken poly-V-belt 	<ul style="list-style-type: none"> ▶ Stop immediately and check the poly-V-belt. <p>If it is broken</p> <ul style="list-style-type: none"> ▶ Do not continue to drive, before the poly-V-belt is replaced. <p>Notify an authorized Mercedes-Benz Light Truck Center.</p>





What to do if ...

Problem	Possible cause	Suggested solution
 <p>The red seat belt warning lamp blinks for a brief period after starting the engine.</p>	The warning lamp reminds you to fasten seat belts.	▶ Fasten your seat belt (▷ page 60).
 <p>The yellow low washer system fluid level lamp lights up after starting the engine or while driving.</p>	There is approximately 1.3 US qt. (1.25 l) of washer fluid remaining in the reservoir.	▶ Add washer fluid (▷ page 208).
	The washer fluid may have frozen	▶ Move the vehicle to a warmer environment so that the washer fluid will thaw. ▶ Correct the concentration level after the washer fluid in the reservoir thaws.
 <p>The yellow brake indicator lamp lights up during braking or after starting the engine.</p>	The brake pads are worn down.	▶ Have the system checked at an authorized Mercedes-Benz Light Truck Center.



Brake pad thickness must be visually checked by a qualified technician at the intervals specified in the Service booklet.

Additional indicators in the speedometer display

Display	Possible cause	Suggested solution
	Perform minor service (A) (▷ page 215).	▶ Visit an authorized Mercedes-Benz Center to perform service.
	Perform major service (B) (▷ page 215).	▶ Visit an authorized Mercedes-Benz Center to perform service.
  <p>The StArt message lights up in addition to the Error message.</p>	The immobilizer is not operational.	▶ Contact an authorized Mercedes-Benz Center or call 1-800-FOR-MERCEdes (in the USA), or 1-800-387-0100 (in Canada).

Where will I find ...?

Where will I find ...?

First aid kit



Check expiration dates and contents for completeness at least once a year and replace missing/expired items.

ML 320, ML 350, ML 500

The first aid kit is stored in the liftgate.

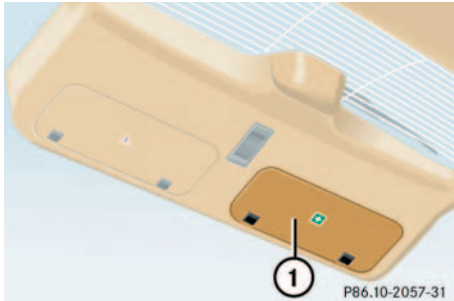

- ▶ Open and fold down panel **1**.

The first aid kit can be removed.

ML 55 AMG

The first aid kit is stored inside the spare wheel cover located in the rear cargo compartment.



- 1** Cargo area cover blind
- 2** Clamp
- 3** Cover

- ▶ Remove the cargo area cover blind **1** (▷ page 143).
- ▶ Open the clamps **2** and remove the cover **3**.

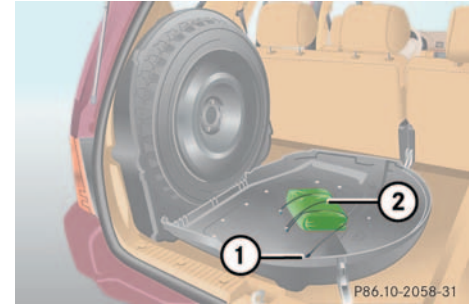

- 1** Fixing strap
- 2** First aid kit

- ▶ Release the fixing strap **1**.

The first aid kit **2** can be removed.

Vehicle tool kit

The vehicle tool kit is stored in the cargo area behind the right trim panel.

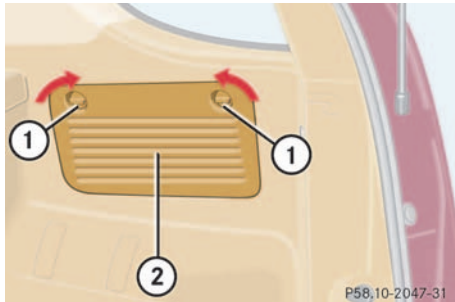

- ▶ Turn handles **1** 90° in direction of arrows.
- ▶ Fold down the panel **2**.

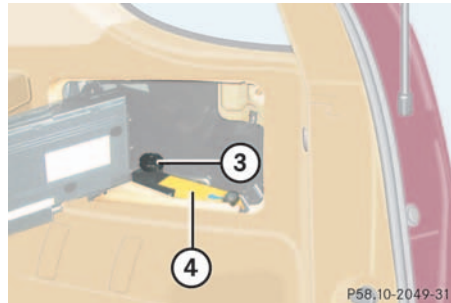

- 3** Screw
- 4** Vehicle jack with tool kit

- ▶ Turn screw **3** counterclockwise.
 - ▶ Remove vehicle jack.
- Vehicles with CD-changer*
(▷ page 238).

The jack is exclusively designed for lifting the vehicle during a wheel change. Always lower the vehicle on sufficient capacity jackstands before working under the vehicle.

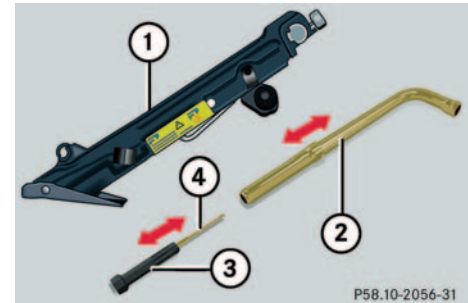

- 1** Vehicle jack
- 2** Wheel bolt wrench
- 3** Screwdriver
- 4** Interchangeable slot

Screwdriver **3** is placed inside the wheel-bolt wrench handle.

Where will I find ...?

Vehicle jack

Please also observe the safety guidelines in the “Flat tire” section (▷ page 255) when using the jack.

Warning!



The jack is designed exclusively for jacking up the vehicle at the jack take-up brackets built into both sides of the vehicle. To help avoid personal injury, use the jack only to lift the vehicle during a wheel change. Never get beneath the vehicle while it is supported by the jack. Keep hands and feet away from the area under the lifted vehicle. Always firmly set parking brake and block wheels before raising vehicle with jack.

Do not disengage parking brake while the vehicle is raised. Be certain that the jack is always vertical (plumb line) when in use, especially on hills. Always try to use the jack on level surface.

Make sure that the jack arm is fully seated in the jack take-up bracket. Always lower the vehicle onto sufficient capacity jack-stands before working under the vehicle.

Vehicle with CD-changer*

To access the vehicle tool kit, swing the CD-changer out of the panel.

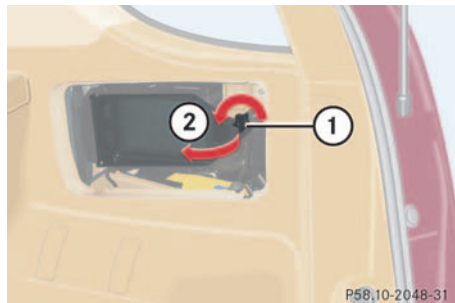

1 Screw

2 CD-changer

- ▶ Turn screw 1 counterclockwise.
- ▶ Swing the CD-changer 2 out of the panel.

Electric air pump (ML 55 AMG)

The electric air pump is located behind the spare wheel.

- ▶ Remove the spare wheel (▷ page 240).

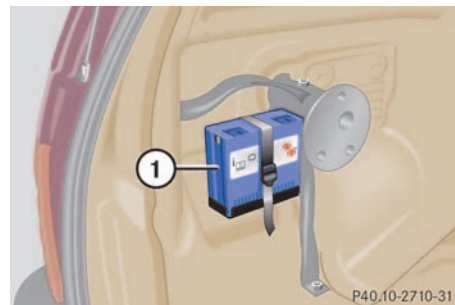

1 Electric air pump

- ▶ Open the strap and remove the electric air pump.

Spare wheel (space-saver tire)

Use the spare wheel only temporarily, while observing the following restrictions:

- Do not exceed vehicle speed of 50 mph (80 km/h).
- Drive to the nearest repair facility to have the flat tire repaired or replaced as appropriate.
- Do not operate vehicle with more than one spare wheel mounted.

Warning!



The dimensions of the spare wheel are different from those of the road wheels. As a result, the vehicle handling characteristics change when driving with a mounted spare wheel.



Please comply with the instructions for “Mounting the spare wheel” (▷ page 255).

Removing spare wheel (except ML 55 AMG)

Warning!



Exercise care when removing or installing spare wheel to prevent personal injury.

The spare wheel is located behind the rear bumper.

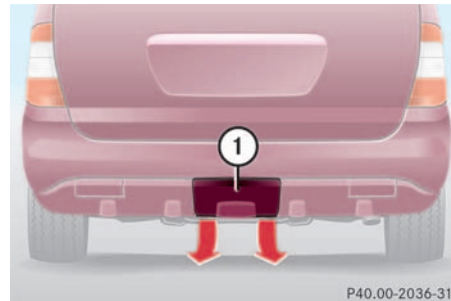

1 Cover

- ▶ Hold left and right side of cover 1 and pull away from bumper.

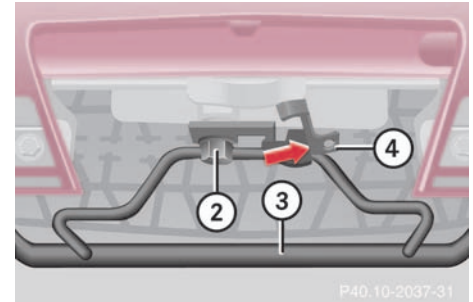

2 Screw

3 Spare wheel carrier

4 Lever

- ▶ Turn screw 2 counterclockwise using the wrench (▷ page 237).
Screw 2 remains in spare wheel carrier 3.
- ▶ Lift spare wheel carrier slightly and push lever 4 to the right using screwdriver (▷ page 237).
- ▶ Swing spare wheel carrier down and pull it out from under the bumper.

Where will I find ...?

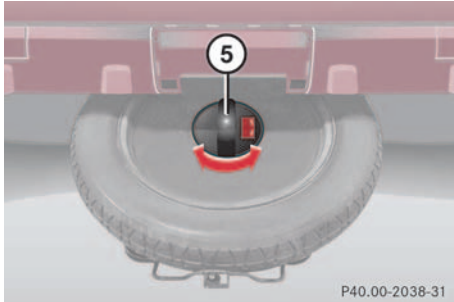

5 Bayonet lock

- ▶ Turn the bayonet lock 90° to the left.
- ▶ Pull off bayonet lock **5**.
- ▶ Remove the spare wheel cover and the spare wheel.
- ▶ Store bayonet lock **5** and spare wheel cover in cargo area.
- ▶ Replace the spare wheel carrier and secure it in place.
- ▶ Fasten handle **1** to the bumper.



When storing the space-saver spare wheel in its holder, secure it using the bayonet lock.

Removing spare wheel with collapsible tire (ML 55 AMG)

The spare wheel is located on the left side in the rear cargo compartment.



- 1 Cargo area cover blind
- 2 Clamp
- 3 Cover

- ▶ Remove the cargo area cover blind **1** (▷ page 143).
- ▶ Open the clamps **2** and remove the cover **3**.



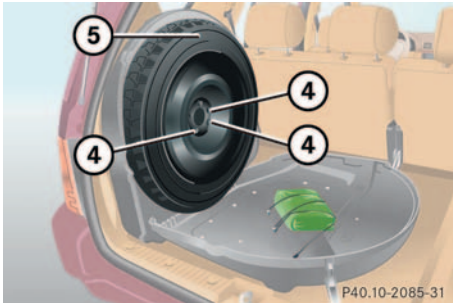

- 4** Wheel bolt
- 5** Spare wheel

- ▶ Unscrew the three wheel bolts using the wrench (▷ page 237).
- ▶ Take out the spare wheel.
- ▶ Remove the electric air pump from its holder (▷ page 238).



After using the spare wheel, have it deflate at an authorized Mercedes-Benz Light Truck Center. Store the deflated spare wheel in its holder and tighten the three wheel bolts with a tightening torque of 37 ft.lb. (50 Nm).

Unlocking/locking in an emergency

Unlocking/locking in an emergency

Unlocking the vehicle

Unlocking the driver's door

If you are unable to unlock the driver's door using the remote control, open the door using the key.

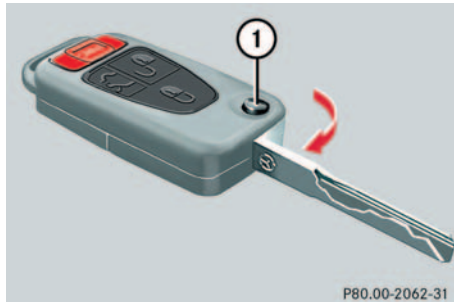

1 Release button

- ▶ Press release button 1 on the remote control.

The key folds out.

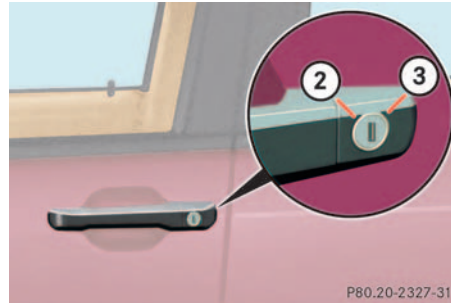



3 Unlocking

4 Locking

- ▶ Remove the protective cap from the door lock.
- ▶ Unlock the door with the mechanical key. To do so, push the mechanical key in the lock until it stops and turn it to the left.



Unlocking and opening the driver's door with the mechanical key will trigger the anti-theft alarm system. To cancel the alarm, do one of the following:

- Press button  or  on the remote control.
- Insert the key in the steering lock.

Unlocking/locking in an emergency

Locking the vehicle

If you are unable to lock the vehicle with the remote control, lock it with the mechanical key as follows:

- ▶ Close the passenger doors and the liftgate.
- ▶ Press the upper part of the central locking button in the cockpit (▷ page 89).
- ▶ Check to see whether the locking knobs on the passenger doors are still visible. If necessary push them down manually.
- ▶ Lock the liftgate if necessary from inside (▷ page 87).
- ▶ Lock the driver's door with the mechanical key.

Changing batteries

If the batteries in the remote control are discharged, the vehicle can no longer be locked or unlocked. It is recommended to have the batteries replaced at an authorized Mercedes-Benz Light Truck Center.

Warning!



Keep the batteries out of reach of children.

If a battery is swallowed, seek medical help immediately.

Batteries contain materials that can harm the environment if disposed of improperly. Recycling of batteries is the preferred method of disposal. Many states require sellers of batteries to accept old batteries for recycling.



When changing batteries, always replace both batteries.

The required replacement batteries are available at any Mercedes-Benz Light Truck Center.

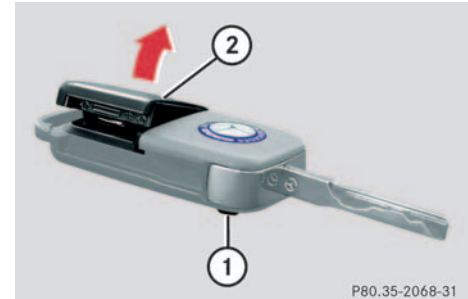

- 1 Release button
- 2 Battery cover

Replacement batteries: Lithium, type CR 2025 or equivalent.

- ▶ Unfold the key by pressing release button 1.



Unlocking/locking in an emergency





- ▶ Pull off battery cover **2** in direction of arrow.
- ▶ Remove the batteries.



- ▶ Using a lint-free cloth, insert new batteries under the contact spring with the plus (+) side facing up.
- ▶ Press battery cover onto housing until locked in place.
- ▶ Push each button to assure proper operation of the remote control.

If remote control does not function correctly after replacing the batteries, the system may have to be resynchronized.

Synchronizing remote control

- ▶ Turn key in steering lock to position **2**, then to position **0** and remove.
- ▶ Within 10 seconds, push and hold button  while pushing button  five times.
- ▶ Release the button, and press ,  or  once.

The remote control is resynchronized.

- ▶ Recheck all of the remote control functions.



If it is not possible to resynchronize the remote control, have the system checked at your authorized Mercedes-Benz Light Truck Center.

Fuel filler flap

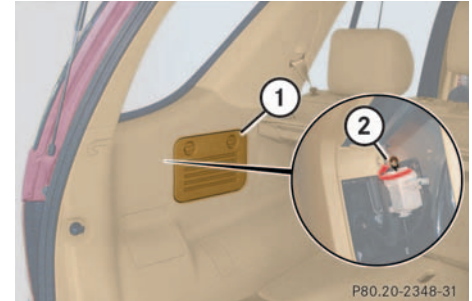

- 1** Cover
- 2** Lock rod

- ▶ Open cover **1** in cargo area behind the left trim panel.



ML 55 AMG:

First remove the spare wheel from its holder (▶ page 240).

- ▶ Turn lock rod **2** clockwise (arrow) to the end stop.
- ▶ Open the fuel filler flap.

Manually unlocking the transmission selector lever

In the case of power failure the transmission selector lever can be manually unlocked, e.g. to tow the vehicle.

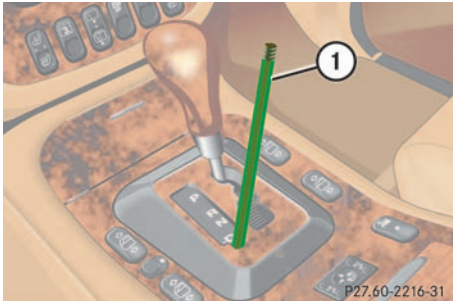

1 Pencil

- ▶ Insert a pin **1**, e.g. pencil, into the covered opening below the position **D** of the shift pattern.
- ▶ Push the pin down.
- ▶ Move selector lever from position **P**.
- ▶ Remove the pin from the opening.

The cover returns to its closed position after moving the selector lever to position **D**.



The selector lever is locked again when moving it to position **P**.

Opening/closing in an emergency

Opening/closing in an emergency

Sliding/pop-up roof*

The sliding/pop-up roof drive is located behind the cover between the front interior lamps.

You can open or close the sliding/pop-up roof manually should an electrical malfunction occur.

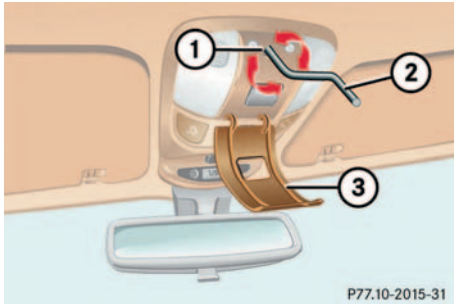

- 1 Hexagon drive hole
- 2 Crank
- 3 Cover

- ▶ Pry off cover **3** using a flat blade screwdriver.
- ▶ Obtain crank **2** (supplied with vehicle) and insert in hexagon drive **1**



Push crank **2** upward while turning it, to disengage the electric motor.

- ▶ Turn crank **2** clockwise to:
 - slide roof closed
 - raise roof at the rear
- ▶ Turn crank **2** counterclockwise to:
 - slide roof open
 - lower roof at the rear

The sliding/pop-up roof must be synchronized if it has been operated manually (▷ page 138).

Replacing bulbs

Safe vehicle operation depends on proper exterior lighting and signaling. It is therefore essential that all bulbs and lamp assemblies are in good working order at all times.

Correct headlamp adjustment is extremely important. Have headlamps checked and readjusted at regular intervals and when a bulb has been replaced. See your authorized Mercedes-Benz Light Truck Center for headlamp adjustment.



If the headlamps are fogged up on the inside as a result of high humidity, driving the vehicle a distance should clear out the fogging.

Bulbs

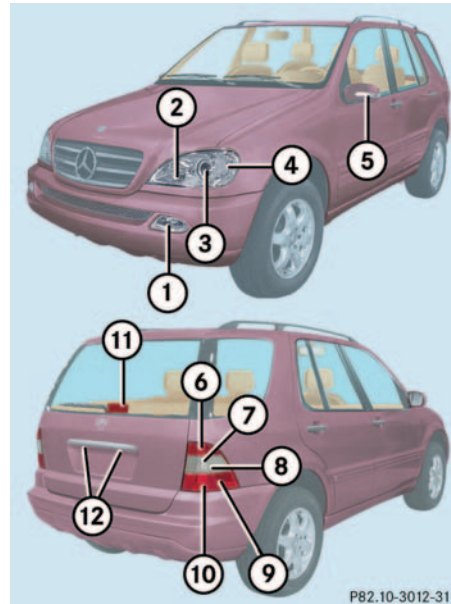

Front lamps

Lamp	Type
1 Fog lamp	H8 35 W
2 High beam	H7 (55 W)
3 Low beam	H7 (55 W) Xenon* D2S-35 W
4 Turn signal, parking, standing and side marker lamp	1157 NA (32/3 cp bulb)
5 Additional turn signal	LED

Replacing bulbs

Rear lamps

Lamp	Type
6 Brake lamp	1073 (32 cp bulb)
7 Backup lamp	1073 (32 cp bulb)
8 Turn signal lamp	PY 21 W
9 Tail, parking and standing lamp Rear fog lamp, driver's side	P 21/4 W
10 Side marker lamp	W 5 W
11 High mounted brake lamp	1073 (32 cp bulb)
12 License plate lamps	C 5 W

Notes on bulb replacement

Warning!



Keep bulbs out of reach of children.

Bulbs and bulb sockets can be very hot. Allow the lamp to cool down before changing a bulb.

Halogen lamps contain pressurized gas. A bulb can explode if you:

- touch or move it when hot
- drop the bulb
- scratch the bulb

Wear eye and hand protection.

Because of high voltage in xenon lamps, it is dangerous to replace the bulb or repair the lamp and its components. We recommend that you have such work done by a qualified technician.

- Use only 12-volt bulbs of the same type and with the specified watt rating.
- Switch lights off before changing a bulb to prevent short circuits.
- Always use a clean lint-free cloth when handling bulbs.
- Your hands should be dry and free of oil and grease.
- If the newly installed bulb does not light up, visit an authorized Mercedes-Benz Light Truck Center.
- Have the LEDs and bulbs for the following lamps replaced by an authorized Mercedes-Benz Light Truck Center:
 - Additional turn signals in the exterior rear view mirrors
 - Bi-Xenon lamps*
 - Front fog lamps (vehicles with sport package)*

Replacing bulbs for front lamps

Replacing low beam bulbs

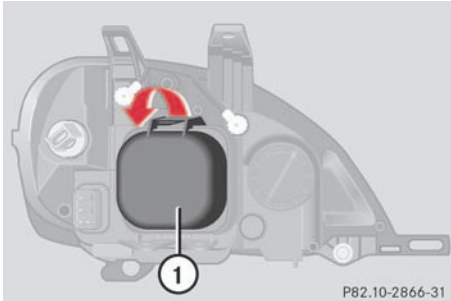

1 Low beam halogen or Bi-Xenon* headlamp cover with locking tab

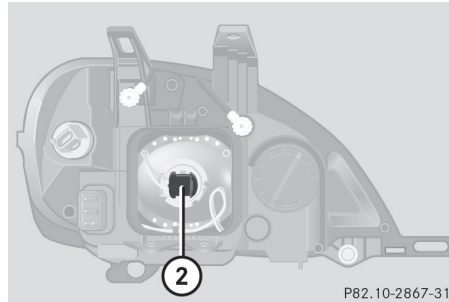

2 Electrical connector

Bi-Xenon* headlamp

Warning!



Do not remove the cover **1** for the Bi-Xenon headlamp. Because of high voltage in xenon lamps, it is dangerous to replace the bulb or repair the lamp and its components. We recommend that you have such work done by a qualified technician.

Halogen headlamp

- ▶ Switch off the lights.
- ▶ Open the hood (▷ page 202).
- ▶ Push down tab at top end of cover **1** and remove.
- ▶ Pull electrical connector **2** off.
- ▶ Unclip the retainer springs and take out the bulb.
- ▶ Insert the new bulb so that the base locates in the recess on the holder.
- ▶ Clip the retainer springs.
- ▶ Plug the connector **2** onto the bulb.
- ▶ Align headlamp cover and click into place.

Replacing bulbs

High beam bulbs

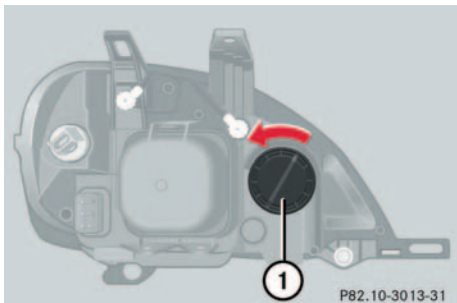

1 High beam headlamp cover with locking tab

- ▶ Switch off the lights.
- ▶ Open the hood (▷ page 202).
- ▶ Twist cover **1** counterclockwise and remove.

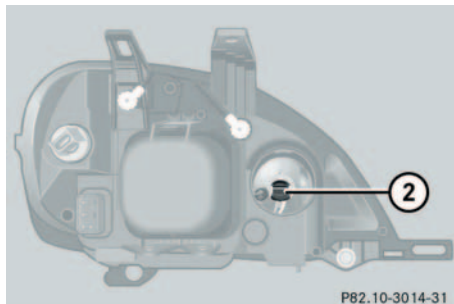

2 Electrical connector

- ▶ Pull electrical connector **2** off.
- ▶ Unclip the retainer springs and take out the bulb.
- ▶ Insert the new bulb so that the base locates in the recess on the holder.
- ▶ Clip the retainer springs.
- ▶ Plug the connector **2** onto the bulb.
- ▶ Align headlamp cover and click into place.

Turn signal, parking, standing and side marker lamp bulbs

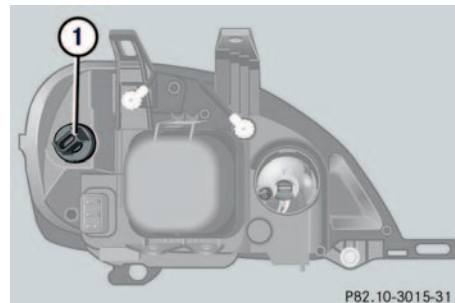

1 Bulb socket

- ▶ Switch off the lights.
- ▶ Open the hood (▷ page 202).
- ▶ Twist bulb socket **1** counterclockwise and pull out.
- ▶ Push bulb into socket, turn counterclockwise and remove.
- ▶ Insert new bulb in socket, push in and twist clockwise.
- ▶ Reinstall the bulb socket.



- ▶ Align headlamp cover and click into place.

Fog lamp bulbs

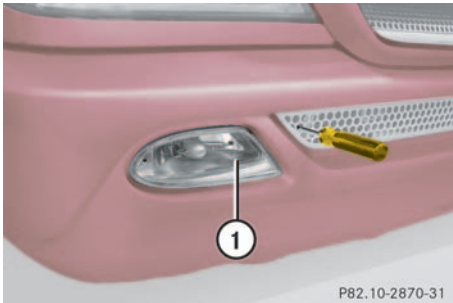

1 Fog lamp

- ▶ Switch off the lights.
 - ▶ Use a suitable object (e.g. screwdriver) to press on the release lever behind the front panel.
- Front fog lamp **1** releases.
- ▶ Remove fog lamp out of bumper.

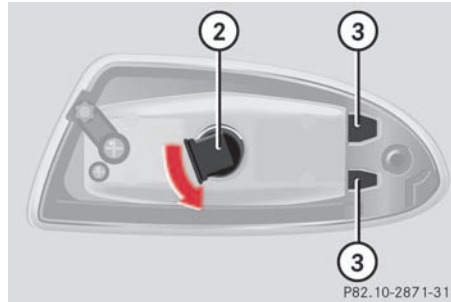

2 Bulb socket

3 Tabs

- ▶ Twist bulb socket **2** counterclockwise to its end stop and pull out.
 - ▶ Pull bulb out of the bulb socket.
 - ▶ Insert new bulb in socket.
 - ▶ Reinstall bulb socket **2**.
 - ▶ Twist bulb socket **2** clockwise to its end stop.
 - ▶ Reinstall fog lamp into the bumper.
- Make sure that tabs **3** firmly seat into the slots of holder.

Replacing bulbs for rear lamps

Tail lamp assemblies

- ▶ Switch off the lights.
- ▶ Open liftgate.

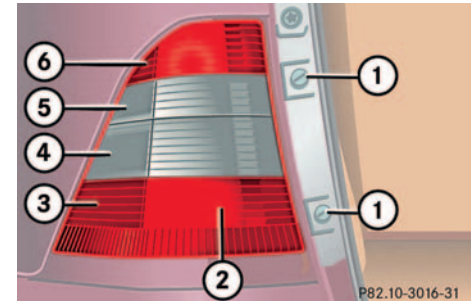

1 Screws

2 Tail, parking and standing lamp
Fog lamp, driver's side

3 Side marker lamp

4 Turn signal lamp

5 Backup lamp

6 Brake lamp

- ▶ Remove screws **1**.
- ▶ Remove tail lamp.



Replacing bulbs

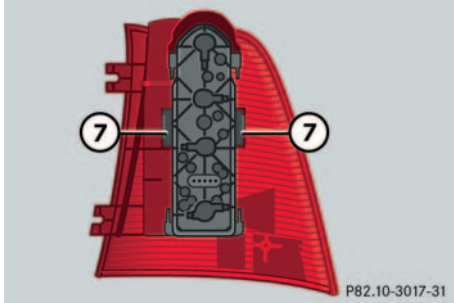

7 Tabs

- ▶ Squeeze tabs **7** together and remove bulb holder.
- ▶ Gently push bulb into socket, turn counterclockwise and remove.
- ▶ Insert new bulb in socket, push in and turn clockwise.
- ▶ Reinstall bulb holder. You should hear it engage.
- ▶ Insert the tail lamp in the body, lower edge first. Make sure that it engages.
- ▶ Retighten screws with washers on them.

License plate lamp

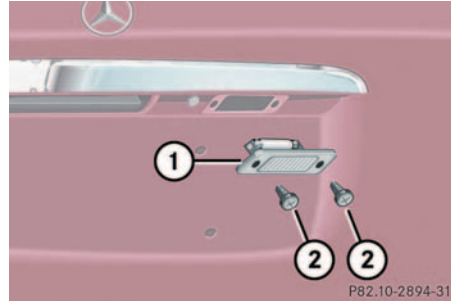

1 License plate lamp

2 Screws

- ▶ Switch off the lights.
- ▶ Loosen both screws **1** and remove lamp.
- ▶ Replace the tubular lamp and reinstall lamp.
- ▶ Retighten the screws.

High mounted brake lamp

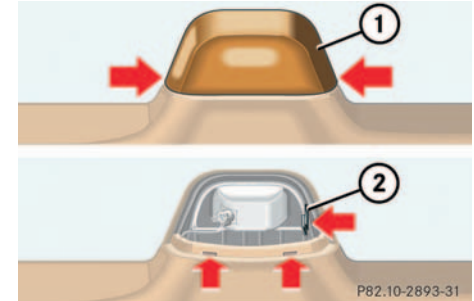

1 Cover

2 Tab

- ▶ Switch off the lights.
- ▶ Squeeze both sides of cover **1**, fold it forward and remove.
- ▶ Press tab **2** on reflector and remove reflector.
- ▶ Gently push bulb into socket, turn counterclockwise and remove.
- ▶ Insert new bulb in socket, push in and turn clockwise.



- ▶ Insert reflector from the left so that it engages on the right.
- ▶ Position tabs of cover in slots and reinstall cover until properly seated.

Adjusting headlamp aim

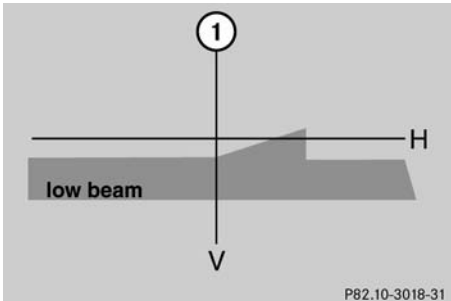

P82.10-3018-31

V Vertical centerline

H Headlamp mounting high, measured from the center



High beam adjustments simultaneously aim the low beam.

Vehicle should have a normal trunk load.

Correct headlamp adjustment is extremely important. To check and readjust a headlamp, follow the steps described:

- ▶ Park the vehicle on a level surface 25 feet (7.6 m) from a vertical test screen or wall.
- ▶ Switch the headlamps on (▷ page 102).

If the beam does not show a beam pattern as indicated in the figure left, then follow the steps below:

- ▶ Open hood (▷ page 202).

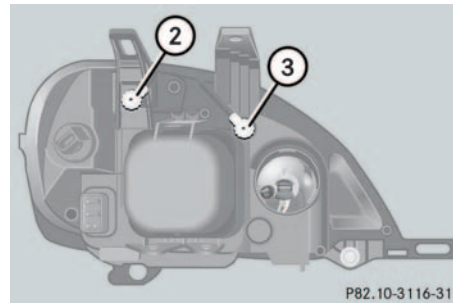

P82.10-3116-31

2 Headlamp vertical adjustment screw

3 Headlamp vertical adjustment screw

- ▶ Always turn adjustment screws **2** and **3** simultaneously for vertical adjustment until the headlamp is adjusted as shown **1**. Turn clockwise for upward movement and counterclockwise for downward movement.

Graduations:

screw **2**: 0.50° pitch

screw **3**: 0.67° pitch

The left and right headlamps must be adjusted individually.



If it is not possible to obtain a proper headlamp adjustment, have the system checked at your authorized Mercedes-Benz Light Truck Center.

Replacing wiper blades

Replacing wiper blades

Warning!



For safety reasons, remove key from steering lock before replacing a wiper blade, otherwise the motor could suddenly turn on and cause injury.

Removal

- ▶ Fold the wiper arm forward.
- ▶ Turn wiper blade at a right angle to wiper arm.

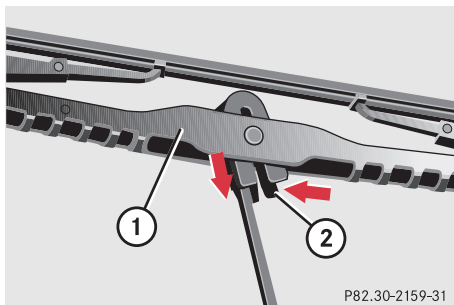

1 Wiper blade

2 Safety tab

- ▶ Press safety tab down **2**.
- ▶ Push wiper blade downward **1** and remove.

Installation

- ▶ Slide wiper blade into end of wiper arm until it locks in place.



Never open the hood when the wiper arm is folded forward.

Do not allow the wiper arms to contact the windshield glass without a wiper blade inserted.

Make certain that the wiper blades are properly installed. Improperly installed wiper blades may cause windshield damage.

For your convenience, we recommend that you have this work carried out by an authorized Mercedes-Benz Light Truck Center.

Flat tire

Mounting the spare wheel

Warning!



The dimensions of the spare wheel are different from those of the road wheels. As a result, the vehicle handling characteristics change when driving with a mounted spare wheel. Adapt your driving style accordingly.

The spare wheel is for temporary use only. When driving with spare wheel mounted, ensure proper tire pressure and do not exceed vehicle speed of 50 mph (80 km/h).

Drive to the nearest Mercedes-Benz Light Truck Center as soon as possible to have the spare wheel replaced with a regular road wheel.

Never operate the vehicle with more than one spare wheel mounted.

Preparing the vehicle

- ▶ Park the vehicle as far as possible from moving traffic on a hard surface.
- ▶ Turn on the hazard warning flashers.
- ▶ Engage the steering wheel lock in the straight ahead position and set the parking brake.
- ▶ Move the selector lever to **P**.
- ▶ Have any passenger exit the vehicle at a safe distance from the roadway.
- ▶ Take the spare wheel out of its carrier (▷ page 239).
ML 55 AMG: (▷ page 240).

Lifting the vehicle

- ▶ Prevent the vehicle from rolling away by blocking wheels with wheel chocks (not included) or other sizable objects.

When changing wheel on a level surface:

- ▶ Place one chock in front of and one behind the wheel that is diagonally opposite to the wheel being changed.

When changing wheel on a hill:

- ▶ Place chocks on the downhill side blocking both wheels of the other axle.
- ▶ Take the two-piece wheel wrench and the jack out of the rear compartment area (▷ page 237). Assemble wheel wrench.

Flat tire

Warning!



The jack is designed exclusively for jacking up the vehicle at the jack take-up brackets built into both sides of the vehicle. To help avoid personal injury, use the jack only to lift the vehicle during a wheel change. Never get beneath the vehicle while it is supported by the jack. Keep hands and feet away from the area under the lifted vehicle. Always firmly set parking brake and block wheels before raising vehicle with jack.

Do not disengage parking brake while the vehicle is raised. Be certain that the jack is always vertical (plumb line) when in use, especially on hills. Always try to use the jack on level surface. Make sure that the jack arm is fully seated in the jack take-up bracket. Always lower the vehicle onto sufficient capacity jackstands before working under the vehicle.



- ▶ On wheel to be changed, loosen but do not yet remove the wheel bolts (approximately one full turn with wrench).

The jack take-up brackets are located directly behind the front wheel housings and in front of the rear wheel housings.



Do not position the jack on the body of the vehicle, as this may cause damage to the vehicle.

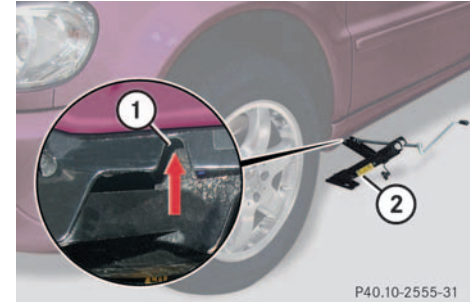

- 1** Take-up bracket
- 2** Jack

- ▶ Place jack on firm ground.
- ▶ Position jack **2** under the take-up bracket **1** so that it is always vertical (plumb-line) as seen from the side, even if the vehicle is parked on an incline.
- ▶ Jack up the vehicle until the wheel is a maximum of 1.2 in (3 cm) from the ground. Never start engine while vehicle is raised.

Removing the wheel

- ▶ Unscrew and remove all wheel bolts.
- ▶ Remove the remaining bolts.



Do not place wheel bolts in sand or dirt. This could result in damage to the bolt and wheel hub threads.

- ▶ Grip the wheel from the sides and remove it.

Mounting the new wheel

- ▶ Clean contact surfaces of wheel and wheel hub.
- ▶ Install spare wheel on wheel hub.
- ▶ Insert wheel bolts and tighten them slightly.
- ▶ ML 55 AMG:
Inflate the spare wheel with collapsible tire using the electric air pump (▷ page 259).

Warning!



ML 55 AMG:

Inflate the spare wheel with collapsible tire only after the wheel is properly mounted.

Inflate the spare wheel tire using the electric air pump (▷ page 259) before lowering the vehicle.



To avoid paint damage, place wheel flat against hub and hold it there while installing first wheel bolt.

Warning!



Always replace wheel bolts that are damaged or rusted.

Never apply oil or grease to wheel bolts.

Damaged wheel hub threads should be repaired immediately. Do not continue to drive under these circumstances! Contact an authorized Mercedes-Benz Light Truck Center or call Roadside Assistance.

Incorrect mounting bolts or improperly tightened mounting bolts can cause the wheel to come off. This could cause an accident. Be sure to use the correct mounting bolts.

Flat tire

Warning!



Use only genuine equipment Mercedes-Benz wheel bolts. They are identified by the Mercedes star. Other wheel bolts may come loose.

Do not tighten the wheel bolts when the vehicle is raised. Otherwise the vehicle could tip over.

Lowering the vehicle

- ▶ Lower vehicle by turning crank counterclockwise until vehicle is resting fully on its own weight.
- ▶ Remove the jack.

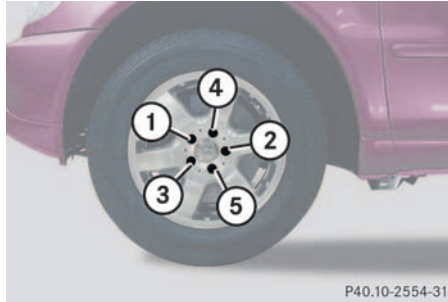

P40.10-2554-31

1 - 5 Wheel bolts

- ▶ Tighten the five wheel bolts evenly, following the diagonal sequence illustrated (1 to 5), until all bolts are tight. Observe a tightening torque of 110 ft lb (150 Nm).

Warning!



Have the tightening torque checked after changing a wheel. The wheels could come loose if they are not tightened to a torque of 110 ft lb (150 Nm).

- ▶ Store jack and tool kit.



The removed road wheel cannot be stored in the spare wheel carrier or inside the storage compartment in the rear cargo area (ML 55 AMG), but should be transported in the rear cargo compartment wrapped in a protective cover supplied with the vehicle.

The protective cover is located in the rear cargo compartment behind the cover in the right side trim panel.

Inflating the spare wheel with collapsible tire

- ▶ Take the electric air pump out of the rear cargo compartment (▷ page 238).

Warning!



Observe instructions on air pump label.

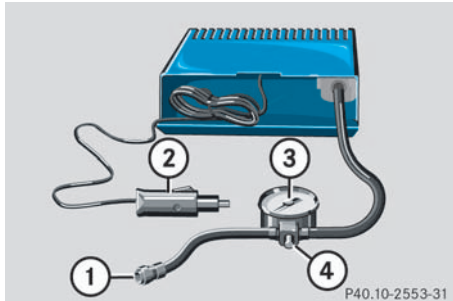

- 1 Union nut
- 2 Electrical plug
- 3 Air hose with pressure gauge
- 4 Vent screw

- ▶ Open flap on air pump.
- ▶ Pull out electrical plug **2** and air hose with the pressure gauge **3**.
- ▶ Close the vent screw **4**.
- ▶ Remove the valve cap from the spare wheel tire valve.
- ▶ Screw the union nut **1** with air hose **3** on to the tire valve.
- ▶ Insert electrical plug **2** into the electrical outlet in the front passenger footwell or rear cargo compartment (▷ page 158).
- ▶ Start the engine.
- ▶ Switch on the air pump.
- ▶ Operate air pump until the pressure gauge displays 61 psi (4.2 bar)

This takes about eight minutes for the collapsible tire. The air hose **3** and the union nut **1** can become hot during inflation. Please exercise appropriate caution.



Do not operate the electric air pump longer than eight minutes without interruption. Otherwise it may overheat.

You may operate the air pump again after it has cooled off.

- ▶ Switch off the air pump.
- ▶ Turn off the engine.
- ▶ If the tire pressure is above 61 psi (4.2 bar), release excess tire pressure using the vent screw **4**.

Flat tire

Warning!



Follow recommended inflation pressures.

Do not overinflate tires. Overinflated tires can result in sudden deflation (blowout) because they are more likely to become punctured or damaged by road debris, potholes etc.

Do not underinflate tires. Underinflated tires wear unevenly, adversely affect handling and fuel economy, and are more likely to fail from being overheated.

Do not overload the tires by exceeding the specified vehicle capacity weight (as indicated by the label on the driver's door latch post). Overloading the tires can overheat them, possibly causing a blowout.

- ▶ Detach the electric air pump.
- ▶ Reinstall tire valve cap.
- ▶ Store the electrical plug and the air hose behind the flap and place the air pump back in the rear cargo compartment.

Battery

The battery is located in the engine compartment on the right-hand side.

Warning!



Failure to follow these instructions can result in severe injury or death.

Never lean over batteries while connecting, you might get injured.

Battery fluid contains sulfuric acid. Do not allow this fluid to come in contact with eyes, skin or clothing. In case it does, immediately flush affected area with water and seek medical help if necessary.

A battery will also produce hydrogen gas, which is flammable and explosive. Keep flames or sparks away from battery, avoid improper connection of jumper cables, smoking etc.



Never loosen or detach battery terminal clamps while the engine is running or the key is in the steering lock. Otherwise the alternator and other electronic components could be severely damaged.

Have the battery checked regularly by an authorized Mercedes-Benz Light Truck Center.

Refer to Service Booklet for maintenance intervals or contact your authorized Mercedes-Benz Light Truck Center for further information.

Warning!



Do not place metal objects on the battery as this could result in a short circuit.

Use leak-proof battery only to avoid the risk of acid burns in the event of an accident.

Warning!



With a disconnected battery

- you will no longer be able to turn the key in the steering lock
- the selector lever will remain locked in position **P**

Disconnecting the battery

- ▶ Turn off all electrical consumers.
- ▶ Open the hood (▷ page 202).
- ▶ Disconnect the battery negative lead.
- ▶ Remove the cover from the positive terminal.
- ▶ Disconnect the battery positive lead.

Battery

Removing the batteries

- ▶ Remove the screw securing the battery.
- ▶ Remove the battery support and bracket. Take out the battery.

Charging and reinstalling batteries

- ▶ Charge battery in accordance with the instructions of the battery charger manufacturer.
- ▶ Reinstall the charged battery. Follow the previously described steps in reverse order.

Warning!



Never charge a battery while still installed in the vehicle. Gases may escape during charging and cause explosions that may result in paint damage, corrosion or personal injury.

Reconnecting the batteries

- ▶ Turn off all electrical consumers.
- ▶ Connect the positive lead and fasten its cover.
- ▶ Connect the negative lead.



Never invert the terminal connections!



The battery, its filler caps and the vent tube must always be securely installed when the vehicle is in operation.



The following procedures must be carried out following any interruption of battery power (e.g. due to reconnection):

- Set the clock (▷ page 112).
- Set the date in trip computer (▷ page 172).
- Calibrate the compass (▷ page 174).
- Resynchronize the ESP (▷ page 225).
- Resynchronize side windows (▷ page 136).
- Resynchronize sliding/pop-up roof* (▷ page 138).

Batteries contain materials that can harm the environment if disposed of improperly. Large 12-volt storage batteries contain lead. Recycling of batteries is the preferred method of disposal. Many states require sellers of batteries to accept old batteries for recycling.

Jump starting

Jump starting

Warning!



Failure to follow these directions will cause damage to the electronic components, and can lead to a battery explosion and severe injury or death.

Never lean over batteries while connecting or jump starting, you might get injured.

Battery fluid contains sulfuric acid. Do not allow this fluid to come in contact with eyes, skin or clothing. In case it does, immediately flush affected area with water, and seek medical help if necessary.

A battery will also produce hydrogen gas, which is flammable and very explosive. Keep flames or sparks away from battery, avoid improper connection of jumper cables, smoking etc.

Attempting to jump start a frozen battery can result in it exploding, causing personal injury.

Read all instructions before proceeding.

If the battery is discharged, the engine can be started with jumper cables and the battery of another vehicle. Observe the following:

- Jump starting should only be performed when the engine and catalytic converter are cold.
- Do not start the engine if the battery is frozen. Let the battery thaw out first.
- Only jump start from batteries with the same voltage rating (12V). Jump starting with a more powerful battery could damage the vehicle's electrical system, which will not be covered by the Mercedes-Benz Limited Warranty.
- Use only jumper cables with sufficient cross-section, insulated terminal clamps and polarity reversal protection.



Jumper cables with polarity reversal protection are available at any authorized Mercedes-Benz Light Truck Center.



Jump starting may only be performed on the battery installed in the engine compartment.

Avoid repeated and lengthy starting attempts.

Do not attempt to start the engine using a battery quick charge unit.

If engine does not run after several unsuccessful starting attempts, have it checked at the nearest authorized Mercedes-Benz Light Truck Center.

Excessive unburned fuel generated by repeated failed starting attempts may damage the catalytic converter.

Make sure the jumper cables do not have loose or missing insulation.

Make sure the cable clamps do not touch any other metal part while the other end is still attached to a battery.

Warning!



Keep flames or sparks away from battery. Do not smoke.

Observe all safety instructions and precautions when handling automotive batteries (▷ page 261).

The battery is located in the engine compartment.

- ▶ Make sure that the two vehicles do not touch.
- ▶ Turn off all electrical consumers.
- ▶ Apply parking brake.
- ▶ Shift selector lever to position **P**.

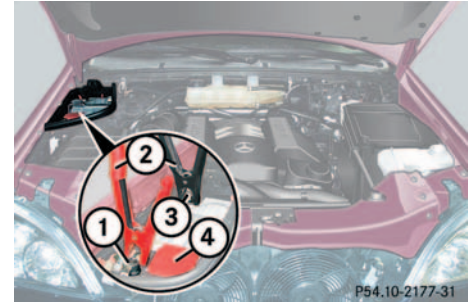

- 1** Positive terminal
- 2** Cable clamps
- 3** Negative terminal
- 4** Cover

- ▶ Remove cover **4** from positive terminal on both vehicles.
- ▶ Connect positive terminals **1** on the batteries with the jumper cables. Start with the charged battery.

Jump starting

- ▶ Let the engine of the assisting vehicle run at idle speed.
- ▶ Connect the negative terminals **3** of the batteries with the jumper cables. Start with the charged battery.
- ▶ Start the engine of the disabled vehicle.

Now you can again turn on the electrical consumers. Do not turn on the lights under any circumstances.

- ▶ Remove the jumper cables first from the negative terminals **3** of the batteries and then from the positive terminals **1**.
- ▶ Have the battery checked at the nearest authorized Mercedes-Benz Center.



The vehicle cannot be started via tow-start.

Towing the vehicle

Mercedes-Benz recommends that the vehicle be transported with all wheels off the ground using flatbed or appropriate wheel lift/dolly equipment. This method is preferable to other types of towing.



Use flatbed or wheel lift/dolly equipment, with key in steering lock turned to position **0**.

Do not tow with sling-type equipment. Towing with sling-type equipment over bumpy roads will damage radiator and supports.

To prevent damage during transport, do not tie down vehicle by its chassis or suspension parts. Use the towing eyes.

Switch off the ESP (▷ page 76), tow-away alarm (▷ page 80) and the automatic central locking (▷ page 89).

When circumstances do not permit the recommended towing methods, the vehicle may be towed with all wheels on the ground only so far as necessary to have the vehicle moved to a safe location where the recommended towing methods can be employed.



When towing the vehicle with all wheels on the ground, the selector lever must be in position **N** and the key must be in steering lock position **2**.

When towing the vehicle with all wheels on the ground, the vehicle may be towed only for distances up to 30 miles (50 km) and at a speed not to exceed 30 mph (50 km/h).

If the vehicle is towed with the front axle raised (observe instructions regarding flexible drive shaft), the engine must be shut off (key in steering lock position **1**). Otherwise, the 4-ETS may become engaged which may cause loss of towing control.



To be certain to avoid additional damage to the vehicle powertrain, however you should observe the following:

- With damage to the front axle
 - raise front axle
 - remove flexible drive shaft between rear axle and transfer case
- With damage to the rear axle
 - raise rear axle
 - tow vehicle with wheel lift or dolly placed under front wheels
- With damage to the transfer case
 - remove flexible drive shaft to the drive axles

Always install new self-locking nuts when reinstalling flexible drive shaft.

Towing the vehicle

Warning!



If circumstances require towing the vehicle with all wheels on the ground, always tow with a tow bar if:

- the engine will not run
- there is a malfunction in the power supply or in the vehicle's electrical system

Prior to towing the vehicle with all wheels on the ground, make certain that the key is in steering lock position **2**.

If the key is left in steering lock position **0** for an extended period of time, it can no longer be turned in the switch. In this case, the steering is locked. To unlock, remove key from steering lock and reinsert.

Warning!



With the engine not running, there is no power assistance for the braking and steering systems. In this case, it is important to keep in mind that a considerably higher degree of effort is necessary to brake and steer the vehicle. Adapt your driving accordingly.



To signal turns while being towed with hazard warning flasher in use, turn key in steering lock to position **2** and activate combination switch for left or right turn signal in usual manner – only the selected turn signal will operate.

Upon canceling the turn signal, the hazard warning flasher will operate again.



The vehicle cannot be started via tow-start.



When towing the vehicle with all wheels on the ground, note the following:

With the automatic central locking activated and the key in steering lock position **2**, the vehicle doors lock if the left front wheel is turning at vehicle speeds of approx. 9 mph (15 km/h) or more.

To prevent the vehicle doors from locking, deactivate the automatic central locking (▷ page 89).

Towing of the vehicle should only be done using the towing eye. Never attach tow cable, tow rope or tow rod to vehicle chassis, frame or suspension parts.

i

The selector lever will remain locked in position **P** and the key will not turn in the steering lock if the battery is disconnected or discharged. See notes on the battery (▷ page 261) or on jump starting (▷ page 264).

Manual unlocking of transmission selector lever (▷ page 245)

Front towing eye

The front towing eye is located on the passenger side below the bumper.

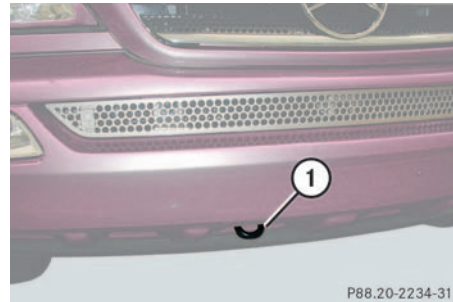

1 Towing eye

Rear towing eye

Warning!



In order to avoid possible serious burns or injury, use extreme caution when removing the cover, because the rear exhaust pipe is extremely hot.

The rear towing eye is located behind the right side cover in the bumper panel.

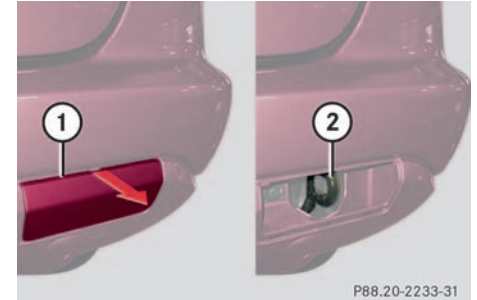

ML 320, ML 350, ML 500

- 1 Cover
- 2 Towing eye

To remove cover:

- ▶ Pry out the cover **1** using a flat blade screwdriver (▷ page 237).

To reinstall cover:

- ▶ Engage cover at bottom and press in top securely.

Towing the vehicle

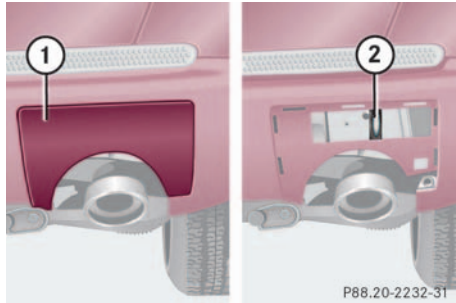

ML 55 AMG and vehicles with sport package*

- 1 Cover
- 2 Towing eye

To remove cover:

- ▶ Grip cover at bottom and securely pull out.

To reinstall cover:

- ▶ Engage cover and press in securely.

Stranded vehicle

Freeing a stranded vehicle, on which the wheels are dug into sand or mud, should be done with the greatest of care, especially if the vehicle is heavily loaded.

Avoid pulling the vehicle jerkily or diagonally, since it could result in damage to the chassis alignment.

Never try to free a vehicle that is still coupled to a trailer.

If possible, a vehicle equipped with trailer hitch receiver should be pulled backward in its own previously made tracks.

Fuses



Only install fuses that have been tested and approved by Mercedes-Benz and that have the specified amperage rating.

Never attempt to repair or bridge a blown fuse. Have the cause determined and remedied by an authorized Mercedes-Benz Light Truck Center.

The fuse chart is printed on the corresponding fuse box cover. The amperages of the fuses are also indicated there.

Fuse box in engine compartment

The fuse box is located in the engine compartment on the left-hand side.

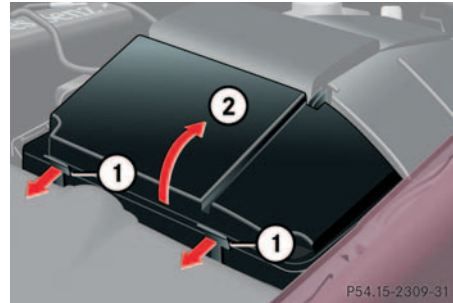

- 1 Clamps
- 2 Fuse box cover

Removing/installing cover

- ▶ Release clamps 1
- ▶ Lift fuse box cover 2 up.
- ▶ Install cover 1 in reverse order.



- 3 Fuse chart
- 4 Fuse extractor
- 5 Spare fuses

Fuses

Auxiliary fuse box in front passenger footwell

The auxiliary fuse box is located in the front passenger compartment.

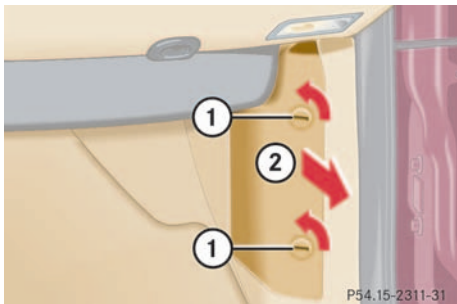

- 1 Lock
- 2 Cover

Removing/installing cover

- ▶ Turn both locks **1** 90° counterclockwise.
- ▶ Remove cover **2** in direction of arrow.
- ▶ Install cover **2** in reverse order.

Technical data

Spare parts service

Warranty coverage

Identification labels

Layout of poly-V-belt drive

Engine

Rims and tires

Electrical system

Main Dimensions

Weights

Fuels, coolants, lubricants etc.

Consumer information



Spare parts service

The “Technical data” section provides the necessary technical data for your vehicle.

Spare parts service

All authorized Mercedes-Benz Centers maintain a stock of original spare parts required for maintenance and repair work. In addition, strategically located parts distribution centers provide quick and reliable parts service.

More than 300 000 different spare parts for Mercedes-Benz models are available.

Mercedes-Benz original spare parts are subjected to stringent quality inspections. Each part has been specifically developed, manufactured or selected for and adapted to Mercedes-Benz vehicles.

Therefore, Mercedes-Benz original spare parts should be installed.



The use of non-genuine parts and accessories not authorized by Mercedes-Benz could damage the vehicle, which is not covered by the Mercedes-Benz Limited Warranty, or could compromise the vehicle's durability or safety.

Warranty coverage

Your vehicle is covered under the terms of the “warranties” printed in the Service and Warranty Information booklet. Your authorized Mercedes-Benz Light Truck Center will exchange or repair any defective parts originally installed on the vehicle in accordance with the terms of the following warranties:

- New Vehicle Limited Warranty
- Emission System Warranty
- Emission Performance Warranty
- California, Maine, Massachusetts, and Vermont Emission Control Systems Warranty

Replacement parts and accessories are covered by the Mercedes-Benz Spare Parts and Accessories warranties, copies of which are available at any Mercedes-Benz Center.

Loss of Service and Warranty Information Booklet

Should you lose your Service and Warranty Information booklet, have your authorized Mercedes-Benz Center arrange for a replacement. It will be mailed to you.

Identification labels

Identification labels

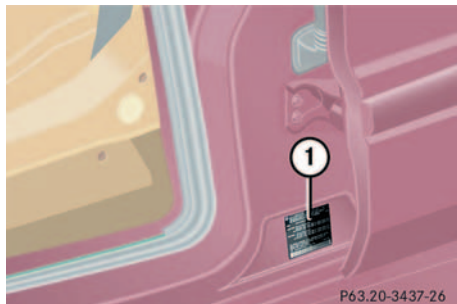

- 1** Certification label and Paintwork number

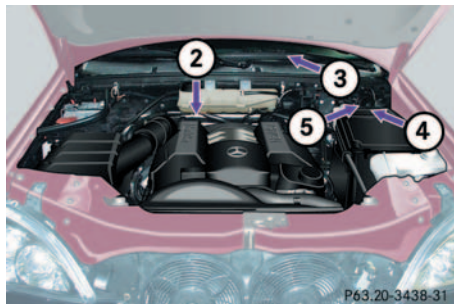

- 2** Engine number (engraved on engine)
3 VIN, visible (lower edge of windshield)
4 Emission control label
Vacuum line routing for emission control system
5 Information label, California version



When ordering spare parts, please specify vehicle identification and engine numbers.

Layout of poly-V-belt drive

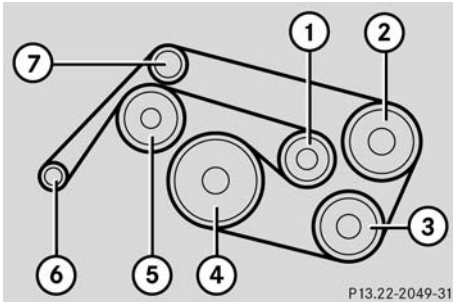

- 1 Automatic belt tensioner
- 2 Power steering pump
- 3 Air conditioning compressor
- 4 Crankshaft
- 5 Coolant pump
- 6 Generator/Alternator
- 7 Idler pulley

Engine

Engine

Model	ML 320 (163.154 ¹)	ML 350 (163.157 ¹)	ML 500 (163.175 ¹)	ML 55 AMG (163.174 ¹)
Engine	112	112	113	113
Mode of operation	4-stroke engine, gaso- line injection	4-stroke engine, gaso- line injection	4-stroke engine, gaso- line injection	4-stroke engine, gasoline injection
No. of cylinders	6	6	8	8
Bore	3.54 in (89.90 mm)	3.81 in (97.00 mm)	3.81 in (97.00 mm)	3.81 in (97.00 mm)
Stroke	3.31 in (84.00 mm)	3.31 in (84.00 mm)	3.31 in (84.00 mm)	3.62 in (92.00 mm)
Total piston displacement	195 cu.in. (3199 cm ³)	227 cu.in. (3724 cm ³)	303 cu.in. (4966 cm ³)	332 cu.in. (5439 cm ³)
Compression ratio	10:1	10:1	10:1	10.5:1
Output acc. to SAE J 1349	215 hp / 5600 rpm (160 kW / 5600 rpm)	241 hp / 5600 rpm (180 kW / 5600 rpm)	288 hp / 5600 rpm (215 kW / 5600 rpm)	342 hp / 5500 rpm (255 kW / 5500 rpm)
Maximum torque acc. to SAE J 1349	233 ft.lb / 3000 rpm (315 Nm / 3000 rpm)	259 ft.lb / 3000 rpm (350 Nm / 3000 rpm)	325 ft.lb / 2700 rpm (440 Nm / 2700 rpm)	376 ft.lb / 2800 rpm (510 Nm / 2800 rpm)
Maximum engine speed	6000 rpm	6000 rpm	6000 rpm	6000 rpm
Firing order	1-4-3-6-2-5	1-4-3-6-2-5	1-5-4-2-6-3-7-8	1-5-4-2-6-3-7-8
Poly-V-belt	7 ft 10 in (2390 mm)	7 ft 10 in (2390 mm)	7 ft 10 in (2390 mm)	7 ft 10 in (2390 mm)

¹ The quoted data apply only to the standard vehicle. See an authorized Mercedes-Benz Center for the corresponding data of all special bodies and special equipment.

Rims and tires

Use only tires and rims which have been specifically developed for your vehicle and tested and approved by Mercedes-Benz. Other tires and rims can have detrimental effects, such as

- poor handling characteristics
- increased noise
- increased fuel consumption



Moreover, tires and rims not approved by Mercedes-Benz may, under load, exhibit dimensional variations and different tire deformation characteristics under load that could cause them to come into contact with the vehicle body or axle parts. Damage to the tires or the vehicle may be the result.



Further information on tires and rims is available at any authorized Mercedes-Benz Light Truck Center. A tire inflation pressure table is located on the fuel filler cap of the vehicle. The tire pressure should be checked regularly and should only be adjusted on cold tires. Follow tire manufacturer's maintenance recommendation included with vehicle.

Rims and tires

Model	ML 320, ML 350	ML 500	ML 55 AMG
Rims (light alloy)	8 J x 17 H2 ET 52	8 ½ J x 17 H2 ET 52	9 J x 18 H2 ET 52
Wheel offset	2.0 in (52 mm)	2.0 in (52 mm)	2.0 in (52 mm)
All season tires (radial-ply-tires)	255/60 R17 106 H	275/55 R17 109 V	285/50 R18 109 W ¹
Rims* (light alloy)	8 ½ J x 17 H2 ET 47	8 ½ J x 17 H2 ET 47	-
Wheel offset*	1.85 in (47 mm)	1.85 in (47 mm)	-
All season tires (radial-ply-tires)*	275/55 R17 109 V	275/55 R17 109 V	-

¹ Must not be used with snow chains.

Rims and tires

Rims and winter tires*

Model	ML 55 AMG
Rims (light alloy)	8 ½ J x 17 H2 ET 52
Wheel offset	2.0 in (52 mm)
All season tires (radial-ply-tires)	275/55 R17 109 H

Spare wheel

Model	ML 320, ML 350, ML 500, ML 55 AMG
Rim	4Jx18 H 2 ET0
Wheel offset	0 in (0 mm)
Space-saver tire	T155/90 D18 113M ¹

¹ Must not be used with snow chains.

Electrical system

Model	ML 320, ML 350	ML 500	ML 55 AMG
Generator (alternator)	14 V/120 A	14 V/150 A	14 V/150 A
Starter motor	12 V/1.7 kW	12 V/1.7 kW	12 V/1.7 kW
Battery	12 V/100 Ah	12 V/100 Ah	12 V/100 Ah
Spark plugs	Bosch F 8 DPP332 Bosch F 8 DPER	Bosch F 8 DPP332 Bosch F 8 DPER	NGK PFR 5-11
Electrode gap	0.039 in (1.0 mm)	0.039 in (1.0 mm)	0.039 in (1.0 mm)
Tightening torque	15 – 22 ft.lb (20 – 30 Nm)	15 – 22 ft.lb (20 – 30 Nm)	15 – 22 ft.lb (20 – 30 Nm)

Main Dimensions

Main Dimensions

Model	ML 320, ML 350, ML 500	ML 55 AMG
Overall vehicle length	182.6 in (4638 mm)	182.5 in (4635 mm)
Overall vehicle width	83.7 in (2126 mm)	83.7 in (2126 mm)
Overall vehicle height	71.7 in (1820 mm)	71.0 in (1804 mm)
Wheelbase	111.0 in (2820 mm)	111.0 in (2820 mm)
Track, front	61.2 in (1555 mm)	61.2 in (1555 mm)
Track, rear	61.2 in (1555 mm)	61.2 in (1555 mm)
Ground clearance	8.03 in (204 mm)	7.4 in (188 mm)
Turning radius	468.5 in (11.9 m)	468.5 in (11.9 m)

Weights

Roof load max.	220 lb (100 kg)
----------------	-----------------

Fuels, coolants, lubricants etc.

Fuels, coolants, lubricants etc.

Capacities

Vehicle components and their respective lubricants must match.

Therefore use only brand tested and recommended by us.

Please refer to the Factory Approved Service Products pamphlet, or inquire at your Mercedes-Benz Light Truck Center.

	Model	Capacity	Fuels, coolants, lubricants etc.
Engine with oil filter	ML 320, ML 350, ML 500	8.5 US qt (8.0 l)	Recommended engine oils
	ML 55 AMG	8.0 US qt (7.5 l)	Recommended engine oils
Automatic transmission		9.0 US qt (8.5 l)	MB Automatic Transmission Oil ¹
Transfer case		1.6 US qt (1.5 l)	(Dexron 3 or Dexron 2E)
Rear axle		1.3 US qt (1.25 l)	(Hypoid gear oil SAE 90, 85 W 90)
Front axle		1.2 US qt (1.1 l)	(Hypoid gear oil SAE 90)
Power steering		approx. 0.65 US qt (0.6 l)	MB Power Steering Fluid
Front wheel hubs		approx. 1.5 oz (43 g) each	High temperature roller bearing grease
Brake system		0.75 US qt (0.7 l)	MB Brake Fluid (DOT 4+)

¹ MB part no. 001 989 21 03 10

Fuels, coolants, lubricants etc.

	Model	Capacity	Fuels, coolants, lubricants etc.
Cooling system		approx. 12.7 US qt (12.0 l)	MB Anticorrosion / Antifreeze
Fuel tank	ML 320, ML 350, ML 500	22.0 US gal (83.0 l)	Premium unleaded gasoline: Posted Octane 91 (Avg. of 96 RON/86 MON)
	ML 55 AMG	25.0 US gal (95.0 l)	Premium unleaded gasoline: Posted Octane 91 (Avg. of 96 RON/86 MON)
including a reserve of		approx. 3.2 US qt (12.0 l)	
Air conditioning system			R-134a refrigerant and special PAG lubricant oil (never R-12)
Windshield washer and headlamp cleaning system		8.0 US qt (7.6 l)	MB Windshield Washer Concentrate ¹

¹ Use MB Windshield Washer Concentrate “S” and water for temperatures above freezing or MB Windshield Washer Concentrate “S” and commercially available pre-mixed windshield washer solvent / antifreeze for temperatures below freezing. Follow suggested mixing ratios (▷ page 290).

Fuels, coolants, lubricants etc.

Engine oils

Engine oils are specifically tested for their suitability in our engines. Therefore, use only engine oils recommended by Mercedes-Benz. Information on recommended brands is available in the Factory Approved Service Products pamphlet, or at your authorized Mercedes-Benz Light Truck Center.

Engine oil additives

Do not blend oil additives with engine oil. They may be harmful to the engine operation.

Damage or malfunctions resulting from blending oil additives are not covered by the Mercedes-Benz Limited Warranty.

Air conditioning refrigerant

R-134a (HFC) refrigerant and special PAG lubricating oil is used in the air conditioning system.

Never use R-12 (CFC) or mineral-based lubricating oil, otherwise damage to the system will occur.

Brake fluid

During vehicle operation, the boiling point of the brake fluid is continuously reduced through the absorption of moisture from the atmosphere. Under extremely strenuous operating conditions, this moisture content can lead to the formation of bubbles in the system, thus reducing the system's efficiency.

Therefore, the brake fluid must be replaced every two years, preferably in the spring.

Only brake fluid approved by Mercedes-Benz is recommended. Your authorized Mercedes-Benz Center will provide you with additional information.

Premium unleaded gasoline



To maintain the engine's durability and performance, premium unleaded gasoline must be used. If premium unleaded is not available and low octane fuel is used, follow these precautions:

- Have the fuel tank only partially filled with unleaded regular and fill up with premium unleaded as soon as possible.
- Avoid full throttle driving and abrupt acceleration.
- Do not exceed an engine speed of 3000 rpm if the vehicle is loaded with a light load such as two persons and no luggage.
- Do not exceed 2/3 of maximum accelerator pedal position if the vehicle is fully loaded or operating in mountainous terrain.

Fuel requirements

Use only premium unleaded meeting ASTM standard D 439:

- The octane number (posted at the pump) must be 91 min. It is an average of both the Research (R) octane number and the Motor (M) octane number: $(R+M) / 2$. This is also known as the ANTI-KNOCK INDEX.

Unleaded gasoline containing oxygenates such as ethanol, IPA, IBA and TBA can be used provided the ratio of any one of these oxygenates to gasoline does not exceed 10%; MTBE not to exceed 15%.

The ratio of methanol to gasoline must not exceed 3% plus additional cosolvents.

Using mixtures of ethanol and methanol is not allowed. Gasohol, which contains 10% ethanol and 90% unleaded gasoline, can be used.

These blends must also meet all other fuel requirements, such as resistance to spark knock, boiling range, vapor pressure etc.

Gasoline additives

A major concern among engine manufacturers is carbon build-up caused by gasoline. Mercedes-Benz recommends only the use of quality gasoline containing additives that prevent the build up of carbon deposits.

After an extended period of using fuels without such additives, carbon deposits can build up especially on the intake valves and in the combustion area, leading to engine performance problems such as:

- Warm-up hesitation
- Unstable idle
- Knocking/pinging
- Misfire
- Power loss

Do not blend other specific fuel additives with fuel. This only results in unnecessary costs and may be harmful to the engine operation.

Damage or malfunctions resulting from poor fuel quality or from blending specific fuel additives are not covered by the Mercedes-Benz Limited Warranty.

Coolants

The engine coolant is a mixture of water and anticorrosion / antifreeze, which provides:

- Corrosion protection
- Freeze protection
- Boiling protection (by increasing the boiling point)

The cooling system was filled at the factory with a coolant providing freeze protection to approximately -35°F (-37°C) and corrosion protection.

If the antifreeze mixture is effective to -22°F (-30°C), the boiling point of the coolant in the pressurized cooling system is reached at approximately 266°F (130°C).

Fuels, coolants, lubricants etc.

The coolant solution must be used year round to provide the necessary corrosion protection and increase in boil-over protection. You should have it replaced every 3 years.

To provide important corrosion protection, the solution must be at least 45% anticorrosion/antifreeze (equivalent to freeze protection to approx. - 22°F [-30°C]). If you use a solution that is more than 55% anticorrosion/antifreeze (freeze protection to approx. - 49°F [-45°C]), the engine temperature will increase due to the lower heat transfer capability of the solution. Therefore, do not use more than this amount of anticorrosion/antifreeze.

If the coolant level is low, water and MB anticorrosion /antifreeze should be used to bring it up to the proper level (have cooling system checked for signs of leakage). Please make sure that the mixture is in accordance with label instructions.

The water in the cooling system must meet minimum requirements, which are usually satisfied by normal drinking water. If you are not sure about the water quality, consult your authorized Mercedes-Benz Light Truck Center.

Anticorrosion/antifreeze

Your vehicle contains a number of aluminum parts. The use of aluminum components in motor vehicle engines necessitates that anticorrosion/antifreeze coolant used in such engines be specifically formulated to protect the aluminum parts. (Failure to use such anticorrosion/antifreeze coolant will result in a significantly shortened service life.)

Therefore, the following product is strongly recommended for use in your vehicle: Mercedes-Benz Anticorrosion/Antifreeze agent.

Before the start of the winter season (or once a year in hot southern regions), you should have the anticorrosion/antifreeze concentration checked. The coolant is also regularly checked each time you bring your vehicle to your authorized Mercedes-Benz Light Truck Center for service.

Anticorrosion/antifreeze quantity

Model	Approx. freeze protection	
	- 35°F (- 37°C)	- 49°F (- 45°C)
ML 320, ML 350, ML 500, ML 55 AMG	6.4 US qt (6.0 l)	7.0 US qt (6.6 l)

Fuels, coolants, lubricants etc.

Windshield and headlamp washer system

Both the windshield and headlamp washer systems are supplied from the windshield washer fluid reservoir.

The windshield and headlamp washer fluid reservoir has a capacity of approx. 8.0 US qt. (7.6 l).

- ▶ Refill the reservoir with MB Windshield Washer Concentrate and water (or concentrate and commercially available premixed windshield washer solvent / antifreeze, depending on ambient temperatures).

Warning!



Washer solvent/antifreeze is highly flammable. Do not spill washer solvent/antifreeze on hot engine parts, because it may burn. You can be seriously burned.

Windshield and headlamp washer fluid mixing ratio

For temperatures above freezing use MB Windshield Washer Concentrate “S” and water:

- 1 part “S” to 100 parts water
(40 ml “S” to 4 l water)

For temperatures below freezing, use MB Windshield Washer Concentrate “S” and commercially available premixed windshield washer solvent / antifreeze:

- 1 part “S” to 100 parts solvent
(40 ml “S” to 4 l solvent).

Consumer information

This has been prepared as required of all manufacturers of passenger cars under Title 49, Code of U.S. Federal Regulations, Part 575 pursuant to the “National Traffic and Motor Vehicle Safety Act of 1966”.

Uniform tire quality grading

Quality grades can be found, where applicable, on the tire sidewall between tread shoulder and maximum section width. For example:

Tread wear	Traction	Temperature
200	AA	A

All passenger car tires must conform to federal safety requirements in addition to these grades.

Tread wear

The tread wear grade is a comparative rating based on the wear rate of the tire when tested under controlled conditions on a specified government test course. For example, a tire graded 150 would wear one and one-half (1½) times as well on the government course as a tire graded 100. The relative performance of tires depends upon the actual conditions of their use, however, and may depart significantly from the norm due to variations in driving habits, service practices and differences in road characteristics and climate.

Traction

The traction grades, from highest to lowest are AA, A, B, and C. Those grades represent the tire’s ability to stop on wet pavement as measured under controlled conditions on specified government test surfaces of asphalt and concrete. A tire marked C may have poor traction performance.

Warning!



The traction grade assigned to this tire is based on straightahead braking traction tests, and does not include acceleration, cornering, hydroplaning, or peak traction characteristics.

Consumer information

Temperature

The temperature grades are A (the highest), B, and C, representing the tire's resistance to the generation of heat and its ability to dissipate heat when tested under controlled conditions on a specified indoor laboratory test wheel. Sustained high temperature can cause the material of the tire to degenerate and reduce tire life, and excessive temperature can lead to sudden tire failure. The grade C corresponds to a level of performance which all passenger car tires must meet under the Federal Motor Vehicle Safety Standard No. 109. Grades B and A represent higher levels of performance on the laboratory test wheel than the minimum required by law.

Warning!



The temperature grade for this tire is established for a tire that is properly inflated and not overloaded. Excessive speed, underinflation, or excessive loading, either separately or in combination, can cause excessive heat build-up and possible tire failure.

ABS

(Antilock Brake System)

Prevents the wheels from locking up during braking so that the vehicle can continue to be steered.

BabySmart™ airbag deactivation system

This system detects if a special system compatible child restraint seat is installed on the front passenger seat. The system will automatically deactivate the passenger front airbag when such a seat is properly installed (indicator lamp  in the instrument cluster lights up). See your authorized Mercedes-Benz Light Truck Center for availability.

BabySmart™ compatible child seats

Special restraint system for children. The sensor system for the passenger seat prevents deployment of the passenger front airbag if a BabySmart™ compatible child seat is installed.

BAS

(Brake Assist System)

System for potentially reducing braking distances in emergency braking situations. The system is activated when it senses an emergency based on how fast the brake is applied.

Bi-Xenon headlamps*

Headlamps which use an electric arc as the light source and produce a more intense light than filament headlamps. Bi-Xenon headlamps produce low beam and high beam.

CAC

(Customer Assistance Center)

Mercedes-Benz customer service center, which can help you with any questions about your vehicle and provide assistance in the event of a breakdown.

CAN system

(Controller Area Network)

Data bus network serving to control vehicle functions such as door locking or windshield wiping.

Cockpit

All instruments, switches, buttons and indicator/warning lamps in the passenger compartment needed for vehicle operation and monitoring.

Cruise control

Driving convenience system for automatically maintaining the vehicle speed set by the driver.

Engine number

The number set by the manufacturer and placed on the cylinder block to uniquely identify each engine produced.

Engine oil viscosity

Measurement for the inner friction (viscosity) of the oil at different temperatures. The higher the temperature an oil can tolerate without becoming thin, or the lower the temperature it can tolerate without becoming viscous, the better the viscosity.

ESP

(Electronic Stability Program)

Improves vehicle handling and directional stability.

ETD

(Emergency Tensioning Device)

Device which deploys in certain frontal and rear collisions exceeding the system's threshold to tighten the seat belts.

->SRS

FSS

(Flexible Service System)

Service indicator in the speedometer display that informs the driver when the next vehicle maintenance service is due.

Gear range

Number of gears which are available to the automatic transmission for shifting. The automatic gear shifting process can be adapted to specific operating conditions using the selector lever.

GPS

(Global Positioning System)

Satellite-based system for relaying geographic location information to and from vehicles equipped with special receivers. Employs CD digital maps for navigation.

Instrument cluster

The displays and indicator/warning lamps in the driver's field of vision, including the tachometer, speedometer, engine temperature and fuel gauge.

Kickdown

Depressing the accelerator past the point of resistance shifts the transmission down to the lowest possible gear. This very quickly accelerates the vehicle and should not be used for normal acceleration needs.

Line of fall

The direct line that an object moves downhill when influenced by the force of gravity alone.

Lock button

Button on the door which indicates whether the door is locked or unlocked. Pushing the lock button down on an individual door from inside will lock that door.

MCS

(Modular Control System)

Information and operating center for vehicle sound and communications systems, including the radio and the radio and navigation system, as well as for other optional equipment (CD changer, telephone, etc.).

Memory function*

Used to store three individual seat, steering wheel and mirror positions.

MON

(Motor Octane Number)

The Motor Octane Number for gasoline as determined by a standardized method. It is an indication of a gasoline's ability to resist undesired detonation (knocking). The average of both the MON (Motor Octane Number) and ->RON (Research Octane Number) is posted at the pump, also known as ANTI-KNOCK INDEX.

Multifunction display

A display field in the instrument cluster used to present information provided by the control system.

Parktronic*

System which uses visual and acoustic signals to assist the driver during parking maneuvers.

Poly-V-belt drive

Drives engine-components (alternator, AC compressor, etc.) from the engine.

Power train

Collective term designating all components used to generate and transmit motive power to the drive axles, including

- engine
- clutch/torque converter
- transmission
- transfer case
- drive shaft
- differential
- axle shafts/axles

Remote Vehicle Diagnostics

Transmission of vehicle data and current location to the Mercedes-Benz Customer Assistance Center for subscribers to Tele Aid service.

REST

(Residual engine heat utilization)
Feature that uses the engine heat stored in the coolant to heat the vehicle interior for a short time after the engine has been turned off.

Restraint system

Seat belts, belt tensioner, airbags and child seat restraint systems. As independent systems, their protective functions complement one another.

RON

(Research Octane Number)

The Research Octane Number for gasoline as determined by a standardized method. It is an indication of a gasoline's ability to resist undesired detonation (knocking). The average of both the \rightarrow MON (Motor Octane Number) and RON (Research Octane Number) is posted at the pump, also known as ANTI-KNOCK INDEX.

Shift lock

When the vehicle is parked, this lock prevents the transmission selector lever from being moved out of position **P** without key turned and brake pedal depressed.

SRS

(Supplemental Restraint System)

Seat belts, emergency tensioning device and airbags. Though independent systems, they are closely interfaced to provide effective occupant protection.

Tele Aid System*

(Telematic Alarm Identification on Demand)

The Tele Aid system consists of three types of response: automatic and manual emergency, roadside assistance and information. Tele Aid is initially activated by completing a subscriber agreement and placing an acquaintance call.

The Tele Aid system is operational providing that the vehicle's battery is charged, properly connected, not damaged and cellular and GPS coverage is available.

Telematics*

A combination of the terms "telecommunications" and "informatics".

Tightening torque

Force times lever arm (e.g. a lug wrench) with which threaded fasteners such as wheel bolts are tightened.

Tire speed rating

Part of tire designation; indicates the speed range for which a tire is approved.

Traction

Force exerted by the vehicle on the road via the tires.

Transfer case

Speed of rotation/torque converter that works together with the \rightarrow automatic transmission. In the LOW mode off-road position, the transfer case decreases the output rotational speed of the \rightarrow automatic transmission by approximately half. This results in a corresponding increase of torque on the drive axles.

The vehicle then has nearly double the driving force but drives only approximately half as fast.

VIN

(Vehicle Identification Number)

The number set by the manufacturer and placed on the body to uniquely identify each vehicle produced.

Voice control system*

Voice control system for car phones, portable cell phones and audio systems (radio, CD, etc.).

- A**
- ABS 25, 71, 293
 - ABS control 71
 - LOW RANGE mode 72
 - Malfunction indicator lamp 225
 - Warning lamp 225
 - Accelerator position, automatic transmission 117
 - Accident
 - In case of 49
 - Activating
 - Air circulation mode 130
 - Air recirculation mode 129
 - Anti-theft alarm system 78
 - Automatic climate control 125
 - ESP 77
 - Exterior headlamps 46
 - Hazard warning flasher 106
 - Headlamps 46
 - High beams 102
 - Ignition 33
 - Immobilizer 51, 78
 - Rear passenger compartment
 - ventilation and climate control 131
 - Rear window defroster 131
 - Rear window wiper 48
 - Residual heat 130
 - Seat heater 91
 - Tow-away alarm 80
 - Warning indicators (Parktronic*) 151
 - Windshield wipers 48
 - Activating automatic central locking 89
 - Adding
 - Coolant 206
 - Engine oil 204, 205
 - Additional turn signals 247
 - Adjustable steering column
 - Indicator lamp 229
 - Adjusting 34
 - Backrest tilt 36, 37
 - Exterior rear view mirror 38
 - Head restraint height 36, 37
 - Head restraint tilt 36, 37
 - Headlamp aim 253
 - Instrument cluster illumination 110
 - Manual seat 35
 - Mirrors 38
 - Power seats 37
 - Seat cushion tilt 37
 - Seat fore and aft 35
 - Seat fore and aft adjustment 37
 - Seat height 35, 36
 - Seats 34
 - Steering wheel 37
 - Adjusting air distribution
 - Automatic climate control 127
 - Adjusting air volume
 - Automatic climate control 127
 - Air conditioner (cooling)
 - Turning on 129
 - Air conditioning
 - Cooling 129
 - Air conditioning refrigerant 286
 - Air outlets
 - Automatic climate control 132
 - Air pressure see Tire inflation pressure 211
 - Air pump 238
 - Air recirculation mode 128
 - Activating 129
 - Deactivating 129
 - AIRBAG OFF
 - Warning lamp 232
 - Airbags 55
 - BabySmart™ airbag deactivation system 293
 - BabySmart™ deactivation system 65
 - Children 56
 - Front 59

- Passenger 59
- Safety guidelines 57
- Side impact 59
- Window curtain 59
- Alarm
 - Audible 70, 79
 - Canceling 79
 - Visual 78
- Alarm system
 - Anti-theft 78
- Anticorrosion/antifreeze 288
- Antiglare
 - Automatic 119
- Antilock brake system (ABS) 293
- Anti-theft alarm system
 - Arming 78
 - Canceling alarm 79
 - Disarming 79
- Anti-theft systems
 - Anti-theft alarm system 78
 - Immobilizer 78
 - Tow-away alarm, glass breakage sensor 79
- Aquaplaning see Hydroplaning 183
- Armrest
 - Storage compartment in front of 153
 - Storage spaces 153
- Armrest in rear seat bench 155
- Ashtray
 - Front center console 156
 - Rear center console 157
- At the gas station 200
- ATF (automatic transmission fluid) 206
- Attaching a trailer 194
- Automatic antiglare for rear view mirror 119
- Automatic central locking
 - Activating 89
 - Deactivating 89
- Automatic climate control 124
 - Adjusting air distribution 127
 - Adjusting air volume 127
- Air conditioning 129
- Air outlets 132
- Air recirculation mode 128
- Basic setting 127
- Changing basic setting 127
- Defrosting 128
- Economy mode 125
- Rear passenger compartment 131
- Rear window defroster 131
- Residual heat utilization 130
- Residual ventilation 130
- Switching off 127
- Switching on 126
- Automatic headlamp mode 103
- Automatic interior lighting control
 - Activating 107
 - Deactivating 107
- Automatic locking when driving 89
- Automatic transmission 113
 - Accelerator position 117
 - Emergency operation (Limp Home Mode) 117
 - Gear ranges 114
 - Gear selector lever position 115
 - Gear shifting malfunctions 117
 - Kickdown 117
 - Manual shifting 113
 - One-touch gearshifting 113
 - Selector lever position 113
 - Towing a trailer 117
 - Transmission fluid 206

- B**
- BabySmart™
 - Airbag deactivation system 65
 - Compatible child seats 65, 293
 - Self-test 66
 - BabySmart™ airbag deactivation system 293
 - Backrest tilt 35
 - Backup lamps 248, 251
 - Bulbs 248
 - BAS 73, 293
 - Malfunction indicator lamp 225, 226
 - Warning lamp 225, 226
 - Batteries, remote control
 - Changing 243
 - Batteries, vehicle 207
 - Battery discharged
 - Jump starting 264
 - Battery indicator lamp
 - Indicator lamp 233
 - Battery, vehicle 207, 261
 - Charging 262
 - Disconnecting 261
 - Reconnecting 262
 - Reinstalling 262
 - Removing 262
 - Bi-Xenon headlamps* 293
 - Block heater 214
 - Blocking
 - Rear door window operation 69
 - Brake assist system (BAS) 293
 - Brake fluid 286
 - Brake lamp bulbs 248
 - Brake lamp, high mounted 248
 - Brake pad wear
 - Indicator lamp 234
 - Brakes 180
 - Warning lamp 228
 - Break-in period 178
 - Bulbs, replacing 247
 - Additional turn signals 247
 - Backup lamps 248
 - Brake lamps 248
 - Fog lamps 247
 - Front fog lamp 251
 - Front lamps 247
 - High beam 247
 - High mounted brake lamp 248, 252
 - License plate lamps 248, 252
 - Low beam 247
 - Parking lamps 247, 248, 250
 - Rear fog lamp 248
 - Rear fog lamps 251
 - Rear side marker lamp bulbs 251
 - Side marker lamps 247, 248, 250
 - Standing lamps 247, 248
 - Tail lamp assemblies 248, 251
 - Turn signal lamps 247, 248, 250
- C**
- CAC (Customer Assistance Center) 293
 - Calibrating compass 174
 - California
 - Important notice 11
 - Calling up
 - Service indicator 216
 - CAN system 293
 - Capacities
 - Fuels, coolants, lubricants, etc. 284
 - Cargo area cover blind* 143
 - Closing 143
 - Installing 143
 - Opening 143
 - Removing 143
 - Cargo area see Cargo compartment 85
 - Cargo compartment
 - Liftgate 85
 - Lighting 109
 - Tie-down rings 140

- Cargo floor plates 144
 - Installing 144
 - Removing 144
 - Storing 144
- Cargo tie-down rings 140
- Catalytic converter 198
- CD-changer* 238
- Center console 27
 - Lower part 28
 - Upper part 27
- Central locking
 - Automatic 89
 - From inside 89
 - Switch 90
 - Unlocking from inside 89, 90
- Central locking switch 90
- Certification label 276
- Charge indicator lamp 233
- Charging
 - Vehicle battery 262
- Chart
 - Fuses 271
- CHECK ENGINE malfunction indicator lamp 232
- Checking
 - Coolant level 201, 206
 - Oil level 201, 203
 - Tire inflate pressure 201
 - Vehicle lighting 201
- Checking weights
 - Trailer and vehicle 193
- Checklist
 - Off-road driving 187
 - Returning from off-road driving 191
- Child safety 63
 - Airbags 56
 - Infant and child restraint systems 54, 60, 63
 - LATCH child seat mounts 68
- Child safety switch see Blocking of rear door window operation 69
- Cigarette lighter
 - Front center console 156
- Cleaning
 - Cup holder 221
 - Gear selector lever 221
 - Hard plastic trim items 221
 - Headlamps 121
 - Headliner 221
 - Instrument cluster 221
 - Leather upholstery 222
 - Light alloy wheels 221
 - MB Tex upholstery 222
 - Plastic and rubber parts 222
 - Seat belts 221
 - Steering wheel 221
 - Windows 220
 - Windshield 48
 - Wiper blades 220
- Cleaning and care of the vehicle see Vehicle care 217
- Clock 26, 112
- Closing
 - Glove box 152
 - Hood 203
 - Liftgate 88
 - Rear quarter windows* 136
 - Side windows 135
 - Sliding/pop-up roof 246
 - Sliding/pop-up roof* 137
- Closing sliding/pop-up roof
 - In an emergency 246
- Cockpit 22, 293
- Combination switch 102
 - High beam flasher 47, 102
 - Turn signals 47
 - Windshield wipers 47

- Compass 173
 - Calibrating 174
 - Setting compass zone 174
- Compass zone 174
- Consumer information 291
- Control and operation of radio
 - transmitters 197
- Coolant 206, 287
 - Adding 206
 - Anticorrosion/antifreeze quantity 288
 - Checking level 206
 - Indicator lamp 230
 - Temperature 199
 - Temperature gauge 111
- Coolant level
 - Checking 201, 206
- Crossing obstacles 190
- Cruise control 146, 293
 - Canceling 147
 - Driving downhill 147
 - Driving uphill 147
 - Fine adjustment 148
 - LOW RANGE mode 148
 - Saving current speed 147
 - Setting speeds 148
- Cruise control lever 146
- Cup holder 154
 - Cleaning 221
 - In front seat armrest 155
 - In instrument panel 154
 - In rear centerconsole 155
- Customer Assistance Center (CAC) 293
- D**
- Daytime running lamp mode 103
- Deactivating
 - Air conditioning (cooling) 129
 - Air recirculation mode 129
 - Alarm 79
 - Anti-theft alarm system 79
 - Automatic climate control 125, 127
 - Cruise control 147
 - Defrost 128
 - Engine 51
 - ESP 76
 - Front fog lamps, rear fog lamp 105
 - Hazard warning flasher 106
 - Headlamps 51
 - Immobilizer 78
 - Rear passenger compartment
 - ventilation and climate control 131
- Rear window defroster 131
- Residual heat 130
- Seat heater 91
- Tow-away alarm 80
- Tow-away alarm (vehicles with trip
 - computer*) 80
- Tow-away alarm (vehicles without trip
 - computer) 81
- Deactivating automatic central locking 89
- Deep water see Standing water 185
- Defogging
 - Windshield 128
- Defrosting 128
- Difficulties
 - While driving see Problems while
 - driving 49
 - With starting 45
- Direction of rotation (tires) 210
- Discharged battery
 - Jump starting 264
- Disconnecting
 - Vehicle battery 261
- Display
 - Engine oil level 204
- Display in the speedometer 111

- Display messages
 - Error 235
 - Service indicator (FSS) 235
 - StArt 235
- Displays
 - Service indicator 215
- Distance remaining 175
- Door entry lamps 107
- Door unlock
 - With Tele Aid* 167
- Doors
 - Opening from inside vehicle 86
 - Opening from outside 85
- Downhill driving
 - Cruise control 147
- Downshifting 113
- Drink holder see Cup holder 155
- Drinking and driving 179
- Driving 40, 45
 - Abroad 197
 - General instructions 179
 - In winter 184
 - Problems 49
 - Safety systems 71
 - Through standing water 185
- Driving abroad 197
- Driving instructions 179
 - Towing a trailer 194
- Driving off 181
- Driving safety systems
 - 4-ETS 73
 - ABS 71
 - BAS 73
 - ESP 75
- Driving systems 146
 - Cruise control 146
 - Driving safety systems 71
 - EBP 74
 - Parktronic* 149
- Driving through water 189
- E**
- Easy entry/exit feature* 95
- EBP 74
 - Indicator lamp 229
- Economy mode
 - Automatic climate control 125
- Electric air pump 238
- Electrical connections
 - Trailer 192
- Electrical fuses 271
- Electrical outlet 158
- Electrical system
 - Technical data 281
- Electronic Brake Proportioning see EBP
- Electronic Stability Program see ESP 25, 75
- Electronic stability program see ESP 294
- Electronic Traction System see 4-ETS 25
- Emergency call system
 - Requirements 160
- Emergency call system* 160
- Emergency calls
 - Initiating an emergency call 163
 - With Tele Aid* 161
- Emergency operation (Limp Home Mode) 117
- Emergency operations
 - Closing sliding/pop-up roof 246
 - Locking the vehicle 243
 - Opening sliding/pop-up roof 246
 - Remote door unlock 167
 - Unlocking the vehicle 242
- Emergency tensioning device
 - see ETD 62, 294
- Emission control 198
- Emission control label 276

- Engine
 - Compartment 202
 - Starting 44
 - Technical data 278
 - Turning off 51
- Engine cleaning 219
- Engine compartment
 - Fuse box in 271
 - Hood 202
- Engine malfunction indicator lamp 25, 232
- Engine number 293
- Engine oil 203, 286
 - Adding 204, 205
 - Additives 286
 - Checking level 203
 - Consumption 203
 - Filler neck 205
 - Viscosity 294
- Engine oil level indicator 204
- Engine oil level see Oil level 201
- Enlarged cargo area 93
- Error
 - Display messages 235
- ESP 25, 75, 294
 - LOW RANGE mode 76
 - Malfunction indicator lamp 225, 226
- Switching off 76
- Switching on 77
- Warning lamp 224, 225, 226
- ETD 294
 - Safety guidelines 57
- ETD (Emergency Tensioning Device) 54
- ETD (Emergency tensioning device) 62
- Exterior mirrors
 - Folding 120
- Exterior rear view mirrors 38
 - Adjusting 38
- F**
- Fastening the seat belts 40
- Fine adjustment
 - Cruise control 148
- First aid kit 236
- Flat tire 255
 - Inflating the spare tire 259
 - Lowering the vehicle 258
 - Mounting the spare wheel 255
 - Preparing the vehicle 255
 - Spare wheel 239
- Flexible Service System (FSS) 215, 294
- Flexible service system (FSS) 25
- Fluid level
 - Automatic transmission 206
- Fog lamp, rear 248
- Fog lamps 105
 - Replacing bulbs 247
- Fog lamps, front
 - Replacing bulbs 248
 - Switching on 105
- Folding
 - Exterior mirrors 120
- 4-ETS 25, 73
 - Indicator lamp 226
 - LOW RANGE mode 74
 - Malfunction indicator lamp 226
 - Warning lamp 224
- Front airbags 59
- Front fog lamps
 - Indicator lamp 229
 - Switching off 106
- Front lamps
 - Replacing bulbs 247, 249
 - Switching on 102
- Front towing eyes 269
- FSS 25
- FSS (Flexible Service System) 215, 294
- Fuel 200
 - Additives 287
 - Fuel reserve warning lamp 233

- Gasoline additives 287
 - Premium unleaded gasoline 200, 286
 - Requirements 287
 - Reserve warning 25
- Fuel additives 287
- Fuel filler flap 200
 - Locking 200
 - Opening 244
 - Unlocking 200
- Fuel requirements 287
- Fuel tank
 - Filler flap 200
- Fuels, coolants, lubricants etc. 284
- Functions
 - Trip computer 172
- Fuse box 271, 272
- Fuse chart 271
- Fuses 271
 - Fuse box in engine compartment 271
 - Fuse box in passenger footwell 272
 - Fuse chart 271
 - Fuse extractor 271
 - Spare fuses 271

G

- Garage door opener 29, 168
 - Erasing in remote control 171
 - Integrated remote control 169
 - Rolling code programming 170
- Gasoline see Fuel 200
 - Gasoline additives 287
- Gauge for
 - Coolant temperature 25
 - Fuel 25
 - Outside temperature 25
- Gear range 294
 - Automatic transmission 114
 - Limiting 114
 - Shifting into optimal 114
- Gear range limit
 - Canceling 114
- Gear selector lever
 - Cleaning 221
 - Position 115
- Glass breakage sensor 79
- Global Positioning System (GPS) 294
- Glossary 293

- Glove box 23, 152

- Closing 152

- Opening 152

- Good visibility 119

- GPS 294

H

- Hand-held transmitter
 - Programming integrated remote control 169
- Hard plastic trim items
 - Cleaning 221
- Hazard warning flasher 106
 - Switching off 106
 - Switching on 106
- Head restraint
 - Installing 92
 - Removing 92
- Head restraints
 - Manual seats 36
 - Power seats* 37
- Headlamp aim
 - Adjusting 253
- Headlamp cleaning system* 208

- Headlamps
 - Automatic control 103
 - Bi-Xenon 293
 - Cleaning 220
 - Cleaning system 121
 - Cleaning system* 208
 - Refilling washer fluid 208
 - Switching off 51
 - Switching on 46
 - Washer fluid 290
 - Washer system 290
- Headliner
 - Cleaning 221
- Heated seats 91
- Height adjustment
 - Head restraints 36, 37
 - Seat belts 43
 - Steering wheel 37
- High beam flasher 47, 102
- High beam headlamps
 - Replacing bulbs 247, 250
 - Switching on 102
- High mounted brake lamp 248
 - Replacing bulbs 252
- Hood 202
 - Closing 203
 - Opening 202
- Hooks
 - Loading 140
- Hydroplaning 183
- I**
- Identification labels 276
 - Certification label 276
 - Vehicle identification number (VIN) 276
- Ignition 33
- Immobilizer 78
 - Activating 51, 78
 - Deactivating 78
- Indicator lamp
 - Adjustable steering column 229
 - Brake pad wear 234
 - Coolant 230
 - Front fog lamps 229
 - Low engine oil level 229
- Indicators, additional
 - Speedometer display 235
- Infant and child restraint systems 63
 - Installing 67
 - LATCH child seat mounts 68
- Inflating
 - Spare tire 259
- Information
 - About service and warranty 10
 - Button for Tele Aid* 165
- Inside rear view mirror
 - Antiglare 119
- Installing
 - Head restraint 92
 - Infant and child restraint systems 67
 - Wiper blades 254
- Instrument cluster 24, 110, 294
 - Cleaning 221
 - Coolant temperature gauge 111
 - Display in the speedometer 111
 - Illumination 110
 - Lamps in 233
 - Outside temperature indicator 112
- Instruments and controls see Cockpit 22
- Integrated remote control
 - Canadian programming 171
 - Erasing memory 171
 - Hand-held transmitter 169
 - Operating 171
 - Rolling code programming 170

- Interior lighting 107
 - Activating automatic control 107
 - Deactivating automatic control 107
 - Manual operation 108
 - Reading lamps 108
- Interior storage spaces 152
 - Armrest 153
 - Cup holder 155
 - Glove box 152
 - Storage compartment in front of armrest 153
 - Storage compartment under front passenger seat* 152
- Intermittent wiping 122
- J**
- Jack 237, 238
- Jump starting 264
- K**
- Key
 - Global locking 85
 - Global unlocking 85
 - Loss of 86
 - Positions in steering lock 33
 - Remote control with folding key 84
 - Unlocking liftgate 85
- Unlocking the driver's door, fuel filler flap 85
- Key positions in steering lock 33
- Key, Mechanical 242
- Key, Remote control
 - Unlocking with 32
- Kickdown 117, 294
- L**
- Labels, identification 276
- Lamp bulbs, exterior 247
- Lamps, exterior
 - Front 247
 - Rear 248
- Lamps, indicator and warning
 - 4-ETS 224, 226
 - ABS 225
 - Adjustable steering column 229
 - AIRBAG OFF 59, 232
 - BAS 73, 225, 226
 - Battery indicator lamp 233
 - Brake pad wear 234
 - Brakes 228
 - CHECK ENGINE 232
 - Coolant 230
 - EBP 229
- Engine diagnostics 232
- ESP 224, 225, 226
- Front fog lamps 229
- Fuel reserve 233
- Instrument cluster ??-233
- Low engine oil level 229
- LOW RANGE 226
- Low washer system fluid level 234
- Seat belts 234
- Service indicator 215
- SRS 54, 227
- Turn signals 25
- LATCH child seat anchors 68
- LATCH child seat mounts 68
- Layout of poly-V-belt drive 277
- Leather upholstery
 - Cleaning 222
- Lever
 - For cruise control 146
- License plate lamps
 - Replacing bulbs 248, 252
- Liftgate
 - Closing 88
 - Opening 85, 87
 - Opening from inside 87
 - Opening from outside 87

- Light alloy wheels
 - Cleaning 221
- Lighter
 - Rear center console 157
- Lighter see cigarette lighter 156
- Lighting 102
 - Automatic headlamp mode 103
 - Cargo compartment 109
 - Combination switch 102
 - Daytime running lamp mode 103
 - Door entry lamps 107
 - Front fog lamps 105
 - High beam flasher 102
 - High beams 102
 - Instrument cluster illumination 110
 - Interior 107
 - Locator lighting 105
 - Low beam 102
 - Night security illumination 104
 - Parking lamps 102
- Limiting the gear range 114
- Limp Home Mode 117
- Line of fall 294
- Loading 139
 - Cargo area cover blind* 143
 - Cargo floor plates 144
 - Cargo tie-down rings 140
 - Hooks 140
 - Instructions 139, 140
 - Partition net* 141
 - Roof rack 145
 - Split rear bench seat 93
 - Trailer 193
- Locator lighting 105
- Lock button 294
- Locking 84
 - Automatic while driving 89
 - Centrally from inside 90
 - Fuel filler flap 200
 - Global 85
 - Vehicle in an emergency 243
- Locking knobs 32
- Loss of keys 86
- Loss of Service and Warranty Information
 - Booklet 275
- Low beam headlamps
 - Replacing bulbs 247, 249
 - Switching on 46
- Low engine oil level
 - Indicator lamp 229
- LOW RANGE - 4-ETS 74
- LOW RANGE - ABS 72
- LOW RANGE - ESP 76
- LOW RANGE mode 118
- Low washer system fluid level
 - Indicator lamp 234
- Lowering
 - Vehicle 258
- M**
- Main dimensions 282
- Maintenance 12
 - Display messages 235
- Manual operations
 - Fuel filler flap 244
 - Interior lighting control 108
 - Locking the vehicle 243
 - Sliding/pop-up roof 246
 - Unlocking the driver's door 242
 - Unlocking transmission selector lever 245
- Manual seat
 - Adjusting 35
 - Adjusting backrest tilt 36
 - Adjusting head restraint height 36
 - Adjusting head restraint tilt 36
 - Seat fore and aft adjustment 35
 - Seat height 35

- MB Tex upholstery
 - Cleaning 222
 - MCS
 - Modular Control System 294
 - Mechanical key 242
 - Memory function 99, 295
 - Storing exterior rear view mirror parking positions 100
 - Memory function* 100
 - Recalling positions from memory 100
 - Mirror
 - Inside rear view mirror 38
 - Mirrors
 - Activating exterior mirror parking position 101
 - Adjusting 38
 - Automatic antiglare for rear view mirror 119
 - Exterior rear view mirror 38
 - Storing exterior rear view mirror parking position 101
 - MON 200
 - MON (Motor Octane Number) 295
 - Monitoring reach
 - Parktronic* 150
 - Multifunction display 295
- N**
- Night security illumination 104
 - Deactivation temporarily 104
 - Setting time 104
- O**
- Occupant safety 54
 - Children and airbags 56
 - Children in the vehicle 63
 - Fastening the seat belt 40
 - Infant and child restraint systems 63
 - LATCH child seat mounts 68
 - Seat belts 40, 57
 - Odometer display 111
 - Odometer, main 25
 - Off-road driving
 - Checklist 187, 191
 - Crossing obstacles 190
 - Driving instructions off-road driving 186
 - Driving through water 189
 - Returning 191
 - Rules 186
 - Special driving features 186
 - Steep terrain 187
- Oil**
- Adding 204, 205
 - Checking level 203
 - Consumption 203
 - Dipstick 203, 205
 - Filler neck 205
 - Viscosity 294
 - Oil dipstick 205
 - Oil level
 - Checking 201
 - One-touch gearshifting 113
 - Canceling gear range limit 114
 - Downshifting 113
 - Upshifting 114
 - Opening
 - Doors from the inside 86
 - Fuel filler flap 200
 - Fuel filler flap manually 244
 - Glove box 152
 - Hood 202
 - Liftgate 85, 87
 - Liftgate from inside 87
 - Liftgate from outside 87
 - Rear quarter windows 136
 - Side windows 135
 - Sliding/pop-up roof 246

- Sliding/pop-up roof in an emergency 246
 - Sliding/pop-up roof* 137
 - Storage compartment in front of armrest 154
 - Storage compartment under passenger seat 153
 - Windows 135
 - Opening and closing
 - Side windows 134
 - Operating
 - Garage door opener 171
 - Integrated remote control 171
 - Radio transmitters 197
 - Vehicle outside the USA and Canada 13
 - Operating safety 17
 - Operator's Manual 10
 - Ornamental moldings 220
 - Outside temperature indicator 112
 - Overdue service 215
 - Overhead control panel 29
- P**
- Paintwork 219
 - Panic alarm 70
 - Panic button on remote control 70
 - Parking 182
 - Trailer towing 196
 - Parking and locking 50
 - Parking brake 45, 50
 - Engaging 50
 - Releasing 45
 - Parking lamps
 - Replacing bulbs 247, 248, 250
 - Replacing the bulbs 250
 - Switching on 102
 - Parking position
 - Exterior rear view mirrors 100
 - Parktronic* 149, 295
 - Cleaning system sensor 220
 - Monitoring reach 150
 - Sensor cover 220
 - Switching off 151
 - Switching on 151
 - Warning indicators 150
 - Partition net
 - Engaging 141
 - Removing 142
 - Tightening 142
 - Partition net* 141
 - Parts see Spare parts service
 - Passenger compartment 196
 - Interior lighting 107
 - Passenger footwell
 - Fuse box in 272
 - Passenger safety see Occupant safety 54
 - Pedals 179
 - Plastic and rubber parts
 - Cleaning 222
 - Poly-V-belt drive 295
 - Layout 277
 - Positions (Memory function*)
 - Recalling from memory 100
 - Storing into memory 100
 - Power assistance 179
 - Power seat*
 - Adjusting backrest tilt 37
 - Adjusting head restraint height 37
 - Adjusting head restraint tilt 37
 - Adjusting seat cushion tilt 37
 - Adjusting seat height 36
 - Seat fore and aft adjustment 37
 - Power seats 37
 - Power train 295
 - Power washer 218

- Power windows
 - Blocking of rear door window operation 69
 - Side windows 134
 - Synchronizing 136
- Practical hints
 - First aid kit 236
 - Fuses 271
 - Lamps in instrument cluster 224
 - Spare wheel 239
 - Towing the vehicle 267
 - Vehicle jack 238
 - Vehicle tool kit 237
- Premium unleaded gasoline 286
- Problems
 - While driving 49
 - With vehicle 18
- Product information 9
- R**
- Radio transmitters, control and operation 197
- Rain sensor 122, 123
- Rapid seat heating
 - Switching off 91
 - Switching on 91
- Reading lamp 29
- Reading lamps 108
- Rear automatic climate control 131
 - Adjusting air volume and air distribution manually 132
 - Automatic mode 132
- Rear bench seat
 - Foldable 93
- Rear door window
 - Blocking operation 69
- Rear fog lamp 248
 - Bulb 248
 - Switching off 106
 - Switching on 105
- Rear lamp bulbs
 - Replacing 251
- Rear parking lamp
 - Replacing bulbs 251
- Rear passenger compartment ventilation and climate control
 - Activating 131
 - Deactivating 131
- Rear passenger compartment ventilation and rear automatic climate control 131
- Rear quarter windows 136
 - Opening 136
- Rear quarter windows*
 - Closing 136
- Rear seats 93
 - Easy entry/exit feature* 95
 - Enlarging cargo area 93
 - Folding down backrest 93
 - Folding up 94
 - Folding up backrest 94
 - Fore and aft 93
 - Lowering 94
 - Third row* 96
- Rear standing lamp
 - Replacing bulbs 251
- Rear towing eyes 269
- Rear view mirror automatic antiglare 119
- Rear view mirrors see Mirrors
- Rear window defroster 131
 - Activating 131
 - Deactivating 131
- Rear window wiper 123
 - Rain sensor* 123
- Rear window wiper/washer 48
- Reconnecting
 - Vehicle battery 262
- Refrigerant
 - Air conditioning 286

- Regular checks 201
- Reinstalling vehicle battery 262
- Remote control
 - Changing battery 243
 - Global locking 85
 - Global unlocking 85
 - Synchronizing 244
 - Unlocking liftgate 85
 - Unlocking the driver's door, fuel filler flap 85
 - Unlocking with 32
- Remote control with folding key 84
- Remote controls
 - Integrated 169
- Remote door unlock
 - With Tele Aid* 167
- Remote Vehicle Diagnostics 295
- Removing
 - Head restraint 92
 - Vehicle battery 262
 - Wheel 257
 - Wiper blades 254
- Removing spare wheel (except ML 55 AMG) 239
- Removing spare wheel (ML 55 AMG) 240
- Replacing
 - Backup lamp bulbs 251
 - Brake lamp bulbs 251
 - Bulbs 247
 - Front lamp bulbs 249
 - Front turn signal bulbs 249
 - Fuses 271
 - High beam bulbs 250
 - High mounted brake lamp 252
 - License plate lamp bulbs 252
 - Low beam bulbs 249
 - Rear fog lamp bulbs 251
 - Rear lamp bulbs 248, 251
 - Rear parking lamp bulbs 251
 - Rear side marker lamp bulbs 251
 - Rear standing lamp bulbs 251
 - Rear turn signal bulbs 251
 - Wiper blades 254
- Replacing front fog lamp bulb 251
- Reporting
 - Safety defects 19
- Resetting
 - Service indicator (FSS) 216
 - Trip odometer 112
- Residual heat utilization 130, 295
- Residual ventilation 130
- REST (Residual engine heat utilization) 295
- Restraint system 295
- Restraint system see Infant and child restraint systems 63, 67
- Restraint systems 54
 - Airbags 54
 - Child seat recognition 54
 - Child seats 54
 - Emergency tensioning device (ETD) 54
 - Lower anchors and tethers for children (LATCH) 54
 - Seat belts 54
- Returning from off-road driving 191
- Rims 279
- Roadside assistance 12
 - Tele Aid* 163
- Rolling code programming 170
- RON 200
- RON (Research Octane Number) 296
- Roof rack 145
- Rotating wheels 212
- Rubber parts
 - Cleaning 222

S

- Safety
 - Occupant 54
- Safety belts see Seat belts 40
- Safety defects
 - Reporting 19
- Safety systems
 - Driving 71
- Saving current speed 147
- Seat belt force limiter 62
- Seat belt height adjustment 43
- Seat belts 54, 60
 - Cleaning 221
 - Fastening 40
 - Height adjustment 43
 - Proper use of 42, 61
 - Safety guidelines 57
 - Warning lamp 234
- Seat heater
 - Switching off 91
 - Switching on 91
- Seats 91
 - Adjusting 34
 - Heater 91
 - Manual 35
 - Power 37
- Rapid seat heating 91
- Rear 93
- Split rear bench seat 93
- Securing cargo
 - Cargo tie-down rings 140
- Selector lever 26
 - Lock 44
 - Position 26, 113
- Self-test
 - BabySmart™ airbag deactivation system 66
 - Tele Aid* 160
- Service 215
 - Calling up the service indicator 216
 - Major service (Service B) 215
 - Minor service (Service A) 215
 - Overdue 215
 - Spare parts
 - Types 215
 - When due 215
- Service and Warranty Booklet
 - Loss of 275
- Service and warranty information 10
- Service indicator 215
 - Calling up 216
 - Clearing 215, 216
- Service indicator (FSS)
 - Display messages 235
- Service life (tires) 210
- Service System see FSS
- Setting
 - Cruise control 147
 - Exterior rear view mirror parking position 100
 - Higher speed in cruise control 148
 - Hours (clock) 112
 - Lower speed in cruise control 148
 - Minutes (clock) 112
 - Slower speed in cruise control 148
 - Speed in cruise control 148
- Setting date
 - Trip computer* 172
- Setting language
 - Trip computer* 176
- Shift lock 296
- Shifting
 - Gear selector lever positions 115
 - Into optimal gear range (automatic transmission) 114
- Side impact airbags 59
- Side marker lamps
 - Replacing bulbs 247, 248, 250

- Side windows 134
 - Automatic closing 135
 - Automatic opening 135
 - Cleaning 220
 - Closing 135
 - Closing fully 135
 - Opening 135
 - Opening and closing 134
 - Opening fully 135
 - Rear quarter window 136
 - Stopping 135
 - Synchronizing power windows 136
- Simultaneous wiping and washing
 - Rear window wiper/washer 48
 - Windshield wipers 48
- Single wipe 48
- Sliding/pop-up roof 137
 - Automatically opening 138
 - Closing 246
 - Opening 246
 - Stopping 137
 - Synchronizing 138
- Sliding/pop-up roof*
 - Closing 137
 - Opening 137
- Snow chains 214
- Spare fuses 271
- Spare parts service 274
- Spare tire
 - Inflating 259
- Spare wheel 239
 - Mounting 255
 - Removing (except ML 55 AMG) 239
- Spare wheel (ML 55 AMG)
 - Removing 240
- Speed
 - Saving current 147
- Speed settings
 - Cruise control 148
- Speedometer 25
- Speedometer display
 - Additional indicators 235
- Split rear bench seat 93
- SRS 61, 296
 - Indicator lamp 227
- Standing lamps 102
 - Replacing bulbs 247, 248
- Standing water
 - Driving instructions 185
- StArt
 - Display messages 235
- Starting difficulties 45
- Starting position 33
- Starting the engine 44
- Steep terrain
 - Driving 187
- Steering lock 23, 33
 - Positions 33
- Steering wheel
 - Adjusting 37
 - Cleaning 221
- Stolen vehicle
 - Tracking services 168
- Stop watch 175
- Stopping
 - Sliding/pop-up roof 137
 - Windows 135
- Storage compartments
 - Glove box 152
 - Under front passenger seat* 152
- Storing (Memory function*)
 - Positions into memory 100
- Stranded vehicle 270
- Sun visor 123
- Supplemental Restraint System (SRS) 296

Switching off

- Automatic climate control 127
- ESP 76
- Front fog lamps 106
- Hazard warning flasher 106
- Headlamps 51
- Rapid seat heating 91
- Rear fog lamp 106
- Transmission control – LOW RANGE mode 118

Switching on

- Automatic climate control 126
- ESP 77
- Front fog lamps 105
- Front fog lamps, rear fog lamp 105
- Hazard warning flasher 106
- Headlamps 46
- High beams 102
- Rapid seat heating 91
- Seat heating 91
- Transmission control – LOW RANGE mode 118
- Trip computer 172
- Windshield wipers 47

Synchronizing

- Power windows 136
- Remote control 244
- Sliding/pop-up roof 138

T

Tachometer 26, 112

- Displaying gear range 114

Tail lamps 251

- Cleaning 220
- Replacing bulbs 248

Tar stains 218

Technical data 286

- Brake fluid 286
- Coolants 287
- Electrical system 281
- Engine 278
- Engine oil 286
- Engine oil additives 286
- Fuel requirements 287
- Gasoline additives 287
- Main dimensions 282
- Premium unleaded gasoline 286
- Rims and tires 279
- Weights 283
- Windshield and headlamp washer system 290

Tele Aid

- Information 165
- Initiating an emergency call manually 163
- Roadside assistance 163
- Tele Aid System 160
- Tele Aid System* 296
- Tele Aid* 159
 - Emergency calls 161
 - Remote door unlock 167
 - Stolen vehicle tracking services 168
 - System self-check 160
 - Upgrade signals 166
- Telematics* 296
- Telephone* 158
- Temperature
 - Grades of tires 292
 - Tires 211
- Third row seats* 96
 - Folding down single seat 96
 - Installing single seat 98
 - Removing single seat 98
 - Storing single seat 97
- Tie-down rings (Cargo compartment) 140
- Tightening torque 296
- Tightening torque (Wheel bolts) 258

- Tilt
 - Head restraint 36
- Time
 - Setting hours 112
 - Setting minutes 112
- Tire inflation pressure
 - Checking 201, 211
- Tire speed rating 184, 296
- Tire traction 183
- Tires 209, 279, 291
 - Direction of rotation 210
 - Driving instructions 182
 - Retreads 209
 - Rims and tires 279
 - Rotating 212
 - Service life 210
 - Temperature 211
 - Temperature grades 292
 - Tread depth 213
 - Wear pattern 212
 - Winter 213
- Tools 237
 - Vehicle jack 237
 - Vehicles with CD-changer* 238
 - Wheel bolt wrench 237
- Tow-away alarm 29, 79
 - Arming 79
 - Disarming 79
 - Disarming for transport 79
- Towing
 - Trailer 192
- Towing a trailer 194
 - Automatic transmission 117
- Towing eyes
 - Front 269
 - Rear 269
- Towing the vehicle 267
 - Stranded vehicle 270
- Tracking services
 - For stolen vehicle 168
- Traction 291, 296
- Trailer
 - Attaching 194
 - Loading 193
 - Towing 194
- Trailer hitches 192
- Trailer towing 192
 - Attaching a trailer 194
 - Checking weights 193
 - Electrical connections 192
 - Hitches 192
 - Loading 193
 - Parking 196
 - Weights and ratings 193
- Trailer weights and ratings 193
- Transfer case 296
- Transmission control – LOW RANGE
 - mode 118
 - Switching off 118
 - Switching on 118
- Transmission selector lever 245
 - Unlocking manually 245
- Tread depth (tires) 213
- Treadwear 291
- Trip computer
 - Average fuel consumption 175
 - Compass 173
 - Distance remaining 175
 - Selecting functions 172
 - Setting date 172
 - Stop watch 175
 - Switching on 172
- Trip computer* 29, 172
 - Country 176
 - Language 176
- Trip odometer
 - Resetting 112

- Trip odometer display 111
- Trunk see Cargo compartment 85
- Turn signal lamps
 - Replacing bulbs 247, 248, 250
- Turn signals 47
 - Additional in mirrors 247
 - Cleaning lenses 220
 - Front bulbs 247
 - Indicator lamps 25
 - Rear bulbs 248, 251
- Turning off
 - Engine 51

U

- Unlocking 32, 84
 - Centrally from inside 90
 - Driver's door in an emergency 242
 - Driver's door, fuel filler flap 85
 - Fuel filler flap 200
 - In an emergency 242
 - Transmission selector lever
 - manually 245
 - Vehicle in an emergency 167
 - With the remote control 32
- Upgrade signals
 - Tele Aid* 166

- Uphill driving
 - Cruise control 147
- Upholstery
 - Cleaning 222
- Upshifting 114
- Useful features 152
 - Ashtrays and cigarette lighter 156
 - Cup holder 154
 - Electrical outlet 158
 - Garage door opener 168
 - Interior storage spaces 152
 - Tele Aid* 159
 - Telephone* 158
 - Trip computer* 172

V

- Vehicle
 - Locking 28
 - Locking in an emergency 243
 - Lowering 258
 - Proper use of 17
 - Service battery 261
 - Towing 267
 - Unlocking 28
 - Unlocking in an emergency 242
- Vehicle and trailer weights and ratings 193
- Vehicle battery 261

- Vehicle care 217
 - Cup holder 221
 - Engine cleaning 219
 - Gear selector lever 221
 - Hard plastic trim items 221
 - Headlamps 220
 - Instrument cluster 221
 - Leather upholstery 222
 - Light alloy wheels 221
 - MB Tex upholstery 222
 - Ornamental moldings 220
 - Paintwork 219
 - Parktronic* system sensor 220
 - Plastic and rubber parts 222
 - Power washer 218
 - Seat belts 221
 - Steering wheel 221
 - Tail lamps 220
 - Tar stains 218
 - Turn signals 220
 - Upholstery 222
 - Vehicle washing 219
 - Window cleaning 220
 - Wiper blades 220
- Vehicle identification number (VIN) 276
- Vehicle jack 238

- Vehicle lighting
 - Checking 201
- Vehicle tool kit 237
 - Vehicle with CD-changer* 238
- Vehicle washing 219
- VIN (Vehicle Identification Number) 276, 297
- Voice control system* 297

W

- Warning indicators
 - Parktronic* 150
- Warning sounds
 - Drivers seat belts 60
 - Parking brake 46
- Warranty coverage 275
- Washer fluid see Windshield washer fluid
- Washing the vehicle 217
- Wear pattern (tires) 212
- Weights 283
- Wheel bolt wrench 237
- Wheel change
 - Tightening torque 258
- Wheels
 - Rotating 212
 - Tires and wheels 209

- Window curtain airbags 59
- Windows see Side windows
- Windshield
 - Defogging 128
 - Refilling washer fluid 208
 - Replacing wiper blades 254
 - Washer fluid 208, 290
 - Washer system 290
- Windshield washer fluid 290
 - Filler neck 208
 - Mixing ratio 290
 - Refilling 208
 - Wiping with 48
- Windshield washer system 290
- Windshield wipers 47, 122
 - Intermittent 47
 - Interval wiping 122
 - Normal wiper speed 47
 - Rain sensor* 122
 - Rear window wiper/washer 48
 - Replacing wiper blades 254
 - Simultaneous wiping and washing 48
 - Single wipe 48
 - Switching on 47
 - Wiping with windshield washer fluid 48

- Winter driving 213
 - Block heater 214
 - Snow chains 214
 - Tires 213
 - Winter tires 280
- Winter driving instructions 184
- Winter tires 213, 280
- Wiper blades
 - Cleaning 220
 - Installing 254
 - Removing 254
 - Replacing 254
- Wiper switch 47
- Wiper/washer
 - Rear window 48
- Wiping
 - And washing simultaneously 48
 - Intermittent 47, 122
 - With windshield washer fluid 48
- Wiping and washing simultaneously 48

X

- Xenon headlamps
 - Bi-Xenon 293

Service and Literature

Your authorized Mercedes-Benz Center has trained technicians and original Mercedes-Benz parts to service your vehicle properly. For expert advice and quality service, see your authorized Mercedes-Benz Light Truck Center.

If you are interested in obtaining service literature for your vehicle, please contact your authorized Mercedes-Benz Light Truck Center. We consider this the best way for you to obtain accurate information for your vehicle.

For further information you can find us on the Mercedes-Benz web-site *www.mbusa.com* or *www.mercedes-benz.ca*.

Warning!



To help avoid personal injury, be extremely careful when performing any service work or repairs. Improper or incomplete service or the use of incorrect or inappropriate parts or materials may damage the vehicle or its equipment, which may in turn result in personal injury.

If you have any question about carrying out some service, turn to the advice of an authorized Mercedes-Benz Light Truck Center.

We reserve the right to modify the technical details of the vehicle as given in the data and illustrations of this Operator's Manual. Re-printing, translation and copying, even of excerpts, is not permitted without our prior authorization in writing.

Title illustration no. P00.01-2273-31

Press time 09 / 26 / 02

GSP/SIP

Printed in Germany

Free Manuals Download Website

<http://myh66.com>

<http://usermanuals.us>

<http://www.somanuals.com>

<http://www.4manuals.cc>

<http://www.manual-lib.com>

<http://www.404manual.com>

<http://www.luxmanual.com>

<http://aubethermostatmanual.com>

Golf course search by state

<http://golfingnear.com>

Email search by domain

<http://emailbydomain.com>

Auto manuals search

<http://auto.somanuals.com>

TV manuals search

<http://tv.somanuals.com>