



COMAND Operator's Manual



Mercedes-Benz

Order-No. DaimlerChrysler 6515 6644 13 Blaupunkt 8 622 403 128 Index C Parts-No. 203 584 33 96 US Edition C 05/02

Welcome to COMAND!

Please make yourself familiar with your COMAND control unit and read the instructions in this manual before operating the COMAND system. This will help you derive a greater benefit from the system. Please also follow the instructions and warnings contained in this manual. Ignoring them could result in damage to the vehicle or personal injury to you or others.

Your COMAND system may have some or all of the equipment described in this manual. Therefore, you may find explanations for optional equipment not installed in your vehicle. If you have any questions about the operation of any equipment, your authorized Mercedes-Benz Center will be glad to demonstrate the proper procedures.

We continuously strive to improve our product and ask for your understanding that we reserve the right to make changes in

design and equipment. Therefore, information, illustrations and descriptions in this manual might differ from the equipment installed in your vehicle. As such, the information, illustrations and descriptions contained in this manual may not be reasonably relied upon in making any claims with respect to the actual performance of the product.

These operating instructions form an integral part of the vehicle and should therefore always be kept inside the vehicle and passed on to the new owner if the vehicle is sold.

We extend our best wishes for many miles of safe, pleasurable driving.

Mercedes-Benz USA, LLC

A DaimlerChrysler Company

Contents

Introduction	1	Audio	23	Naming a CD	55
Where to find it	1	Radio operation	24	Playback mode	58
Symbols	2	Quick reference	24	Muting CD playback	60
Operating safety	3	Switching on	28	Error messages	60
		Switching another system on	28	Multifunctional display	62
		Changing the Radio band	29	Sound settings	63
		Selecting a station	30	Adjusting sound settings	63
		Memory functions	34		
At a glance	5	Multifunction display	40	Telephone	67
COMAND control unit	6	CD operation	42	Important notes	68
Screen displays	9	Quick reference	42	Multifunction display	71
Multifunction display	11	General information on		Display overview	72
Quick reference COMAND	12	CD operation	44	Telephone operation	74
Switching the COMAND control unit		Menu overview	48	Quick reference	74
on and off	12	Switching on	50	Menu overview	76
Adjusting the volume	14	Switching another system on	50	Switching telephone operation on	78
Radio operation	14	Track select	51	Switching telephone operation off	79
CD operation	15	Selecting a CD	53	Incoming call	79
Telephone operation	16	Fast forward/reverse	54	Outgoing calls	82
Entering a destination and		CD track scan	55	Notebook	97
calculating a route	17			Editing the phone book	98
Selecting beeps	21				

Contents

- Driving on a non-digitized road... 168
- Interrupt route guidance during a journey..... 169
- Arriving at destination..... 170
- Activating audio system..... 171
- Activating audio functions..... 171
- Canceling route guidance..... 173
- Destination memory..... 174
 - Retrieving a destination from the destination memory..... 174
 - Saving the current destination... 175
 - Saving the current vehicle location..... 177
 - Sorting destination memory..... 178
 - Deleting a destination..... 179
- Settings..... 180
 - Entering the vehicle location... 180
 - Calibration..... 181

- Info Services/System settings**... 183
- Info Services*..... 184
 - Requesting and displaying Info Services..... 184
- System settings..... 187
 - Activating the main settings menu 187
 - Adjusting the brightness..... 188
 - Activating settings menu..... 188
 - Selecting the language..... 189
 - Setting date and time..... 190
 - Switching beep tones on and off . 197
 - Setting the display dimming characteristics (day and night display)..... 198
 - Resetting all settings to the factory settings..... 199

- Auxiliary audio source..... 200
 - Connecting..... 200
 - Switching auxiliary audio source on..... 200
 - Switching auxiliary audio source off..... 202

Glossary..... 203

Index..... 205

Contents

Where to find it

This Operator's Manual is designed to provide support information for you, the COMAND operator. Each chapter has its own guide color to provide fast access to information.

At a glance

Here you will find an overview of all COMAND control elements and system components. If you are operating COMAND for the first time or if you have rented or borrowed the vehicle, this is the chapter you should read first.

Audio

Here you will find all the information on how to use the radio, cassette player*, CD-player, CD changer and adjust the audio system settings.

Telephone

Here you can learn in detail about the many functions of the telephone, SMS, how to initiate an emergency call and use service numbers.

Navigation

This chapter provides detailed information on the following topics:

- Destination input
- Route selection and calculation
- Route guidance including detour
- Destination memory

Info Services* and System settings

This chapter provides information on how to:

- Request and display info services such as news, weather, stocks and sports
- Adjust COMAND system settings

Directories

The glossary explains the most important technical terms.

The table of contents and index directory will help you quickly locate the information you need.

Introduction

Symbols

Symbols

You will find the following symbols in these operating instructions:

- * The asterisk identifies optional equipment. Since not all models have the same standard equipment, your COMAND system equipment may deviate from some descriptions and illustrations.

Warning



A warning draws your attention to possible dangers to your safety or the safety of others.



Highlights hazards that may result in damage to your COMAND.



Helpful hints or further information you may find useful.

- ▶ This symbol points to instructions for you to follow.
- ▶ A number of these symbols appearing in succession indicates a multiple-step procedure.

(▷ page 3) This symbol tells you where to look for further information on this subject.



The continuation symbol marks an interrupted procedure which will be continued on the next page.

Display

Words appearing in the multi-function display are printed in the type shown here.

Operating safety

Warning



Any alterations made to electronic components and the software can cause malfunctions.

The radio, amplifier, CD changer and telephone* are interconnected. When one of the components is not operational or has not been removed/replaced properly, the function of other components may be impaired.

This condition might seriously impair the operating safety of your vehicle.

We recommend that you have any service work on electronic components carried out by an authorized Mercedes-Benz Center.

Warning



In order to avoid distraction, which could lead to an accident, system settings should be entered with the vehicle at a standstill. The driver should only operate the system when traffic conditions permit.

Bear in mind that at a speed of just 30 mp/h (approximately 50 km/h), your car is covering a distance of 50 feet (approximately 14 m) every second.

COMAND supplies you with information to help you select your route more easily and guide you conveniently and safely to your destination. For safety reasons, we encourage the driver to stop the vehicle in a safe place before answering or placing a call, or consulting the COMAND screen to read navigational maps, instructions, or downloaded information.

While the navigation system provides directional assistance, the driver must remain focused on safe driving behavior, including attention to traffic and street signs, and should utilize the system's audio cues while driving.

The navigation system does not supply any information on stop signs, yield signs, traffic regulations or traffic safety rules. This always remains your personal responsibility when you drive. CD maps do not cover all areas nor all routes within an area.

Introduction

At a glance

COMAND control unit

Multifunction display

Quick reference COMAND

At a glance

COMAND control unit

COMAND control unit



At a glance

COMAND control unit

	Function	Page
1	Switching COMAND on and off	12
2	Switching the navigation system on	122
	Quick reference	116
3	CD drive for an audio or a navigation CD	
4	Zooming in for more detailed map	158
5	Zooming out for less detailed map	158
6	Route guidance is active: Switching between map and symbol display or activating the map	156
	Route guidance is not active: Activating the location map	149
7	Selecting a detour during route guidance	163

	Function	Page
8	Requesting destination and route information	147
9	Muting of:	
	• Audio source	28
	• Voice output during route guidance	153
10	Setting the display dimming characteristics (day and night display)	198
11	Ejecting an audio or a navigation CD	45
12	Radio operation:	
	Selecting a station	30
	Saving stations manually	34
	CD operation:	
	Selecting a track or CDs	51, 53
	Telephone:	
	Entering the unlock code	78
	Entering the telephone number	82

	Function	Page
	Navigation (Destination input):	
	Selecting destination via the map	131
13	Subsequent dialing	84
	Displaying a long list entry in full in a window	127
	Removing a window	127
14	Subsequent dialing	84
15	From within a system: Return to the previous menu	
	Telephone:	
	Ending a call	81

At a glance

COMAND control unit

	Function	Page		Function	Page		Function	Page
16	General: Altering or deleting entries	18	18	Turn to adjust the volume of	14	21	Switching radio operation on	28
	CD operation: Deleting a CD name	57		<ul style="list-style-type: none"> Audio source Hands-free operation of the telephone Voice output during route guidance 			Quick reference	24
	Telephone: Altering or deleting the unlock code or a telephone number	83		Press to repeat the current voice output			Changing the radio band	29
17	Turn to highlight a function or a menu field		19	Radio operation: Automatic seek tuning	30	22	Switching CD operation on	50
	Press to start a function or activate a submenu			Manual tuning	31		Quick reference	42
				CD operation: Track select	51	23	Switching telephone operation on	78
				Fast forward/reverse	53		Quick reference	74
			20	Requesting and displaying Info Services	184	24	Color screen, e.g. with main radio menu	14
				Adjusting system settings	187			

Screen displays

Screen displays include:

- Main system menus, e.g. the main radio menu
- Lists for the selection of entries, e.g. the city list (▷ page 19)
- Input menus, e.g. during destination input (▷ page 18)
- Selection menus, e.g. during route calculation (▷ page 20)
- Symbol display (▷ page 20) or map (▷ page 132) in navigation
- Pop-up windows (▷ page 171)

Main menu structure

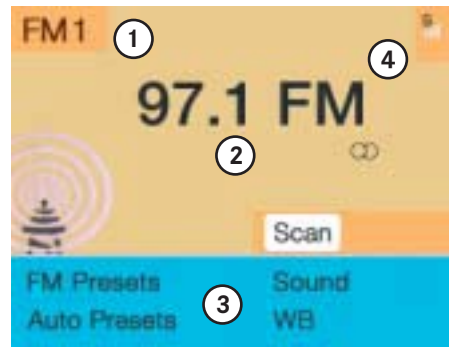

P82.85-9059-31

Main radio menu

- 1 Status line, displays active system
- 2 Station frequency and function that has been switched on
- 3 Menu fields to call further menus or functions
- 4 Symbol bar

Status line and symbol bar

Symbols	Meaning
Status line	
FM1	The radio is switched on in FM Band; the current station has been saved in memory location 1 in the FM preset menu
AM, WB	AM or Weather Band WB
CD, TEL NAV, SVC SYS, AUX	The corresponding system is active
Symbol bar	
	Reception strength of the mobile phone
	Incoming SMS message ¹
	<small>1 if available from carrier</small>

At a glance

COMAND control unit



The symbol bar appears in all system main menus.

For symbol and map displays in navigation:

The symbol bar appears on the left hand side of the display and shows different symbols.

Pop-up screen messages

Battery voltage gets low

You can still operate COMAND without the engine running.



To prevent the car battery from running down, you will be receiving two messages asking you to start the engine when battery power gets low.

You will see the message “Caution. Please start engine. Otherwise COMAND will shut down in 3 minutes”.

- ▶ Start the engine.



If you do not start the engine, you can continue using COMAND until the next message appears.

You will see the message “Caution. Please start engine. Otherwise COMAND will shut down in 10 seconds”.

- ▶ Start the engine.

You will see the message “Caution. COMAND will shut down now”.

- ▶ Start the engine.

*Transmitting an emergency call via TELE AID**

Refer to the vehicle operating instructions for information regarding the operation TELE AID emergency call system and on how to transmit an emergency call.

You will see the message “Tele Aid active”.

- ▶ Press the right-hand rotary/push-button  to remove the window.

COMAND will mute an audio source or one of the two service sources Voice output in navigation or Voice recognition system.

Multifunction display

The starter switch must be in position 1 or 2. Refer to vehicle operating instructions.

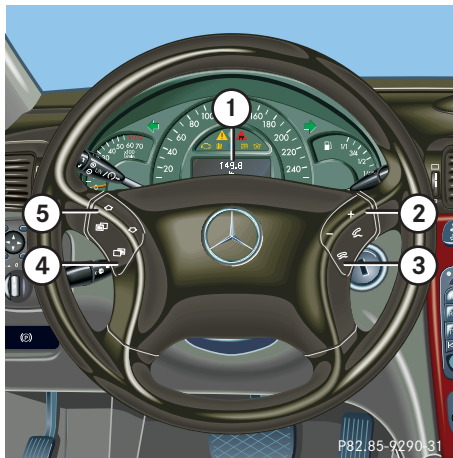

Function

- 1 Multifunction display in speedometer

Operating the control system

- 2 Adjusting the volume

— lowers the volume

+ raises the volume

- 3 Making a call

 Accept incoming call or starts dialing

 End a call or end Tele Aid

- 4 Switching between menu systems

 next system

 previous system

At a glance

Multifunction display

Function

- 5 Moving within a menu system

 next display

 previous display

You can operate the following systems with steering wheel buttons 4 and 5:

- Radio
- CD (CD changer and CD drive)
- Auxiliary audio source, e.g. tape recorder (▷ page 200)
- Telephone

For more detailed information, refer to “Multifunction display” in the chapters discussing the radio, CD, telephone operation.

At a glance

Quick reference COMAND

Quick reference COMAND

The section “Quick reference COMAND” summarizes information regarding the main functions of your COMAND system. You should read this section with particular care if you are operating COMAND for the first time.

For detailed information, please refer to the pages indicated and the respective system chapters.

Switching the COMAND control unit on and off

Switching on



P82.85-9060-31

- ▶ Press **PWR**.

The Mercedes logo and the lettering Mercedes-Benz will appear. The display then changes and an alert box will appear.



P82.85-9061-31

COMAND switches on the last active system and displays the corresponding menu.

The navigation system was the last system used

The menu displayed will vary according to the last navigation function used.

If route guidance was active:

- the symbol display or
- the map

If route guidance was active and the COMAND was switched off for more than 2 hours:

- an inquiry menu (▷ page 169)



If COMAND is switched off for more than 30 minutes during active route guidance, all manually entered traffic jams and detours are deleted. You will see a corresponding message. Selecting a detour (▷ page 163).

If destination input was active:

- the main destination input menu

Switching another system on

- ▶ Press a system key, e.g. **CD**.
The main CD menu will appear.

Switching off

- ▶ Press **PWR**.
The COMAND control unit will switch off.

At a glance

Quick reference COMAND

Adjusting the volume

At the multifunction steering wheel

To raise the volume

- ▶ Press **+**.

To lower the volume

- ▶ Press **-**.

At the COMAND operating unit

- ▶ Turn the the left-hand rotary/push-button **⦿**.

For the audio sources

- Radio
- CD (CD drive and CD changer)

you can set the volume jointly.

For the service sources

- Voice output during route guidance (navigation system) and
- Voice Recognition System (refer to separate operating instruction)

you can set the volume jointly.

For the service source

- Telephone

you can alter the listening volume for the telephone only.

Radio operation



P82.85-6062-31

Switching on

- ▶ Press **FM AM**.

The radio is switched on. The station last tuned to will begin to play.

Changing the radio band

- ▶ Press **FM AM** to switch between FM-, AM- and WB-Band.

At a glance

Quick reference COMAND

Selecting a station

Automatic seek tuning

- ▶ Press **◀** or **▶** on the rocker switch briefly.

FM- and AM-Bands, Weather Band WB

The radio will tune in to the next receivable station (FM/AM) or channel (WB) with descending/ascending frequency.

Switching another system on

- ▶ Press any system key, e.g. **CD**.

COMAND will switch to CD mode.

You will find more information regarding this topic in section “Radio operation” in chapter “Audio” (▷ page 28).

CD operation



P82.85-9063-31

Switching on

- ▶ Press **CD**.

The main CD menu will appear.

Playback will begin in

- CD drive with the first track on the CD
- CD changer with the first track on the first CD detected in the magazine.

Loading a CD into the CD drive and loading CDs in the CD changer (▷ page 45).

Track select

- ▶ Press the rocker switch **◀** / **▶**.

You will hear the previous or next track. If more than 9 seconds of playing time has elapsed, the CD changes back to the start of the current track.

Selecting a CD

- ▶ Press one of the number keys
 - Key **0** select the CD drive
 - Keys **1** - **6** select the corresponding magazine slot of the CD changer

The message “Loading CD ...” appears on the display. Playback then will begin with track 1.

At a glance

Quick reference COMAND

CD track scan

- ▶ Press the right-hand rotary/push-button **0** to confirm “Scan”.

The tracks on the CD will be played one after the other for 8 seconds each, “Scan” will appear in red.

- ▶ Press the right-hand rotary/push-button **0** again to end the function.

Switching another system on

- ▶ Press any system key, e.g. **TEL**.

COMAND will switch to Telephone operation.

You will find more information in section “CD operation” in chapter “Audio” (▷ page 50).

Telephone operation



P82.85-9064-31

Switching on

- ▶ Press **TEL**.

The menu to enter the unlock code will appear.

Entering the unlock code

- ▶ Use the number keys **1** through **0** to enter the unlock code.

Asterisks instead of digits will appear in the input line.

- ▶ Press the right-hand rotary/push-button **0** to confirm the entry.

If entered code is correct and the phone is registered in a network, the phone is ready for use.

Outgoing call

Enter a telephone number

- ▶ Use the number keys **1** through **0** to enter the telephone number.

The menu changes when the first digit is entered.

Begin dialing

- ▶ When the “Send” button is highlighted, press the right-hand rotary/push-button  to confirm your input.

Dialing will begin. If the phone number together with a name is stored in the phone book, the name appears on the screen.

Conducting a call

When the call is answered, the call time appears in the screen.

Ending a call

- ▶ Press the right-hand rotary/push-button  to confirm the “End” button.

Switching another system on

- ▶ Press any system key, e.g. **NAV**.

COMAND switches to the navigation system.

You will find more information in chapter “Telephone” (> page 78).

Entering a destination and calculating a route

Switching the navigation system on

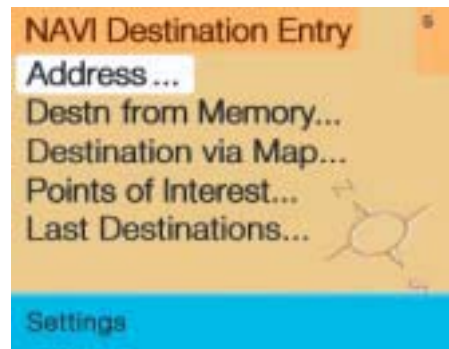

P82.85-9065-31

Main destination input menu

- ▶ Press **NAV**.

If the navigation system has not been booted up, the message “Navigation being activated. Please obey all traffic rules” will appear.

The navigation menu displayed will vary according to the last navigation function used (> page 13).

If route guidance was switched off, the main destination input menu will be displayed.

At a glance

Quick reference COMAND

Entering destination address

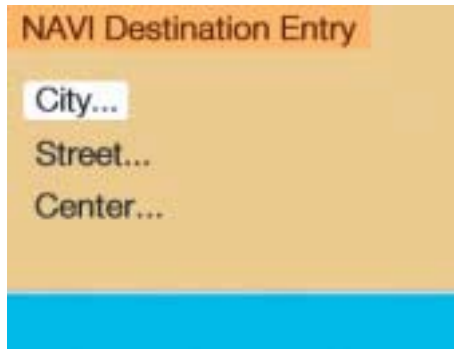

P82.85-9066-31

- ▶ Press the right-hand rotary/push-button  in the main destination input menu and confirm “Address...”.
- The main address menu will appear.
- The entry behind “City...” is either empty or the city you last entered will appear.

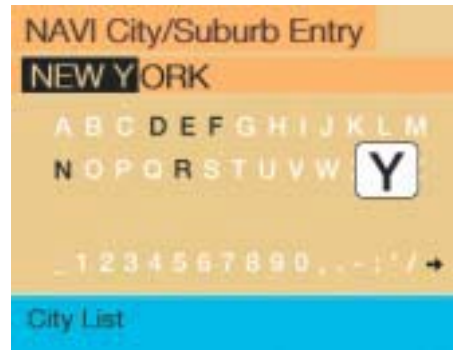

P82.85-9067-31

“City/Suburb Entry” input menu

- ▶ Press the right-hand rotary/push-button  in the main address menu and confirm “City...”.
- The “City/Suburb Entry” input menu will appear.

Adopting the city last selected

- ▶ Press the right-hand rotary/push-button  longer than 2 seconds.

Entering a city

- ▶ Turn the right-hand rotary/push-button  to highlight the first letter and press to confirm.
- ▶ Enter other characters until the desired city appears in the input line.

Correcting entry

- Last character
 - ▶ Press **DEL** briefly.
- Complete entry
 - ▶ Press **DEL** longer than 2 seconds.

Activating the city list

- ▶ Press the right-hand rotary/push-button  longer than 2 seconds until the city list appears.

At a glance

Quick reference COMAND

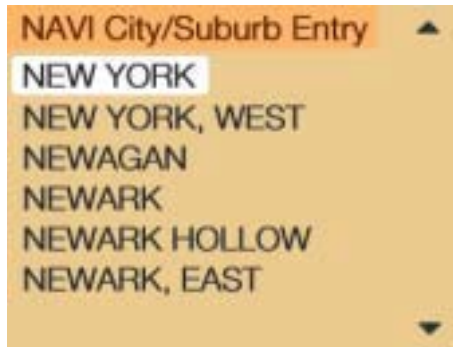

P82.85-9068-31



P82.85-9069-31



P82.85-9070-31

City list

- ▶ Press the right-hand rotary/push-button ● again to confirm the city. A selection menu will appear.



If several options of a city/suburb are available, another menu will appear where you must make and confirm your desired selection.

- ▶ Press the right-hand rotary/push-button ● to confirm “Street...”. The input menu “Street Entry” will appear.

The further sequence corresponds to the “Entering a city” section.

- ▶ Now enter the street and activate the street list. Then confirm the street in this list.

You have now selected the destination and can calculate the route.

- ▶ Press the right-hand rotary/push-button ● to confirm “OK”.

The “Route Mode” selection menu will appear.

At a glance

Quick reference COMAND



P82.85-9071-31

“Route mode” selection menu

Select a route and then a traffic route

- ▶ Turn the right-hand rotary/push-button  to move the cursor on the entry you want and press to confirm.

A checkmark appears .

Route types available:

- Fast Route
- Short Route

Including /avoiding traffic routes

- Freeway
- Ferry
- Toll

- ▶ Press the right-hand rotary/push-button  to confirm “OK”.

The selected route and the destination you have entered will appear on the display.

You will hear the message “The route is being calculated”.



P82.85-9072-31

Symbol display

After a few seconds, you will see the symbol display.

CALC. ROUTE	Calculation of route
2.9 miles	Distance to destination (as the crow flies)



P82.85-9073-31

The route will be calculated. COMAND identifies the road you are travelling on.

You will see the arrow indicating the direction of travel if COMAND recognizes the road you are travelling on. You will e.g. hear the message “Please turn right”. Route guidance will begin.

You will find more information in chapter “Navigation” (▷ page 123).

Day and night display, switching off screen

- ▶ Press **DISP** repeatedly until the desired display appears.

The display changes in this order:

- Day display
- Night display
- Screen off
- Day display



It is also possible to carry out the change between day and night display automatically via the headlight switch (▷ page 198).

At a glance

Quick reference COMAND

Selecting beeps

You can switch different beeps on and off.

- Acknowledgement beep
Beeps when you accept an entry or enter a destination on the map
- Info beep
Beeps when you see the messages announcing a drop of battery voltage (▷ page 10)
- Alarm beep
Beeps if the device has a serious malfunction or if you are listening to a disaster announcement on the radio. You can only switch off the beep if you also switch off COMAND.

You will find more information in chapter “System settings” (▷ page 197).

At a glance

Quick reference COMAND

Audio

Radio operation

CD operation

Sound settings

Audio

Radio operation

Radio operation

Quick reference



P82.85-9075-31

	Function	Page
1	Switching COMAND on and off	12
2	Muting the radio audio (muting on/off)	28
3	Selecting a station via number keypad (presets)	32
	Selecting a station via direct frequency entry	32
	Saving a station	34
	Selecting a station from the preset menu FM/AM	38
	Selecting a station from the WB preset menu	38
4	Activating the input mode for station frequency	
	in the main radio menu	32
	in the presets	39
5	Return to previous menu	

	Function	Page
6	Turn to highlight a function or a menu field	
	Press to perform a function or access a submenu	
7	Adjusting the volume	14
8	Automatic seek tuning ascending/descending	30
	Manual tuning ascending/descending	31
9	Requesting and displaying Info Services	184
	Adjusting system settings	187
10	Switching to radio operation	28
11	Color screen with main radio menu	

Audio

Radio operation

Menu overview

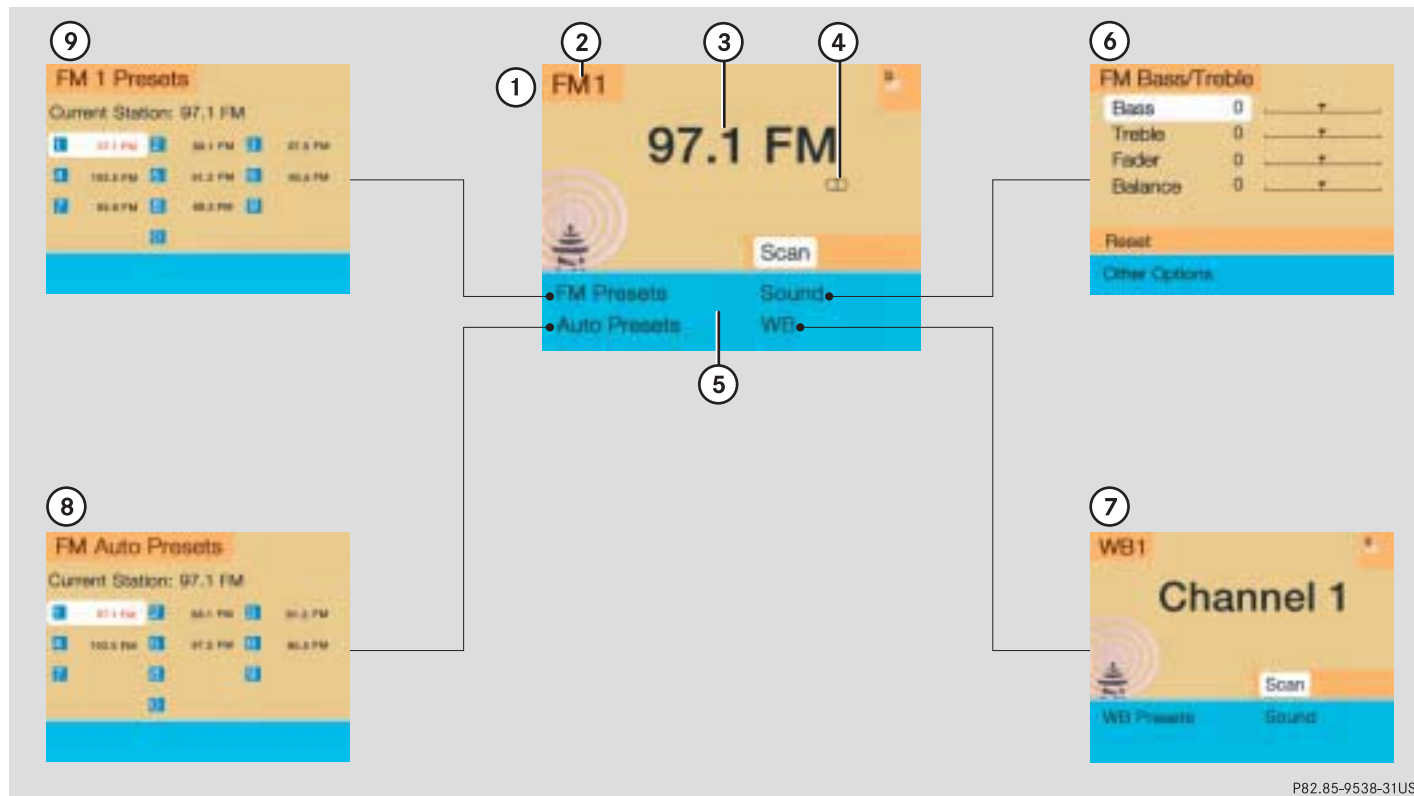

P82.85-9538-31US

	Function	Page
1	Main radio menu FM	
2	Current frequency band (FM) and memory preset selected (e.g. 1)	
3	Current frequency	
4	Symbol indicates stereo reception	
5	Menu fields	
6	Main sound menu Sound settings	63
7	Main Weather Band WB menu	29
8	Auto preset Saves 10 stations automatically Select a station	36 38

	Function	Page
9	Preset menu Save a station automatically FM, AM Select a station	36 38

Audio

Radio operation

In chapter “Audio” you will find detailed information regarding

- radio operation
- CD operation and
- sound adjustments

If you have not done so already, please familiarize yourself with these functions by reading chapter “At a glance”.

Switching on



P82.85-9077-31

Main radio menu FM

- 1 Frequency band (FM, AM, WB) and memory location of station, e.g. “1”
 - 2 Station frequency
 - 3 Symbol bar
- ▶ Press **FM/AM** to switch to radio operation.
The station last tuned will begin to play.



You can operate the telephone and the navigation system while the radio is on.

Muting

- ▶ Press **MUT** while listening to the radio.
The symbol will appear in the symbol bar.
- ▶ Press **MUT** again to resume listening to the current station.
The symbol will have disappeared.



Muting will also be canceled if you switch to a different audio source, e.g. CD, or if you alter the volume.

Switching another system on

- ▶ Press any system key, e.g. **CD**.
COMAND will switch to CD mode.

Changing the Radio band

You can select between FM-, AM- and WB-Band.

AM Band



P82.85-9078-31

- ▶ Press  until "AM" is displayed in the upper left hand corner of the display.
The AM station last tuned to will begin to play. The frequency will appear in the display.

Frequency band	Frequency range
FM	87.7 - 107.9 FM
AM	530 - 1710 AM

Weather Band WB



P82.85-9079-31

- ▶ In the AM or FM main radio menu, turn the right-hand rotary/push-button  to highlight WB and press to confirm.
The channel last tuned to will appear in the display.

i

If a weather band station cannot be received on this channel, an automatic search run of all 7 channels will take place. As soon as a weather band station is received, the search stops and the channel appears in the display. The automatic search will perform two cycles through the 7 channels.

Message "No WB"

A weather band station cannot be received on any of the 7 channels.

Audio

Radio operation

Selecting a station

You can use the following functions:

- Automatic seek tuning (▷ page 30)
- Seek tuning at the multifunction steering wheel (▷ page 31)
- Manual tuning (▷ page 31)
- Station selection via number keypad (presets) (▷ page 32)
- Station selection via direct frequency entry (▷ page 32)
- Automatic station scan (▷ page 33)
- Station selection from the preset menu (▷ page 38)

Automatic seek tuning



P82.85-9080-31

- ▶ Press **◀** or **▶** on the rocker switch briefly.

FM- and AM-Bands, Weather Band WB

The radio will tune in to the next receivable station (FM, AM) or channel (WB) with descending/ascending frequency depending on the direction of seek.

WB

Alternatively, you can select the channel directly:

- ▶ Press a number key **1** through **7**.

Seek tuning at the multifunction steering wheel

If the multifunctional display shows the station frequency, then:

- ▶ Press  or  to select a higher/lower frequency preset.





The up/down arrows have different functions depending on which mode the seek function in the multifunction display is programmed to.

The two available options are Memory Scan or Frequency Scan (Station search). Refer to the vehicle operator's manual on how to program this option.

Manual tuning (FM, AM)



P82.85-9081-31

- ▶ Press  or  on the rocker switch longer than 2 seconds.

The menu fields will appear in light grey lettering.

FM Band

The frequency displayed will change in increments of 0.2 MHz.

AM Band

Tuning will take place in increments of 10 kHz.



Activating the AM Band (▷ page 29).

Audio

Radio operation

Station selection via number keypad (presets)

FM- and AM-Bands



P82.85-9082-31

- ▶ Press one of the number keys, such as **2** briefly.

The radio will tune to the frequency assigned to that memory location. If none has been set by you, the radio will not change the station.



FM and AM presets are independent and can only be accessed while in the corresponding band.

Saving stations for FM and AM (▶ page 34).

Weather Band WB

- ▶ Tune the radio to the selected channel. The memory preset number will appear in the status line.



The “XX Presets” (XX = FM, AM or WB) menu field provides an overview of which stations have been allocated to which memory presets (▶ page 35).

Station selection via direct frequency entry (FM, AM)

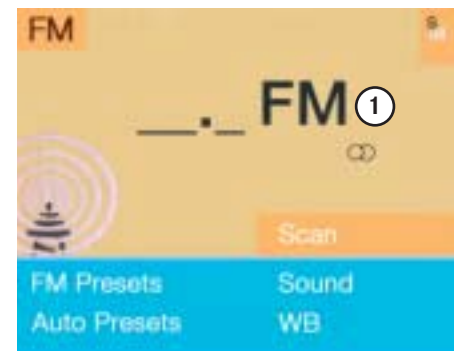

P82.85-9083-31

1 Input line

- ▶ Press *****. Input line **1** will appear in the main radio menu.
- ▶ Enter the desired frequency with the number keys within 8 seconds, e.g. **1 0 2 7** for 102.7 FM. The station you have selected will begin to play.



If you do not make another entry within 8 seconds, the function will be canceled and you will listen to the station last tuned to.

Frequency band	Frequency range
FM	87.7 - 107.9 FM
AM	530 - 1710 AM



If you enter a frequency that is outside the allowable input range, the message “Invalid input” appears. Enter a valid frequency.

Automatic station scan

The stations on same band (FM/AM/WB) can be scanned one after the other for 8 seconds each.



P82.85-9084-31

1 Scan function is active

- ▶ Press the right-hand rotary/push-button and confirm “Scan”.

The scan function will begin, “Scan” will appear in red lettering.

Weather Band WB

The individual weather stations stored in the memory on 7 channels will be scanned one after the other.

The scan function stops automatically when the first station received has been scanned twice.

End scan function and play a station

- ▶ Press the right-hand rotary/push-button again if you hear the desired station.

The station selected will appear with the station frequency. “Scan” will appear in black lettering again.

Audio

Radio operation

Memory functions

You can use the following functions:

- Saving stations manually FM
- Saving stations manually AM (▷ page 36)
- Saving stations automatically FM, AM (▷ page 36)
- Selecting a station from the FM/AM preset menu (▷ page 38)
- Selecting channels from the WB preset menu (▷ page 38)
- Selecting a station by entering the stations frequency in the FM/AM presets (▷ page 39)

Saving stations manually (FM)

In the main radio menu



P82.85-9085-31

- ▶ Press one of the number keys, e.g. **3**, longer than 2 seconds.

You will hear a confirmation beep if the beep tones option was activated in the system settings (▷ page 197).

The radio saves the current station at the memory preset selected. The memory preset selected will appear in the status line, e.g. "FM3".

i



There are 10 presets available (**1** - **9**, **0**).

An existing entry is overwritten in the memory list when a new input is given.

On the memory list

P82.85-9086-31

- 1 Preset of the station currently selected
- 2 Frequency of the station currently selected
- 3 Current frequency appears in red lettering
- 4 Memory preset allocated
- 5 Memory preset available

- ▶ Turn the right-hand rotary/push-button  to highlight "FM Presets" in the main radio menu and press to confirm. The FM preset memory will appear.
- ▶ Turn the right-hand rotary/push-button  to highlight the desired memory preset.
- ▶ Press the right-hand rotary/push-button  or corresponding number key longer than 2 seconds. The current station will be saved at the memory preset selected.

You will see the main radio menu

- automatically after 8 seconds
- if you press **BACK**.

i

There are 2 presets for each of the FM and AM waveband, standard FM/AM presets (saving stations manually) and Auto presets (saving stations automatically).

The standard FM/AM presets are not affected by the Auto presets. This is a second option for storing a station range you are currently receiving.

Audio

Radio operation

Saving stations manually (AM)



P82.85-9087-31

- ▶ Activate the AM Band (▷ page 29). Save a station in the same way as described for the FM Band (▷ page 34)
 - in the AM main radio menu
 - on the memory list

On the memory list



P82.85-9088-31

- ▶ Press the right-hand rotary/push-button ● to confirm "AM Presets". The AM preset memory will appear.



The standard AM presets are not affected by the Auto presets. This is a second option for storing a station range you are currently receiving.

Saving stations automatically (FM, AM)



P82.85-9089-31

1 Function is active

If the FM/AM main radio menu is displayed

- ▶ Turn the right-hand rotary/push-button ● to highlight "Auto Presets" and press the button longer than 2 seconds. Message **1** will appear.



P82.85-9090-31

The radio stores the 10 strongest stations. The station frequencies available will appear in the memory list.

Select other station

- ▶ Turn the right-hand rotary/push-button  to highlight the memory position and press to confirm.

The main radio menu appears.

- automatically after 8 seconds
- if you press **BACK**.

Audio

Radio operation

Weather Band



P82.85-9091-31

- ▶ Activate the Weather Band WB.
- ▶ Turn the right-hand rotary/push-button  to highlight "WB Presets" and press to confirm.

The WB Presets will appear. Channels 1 to 7 are listed in the memory. The memory position of the channels are fixed and cannot be altered.

Audio

Radio operation

Selecting a station from the preset menu (FM, AM)



P82.85-9092-31

- ▶ Activate the FM or AM memory (▷ page 35).

You can use one of the following two ways to select a station from the FM/AM presets

- ▶ Press the corresponding number key (e.g. **3**) to select the desired station.
- ▶ Turn the right-hand rotary/push-button **0** to highlight a memory preset in the FM/AM preset list and press briefly to confirm.

In both cases, the main radio menu will then appear automatically after 8 seconds, indicating the memory preset number.

Selecting a channel from the WB preset menu



P82.85-9093-31

- ▶ Activate the WB Presets (▷ page 37).
- ▶ Use one of the two ways to select a channel from the WB presets as described on the left.

The main WB menu will then appear automatically after 8 seconds, indicating the memory preset number.

Selecting a station by entering the station frequency in the presets (FM/AM)

The station frequency can be entered in FM and AM Bands in the corresponding presets list.



P82.85-9094-31

1 Input line

For both FM/AM Bands

- ▶ Press **⊕**.

An input line **1** will appear on the top line in place of the current station name.

- ▶ Use the number keys to enter the frequency.

The frequency is entered into **1** beginning from the right. After 8 seconds at the most, the station selected will begin to play.

Frequency band	Frequency range
FM	87.7 - 107.9 FM
AM	530 - 1710 AM



If you enter a frequency which is not within the given range, the message “Invalid input” will appear.

Enter a valid frequency.

Audio



Radio operation

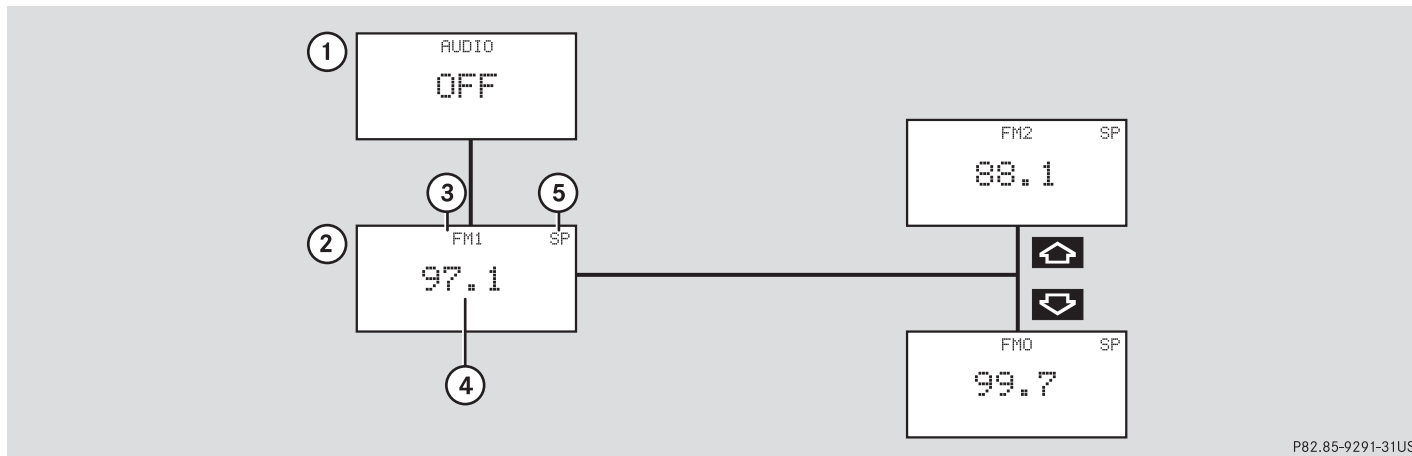



Multifunction display



- 1 No audio source has been switched on
- 2 The radio is switched on
- 3 Frequency band and the memory preset, if applicable
- 4 Frequency of the station selected

- 5 "SP" (memory) - appears if "Memory" instead of "Station search" or "Freq." (depending on model) has been selected in the "Vehicle" submenu. Refer to "Control system" in chapter "Controls in detail" in your vehicle's operating instructions for further information.

- ▶ Press **PWR** at the COMAND control unit to switch on COMAND.
- ▶ Press **FM AM** at the COMAND control unit to switch to radio operation.
- ▶ Repeatedly press key  or  at the multifunction steering wheel until display 2 appears.

- ▶ Repeatedly press  or  at the multifunction steering wheel until the desired station frequency appears.
- ▶ Press  or  at the multifunction steering wheel to display the next or previous system.

Audio

CD operation

CD operation

Quick reference



P82.85-9096-31

Function	Page
CD drive in the control unit and CD changer operation	
1 Switching COMAND on and off	12
2 CD drive for audio CD or navigation CD	45
3 Muting CD playback (muting on/off)	60
4 Ejecting an audio CD or a navigation CD	45
5 Selecting a CD	53
Selecting a track	51

Function	Page
6 Track selection with the number keypad	51
7 Return to previous menu	
8 Press briefly:	
Deletes the character that has been entered last	55
Press longer than 2 seconds:	
Deletes a complete name	55
9 Turn to highlight a function or a menu field	
Press to perform a function or activate a submenu	

Function	Page
10 Turn to the right: Raises the volume	
Turn to the left: Lowers the volume	
11 Press briefly:	
Previous track or start of the track (depending on playback time)/next track	51
Press longer than 2 seconds:	
Fast forward/fast reverse	54
12 Requesting and displaying Info Services	184
Adjusting system settings	187
13 Switching on CD operation (CD drive, CD changer)	50
14 Color screen with main CD menu	

Audio

CD operation

General information on CD operation

Health hazard



The CD drive and CD changer are Class 1 laser products. There is a danger of invisible laser radiation when you open or damage the cover.

Do not remove the cover. The CD drive and the CD changer do not contain any parts which can be serviced by the user. For safety reasons, have any necessary service work performed by an authorized Mercedes-Benz Center.



Use only CDs with a diameter of 12 cm, do not use 8-cm CDs.

An 8-cm CD adapter may cause damage to the CD changer and **should not** be used.

CD playback locations are

- the CD drive in the COMAND operating unit
You can play audio CDs or read data from the navigation CD.
- the CD changer with 6 magazine slots.

The status line in the main CD menu (▷ page 50) indicates which component is being used for CD playback.

Tips on caring for your CDs

- Only touch the CD on the sides.
- Avoid touching the CD surface with your fingers.
- Clean the CD with a dry, lint-free cloth. Wipe them from the inside to the outer edge. Never wipe the CD in a circular motion.
- Do not use rubbing alcohol or solvents to clean the CDs.
- Do not expose the CDs to heat or direct sunlight.
- Do not write or put stickers on CD.



You can name a CD (▷ page 55). This name then will appear on the display during CD playback.

Loading a CD into the CD drive

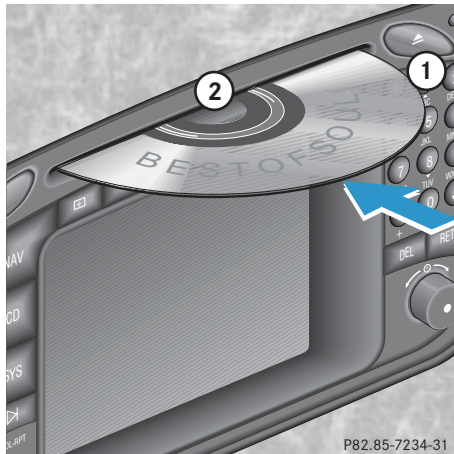

- 1 Eject button
- 2 CD drive

- ▶ Press **1** to eject any CD if necessary.
- ▶ Insert a CD as illustrated with the label facing up into **2** until it is automatically pulled in.

Changing the navigation CD (▶ page 119)



After the navigation CD has been changed, the message "Program is being loaded. Please wait." and a progress indicator are displayed. This indicates that COMAND is currently loading the program stored on the navigation CD.

Do not interrupt the loading process. Do not eject the navigation CD until the loading process has been completed.

Loading CDs in the changer

The CD changer is located on the left side of the cargo compartment (model 463) or in the glove box (models 203 and 209). It can accommodate up to 6 CDs.

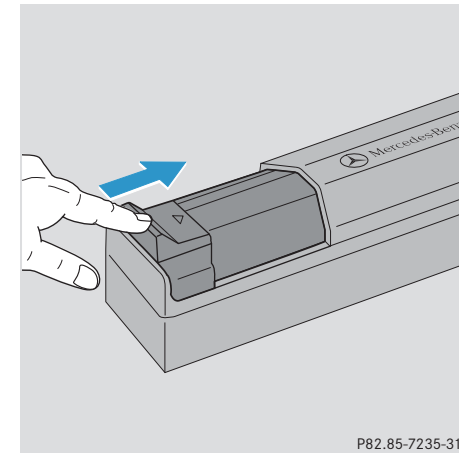

- ▶ Open the sliding door by pushing in the direction of the arrow above. Push the door completely open until it locks in the open position.

Audio

CD operation

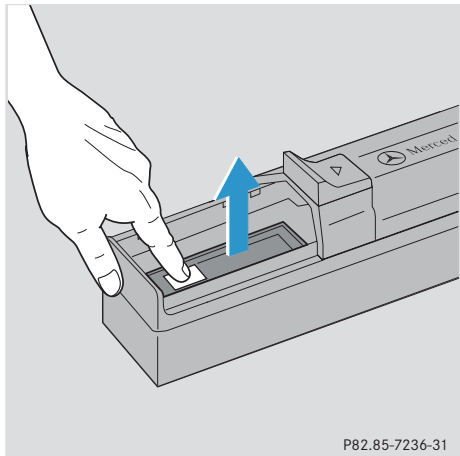

- ▶ Press the green eject button.
The magazine will slide upwards.



You can also slide out the magazine if COMAND is switched off.

However, the eject button will not function if the battery is not connected or drained.

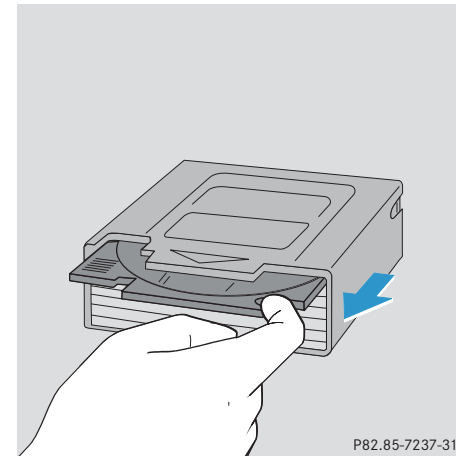

- ▶ Pull the disk tray forward until it stops.



Do not attempt to remove the tray from the magazine.

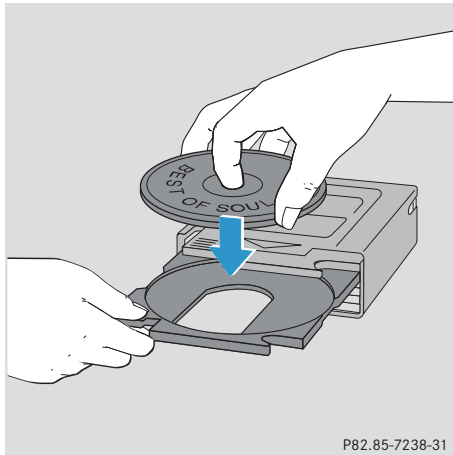

- ▶ Place a CD in the tray. The CD should be inserted with the label side up.

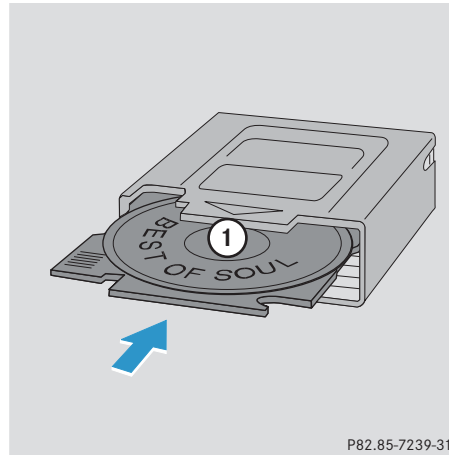

- ▶ **1** Arrow tip on the rack wall
- ▶ Push the CD tray into the magazine completely.

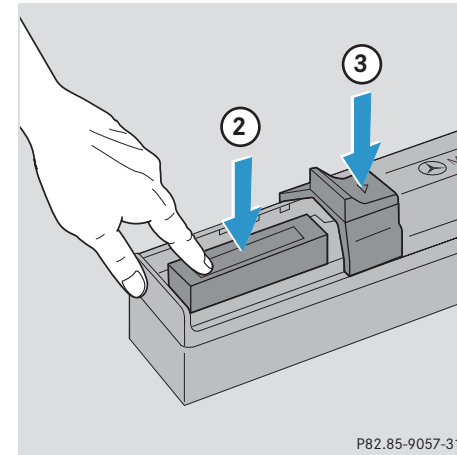

- ▶ Slide the magazine into the CD changer until it clicks into place (listen for the click).
- ▶ Press the button **3** to close the magazine compartment.



Make sure that **1** is pointing in the direction of the arrow **2**.

Audio

CD operation

Menu overview

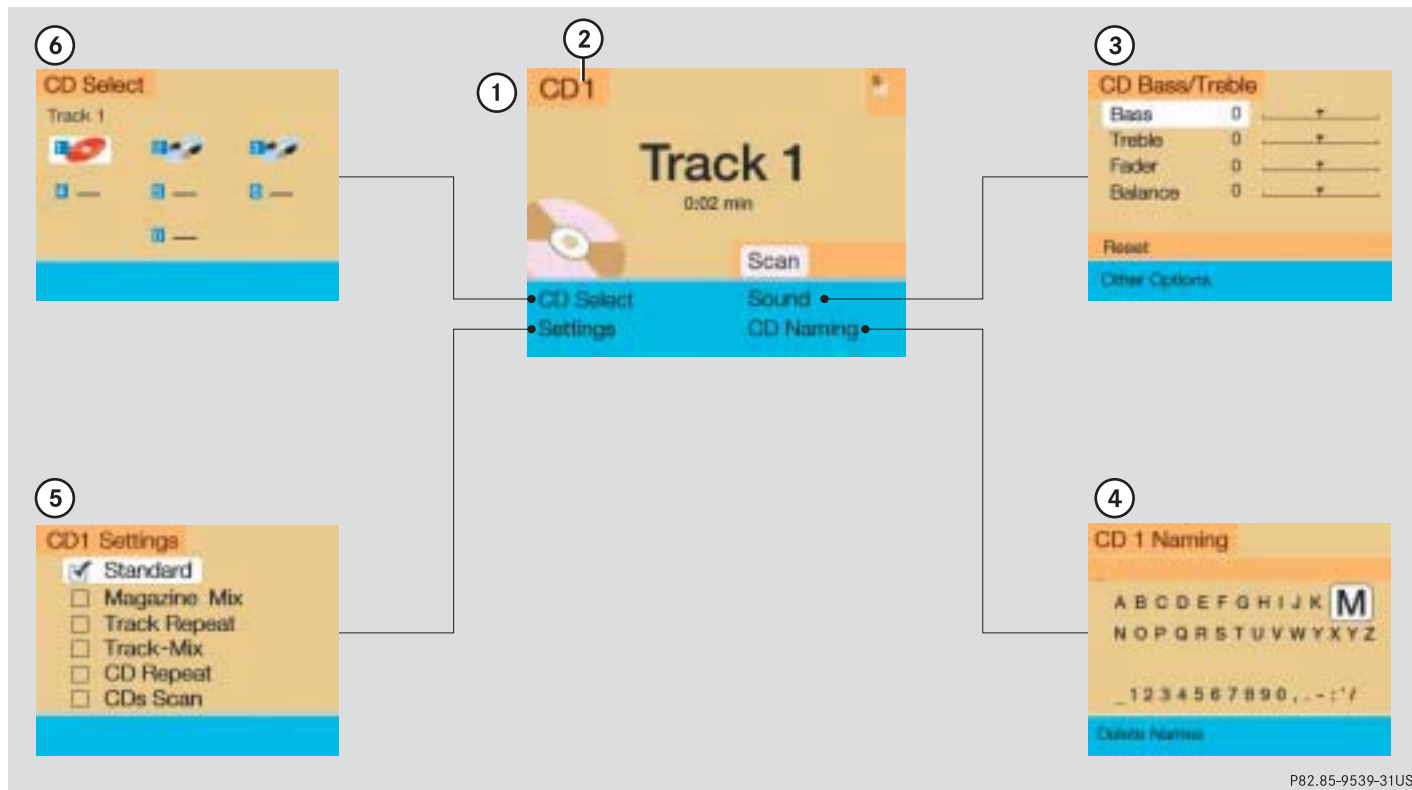

P82.85-9539-31US

	Function	Page
1	Main CD menu	50
2	Status line	
	CD 0: The CD drive is in operation	
	CD 1-6: The CD changer is in operation	
3	Main sound menu	
	Sound settings	63
4	“CD Naming” menu	
	Naming a CD	55
5	“Settings” menu	
	Selecting the playback mode	58
6	“CD Select” menu	
	Selecting a CD	53
	Track select	51

Audio

CD operation

Switching on

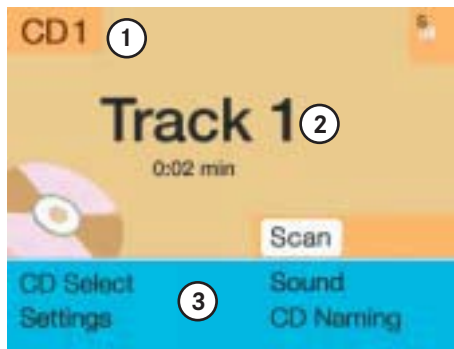

P82.85-9098-31

Main CD menu

- 1 CD function with the number of the magazine slot currently playing
- 2 Track number and elapsed playback time will appear. Also, the name of the CD will appear here, see “Naming a CD” (▷ page 55)
- 3 Scan function and menu fields

- ▶ Press **CD**.

The main CD menu will appear. Playback begins if a CD was inserted in one of the playback locations.

Playback locations are

- CD 0 CD drive
- CD 1 - CD 6 magazine slot 1 to 6 in the CD changer

- CD drive
Playback will begin with the first track on the CD.
- CD changer

The CD changer searches for inserted CDs in magazine slots 1 to 6 and plays the first track on the first CD detected.



If you switch on CD mode, COMAND will check which playback unit (CD drive or CD changer) was used last.

If there is no CD in one of the units, COMAND automatically switches to the unit with CD.

After the magazine was changed

The message “Loading CD ...” appears if the CD changer was used last.

Error messages (▷ page 60).

Switching another system on

- ▶ Press any system key, e.g. **FM AM**.

COMAND will switch to radio operation.

Track select



P82.85-9099-31

You can select a track

- with the rocker switch **◀** / **▶**
- with the number keypad
- in the “CD Select” menu

With the rocker switch **◀** / **▶**

Next track

- ▶ Press **▶** briefly.

Previous track or start of title (if more than 9 seconds of playing time has elapsed)

- ▶ Press **◀** briefly.

Select any desired track

- ▶ Press **◀** / **▶** as often as necessary.

With the number keypad

P82.85-9100-31

- ▶ Press ***** and enter the number of the track you wish to select, e.g. **2**.



If you enter a two-digit number, you must enter the second number within 3 seconds. Otherwise the system will switch to the track of the first number entered.

Audio

CD operation

You will hear the selected track

- automatically after 3 seconds
- if you press **+**.

The new track number will appear in the main CD menu.

In the "CD Select" menu



P82.85-9101-31

- ▶ Turn the right-hand rotary/push-button **+** to highlight "CD Select" in the main CD menu and press to confirm.

The "CD Select" menu will appear.

- ▶ Press **+** and the number key for the track you wish to select, e.g. **2**.

You will hear the track you have chosen

- automatically after 3 seconds
- if you press **+**.

The main CD menu with the new track number will appear.

Selecting a CD



P82.85-9102-31

You can select a CD

- with the number keypad
- in the “CD Select” menu

With the number keypad

- ▶ Press a number key, e.g. **2** to select the corresponding CD.

The message “Loading CD ...” will appear if the selected magazine slot is loaded.

Key **0** CD drive

Keys **1** - **6** magazine slots 1 to 6 of the CD changer

No CD has been inserted:

COMAND will show the messages

- “CD drive: No CD” or
- “CD changer: No CD”.



If it is not possible to play a CD selected from the CD drive (message: “Error”), COMAND will automatically load the next CD in the magazine.

Other error messages (▷ page 60).

In the “CD Select” menu

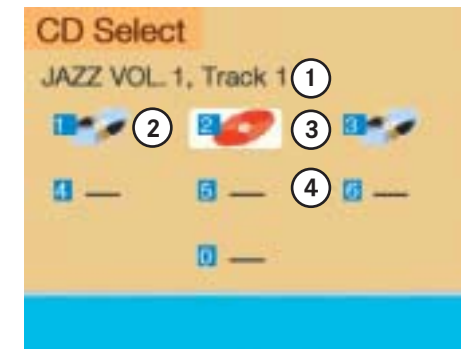

P82.85-9103-31

- 1 Current track and the name of the CD playing if this was entered previously (▷ page 55)
- 2 Current CD in red color
- 3 Magazine slots contains a CD
Position 0: CD drive
Position 1-6: magazine slots in the CD changer
- 4 Magazine slot does not contain a CD

Audio

CD operation

- ▶ Turn the right-hand rotary/push-button **1** to highlight “CD Select” in the main CD menu and press to confirm.

The “CD Select” menu will appear.

- ▶ Turn the right-hand rotary/push-button **2** to highlight the desired CD and press to confirm.

The message “Loading CD ...” will appear in **1**. Playback will then begin with track 1, the main CD menu will appear.



If magazine slots are empty, it is not possible to select them with the right-hand rotary/push-button **2**.

If you select an empty magazine slot with a number key, e.g. **4** the message “No CD” is displayed.

Fast forward/reverse



P82.85-9104-31

Fast forward

- ▶ Press **4** longer than 2 seconds and keep it depressed.

The message “Forward **4**” will appear. The display shows the current position via the time indicator display.

Fast reverse

- ▶ Press **5** longer than 2 seconds and keep it depressed.

The message “**5** Reverse” will appear.

Ending the function

- ▶ Release **4** or **5**.

Playback will resume.

CD track scan



The tracks on a CD can be scanned one after the other for 8 seconds each.



P82.85-9105-31

- ▶ Press the right-hand rotary/push-button  to activate “Scan” function. Scan will begin and “Scan” will appear in red.

Use one of these ways to switch off the function

- ▶ Press the right-hand rotary/push-button  again.
- ▶ Press  or .



The function will switch off automatically when the starting track is reached.

Playback will resume with the desired track.

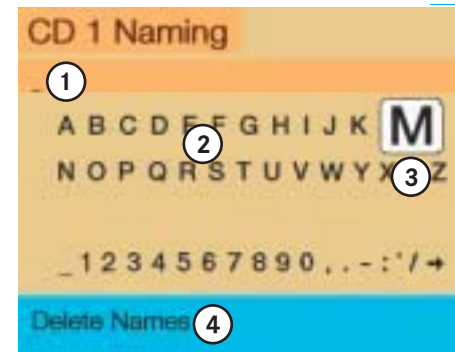

For the CD changer, it is also possible to scan all of the CDs in the magazine slots 1-6 for 8 seconds each (always track 1). Activate the function “CDs Scan” in the settings menu (▶ page 58).

Naming a CD

P82.85-9106-31

- 1 Input line
- 2 Character set (letters, digits, special characters)
- 3 Character selected appears magnified, magnified “M” is starting point
- 4 “Delete Names” function

Audio

CD operation

Naming the CDs inserted in the CD changer or CD drive

- ▶ Turn the right-hand rotary/push-button **●** to highlight “CD Naming” in the main CD menu and press to confirm.

The “CD Naming” menu will appear.

- ▶ Turn the right-hand rotary/push-button **●** to highlight the desired character and press to confirm.

The character is entered in 1.

- ▶ Repeat the last step to enter additional characters.

Deleting the character that has been entered last

- ▶ Press **DEL** briefly. The input marker moves to the left as it deletes.

Deleting a complete name

- ▶ Press **DEL** longer than 2 seconds.

Altering an entered name

- ▶ Delete one character at a time or the entire name.
- ▶ Then enter the new name.



P82.85-9107-31

- ▶ Press the right-hand rotary/push-button **●** longer than 2 seconds.

The name of the CD currently playing will appear in the main CD menu above the track number.



The CD will retain this name even if you later insert it in a different magazine slot.



The CD names are stored in the names list in alphabetical order. If the name memory is full, the following message will appear: “Attention, name memory is full. New entry only possible after deleting old one”.

Confirm the message by confirming “OK”. The input menu will appear again.

Use the “Delete Names” function to delete names from the memory.

Deleting a CD name



P82.85-9108-31

- ▶ Turn the right-hand rotary/push-button ● to highlight “Delete Names” in the main CD menu and press to confirm.

The list of CD names will appear.

Audio

CD operation

- ▶ Turn the right-hand rotary/push-button ● to highlight the name you wish to delete and press to confirm.

The name is deleted, the following entry will then move up one position.

- ▶ Press the right-hand rotary/push-button ● longer than 2 seconds to return to the main CD menu.

Paging backward/forward in the name memory (if the ▲ and ▼ symbols are shown)

- ▶ Turn the right-hand rotary/push-button ● to highlight the ▲ or ▼ symbol and press to confirm.

Audio

CD operation

Playback mode



P82.85-9109-31

- 1 Current playback mode
- 2 up to 4 functions can be selected for the CD changer only

- Playback mode active
- Playback mode is not active



You can only select one playback mode at a time.

- ▶ Turn the right-hand rotary/push-button to highlight “Settings” and press to confirm.

The “CD Settings” menu will appear.

Activating playback mode

- ▶ Turn the right-hand rotary/push-button to highlight the desired function and press to confirm.

Playback mode is active .

Standard

This function is automatically active when another CD has been selected. CD playback begins in ascending order.

Magazine Mix (CD changer only)

Select this function to play all of the tracks of all of the CDs in the magazine slots 1-6 in random order.



When CDs are played in random order, it is possible that several tracks from the same CD are played in a row.

“Magazine Mix” appears in the main CD menu.

Track Repeat

Select this function to repeat the current track until you switch the function off.

“Track Repeat” appears in the main CD menu.

Track-Mix

Select this function to play the tracks on the CD currently selected in random order.

“Track-Mix” appears in the main CD menu.

CD Repeat (CD changer only)

Select this function to repeat the current CD until you switch the function off.

“CD Repeat” appears in the main CD menu.

CDs Scan (CD changer only)

Select this function to scan all of the CDs in the magazine slots 1-6 for 8 seconds each (track 1).



This function will begin with the CD following the CD currently playing.

Scan function will end

- automatically after all CDs have been scanned
- if you press / .

Switching off playback mode

- ▶ Turn the right-hand rotary/push-button to highlight the current playback mode and press to confirm.

The checkmark disappears. Playback automatically changes to “Standard” .

Audio

CD operation

Return to the main CD menu



P82.85-9110-31



- ▶ Press **BACK**.

The playback mode selected appears in the main CD menu below the track number, e.g. “Magazine Mix”.

Audio

CD operation

Muting CD playback

- ▶ Press **MUT** while a CD is being played. CD operation is muted, the symbol  will appear in the symbol bar.
- ▶ Press **MUT** once again if you wish to continue playback. The symbol  is faded out of the symbol bar.



COMAND also cancels muting, if you

- select a different audio source, e.g. radio
- alter the volume
- press **◀** / **▶**.

Error messages



P82.85-9111-31

- 1 CD changer error messages
- 2 CD drive error messages

“No CD changer”

COMAND is unable to activate the CD changer.

- ▶ If necessary, contact an authorized Mercedes-Benz Center.

“No Magazine”

There is no magazine inserted in the CD changer.

- ▶ Load CDs into the magazine and insert it into the CD changer.

“CD Magazine empty”

There are no CDs in the magazine.

- ▶ Load CDs into the magazine and insert it into the CD changer.

“No CD”

- CD changer

There is no CD in the magazine slot selected.

- ▶ Select another magazine slot.

- CD drive

No CD is in the CD drive or the CD in the drive is not ready to play.

“Being activated”

The CD changer is not yet ready for operation.

“Reading error”

The CD that has been inserted cannot be read.

“Temperature is too high”

CD operation will switch off automatically after 3 seconds.

- ▶ Press the corresponding key to select a different audio source.

“Error”

Another error has occurred.



If an error occurs in the operation of the CD drive or CD changer, COMAND automatically switches to the other device after 3 seconds.

If it is not possible to play the CD selected in the CD changer, the system will automatically select the next CD in the magazine.

Audio

CD operation

Multifunctional display

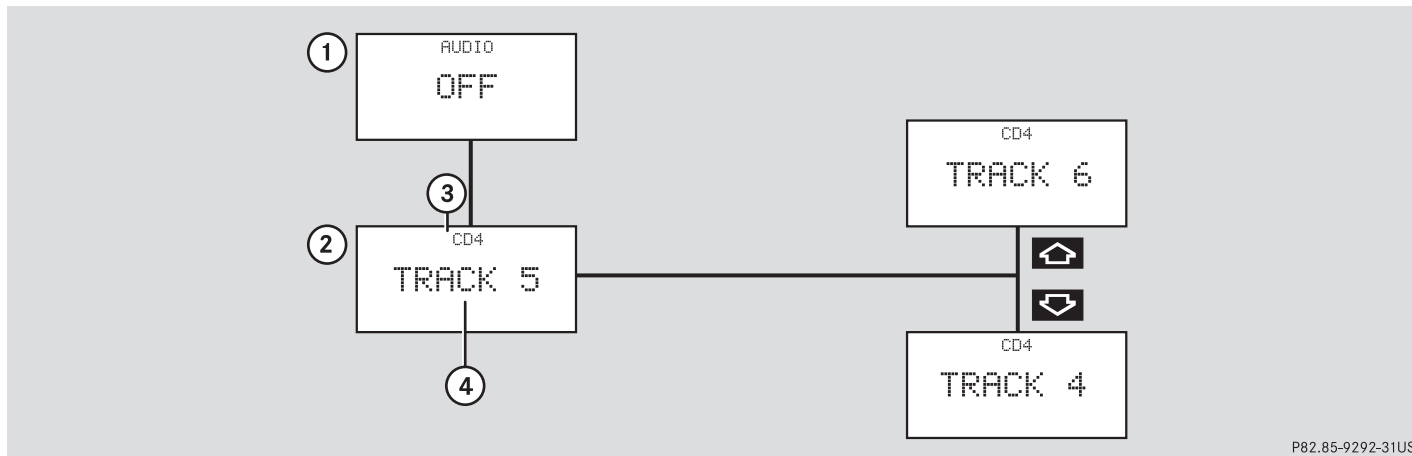

- 1** No audio source has been switched on
 - 2** CD unit is switched on
 - 3** If the CD changer is switched on, the number of the CD currently playing appears
 - 4** Track number
- ▶ Press **CD** on COMAND.
 - ▶ Press **CD** on COMAND. CD unit is switched on.
 - ▶ Press **CD** or **CD** repeatedly until display **2** appears.
 - ▶ Press **▲** or **▼** until the desired track number **4** appears.
 - ▶ Press **▲** or **▼** to display the next or previous system.

Sound settings

Adjusting sound settings

COMAND is equipped with a standard amplifier.

You can set

- the sound Bass/Treble individually
- the sound-center (Fader and Balance)
- select predefined sound optimization.

See individual audio mode descriptions for instructions on this feature.

Adjustments to the sound have a different effect on the audio and service sources. The predefined sound optimizations are available for the **audio sources only**.

Audio sources include:

- Radio FM, AM, WB
- CD (CD drive, CD changer)
- auxiliary audio source, e.g. tape deck (if connected)

You can activate the main Sound menu in the audio sources through the menu field "Sound".

Service sources include:

- Telephone
- Voice output in the navigation
- Voice recognition system

See separate operating instructions for telephone and voice recognition system.

You can activate the main Sound menu in the "NAVI Settings" menu (▷ page 181), through the menu field "Sound".

Audio

Sound settings

Activating the main sound menu

For audio sources



P82.85-9540-31US

Main sound menu

- 1 Radio (FM) is switched on
- 2 Actual sound settings (Bass/Treble)
- 3 Actual sound-center (Fader and Balance)
- 4 Slider switch to alter the value
- 5 Reset Bass/Treble to "0", and the Balance to the middle of the vehicle
- 6 Activate predefined sound optimizations

Audio

Sound settings

- ▶ Turn the right-hand rotary/push-button  to highlight “Sound” in the main menu for radio or CD operation and press to confirm.

The main sound menu will appear displaying the actual settings.



It is also possible that “AM Bass/Treble”, “WB Bass/Treble”, “CD Bass/Treble” or “AUX Bass/Treble” are indicated in **1**.

Fader defines sound-center front/back

Balance defines sound-center left/right

For service sources



P82.85-9541-31US

- 1** Volume difference
Set the difference between voice output during route guidance and an active audio source
 - “0” The volume of the audio source is not affected during voice output.
 - “10” The audio source is set very low during voice output.

- ▶ Turn the right-hand rotary/push-button  to highlight “Settings” in the main destination input menu (▷ page 122) and press to confirm.

The “NAVI Settings” menu will appear (▷ page 181).

- ▶ Turn the right-hand rotary/push-button  to highlight “Sound” and press to confirm.

The “Speech Bass/Treble” menu will appear.



No predefined sound optimizations are available for service sources.

During adjustment in the “Speech Bass/Treble” menu, COMAND will issue a repetitive voice output of “Sample” to allow you to set the settings as you prefer.

Setting Bass/Treble/Fader/Balance



P82.85-9542-31US

- Setting mode active
- Turn the right-hand rotary/push-button to move the cursor to the parameter you want to adjust and press to confirm.

The setting mode is active. The activated sound parameter is shown in red.



P82.85-9543-31US

- Turn the right-hand rotary/push-button to set the desired value.
- Press the button. The value is set. The sound feature is shown in black.

i

The sound-center adjustments affect the settings for the radio (FM/AM/WB) and CD operation.

Adjustments which are made to the navigation system will affect the voice recognition system and the telephone.

Reset the Settings to "0"

- Turn the right-hand rotary/push-button to highlight "Reset" and press to confirm.

COMAND sets treble and bass to "0" and sets the sound-center into the middle of the vehicle.

Return to the main audio menu

- Press **BACK**.

Audio

Sound settings

Activating sound optimization



P82.85-9116-31

- ▶ Turn the right-hand rotary/push-button to highlight "Other Options" in the main sound settings menu and press to confirm.

The "Other Options" (FM/AM, WB or CD) menu will appear.

- actual sound optimization



P82.85-9117-31

- ▶ Turn the right-hand rotary/push-button to highlight the desired sound optimization and press to confirm.

The new sound optimization is active .



You can only select one sound optimization at a time.

Return to the main sound menu

- ▶ Turn the right-hand rotary/push-button to highlight "Bass/Treble" and press to confirm.

Return to the main audio menu

- ▶ Press **BACK**.

Available sound optimizations

- Standard - COMAND set the sound linear for the center of the vehicle
- Speech - the emphasis is on the spoken word
- Driver-optimized - COMAND optimizes the sound for the driver's seat position
- Ambience
Small, medium and large rooms are simulated



COMAND does not offer sound optimization for the service sources.

Telephone

Important notes

Multifunction display

Telephone operation

SMS function

Emergency call

Service numbers

Telephone

Important notes

Important notes

In chapter “Telephone”, you will find detailed information regarding the telephone*, including emergency call, SMS function and service numbers.

Warning



Some jurisdictions prohibit the driver from using a cellular telephone while driving a vehicle. Whether or not prohibited by law, for safety reasons, the driver should not use the cellular telephone while the vehicle is in motion. Stop the vehicle in a safe location before answering or placing a call.

If you nonetheless choose to use the cellular phone while driving, please be sure to pay attention to the traffic situation at all times. Use the cellular phone¹ only when the traffic situation allows.

Never operate radio transmitters equipped with a built-in or attached antenna (i.e. without being connected to an external antenna) from inside the vehicle while the engine is running. Doing so could lead to malfunction of the vehicle’s electronic systems, possibly resulting in an accident and personal injury.

¹ Observe all legal requirements



Radio transmitters, such as a portable telephone or a citizens band unit should only be used inside the vehicle if they are connected to a separate exterior antenna that has been approved by Mercedes-Benz.

- Please read the chapter “Telephone” first before attempting to operate your telephone.
- Always drive with extreme caution when you operate the telephone hands-free.
- For safety reasons, you should not use the mobile telephone handset to make a call while driving the vehicle.

If the signal strength is very weak (display in the symbol field of all menus):

Wait until reception improves before making a call.

- Close the windows and reduce all outside noise as much as possible when you use hands-free operation.
- A brief disconnection from the cellular network is not a malfunction, as this can occur when the network switches areas. The phone will automatically try to sign on to a network again.
- If the message “Locked. Please enter code” appears, enter the unlock code to enable all telephone functions (▷ page 78).
- If a menu other than the telephone menu is displayed on the COMAND screen, the display will change if an outgoing call is sent out via the multi-function steering wheel.

In the following situations, it is not possible or not yet possible to use the telephone:

- The telephone is already unlocked but is not or not yet registered in the network.

The message “No Service” appears. The telephone will try to register into an existing network. If the network is available, the telephone will be ready for use.

The above message also appears

- if the network is no longer available due to weak signals
- if you try to make a call (message appears for 8 seconds)

- The message “Telephone is being activated. Please wait.” appears.

COMAND prepares the telephone for use. Select other system functions, e.g. radio, by pressing the corresponding button or wait until the telephone is active.

- One of the two messages “No telephone” or “Telephone not connected” appears.

Please connect the telephone.

- The message “Telephone defective” appears.

Please contact an authorized Mercedes-Benz Center.

Telephone

Important notes

In the following situation, it is not yet possible to use the functions “Dial number from phone book”, “Redial” and “Speed-dial”:

- The mobile telephone has been plugged into its holder correctly, the COMAND operating unit has been switched on and the phone book download function has been actuated (see telephone operation guide).

Once the download process has been completed, the above functions become available.

It is not possible to make a call when one of the following messages appears:

- “System busy, redial?”

Dialing has failed because system is busy.

- “No service, redial?”

Dialing has failed because network cannot be received.

- “Phone off”

Tele Aid is active, the telephone function will switch on automatically after Tele Aid is ended.

Multifunction display

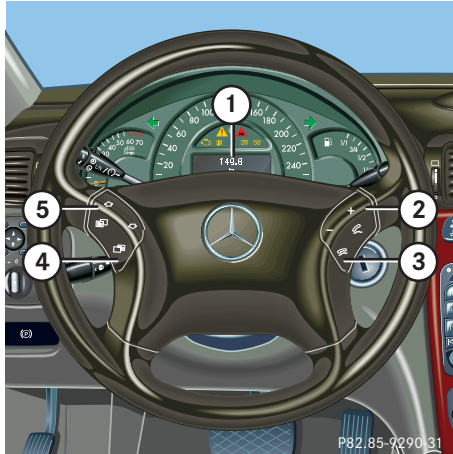

- Turn the electronic key in the steering lock to position “1” or “2”, refer to vehicle operating instructions.

Function

Page

- 1 Multifunction display on the speedometer

Using the control system

- 2 Adjusting the dial/idle tone volume during a call

— lowering

+ raising

- 3 To make a call

 Accept an incoming call 79

Start dialing operation 85

Activate the redial memory 91

 End a call 79

Interrupt dialing 83

The message READY appears

Function

Page

- 4 Changing from system to system, displaying network provider

 next

 previous

- 5 Pages through the phone book in alphabetical order

 forward

 backward

Telephone

Multifunction display

Display overview

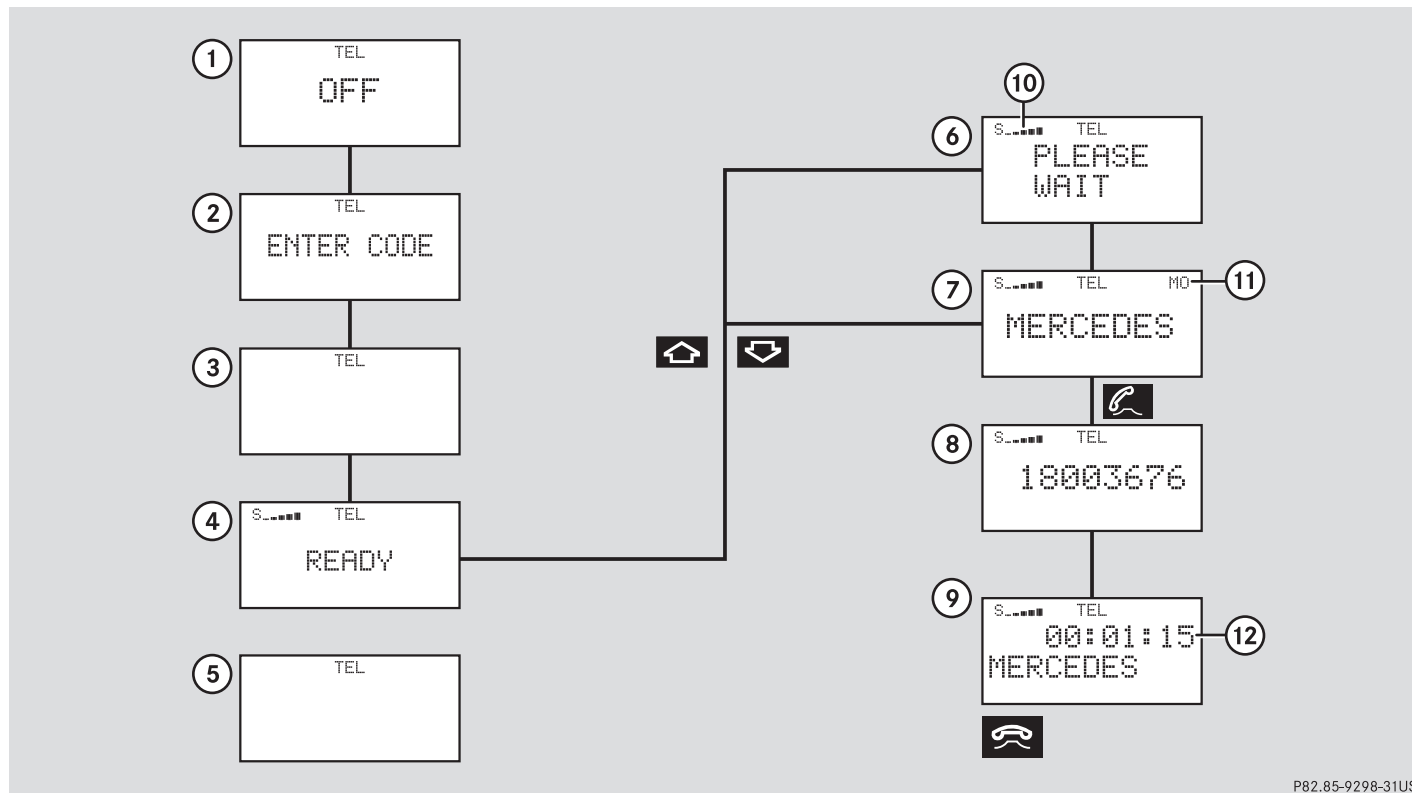

P82.85-9298-31US

Telephone

Multifunction display

Function	Page
1 The telephone is switched off Switching telephone operation on	78
2 Entering the unlock code	78
3 The system is searching for the corresponding network	78
4 The telephone is ready for use	85
5 The vehicle is currently outside the transmission or reception range	

Function	Page
6 Phone book is empty and/or has not been loaded into the COMAND telephone memory	85
7 Name selected from the phone book	85
8 Dialing begins	86
9 Dialing is completed and the name is displayed. The display will remain until you end the call	86

Function	Page
10 Reception strength is indicated by up to 5 bars for a connected and functional telephone.	79
11 Number of the memory location and the name stored here	85
12 Call time	86

Telephone

Telephone operation

Telephone operation

Quick reference

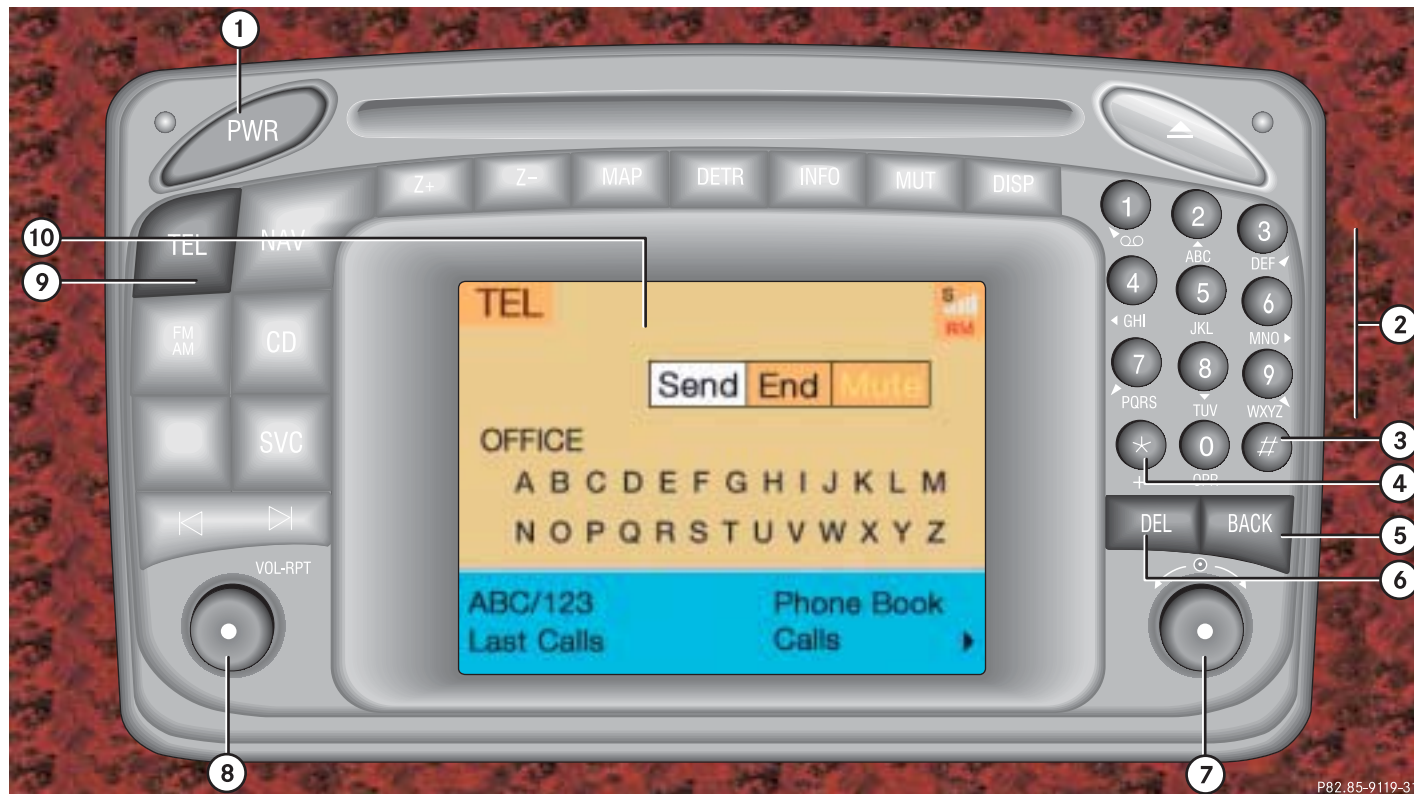

Telephone

Telephone operation

Function	Page
1 Switching the COMAND on/off	12
2 Entering the unlock code	78
Entering a telephone number	82
Speed-dialing (only with COMAND)	95
Quick-dialing (for the first 10 memory locations)	97
Entering the emergency call "9-1-1"	107
3 Subsequent dialing	84
4 Subsequent dialing	84
5 Calls the previous menu, unless the main telephone menu is displayed	
6 Deletes the last digit or the whole entry if the unlock code or a phone number are entered	83

Function	Page
7 Turning	
Highlights a menu field, a list entry, or a symbol	
Pressing	
Activates a sub-menu, confirms an entry/selection	
• "Send" is highlighted	
Begin dialing	
• "End" is highlighted	
Ends the call	
• "Mute" is highlighted	
Switches off the microphone of the hands-free telephone	

Function	Page
8 Sets the volume for hands-free operation of the telephone (during a call)	80
9 Switching the telephone operation on/off	78
10 Color screen with main telephone menu	

Telephone

Telephone operation

Menu overview

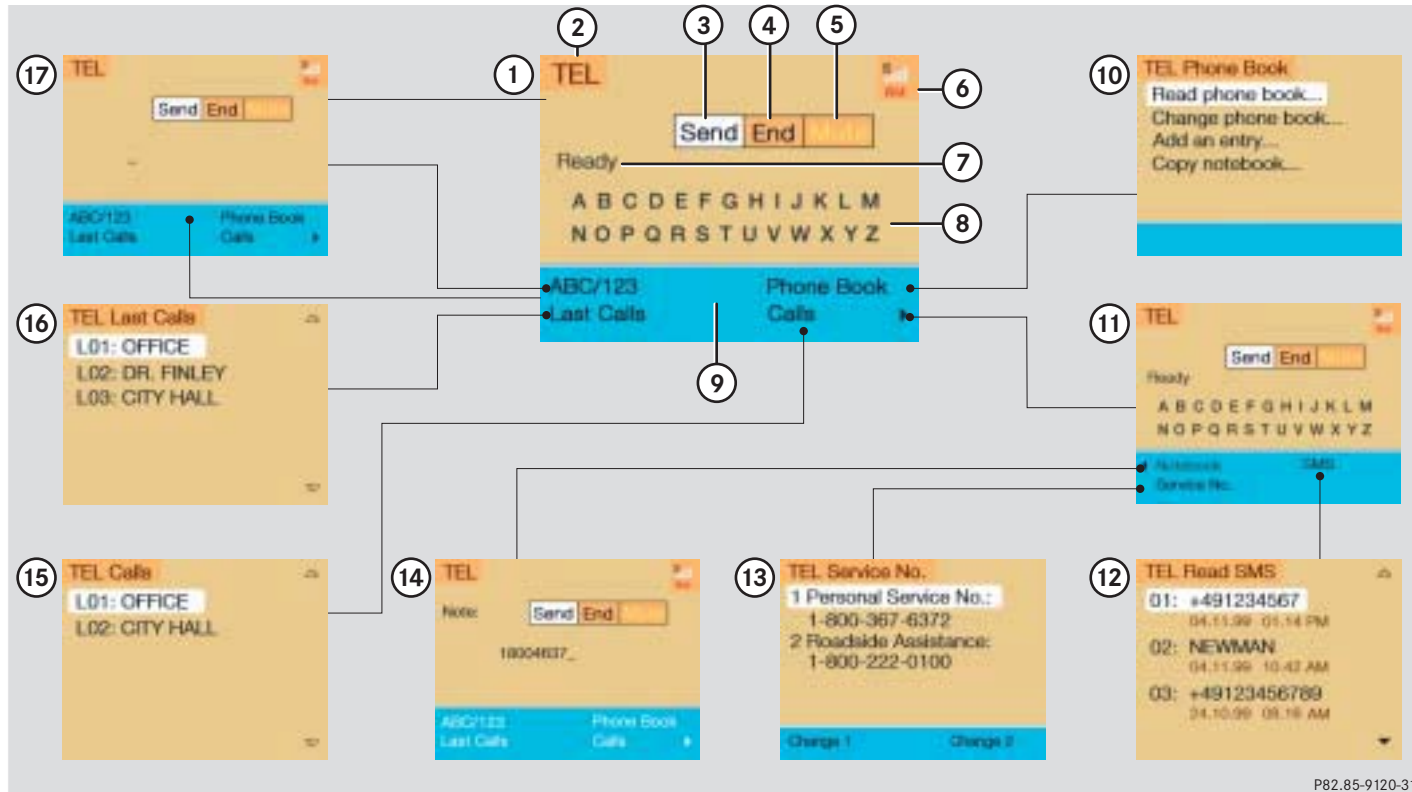

P82.85-9120-31

Telephone

Telephone operation

Function	Page
1 Main telephone menu	78
2 Telephone system is active	78
3 Accepting a call using COMAND	80
Begin dialing	83
4 Ending a call	84
5 Microphone mute	80
6 Reception strength is indicated by up to 5 bars for a connected and functional telephone	103
 Incoming SMS message	103
RM ROAM indicator	
RM in black - using a home type system	
RM in red - using a non home type system	

Function	Page
7 Input line	
8 Alphabet to enter the name	99
9 Menu fields to activate sub-menus	80
10 "Phone book" selection menu is activated when the input line 7 is empty	87
Phone book with names is activated according to input of up to 3 letters	87
11 Main telephone menu with other menu fields is activated via the symbol "▶"	
12 SMS list	104
Reading or deleting an SMS message	
13 "Service Number" menu	108
Selecting a service number for an outgoing call or changing a service number	

Function	Page
14 Notebook, noting a telephone number	97
Dialing from the notebook	97
15 "Calls" function	94
The last incoming calls are stored	
16 Redial memory, the last 10 numbers (L01-L10) dialed are stored	93
L01 last number or name dialed	
L01-L10 numbers or names dialed previously	93
17 Telephone menu for entering telephone numbers	82
Switch back to the main telephone menu via the "ABC/123" menu field	

Telephone

Telephone operation

Switching telephone operation on

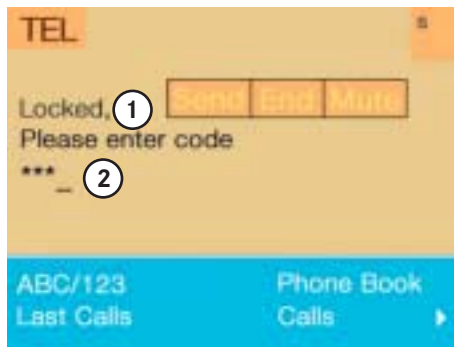

- 1 Status line, telephone is not yet logged onto network
- 2 Input line for unlock code

- ▶ Press **TEL**.
The menu to enter the unlock code will appear.

Entering the unlock code

- ▶ Use the number keys **1** through **0** to enter the unlock code.

Asterisks instead of digits will appear in the input line.

If entered code is correct and the phone is registered in a network, the phone is ready for use.



Your unlock code prevents unauthorized persons from using your telephone. Be sure to memorize this code, a three digit number, carefully.

Timeport phones use a three-digit code. V60 phones use a four-digit code. The head unit will unlock the phone using the first three digits of the four-digit V60 unlock code.

If you enter an incorrect code, the system returns to the menu for entering the unlock code.



You must always enter the unlock code when you switch on the telephone the first time (if phone is in locked mode).

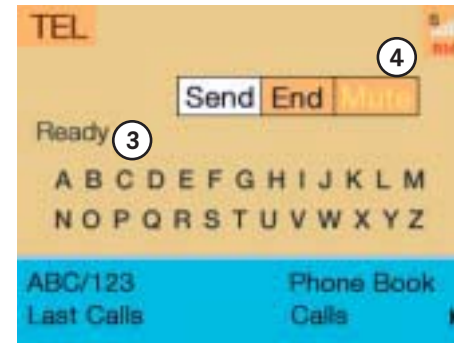

P82.85-9122-31

Ready for operation display

- 3 Telephone is ready for operation, "Send" is highlighted
- 4 Reception strength, indicated by up to 5 bars
RM appears, if the telephone is not using the home system

If the phone memory has been downloaded to COMAND, the menu fields “Phone Book”, “Last Calls” and “Calls” will be available.

If the memory was not downloaded, the menu fields will be dimmed out.

Outgoing calls (▷ page 82).

Switching telephone operation off

Use one of these ways

- ▶ When the telephone is connected to the coiled cord, press **TEL** on the COMAND control unit.
or
- ▶ When the telephone is in portable mode, press **PWR** on the phone.

Incoming call

Accepting the call at the multifunction steering wheel

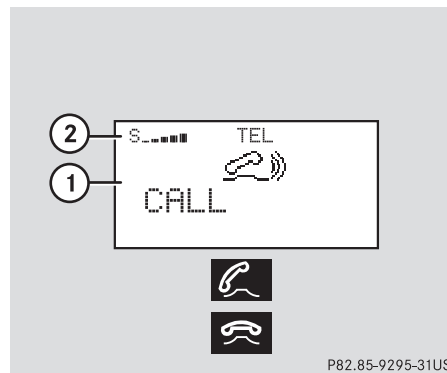

- 1 CALL**
The system detects an incoming call, the phone rings
- 2 Reception strength**
The more bars appear, the stronger the signal of the cellular network

Telephone

Telephone operation

Accepting a call

- ▶ Press .

Audio source is automatically muted.



You can also accept a call, if another display, e.g. navigation, is shown on the multifunction display.

Ending a call

- ▶ Press .

The main telephone display appears.



Communication between the multifunction display and the COMAND screen:

If different systems appear, the changes made to COMAND will have no effect on the driver information display.

- Press the COMAND key **TEL** to switch to the telephone functions.

Telephone

Telephone operation

Accepting a call using COMAND



P82.85-9123-31

- 1 “Call”
The system detects an incoming call, the phone rings.
- ▶ Press the right-hand rotary/push-button  to confirm the “Send” button.

The display will change to the call menu. An active audio source will be muted.





P82.85-9124-31

Call menu

- 2 “00:01:21 h”
The call time appears
 - 3 Phone number
-  No telephone menu is shown on the screen
 - first press **TEL**
 - then you can accept or refuse the call.

Switching the microphone for the hands-free telephone off

- ▶ Turn the right-hand rotary/push-button  to highlight the “Mute” button and press to confirm.
- ▶ Press the right-hand rotary/push-button  again to cancel muting.

Setting the volume for hands-free operation

Raising the volume

- ▶ Turn the left-hand rotary/push-button  to the right.

Lowering the volume

- ▶ Turn the left-hand rotary/push-button  to the left.

Refusing or ending a call

Use one of the three ways:

- ▶ Press the right-hand rotary/push-button  to confirm the “End” button.
- or
- ▶ Press **TEL**.
- or
- ▶ Press **BACK**.

Accepting an incoming call using the mobile telephone handset

The telephone is located in the storage compartment under the armrest. See your vehicle’s operating instructions.

- ▶ Press the right-hand rotary/push-button  to confirm the “Send” button.
- ▶ Remove the telephone from its cradle and conduct your call.

The hands-free operation will switch off.

Ending a call

- ▶ Put the phone back in its cradle.

Telephone

Telephone operation

Warning



Some jurisdictions prohibit the driver from using a cellular telephone while driving a vehicle. Whether or not prohibited by law, for safety reasons, the driver should not use the cellular telephone while the vehicle is in motion. Stop the vehicle in a safe location before answering or placing a call. If you nonetheless choose to use the cellular phone while driving, please be sure to pay attention to the traffic situation at all times. Use the cellular phone¹ only when the traffic situation allows.

¹ Observe all legal requirements

Telephone

Telephone operation

Outgoing calls

You can use the following functions:

- Dialing a telephone number (▷ page 82)
- Dialing a number from the phone book (▷ page 85)
- Redial (▷ page 91)
- Dialing from calls list (▷ page 94)
- Speed-dialing (only with COMAND) (▷ page 95)
- Dialing a telephone number from the notebook (▷ page 97)
- Emergency call (▷ page 106)

Dialing a telephone number

Entering a telephone number

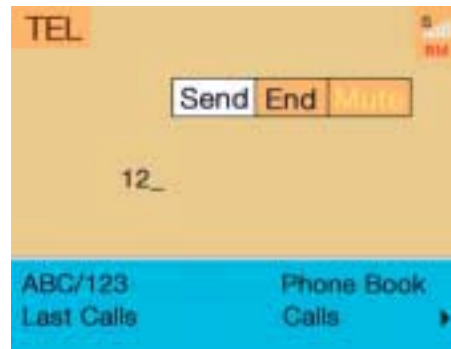

- ▶ Press **TEL**.

The main telephone menu will appear.

- ▶ Use the number keys **1** through **0** to enter the telephone number.

The menu changes when the first digit is entered.

Correcting input

To correct only the last digit

- ▶ Press **DEL** briefly.

To correct the whole entry

- ▶ Press **DEL** longer than 2 seconds.

Begin dialing



P82.85-9126-31

- ▶ When the “Send” button is highlighted, press the right-hand rotary/push-button ● to confirm your input.

Dialing will begin. If a name is associated with the phone number stored in the phone book, the name appears on the screen.

COMAND will mute an active audio source.

Telephone

Telephone operation

Interrupt dialing

Use one of the three ways:

- ▶ Press the right-hand rotary/push-button ● to confirm the “End” button.

or

- ▶ Press **TEL**.

or

- ▶ Press **BACK**.

Telephone

Telephone operation

Conducting a call

When the call is initiated, the call time appears in the screen.



P82.85-9127-31

Ending a call, use one of the three ways:

- ▶ Press the right-hand rotary/push-button  to confirm the “End” button or call has been finished by the other party.
- or
- ▶ Press **TEL**.
- or
- ▶ Press **BACK**.

Subsequent dialing

Transmitting other dial tones:

- ▶ During a call you can press the number keys **1** through **0**, **#** and *****.
- The numbers dialed will appear in the menu for 10 seconds after the last key is pressed (subsequent dialing display).



During a conversation, you can enter a telephone number in the notebook or edit an existing one (▷ page 97).

Dialing a number from the phone book

Dialing using the multifunction steering wheel

In order to use this feature, the phone book must have previously been downloaded to the COMAND memory. This is performed automatically each time the portable phone is connected to the coiled cord.

The telephone is ready for operation (▷ page 78).

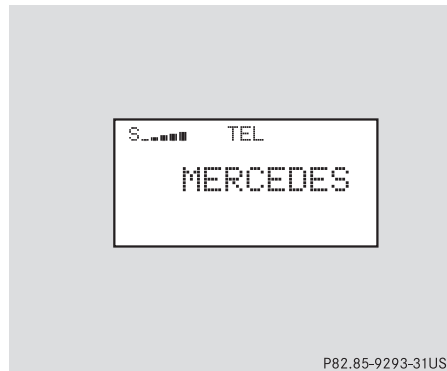

- ▶ Press or as often as necessary until the telephone mode appears in the multifunction display.

If ENTER CODE appears, enter your unlock code first (▷ page 78).

The message NO ENTRY appears when the portable phone has been put into the cradle and no entries are stored in the phone book.

Telephone

Telephone operation

- ▶ Press or .

You are paging the phone book backwards or forwards in alphabetical order. Name and memory location appear.

or

- ▶ Press or longer than 2 seconds.

You are scrolling through the phone book very quickly.

The name that is selected appears in the display.



If you do not wish to place a call, press . The process will be cancelled and the message READY appears again.

Telephone

Telephone operation

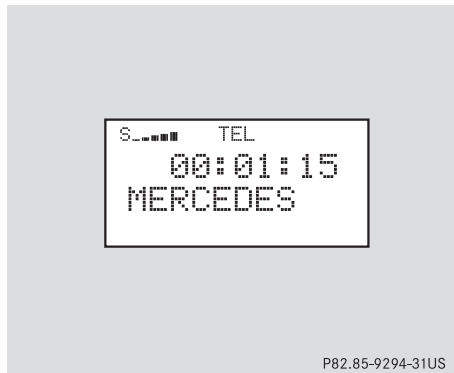

- ▶ Press  when desired name appears in the display.

The telephone number is dialed.

The message DI ALI NG appears in the display. COMAND will mute an active audio source.

When the call is initiated, the call time appears in the display. The name will reappear.

- ▶ Press  to end the call.

The message READY will reappear. The audio source will switch on again.



Phone numbers are stored in the phone book according to memory locations. A memory location starts with “M”.

Memory locations available: M01 - M99

Dialing with COMAND

Opening phone book with names

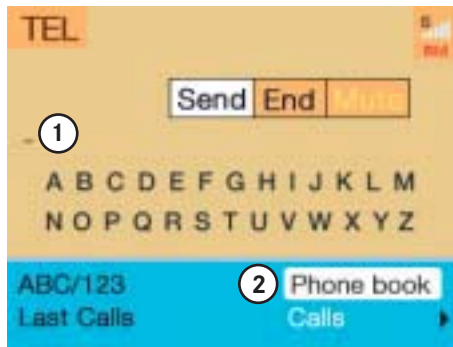

P82.85-9130-31

- 1 Input line
- 2 Activating “Phone book” selection menu (no input in 1) or opening the phone book page (▷ page 88)

- ▶ Enter up to 3 letters by highlighting them one by one with the right-hand rotary/push-button ● and press to confirm.

The input appears in 1.

- ▶ Turn the right-hand rotary/push-button ● until 2 is highlighted and press to confirm.

or

- ▶ Press the right-hand rotary/push-button ● longer than 2 seconds after input of the last letter.

The relevant page of the phone book will appear.

If the input line is empty

- ▶ Turn the right-hand rotary/push-button ● until 2 is highlighted and press to confirm.

The “Phone book” selection menu will appear.

Telephone

Telephone operation

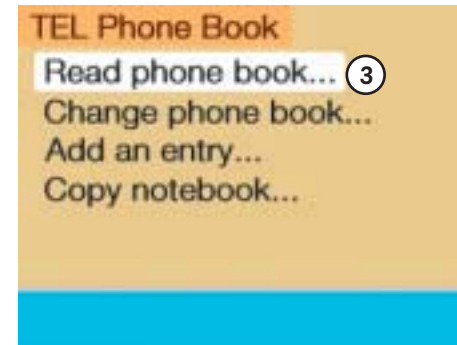

P82.85-9131-31

“Phone Book” selection menu

3 Opens the first page of the phone book (names)

- ▶ Press the right-hand rotary/push-button ● and confirm “Read phone book...”.

The first page of the phone book will appear.

Telephone

Telephone operation

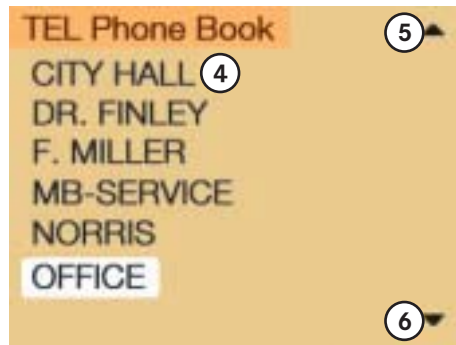

P82.85-9132-31

Phone Book page (names)

- 4 Highlighted entry, sorted alphabetically
- 5 Page back in the list
- 6 Page forward in the list



The phone book stored in the phone memory is being downloaded.

- ▶ Turn the right-hand rotary/push-button ● to highlight the desired entry and press to confirm.

The main telephone menu appears, indicating the selected name.



P82.85-9133-31

Begin dialing

- ▶ Press the right-hand rotary/push-button ● to confirm the “Send” button.

The “End” button is highlighted.

Ending a call, use one of the three ways:

- ▶ Press the right-hand rotary/push-button  to confirm the “End” button or the call has been finished by the other party.

or

- ▶ Press **TEL**.

or

- ▶ Press **BACK**.

Opening phone book (phone number)

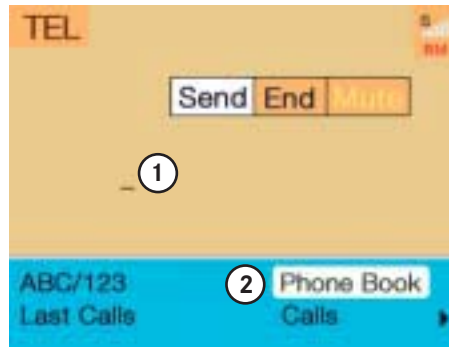



P82.85-9134-31

- 1 Input line
 - 2 Activates “Phone book” selection menu (no input in 1) or opens the relevant phone book page
- ▶ Turn the right-hand rotary/push-button  to highlight “ABC/123” and press to confirm.

The menu for entering the phone number will appear.

Telephone

Telephone operation

- ▶ Use the number keys  through  to enter up to 2 digits one by one.

The input appears in 1.

- ▶ Turn the right-hand rotary/push-button  until 2 is highlighted and press to confirm.

or

- ▶ Press the right-hand rotary/push-button  longer than 2 seconds after input of the last digit.

The relevant page of the phone book will appear.

Telephone

Telephone operation

If the input line is empty

- ▶ Turn the right-hand rotary/push-button **2** until **2** is highlighted and press the button.

The “Phone book” selection menu will appear (▷ page 87).

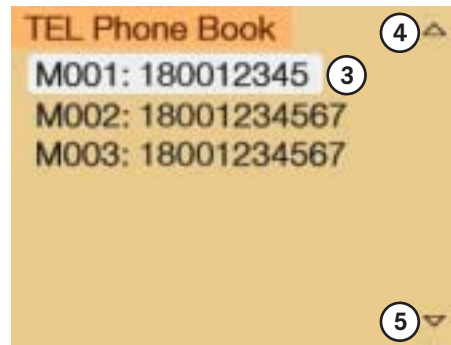

P82.85-9135-31

Phone book page (phone numbers)

- 3** Phone book entries sorted according to memory locations
Memory locations available:
M01 - M99
- 4** Page back in the list, if filled
- 5** Page forward in the list, if filled

- ▶ Turn the right-hand rotary/push-button **2** to highlight the desired entry and press to confirm.

The main telephone menu appears indicating the selected phone number and memory location.

Begin dialing (▷ page 88), then conducting a call.

Ending a call (▷ page 89).



If there is no entry in the numbers list, the message “No entry in telephone book” appears in the telephone menu.

Redial

Dialing using the multifunction steering wheel

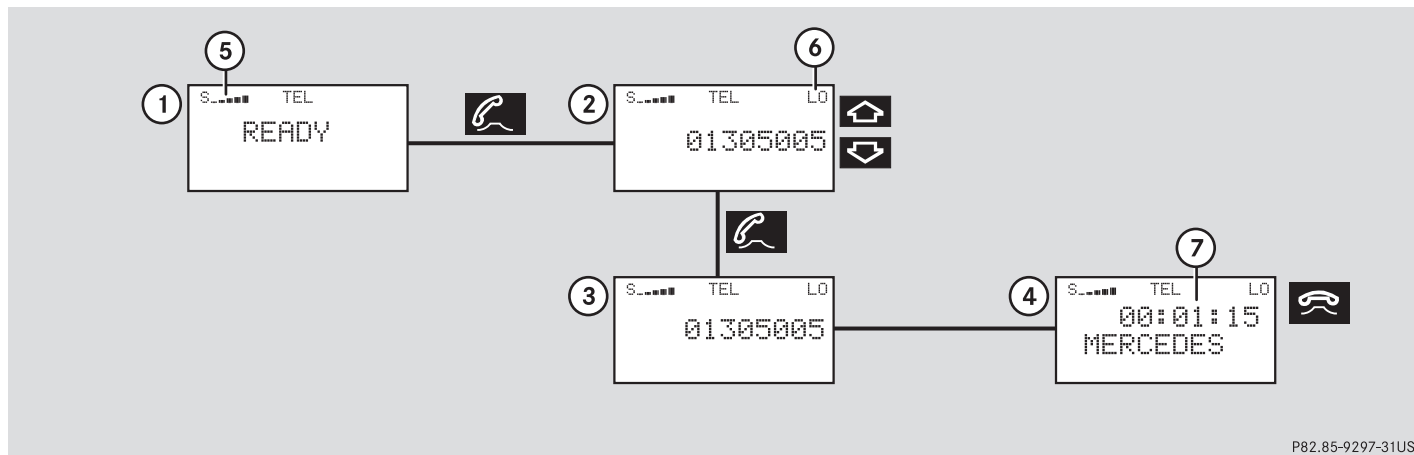

P82.85-9297-31US

- 1** The telephone is ready for operation.
- 2** Number in the redial memory
- 3** Number in the redial memory, dialing has begun
- 4** Dialing is completed. Name or still the dialed number (name has not been saved).
- 5** Reception strength - the more bars appear, the stronger the signal of the cellular network received
- 6** Memory location number, the last 10 dialed telephone numbers are stored L01, number dialed last L01 to L10, numbers dialed previously
- 7** Call time

Telephone

Telephone operation

The telephone is switched on

- ▶ Press  or  repeatedly until the corresponding telephone menu **1** appears in the display.

The telephone is ready for operation.

- ▶ Press .

The redial memory appears with the last number dialed.

- ▶ Press  or .

This allows you to page forward or backward through the redial memory.

The number selected will appear in the display with the corresponding memory location.



If you do not wish to place a call, press . The telephone display **1** appears.

- ▶ Press , when the desired number or name appears in the display **2**.



Dialing will begin **3**. When the dialing has been completed, the name **4** is displayed if the name has been stored in the phone book, otherwise you will continue to see the phone number.

The display is maintained for the duration of the call.

- ▶ Press  to end the call.

The telephone display **1** appears.



Press  or  to display the next or previous system.

Dialing with COMAND

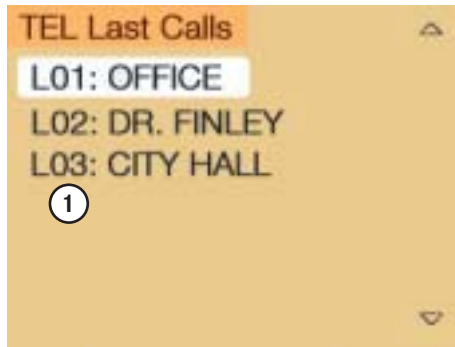

P82.85-9137-31

Redial memory list

1 Memory locations L01 - L10

L01 the last number or name dialed

L02 - L10 numbers or names dialed previously

- ▶ Turn the right-hand rotary/push-button ● to highlight “Last Calls” in the main telephone menu and press to confirm.
or
if there is a blank input line in the main telephone menu
- ▶ Press the right-hand rotary/push-button ● when the “Send” button is highlighted.
The “Last Calls” menu will appear.



If there is no entry in the numbers list, the message “No entry in list” appears in the telephone menu.

Telephone Telephone operation

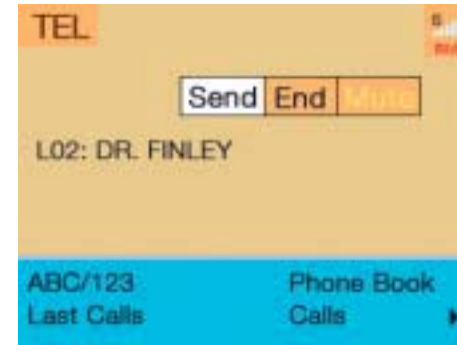

P82.85-9138-31

- ▶ Turn the right-hand rotary/push-button ● to highlight the desired phone number or name and press to confirm.
The main telephone menu appears with the desired phone number or name.

Telephone

Telephone operation

Begin dialing

- ▶ Press the right-hand rotary/push-button  to confirm the “Send” button.

The message “Dialing” will appear. The “End” button is highlighted.

Use one of these three ways, to end a call:

- ▶ Press the right-hand rotary/push-button  to confirm the “End” button or the call has been finished by the other party.

or

- ▶ Press **TEL**.

or

- ▶ Press **BACK**.

Dialing from calls list



P82.85-9139-31

Incoming calls memory

- ▶ Turn the right-hand rotary/push-button  to highlight “Calls” in the main telephone menu and press to confirm.

The incoming calls memory will appear.

- ▶ Turn the right-hand rotary/push-button  to select the desired phone number or name and press to confirm.

The main telephone menu appears indicating the number or name selected.

Begin dialing, ending a call, see above.

Speed-dialing (only with COMAND)

For all memory locations

You can enter up to 2 digits

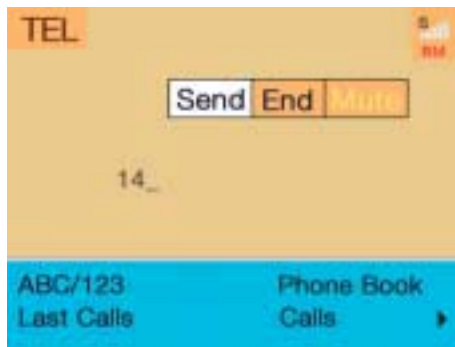

P82.85-9140-31

The main telephone menu is displayed

- ▶ Use the number keys, e.g. 1 and 4 to enter the memory location number.

Warning



If you enter “1” and confirm this memory location using one of the described ways in “Begin dialing”, the emergency number 9-1-1 (default input) will be dialed.

The 9-1-1 emergency call system is a public service. Using it without due cause is a criminal offense.

Begin dialing

Use one of these ways

- ▶ Press the last number key for more than 2 seconds.
- or

Telephone

Telephone operation



P82.85-9141-31

- ▶ Press the right-hand rotary/push-button to confirm the “Send” button.

The phone number or name will appear in the menu. The telephone will dial the phone number that has been stored in this memory location.

When the call is initiated, the call time will appear.

Telephone

Telephone operation



If the memory location called is free, the message “Memory location not allocated” will appear.

- ▶ Ending a call (▷ page 94).

Quick-dialing for the first 10 memory locations



P82.85-9142-31

The main telephone menu is displayed

- ▶ Press **2** to **0** longer than 2 seconds.

The phone number or name will appear in the menu. The telephone will dial the phone number that has been stored in this memory location.

When the call is initiated, the call time will appear.

Warning



If you press “1” the emergency number 9-1-1 (default input) will be dialed.

The 9-1-1 emergency call system is a public service. Using it without due cause is a criminal offense.

- ▶ Ending a call (▷ page 94).

Notebook

You can enter a telephone number in the notebook or edit an existing one

- during a conversation
- in the main telephone menu without having a call



P82.85-9143-31

Opening the notebook

The main telephone menu is displayed

- ▶ Turn the right-hand rotary/push-button ● to highlight the “▶” symbol and press to confirm.
Other menu fields will appear.
- ▶ Turn the right-hand rotary/push-button ● until “Notebook” is highlighted and press to confirm.

Entering the telephone number

- ▶ Press number keys 1 through 0, # and *.

Correcting input

To delete only the last digit

- ▶ Press **DEL** briefly.

To delete the whole entry

- ▶ Press **DEL** longer than 2 seconds.

Closing the notebook and storing input

- ▶ Press **BACK**.

Dialing a telephone number from the notebook

- ▶ Open the notebook.
- ▶ When the notebook phone number appears, press the right-hand rotary/push-button ● to confirm the “Send” button.

Dialing begins.



You can transfer the notebook phone number to the phone book (> page 102).

Telephone

Telephone operation

Editing the phone book

You can edit the phone book and transfer a phone number from the notebook.

- ▶ In the main telephone menu, turn the right-hand rotary/push-button ● until “Phone book” is highlighted and press to confirm.

The “Phone book” selection menu will appear.

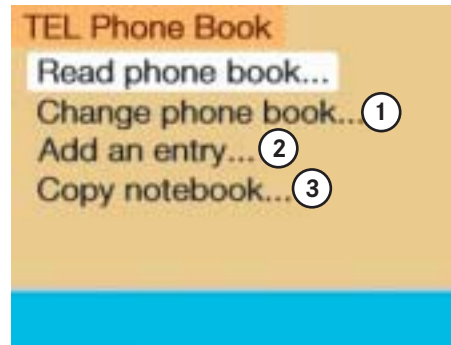

P82.85-9144-31

“Phone book” selection menu

- 1 Changing entries in the phone book
- 2 Adding entries in the phone book (> page 101)
- 3 Transferring a telephone number from the notebook (> page 102)

Changing entries in the phone book

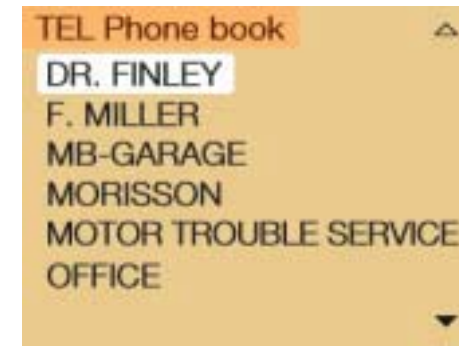



P82.85-7589-31

- ▶ Turn the right-hand rotary/push-button ● to highlight **1** and press to confirm. The phone book will either display
 - the list of names sorted alphabetically
 - the list of phone numbers sorted by memory locations.

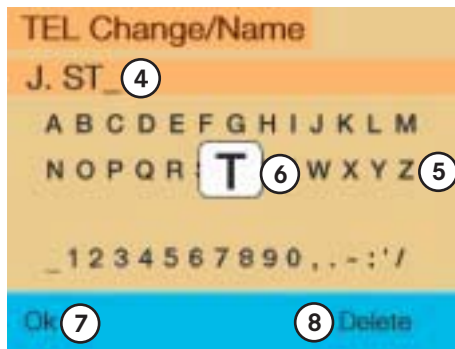
Changing a name



- 4 Phone book entry selected
 - 5 Character list
 - 6 Zoom
 - 7 Confirming the changed entry
 - 8 Deleting the entry
- Turn the right-hand rotary/push-button  to highlight the desired phone book entry and press to confirm.
- An input menu appears.

- Turn the right-hand rotary/push-button  to highlight the desired letters one by one and press to confirm.

The name will appear in the input line. The input cursor indicates the current input position.



You can enter up to 20 characters.

Correcting an input

Deleting the last digit

- Press **DEL** briefly.

Deleting the whole entry

- Press **DEL** longer than 2 seconds.



You can also select characters using the number keys. Each number key has more than one assignment. See table.

Telephone

Telephone operation

Input with number keys

- Select a character by pressing the key as listed below the corresponding number of times.

Key	Character
1	, . - 1 : ' /
2	A B C 2
3	D E F 3
4	G H I 4
5	J K L 5
6	M N O 6
7	P Q R S 7
8	T U V 8
9	W X Y Z 9
0	0
#	Blank

Telephone

Telephone operation

The selected character is automatically adopted in the input line after 2 seconds

or

- ▶ Press ***** or turn the right-hand rotary/push-button **9**.

Storing changed names

Use one of these ways

- ▶ Turn the right-hand rotary/push-button **9** until “Apply” is highlighted and press to confirm.

or

- ▶ Press the right-hand rotary/push-button **9** longer than 2 seconds to confirm the last letter of the name.

Now change the phone number.

If you do not wish to save the changes

- ▶ Press **BACK**.

Changing a telephone number



- 9** Current name or name previously changed (light brown) appears only if you have entered a name for the telephone number
- 10** Input line, highlighted when activated
- 11** Storing a telephone number in the phone book

Entering a telephone number

- ▶ Press the number keys **1** through **0**, **#** and *****.

The telephone number appears in **10**.

Correcting input

- Deleting last digit
 - ▶ Press **DEL** briefly.
- Deleting the whole entry
 - ▶ Press **DEL** longer than 2 seconds.

Storing the phone number in the phone book

- ▶ Turn the right-hand rotary/push-button **9** until **11** is highlighted and press to confirm.

The main telephone menu will appear.

Deleting an entry in the phone book



P82.85-9147-31

- 1 Name and telephone number of the entry to be deleted (light brown)
- 2 Query (light brown)
- 3 COMMAND will delete the entry from the phone book
- 4 The entry remains in the phone book

- ▶ Turn the right-hand rotary/push-button ● to highlight “Delete” in the input menu (▷ page 99) and press to confirm.

The query **2** appears. “Yes” is highlighted.

- ▶ Press the right-hand rotary/push-button ● and confirm “Yes”.

The main telephone menu appears. The entry is deleted.

If you don't want to delete the entry:

- ▶ Turn the right-hand rotary/push-button ● to highlight “No” and press to confirm.

The phonebook list will appear.

Adding an entry to the phone book

Entering a name





P82.85-9148-31

- 1 Input line
- 2 Transferring name

Telephone



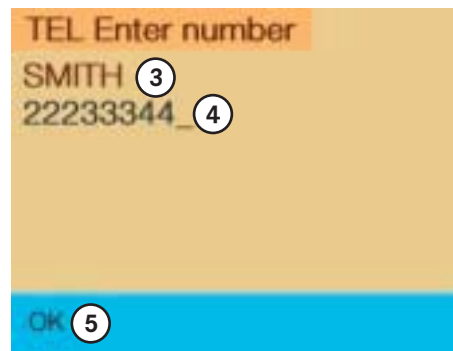

Telephone operation

- ▶ While in the selection menu (▷ page 98), turn the right-hand rotary/push-button  until “Add an entry...” is highlighted and press to confirm.
An input menu will appear.
- ▶ Turn the right-hand rotary/push-button  until the desired character is highlighted and press to confirm.
- ▶ Repeat this action.
The name will appear in the input line. Confirm the name as described under “Storing changed names” (▷ page 100).
- ▶ Now change the phone number.
Correcting an input (▷ page 99).

Entering and storing a telephone number



P82.85-9149-31

- 3 Previously entered name
- 4 Input line for phone number, entering phone number with numeric keys  to , key  and key 
- 5 COMAND stores the phone number

- ▶ Press the right-hand rotary/push-button  to confirm the input.
COMAND stores the phone number and the main telephone menu will appear.

Storing a phone number in the notebook

- ▶ While in the “Phone book” selection menu (▷ page 98), turn the right-hand rotary/push-button  to highlight “Copy notebook...” and press to confirm.
- ▶ Now you can enter a new name and phone number or edit an existing entry, and store the entry.

SMS function

With this function you can receive, read and delete short text messages¹.



COMAND may have to read in SMS messages first. The message “SMS loading...” will appear. The reading operation may take up to 30 seconds.

¹ If available from your carrier.

Activating

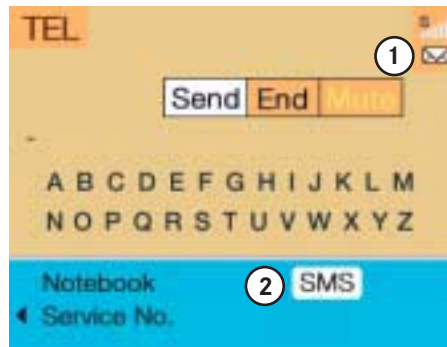



P82.85-9150-31

- 1 The symbol  will appear when a new SMS message arrives, symbol “RM” (roaming mode) that may have been displayed before will be replaced
- 2 Activates the SMS list

Telephone

SMS function

- ▶ Turn the right-hand rotary/push-button  to highlight “▶” in the main telephone menu and press to confirm. Other menu fields will appear.
- ▶ Turn the right-hand rotary/push-button  to highlight **2** and press to confirm. The SMS list will appear.

Telephone

SMS function

Reading SMS messages received

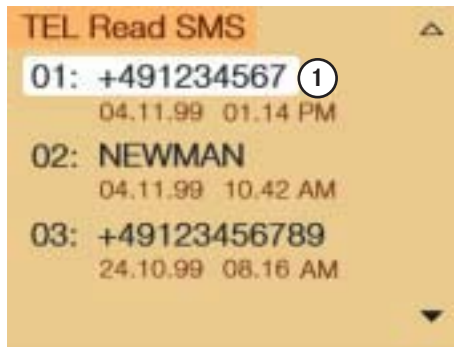

P82.85-9151-31

1 Current SMS message is highlighted, telephone number or name (if it is in the phone book), date and time appear in brown

The SMS messages (max. 10) are listed in the order when they were received.

- ▶ Use the appropriate arrow symbols to page through the list.
- ▶ Turn the right-hand rotary/push-button ● to highlight the desired SMS message and press to confirm.

The SMS message will appear.



COMAND does not display so called „chained“ SMS messages. These contain more than 160 characters. For you to be able to read these messages, the sender should send the message again in normal mode.

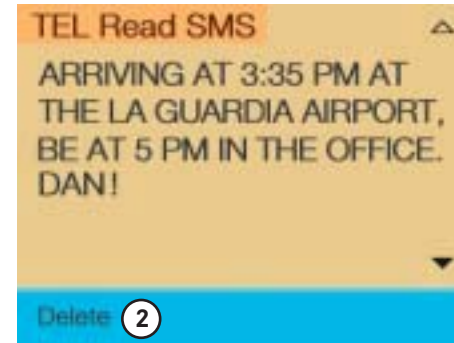

P82.85-9152-31

SMS view

2 Deleting displayed SMS message

Deleting an SMS message



P82.85-9153-31

- 1 Deletes current SMS message
- 2 SMS message is not deleted

- ▶ Press the right-hand rotary/push-button ● to highlight “Delete” and press to confirm.

The menu “Delete SMS” will appear.

- ▶ Press the right-hand rotary/push-button ● to confirm “Yes”.

If there was only one SMS message:

The message is deleted, the main telephone menu will appear.

If there are other SMS messages:

The message is deleted, the next SMS message will appear.

If you don't want to delete the SMS message:

- ▶ Turn the right-hand rotary/push-button ● to highlight “No” and press to confirm.

The SMS view will appear.



You can also delete an SMS message by pressing **DEL**.

After you have deleted the oldest SMS message, COMAND highlights the current SMS message in the list.

Telephone

Emergency call

Emergency call

You can make an emergency call to an emergency rescue station with a mobile communication network.

The emergency call will be placed as long as the corresponding mobile communication network is available. To do this, switch the telephone on if you have not already done so.



The emergency call will also be placed if the phone is locked.

Emergency calls may not be possible with all mobile phone networks or if certain network services and/or telephone functions are active. Check with your local network operating company.



This function places a call to the local 9-1-1 provider. It does not initiate a Tele Aid call.

Warning



The 9-1-1 emergency call system is a public service. Using it without due cause is a criminal offense.



If you enter “1” and press the right-hand rotary/push-button ●, the number stored in memory location “1” (default is 9-1-1) will be dialed.

Pressing or holding “1” longer than 2 seconds will also initiate the call.



It will not be possible to complete the emergency call if the cellular system is busy. The message “System busy, redial?” appears.

Take appropriate measures to alert an emergency service as soon as possible.

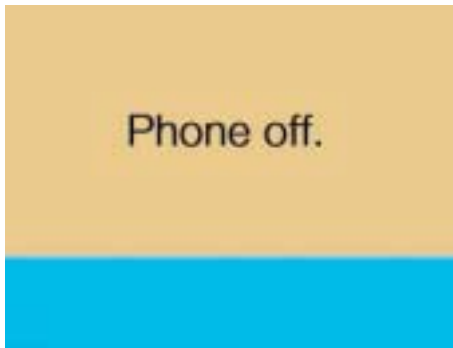

P82.85-9154-31

If there is an active Tele Aid call, the telephone main menu will disappear and you will see the message “Phone off”.

After the Tele Aid call is ended the telephone main menu will reappear.

See your vehicle’s operator’s manual.

Telephone is ready for operation



Please ensure that the number stored in the memory location is the number you want to dial in case of an emergency (default is 9-1-1).

The function will also be performed if the telephone is locked.



P82.85-9155-31

Telephone

Emergency call

Initiating an emergency call

If the telephone main menu or a memory menu is displayed

- ▶ Press number key **1** longer than 2 seconds (quick-dialing).

The telephone begins dialing, the “End” button is highlighted.

When the call is initiated, the call time will appear.

Do not place the emergency call

- ▶ Turn the right-hand rotary/push-button **1** to highlight the “End” button and press to confirm or press **BACK**.

Ending the call, use one of the three ways:

- ▶ Press the right-hand rotary/push-button **1** to confirm the “End” button.

or

- ▶ Press **TEL**.

or

- ▶ Press **BACK**.

Telephone

Service numbers

Service numbers

Calling a service number

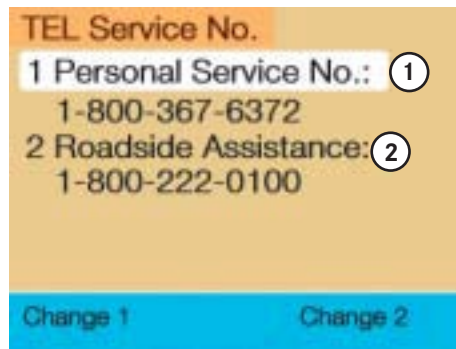

P82.85-9156-31

- 1 Personal Service Number
- 2 Number for Roadside Assistance

- ▶ Turn the right-hand rotary/push-button ● to highlight “Service No.” in the main telephone menu and press to confirm.
The menu “Service No.” will appear.
- ▶ Use the right-hand rotary/push-button ● to highlight the service you require and press to confirm.
The main telephone menu will appear.

Begin dialing

- ▶ Press the right-hand rotary/push-button ● to confirm the “Send” button.
One of the messages “Personal Service Number” or “Roadside Assistance” will appear. The “End” button is highlighted.
When the call is initiated, the call time will appear.

Use one of these three ways to end a call

- ▶ Press the right-hand rotary/push-button ● to confirm the “End” button.
or
- ▶ Press **TEL**.
or
- ▶ Press **BACK**.

Changing personal service number



P82.85-9157-31

- ▶ Turn the right-hand rotary/push-button ● to highlight “Change 1” in the “Service No.” menu and press to confirm.

The “Change Service No. 1” menu will appear.

- ▶ Enter the new service number with number keys 1 through 0.
- ▶ Press the right-hand rotary/push-button ● to confirm the service number.

The new service number is now stored in the “Service No.” menu.

Returning to the menu “Service No.”

The menu “Service No.” will appear automatically after 7 seconds

or

- ▶ Press **BACK**.



Pressing the right-hand rotary/push-button ● and inserting an empty input line will delete the personal service number.

Telephone

Service numbers

Changing the number for roadside assistance



P82.85-9158-31

- ▶ Turn the right-hand rotary/push-button ● to highlight “Change 2” in the “Service No.” menu and press to confirm.

The “Change Service No. 2” country list will appear.

Select a new country service number from the list

- ▶ Turn the right-hand rotary/push-button ● to highlight the country abbreviation you want and press to confirm.

The new service number is now stored in the “Service No.” menu.

Returning to the menu “Service No.”

The menu “Service No.” will appear automatically after 7 seconds

or

- ▶ Press **BACK**.

Navigation

Important notes

Quick reference

Destination input

Route guidance

Destination memory

Settings

Navigation

Important notes

Important notes

Warning



For safety reasons you should only enter a destination when the vehicle is stationary. When the vehicle is in motion, a passenger should enter the destination. Study manual and select route before driving.

Do not watch display screen or operate buttons while the vehicle is in motion - let voice instructions guide you. Stop at a safe location before using buttons or making corrections.

Traffic regulations always have priority over any route recommendations given.

The route calculated by COMAND is a recommendation on how the best reach your selected destination.

During route guidance, you will not receive any information on

- Traffic lights
- Stop and yield signs
- Parking or stopping zones

- One-way streets
- Narrow bridges
- Similar traffic regulation data

You should therefore always strictly observe traffic regulations while driving. Drive carefully and always obey traffic laws and road signs even if they contradict COMAND instructions.

Warning



The CD reader contains a Class 1 laser product. There is a danger of invisible laser radiation if the cover is opened or damaged.

Do not remove the cover. The CD reader does not contain any parts which can be serviced by the user. For safety reasons, have any service work which may be necessary performed only by an authorized Mercedes-Benz Center.



COMAND calculates the route with the help of data that is stored on the navigation CD.

Only use Mercedes-Benz navigation CDs. Using other navigation CDs might lead to malfunctions.

Because of changes in local traffic patterns (e.g. road works) and/or incomplete data, errors in calculation may occur.

As a result, the recommended route may deviate from the ideal route. The data stored on the CD only reflects local conditions at the time of CD production.



The CD drive can read navigation CDs and playback audio CDs.

If an audio CD is in the CD drive and **NAV** is pressed, the message “No CD available. Insert NAVI-CD type DX only” will be displayed.

- Remove the audio CD and insert a navigation CD (▷ page 119).

Navigation

Important notes



GPS (Global Positioning System) signals received make it possible to determine the current vehicle position.

Deviations from the actual position may occur

- if the reception of GPS signals is disturbed e.g. in parking garages and tunnels
- if road conditions are bad
- depending on the vehicle's condition

If the reception of the GPS signal is unavailable, you will have to manually enter the current vehicle position (▷ page 180).

If your vehicle has been transported by a car, train or ferry, COMAND needs some time to find its exact position. Moving the vehicle a few yards is typically enough to remedy this situation.

Travelling abroad

If you intend to travel through different regions or abroad, you will need the respective navigation CD.

Contact your Mercedes-Benz Center or the Client Assistance Center at 1-800-FOR-MERCEDES (1-800-367-6372) for available CDs.

- ▶ Change the navigation CD (▷ page 119).

Changing tires

Mercedes-Benz recommends that you have your tires changed by an authorized Mercedes-Benz Center.

COMAND operates based on measurements taken by wheel revolutions. When changing tires, the correct tire information must be entered for the system to operate as expected.

See calibration (▷ page 181).

Navigation

Quick reference

Quick reference



Navigation

Quick reference

	Function	Page
1	Switching COMAND on and off	12
2	Switching the navigation system on	122
3	Zooming in for more detailed map	133, 158
4	Zooming out for less detailed map	133, 158
5	Route guidance active: Switches between map and symbol display	156
	Route guidance not active:	
	Activates location map	149
6	Selecting a detour during route guidance	163

	Function	Page
7	CD drive for navigation CD or audio CD	45
	 Pay attention to regional version of navigation CD	
8	Route guidance active: Displays estimated time of arrival and current distance to destination	147
	Route guidance not active: Displays last destination driven	147

	Function	Page
9	Muting current route instructions or Switching off voice output for the duration of the current route guidance	153
10	Ejecting navigation CD	119
11	Entering destination via the map	131
12	Displaying and removing a long list entry in full in a window	138
13	Switching back to the previous menu	
14	When entering information: Deletes last character or complete entry	124

Navigation

Quick reference

	Function	Page
15	Turn to Highlight menu field, list entry or character Alter the map scale	133
	Press to Confirm entry/selection, starting function or activating submenu Activate map scale bar	133
16	Turn to During voice output: Lower (left)/raise (right) the volume	
	Press to Repeat current route instructions	

	Function	Page
17	Requesting and displaying Info Services	184
	System settings	187
18	Color screen	

Changing the navigation CD

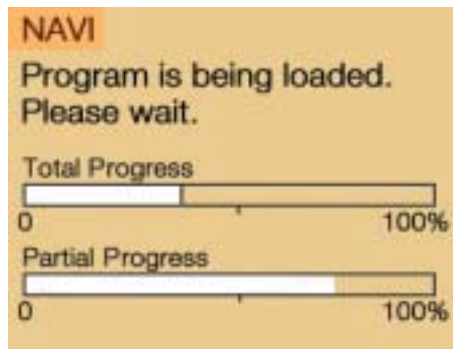

P82.85-9163-31

- ▶ Press .
- COMAND ejects the inserted navigation CD.
- ▶ Remove the CD.

- ▶ Insert another navigation CD, e.g. a regional version, with the label facing up. The illustrated message will appear. COMAND loads the program stored on the navigation CD.



Do not interrupt the loading process. Do not eject the navigation CD until the loading process has been completed.



If you do not remove an ejected CD, it will be automatically retrieved by the CD drive after 10 seconds.

The CD drive can

- read navigation CDs, or
- playback audio CDs.

Navigation

Destination input

Destination input

Menu overview

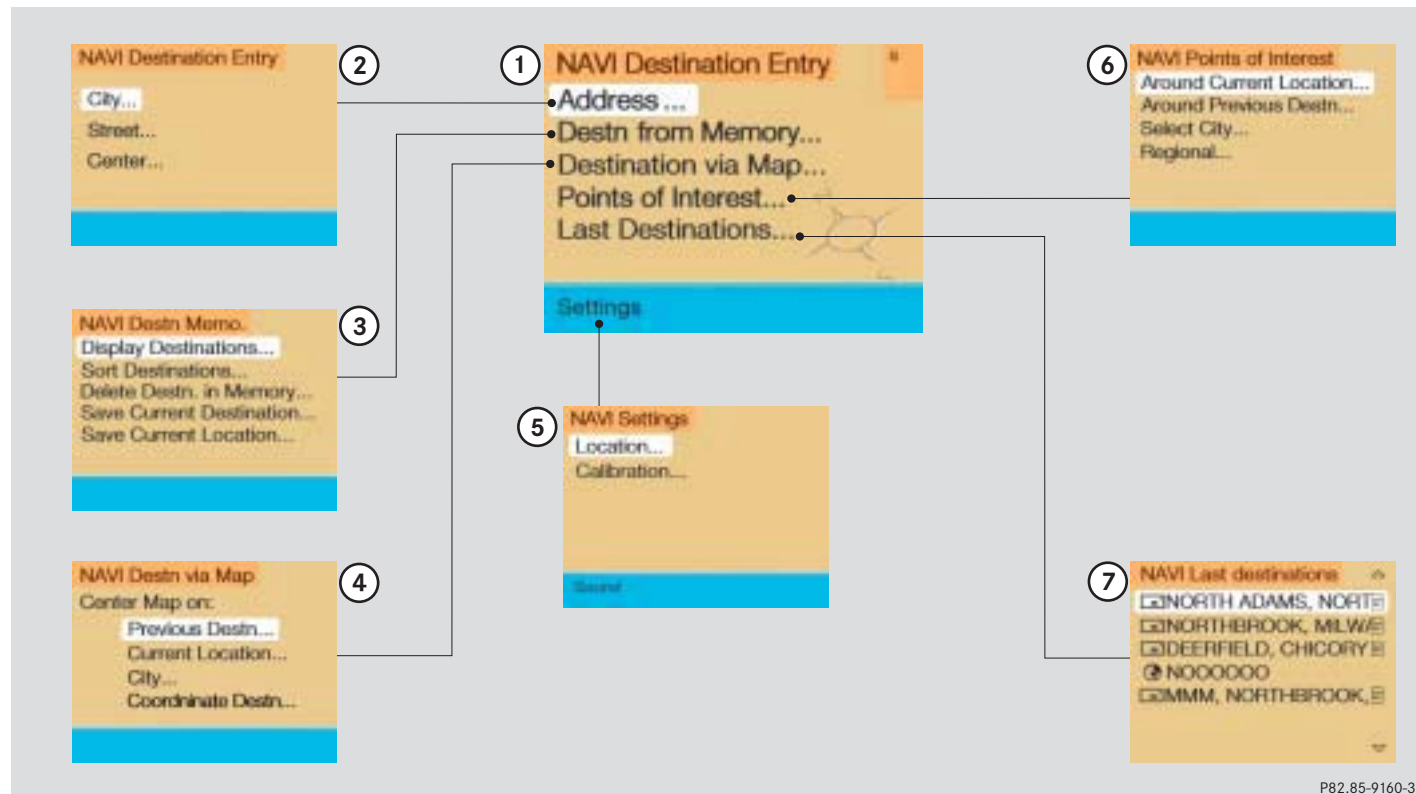

P82.85-9160-31

	Function	Page
1	Main destination input menu	
	• Entering a destination address	123
	• Retrieving a destination from the destination memory	174
	• Selecting a destination via the map	131
	• Entering Points of Interest	137
2	Main address menu	
	Entering a destination address	123
3	Main destination memory menu	
	Selecting destination from the destination memory	174

	Function	Page
4	“Destination via map” menu	
	Setting destination via location on map	131
	Setting destination via coordinates	135
5	“Settings” menu	
	Entering vehicle location	180
6	Calibrating tires	181
	“Points of Interest” menu	
	Setting destination via Point of Interest listing	137
7	Activating list of last 12 destinations for a recalculation	141

Navigation

Destination input

Switching the navigation system on

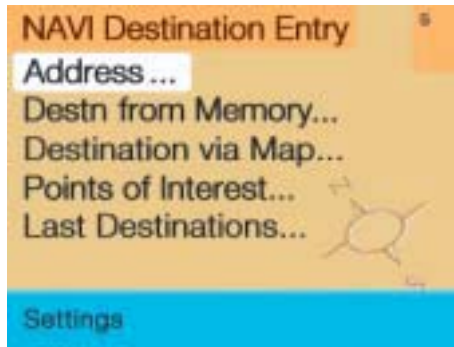

P82.85-9162-31

Main destination input menu

- ▶ Press **NAV**.

The display that appears is dependent on the last navigation function used:

Route guidance has been switched off

- the main destination input menu or
- the location map (▷ page 149).

Route guidance has been switched on

- the symbol display with an arrow indicating your driving direction (▷ page 144) or
- the map with the symbol indicating current vehicle location (▷ page 144)

Route guidance has been switched on, COMAND has been switched off for more than 2 hours

- an inquiry menu (▷ page 169)



The following message will appear when COMAND is preparing for navigation startup: “Navigation being activated. Please obey all traffic rules.”. Then, one of the 3 displays will appear.

Changing over to another system, for e.g. radio

- ▶ Press **FM/AM**.



Potential fault messages during preparation of navigation startup:

- “Navigation cannot be activated. An error has occurred”.
- “CD-Reading error. Please use another CD”.

Eject the inserted CD and insert a navigation CD.

- “No CD available. Please insert NAVI-CD type DX only”.

Insert a current DX-coded navigation CD. Using other navigation CDs might lead to malfunctions.

If the error has been eliminated, you will see the message “Navigation being activated. Please obey all traffic rules”.

Entering destination address

Select one of the following possibilities to enter a destination:

- Entering a destination address
- Selecting destination via the map (▷ page 131)
- Entering Points of Interest (▷ page 137)
- Selecting last destinations (▷ page 141)
- Selecting from destination memory (▷ page 174)

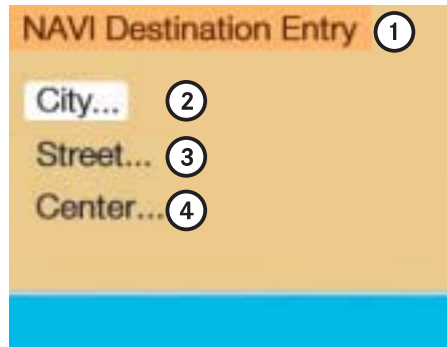

Main address menu

- 1 Info/status line
- 2 Selecting city/suburb or selecting destination that has been entered at last
- 3 Selecting a street
- 4 Selecting a city center (▷ page 130)



If you have previously entered a city/suburb, you can highlight **3** and **4**.

Navigation

Destination input

- ▶ Press the right-hand rotary/push-button  in the main destination input menu and confirm “Address”.

The main address menu will appear.

Switching back to the main destination input menu

- ▶ Press **BACK**.

Navigation

Destination input

Select city/suburb

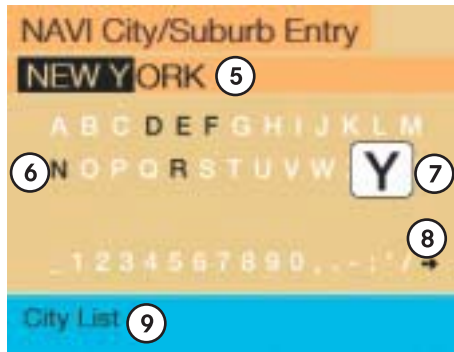

P82.85-9165-31

“City/Suburb Entry” input menu

- 5 Input line, selected characters (invers) or last city selected
- 6 Character set
- 7 Zoom
- 8 Move the insertion point one position to the right
- 9 Activate the city list

- ▶ Press the right-hand rotary/push-button  in the main address menu and confirm and confirm “City/Suburb”.

The input menu “City/Suburb Entry” will appear.

To adopt the city last selected:

- ▶ Activate the city list.

To select another city:

- ▶ Turn the right-hand rotary/push-button  until the desired letter in character set 6 is highlighted.

The zoom 7 enlarges the currently highlighted character.

- ▶ Press the right-hand rotary/push-button  to enter the character in input line 5.

COMAND supplements the new entry with additional letters so that the stored name of a city/suburb will appear.

- ▶ Enter other characters until the desired city name appears in 5.

i

For quicker input, COMAND will offer available characters from the character set 6 based on your selections and the names of the cities stored on the navigation CD.

Correcting the entry

- Last character entered
 - ▶ Press **DEL** briefly.
- All of the characters entered
 - ▶ Press **DEL** longer than 2 seconds.

Activating the city list

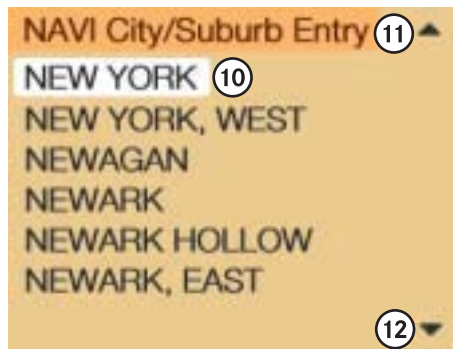

P82.85-9166-31

City list

- 10 Selected city is highlighted
- 11 Display the previous page, if ▲
- 12 Display the next page, if ▼

If the input menu “City/Suburb Entry” is displayed

- ▶ Press the right-hand rotary/push-button ● longer than 2 seconds.
- or
- ▶ Turn the right-hand rotary/push-button ● to highlight menu field 9 with and press to confirm.

The city list will appear.

You can now do the following in the city list:

- Confirm the city/suburb that has already been highlighted
- Select another city/suburb
 - ▶ Turn the right-hand rotary/push-button ● until the desired city/suburb is highlighted.

- Display the previous/next page
 - ▶ Turn the right-hand rotary/push-button ● to highlight one of the arrows 11 or 12.
 - ▶ Press the right-hand rotary/push-button ●.

Confirming the city

- ▶ Press the right-hand rotary/push-button ● longer than 2 seconds.

A selection menu will appear.



If several options of a city/suburb are available, another menu will appear where you must make and confirm your desired selection.

Navigation

Destination input

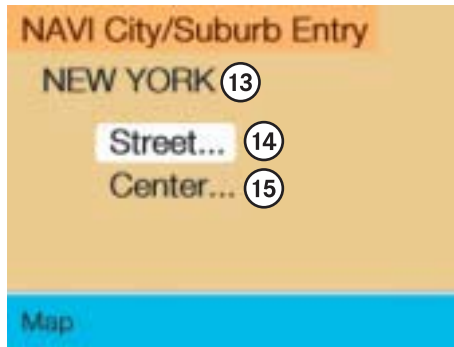

- 13 City previously selected
- 14 Selecting a street
- 15 Selecting a city center (▷ page 130)

- ▶ Press the right-hand rotary/push-button ● to activate the input menu “Street”.

Entering a street

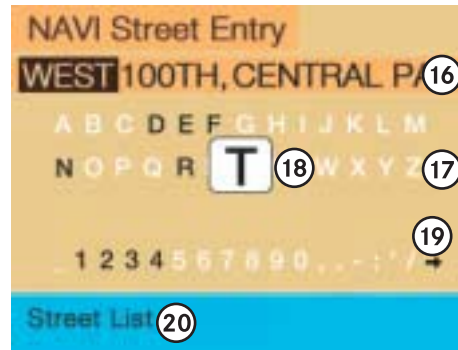

“Street Entry” input menu

- 16 Input line with letters that have already been entered
- 17 Character set
- 18 Zoom
- 19 Move the insertion point one position to the right
- 20 Activate the street list

- ▶ Turn the right-hand rotary/push-button ● to highlight the desired character in the character set 17.

The zoom 18 enlarges the highlighted character.

- ▶ Press the right-hand rotary/push-button ● to enter the character in input line 16.

COMAND supplements the new entry with additional letters so that a saved street name will appear.

- ▶ Enter other characters until the desired street name appears in 16.



For quicker input, COMAND will offer available characters from the character set 17 based on your selections and the names of the streets stored on the navigation CD.

Correcting the entry (▷ page 124).

Activating the street list



P82.85-9169-31

Street list

- 21 Street previously selected
- 22 Display the previous page, if ▲
- 23 Display the next page, if ▼

If the input menu “Street Entry” is displayed

- ▶ Press the right-hand rotary/push-button ● longer than 2 seconds.
- or
- ▶ Turn the right-hand rotary/push-button ● to highlight menu field 20 with and press to confirm.

The street list appears.

Here you can, as in the city list (▶ page 125), select another street or display the previous/next page.

- ▶ Press the right-hand rotary/push-button ● longer than 2 seconds.

This will confirm city/suburb and street of the desired destination. The selection menu “Destination Entry” appears.



If several options of a street are available, another menu will appear where you must make and confirm your desired selection.

Navigation

Destination input

Continue destination input



P82.85-9170-31

“Destination Entry” selection menu

- 1 Adding an intersection
- 2 Adding a house number
- 3 Selecting a destination via the map (▷ page 131)
- 4 Saving a destination address in the destination memory (▷ page 175)
- 5 Confirming the destination and the calculating route (▷ page 141)

You have now selected the destination and can define your destination address more precisely in the following manner:

- Adding an intersection
- Adding a house number



In order to do so, “House no.” must be shown in black.

- Selecting it via the map (▷ page 131)
- Selecting a city center, if you do not want to select a street (▷ page 130)

or

Confirm the destination and calculate the route (▷ page 141)

- ▶ Press the right-hand rotary/push-button ● to confirm “OK” in the menu “Destination Entry”.

Adding an intersection

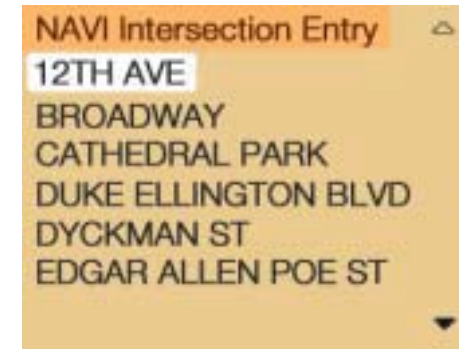

P82.85-9171-31

If the menu “Destination Entry” is displayed

- ▶ Turn the right-hand rotary/push-button ● to highlight 1 and press to confirm.

A list of roads intersecting with the previously input street will appear.

- ▶ Turn the right-hand rotary/push-button  to highlight the name of the intersection.



The previous/next page can be displayed as described for the city list (▷ page 125).

- ▶ Press the right-hand rotary/push-button  to confirm the selection.

The selection menu “Destination Entry” will appear, indicating the intersection.



P82.85-9172-31

- ▶ Press the right-hand rotary/push-button  longer than 2 seconds to calculate the route (▷ page 141).

Navigation

Destination input

Adding a house number

Depending on the data stored on the navigation CD, you can add a house number to the destination address.

In order to do so, the menu field “House no.” must be shown in black in the selection menu “Destination Entry”.

- ▶ Turn the right-hand rotary/push-button  to highlight **2** and press to confirm.

An input menu will appear.

- ▶ Turn the right-hand rotary/push-button  to highlight the desired numbers one after the other and press to confirm.

The numbers will appear in the input line.

- ▶ Press the right-hand rotary/push-button  longer than 2 seconds.

A list will appear.

Navigation

Destination input



The house numbers usually appear on the list in blocks, e.g.

1-5	odd numbers
42-50	even numbers
1-50	mixed numbers

- ▶ Turn the right-hand rotary/push-button  to highlight the desired block and press to confirm.

The selection menu “Destination Entry” will appear.

- ▶ Press the right-hand rotary/push-button  longer than 2 seconds to calculate the route (▷ page 141).

Selecting a city center

You can activate the list “Center Entry” in the main address menu (▷ page 123) or after selecting a city (▷ page 126).



P82.85-9173-31

- ▶ Turn the right-hand rotary/push-button  to highlight “Center” and press to confirm.

The list “Center Entry” will appear.

- ▶ Turn the right-hand rotary/push-button  to highlight the desired entry and press to confirm.

The selection menu “Destination Entry” will appear.

- ▶ Press the right-hand rotary/push-button  longer than 2 seconds to calculate the route (▷ page 141).

Selecting a destination via the map

Activating the map from the main destination input menu

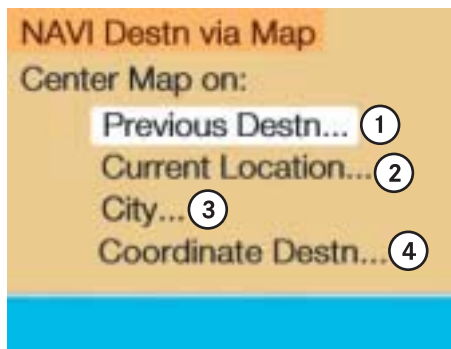

P82.85-9174-31

“Destination via Map” menu

Setting the map center

- 1 To the previous destination
 - 2 To the current vehicle location
 - 3 Activate the “City/Suburb Entry” input menu and select the corresponding city center after input
 - 4 Activate the coordinate destination input menu
- ▶ Turn the right-hand rotary/push-button ● to highlight “Destination via Map...” (Destn via Map) in the main destination input menu and press to confirm.

The selection menu “Destination via Map” will appear.

- ▶ Turn the right-hand rotary/push-button ● to highlight **1**, **2**, **3** or **4** and press to confirm.
- 1 and 2** The map with the crosshairs will appear
- 3** The “City/Suburb Entry” menu will appear (▷ page 124)
- ▶ Enter the city in the input menu and confirm it.
- Then, the map with the crosshairs will appear. The crosshairs are centered on the city center.
- 4** The coordinate destination input menu will appear (▷ page 135).

Navigation

Destination input

Continue destination input via the map



P82.85-9175-31

Map with crosshairs

- 5 Street name or name of the symbol (e.g. parking area) that the crosshairs are centered on
- 6 Crosshairs to select the destination
- 7 Symbol for current vehicle location
- 8 Current map scale

- ▶ Turn the right-hand rotary/push-button  to highlight “Map” and press to confirm.

The map with the crosshairs will appear.



During destination input, the map will always appear facing north (north is on top).

Map appearance is dependent on the selected map scale.

Moving the crosshairs

- ▶ Use the number keys (refer also to the arrows shown on the keypad) to move the crosshairs around the map.

- 1 to the top left
- 2 up
- 3 to the top right
- 4 to the left
- 6 to the right
- 7 to the bottom left
- 8 down
- 9 to the bottom right



As you move the crosshairs towards the edge of the screen using the number keys, an adjacent section of the map is activated. It may take a few seconds to point to each new map.

Adjacent map sections overlap somewhat so that destinations at the edge of the map can be marked as well.

Altering the map scale



P82.85-9177-31

- 9 Current map scale
- 10 Scale selector
- 11 New map scale (filled arrow)
- 12 Square increase section of the map

Navigation

Destination input

Activating the scale selector 10.

- ▶ Press **Z+** or **Z-**.
- or
- ▶ Press the right-hand rotary/push-button



A division mark corresponds to an available scale. You can select 13 different scales ranging from 0.05 miles/inch to 500 miles/inch.

Navigation

Destination input

Zooming in for more detailed map

- ▶ Press **Z+**.
- or
- ▶ Turn the right-hand rotary/push-button **⬅** to the left.
A filled arrow for the new scale **11** and a square **12** appear.

Press the right-hand rotary/push-button **⬅** to calculate the map with the new scale.

Zooming out for less detailed map

- ▶ Press **Z-**.
- or
- ▶ Turn the right-hand rotary/push-button **➡** to the right.
The new scale will appear.
- ▶ Press the right-hand rotary/push-button **➡** to calculate the map with the new scale.

This will take place automatically after 6 seconds.

Confirming destination and calculating route

The crosshairs highlight the desired destination

- ▶ Press the right-hand rotary/push-button **⬅** longer than 2 seconds.
- ▶ Then calculate the route (▷ page 141).

Destination entry via coordinates

You can enter a destination if the corresponding coordinates are known.

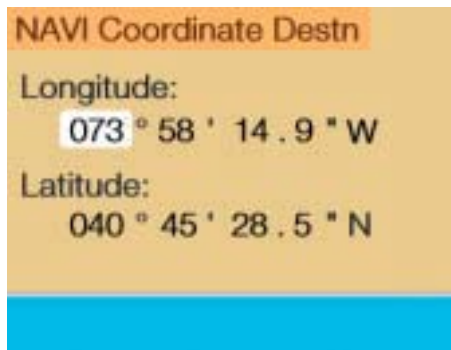

P82.85-9179-31

“Coordinate Destination” menu

- ▶ Turn the right-hand rotary/push-button  to highlight “Coordinate Destination...” in the Destination via Map menu (▷ page 131) and press to confirm.

The “Coordinate Destination” input menu will appear.

Activating the adjustment mode

- ▶ Press the right-hand rotary/push-button .

The entry will appear in red.

Altering the setting

- ▶ Turn the right-hand rotary/push-button .
- or
- ▶ Enter coordinates with the number keys.

Store the new setting and move the marking to the next entry

- ▶ Press the right-hand rotary/push-button .
- ▶ Subsequently repeat operating sequence and enter coordinates completely.



Adjustment range

- Longitude (W - West or E - East)
 - 0-179° 0-59 min
 - 0-59 s 0.1-0.9 s
- Latitude (N - North or S - South)
 - 0-89° 0-59 min
 - 0-59 s 0.1-0.9 s

Changing between western (W) and eastern (E) longitude

- ▶ Press  repeatedly.

Changing between northern (N) and southern (S) latitude

- ▶ Press  repeatedly.

Navigation

Destination input



P82.85-9180-31

Confirming coordinate destination

- ▶ Press the right-hand rotary/push-button  longer than 2 seconds.

The above display appears.

Starting the adjustment mode

- ▶ Turn the right-hand rotary/push-button  to highlight "OK" and press to confirm.

Store the coordinate destination in the destination memory with a name

- ▶ Turn the right-hand rotary/push-button  to highlight "Save" and press to confirm.

This will activate the destination memory (▷ page 175).

Activate the map with crosshairs

- ▶ Turn the right-hand rotary/push-button  to highlight "Map" and press to confirm.

This will activate the map (▷ page 132).

Entering Points of Interest

This function allows you to select Points of Interest such as gas stations, parking facilities or shopping centers.

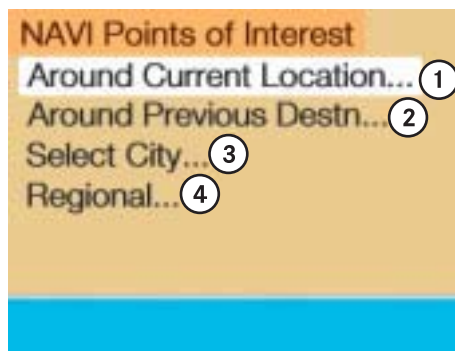

P82.85-9181-31

“Points of Interest” selection menu

Select a Point of Interest

- 1 Around the current area of vehicle location
- 2 Around the previous destination area
- 3 In the surrounding area of another city
- 4 As regional destination, e.g. airport

- ▶ Turn the right-hand rotary/push-button ● to highlight “Special destinations” in the main destination input menu and press to confirm.

The selection menu “Point of Interest” will appear.

- ▶ Turn the right-hand rotary/push-button ● to highlight 1 to 4 and press to confirm.

1, 2, 4 A Category list will appear

3 The input menu “City/Area” will appear (▷ page 139)

Navigation

Destination input

Around the current area of vehicle location or previous destination area



P82.85-9182-31

Category list

5 Display previous page, if ▲

6 Display next page, if ▼

Navigation

Destination input

- ▶ Turn the right-hand rotary/push-button  to highlight **1** or **2** and press to confirm.

The list "Select Category" will appear.

- ▶ Turn the right-hand rotary/push-button  to highlight the desired category and press to confirm.

A corresponding list will appear.



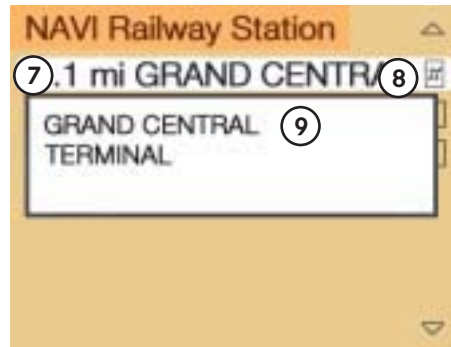

Not all Points of Interest may be listed on the CD.



P82.85-9183-31

- 7** Point of Interest entry with distance to destination in miles (as the crow flies)
- 8** Symbol for long entry
- 9** Complete entry in a window

Display the entry in full in a window **9**

- ▶ Press .
- ▶ Press  again to remove **9**.

Selecting the desired destination

- ▶ Turn the right-hand rotary/push-button  to highlight the entry in the selection list and press to confirm.
- ▶ Then calculate the route (▷ page 141).

In the surrounding area of another city

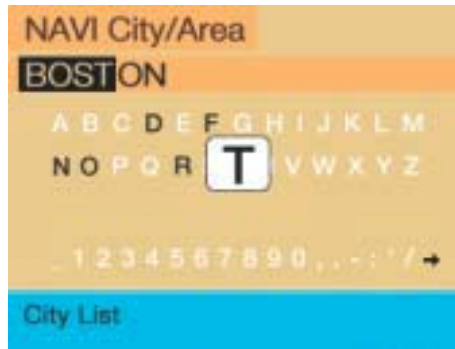

P82.85-9184-31

“City/Area” input menu

- ▶ Turn the right-hand rotary/push-button  to highlight “Select City...” in the Points of Interest menu and press to confirm.
The input menu “City/Area” will appear.
- ▶ Select the city and activate the city list (▷ page 125).

- ▶ Turn the right-hand rotary/push-button  to highlight the desired destination in the city list and press to confirm.
The list “Select Category” will appear.



If several options of a city/suburb are available, another menu will appear where you must make and confirm your desired selection.



Not all Points of Interest may be listed on the CD.

- ▶ Turn the right-hand rotary/push-button  to highlight the desired category and press to confirm.
A corresponding list will appear.
- ▶ Select the desired destination.
- ▶ Then calculate the route (▷ page 141).

Regional destinations



P82.85-9187-31

- ▶ Turn the right-hand rotary/push-button  to highlight “Regional...” in the Points of Interest menu and press to confirm.
The list “Select Category” will appear.



Not all Points of Interest may be listed on the CD.

Navigation

Destination input



- ▶ Turn the right-hand rotary/push-button ● to highlight the desired category and press to confirm.
An input menu, e.g. "Airport" will appear.
- ▶ Select an entry (▷ page 124) and then activate the list.

Activating the list



- ▶ Press the right-hand rotary/push-button ● longer than 2 seconds.
or
- ▶ Turn the right-hand rotary/push-button ● to highlight "List" and press to confirm.
The list will appear.

- ▶ Turn the right-hand rotary/push-button ● to highlight the desired entry and press to confirm.
- ▶ Then calculate the route (▷ page 141).

Navigation

Destination input

Selecting the last destinations

This function allows you to display up to 12 destinations you last selected.

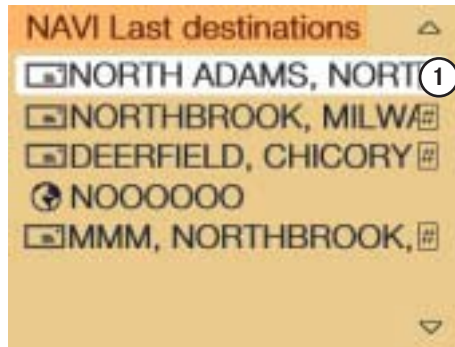

P82.85-9190-31

1 Destination selected last

- ▶ Turn the right-hand rotary/push-button  to highlight "Last destinations..." in the main destination input menu and press to confirm.

The list "Last destinations..." will appear.

- ▶ Turn the right-hand rotary/push-button  to highlight the desired destination and press to confirm.
- ▶ Then calculate the route.

Calculating a route

First select the calculation mode and then calculate your route.

Selecting calculation mode

COMAND calculates the route either as the Fast Route **1** or Short Route **2** whereby traffic routes **3**, **4** and **5** can be included or avoided (with several selections).

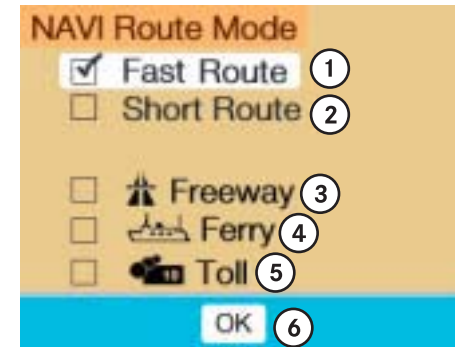

P82.85-9191-31

Navigation

Destination input

Selecting a route mode

- 1 Route calculated for optimum driving time
 - 2 Route calculated for optimum driving route
- ▶ Turn the right-hand rotary/push-button  to highlight the desired route mode and press to confirm.

Including or avoiding traffic routes, several selections are available



- 3 Calculate the route with/without free-ways
- 4 Calculate the route with/without ferry connections, car trains
- 5 Calculate the route with/without toll roads
- 6 COMAND calculates the route with the selected settings



Toll roads appear in green on the map.

- ▶ Turn the right-hand rotary/push-button  to highlight the desired type of road and press the button.

Calculating the route

- ▶ Press the right-hand rotary/push-button  longer than 2 seconds.
or
- ▶ Turn the right-hand rotary/push-button  to highlight "OK" and press to confirm.

As soon as calculation begins, you will see a corresponding message and hear the voice output "The route is being calculated".



In the event that no reasonable alternate route for that destination exists, COMAND will calculate the route including **3** to **5** even if these selections are to be avoided.

Navigation

Destination input

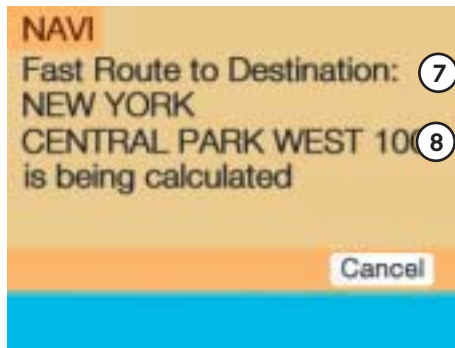

P82.85-9192-31

- 7 Calculation method
- 8 Destination

Cancel route calculation

- ▶ Turn the right-hand rotary/push-button  to highlight "Cancel" and press to confirm.

The main destination input menu will appear.



P82.85-9193-31

During the calculation, the symbol display will appear after a few seconds.

- 9 Calculation of route
- 10 Arrow indicating the direction to the destination (as the crow flies)
- 11 Distance to the destination (as the crow flies)



P82.85-9194-31

The route will be calculated. COMAND identifies the road you are travelling on.

Position 12 now indicates the driving direction.

You will e.g. hear the voice output "Please, make the next right turn".

Navigation

Route guidance

Route guidance

Route guidance principles

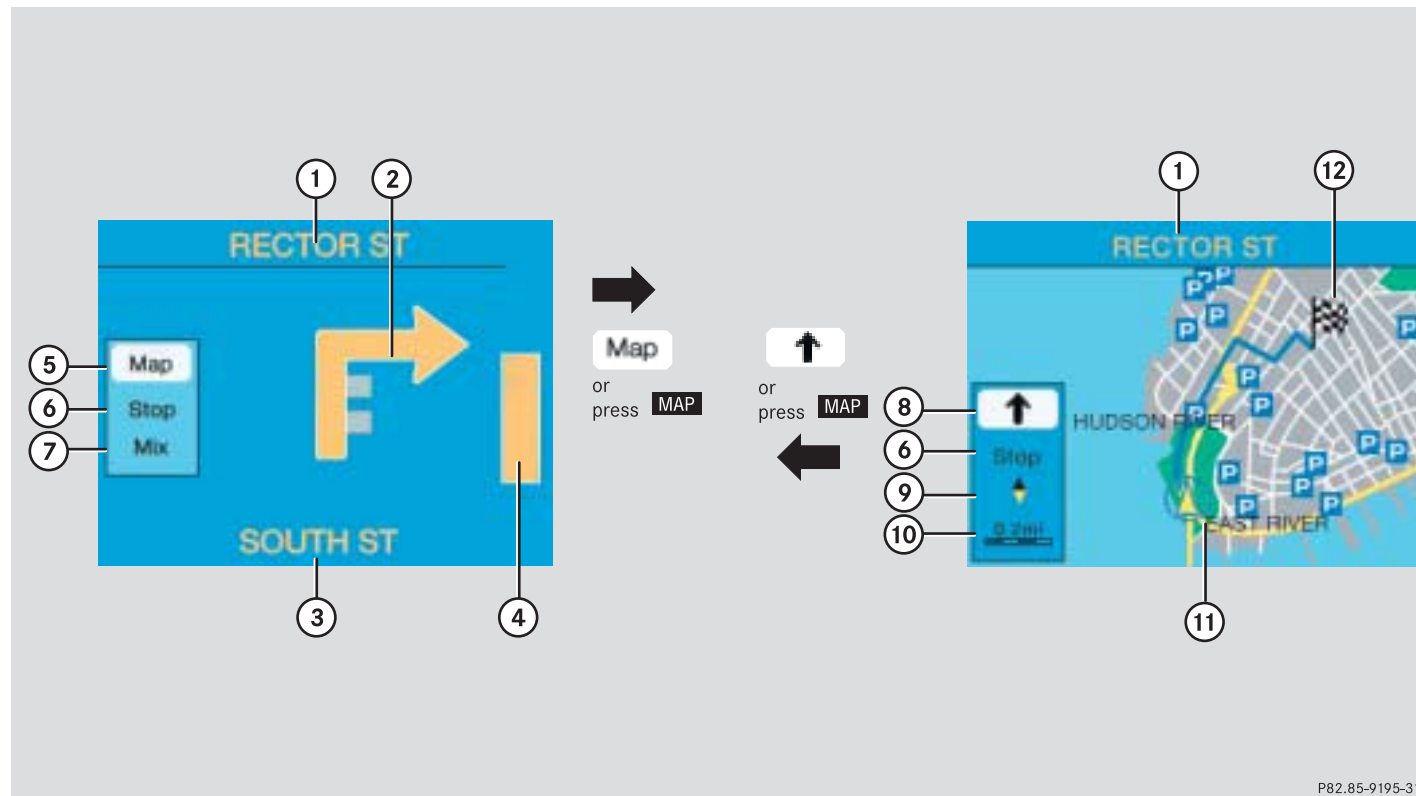

P82.85-9195-31

	Function	Page
1	Name of the street onto which you should turn or	154
	Distance to destination or	155
	Name of the route (e.g. I-695) and direction of travel to follow (e.g. North)	155
2	Arrow indicating driving direction or	154
	<ul style="list-style-type: none"> • Destination direction 	168
	<ul style="list-style-type: none"> • Symbol for new calculation of the route • Destination flag 	170
3	Name of the street on which you are travelling	149
4	Other display types	
	<ul style="list-style-type: none"> • Distance bar to the next maneuver 	154
	<ul style="list-style-type: none"> • Distance to the next maneuver in miles 	155

	Function	Page
	<ul style="list-style-type: none"> • “OFF MAP” - vehicle is located outside of the digitized map area • “OFF ROAD” - vehicle is located on a road which is not digitized • “DEST AREA” - vehicle is approaching the destination, the destination area is not digitized 	
	<ul style="list-style-type: none"> • “CALC. ROUTE” - a route is being calculated 	143
	<ul style="list-style-type: none"> • “NEW ROUTE” - an existing route is being recalculated 	170
	<ul style="list-style-type: none"> • “NO ROUTE” - the COMAND is unable to calculate a route 	

	Function	Page
5	Activating the map	156
	Route guidance is active: You can also press MAP .	
6	Marking a way point	160
7	Mixture of map and symbol display	157
8	Activating the symbol display	156
	Route guidance is active: You can also press MAP .	
9	Selecting map orientation	159
10	Current map scale	158
11	Current vehicle location with route (blue line)	151
12	Destination flag	

Navigation

Route guidance

After the destination is selected and the route is calculated, the navigation system will guide you to the destination using both pictorial displays and voice outputs.

During route guidance, you can select the following 3 screen displays:

- Symbol display
Always appears after a route has been calculated
- Map display
Activate the map with menu field **5**, switch back to symbol display with menu field **8**
- Mix
Before the vehicle makes a turn, COMAND switches automatically from the map to the symbol display.
Once the turn has been completed, the map is displayed again.



In the map display, menu fields **6, 8, 9** are removed after 6 seconds.

Turn the right-hand rotary/push-button  to display the menu fields again.



The map appears automatically after 5 seconds if the vehicle is located on a road which is not digitized (message OFF ROAD).

If COMAND recognizes a stored road, the symbol display is called up again.

Requesting destination and route information

Once you have calculated the route, you can request destination and route information.

- ▶ Press **INFO**.
The selection menu "Destination Info" will appear.

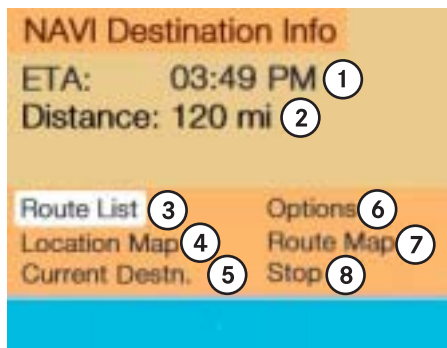

P82.85-9196-31

"Destination Info" selection menu

- 1 Estimated time of arrival at destination
- 2 Current distance to destination
- 3 Display route list
- 4 Display location map
- 5 Display current destination
- 6 Request route mode
- 7 Activate route map
- 8 Display stop-over

Navigation

Route guidance

- ▶ Turn the right-hand rotary/push-button **●** to highlight **3** to **8** and press to confirm.

i

If the vehicle drives on a road which is not digitized, **1** and **2** will appear in gray and display the last available information. The message "Off Road: dest. info not up-to-date" appears underneath.

Route guidance is switched off

The last destination driven to will appear in line **1**.

Navigation

Route guidance



Displaying route list





P82.85-9197-31

- ▶ Turn the right-hand rotary/push-button  to highlight **3** and press to confirm. The message “Compiling Route List...” will appear.

Displaying the entry in full in a window

- ▶ Press .
- ▶ Press  again to remove the window.

Displaying the next/previous page (if arrows are filled)

Turn the right-hand rotary/push-button  to highlight / and press to confirm.

Switching back to the symbol or map display

- ▶ Press **BACK** twice.



The route list is updated during the trip. It contains a selection of streets which will be travelled or which still lie ahead.

If a longer route is calculated, e.g. to avoid sections of the freeway (▷ page 142), these freeways may still appear on the route list. As the vehicle approaches the freeway, it will be deleted from the route list.

Activating the location map

If route guidance is active

- ▶ Turn the right-hand rotary/push-button  in the selection menu “Destination Info” to highlight “Location map” and press to confirm.

The location map faces north (North-up).



P82.85-9198-31

- 1 Geographic longitude and latitude for your current location
- 2 Number of satellites received
- 3 Scale used the last time the location map was activated
- 4 Current vehicle location in the center of the screen
- 5 Name of the street the vehicle is currently travelling on

Altering the map scale (▷ page 158).

Switching back to the symbol or map display

- ▶ Press **BACK** twice.

If route guidance is switched off

- ▶ Press **MAP**.

The location map will appear.

- ▶ Press **MAP** again to activate the main destination input menu.



If the location map appears after COMAND has been switched on, press **NAV** to activate the main destination input menu.

Navigation

Route guidance

Displaying current destination

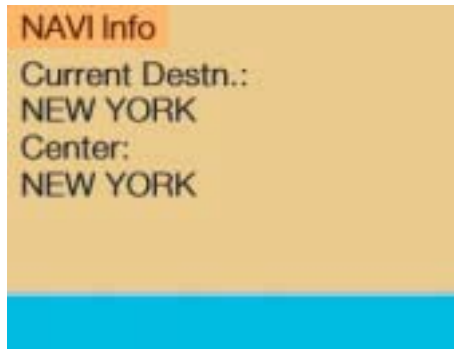

P82.85-9199-31

- ▶ Turn the right-hand rotary/push-button  in the selection menu “Destination Info” to highlight “Current Destination” and press to confirm.

You will see the current destination.

Switching back to the symbol or map display

- ▶ Press **BACK**.

Requesting route mode

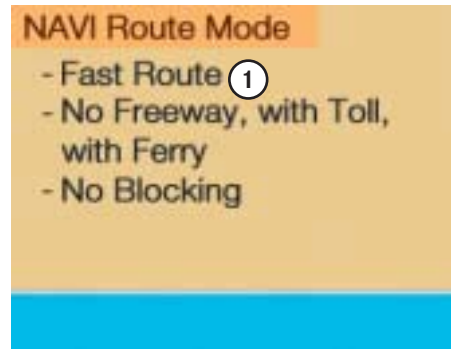

P82.85-9200-31

- 1 Settings for route calculation mode
- ▶ Turn the right-hand rotary/push-button  in the selection menu “Destination Info” to highlight “Options” and press to confirm.

The settings for the current route are displayed.



Selecting calculation mode
(▷ page 141)

Selecting a detour during destination
guidance (▷ page 163)

Marking a way point (▷ page 160)

Switching back to the symbol or map display

After 15 seconds, COMAND will return automatically to the symbol or map display.

or

- ▶ Press **BACK**.

Navigation

Route guidance

Activating the route map



P82.85-9201-31

- 1 Current vehicle location
- 2 Route displayed as blue line
- 3 Destination

- ▶ Turn the right-hand rotary/push-button ● in the selection menu “Destination Info” to highlight “Route Map” and press to confirm.

The route map faces north (North-up) and shows the general view for the whole route.

The map scale selected depends on the route.

Switching back to the symbol or map display

- ▶ Press **BACK**.

Displaying a stop-over

You can display this information if you have previously selected a way point (▷ page 160).

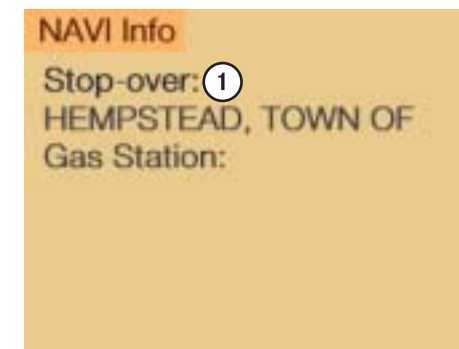

P82.85-9202-31

1 Way point

Place, type of stop-over and name

- ▶ Turn the right-hand rotary/push-button ● in the selection menu “Destination Info” to highlight “Stop” and press to confirm.

Navigation

Route guidance

Beginning route guidance

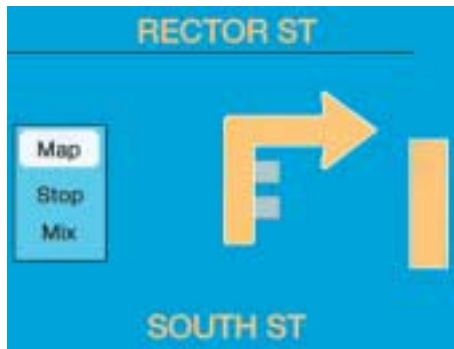

P82.85-9203-31

Once the route has been calculated, the symbol display will appear.

If you now are at the maneuver point, you will also hear a voice output, e.g. "Please turn right".

During route guidance, you can select the following 3 screen displays:

- Symbol display
- Map display
- Mix of map and symbol display (▷ page 157)

Voice output

During the trip, apart from visual information (symbol or map displays), COMAND also provides all of the necessary route information via voice output.

COMAND gives you spoken recommendations

- when route guidance begins
- after the route has been calculated
- before and during a change in the driving direction
- on reaching the destination or a way point

Warning



Voice output is intended to direct you while driving without diverting your attention from the road and driving. Please always use this feature instead of consulting the symbol or map display for directions while driving which may cause you to divert your attention from driving and increase your risk of accident.

If an audio source is switched on, e.g. the radio, the voice output will be mixed with that of the audio source.

You can individually set the audio volume differential between voice output/audio source (▷ page 64). COMAND mutes navigation voice outputs during telephone/Tele Aid operation.

Repeating current voice output

- ▶ Press the left-hand rotary/push-button  briefly.

Muting current voice output

- ▶ Press **MUT** briefly during a voice output. You will hear the next announcement normally.

Switching the voice output off for the duration of the current route guidance

- ▶ Press **MUT** longer than 2 seconds during a voice output.

You will see the message “Voice output is muted”.

Switching the voice output on again

The current route guidance has been completed.

Voice output will automatically switch on again.

During a voice output

- ▶ Press the left-hand rotary/push-button .

Altering the voice output volume

At the COMAND control unit

- ▶ Turn the left-hand rotary/push-button  during a voice output.

COMAND will accept this setting for following voice outputs.

At the multifunctional steering wheel

You can alter the volume with the steering wheel keys during a voice output as well.

To raise the volume

- ▶ Press **+**.

To lower the volume

- ▶ Press **-**.

Navigation

Route guidance

Turning onto a street

Example of a traffic situation with voice output

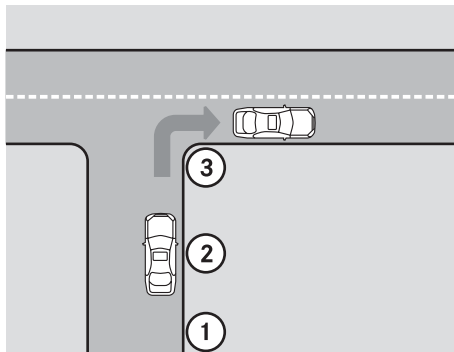

P82.85-7382-31

- 1 "Prepare to turn right" (advance notice)
- 2 "Turn right after 250 feet"
- 3 "Please, turn next right"

Manual recall of the current voice instruction

- ▶ Press left-hand rotary/push-button 

Advance notice of right turn



P82.85-9205-31

- 4 Name of the street you are to turn onto
- 5 Arrow indicating driving direction
- 6 Name of the street you are travelling on
- 7 Distance in miles to right turn



As you approach a junction or interchange (e.g. I-695), COMAND will advise you the direction of travel to follow (e.g. North) as well as the name of the route.

Just before a right turn

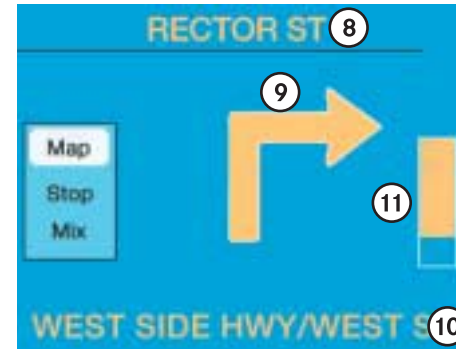

P82.85-9206-31

- 8 Name of the street you will to turn onto
- 9 Right-turn arrow
- 10 Name of the street you are now driving on
- 11 Distance graph to turning point, reduces as you approach the intersection



In special situations, e.g. when turning quickly several times in succession, there may be deviations in the accuracy of the voice instructions.

Navigation

Route guidance

Following the course of the road



P82.85-9207-31

- 1 Distance to destination
- 2 Arrow indicating driving direction
- 3 Name of the road you are currently driving on
- 4 Distance in miles to the next maneuver point

Driving through an intersection



P82.85-9208-31

- 1 Name of the street onto which you are to drive
- 2 Part of the street, not to be followed
- 3 Name of the street you should drive on
- 4 Distance graph to turning-point



As you approach a junction or interchange (e.g. I-695), COMAND will advise you the direction of travel to follow (e.g. North) as well as the name of the route.

Before you drive through an intersection, you will be informed of the continued route, e.g.

- “Prepare to bear left soon” (advance notice)
- “Bear left after 250 feet”
- “Please bear left”

Please note the following difference in voice output

Situation	Example of voice output
Making a turn onto a street	...turn left/right.
Driving through an intersection	...bear left/right.

Navigation

Route guidance

Changing to map display

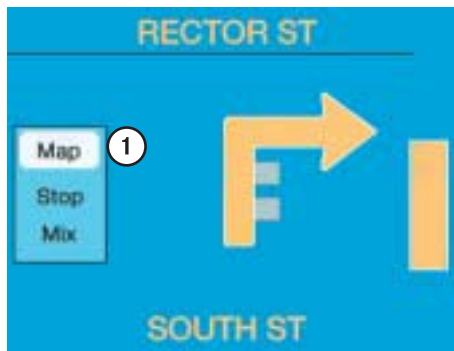

P82.85-9209-31

1 Activating map display



P82.85-9210-31

- 2 Return to symbol display
- 3 Last scale selected
Altering the map scale (> page 158)
- 4 Actual vehicle location
- 5 Name of the street you will turn onto

You can select one of the two possibilities:

- ▶ Press the right-hand rotary/push-button  to confirm **1**.

or

- ▶ Press **MAP**.

The map will appear in the scale last selected.



COMMAND will remove the menu bar (except for **3**) after 6 seconds.

- ▶ Turn the right-hand rotary/push-button  to recall the menu bar to the screen.

Navigation

Route guidance

Mix of map and symbol display

If the function Mix is switched on, the symbol display is activated automatically from the map display before making a maneuver. After you have made the maneuver, the map will appear again.

Switching the mix function on

- ▶ Turn the right-hand rotary/push-button  to highlight "Mix" in the symbol display and press to confirm.

"Mix" appears in red.

Switching the mix function off

- ▶ Turn the right-hand rotary/push-button  to highlight "Mix" in the map or symbol display and press to confirm.

"Mix" appears in black again.



P82.85-9211-31

Map display before a maneuver, mix function is switched on



P82.85-9212-31

Before a maneuver off e.g. a U-turn, CO-MAND will activate the symbol display.

After you have made the U-turn, the map will appear again.

Navigation

Route guidance

Altering the map scale

Activate the scale selector

- ▶ Press **z+** or **z-**.
- or
- ▶ Turn the right-hand rotary/push-button **●** to highlight 1 and press to confirm. The scale bar will appear.



A division mark corresponds to an available scale. You can select 13 different scales ranging from 0.05 miles/inch to 500 miles/inch.



P82.85-9213-31

- 1 Current map scale
- 2 Scale selector
- 3 New map scale

Zooming in for more detailed map

- ▶ Press **z+**.
- or
- ▶ Turn the right-hand rotary/push-button **●** to the left. The map will appear automatically.

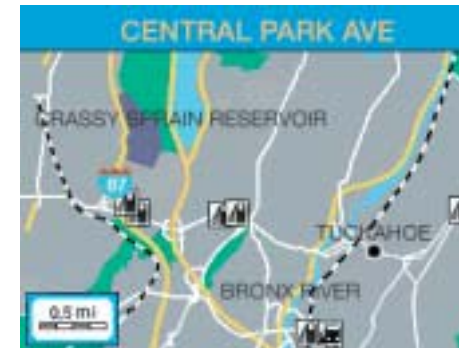

P82.85-9214-31

Zooming out for less detailed map

- ▶ Press **z-**.
- or
- ▶ Turn the right-hand rotary/push-button **●** to the right. The map will appear automatically.

Navigation

Route guidance



Selecting map orientation

You can either select the map north or position it with the driving direction pointing up.



P82.85-9215-31

North-up: Map is displayed facing north

- 1 Selecting map orientation
North arrow  or compass needle 
(black tipping pointing to the north)
- 2 Symbol for current vehicle location

Selecting driving direction pointing up



P82.85-9216-31

Heading-up: Map is displayed facing driving direction pointing up

- ▶ Turn the right-hand rotary/push-button  to highlight 1 and press to confirm.
Symbol 2 points in the driving direction, the compass needle will appear.

To return to North-up

- ▶ Turn the right-hand rotary/push-button  to highlight 1 and press to confirm.
The north arrow will appear again.

Map orientation	Characteristics
North-up	North arrow always points to the top The symbol for the current vehicle location is turning on the map
Heading-up	The symbol for the current vehicle location always points to the top The compass needle is turning, the black point always points north

Navigation

Route guidance

Marking a way point

You can store a way point during route guidance.



P82.85-9217-31

1 Activate "Way Point" menu

- ▶ Turn the right-hand rotary/push-button  to highlight 1 and press to confirm. The "Way Point" menu will appear.

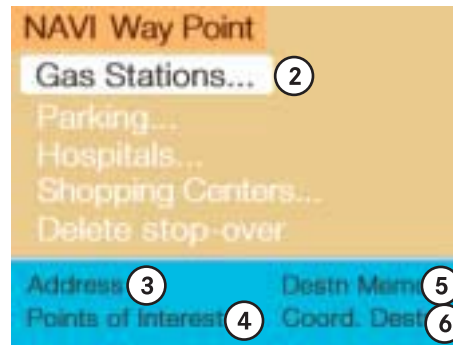

P82.85-9218-31

"Way Point" menu

- 2 Select a category
- 3 Activate the main address menu (> page 123)
- 4 Activate the "Points of Interest" selection menu (> page 137)
- 5 Activate the main destination memory menu (> page 174)
- 6 Activate the "Coordinate Destination" input menu (> page 135)

- ▶ Turn the right-hand rotary/push-button  to highlight 2 to 6 press to confirm.
- ▶ Select the desired way point.
- ▶ Start route guidance.

Starting route guidance



P82.85-9219-31

- ▶ Press the right-hand rotary/push-button  to confirm "Start Guidance...".



After you have entered an address, the menu fields "Intersection..." and "House No..." may appear in black, indicating that it is possible to select them.

Navigation

Route guidance

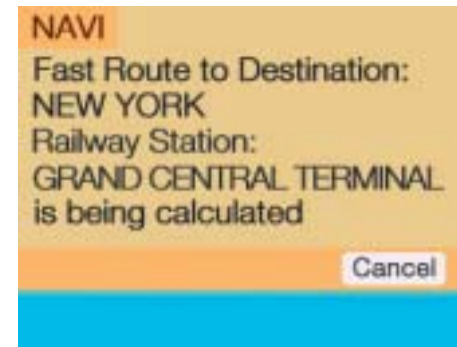

P82.85-9220-31

You will now see the information corresponding to route calculation and hear the voice output: "The route to your intermediate destination is being calculated".

The previously selected route mode will be maintained.

After you reach the way point, you will continue to follow the route to the original input destination.

Navigation

Route guidance

Cancel the calculation

- ▶ Press the right-hand rotary/push-button  to confirm "Cancel".

Deleting way point

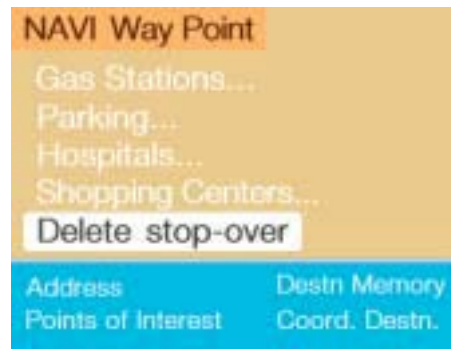

P82.85-9221-31

- ▶ Turn the right-hand rotary/push-button  to highlight "Stop" in the symbol or map display and press to confirm.

The "Way Point" menu will appear, "Delete stop-over..." is highlighted.

If the menu bar is not visible in the map:

- ▶ Turn the right-hand rotary/push-button .

The menu bar will appear.

- ▶ Press the right-hand rotary/push-button  to confirm "Delete stop-over...".

The way point has been deleted.

If you do not want to delete the way point

- ▶ Press **BACK**.



It is also possible to delete a way point in the menu (▷ page 167).

Selecting a detour

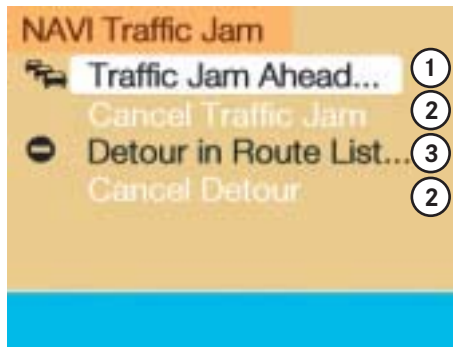

P82.85-9222-31

Main detour menu

- 1 It is possible to block route sections ahead
- 2 Ends the detour function, the previous route is calculated
 - Traffic Jam Ahead/Detour in Route List not activated:
 - “Cancel” cannot be selected
 - Traffic Jam Ahead/Detour in Route List activated:
 - “Cancel” is highlighted
- 3 It is possible to block route sections in the route list (▷ page 165)

- ▶ Press **DETR** at any time. The main detour menu will appear.
- ▶ Turn the right-hand rotary/push-button **⦿** to highlight the desired menu field and press to confirm.



Traffic jams are identified by the driver, not by the COMAND.

If you switch off COMAND for more than 30 minutes during active route guidance, all manually entered traffic jams are deleted.

Navigation

Route guidance

Traffic jam ahead

If a traffic jam lies ahead, you can block the route sections following the next intersection/the next turn-off.

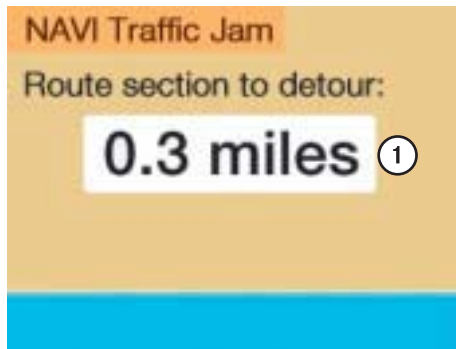

P82.85-9223-31

Traffic jam menu

- 1 Length of the blocked route section in miles

- ▶ Turn the right-hand rotary/push-button  to highlight “Traffic Jam Ahead...” in the main detour menu and press to confirm.

The traffic jam menu will appear.



COMAND suggests reasonable route sections.

Minimum/maximum length of detour is governed by the logical grouping of route sections. If additional detour segments are required after the original detour, they must be requested individually.

Entering the length of the blocked route section

Increasing the blocked section

- ▶ Turn the right-hand rotary/push-button  to the right.

Decreasing the blocked section

- ▶ Turn the right-hand rotary/push-button  to the left.

Calculating detour

- ▶ Press the right-hand rotary/push-button .

The route will be re-calculated. An information menu will appear.

Then COMAND continues route guidance.



You can also select “Traffic Jam Ahead” during the course of a detour. The current detour will then be cancelled.

Detour in route list

- ▶ Turn the right-hand rotary/push-button ● to highlight “Detour in Route List” in the main detour menu and press to confirm.

The message “The route list is being calculated” will appear.

Then the route list will appear.



P82.85-9224-31

Route list

- 1 Street cannot be blocked off
- 2 Symbol “+”: street contains several sections which can be blocked off
- 3 Blocked street will appear in red

Displaying an entry in full in a window

- ▶ Press #.
- ▶ Press # again to remove the window.

Navigation

Route guidance

Calling detailed route list



P82.85-9225-31

Detailed route list

- 4 Symbol “-” - sections of a road are displayed
- ▶ Press **Z+**.
- The detailed route list will appear.

Blocking off several streets/street sections

- ▶ Turn the right-hand rotary/push-button **●** to the right.
- With each turn, you will block another section.
- The road name will appear in red.

Undoing street block

- ▶ Turn the right-hand rotary/push-button **●** to the left.
- The street name will appear in black again.

Switching back to the route list

- ▶ Press **Z-**.
- The symbol “+” appears in front of the street section.
- The blocking function is still active.

Canceling blocking function, do not recalculate the route

- ▶ Press **BACK**.
- The traffic jam menu will appear.

Ending the blocking function, re-calculating the route with the blocks selected

- ▶ Press the right-hand rotary/push-button **●**.
- COMAND re-calculates the route in the previously selected calculation mode. A corresponding message will appear.
- Then the symbol display will appear again and COMAND will continue route guidance.

Resetting functions

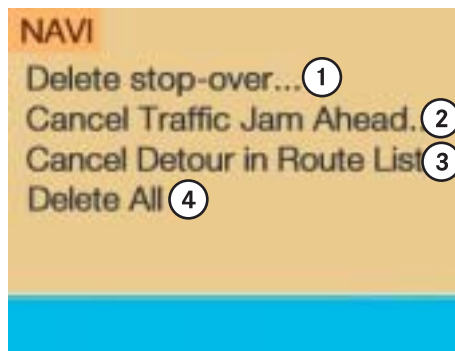

P82.85-9226-31

- 1 Delete a way point
- 2 Cancel a detour (traffic jam ahead)
- 3 Cancel a detour (street sections blocked in the route list)
- 4 Reset all functions

- ▶ Press **DEL**.

A selection menu will appear.

- ▶ Turn the right-hand rotary/push-button **●** to highlight the desired menu field and press to confirm.

COMAND will re-calculate the route using the previously selected calculation mode.

You will see the corresponding information.

The corresponding information will appear on the display.



If you have not selected any way point (▷ page 160) or detour (▷ page 163) menu fields **1** to **4** are shaded out and cannot be selected.

Navigation

Route guidance

Deviating from the calculated route



P82.85-9227-31

If you deviate from a recommended route, the COMAND automatically calculates a new route from the current vehicle location to the requested destination.

If applicable, the message “NEW ROUTE” will appear along with an arrow outline indicating the driving direction.

After the new calculation has been successfully completed, COMAND continues route guidance.

The arrow indicating the driving direction will appear as usual.

Driving on a non-digitized road

If the symbol display is active, the map showing the current vehicle location relative to the route will appear after 5 seconds.

COMAND automatically changes back to the symbol display if a known road is used again.

Interrupt route guidance during a journey

The car is parked for longer than 2 hours and the remaining distance to the destination is more than 0.3 miles.

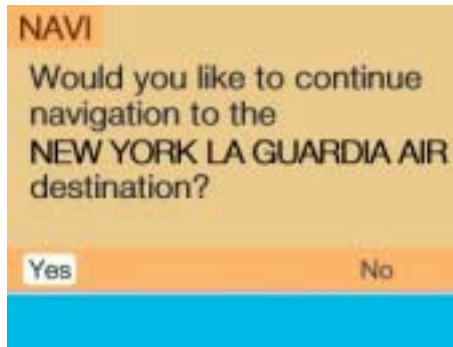

P82.85-9234-31

Inquiry menu

After COMAND has been switched on again, the inquiry menu shown above appears.

Recalculating and continuing the active route guidance

- ▶ Press the right-hand rotary/push-button  and confirm "Yes".

You will hear the voice output "The route is being recalculated".

Recalculating and continuing the active route guidance

- ▶ Turn the right-hand rotary/push-button  to highlight "No" and press to confirm.

The destination input menu will appear.



The inquiry menu can also appear if the current stop-over is entered.

If the journey is interrupted for less than 2 hours, active route guidance will be continued automatically. You will hear the voice output "The route is being recalculated".



If the remaining distance to the route is less than 0.3 miles, route guidance ends and the main destination input menu will appear.

The message "Manual route exclusions have been reset" will appear, if

- you have selected a detour and the COMAND was switched off for longer than 30 minutes during active route guidance.

Manually entered traffic jams are deleted.

- ▶ Press **BACK** to remove the message.

Navigation

Route guidance

Arriving at destination



P82.85-9228-31

When you reach the destination, you will see the destination flag. You will hear the voice output “You have reached your destination”.

Then the main destination input menu appears and you can now enter another destination.



You will also hear voice outputs and see display messages when you approach and arrive at way points.

Navigation

Route guidance

Activating audio system

During route guidance (you see either symbol or map display) you can select another COMAND system by pressing the corresponding key.

The main menu of the selected audio source will appear and you will e.g. hear the radio.

Route guidance and the navigation's voice output remain active.

The voice output is added to the audio playback.

You can individually adjust the volume levels for voice output and audio playback (▷ page 64).



P82.85-9230-31

- ▶ Press **FM/AM**.
The main radio menu will appear.
The station last tuned to will begin to play.
- ▶ Selecting a station (▷ page 30).

Returning to navigation system

- ▶ Press **NAV**.

Activating audio functions

During route guidance, you can operate an audio source that is active in the background. Although the options are limited, you can operate the audio source without having to fully switch to the corresponding system.

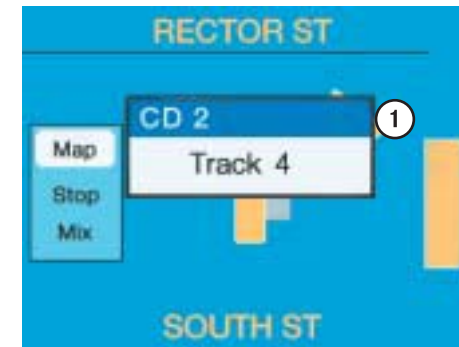

P82.85-9231-31

- 1 A window is shown in the symbol or map display, providing details about the active audio source

Navigation

Route guidance

Removing the window

This is done automatically after 3 seconds.

or

- ▶ Press **BACK**.

The radio is active

- Selecting a memorized station from the respective memory (FM, AM or WB)
 - ▶ Press number keys **1** through **0**.
- Performing station seek
 - ▶ Press **◀** or **▶** briefly.

- Starting manual search

- ▶ Press **◀** or **▶** longer than 2 seconds.

The search run will start in the desired direction - frequency ranges FM, AM or WB.

CD mode is active

- Selecting CD with number keys
 - 0** CD drive
 - 1** - **6** CD changer
- Selecting previous/next track
 - ▶ Press **◀** or **▶** briefly.
- Skipping backwards/forwards
 - ▶ Hold **◀** or **▶** longer than 2 seconds.

Navigation

Route guidance

Canceling route guidance

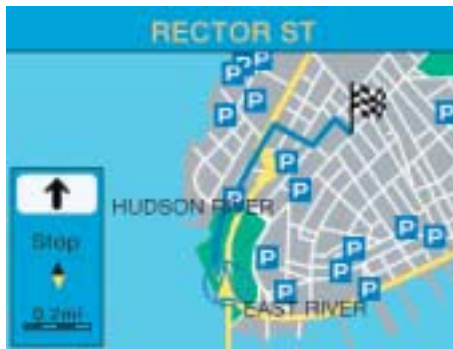

P82.85-92332-31

- ▶ While the map or symbol display is active, press **NAV**.
A query will appear.

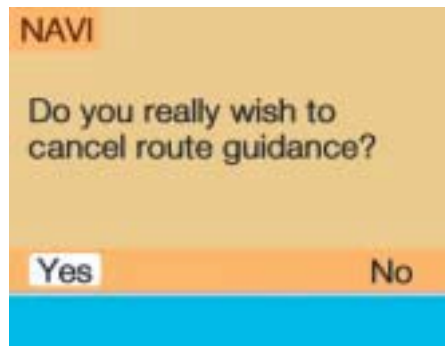

P82.85-92333-31

- ▶ Press the right-hand rotary/push-button **●** and confirm "Yes".
The main destination input menu will appear.

Continuing route guidance

- ▶ Press **BACK**.
or
- ▶ Turn the right-hand rotary/push-button **●** to highlight "No" and press to confirm.

The map or the symbol display will appear.

Navigation

Destination memory

Destination memory

You can save frequently used destinations in the destination memory.

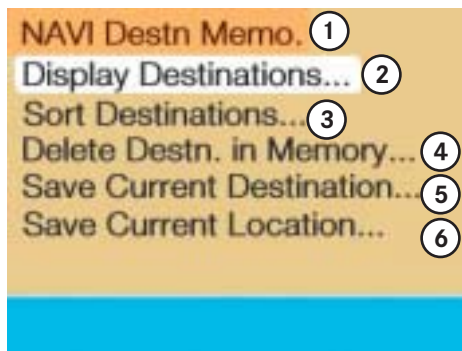

P82.85-9235-31

Main destination memory menu

- 1 Info/status line
- 2 Retrieving destination from the destination memory for destination input
- 3 Sorting destination memory
- 4 Deleting destination in the destination memory
- 5 Saving the current destination
- 6 Saving current vehicle location with a name

- ▶ Turn the right-hand rotary/push-button ● to highlight "Destination memory" in the main destination input menu and press to confirm.

The main destination memory menu will appear.

Retrieving a destination from the destination memory



P82.85-9236-31

- ▶ Press the right-hand rotary/push-button ● to confirm "Display destinations..." in the main destination memory menu.

After the message "Compiling sorted destination list", the destination memory will appear.

- ▶ Turn the right-hand rotary/push-button **●** to highlight the desired entry and press to confirm.
- ▶ Then calculate the route (▷ page 141).



Displaying longer entries (▷ page 165).

Saving the current destination

When you have entered or reached the current destination, you can save the destination in the destination memory.

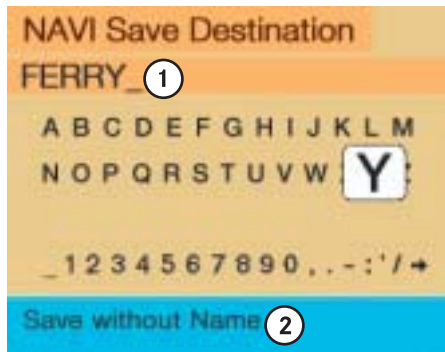

P82.85-9237-31

Input menu

- 1 Name entered
- 2 Saving the destination without entering a name

Navigation

Destination memory

In the selection menu “Destination Entry” (▷ page 128)

- ▶ Turn the right-hand rotary/push-button **●** until “Save” is highlighted and press to confirm.

In the main destination memory menu

- ▶ Turn the right-hand rotary/push-button **●** until “Save current destination...” is highlighted and press to confirm.

An input menu will appear.



If all memory locations are used, the message “Destination memory is full” will appear. Press the right-hand rotary/push-button **●** to remove the message.

The main destination memory menu will appear.

Deleting a destination in destination memory (▷ page 179).

Navigation

Destination memory

Saving with a name

You can enter a name for the current destination.

- ▶ Turn the right-hand rotary/push-button ● to highlight the desired character and press to confirm.

The letter you have selected appears in the input line.

- ▶ Enter the other letters until the name is complete.

- ▶ Press the right-hand rotary/push-button ● longer than 2 seconds.

The destination memory will activate. The current destination has been saved with a name and appears in red.

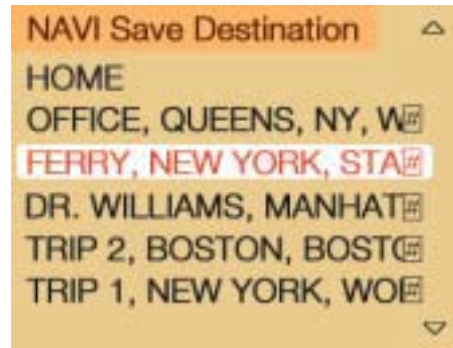

P82.85-9238-31

- ▶ Turn the right-hand rotary/push-button ● to move the entry to the desired point in the list and press to confirm.

Saving after destination has been entered:

The main destination entry menu will appear, "Start Guidance..." is highlighted.

Saving on arrival at destination:

The main destination entry menu will appear.

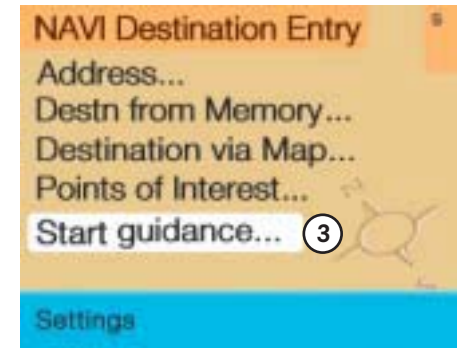

P82.85-9239-31

3 Starting route guidance

- ▶ Press the right-hand rotary/push-button ● to confirm **3**.
Route guidance begins.

Saving without a name

If you do not wish to enter a name, COMAND will save the destination with city and street name.

- ▶ While you are in the input menu, turn the right-hand rotary/push-button ● to highlight “Save without names” and press to confirm.

The destination memory will appear.

Saving the current vehicle location

With this function, you can save the current vehicle location in the destination memory. Enter a name so you will be able to retrieve it at a later date.

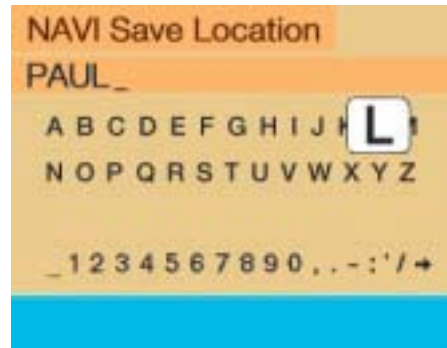

P82.85-9240-31

- ▶ Turn the right-hand rotary/push-button ● to highlight “Save current location...” in the main destination memory menu and press to confirm.

The input menu “Save Location” will appear.

- ▶ Enter a name.
- ▶ Then activate the destination memory and save the position in the desired memory location, see “Saving with a name”.

The main destination input menu will appear.

Navigation

Destination memory

Sorting destination memory



P82.85-9158-31

- ▶ Turn the right-hand rotary/push-button ● to highlight “Sort destinations...” in the main destination memory menu and press to confirm.

After the message “Compiling sorted destination list”, the destination memory will appear.

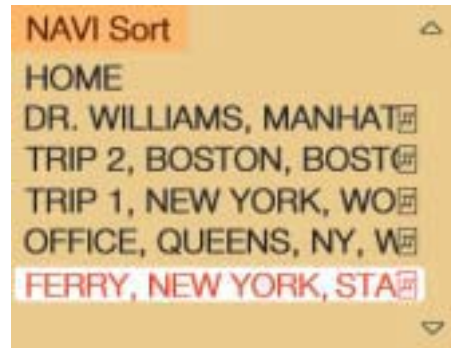

P82.85-9157-31

- ▶ Turn the right-hand rotary/push-button ● to highlight the desired entry and press to confirm.

The entry is now shown in red.

- ▶ Turn the right-hand rotary/push-button ● to move the entry to the desired position and press to confirm.

The entry is saved at that location.

The entry is shown in black again. The main destination memory menu is re-activated automatically.

Deleting a destination

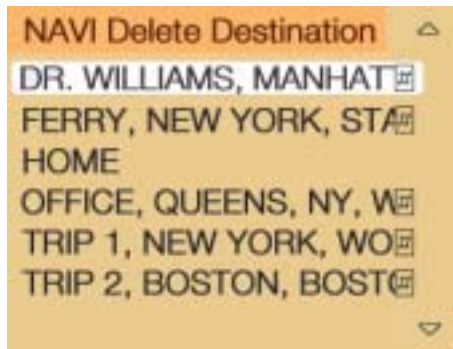

P82.85-9156-31

- ▶ Turn the right-hand rotary/push-button **●** to highlight “Delete Destination in Memory” in the main destination memory menu and press to confirm.

After the message “Compiling sorted destination list”, the destination memory will appear.

- ▶ Turn the right-hand rotary/push-button **●** to highlight the entry you wish to delete and press to confirm.

The inquiry “Do you really want to delete the destination?” will appear.

- ▶ Turn the right-hand rotary/push-button **●** to highlight “Yes” and press to confirm.

The entry has been deleted from the list. The following entries will each move up one position. The delete function is still active.

If you do not want to delete the destination

- ▶ Turn the right-hand rotary/push-button **●** to highlight “No” and press to confirm.

The destination memory will appear.

Activating the main destination memory menu

- ▶ Press **BACK**.

Navigation



Settings

Settings

Entering the vehicle location

COMAND normally determines the vehicle location automatically with the GPS. In exceptional cases, this may not be possible.

You can then enter the current vehicle location manually in connection with an intersection.

- ▶ Turn the right-hand rotary/push-button  to highlight “Settings” in the main destination input menu and press to confirm.
- ▶ Turn the right-hand rotary/push-button  to highlight “Location...” and press to confirm.

The input menu to enter the city will appear.

- ▶ Enter the city/suburb and then the street and select the required entries from the corresponding list. See entering destination address (▷ page 123).

After you have selected the street, you will see a prompt for the intersection.

- ▶ Turn the right-hand rotary/push-button  to highlight the appropriate cross street and press to confirm.

The input menu “Location/Intersection” will appear.

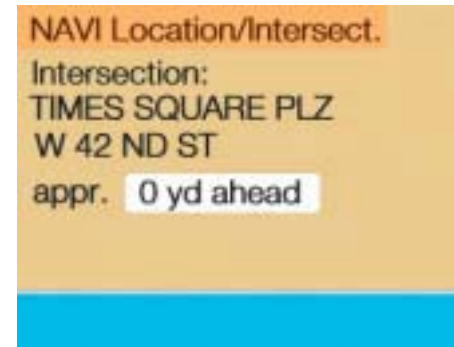

P82.85-9154-31

Location is ahead or behind an intersection

- ▶ Turn the right-hand rotary/push-button  to the right (location is ahead) or to the left (location is behind) and press to confirm.

The message “Chosen location accepted” will appear.

- ▶ Press the right-hand rotary/push-button  to confirm.

Calibration

In order to ensure an exact fix on position, you have to calibrate COMAND by entering the correct tire information whenever tires are changed.



Mercedes-Benz recommends that you have tires changed by an authorized Mercedes-Benz Center.

- ▶ Turn the right-hand rotary/push-button to highlight “Settings” in the main destination input menu and press to confirm.

A list of options will appear.

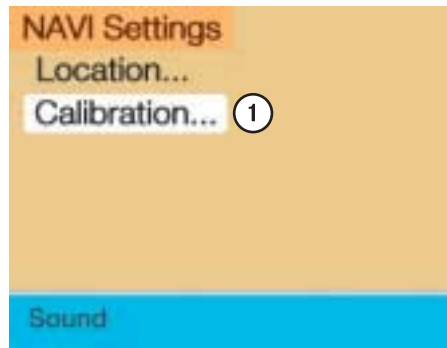

P82.85-9153-31

Menu “Settings”

- 1 Activate menu “Calibration”
- ▶ Turn the right-hand rotary/push-button to highlight **1** and press to confirm. The menu “Calibration” will appear.

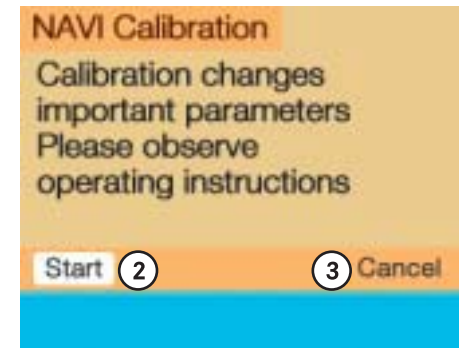

P82.85-9152-31

- 2 Enter the tread depth and the tire type
- 3 Return to the main destination input menu
- ▶ Press the right-hand rotary/push-button to start calibration. A list of options will appear.

Navigation

Settings



P82.85-9151-31

- 4 Tread depth \geq 4 mm (3/16 in.)
- 5 Tread depth $<$ 4 mm (3/16 in.)

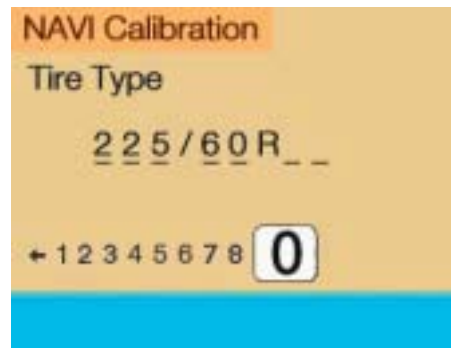

- ▶ Turn the right-hand rotary/push-button  to highlight the desired menu field and press to confirm.

An input menu will appear.



P82.85-9150-31

Enter the new tire type

-  Enter the front axle tire parameters.
- ▶ Turn the right-hand rotary/push-button  to highlight the appropriate digits one by one and press to confirm.

- ▶ Press the right-hand rotary/push-button  longer than 2 seconds to confirm the entry.

The main destination input menu will appear.

Info Services/System settings

Info Services*

System settings

Auxiliary audio source

Info Services/System settings

Info Services*

In chapter “Info Services/System settings” you will find detailed information on the following topics:

- Requesting and displaying Info Services



This function is not available in some countries.

- Adjusting the brightness
- Selecting the language for the menu text displays and the voice output
- Setting the date and time
- Selecting beep tones
- Setting the display dimming characteristics (day and night display)
- Resetting all settings to the factory settings
- Switching an auxiliary audio source on and off

Info Services*

If you have not done so already, please familiarize yourself with these functions by reading the chapter “At a glance” (▷ page 6).

Requesting and displaying Info Services

When you subscribe to Info Services, you can download information directly to your COMAND. You can select from news, weather, sports, stocks, and calendar reminders.

To personalize your selections visit

- www.MBUSA.com or call
- 1-800-FOR-MERcedes.



Before you can use Info Services, Tele Aid must be activated at the Response Center and Info Services selected.

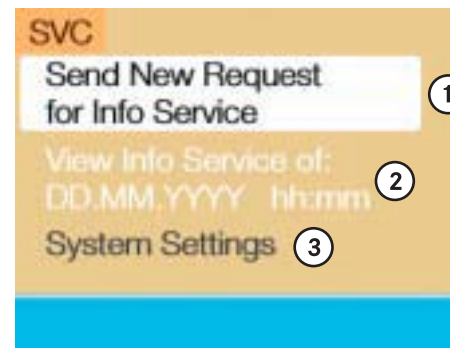

P82.85-9241-31

Main service menu

- 1 New information service is requested from Response Center
- 2 Shows date and time of the message
- 3 The main settings menu will appear (▷ page 187)

Info Services/System settings

Info Services*

- ▶ Press **SVC** in any menu.
The main service menu will appear.



The characters are displayed in light grey

- In 1 During an active request transmission
 - In 2 If no information is available
- ▶ Press the right-hand rotary/push-button to confirm 1.
New information service is requested from the Response Center.

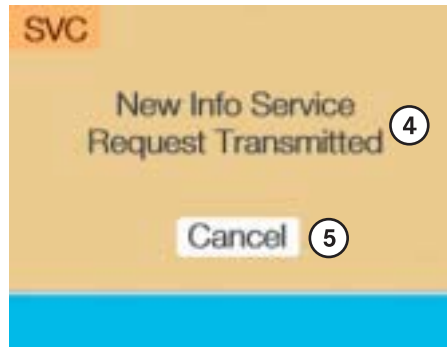

P82.85-9242-31

- 4 This message appears
- 5 Cancels the request

You will hear a beep tone if there is a new incoming message.

There are three ways to cancel the request and switch to a main menu, e.g. radio main menu:

- ▶ Press the right-hand rotary/push-button and confirm "Cancel".
- ▶ Press **BACK**.
- or
- ▶ Automatically after 15 seconds.

Info Services/System settings

Info Services*



If information cannot be retrieved, one of the following messages will be displayed:

- “Data Connection Cannot be Established”
Request has failed because Response Center cannot be accessed. Try again later.
- “No Cellular Connection Available”
Vehicle may be in a cellular weak signal area. Try again later.
- “Cellular System Busy”
Request has failed because cellular system is busy. Try again later.
- “Data transmission failure”
Request has failed because a data transfer error has occurred. Try again later.



- “Tele Aid Call in Progress”
Request has failed because SOS or Roadside call is in progress.
- “Tele Aid. Please visit workshop”
A hardware error has been detected. Contact your Mercedes-Benz Center.
- “To subscribe to information services dial phone number”
You have not yet subscribed to service.
- “No information available at this time. Press SVC.”
No new information is available.

Warning



A driver’s attention to the road must always be his/her primary focus when driving.

For your safety and the safety of others, we recommend that you pull over to a safe location and stop the vehicle before requesting or receiving any info services.

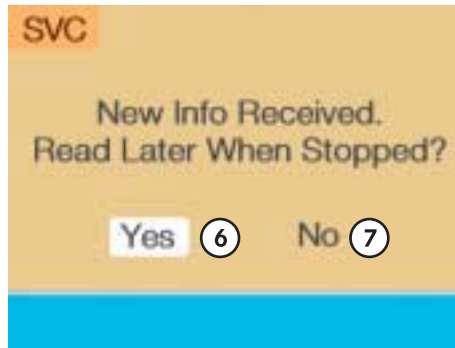

P82.85-9243-31

- 6 Displays the new message
- 7 Switches back to the main menu

There is more than one message

- ▶ Press the right-hand rotary/push-button **▶** to move to the next page.

Activating the main service menu

- ▶ Press **BACK**.

Switching back to e.g. radio main menu

- ▶ Turn the right-hand rotary/push-button **▶** to highlight “No” and press to confirm.

System settings

Activating the main settings menu

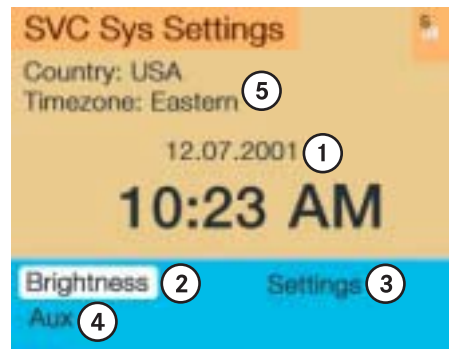

P82.85-9244-31

Main system settings menu

- 1 Date and time
You can select the time format
(▷ page 196)
- 2 Adjusting the brightness
- 3 Activating “Settings” menu
- 4 Switching an auxiliary audio source on
(▷ page 200)
- 5 Country setting, with a time zone
(▷ page 192)

Info Services/System settings

System settings

- ▶ Press **SVC**.
- The main service menu will appear.
- ▶ Turn the right-hand rotary/push-button **▶** to highlight “System Settings” and press to confirm.

The main system settings menu will appear.



You will see information **5** if the clock has been set to GPS reception and if a country, e.g. USA and a time zone was selected.

Info Services/System settings

System settings

Adjusting the brightness

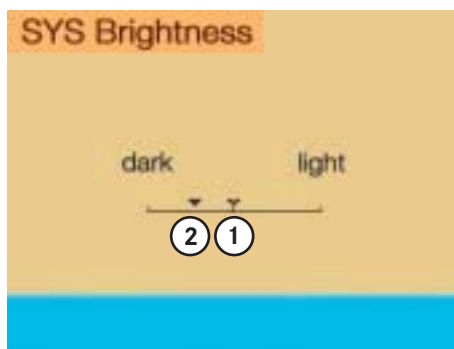

P82.85-7710-31

- 1 Previous settings
- 2 Current settings

- ▶ Press the right-hand rotary/push-button ● to confirm "Brightness".
The "Brightness" menu will appear.

Darkening screen

- ▶ Turn the right-hand rotary/push-button ● to the left.
The triangle **2** will move to the left.

Brightening screen

- ▶ Turn the right-hand rotary/push-button ● to the right.
The triangle **2** will move to the right.

Confirming new settings

- ▶ Press the right-hand rotary/push-button ●.
The main system settings menu will appear.

Activating settings menu

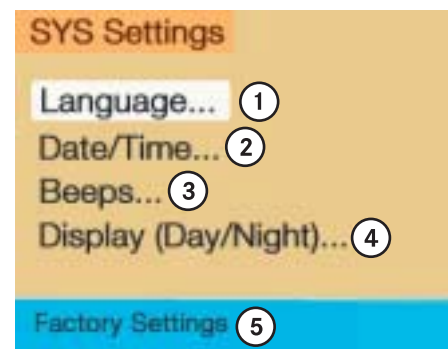

P82.85-9245-31

Settings menu

- 1 Selecting the language
Navigation CD must be inserted
- 2 Setting date and time (▷ page 190)
- 3 Switching beep tones on and off
(▷ page 197)
- 4 Setting the display dimming characteristics (day and night display)
(▷ page 198)
- 5 Resetting all settings to the factory settings (▷ page 199)

- ▶ Turn the right-hand rotary/push-button **●** to highlight “Settings” in the main system settings menu and press to confirm.

The settings menu will appear.

Selecting the language

The language affects the menu text displays and the voice output during route guidance.

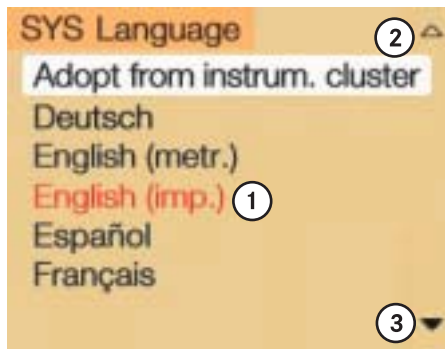

- 1 Current language setting appears in red
- 2 Page back, if the arrow is filled in
- 3 Page forward for more languages

Info Services/System settings

System settings

- ▶ Press the right-hand rotary/push-button **●** to confirm “Language...” in the settings menu.

The languages list will appear.

- ▶ Turn the right-hand rotary/push-button **●** to highlight the desired language and press to confirm.

COMAND displays the message “Loading the xx language” and loads the selected language.

You will hear the corresponding voice output.

After that, the main system settings menu will appear with the display text in the language selected.

System settings

You can select the following languages

- “Adopt from Instrument Cluster”
COMAND will use the same language as is set in instrument cluster
- “Deutsch”
- “English” (metric)
Distance measured in km, speed in km/h
- “English” (imperial)
Distance measured in yards and miles, speed in miles per hour (mph)
- “Español”
- “Français”
- “Italiano”
- “Nederlands”

Setting date and time

COMAND is equipped with an integrated clock, which it shows in the main system settings menu.



The clock displays e.g. the estimated time of arrival at the destination during route guidance.

Automatically

COMAND automatically sets date and time if the GPS time is received.

However, you can make the following adjustments:

- Set the time in increments of 30 minutes (▷ page 191)
- Set the time by selecting a country and the time zone (▷ page 192)

Manually

You must always set the clock manually (▷ page 195), if

- COMAND does not receive a GPS time
- the clock has been disconnected from the vehicle battery
- the dates of the change between summer and winter time are not available

Setting the time in increments of 30 minutes

You can set the the time to any local time (time zone) in increments of 30 minutes.

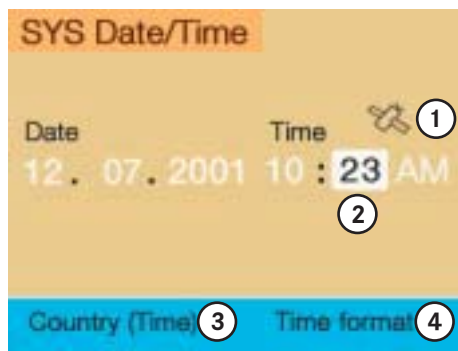

P82.85-7714-31

- 1 COMAND receives GPS time
- 2 Setting the clock (increments of 30 minutes)
- 3 Selecting the country and the time zone (▷ page 192)
- 4 Selecting the time format (▷ page 196)

- ▶ Turn the right-hand rotary/push-button ● to highlight “Date/Time...” in the settings menu and press to confirm. The menu displays the date and the time, minutes are highlighted.

Info Services/System settings

System settings

Activating the setting mode

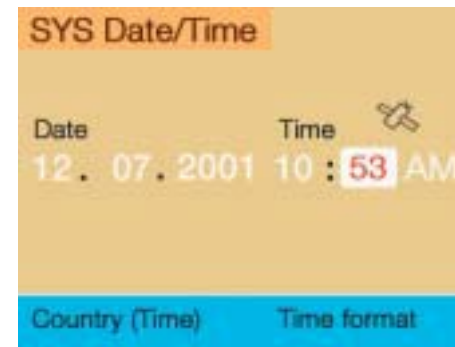

P82.85-7715-31

- ▶ Press the right-hand rotary/push-button ●. Setting mode is active, the minutes will appear in red.

Info Services/System settings

System settings

Altering the time

- Setting the clock ahead
 - ▶ Turn the right-hand rotary/push-button **⬤** to the right.
Each click will move the time 30 minutes ahead.
- Setting the clock back
 - ▶ Turn the right-hand rotary/push-button **⬤** to the left.
Each click will move the time 30 minutes back.

Canceling setting mode

- ▶ Press the right-hand rotary/push-button **⬤**.
The minutes appear in black lettering.

Switching back to the main system settings menu



P82.85-9248-31

- ▶ Press **BACK**.
or
- ▶ Press the right-hand rotary/push-button **⬤** longer than 2 seconds.
You will see the new time.

Selecting the country and the time zone

You can select among several countries. If a country has multiple time zones, e.g. Canada and USA, you can select the applicable time zone.

COMAND will indicate this information in the main system settings menu.

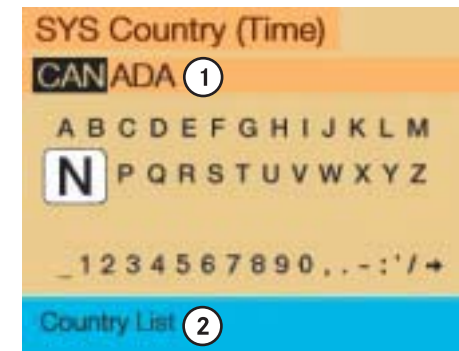

P82.85-9249-31

- 1 Input line
- 2 Activating country list

- ▶ Turn the right-hand rotary/push-button **●** to highlight “Country (Time)...” in the settings menu and press to confirm.

An input menu will appear.

- ▶ Turn the right-hand rotary/push-button **●** to highlight the initial letter for the country name and press to confirm.

The letter appears in **1**.

- ▶ Enter additional letters.

- ▶ Press the right-hand rotary/push-button **●** longer than 2 seconds.

or

- ▶ Turn the right-hand rotary/push-button **●** to highlight “Country List” and press to confirm.

The country list appears.

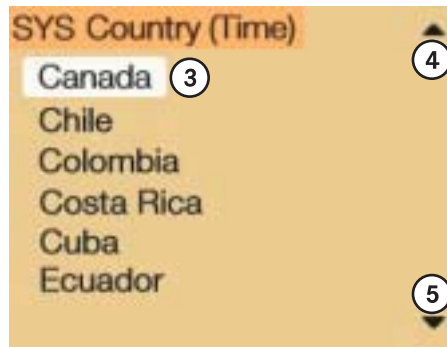

P82.85-9250-31

Country list

- 3** Country entered previously
- 4** Page back for more countries
- 5** Page forward for more countries
- ▶ Turn the right-hand rotary/push-button **●** to highlight the desired country in the list and press to confirm.

The time zone list appears for countries with several time zones (e.g. Canada, USA).

Selecting time zone



P82.85-9251-31

- ▶ Press the right-hand rotary/push-button **●** longer than 2 seconds to confirm the country.

The “Timezone” menu will appear showing the available time zones.

- ▶ Turn the right-hand rotary/push-button **●** to highlight the required time zone and press to confirm.

- ▶ Then set the automatic time conversion as described next.

Info Services/System settings

System settings

Automatic time conversion



P82.85-9252-31

1 Setting change summer/winter time

Position 1



Automatic summer/winter time

Summer time

Meaning

The time in this country/timezone changes, the dates of the time change are known

The dates of the time changes are not known, the change to winter time must be made manually

- ▶ Press the right-hand rotary/push-button .
Checkmark indicates that automatic time change is active.
- ▶ Press the right-hand rotary/push-button  longer than 2 seconds.
The settings are adopted and the main system settings menu will appear.

Manually setting date and clock

You must manually set the date and clock, if

- COMAND does not receive a GPS time
- the clock has been disconnected from the vehicle battery
- the dates of the change between summer and winter time are not available

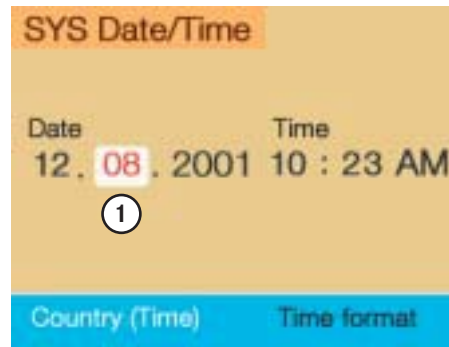

P82.85-7719-31

Date/time menu

- 1 Day, month, year, hours, minutes
Day is highlighted when the menu appears
- ▶ Turn the right-hand rotary/push-button  to highlight "Date/Time..." in the settings menu (▷ page 188) and press to confirm.



The menu displays date and time.

Setting

- ▶ Press the right-hand rotary/push-button .

The day appears in red letters, setting mode is active.

Move the day forwards or back

- ▶ Turn the right-hand rotary/push-button  to the right or left.
- ▶ Press the right-hand rotary/push-button .

The day appears in black letters, setting mode is switched off. The cursor moves one position to the right.

- ▶ Repeat the operating steps to subsequently change month, year, hours and minutes.

Info Services/System settings

System settings

Adopting settings

- ▶ Press the right-hand rotary/push-button  longer than 2 seconds.

The main system settings menu will appear with the changed settings.



If you have selected an invalid setting, the message “Invalid input” will appear.

Selecting the time format

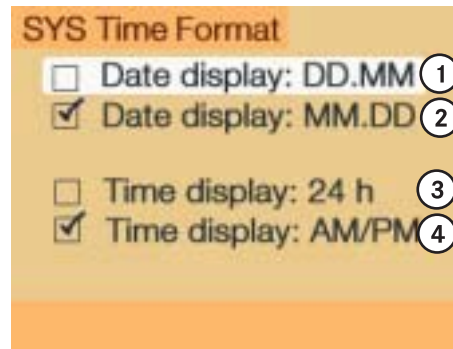

P82.85-9253-31

- 1 Date display in day, month format
- 2 Date display in month, day format
- 3 Time display in 24-hour format
- 4 Time display in 12-hour format

- Setting is active
- Setting is not active

In the “Date/Time” menu

- ▶ Turn the right-hand rotary/push-button  to highlight “Time format” and press to confirm.

The “Time format” menu will appear.

Setting

- ▶ Turn the right-hand rotary/push-button  to highlight the desired entry and press to confirm. A checkmark will appear .



If the 12-hour format is selected, either AM (ante meridiem) or PM (post meridiem) will appear after the time.

Adopting settings

- ▶ Press the right-hand rotary/push-button **⬇** longer than 2 seconds.
The main system setting menu will appear.
- or
- ▶ Press **BACK**.
The “Date/Time” menu will appear.



P82.85-9254-31

- 1 Acknowledgement beep
- 2 Info beep
- Tone is switched on
- Tone is switched off

Info Services/System settings

System settings

- ▶ Turn the right-hand rotary/push-button **⬇** to highlight “Beeps” in the settings menu and press to confirm.
The “Beeps” menu will appear.
- ▶ Turn the right-hand rotary/push-button **⬇** to highlight **1** or **2** and press to confirm.
The beep selected is switched on or off accordingly.
Acknowledgement beep
You will hear this beep if you confirm a function or select an entry.
Info beep
You will hear this beep if COMAND provides information, e.g. navigation turn is approaching.

Info Services/System settings

System settings

Setting the display dimming characteristics (day and night display)

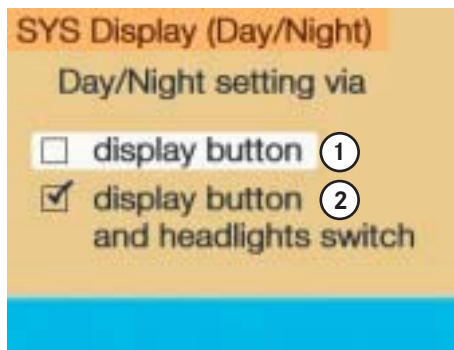

P82.85-9255-31

- 1 Changes by pressing **DISP**
- 2 Changes by pressing **DISP** and headlights switch

- Setting active
- Setting not active

If the settings menu (▷ page 188) is displayed

- ▶ Turn the right-hand rotary/push-button ● to highlight “Display (day/night)...” and press to confirm.

The “Display (Day/Night)” menu will appear. The setting **2** is active, when calling up the menu for the first time.

- ▶ Turn the right-hand rotary/push-button ● to highlight the desired setting and press to confirm.

The desired setting is active.

Setting **2** has been selected

When the headlights are switched on, the screen will change to night display.

Changing the display

- ▶ Press **DISP** to access the following displays in succession.
 - Day display
 - Night display
 - Screen off
 - and the Day display again

Resetting all settings to the factory settings

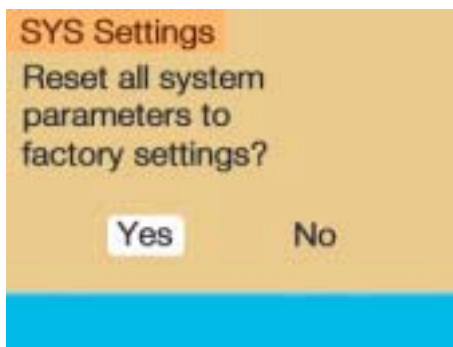

P82.85-7723-31

If the settings menu is displayed

- ▶ Turn the right-hand rotary/push-button  to highlight “Factory settings” and press to confirm.

An inquiry menu will appear. “Yes” is highlighted.

Accepting the factory settings

- ▶ Press the right-hand rotary/push-button .

A screen with the factory setting will appear for 8 seconds.

The main system settings menu is reactivated.

Info Services/System settings

System settings

The factory settings are:

- Acknowledgement beep – off
- Info beep – off
- Language – English (imp.)
- Time display – 24 h
- Date format – DD.MM (day, month)

If you do not wish to reset the factory settings

- ▶ Turn the right-hand rotary/push-button  to highlight “No” and press to confirm.

The main system settings menu will appear.

Info Services/System settings

Auxiliary audio source

Auxiliary audio source

Connecting



Mercedes-Benz recommends that any auxiliary audio unit is installed and connected by an authorized Mercedes-Benz Center.

The auxiliary audio source (e.g. tape recorder) will be installed in the glove compartment of your vehicle and connected to the socket available for this purpose. You will require a separate connecting cable for this.



Refer to the separate operating instructions for information on how to operate the auxiliary audio source (e.g. CD changer).

COMAND will play back voice outputs during route guidance even if the auxiliary audio source has been switched on.

It is possible to use the telephone while the auxiliary audio source is in operation.

Switching auxiliary audio source on



P82.85-7724-31

1 Adjusting sound settings (> page 63)

- ▶ Turn the right-hand rotary/push-button  to highlight “Aux” in the main system settings menu and press to confirm.

The “Aux” menu will appear. The auxiliary audio source will switch on if it has been connected to the COMAND control unit.

Adjusting the volume (▷ page 14).



The sound adjustments for the auxiliary audio source are independent of those selected for the COMAND audio sources.

Adjusting the volume level of an auxiliary audio source

- ▶ Adjust volume of vehicle radio to a comfortable listening level.
- ▶ Connect adapter cable to portable tape deck and to vehicle (socket in glove box).
- ▶ Press **svc** button on COMAND unit.
- ▶ Activate the “Aux” menu as described.
- ▶ Press “Play” button on the portable tape deck.
- ▶ Adjust the volume on the portable tape deck so that the audio system output is at or near the same comfortable level previously set in radio mode.
- ▶ Volume can now be adjusted using either COMAND or volume controls on multifunction steering wheel.



Only the volume setting of the tape player can be controlled using the COMAND system.

Muting auxiliary audio source

- ▶ Press **MUT**.
Symbol  will appear.

Canceling mute function

- ▶ Press **MUT** again.
Symbol  will disappear.

Info Services/System settings

Auxiliary audio source

Switching auxiliary audio source off

- ▶ Press e.g.  on the COMAND control unit.

The COMAND audio source selected will switch on.

Audio source

This includes the systems radio and CD (CD drive in the control unit and CD changer) as well as an external source, e.g. tape recorder.

COMAND

(Cockpit Management and Data System)

Information and operating center for vehicle sound and communications systems, including the radio and CD player, as well as for other optional equipment (CD changer, telephone, etc.).

Emergency call

This function places a call to a local 9-1-1 provider. It does not initiate a ->TELE AID call. Please note that the 9-1-1 emergency call system is a public service. Using it without due cause is a criminal offense.

GPS

(Global Positioning System)
Satellite-based system for relaying geographic location information to and from vehicles equipped with special receivers. Employs CD digital maps for navigation.

Heading-up

The map is displayed facing driving direction pointing up during route guidance.

Info Services*

With this function you can request information on news, weather, stocks, sports and reminders. Info Services is an additional optional feature to basic Tele Aid service. Tele Aid can be initially activated by completing a subscriber agreement and placing an acquaintance call.

Mix

Display representation during destination guidance. The symbol display is activated automatically from the map display before a turn-off. After you have made the turn, the map will appear again.

Multifunction display

Two displays in the combination instrument that show important information about the COMAND systems radio, CD and telephone. The displays can be called up using the control buttons on the multifunction steering wheel.

Navigation CD

Contains all the destination addresses (town, road, intersection, house number, special destinations) and the digital map material for a country or a region for destination entry, route calculation and destination guidance.

Glossary

North-up

The map is displayed facing due north during route guidance.

Provider

is the network operator who makes available (provides) telephone services

Roaming

For this function, the telephone uses the telephone network of a contract partner. There are home type and non home type systems. COMAND displays the system currently used with the RM indicator.

Service numbers

includes a personal service number and the number for roadside assistance

Service source

This includes the systems telephone, navigation (voice output during destination guidance) and ->Voice recognition system

SMS

(Short Message Service)

With this function you can receive, read and delete short text messages (if SMS service is provided by your carrier)

TELE AID*

(Telematic Alarm Identification on Demand)

The Tele Aid system consists of three types of response: automatic and manual emergency, roadside assistance, and information. Tele Aid is initially activated by completing a subscriber agreement and placing an acquaintance call.

The Tele Aid system is operational providing that the vehicle's battery is charged, properly connected, not damaged, and cellular and GPS coverage is available.

Unlock code

Your unlock code prevents unauthorized persons from using your telephone. The unlock code is a number string, which you have to enter on switching on the telephone.

Voice output

During a trip, apart from visual informations (symbol or map displays), COMAND also provides all of the necessary spoken route information via voice output.

Voice recognition system

One of the service sources of COMAND.

As voice-operated control system, it controls the COMAND systems via voice. Refer to the separate operating instructions.

A

- Adjust
 - Sound 63
 - for audio sources 63
 - for service sources 64
 - Sound-center 65
 - Volume difference 64
- Adjusting the volume 14
- Amplifier 66
- Arrow indicating the direction to the destination 143
- Audio sources 63
 - Auxiliary audio source 200
 - connecting 200

B

- Beeps 197
 - Acknowledgement beep 197
 - Info beep 197

C

- Calibration 181

CD operation

- CD track scan 55
- Fast forward/backward 54
- Naming CD 55
 - Deleting a CD name 57
- Playback mode 58
- Selecting a CD 53
- Track select 51

Changing the navigation CD 45, 119

COMAND control unit 6

Cross hairs 132

moving 132

Current vehicle location 132

D

Date and time 190

AM 196

automatic time conversion 194

automatically setting 190

manually setting 195

PM 196

selecting country and time zone 193

selecting time format 196

setting the time in 30 minute steps 191

Day and night display 21, 198

Destination

confirming on the map 134

Destination address 123

Points of Interest 137

requesting 147

saving 175

selecting the last destinations 141

selecting via the map 131

Destination and route information 147

Location map 149

Route list 148

Route map 151

Stop-over (way point) 151

Destination flag 170

Destination memory

deleting a destination 179

sorting 178

Index

- Detour
 - calculating 164
 - Traffic jam ahead 164
- Dialing
 - from calls list 94
 - Redial 91
 - Speed dialing 95
 - Subsequent dialing 84
- Dialing operation 83
- Distance bar 145
- E**
- Emergency call 106
 - entering emergency call number 107
 - initiating 107
- Ending a call
 - at the COMAND control unit 81
 - at the multifunctional steering wheel 79
- Enter
 - Unlock code 78
- Entering
 - House number 129
 - Intersection 128
 - Vehicle location 180
- Error messages
 - CD operation 60
- F**
- Factory settings
 - reset 199
- Fault messages
 - during preparation of navigation startup 122
- G**
- GPS 114
 - GPS time 191
- I**
- Important notes
 - Navigation 112
 - Telephone 68
- Incoming call 79
 - accepting at the COMAND control unit 80
 - accepting at the multifunctional steering wheel 79
 - refusing a call 81
- L**
- Language
 - selecting 189
- Latitude 135
- List
 - Country list 193
 - Route list
 - detailed route list 166
 - route list 165
- Loading
 - CD drive with an audio CD 45
 - CDs in the changer 45
- Longitude 135

M

Main menu structure 9

Map

altering the map scale 133

Compass needle 159

Heading-up 159

Map with cross hairs 132

moving the cross hairs 132

North arrow 159

North-up 159

Symbol for current vehicle

location 159

Memory functions

Radio operation 34

Menu

“City/Suburb” input menu 124

“Destination info” selection
menu 147

“Incoming calls memory” 94

“Phone book” 98

“Phone book” selection menu 87

“Points of Interest” selection
menu 137

“Settings” 188

“Street” input menu 126

“Way point” 160

Category list 137

Main address menu 123

Main destination entry menu 122

Main destination memory menu 174

Main radio menu FM 28

Main system setting menu 184, 187

Phone book page (names) 88

Phone book pages (phone
numbers) 90Ready for operation display
(Telephone) 78

SMS view 104

Traffic jam menu 164

Menu fields 9

Menu overview

CD operation 48

Destination input 120

Radio operation 26

Telephone mode 76

Message

“Being activated” 61

“CALC. ROUTE” 145

“Caution. COMAND will shut down
now”. 10“Caution. Please start engine. Otherwi-
se COMAND will shut down in 10
seconds” 10“Caution. Please start engine. Otherwi-
se COMAND will shut down in 3
minutes” 10

“CD Magazine empty” 60

“CD-Reading error. Please use another
CD” 122“Compiling sorted destination
list” 174, 179

Index

- “DEST AREA” 145
 - “Destination memory is full” 175
 - “Error” 61
 - “Loading CD ...” 50
 - “Manual route exclusions have been reset” 169
 - “Navigation cannot be activated. An error has occurred” 122
 - “NEW ROUTE” 145
 - “No CD available. Please insert NAVI-CD type DX only” 122
 - “No CD changer” 60
 - “No CD” 60
 - “No magazine” 60
 - “NO ROUTE” 145
 - “No telephone” 69
 - “OFF ROAD” 145
 - “Personal service number” 108
 - “Reading error” 61
 - “Roadside Assistance” 108
 - “SMS loading...” 103
 - “Telephone defective” 69
 - “Telephone is being activated. Please wait.” 69
 - “Temperature is too high” 61
 - “The route list is being calculated” 165
 - “Voice output is muted” 153
 - CALL 79
 - Mix 157
 - Multifunction display 11
 - CD operation 62
 - Radio operation 40
 - Telephone mode 71
 - Display overview 72
 - Muting 28
 - CD playback 60
- N**
- Notebook 97
- O**
- Outgoing calls 82
- P**
- Phone book 98
 - adding an entry 101
 - changing entries 98
 - deleting an entry 101
 - Phone number
 - begin dialing 83
 - correcting 83
 - interrupt dialing 83
 - Points of Interest
 - entering 137
- Q**
- Quick reference
 - CD operation 42
 - Navigation 116
 - Radio operation 24
 - Quick reference COMAND 12

R

- Radio station
 - automatically saving 36
 - deleting in memory 39
 - manually saving 36
 - saving station manually 34
 - selecting from memory 37
- Reception quality of the mobile phone 9
- Redial 91
- ROAM indicator 77
- Route
 - calculating 141
 - including or avoiding traffic routes 142
 - selecting calculation mode 141
 - cancel route calculation 143
 - Fast route 141
 - selecting 142
 - Short route 141

Route guidance

- advance notice of right turn 154
- arriving at destination 170
- beginning 152
- beginning (way point) 161
- canceling 173
- changing to the map display 156
- deviating from the calculated route 168
- following the course of the road 155
- Mix of map and symbol display 157
- retrieving a destination 174
- turning onto a street 154

S

- Saving
 - current destination 175
 - current vehicle location 177
 - Radio station 34, 36
- Screen displays 9

Selecting

- City center 130
- Destination via the map 131
- Service number
 - changing number for roadside assistance 110
 - changing personal service number 109
- Service numbers 108
 - calling 108
- Service sources 63

Setting

- Date and time 190
 - automatically 190
- date and time
 - manually 190

Settings

- Brightness (system) 188
- Factory settings 199

Index

- SMS 103
 - deleting 105
 - Incoming SMS message 9
 - Sound 63
 - Setting Bass/Treble/Balance 65
 - Sound impressions 66
 - Sound-center
 - Balance 64
 - Fader 64
 - Speed dialing (only with COMAND) 95
 - Station
 - Radio station
 - Automatic station scan 33
 - Manual tuning 31
 - Seek tuning 30
 - selecting 30
 - Station selection via direct frequency entry 32
 - Station selection via number keypad (presets) 32
 - Station frequency 28
 - Storing
 - in the phone book 102
 - Notebook input 97
 - Street list 127
 - Switch on
 - Radio operation 28
 - Switching another system on
 - CD mode 28
 - Radio operation 50
 - Switching off
 - Beeps 197
 - COMAND control unit 13
 - Mix 157
 - Telephone mode 79
 - Switching on
 - Auxiliary audio source 200
 - Beeps 197
 - CD operation 15, 50
 - COMAND control unit 12
 - Mix 157
 - Navigation 122
 - Navigation system 17
 - Radio operation 14
 - Telephone operation 16
 - Telephone mode 78
 - Symbol display 144
- T**
- Travelling abroad 114
- V**
- Voice output
 - “Bear left after 250 feet” 155
 - “Please bear left” 155
 - “Please, make the next right turn” 143
 - “Prepare to turn right” 154

“The route is being calculated” 142
“The route to your intermediate destination is being calculated” 161
“Turn right after 250 feet” 154

W

Way point
 deleting 162

Index

212

Index

214

Index

216

We reserve the right to modify
the technical details
of the COMAND system as given
in the data and illustrations
of this Operator's Manual.

Reprinting, translation and copying,
even of excerpts, is not permitted
without prior authorization in writing.

Press time: 05/08/2002

Printed in Germany

Free Manuals Download Website

<http://myh66.com>

<http://usermanuals.us>

<http://www.somanuals.com>

<http://www.4manuals.cc>

<http://www.manual-lib.com>

<http://www.404manual.com>

<http://www.luxmanual.com>

<http://aubethermostatmanual.com>

Golf course search by state

<http://golfingnear.com>

Email search by domain

<http://emailbydomain.com>

Auto manuals search

<http://auto.somanuals.com>

TV manuals search

<http://tv.somanuals.com>