

555-8421-211

Meridian Digital Telephone IP Adapter

Installation and Administration Guide

Product release 1.3

Standard 1.1

October 2001

NORTEL
NETWORKS

Meridian Digital Telephone IP Adapter Installation and Administration Guide

Product release:	1.3
Publication number:	555-8421-211
Document release:	Standard 1.1
Date:	October 2001

Copyright © 2001 Nortel Networks, All Rights Reserved.

Printed in Canada.

All information contained in this document is subject to change without notice. Nortel Networks reserves the right to make changes to equipment design or program components, as progress in engineering, manufacturing methods, or other circumstances may warrant.

*Nortel Networks, the Nortel Networks logo, the Globemark, and Unified Networks, Meridian 1, MSL-100, and Succession Communication Server for Enterprise 1000 are trademarks of Nortel Networks.

MICROSOFT, MS-DOS, WINDOWS, and WINDOWS NT are trademarks of Microsoft Corporation.

Publication history

October 2001

This is the Standard 1.1 issue of the *Meridian Digital Telephone IP Adapter Installation and Administration Guide* (NTP 555-8421-211). This document provides product descriptions, planning, installation, configuration, administration, and troubleshooting information for the Remote Office Product release 1.3 of the Meridian Digital Telephone IP Adapter unit.

Contents

About this document	xv
About this guide	xvi
<i>How to use this guide</i>	xvi
Product overview	xvii
Skills you need	xviii
<i>Nortel Networks product knowledge</i>	xviii
<i>Telecommunications knowledge</i>	xviii
<i>Data networking knowledge</i>	xix
Conventions used in this guide	xx
<i>Precautionary messages</i>	xx
<i>Instructions for selecting menu options</i>	xx
<i>Instructions for displaying property sheets</i>	xx
<i>PBX terminology</i>	xxi
Related information products	xxii
<i>Printed documents</i>	xxii
<i>CD-ROM</i>	xxiii

1 Meridian Digital Telephone IP Adapter description	1
Product Introduction	2
<i>Meridian Digital Telephone Internal IP Adapter circuit card</i>	2
<i>Meridian Digital Telephone External IP Adapter unit</i>	3
<i>Reach Line Card</i>	3
<i>Voice over IP technology</i>	3
<i>Configuration - Device and Software</i>	4
Hardware description	5
<i>Meridian Digital Telephone IP Adapter unit LEDs</i>	5
<i>Meridian Digital Telephone IP Adapter unit LED display diagrams</i>	6
<i>Meridian Digital Telephone Internal IP Adapter circuit card</i>	7
<i>Meridian Digital Telephone External IP Adapter unit</i>	7
<i>Universal power supply support - Meridian Digital Telephone Internal IP Adapter circuit card</i>	8
<i>Universal power supply support - Meridian Digital Telephone External IP Adapter unit</i>	9
<i>Internet Access Device description</i>	10

Connection options	11
<i>10BaseT Ethernet interface</i>	11
How Meridian Digital Telephone IP Adapter units work.	12
<i>Outgoing call process</i>	13
<i>Incoming call process</i>	13
<i>Host-controlled call mode</i>	13
<i>Call scenario 1: host-controlled—corporate internal call</i>	14
<i>Call scenario 2: host-controlled—corporate external call</i>	16
System security	18
<i>No security</i>	18
<i>Security identifier</i>	18
Telephones	19
<i>Supported digital telephones</i>	19
<i>Required footstand for Meridian Digital Telephone Internal</i>	
<i>IP Adapter units</i>	19
<i>Supported telephone modules</i>	19
<i>Supported telephone features</i>	20
<i>Computer telephony integration applications</i>	20
<i>Automatic Call Distribution (ACD) applications</i>	21
Online/Offline Table.	22
Emergency service number.	23
Configuration Manager.	24
Power requirements	25
<i>Input specifications</i>	25
<i>Output specifications</i>	25

2 Planning for installation 27

Physical environment	28
<i>Space</i>	28
<i>Temperature</i>	28
<i>Mounting options</i>	30
<i>Cables included with the Meridian Digital Telephone Internal</i>	
<i>IP Adapter circuit card</i>	30
<i>Cables included with the Meridian Digital Telephone External</i>	
<i>IP Adapter unit</i>	30
<i>Cables you must supply yourself</i>	30
Administration PC	31
<i>Connection options</i>	31
<i>Ethernet connection</i>	31
<i>Administering multiple nodes in the network</i>	32
<i>Windows PC requirements</i>	32

Network considerations	34
<i>IP addressing and routing</i>	34
<i>Determining DHCP Assigned IP Addresses</i>	34
Deployment.	36
<i>Transport media</i>	36
<i>Network Address Translation</i>	36
<i>IP deployment</i>	37

3 Installing the Meridian Digital Telephone IP Adapter unit 39

Preparing for installation	40
<i>General Safety</i>	40
<i>Required hardware and software tools</i>	41
<i>Unpacking and inspecting the equipment</i>	41
Installing the Meridian Digital Telephone Internal IP Adapter circuit card.	42
<i>Removing the footstand of the digital telephone</i>	42
<i>Inserting the Meridian Digital Telephone Internal IP Adapter circuit card</i>	43
<i>Installing ferrite beads</i>	45
<i>Connecting the Meridian Digital Telephone Internal IP Adapter circuit card</i>	46
<i>Powering up the Meridian Digital Telephone Internal IP Adapter circuit card</i>	47
Installing the Meridian Digital Telephone External IP Adapter unit	48
<i>Installing the Meridian Digital Telephone External IP Adapter unit on a desk</i>	48
<i>Installing the Meridian Digital Telephone External IP Adapter unit on the wall</i>	48
<i>Connecting the Meridian Digital Telephone External IP Adapter unit</i>	50
<i>Connecting the Meridian Digital Telephone External IP Adapter unit to the network</i>	51
<i>Powering up the Meridian Digital Telephone External IP Adapter unit</i>	52

4	Configuring the IP Adapter unit using the telephone menu	53
	Before you begin	54
	<i>Information you need to know before configuring</i>	54
	<i>Accessing the telephone menu</i>	55
	<i>Telephone menu key function</i>	55
	<i>Backing up while in the telephone menu</i>	56
	<i>Exiting the system using the Release key</i>	56
	Running the telephone menu script	57
5	Changing configuration settings using Configuration Manager	81
	Before you begin	82
	Meridian Digital Telephone IP Adapter unit system configuration	83
	<i>Configuring the system settings</i>	84
	<i>Meridian Digital Telephone IP Adapter System Configuration field descriptions</i>	85
	IP configuration	88
	<i>Configuring IP information</i>	89
	<i>IP Configuration field descriptions</i>	90
	RLC connection configuration	91
	<i>Configuring the RLC connection information</i>	92
	<i>RLC Connection configuration field descriptions</i>	93
6	Using the digital telephone	95
	Modes of operation	96
	<i>Host-controlled mode</i>	96
	<i>Online mode</i>	96
	<i>Offline mode</i>	96
	<i>What controls the online and offline modes</i>	96
	Placing and receiving calls	98
	<i>Receiving incoming calls</i>	98
	<i>Methods for placing outgoing calls</i>	98
	<i>Placing a host-controlled call</i>	98
	<i>To call another station at your site—host-controlled mode</i>	99
	Indicator updates	100
	<i>Host-controlled indicator updates</i>	100
	Display messages	101
	<i>Message descriptions</i>	101

Telephone features operation	103
<i>Emergency service calls</i>	103
<i>Hold</i>	103
<i>Call Waiting</i>	103
<i>Call Transfer</i>	104
Going online and offline.	105
<i>Using the SPRE code to place your unit in online mode</i>	105
<i>Using the SPRE code to place your unit in offline mode</i>	105
<i>Overriding an automatic offline event from the host PBX</i>	106

7 Administration 107

Changing the administration password.	108
<i>Changing the Configuration Manager password</i>	108
<i>Changing the Meridian Digital Telephone IP Adapter unit's password</i>	109
Creating a backup configuration file	110
<i>Storing backup configuration files</i>	110
<i>Creating the backup file</i>	111
Restoring the configuration	113
<i>Before you begin</i>	113
<i>Uploading a configuration file over the IP network</i>	114
Display logs	118
<i>Viewing display logs</i>	118
<i>Printing the display logs to a file</i>	119
<i>Changing the number of display logs retained by the Meridian Digital Telephone IP Adapter unit</i>	120
<i>Clear logs</i>	121
Statistics screens	122
<i>Bandwidth Connection Statistics</i>	122
<i>Caller Information Statistics</i>	125
<i>Digital Signal Processor (DSP) Statistics</i>	128
<i>Ethernet Interface Statistics</i>	132
<i>Network Statistics</i>	136
Verifying the firmware and software version	139
<i>Verifying the software version</i>	139
<i>Verifying the firmware version</i>	140
<i>Determining the current firmware and software versions</i>	140
Obtaining the latest upgrade file.	141
<i>Types of upgrades</i>	141
<i>Downloading the upgrade file</i>	141
Extracting upgrade files from the download file	142
<i>Performing the extraction using Windows</i>	142

Performing a firmware upgrade	144
<i>When to perform a firmware upgrade</i>	144
<i>About firmware upgrades and configuration files</i>	144
<i>Before you begin</i>	144
<i>Upgrading the Meridian Digital Telephone IP Adapter unit</i> <i>firmware</i>	145
Restarting the system	147
<i>To restart the unit</i>	147
Performing a software upgrade	148
<i>Upgrading the Configuration Manager software</i>	148

8 Troubleshooting 149

Before you begin	150
<i>Identifying why a problem occurred</i>	150
Meridian Digital Telephone IP Adapter unit LEDs	152
Digital telephone	153
<i>Symptom descriptions</i>	153
Network connectivity	159
<i>System descriptions</i>	159
Software problems	162
<i>Symptom descriptions</i>	162
<i>Display Logs definitions</i>	162
Using Configuration Manager's PING	163
<i>Performing a Configuration Manager PING</i>	163
<i>Unsuccessful PING options</i>	165
Recovering from a catastrophic failure	166
Repair and warranty information	167
<i>Canada</i>	167
<i>United States</i>	167
<i>Europe</i>	167
<i>Asia/Pacific</i>	168
<i>CALA</i>	168

A Planning forms 169

IP Adapter Network Connections	170
IP Adapter Configuration Information—Dialing Plans	171
IP Adapter telephone menu— Configuration Values	172

B	Connection pin-out tables	175
	RJ-45 ethernet connector	176
	Admin (serial) connector pin-out table	177
	Power connector pin-out table	178
C	Equipment attachment notices	179
	Industry Canada	180
D	Safety and regulatory information	181
	International safety compliance	182
	<i>Underwriters Laboratory (UL)</i>	182
	<i>Canadian Standards Association (CSA)</i>	182
	<i>Europe</i>	182
	<i>Australia</i>	182
	<i>Other Countries Deviations Assessed</i>	182
	Electromagnetic compatibility	183
	Electromagnetic immunity	184
	Electrostatic discharge	185
	FCC requirements	186
	<i>Part 68</i>	186
	<i>Telephone network plug and jack</i>	187
	<i>Equipment harmful to the telephone network</i>	187
	<i>Party lines</i>	187
	Fields Index	219
	Index	223

Preface

About this document

In this preface

About this guide	xvi
Product overview	xvii
Skills you need	xviii
Conventions used in this guide	xx
Related information products	xxii

About this guide

The *Meridian Digital Telephone IP Adapter Installation and Administration Guide* (NTP 555-8421-211) is for telecom and data network managers and administrators who plan, install, and manage corporate telecommunications and data networks. This guide contains the following information:

- detailed descriptions of the Meridian Digital Telephone IP Adapter units
- procedures necessary to install, configure, and manage Meridian Digital Telephone IP Adapter units in a remote or branch office
- suggested troubleshooting procedures for addressing possible problems

This guide assumes that you are familiar with the following:

- basic telecommunications terminology
- basic networking terminology
- PC terminology and operation (specifically, Windows 95, Windows 98, or Windows NT 4.0)
- Nortel Networks PBX terminology, functionality, and administration

How to use this guide

This guide provides step by step procedures for installing, configuring, and managing the Meridian Digital Telephone IP Adapter unit as a part of your remote services network. Review this guide before beginning Meridian Digital Telephone IP Adapter unit installation and configuration.

When you are ready to begin, follow the steps for planning, installing, and configuring your hardware in the order that they are presented in this guide. This helps you to achieve a successful, trouble-free installation.

Product overview

Nortel Networks proudly presents Meridian Digital Telephone IP Adapter remote telecommunications equipment. The *Meridian Digital Telephone IP Adapter Installation and Administration Guide* (NTP 555-8421-211) provides information on configuring and maintaining your Meridian Digital Telephone IP Adapter unit.

The Meridian Digital Telephone IP Adapter unit allows your remote site to access a Reach Line Card (RLC) installed in the host PBX. A properly completed installation supplies your remote location with the full host PBX and.

To identify and locate documentation for the other elements of your Remote Office network, refer to “Related information products” on page xxii.

Skills you need

Knowledge of, or experience with, the following PC concepts as appropriate to your network is helpful when administering a Meridian Digital Telephone IP Adapter unit:

- Microsoft Windows
- software installation
- network configuration

Nortel Networks product knowledge

Knowledge of, or experience with, the following Nortel Networks products and concepts:

- basic administration of a Meridian 1, MSL-100, or Succession Communication Server for Enterprise 1000 PBX (telephone set and XDLC configuration)
- characteristics and principles of XDLC operation
- PBX data calls

Telecommunications knowledge

Knowledge of, or experience with, the following aspects of telecommunications:

- digital telephone set configuration
- ISDN PRI configuration
- trunk configuration
- PBX configuration
- PBX maintenance (SDI operation)
- knowledge of RS-232 signaling

Data networking knowledge

Knowledge of, or experience with, the following aspects of data networking:

- data link (Layer 2 of the OSI model)
 - IP protocol
 - routing
- network (Layer 3 of the OSI model)
 - addressing
 - traffic analysis and provisioning
 - configuration
- Voice over IP concepts

Conventions used in this guide

This section describes the symbols and text conventions used in this guide.

Precautionary messages

Note: A “Note” describes the secondary results of procedures or commands, or special conditions where you must use a procedure or command.

ATTENTION! _____
Provides information essential to the completion of a task.



CAUTION

Risk of data loss or equipment damage

Cautions you against unsafe practices or potential hazards, such as equipment damage, service interruption, or loss of data.

Instructions for selecting menu options

To simplify the instructions for selecting menu options, this guide abbreviates the selection path. For example, if you must choose Telnet from the Logon Unit menu, under the Connect menu, this guide uses the following style:

From the menu, choose Connect → Logon Unit → Telnet.

Instructions for displaying property sheets

To simplify the procedures for accessing property sheets throughout this guide, the instructions for displaying a particular property sheet are summarized in a “Getting there” statement.

The procedure for displaying the screen that you need depends on if you are:

- performing an online configuration (connected to a node by Telnet)
- performing an offline configuration (not connected to a node)

Example

Getting there 911x → Configuration Manager → IP Configuration

The long instruction for this example is shown below.

- 1 Do the following:

IF	THEN
you are performing an offline configuration	select the device type as described in “Selecting the device type for offline configuration” on page 125.
you are performing an online configuration	connect to, and then log on to the node as described in “Logging on to a unit” on page 126.

- 2 In the left pane, click on the plus sign (+) beside Configuration Manager to expand the node list.
- 3 Click on **IP Configuration**.

Result: The IP Configuration property sheet for the Meridian Digital Telephone IP Adapter unit displays in the right pane.

PBX terminology

Throughout this guide, the term “host PBX” refers to any of the following Nortel Networks PBX platforms:

- Meridian 1
- MSL-100
- Succession Communication Server for Enterprise 1000

Related information products

This section lists sources for additional information related to the Meridian Digital Telephone IP Adapter unit. You can order printed documentation and the CD-ROM from your Nortel Networks distributor.

You can also download the documentation in Portable Document Format (PDF) from the Nortel Networks website. To locate these documents, click on the Customer Support, Documentation, and North America links at the following website:

www.nortelnetworks.com

Note: The information available on the website may supersede the information provided on the CD-ROM.

For further details, refer to *Remote Office and RLC Release Notes* (NTP 555-8421-102).

Printed documents

The following documents provide additional information on Meridian Digital Telephone IP Adapter units and other elements of a Remote Office system:

***Remote Office Network Engineering Guidelines* (NTP 555-8421-103)**

The Engineering Guidelines, written for the installer/administrator, describe how a Remote Office system integrates with existing telecommunications and data networks. This document helps you to ensure that your networks are prepared for Remote Office.

***Remote Office and RLC Release Notes* (NTP 555-8421-102)**

The *Release Notes*, written for the installer/administrator, describe the features and known problems for the Reach Line Card (RLC), the Remote Office 9150 unit, Remote Office 911x series units, and Meridian Digital Telephone IP Adapter units.

Reach Line Card Installation and Administration Guide
(NTP 555-8421-210)

The *Reach Line Card Installation and Administration Guide*, written for the installer/administrator, describes how to install, configure, and manage the Reach Line Card on the host PBX.

Remote Office 9150 Installation and Administration Guide
(NTP 555-8421-215)

The *Remote Office 9150 Installation and Administration Guide*, written for the installer/administrator, describes how to install, configure, and manage the Remote Office 9150 unit.

Remote Office 911x Series Installation and Administration Guide
(NTP 555-8421-220)

The *Remote Office 911x Series Installation and Administration Guide*, written for the installer/administrator, describes how to install, configure, and manage Remote Office 911x series units.

CD-ROM

A Remote Office Product CD-ROM is available containing the documentation in Portable Document Format (PDF), firmware, and Configuration Manager software.

Chapter 1

Meridian Digital Telephone IP Adapter description

In this chapter

Product Introduction	2
Hardware description	5
Connection options	11
How Meridian Digital Telephone IP Adapter units work	12
System security	18
Telephones	19
Online/Offline Table	22
Emergency service number	23
Configuration Manager	24
Power requirements	25

Product Introduction

Meridian Digital Telephone IP Adapter units provide full-featured host Private Branch Exchange (PBX) services to single users in small remote offices or home offices.

Meridian Digital Telephone IP Adapter units require each of the following components:

- a Meridian Digital Telephone Internal or External IP Adapter unit
- a Reach Line Card (RLC)
- a 10BaseT Ethernet interface to an Internet Access Device (IAD)

This section provides a brief description of each component used to provide Meridian Digital Telephone IP Adapter functionality.

Meridian Digital Telephone Internal IP Adapter circuit card

The Meridian Digital Telephone Internal IP Adapter circuit card fits in the base of a Meridian digital telephone set. The circuit card relays voice and signaling information between the digital telephone connected at your office and the RLC installed on the host PBX using the Internet Protocol (IP) network.

Refer to the following chapters for additional information:

- Chapter 3, “Installing the Meridian Digital Telephone IP Adapter unit”
- Chapter 4, “Configuring the IP Adapter unit using the telephone menu”, or Chapter 5, “Changing configuration settings using Configuration Manager”

Meridian Digital Telephone External IP Adapter unit

The Meridian Digital Telephone External IP Adapter unit connects to the telephone set line cord of the digital telephone with a standard RJ-11 connector. The unit relays voice and signaling information between your digital telephone at a remote location and the RLC installed in the host PBX over the IP network. Refer to the following chapters for additional information:

- Chapter 3, “Installing the Meridian Digital Telephone IP Adapter unit”
- Chapter 4, “Configuring the IP Adapter unit using the telephone menu”, or Chapter 5, “Changing configuration settings using Configuration Manager”

Reach Line Card

The Reach Line Card (RLC), installed in the host PBX, provides service for up to 16 ports on a single-slot card or 32 ports on a double-slot card. The RLC emulates a standard digital line card (XDLC), providing PBX functionality for telephones at remote locations (including sites using the Meridian Digital Telephone IP Adapter unit).

The RLC relays voice and signaling information between the remote digital telephone and the host PBX over the IP network.

For a more detailed description, refer to the *Reach Line Card Installation and Administration Guide* (NTP 555-8421-210).

Voice over IP technology

The Meridian Digital Telephone IP Adapter unit uses Nortel Networks proprietary Voice over IP technology to send voice and data signals between your office and the host PBX through the existing IP data network.

Configuration - Device and Software

To make the Meridian Digital Telephone IP Adapter unit operational, some configuration is required. You can use the following tools to configure the Meridian Digital Telephone IP Adapter unit:

- telephone menu

You must use the telephone menu to configure the Meridian Digital Telephone IP Adapter unit initially.

For detailed instructions on using the telephone menu, refer to Chapter 4, “Configuring the IP Adapter unit using the telephone menu”.

- Configuration Manager

Configuration Manager is a Windows-based application for accessing the Meridian Digital Telephone IP Adapter unit configuration settings. Once you have configured the Meridian Digital Telephone IP Adapter unit, you can use Configuration Manager to make configuration changes and perform ongoing administration.

For more details, refer to Chapter 5, “Changing configuration settings using Configuration Manager”, and Chapter 7, “Administration”.

Hardware description

This section describes the LED displays, power supply, cables, connectors, and Internet Access Devices (IAD) for the Meridian Digital Telephone IP Adapter units.

Meridian Digital Telephone IP Adapter unit LEDs

The operational status of the Meridian Digital Telephone IP Adapter unit is indicated by LEDs mounted on the following:

- telephone set footstand for the Meridian Digital Telephone Internal IP Adapter circuit card
- front panel of the Meridian Digital Telephone External IP Adapter unit

LED Type	LED Name	Description
Power	On	When lit, this LED indicates that power is present.
IP network	TX	When flashing, this LED indicates that data is being transmitted over the Ethernet network.
	RX	When flashing, this LED indicates that data is being presented to the Meridian Digital Telephone IP Adapter unit over the Ethernet network.

Meridian Digital Telephone IP Adapter unit LED display diagrams

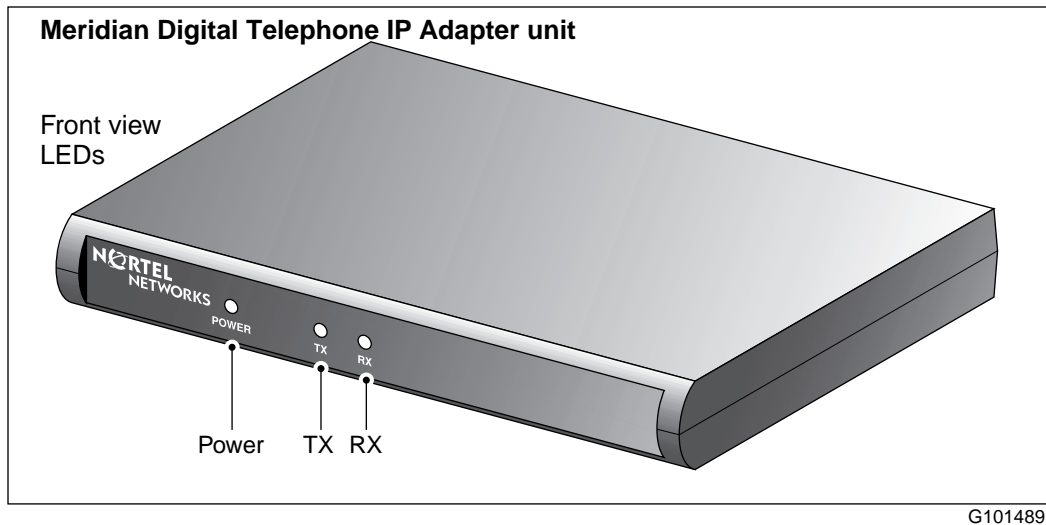
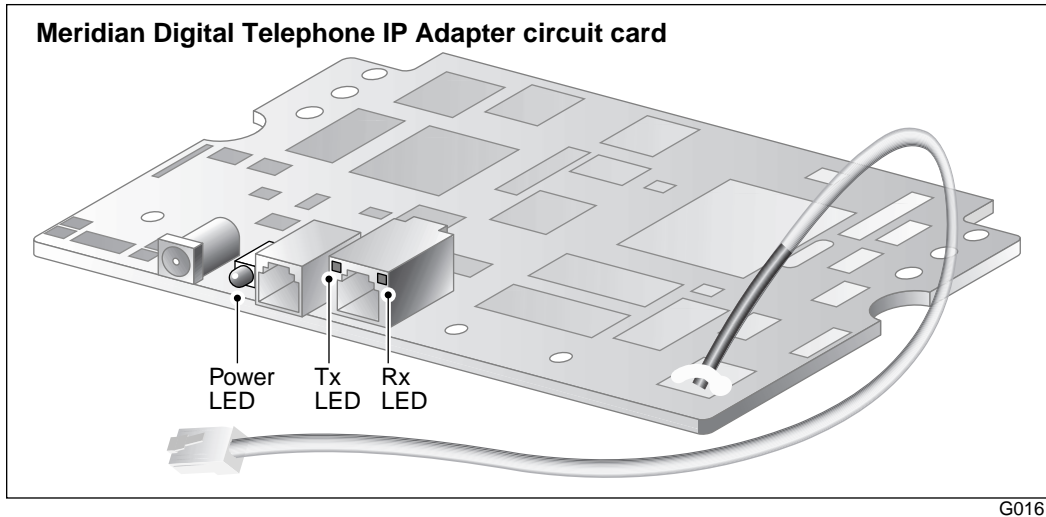

Meridian Digital Telephone Internal IP Adapter circuit card

The Meridian Digital Telephone Internal IP Adapter circuit card provides the connections listed below:

- a female RJ-45 connector (labeled ETHERNET) for a 10BaseT Ethernet connection to an Internet Access Device
- a female RJ-11 connector (labeled LINE) for an analog connection to the PSTN

This connector is not used for the Meridian Digital Telephone Internal IP Adapter circuit card.

- a male RJ-11 connector on an approximately six-inch TCM cable for the connection between the circuit card and the digital telephone.

Meridian Digital Telephone External IP Adapter unit

The Meridian Digital Telephone External IP Adapter unit provides the connections listed below:

- a female RJ-45 connector (labeled ETHERNET) for a 10BaseT Ethernet connection to an Internet Access Device
- a female RJ-11 connector (labeled LINE) for an analog connection to the PSTN

This connector is not used for the Meridian Digital Telephone External IP Adapter unit.

- a female RJ-11 connector (labeled D PHONE) for a connection to the digital telephone
- a DB-9 connector (labeled ADMIN) provides an RS-232 connection to the serial port of a PC

Note: The ADMIN port on the Meridian Digital Telephone External IP Adapter unit is for field service use only.

Universal power supply support - Meridian Digital Telephone Internal IP Adapter circuit card

The Meridian Digital Telephone Internal IP Adapter circuit card requires a .5A/24V power supply. To order the power supply from your Nortel Networks distributor, request part number NTDR91xx. (The “xx” represents the vintage and can vary.) The design of this power supply, shown in the following illustration, accommodates North American, British (U.K.), and European standards.

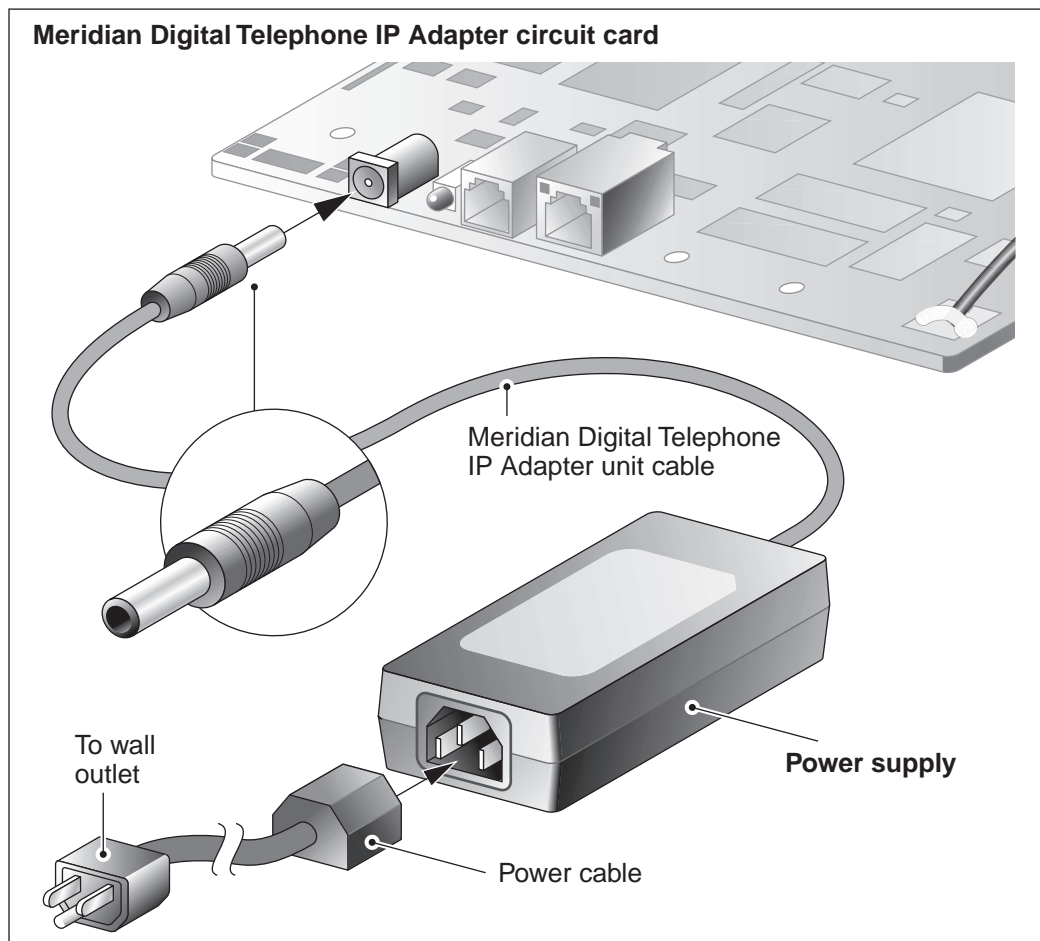

G017IP

Universal power supply support - Meridian Digital Telephone External IP Adapter unit

The Meridian Digital Telephone External IP Adapter unit requires a .5A/24V power supply. To order the power supply from your Nortel Networks distributor, request part number NTDR91xx. (The "xx" represents the vintage and can vary.) The design of this power supply, shown in the following illustration, accommodates North American, British (U.K.), and European standards.

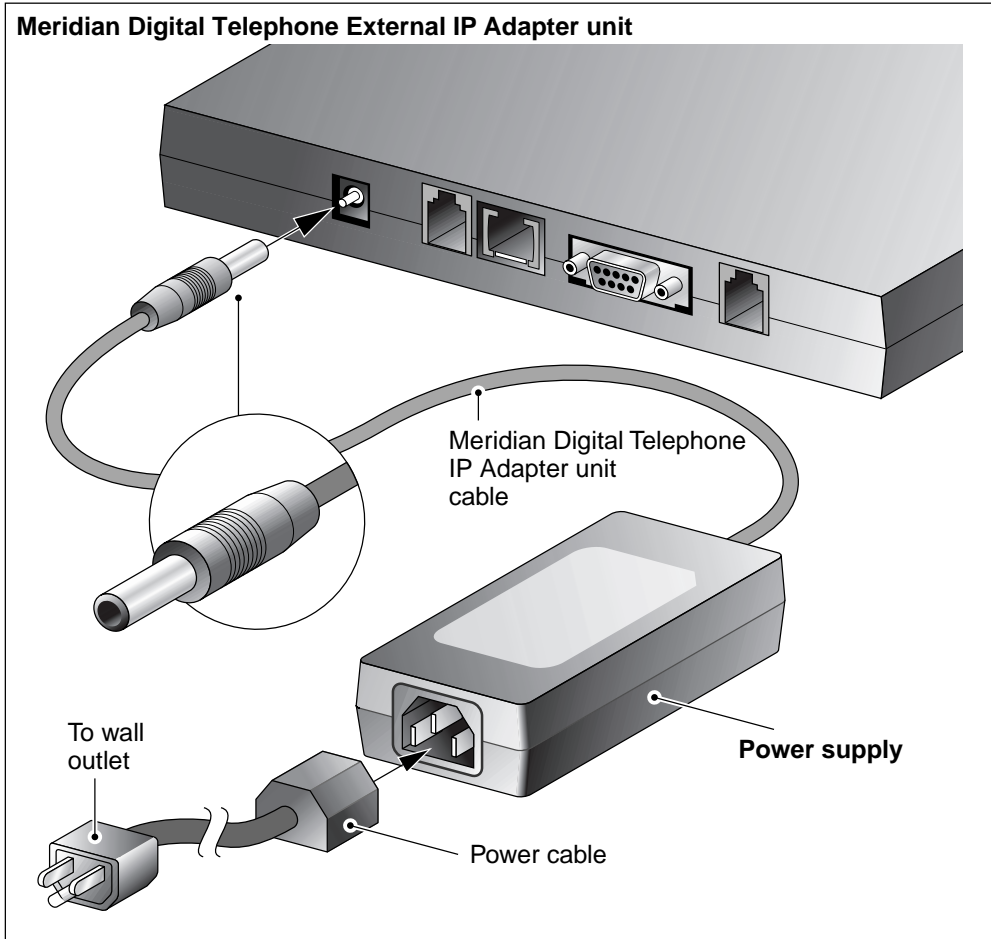

G101532IP

Internet Access Device description

If you are using a 10BaseT Ethernet LAN at the remote site, you can connect the Meridian Digital Telephone IP Adapter unit to any high-speed Internet Access device. The following are some commonly-used devices:

- ISDN Basic Rate Interface (BRI) router
A BRI router is designed to send voice and data traffic across an ISDN line.
- digital subscriber line (xDSL) modem
An xDSL modem transmits digital information at high bandwidth on existing phone lines. The xDSL modem can send and receive data at a rate of 512 Kbps to 6 Mbps. An example, is the 1-meg modem.
- cable modem
A cable modem is used on cable TV lines so that customers can dial up to their Internet service providers over a cable line, instead of a telephone line.

Refer to the *Remote Office Network Engineering Guidelines* (NTP 555-8421-103) for detailed information on the interaction of the Meridian Digital Telephone IP Adapter unit with the IP Network.

Connection options

Communications between the Meridian Digital Telephone IP Adapter unit in your office and the host PBX takes place using 10BaseT Ethernet interface to an Internet Access Device (IAD) on a corporate wide area network (WAN). This section provides a description of this connection.

10BaseT Ethernet interface

The Meridian Digital Telephone IP Adapter unit uses Nortel Networks proprietary Voice over IP (VoIP) technology over the IP network to the host PBX. Voice data is forwarded as UDP/IP packets and the signalling data as TCP/IP packets. You can connect the Ethernet interface to an Internet Access Device such as a BRI router, an xDSL modem, or cable modem. For more information, refer to the “Internet Access Device description” on page 10.

How Meridian Digital Telephone IP Adapter units work

There are two major components to the Meridian Digital Telephone IP Adapter units. They are:

1. the Meridian Digital Telephone Internal or External IP Adapter circuit card or unit located at the remote office
2. the RLC located on the host PBX

These two components, along with the connection options described on page 11, extend the host PBX services to a remote office user.

IP network diagram

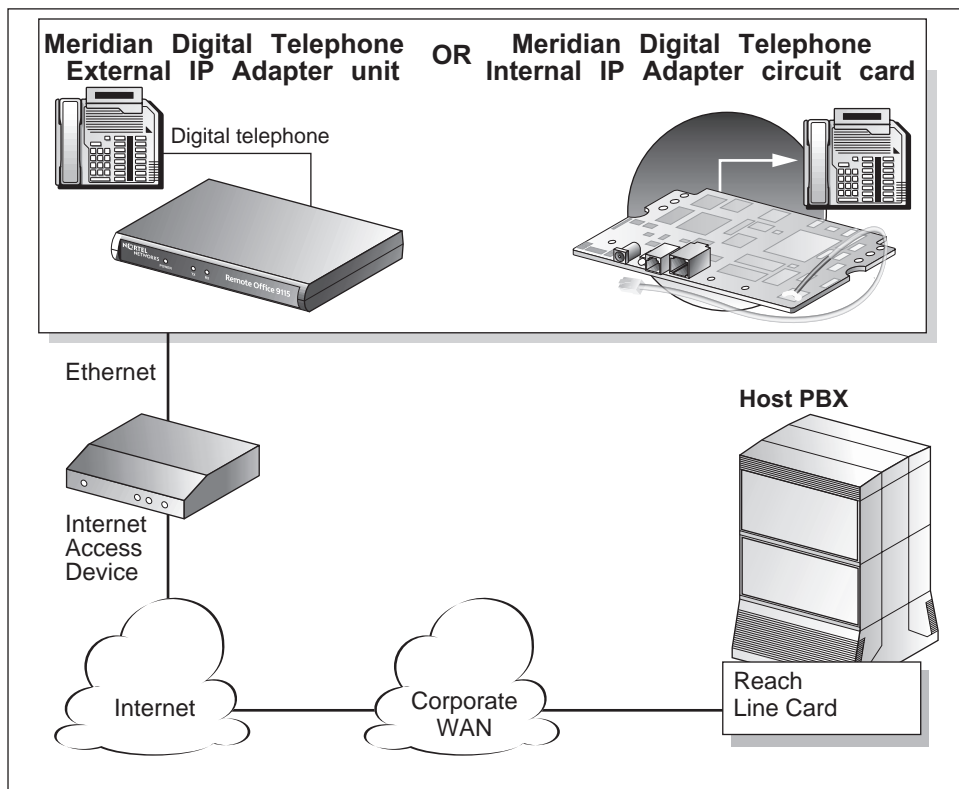

G018

Outgoing call process

To place outgoing calls, users can either pick up the handset on the telephone or press the line key. For a detailed description of the outgoing call process, refer to the sample illustrations beginning on page 14.

Incoming call process

When someone places a call through the host PBX to a Meridian Digital Telephone IP Adapter unit, the RLC connects to the remote unit. The host PBX then completes the call normally. If the RLC cannot establish a connection, the call rings until the host PBX forwards the call to voice mail. Refer to Chapter 6, “Using the digital telephone”, for a more detailed description of the incoming call process.

Host-controlled call mode

When you place a call to someone at the host site, or when someone from the host site calls you, the call is in host-controlled call mode. Calls in host-controlled mode are routed through the host PBX. Refer to the sample illustrations beginning on page 14.

Call scenario 1: host-controlled—corporate internal call

The following diagram shows how a call is routed when placing a host-controlled call over the IP network to the corporate office:

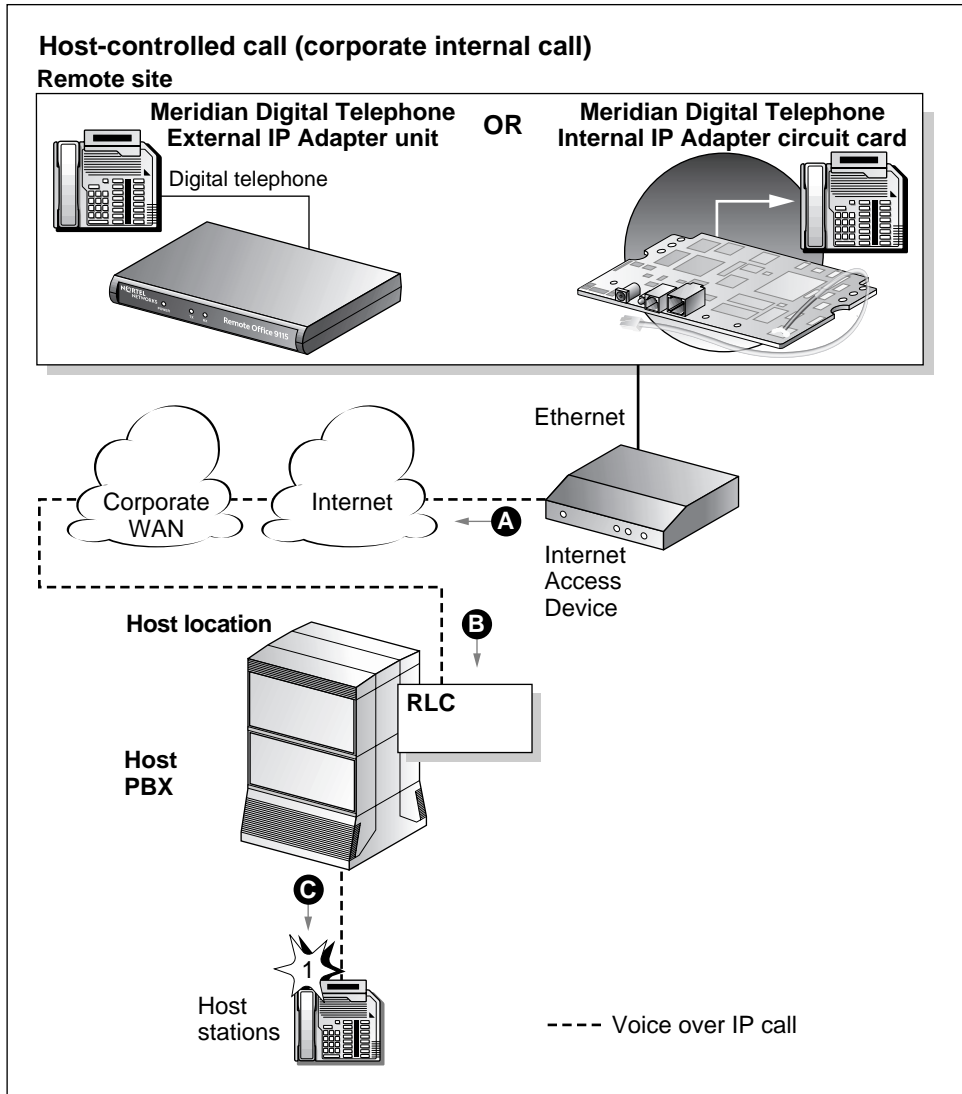

Calls work the same in reverse, from the host PBX site to the Meridian Digital Telephone IP Adapter unit site.

Voice over IP network call

- 1** The Meridian Digital Telephone IP Adapter user lifts the handset (item A).
Result: The Meridian Digital Telephone IP Adapter user hears a dial tone. This indicates a successful connection to the RLC over the IP network (item B).
- 2** The Meridian Digital Telephone IP Adapter user dials a telephone number, such as the extension number of host station 1.
Result: The Meridian Digital Telephone IP Adapter unit sends the dialed digits as packets through the IP network to the Ethernet network or Corporate WAN to the RLC. The RLC converts the packets to the format required by the host PBX.
- 3** The host PBX then converts the data to voice and routes the call to host station 1 (item C).

Note: Item notations in parentheses refer to circled markers in the diagram on page 14.

Call scenario 2: host-controlled—corporate external call

The following diagram shows how a call is routed when placing a host-controlled call to a party outside the organization using a Meridian Digital Telephone IP Adapter unit. Calls work the same in reverse, from the host PBX site to the Meridian Digital Telephone IP Adapter unit site.

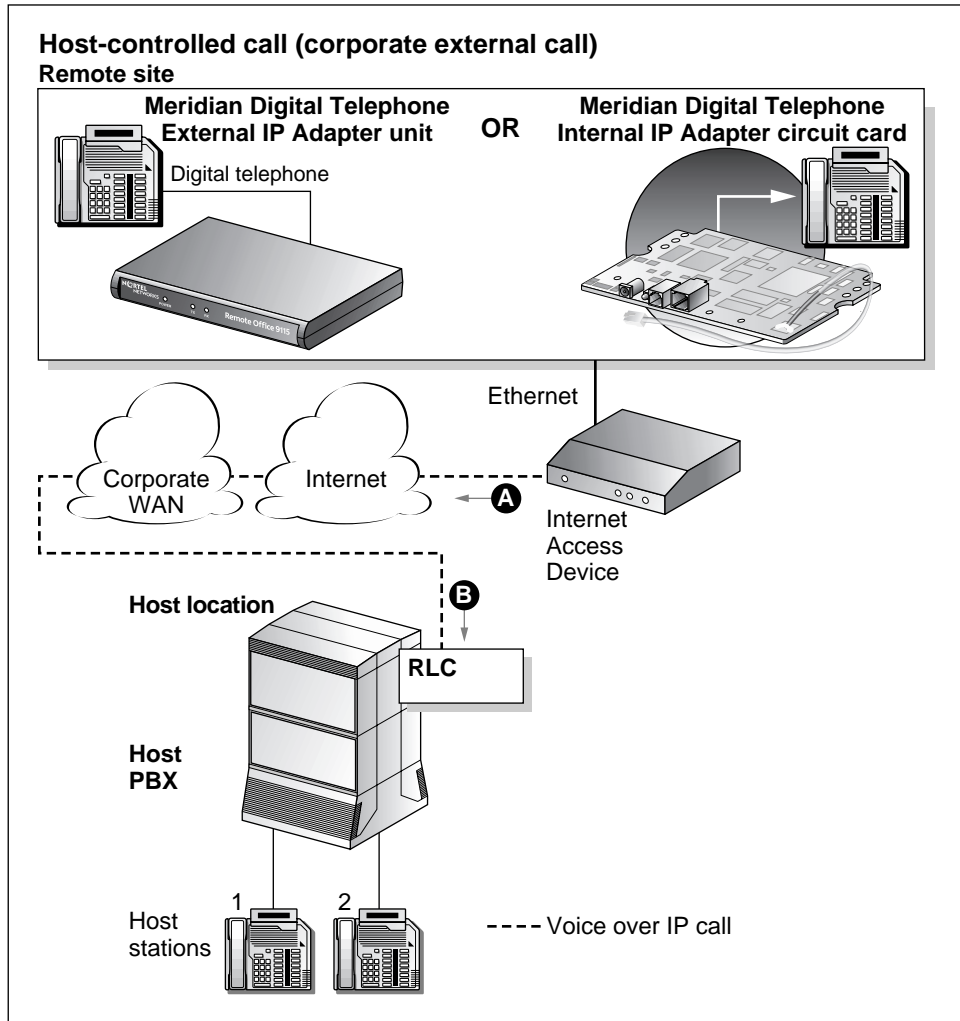

G020IP

Voice over IP network call

- 1 The Meridian Digital Telephone IP Adapter user lifts the handset (item A).

Result: The Meridian Digital Telephone IP Adapter user hears a dial tone. This indicates a successful connection to the RLC over the IP network and the corporate WAN (item B).

- 2 The Meridian Digital Telephone IP Adapter user dials the external telephone number.

Result: The Meridian Digital Telephone IP Adapter unit sends the dialed digits as packets across the Ethernet network. The packets go through the IP network and the corporate WAN, to the RLC. The RLC converts the packets to the format required by the host PBX. The host PBX then converts the data to voice and routes the call to the called party (host stations 1 and 2).

Note: Item notations in parentheses refer to circled markers in the diagram on page 16.

System security

There are two levels of security that you can set to control access from Meridian Digital Telephone IP Adapter units to the RLC on the host PBX. This section describes these security levels and how you can manage them using Configuration Manager.

No security

When no security measures are used, the RLC accepts incoming calls from all Meridian Digital Telephone IP Adapter units.

Use this level with caution as it exposes the RLC to unauthorized use. For example, No security allows a user from an unauthorized remote site can accidentally, or intentionally, connect to the RLC. With this connection made, the unauthorized user can now place long distance phone calls through the RLC and the host PBX.

Security identifier

When you choose the security identifier level of security, the Meridian Digital Telephone IP Adapter automatically sends its configured security identifier (password) for each connection request. The RLC compares the identifier configured to the RLC port with the identifier assigned to the Meridian Digital Telephone IP Adapter. If the identifiers match, then the RLC grants the requested connection.

If the identifiers do not match, then the RLC records an event in the Meridian Digital Telephone IP Adapter system log. You can view the system log in Configuration Manager. The telephone displays **HOSTLESS MODE**, indicating that communications with the host PBX are down.

Telephones

This section lists the telephones, features, and modules supported by the Meridian Digital Telephone IP Adapter unit.

Supported digital telephones

Meridian Digital Telephone IP Adapter units support the following digital telephone sets with display:

M2008D	M2616D	M3820	M3904
M2008HFD	M2616CT	M3902	M3905
M2216D	M3310	M3903	

Your digital telephone must have a one or two-line display in order to configure the Meridian Digital Telephone IP Adapter unit with the telephone display menu.

Required footstand for Meridian Digital Telephone Internal IP Adapter units

The Meridian Digital Telephone Internal IP Adapter unit installs in the footstand of the Meridian Digital Telephone. The required ATA/MCA footstand is standard on Meridian Modular Telephones (M2000 series) with a date code of May 6, 1998 or later. Contact your Nortel Networks distributor to obtain the required footstand if your telephone has an earlier date code.

Supported telephone modules

Meridian Digital Telephone IP Adapter units support the following telephone modules:

- add-on modules to add more keys to the digital telephone
- application modules to provide more functionality to the digital telephone

Note: Meridian Digital Telephone Internal IP Adapter units do not support Meridian Communication Adapters (MCAs). Meridian Digital Telephone External IP Adapter units support Meridian Communication Adapters (MCAs) to allow computer telephony integration (CTI) control of digital telephones operating in transparent mode. Meridian Digital Telephone IP Adapter units do not support Analog Telephone Adapters (ATAs).

Supported telephone features

The Meridian Digital Telephone IP Adapter units support all features provided by the host PBX for host-controlled calls. The following are some examples:

- ACD features
- call forward
- conference
- call waiting
- hold
- transfer

Note: Dial tone for conference and transfer can be very rough. A stutter can be heard during a remote dial tone. This is a normal occurrence and is caused by the DSP activating a dial tone relay.

Refer to Chapter 6, “Using the digital telephone”, for a detailed description of the features listed above.

Computer telephony integration applications

You can use the following two types of computer telephony integration (CTI) applications:

1. first-party CTI applications that use the Symposium Desktop Telephone Application Programming Interface (TAPI) Service Provider
2. third-party CTI applications that use Symposium TAPI Service Provider for M1

You can use both types with the Meridian Digital Telephone IP Adapter unit.

Automatic Call Distribution (ACD) applications

The Meridian Digital Telephone IP Adapter supports all Nortel Networks Automatic Call Distribution (ACD) applications.

Online/Offline Table

Configure the Online/Offline table on the RLC to schedule the times that you want to make the host PBX available to the Meridian Digital Telephone IP Adapter unit.

Note: When the Meridian Digital Telephone IP Adapter unit is in offline mode, you cannot use it to place or receive calls.

You can define up to eight entries per day, every day of the week for each Meridian Digital Telephone IP Adapter unit site. You can define each entry as online, offline, or undefined for each time period entered.

You can override the settings of the Online/Offline table if the table attempts to suspend access to the connection in the middle of a business call. You are alerted by a tone and a display message 30, 20, and 10 seconds before the connection is terminated. To override connection termination, you must enter the online SPRE (Special Prefix) code on the telephone.

You can configure an online/offline table for each remote site on the RLC. Refer to the *Reach Line Card Installation and Administration Guide* (NTP 555-8421-210) for configuration information.

Emergency service number

To make an emergency service call, you must use a PSTN telephone. The Meridian Digital Telephone IP Adapter unit does not support emergency service calls.

ATTENTION!

You must place emergency service calls on a telephone that is directly connected to a PSTN line. If you place an emergency service call from a station that is connected to a Meridian Digital Telephone IP Adapter unit, the RLC routes the call through the host PBX. (The host PBX could be in a different city.)

Configuration Manager

After the initial configuration is complete, you can use Configuration Manager administration software to make configuration changes and administer the Meridian Digital Telephone IP Adapter unit. Refer to Chapter 5, “Changing configuration settings using Configuration Manager”. The software is a Windows-based application that is installed on your PC.

Administration tasks include the following:

- viewing the system status
- performing upgrades, backups, or restores
- making configuration changes
- changing the administration password

Note: You must use the telephone set menu to configure the Meridian Digital Telephone IP Adapter unit for the first time. Refer to “Before you begin” on page 54 for a detailed telephone menu description.

Power requirements

This section lists characteristics of the recommended power supplies for the Meridian Digital Telephone IP Adapter units.

Input specifications

Input specifications for the Meridian Digital Telephone IP Adapter units are as follows:

Characteristic	Rating
voltage	90 - 264 VAC
frequency	47 - 63 Hz
current	0.4A maximum

Output specifications

Output specifications for the Meridian Digital Telephone IP Adapter units are as follows:

Characteristic	Rating
voltage	24 VDC +/-5%
current	0.62A maximum
power	15W maximum

Chapter 2

Planning for installation

In this chapter

Physical environment	28
Administration PC	31
Network considerations	34
Deployment	36

Physical environment

This section provides the space, temperature, cabling, and mounting information you need to know before you install Meridian Digital Telephone IP Adapter units.

Space

Insert the Meridian Digital Telephone IP Adapter circuit card into the base of a digital telephone set. The dimensions for the circuit card are as follows:

- 16.5 cm (6.5 inches) wide
- 8.8 cm (3.5 inches) deep

Place the Meridian Digital Telephone IP Adapter unit on a desk, or mount it on the wall. The dimensions for the unit are as follows:

- 18.2 cm (7.2 inches) wide
- 9.9 cm (3.9 inches) deep

Temperature

The table on the following page describes the temperature and humidity conditions that the Meridian Digital Telephone IP Adapter unit can withstand without any performance degradation or damage.

Specification	Minimum	Maximum
Normal operation		
Recommended:		
■ Temperature	■ 0°C (32°F)	■ 65°C (149°F)
■ Relative humidity	■ 10%	■ 95% (non-condensing)
Absolute:		
■ Temperature	■ 0°C (32°F)	■ 70°C (158°F)
■ Relative humidity	■ 5%	■ 95% (non-condensing)
Short term (less than 72 hours):	0°C (32°F)	70°C (158°F)
Rate of change	0°C (32°F) to 60°C (140°F) per 3 minutes	
Storage		
Recommended temperature	-50°C (-58°F)	70°C (158°F)
Relative humidity	5%	95% RH (non-condensing)
Temperature shock		
In three minutes	-50°C (-58°F)	25°C (77°F)
In three minutes	70°C (158°F)	25°C (77°F)
Non-condensing	-40°C (-40°F)	70°C (158°F)
Power consumption		
Voltage	24VDC	
Current	0.62A	

Mounting options

Place the Meridian Digital Telephone External IP Adapter unit on a desk, or mount the unit on the wall. If mounting on the wall, make sure that the chosen location allows you to easily view the LEDs on the front panel.

ATTENTION! Installation on the wall must be completed using standard telephony installation practices.

Cables included with the Meridian Digital Telephone Internal IP Adapter circuit card

The Meridian Digital Telephone Internal IP Adapter package includes a power cord and power supply.

Cables included with the Meridian Digital Telephone External IP Adapter unit

The Meridian Digital Telephone Internal IP Adapter package includes the following cables:

- 1.83 meter (6-foot) RJ-11 telephone cord
- a power cord and power supply

Cables you must supply yourself

The following cables used to establish the network connections are industry-standard cables and are not provided in the Meridian Digital Telephone External IP Adapter package.

- Ethernet cable (CAT 5)
- telephone cable
- serial cable for the Meridian Digital Telephone External IP Adapter unit

You must obtain these cables from your local cable supplier.

Administration PC

This section describes the way that you can connect an administration terminal to the Meridian Digital Telephone IP Adapter unit. It also describes the hardware and software requirements for using the Configuration Manager administration software.

Connection options

The Meridian Digital Telephone IP Adapter system includes the Configuration Manager software that enables you to configure, administer, and upgrade the Meridian Digital Telephone IP Adapter unit. You can connect to Meridian Digital Telephone IP Adapter unit with Telnet to use Configuration Manager, or using the digital telephone set menu.

You can access Configuration Manager using a 10BaseT Ethernet connection for ongoing administration and upgrade of Meridian Digital Telephone IP Adapter units.

Note: Use the telephone set menu for first-time configuration of Meridian Digital Telephone IP Adapter units.

Ethernet connection

Once you configure the Meridian Digital Telephone IP Adapter unit with its IP interface information, the following can occur:

- You can establish communication between the Meridian Digital Telephone IP Adapter unit and the RLC (that is, calls can be routed over the data link between the two).
- You can administer the Meridian Digital Telephone IP Adapter unit over the data link between the unit and the RLC. For more information, refer to “Administering multiple nodes in the network,” on page 32.

Administering multiple nodes in the network

If you are responsible for administering one or more Meridian Digital Telephone IP Adapter units and the RLC on the host PBX, you can access them and the RLC from anywhere on the network.

Note: You do not have to install separate administration PCs for the RLC and the Meridian Digital Telephone IP Adapter unit(s). You can use one administration PC to administer all units in the RemoteOffice network.

Windows PC requirements

To use Configuration Manager, the administration PC must have the following characteristics:

- IBM-compatible
- Windows 95, Windows 98, or Windows Workstation NT 4.0 with the Microsoft Transmission Control Protocol/Internet Protocol (TCP/IP) networking component installed
- CD-ROM drive
- a pointing device (mouse)
- 32 Mbytes of RAM for Windows 95 and 98, or 64 Mbytes of RAM for Windows Workstation NT
- 48 Mbytes of available storage for Windows 95 and 98, or 64 Mbytes of available storage for Windows Workstation NT

TFTP server

A Trivial File Transfer Protocol (TFTP) server is required for performing firmware upgrades and configuration uploads. You can use any TFTP server application. TFTP server applications are available from the Internet.

Year 2000 compliance

The Meridian Digital Telephone IP Adapter unit and Configuration Manager software are Year 2000 compliant. However, you must ensure that the administration PC is Year 2000 compliant by verifying that the Windows operating system is shown in this table:

Operating system	Year 2000 compliance requirement
Windows Workstation NT 4.0	Service Pack 5 or higher
Windows 95	Version 95b
Windows 98	OK as is

Network considerations

Refer to the *Remote Office Network Engineering Guidelines* (NTP 555-8421-103) for detailed information on planning and preparing your network for the addition of IP Adapter units. The Meridian Digital Telephone IP Adapter unit communicates with the host PBX using the IP network. To use the Meridian Digital Telephone IP Adapter unit in these networks, you must consider the issues described in this section.

IP addressing and routing

To place and receive calls over the IP network, you must:

- physically connect the Meridian Digital Telephone IP Adapter unit to the IP network
- assign a unique IP address and a subnet mask to the Meridian Digital Telephone IP Adapter unit, unless using Dynamic Host Configuration Protocol (DHCP)

Note: Similarly, you must assign a subnet mask, gateway, and unique IP address to the RLC on the host PBX.

- have the ability to send and receive traffic to and from the RLC on the host PBX

Determining DHCP Assigned IP Addresses

If you use DHCP at the remote location, determine the Remote Office Unit's IP address by checking the Network statistics for the RLC through Configuration Manager. Log onto Configuration Manager, choose the RLC as the Device Type, and then access Alarms/Stats/Logs → Network Statistics. Enter the Unit ID of the Remote Office unit that you want to review the statistics for. The DHCP assigned IP address displays at the top of the window.

Note: If you are using a Network Address Translation (NAT) router at the remote location, the IP address provided is a NAT address. To access the Remote Office unit using Telnet, ensure that the NAT router allows Telnet access to TCP port 23, and for upgrades, TCP port 69.

Network diagram

The following diagram shows the Meridian Digital Telephone IP Adapter unit's position in an IP network.

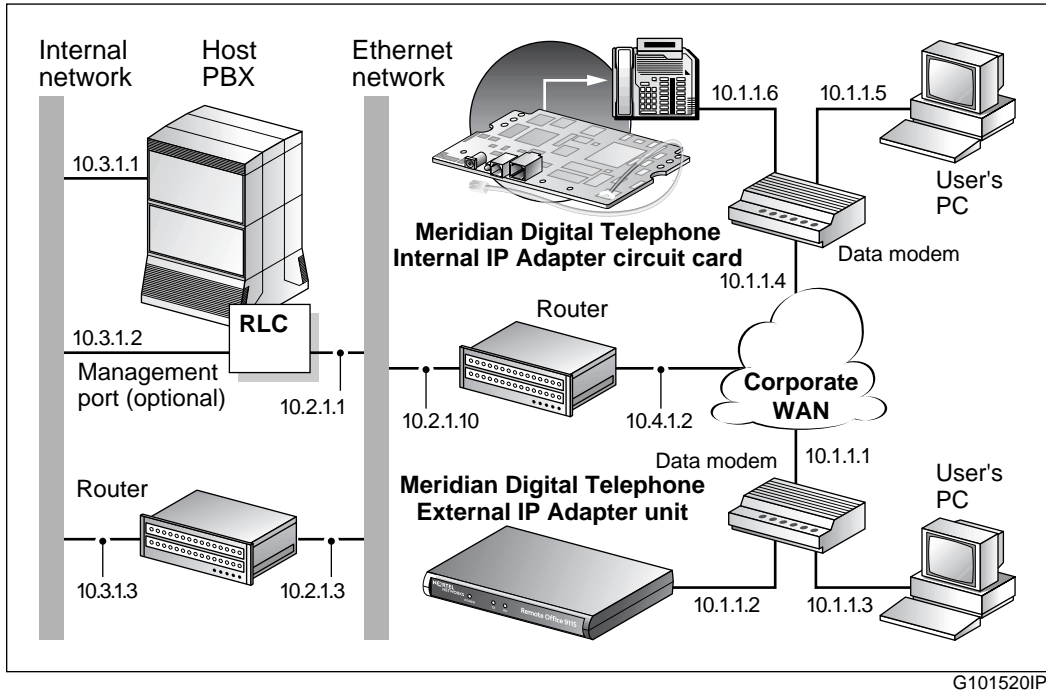

Deployment

This section presents the Meridian Digital Telephone IP Adapter unit deployment models (options) that are supported by Nortel Networks.

Transport media

You can only configure the Meridian Digital Telephone IP Adapter unit on the RLC to use the IP network. For further details on this configuration, refer to Priority under Remote Port Configuration in the *Reach Line Card Installation and Administration Guide* (NTP 555-8421-210).

Network Address Translation

Some network routers run the Network Address Translation (NAT) protocol that allows multiple devices in the IP network to share the same broadband IP address. An alternative to running the NAT protocol is to have the network administrator provide each device with its own broadband IP address.

Meridian Digital Telephone IP Adapter units support NAT functionality, if this functionality is enabled on your network. You can only connect a single Meridian Digital Telephone IP Adapter unit behind a NAT router. You can connect multiple Meridian Digital Telephone IP Adapter units behind a PNAT router. A PNAT router is a port number and network address translation router. If you are not sure whether yours is a NAT router or a PNAT router, check with your vendor.

You must configure your Meridian Digital Telephone IP Adapter unit for IP permanent allocation if it is connected behind a NAT router. You can assign a static IP address to your Meridian Digital Telephone IP Adapter unit, or you can use DHCP to obtain its IP address.

IP deployment

Before deploying your Meridian Digital Telephone IP Adapter unit, ensure that you engineer the IP network properly. You can configure a permanent (Model 1) or on-demand (Model 2) IP connection. The following guidelines describe requirements, conditions, and characteristics of each supported IP deployment option:

Model 1: IP permanent

If using DSL or a cable modem, configure an IP permanent connection.

- The Meridian Digital Telephone IP Adapter unit re-establishes its TCP/IP signaling session to the RLC once per minute.
- The Meridian Digital Telephone IP Adapter unit supports both static IP and, through DHCP, dynamic IP addressing
- Do not configure a remote IP address on the RLC.
- One virtual private network (VPN) supports multiple Meridian Digital Telephone IP Adapter units.
- One Network Address Translation (NAT) router supports only one Meridian Digital Telephone IP Adapter unit.
- One Port number and Network Address Translation (PNAT) router supports multiple Meridian Digital Telephone IP Adapter units.
- The RLC requires an IP address that the Meridian Digital Telephone IP Adapter unit can access.

Model 2: IP on-demand

If your BRI routers incur toll charges, configure an IP on-demand connection.

- TCP/IP signaling sessions between the RLC and the Meridian Digital Telephone IP Adapter unit close when calls end.
- Configure a static IP address for the Meridian Digital Telephone IP Adapter unit on the RLC for best service.
- IP on-demand configuration supports VPNs.
- IP on-demand configuration does not support NAT or PNAT routers.
- Both the RLC and Meridian Digital Telephone IP Adapter unit require IP addresses that are accessible from the other unit.

Chapter 3

Installing the Meridian Digital Telephone IP Adapter unit

In this chapter

Preparing for installation	40
Installing the Meridian Digital Telephone Internal IP Adapter circuit card	42
Installing the Meridian Digital Telephone External IP Adapter unit	48

Preparing for installation

This section shows you how to prepare for the installation of the Meridian Digital Telephone IP Adapter unit.

General Safety

The following is a list of general safety measures that should be considered when installing the Meridian Digital Telephone IP Adapter unit.

- Do not ignore the warnings, in the guide, about the risks related to installing and handling hardware. For a description of the types of warnings this guide provides, refer to “Conventions used in this guide” on page xx in the Preface.
- Follow these safety precautions at all times to avoid damage or injury:
 - Plug the Meridian Digital Telephone IP Adapter unit into a properly grounded power source to reduce the possibility of electric shock and damage to the unit or network.
 - Ensure that nothing rests on connection cables, and that cables cannot be tripped over or stepped on.
- Protect the equipment against Electrostatic discharge (ESD). ESD affects the performance and decreases the useful life of system components. ESD can seriously damage component parts such as circuit cards. Implement the following precautions that are recommended by computer and telephone equipment manufacturers:
 - Remove items that generate static charge from the installation site.
 - Use antistatic spray if the site is carpeted.
 - Ground yourself before handling any equipment.

Required hardware and software tools

The following is a list of required hardware and software installation tools:

- an antistatic ESD wrist strap (recommended)
- a Phillips-head screwdriver and two number eight wood screws (if you want to mount the Meridian Digital Telephone External IP Adapter unit on the wall)
- the Configuration Manager software installed on the administration PC (to make configuration changes or administer the Meridian Digital Telephone IP Adapter unit). You can download the software by clicking on the Customer Support and Software Distribution links at the following website: **www.nortelnetworks.com**
- a TFTP server application installed on the PC (required for performing firmware upgrades)

If you do not have a TFTP server currently installed on the administration PC, you can obtain one from the Internet.

Unpacking and inspecting the equipment

Before you install the Meridian Digital Telephone IP Adapter unit, ensure that the following package contents are all present and are not damaged:

- one Meridian Digital Telephone Internal IP Adapter or Meridian Digital Telephone External IP Adapter
- one power cord and power supply for each Meridian Digital Telephone IP Adapter unit
- one six-foot RJ-11 telephone cable for each Meridian Digital Telephone External IP Adapter unit
- one installation kit for each Meridian Digital Telephone Internal IP Adapter circuit card. Each installation kit includes the following:
 - two ferrite beads
 - one overlay
 - two mounting screws (used to attach the circuit card to the foot stand)
- the *Remote Office and RLC Release Notes* (NTP 555-8421-102)
- the *Meridian Digital Telephone IP Adapter Quick Start Guide*

Installing the Meridian Digital Telephone Internal IP Adapter circuit card

Before you can install the Meridian Digital Telephone Internal IP Adapter circuit card, you must first remove the footstand of the digital telephone. For more information about supported telephone footstands, refer to “Required footstand for Meridian Digital Telephone Internal IP Adapter units” on page 19.

Note: You can only add the Meridian Digital Telephone Internal IP Adapter circuit card to digital telephones that have an ATA/MCA footstand. To obtain an ATA/MCA footstand, contact your Nortel Networks distributor.

Removing the footstand of the digital telephone

To remove the footstand of the digital telephone, complete the following procedure:

- 1 Disconnect the telephone-side connection of the RJ-11 TCM telephone cable. The other end of this cable connects to the wall jack.
- 2 Place the telephone on a flat surface with the keypad facing downward.

Note: Ensure that you are grounded with an approved ESD strap.

- 3 Unscrew and remove the footstand of the digital telephone.

Note: Refer to "A" in the following diagram.

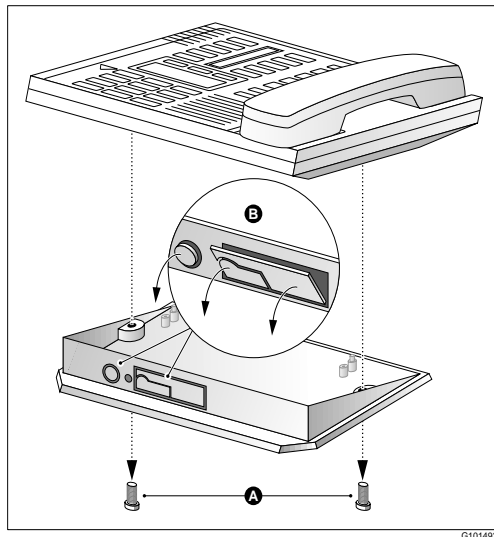

- 4 Punch out the front panels in the footstand of the telephone to make the connections accessible when you install the Meridian Digital Telephone Internal IP Adapter circuit card.

Note: Refer to "B" in the preceding diagram.

Inserting the Meridian Digital Telephone Internal IP Adapter circuit card

To insert the Meridian Digital Telephone Internal IP Adapter circuit card into your digital telephone, complete the following procedure:

- 1 Remove the Meridian Digital Telephone Internal IP Adapter circuit card from the antistatic bag.
- 2 Insert the leading edge of the Meridian Digital Telephone Internal IP Adapter circuit card under the two brackets on the footstand.

Note: Refer to "C" in the following diagram for the location of the brackets.

- 3 Use both hands to push forward until the circuit card snaps into place under the brackets.

Note: Two holes on either side of the circuit card should now be aligned with the corresponding holes on the footstand.

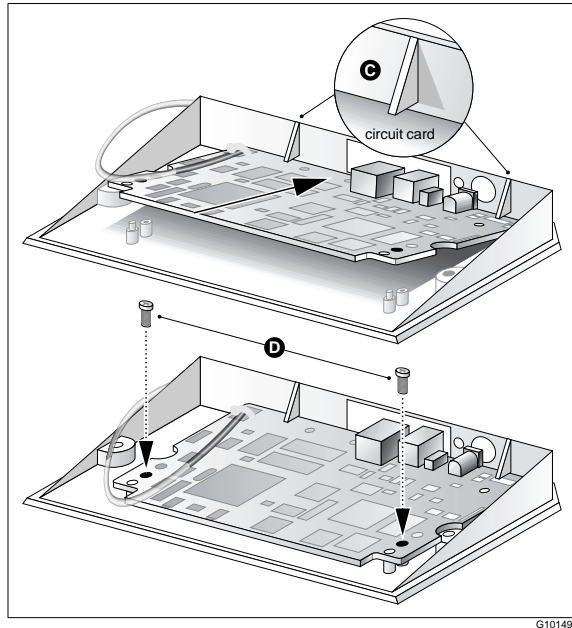

G101493

- 4 Attach the Meridian Digital Telephone Internal IP Adapter circuit card to the footstand with the screws supplied in the Installation Kit.

Note: Refer to "D" in the diagram on page 44.

- 5 Plug the male RJ-11 connector on the loose end of the Meridian Line Cord attached to the Remote Office 9110 unit into the jack on the telephone.
- 6 Re-attach the footstand to the bottom of the telephone.
- 7 Apply the overlay identifying the power connection and the jack connecting your Ethernet for IP network connectivity.

Installing ferrite beads

The Meridian Digital Telephone Internal IP Adapter circuit card installation kit contains two ferrite beads. Ferrite beads protect the Ethernet and power supply cable from electromagnetic interference (EMI). The two heavy pieces of ferrite come in a plastic-hinged cover that forms a block and has a hole in the middle for the cable to pass through. You must install the ferrite bead close to the plug that connects to the Meridian Digital Telephone Internal IP Adapter circuit card.

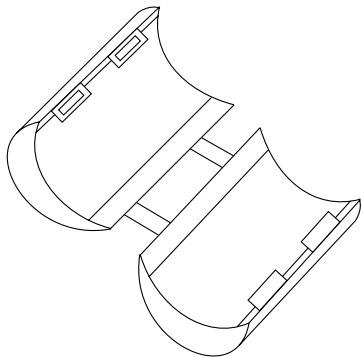

To install the ferrite beads for both the Ethernet cable and the power supply cable:

1 Open the plastic latch at the side of the ferrite bead.

2 Lay a cable across the middle of the ferrite bead.

The ferrite bead must be close to the cable connector.

3 Loop the cable **tightly** around the ferrite bead.

There must be 2 loops of Ethernet cable around the ferrite bead (the Ethernet cable lays across the ferrite bead 3 times).

There must be 3 loops of power supply cable around the ferrite bead (the power supply cable lays across the ferrite bead 4 times).

4 Close and latch the ferrite bead.

Note: You may need to adjust the cable loops to make them as tight as possible.

Connecting the Meridian Digital Telephone Internal IP Adapter circuit card

Ensure that you have obtained the following telephone and Ethernet cables for your network:

- Ethernet cable

If you are connecting the Meridian Digital Telephone Internal IP Adapter circuit card to a hub, you need a standard CAT5 unshielded twisted-pair (UTP) straight-through Ethernet cable. The cable should be no longer than 100 meters (325 feet).

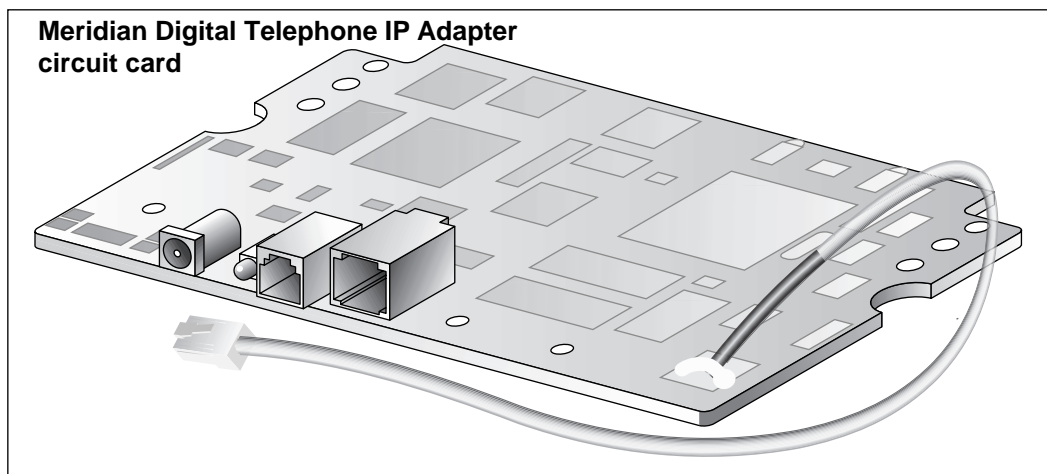

G101482

Note: These cables are not supplied in the Meridian Digital Telephone Internal IP Adapter package.

Complete the following procedure:

- 1 If you want to route calls over the IP network or administer the Meridian Digital Telephone Internal IP Adapter circuit card with Configuration Manager, connect the circuit card to the Ethernet network by making the following connections:
 - a. Connect one end of the RJ-45 Ethernet cable to the ETHERNET connector on the Meridian Digital Telephone Internal IP Adapter circuit card.
 - b. Connect the other end to either an Ethernet hub or network router.
- 2 Connect the Meridian Digital Telephone Internal IP Adapter circuit card to the power source as follows:
 - a. Connect the appropriate cord on the power transformer to the power connector on the Meridian Digital Telephone Internal IP Adapter circuit card.
 - b. Plug the power connector into an uninterruptible power supply (UPS) or wall outlet.

Powering up the Meridian Digital Telephone Internal IP Adapter circuit card

As soon as you connect the Meridian Digital Telephone Internal IP Adapter circuit card to the power source, the circuit card begins to power up.

During power-up, the Meridian Digital Telephone Internal IP Adapter circuit card performs a self-test. The power LED flashes three times to verify all critical functionality.

If the Meridian Digital Telephone Internal IP Adapter circuit card completes a successful self-test, the telephone display shows one of the following messages:

- A time and date, if connected to a PBX.
- `HOSTLESS MODE`, if not connected to a PBX.

Note: The ETHERNET TX and RX LEDs flash only in response to transmit and receive activity.

Installing the Meridian Digital Telephone External IP Adapter unit

You can install the Meridian Digital Telephone External IP Adapter unit on a desk or on the wall. The unit has the following dimensions:

- 18.2 cm (7.2 inches) wide
- 9.9 cm (3.9 inches) deep
- 2.544 cm (1 inch) high

Note: If you want to mount the Meridian Digital Telephone External IP Adapter unit on the wall, you must provide your own mounting hardware.

Installing the Meridian Digital Telephone External IP Adapter unit on a desk

To install the Meridian Digital Telephone External IP Adapter unit on a desk, complete the following procedure:

- 1 Turn the Meridian Digital Telephone External IP Adapter unit upside down.
- 2 Affix the rubber feet to the bottom of the Meridian Digital Telephone External IP Adapter unit.

Note: Ensure the rubber feet are securely fastened.

- 3 Place the Meridian Digital Telephone External IP Adapter unit in the desired location.

Installing the Meridian Digital Telephone External IP Adapter unit on the wall

You need the following tools:

- a tape measure
- a screwdriver
- two long screws (to ensure the unit is securely mounted)

Note: Do not affix the rubber feet to the bottom of the Meridian Digital Telephone External IP Adapter unit. Otherwise, the unit cannot be mounted flush against the wall.

Ensure that your chosen location meets the following criteria:

- The LEDs on the front panel must be easily viewed.
- There must be enough space to accommodate the cables when they are connected to the Meridian Digital Telephone External IP Adapter unit.

Refer to the following diagram.

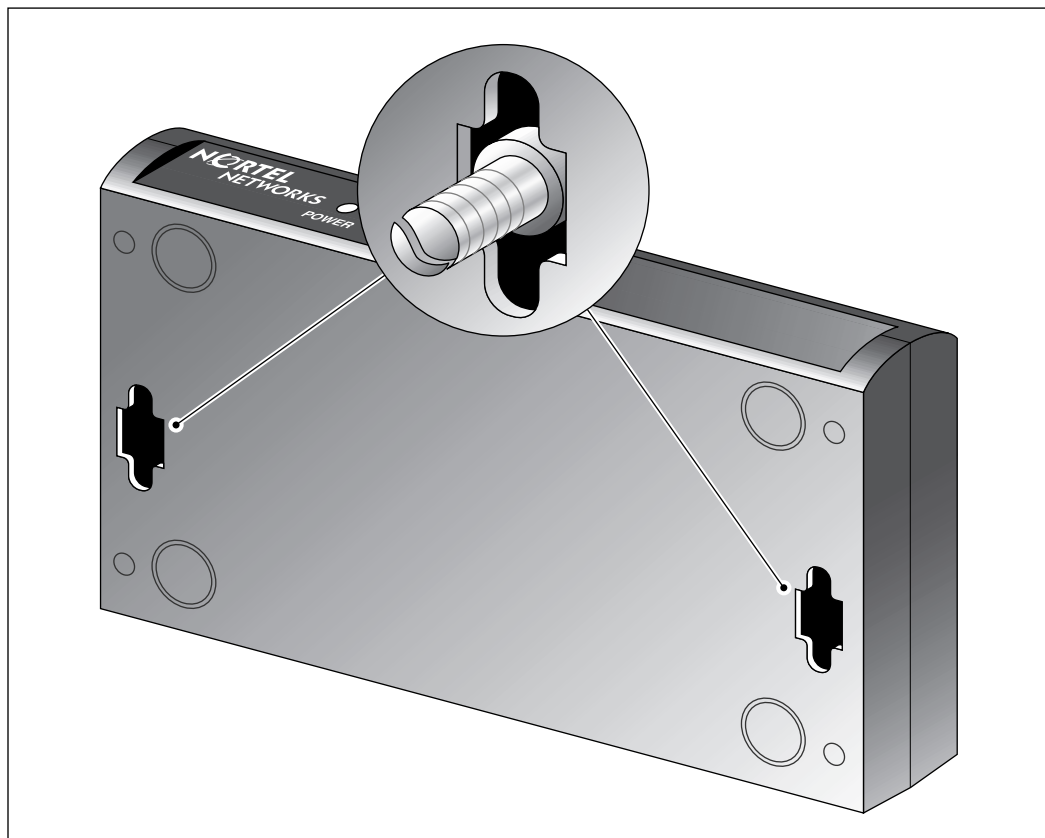

G023IP

Complete the following procedure:

- 1 Choose the location on the wall where you want to mount the Meridian Digital Telephone External IP Adapter unit.
- 2 Use the pre-drilled screw slots on the bottom of the Meridian Digital Telephone External IP Adapter unit as a guide to measure and mark the location on the wall for each mounting screw.

The measurements between the screw slots are as follows:

- from front to back panels: 2.54 cm (1 in.)
- from side to side: 15.8 cm (6.25 in.)

- 3 Mount the screws.

Note: Do not screw the screws all the way in. The heads should be screwed to about 5 mm (1/8 inch) from the wall.

- 4 Mount the Meridian Digital Telephone External IP Adapter unit on the screws, then gently pull it down so the screws slide into the narrow portion of the screw slots.

Note: Do not let go yet.

- 5 Make sure that the Meridian Digital Telephone External IP Adapter unit is securely mounted.



WARNING

Risk of equipment damage

Ensure that you fasten the Meridian Digital Telephone External IP Adapter unit securely to the wall. Falls can damage the unit.

Connecting the Meridian Digital Telephone External IP Adapter unit

Obtain the following cables for your network. These cables are not supplied.

Note: Locate digital telephones no farther than 1230.7 meters (4000 feet) from the Meridian Digital Telephone External IP Adapter unit.

- Ethernet cable

If you are connecting the Meridian Digital Telephone External IP Adapter unit to a hub, you need a standard CAT5 unshielded twisted-pair (UTP), straight-through Ethernet cable. Ensure that this cable is no longer than 100 meters (325 feet) in length.

The following diagram shows the connections on the back panel of the Meridian Digital Telephone External IP Adapter unit.

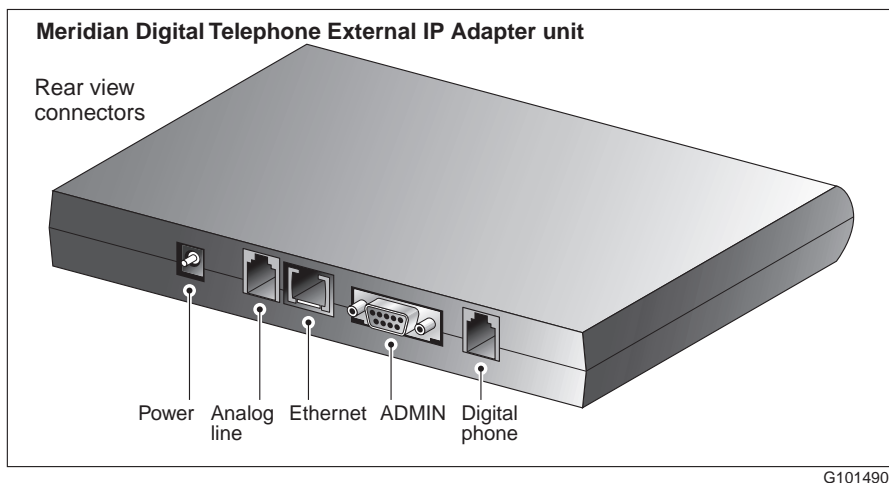

Connecting the Meridian Digital Telephone External IP Adapter unit to the network

To connect the Meridian Digital Telephone External IP Adapter unit to the network, complete the following procedure:



WARNING

Risk of equipment damage

To prevent damage to the Meridian Digital Telephone External IP Adapter unit, ensure that the power source to the unit is turned off until you complete all connections.

- 1 Add the Meridian Digital Telephone External IP Adapter unit to your Ethernet network by making the following connections:
 - a. Connect one end of the Ethernet cable to the ETHERNET connector on the Meridian Digital Telephone External IP Adapter unit.

- b. Connect the other end to either an Ethernet hub or a network router.
- 2 Connect the Meridian Digital Telephone External IP Adapter unit to the power source as follows:
 - a. Connect the appropriate plug on the power transformer to the power connector on the Meridian Digital Telephone External IP Adapter unit.
 - b. Plug the power connector into an uninterruptible power supply (UPS) or wall outlet.
- 3 Connect the Meridian Digital Telephone External IP Adapter unit to the digital telephone as follows:
 - a. Connect one plug of the telephone cable supplied with the Meridian Digital Telephone External IP Adapter unit to the jack marked DIGITAL PHONE on the rear panel of the Meridian Digital Telephone External IP Adapter unit.
 - b. Plug the other end of this cable to the jack on the digital telephone.

Powering up the Meridian Digital Telephone External IP Adapter unit

As soon as you connect the Meridian Digital Telephone External IP Adapter unit to the power source, the unit begins to power up.

During power-up, the Meridian Digital Telephone External IP Adapter unit performs a self-test. The power LED flashes three times to verify all critical functionality, including:

- RAM memory test
- flash checksum validation

If the Meridian Digital Telephone External IP Adapter unit completes a successful self-test, the telephone display shows one of the following messages:

- A time and date, if connected to a PBX.
- **HOSTLESS MODE**, if not connected to a PBX.

Note: The ETHERNET TX and RX LEDs flash only in response to transmit and receive activity.

Chapter 4

Configuring the IP Adapter unit using the telephone menu

In this chapter

Before you begin	54
Running the telephone menu script	57

Before you begin

To complete initial configuration of the Meridian Digital Telephone IP Adapter unit, you must use the telephone menu. After initial configuration, you can use Configuration Manager for changes, administration, and firmware upgrades. For a more detailed description of Configuration Manager, refer to the *Reach Line Card Installation and Administration Guide* (NTP 555-8421-210).

Note: You cannot access the telephone menu and Configuration Manager at the same time. You must use one or the other. If you want to use Configuration Manager to configure the Meridian Digital Telephone IP Adapter unit, refer to Chapter 5, “Changing configuration settings using Configuration Manager”.

Information you need to know before configuring

Before you start configuring the Meridian Digital Telephone IP Adapter unit, you should have the following information available:

- the unit ID for the Meridian Digital Telephone IP Adapter unit
- the online and offline SPRE codes
- the registration and deregistration SPRE codes
- an IP address, including subnet mask and the IP address of the IP Gateway, if applicable

The network administrator can provide the above information to the end-user by filling out and delivering the Telephone Menu - Configuration Values form in Appendix A, “Planning forms”.

Accessing the telephone menu

You can access the telephone menu by quickly pressing the **Release** key four times within a three second time span. Refer to “Running the telephone menu script” on page 57.

Telephone menu key function

Key name	Key label	911x telephone menu key function
DIGIT	1, 2, 3, 4, 5, 6, 7, 8, 9, 0	user name/password entry, numeric entry
ALPHA	2, 3, 4, 5, 6, 7, 8, 9	user name/password entry
YES	1	request menu, enable feature
NO	2	skip menu, disable feature
RELEASE	Rls, R, Goodbye (depending on your telephone set)	enter configuration mode, return to previous menu, exit system
ENTER	Hold	accept selection, move to next menu prompt
PERIOD	*	period (.), delimiter for IP addresses
BACKSPACE	#	backspace with delete

Backing up while in the telephone menu

If, at any time while working with the telephone set menu, you make a mistake, you can return to the previous level in the menu system by pressing the **Release** (Rls, R, or Goodbye depending on your telephone set) key once.

Exiting the system using the Release key

To exit the system at any time using the release key, complete the following procedure:

- 1 Press the **Release** key to move up in the menu one level at a time until you reach the top level.

Note: The `Confirm Exit?` message indicates that you have reached the top level of the menu.

- 2 The telephone display asks you to confirm your request to exit the configuration menu, similar to the following:

```
Confirm Exit?
[1-Yes 2-No]
```

IF you wish to THEN do the following:

continue working,

- a. Press **2**.
- b. Press the **Hold** key.

Result: The telephone display continues, as though you had entered a “No” response to the most recent option you had on the menu.

stop working with
the telephone
menu,

- a. Press **1**.
- b. Press the **Hold** key.

Result: The following screen confirms that you have left Remote Office configuration.

```
You are logged out.
```

Note: If you exit the system without saving any changes you have made, your changes will stay in active memory until the next system restart/reboot. After this, your changes are lost.

Running the telephone menu script

After installing and powering up the Meridian Digital Telephone IP Adapter unit, complete the following procedure:

- 1 Press the release key four times within three seconds to access the telephone menu.

Result: The telephone display prompts you for a user name, similar to the following:

```
Enter User Name
Press the Rls key to exit.
```

- 2 Enter the digits **48378 (GUEST)** and then press the **Hold** key.

Result: The telephone display prompts you for a password, similar to the following:

```
Enter Password
Press the Rls key to exit.
```

- 3 Enter the digits **48378123 (GUEST123)**, the default password, or the current password if you have customized the password and then press the **Hold** key.

Result: The telephone display asks if you want to display shows:

```
Display Local IP?
[1-Yes 2-No]
```

IF you want to THEN do the following:

display read-only
IP parameters,

- a. Press **1**.
- b. Press the **Hold** key.

Result: The telephone display shows the remote site's current IP address, similar to the following:

```
IP Address  
192.168.142.102
```

- c. Press the **Hold** key.

Result: The telephone display shows the remote site's current IP subnet mask, similar to the following:

```
IP Subnet Mask  
255.255.255.0
```

- d. Press the **Hold** key.

Result: The telephone display shows the remote site's current IP gateway, similar to the following:

```
IP Gateway  
192.168.142.254
```

- e. Press the **Hold** key.
- f. Proceed to step 4 on page 59.

not display IP
parameters,

- a. Press **2**.
 - b. Press the **Hold** key.
-

- 4 The telephone display asks if you want to restore default values, similar to the following:

Restore Default Values?
[1-Yes 2-No]

IF you want to THEN do the following:

retain current
configuration
settings for this
Meridian Digital
Telephone IP
Adapter unit,

- a. Press **2**.
- b. Press the **Hold** key.
- c. Proceed to step 5 on page 60.

revert Meridian
Digital Telephone
IP Adapter unit
configuration
settings to their
factory-set default
values,

- a. Press **1**.
 - b. Press the **Hold** key.
Result: The telephone display asks you to confirm your decision, similar to the following:
Confirm?
[1-Yes 2- No]
 - c. Press **1** to confirm your decision, or press **2** to retain current settings.
 - d. Press the **Hold** key.
-

- 5 The telephone display asks if you want to modify the unit ID of the Meridian Digital Telephone IP Adapter unit, similar to the following:

```
Modify Unit ID?  
[1-Yes 2-No]
```

IF you want to **THEN do the following:**

modify the Unit
ID of the Meridian
Digital Telephone
IP Adapter unit,

a. Press **1**.

b. Press the **Hold** key.

Result: The telephone display prompts you for the new Unit ID and displays the current Unit ID, similar to the following:

```
Enter Unit ID of 911x  
1
```

c. Press the digit(s) of the new Unit ID.

d. Press the **Hold** key.

e. Proceed to step 6 on page 61.

retain current Unit
ID of the Meridian
Digital Telephone
IP Adapter unit,

a. Press **2**.

b. Press the **Hold** key.

- 6 The telephone display asks if you want to modify the Meridian Digital Telephone IP Adapter unit's setting for the difference in the time at the local site and the remote site, similar to the following:

```
Modify Time Offset?
[1-Yes 2 - No]
```

Note: The Meridian Digital Telephone IP Adapter unit derives the time on its telephone display from the time maintained by the host PBX. The *time offset* is the number of minutes that the Meridian Digital Telephone IP Adapter unit must add to, or subtract from the host-site time (to account for different time zones, for example) to calculate the remote-site time.

IF you want to THEN do the following:

modify the Meridian Digital Telephone IP Adapter unit's current time offset between the host site and the remote site,

- a. Press **1**.
- b. Press the **Hold** key.

Result: The telephone display prompts you to indicate if the time at the remote site is later or earlier than the time at the host site, similar to the following:

```
Enter Sign [1-Add 2 -Sub]
```
- c. Press **1** if the time at the remote site is later than the time at the host site. This is the case when the remote site is located east of the host site.
- d. Press **2** if the time at the remote site is earlier than the time at the host site. This is the case when the remote site is located west of the host site.
- e. Press the **Hold** key.

Result: The telephone display prompts you for the number of minutes in the time offset. The telephone display also shows the current time offset, similar to the following:

```
Enter Offset in Minutes
Ø
```
- f. Enter the number of minutes of the time offset. For example, if the time offset is 2 hours, press **1**, **2**, and **0** (for 120 minutes).
- g. Press the **Hold** key.
- h. Proceed to step 8 on page 63.

IF you want to THEN do the following:

retain the current time offset between the PBX at the host site and the Meridian Digital Telephone IP Adapter unit at the remote site,

a. Press **2**.
b. Press the **Hold** key.

- 7** The telephone display asks if you want to modify the emergency code, similar to the following:

Modify Emergency Code?
[1-Yes 2-No]

This step does not apply to Meridian Digital Telephone IP Adapter units. Press **2** and continue to step 8 on page 63.

- 8 The telephone display asks if you want to modify the SPRE code that you must dial to go online manually, similar to the following:

```
Modify Online SPRE?
[1-Yes 2-No]
```

IF you want to **THEN do the following:**

modify the number that you must dial to go online with the Meridian Digital Telephone IP Adapter unit in the absence of an online command in the Online/Offline Table,

- a. Press **1**.
- b. Press the **Hold** key.

Result: The telephone display prompts you for a new online SPRE code. The telephone display also shows the current online SPRE code, similar to the following:

```
Enter Online SPRE
#99
```

- c. Press the digits of the new online SPRE code.

Note: All SPRE codes begin with a pound sign (#). It is not necessary to press the # key when modifying a SPRE code. However, when you actually use a SPRE code, you *must* press the # key for the host PBX to recognize the digits as a SPRE code.

- d. Press the **Hold** key.
- e. Proceed to step 9 on page 64.

retain the current online SPRE code,

- a. Press **2**.
 - b. Press the **Hold** key.
-

- 9 The telephone display asks if you want to modify the SPRE code that you must dial to go offline manually, similar to the following:

```
Modify Offline SPRE?
[1-Yes 2-No]
```

IF you want to **THEN do the following:**

modify the number that you must dial to go offline with the Meridian Digital Telephone IP Adapter unit in the absence of an offline command in the Online/Offline Table,

a. Press **1**.

b. Press the **Hold** key.

Result: The telephone display prompts you for a new offline SPRE code. The telephone display also shows the current offline SPRE code, similar to the following:

```
Enter Offline SPRE
#98
```

c. Press the digits of the new offline SPRE code.

Note: Refer to the Note on page 63 for information on pound signs (#) in SPRE codes.

d. Press the **Hold** key.

e. Proceed to step 10 on page 65.

retain the current offline SPRE code,

a. Press **2**.

b. Press the **Hold** key.

- 10** The telephone display asks if you want to modify the SPRE code that you must dial to register for, or begin a work session, the registration SPRE code, similar to the following:

```
Modify Reg. SPRE?
[1-Yes 2-No]
```

IF you want to THEN do the following:

modify the number that you must dial to begin a work session (in an ACD environment, for example),

- a. Press **1**.
- b. Press the **Hold** key.
Result: The telephone display prompts you for a new registration SPRE code. The telephone display also shows the current registration SPRE code, similar to the following:

```
Enter Reg. SPRE Code
#97
```
- c. Press the digits of the new registration SPRE code.
Note: Refer to the Note on page 63 for information on pound signs (#) in SPRE codes.
- d. Press the **Hold** key.
- e. Proceed to step 11 on page 66.

retain the current registration SPRE code,

- a. Press **2**.
 - b. Press the **Hold** key.
-

- 11** The telephone display asks if you want to modify the SPRE code that you must dial to deregister from, or end a work session, the Deregistration SPRE code, similar to the following:

```
Modify Dereg. SPRE?
[1-Yes 2-No]
```

IF you want to THEN do the following:

modify the number that you must dial to end a work session (in an ACD environment, for example),

- a. Press **1**.
- b. Press the **Hold** key.

Result: The telephone display prompts you to enter a new deregistration SPRE code. The telephone display also shows the current deregistration SPRE code, similar to the following:

```
Enter Dereg. SPRE Code
#96
```
- c. Press the digits of the new deregistration SPRE code.

Note: Refer to the Note on page 63 for information on pound signs (#) in SPRE codes.
- d. Press the **Hold** key.
- e. Proceed to step 12 on page 67.

retain the current deregistration SPRE code,

- a. Press **2**.
 - b. Press the **Hold** key.
-

- 12** The telephone display asks if you want to modify the IP parameters, similar to the following:

```
Modify IP Parameters?
[1-Yes 2-No]
```

IF you want to THEN do the following:

retain the current IP parameters configured for this Meridian Digital Telephone IP Adapter unit,

- a. Press **2**.
- b. Press the **Hold** key.
- c. Proceed to step 13 on page 70.

modify the IP parameters configured for this Meridian Digital Telephone IP Adapter unit,

- a. Press **1**.
 - b. Press the **Hold** key.
- Result:** The telephone display asks if you want to enable Dynamic Host Configuration Protocol (DHCP), similar to the following:

```
Enable DHCP?
[1-Yes 2-No]
```

allow a DHCP server to dynamically assign an IP address to this Meridian Digital Telephone IP Adapter unit each time someone logs on with this unit,

- a. Press **1**.
 - b. Press the **Hold** key.
 - c. Proceed to Enable DiffServ? [1-Yes 2-No] on page 69.
- Note:** Refer to the *Reach Line Card Installation and Administration Guide* (NTP 555-8421-210) for more information on DiffServ Codepoint and 802.1p mapping.

IF you want to THEN do the following:

manually enter static IP information for this Meridian Digital Telephone IP Adapter unit,

a. Press **2**.

b. Press the **Hold** key.

Result: The telephone display prompts you for the Meridian Digital Telephone IP Adapter unit's new, permanent IP address. The telephone display also shows the current setting, similar to the following:

```
Enter IP Address
0.0.0.0
```

c. Press the digits of the Meridian Digital Telephone IP Adapter unit's permanent IP address. Use the * key for the IP address delimiter. (Refer to the table on page 55.)

d. Press the **Hold** key.

Result: The telephone display prompts you for the Meridian Digital Telephone IP Adapter unit's new, permanent IP subnet mask. The telephone display also shows the current setting, similar to the following:

```
Enter IP Subnet Mask
255.0.0.0
```

e. Press the digits of the Meridian Digital Telephone IP Adapter unit's permanent IP subnet mask.

f. Press the **Hold** key.

Result: The telephone display asks if you want to modify the Meridian Digital Telephone IP Adapter unit's IP gateway, similar to the following:

```
Modify IP Gateway?
[1-Yes 2-No]
```

Note: Assigning static IP addressing to a Meridian Digital Telephone IP Adapter unit allows you to use the address information to identify the unit on the IP network. This makes the unit more accessible for online administration and maintenance.

IF you want to	THEN do the following:
manually enter static IP information for this Meridian Digital Telephone IP Adapter unit, (continued)	<p>g. Press 2 and proceed to Enable DiffServ? [1-Yes 2-No], below, to leave the Meridian Digital Telephone IP Adapter unit's IP gateway as it is. Press 1 to modify the Meridian Digital Telephone IP Adapter unit's IP gateway.</p> <p>h. Press the Hold key.</p> <p>Result: The telephone display prompts you for the Meridian Digital Telephone IP Adapter unit's new, permanent IP gateway. The telephone display also shows the current setting, similar to the following:</p> <pre>Enter IP Gateway 0.0.0.0</pre> <p>i. Press the digits of the Meridian Digital Telephone IP Adapter unit's permanent IP gateway. Use the * key for the IP address delimiter. (Refer to the table on page 55.)</p> <p>j. Press the Hold key.</p> <p>Result: The telephone display asks if you want to enable DiffServ, similar to the following:</p> <pre>Enable DiffServ? [1-Yes 2-No]</pre>
enable prioritizing of voice packets in the IP header (DiffServ),	<p>a. Press 1.</p> <p>b. Press the Hold key.</p> <p>c. Proceed to Enable 802.1p Mapping? [1-Yes 2-No] on page 70.</p> <p>Note: Refer to the <i>Reach Line Card Installation and Administration Guide</i> for information on DiffServ Codepoint and 802.1p mapping.</p>

IF you want to THEN do the following:

not enable
prioritizing of
voice packets in
the IP header,

- a. Press **2**.
- b. Press the **Hold** key.

Result: The telephone display asks if you want to enable 802.1p mapping, similar to the following:

```
Enable 802.1P Mapping?
[1-Yes 2-No]
```

enable prioritizing
of voice packets in
the IEEE Media
Access Control
layer (802.1p),

- a. Press **1**.
- b. Press the **Hold** key.
- c. Proceed to step 13, below.

not enable
prioritizing of
voice packets in
the IEEE Media
Access Control
layer,

- a. Press **2**.
 - b. Press the **Hold** key.
-

- 13** The telephone display asks if you want to modify RLC Parameters, similar to the following:

```
Modify RLC Parameters?
[1-Yes 2-No]
```

IF you want to THEN do the following:

retain the current
RLC settings,

- a. Press **2**.
- b. Press the **Hold** key.
- c. Proceed to step 18 on page 76.

IF you want to THEN do the following:

modify the current
RLC settings,
(continued)

a. Press **1**.

b. Press the **Hold** key.

Result: The telephone display prompts you to enter the RLC port number that you want to process this Meridian Digital Telephone IP Adapter unit's traffic. The telephone display also shows the RLC port number currently configured to handle this traffic, similar to the following:

```
Enter Port # of RLC
7
```

c. Press the digit(s) of the new port number.

d. Press the **Hold** key.

Result: The telephone display prompts you to enter the security level that you want to assign to this Meridian Digital Telephone IP Adapter unit. The telephone display also shows the current security level, similar to the following:

```
Enter Security Level
1
```

allow unrestricted
access to the
Meridian Digital
Telephone IP
Adapter unit and
the RLC,

a. Press **1** to select No security.

b. Press the **Hold** key.

c. Proceed to Enable IP? [1-Yes 2-No] on page 72.

IF you want to THEN do the following:

restrict access to the Meridian Digital Telephone IP Adapter unit according to a ten digit security code maintained by the security ID of the qualified callers,

a. Press **2** to select Provisioned Security.

b. Press the **Hold** key.

Result: The telephone display prompts you for the RLC's Inbound Security ID, similar to the following:

Inbound Security ID

c. Enter the Meridian Digital Telephone IP Adapter unit's 10-digit inbound security ID.

d. Press the **Hold** key.

Result: The telephone display prompts you for the RLC's outbound security ID, similar to the following:

Outbound Security ID

e. Enter the Meridian Digital Telephone IP Adapter unit's 10-digit outbound security ID.

f. Press the **Hold** key.

Result: The telephone display asks if you want to enable the IP connection to the RLC from this Meridian Digital Telephone IP Adapter unit, similar to the following:

Enable IP?

[1-Yes 2-No]

IF you want to THEN do the following:

enable IP connection to the RLC from this Meridian Digital Telephone IP Adapter unit,

a. Press **1**.

b. Press the **Hold** key.

Result: The telephone display prompts you to enter an IP address for the RLC and shows the current value it has for this address, similar to the following:

```
Enter RLC IP Address
192.68.243.254
```

c. Press the digits of the new RLC IP address.

d. Press the **Hold** key.

Result: The telephone display prompts you for the IP Signaling setting for this Meridian Digital Telephone IP Adapter unit and displays the current setting, similar to the following:

```
IP Signaling
1-Permanent 2-OnDemand:2
```

e. Choose from the options presented.

f. Press the **Hold** key.

g. Proceed to step 14 , below.

disable IP connection to the RLC from this Meridian Digital Telephone IP Adapter unit,

a. Press **2**.

b. Press the **Hold** key.

Result: Proceed to step 19 on page 77.

-
- 14** The telephone display asks if you want to modify the local calling settings on this Meridian Digital Telephone IP Adapter unit, similar to the following:

```
Modify Local Calling?
[1-Yes 2-No]
```

This step does not apply to Meridian Digital Telephone IP Adapter units. Press **2** and continue to step 15 on page 74.

- 15** The telephone display asks if you want to modify the current analog localization setting for this Meridian Digital Telephone IP Adapter unit, similar to the following:

```
Modify Localization?  
[1-Yes 2-No]
```

This step does not apply to Meridian Digital Telephone IP Adapter units. Press **2** and continue to step 16, below.

- 16** The telephone display asks if you want to modify the current modem tones setting for this Remote Office 911x series unit, similar to the following:

```
Modify Modem Tones?  
[1-Yes 2-No]
```

This step does not apply to Meridian Digital Telephone IP Adapter units. Press **2** and continue to step 17 on page 75.

- 17** The telephone display asks if you want to configure the type of telephone set attached to this Meridian Digital Telephone IP Adapter unit, similar to the following:

```
Configure Set Type?
[1-Yes 2-No]
```

IF you want to THEN do the following:

modify the
current telephone
set type
configuration for
this Meridian
Digital Telephone
IP Adapter unit,

a. Press **1**.

b. Press the **Hold** key.

Result: The telephone display asks what type of telephone set is connected to the Meridian Digital Telephone IP Adapter unit, similar to the following:

```
Is this a M2006?
[1-Yes 2-No]
```

c. If the telephone display does not show the model of your telephone set, press **2**.

d. Press the **Hold** key.

Note: The telephone display repeats this question until it receives an affirmative answer with the following set types: M2008, M2216, M2616, M2616CT, M3310, M3820, M3902, M3903, M3904, M3905, or OTHER. Choose OTHER if you are using a Nortel Networks digital telephone set with a display that is not included in the preceding list.

e. When the telephone display shows the model of your telephone set, press **1** and the **Hold** key.

Result: The telephone display asks you to confirm your identification of your telephone set type, similar to the following:

```
Are you sure?
M2616?- [1-Yes 2-No]
```

IF you want to THEN do the following:

- | | |
|---|---|
| modify the
current telephone
set type
configuration for
this Meridian
Digital Telephone
IP Adapter unit,
(continued) | f. If this is not the correct model number of your telephone set, press 2 and return to step e, above.
g. If this is the correct model number of your telephone set, press 1 .
h. Press the Hold key.
i. Proceed to step 18, below. |
| not modify the
current telephone
set type
configuration for
this Meridian
Digital Telephone
IP Adapter unit, | a. Press 1 .
b. Press the Hold key. |
-

- 18** The telephone display asks if you want to save the configuration you have just entered, similar to the following:

```
Save Configuration?
[1-Yes 2-No]
```

IF you want to THEN do the following:

- | | |
|--|---|
| discard your most
recent
configuration
changes, | a. Press 2 .
b. Press the Hold key.

Result: The telephone display asks if you want to reboot the Meridian Digital Telephone IP Adapter unit, similar to the following:

<pre>Reboot Unit? [1-Yes 2-No]</pre> c. Proceed to step 19 on page 77. |
|--|---|

IF you want to THEN do the following:

retain your most recent configuration changes,

- a. Press **1**.
- b. Press the **Hold** key.

Result: The telephone display asks you to confirm your instruction to overwrite current configuration settings with your latest configuration changes, similar to the following:

```
Confirm?
[1-Yes 2-No]
```

revert to the previous configuration settings,

- a. Press **2**.
- b. Proceed to step 19, below.

keep your most recent configuration changes as system settings,

- a. Press **1**.
 - b. Proceed to step 19, below.
-

Note: Do not interrupt the power to the Meridian Digital Telephone IP Adapter unit during the save process.

- 19** The telephone display asks if you want to reboot the Meridian Digital Telephone IP Adapter unit, similar to the following:

```
Reboot Unit?
[1-Yes 2-No]
```

IF you want to THEN do the following:

not reboot the Meridian Digital Telephone IP Adapter unit,

- a. Press **2**.
- b. Press the **Hold** key.

Result: Return to Display Local IP? [1-Yes 2-No] on page 57.

IF you want to	THEN do the following:
reboot the Meridian Digital Telephone IP Adapter unit,	a. Press 1 . Result: Press the Hold key. The telephone display asks if you want to shut the system down or restart the system, similar to the following: 0-Shut Down 1-Restart
restart the Meridian Digital Telephone IP Adapter unit,	a. Press 1 . b. Press the Hold key. Result: The telephone display asks you to confirm your decision to restart the system, similar to the following: Confirm? [1-Yes 2-No]
abort your instruction to restart the Meridian Digital Telephone IP Adapter unit,	a. Press 2 . b. Press the Hold key. Result: Return to Display Local IP? [1-Yes 2-No] on page 57.

IF you want to	THEN do the following:
confirm your instruction to restart the Meridian Digital Telephone IP Adapter unit,	<p>a. Press 1 to restart the Meridian Digital Telephone IP Adapter unit.</p> <p>b. Press the Hold key.</p> <p>Result: The telephone display informs you that it is restarting the system, similar to the following:</p> <pre data-bbox="525 407 829 467">Restarting the System Please Wait...</pre> <p>c. When the system restarts, the telephone display returns to its normal state, showing the time and date, similar to the following:</p> <pre data-bbox="525 594 705 618">JAN 01 12:13 P</pre> <p>d. If the telephone is connected to a PBX, it is ready to send and receive telephone calls as normal.</p> <p>e. If the telephone is not connected to a PBX, the telephone display shows a message similar to the following:</p> <pre data-bbox="525 834 713 859">HOSTLESS MODE</pre>
shut down the Meridian Digital Telephone IP Adapter unit, thereby disabling all functionality on the unit,	<p>a. Press 0.</p> <p>b. Press the Hold key.</p> <p>Result: The telephone display asks you to confirm your instruction to shut down the Meridian Digital Telephone IP Adapter unit, similar to the following:</p> <pre data-bbox="525 1084 700 1144">Confirm? [1-Yes 2-No]</pre> <p>Note: Only choose the shut down option when you have physical access to the remote unit. You must be able to disconnect then reconnect power to the Meridian Digital Telephone IP Adapter unit to be able to access the unit again.</p>

IF you want to	THEN do the following:
abort your instruction to shut down the Meridian Digital Telephone IP Adapter unit,	<p>a. Press 2.</p> <p>b. Press the Hold key.</p> <p>Result: Return to Display Local IP? [1-Yes 2-No] on page 57.</p>
confirm your instruction to shut down the Meridian Digital Telephone IP Adapter unit,	<p>a. Press 1.</p> <p>b. Press the Hold key.</p> <p>Result: The telephone display prompts you to turn off the Meridian Digital Telephone IP Adapter unit, similar to the following:</p> <pre>Please remove System Power</pre>

Chapter 5

Changing configuration settings using Configuration Manager

In this chapter

Before you begin	82
Meridian Digital Telephone IP Adapter unit system configuration	83
IP configuration	88
RLC connection configuration	91

Before you begin

This section describes the configuration settings that apply to Meridian Digital Telephone IP Adapter units. If you need remote serial access to Configuration Manager, use a remote management software application.

Note: Nortel Networks recommends that you use the telephone menu set to perform the initial configuration for the Meridian Digital Telephone IP Adapter unit. Refer to Chapter 4, “Configuring the IP Adapter unit using the telephone menu.” Once configured, you can then use the Configuration Manager for changes, administration, and firmware upgrades. For a more detailed description of Configuration Manager, refer to the *Reach Line Card Installation and Administration Guide* (NTP 555-8421-210).

Meridian Digital Telephone IP Adapter unit system configuration

This section describes the settings that apply to the Meridian Digital Telephone IP Adapter unit system.

Note: The Meridian Digital Telephone IP Adapter unit configuration follows the same configuration property sheets in Configuration Manager as the Remote Office 911x unit. To configure the Meridian Digital Telephone IP Adapter unit, choose View → Device Type → 911x. Help information for Remote Office 911x series units applies to Meridian Digital Telephone IP Adapter units, unless otherwise stated.

Getting there 911x → Configuration Manager → 911x System Configuration

Meridian Digital Telephone IP Adapter unit System Configuration property sheet

SYSTEM CONFIGURATION			
Unit ID	<input type="text" value="1"/>	Node Name	<input type="text" value="911x"/>
DSP Gain	<input type="text" value="0"/> dB		
Time Offset	<input type="text" value="0"/>	Emergency Activation Code	<input type="text" value="911"/>
SPRE Codes			
Online	Offline	Registration	DeRegistration
<input type="text" value="# 99"/>	<input type="text" value="# 98"/>	<input type="text" value="# 97"/>	<input type="text" value="# 96"/>
Local Call			
Status	<input type="radio"/> Enable <input checked="" type="radio"/> Disable	Local Calling Key Position	<input type="text" value="13"/>
		Autohold	<input type="radio"/> Enable <input checked="" type="radio"/> Disable
Local DN	<input type="text" value="NC"/>	Analog Localization	<input type="text" value="FCC"/>
Phone Type	<input type="text" value="M2616"/>	Modem Tones	<input type="radio"/> Enable <input checked="" type="radio"/> Disable
		Add on Module Type	<input type="text" value="Not Configured"/>
<input type="button" value="OK"/>	<input type="button" value="Default"/>	<input type="button" value="Send"/>	<input type="button" value="Retrieve"/>
<input type="button" value="Help"/>			

Configuring the system settings

To configure the system settings, complete the following procedure:

- 1 Complete the fields as described in the “Meridian Digital Telephone IP Adapter System Configuration field descriptions”, on page 85.
- 2 Click on the **OK** button to save the information in the temporary work file.
- 3 Click on the **Send** button to update the Meridian Digital Telephone IP Adapter unit with the new information.

IF you are

THEN

logged on to the Meridian Digital Telephone IP Adapter unit,

the changes are written into the Meridian Digital Telephone IP Adapter unit's buffer.
To save the changes in flash memory, choose Upload/Download › Save to Flash from the Menu Bar.

not logged on to the Meridian Digital Telephone IP Adapter unit,

the Confirmation Manager dialog box displays, similar to the following:

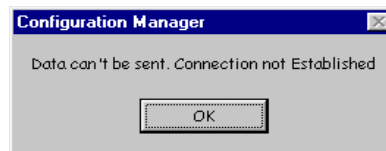

Do one of the following:

- a. Log on to the Meridian Digital Telephone IP Adapter unit and then click on the **Send** button.
- b. Save the changes to a file on your administration PC using the File -> Save As command.

Meridian Digital Telephone IP Adapter System Configuration field descriptions

Field	Description
Unit ID	<p>Assign a number between 1 and 20 to the Meridian Digital Telephone IP Adapter unit that you are configuring. This number:</p> <ul style="list-style-type: none">■ must be different from numbers assigned to other units connected to the same RLC■ must be consistent with the configuration on the RLC for this unit ID
Node Name	<p>Enter your site name. The node name identifies this Meridian Digital Telephone IP Adapter unit in the remote network.</p>
DSP Gain	<p>Select the number of decibels (dB) that you want to add to, or subtract from, the strength of the incoming signal before the DSP processes it. Valid options are: 9, 6, 3, 0, -3, -6, -9, -12, and -15.</p> <p>Note: Change this setting at the remote site to address a problem with signal strength at the host site.</p>
Time Offset	<p>Click on the up or down arrows to change the time zone difference from the host PBX.</p> <p>Note: The time can be changed in 15-minute intervals only.</p>
Emergency Activation Code	<p>This setting does not apply to Meridian Digital Telephone IP Adapters.</p>

Field	Description
SPRE Codes: Online	<p>Enter the SPRE code (maximum seven digits) that is used to place your site into online mode, or accept the default. The default is #99.</p> <p>Note: The SPRE code is automatically prefixed with the pound sign. This means users must dial # before the SPRE code when going into online mode.</p>
SPRE Codes: Offline	<p>Enter the SPRE code (maximum seven digits) that is used to put your site into offline mode, or accept the default code. The default is #98.</p> <p>Note: The SPRE code is automatically prefixed with the pound sign. This means users must dial # before the SPRE code when going into offline mode.</p>
SPRE Codes: Registration	<p>Enter the SPRE code (maximum seven digits) that engages the user's telephone with a multi-user or dynamic port, or accept the default code. The default is #97.</p> <p>Note: The SPRE code is automatically prefixed with a pound sign (#). This means users must dial # before the SPRE code when registering for a port.</p>
SPRE Codes: DeRegistration	<p>Enter the SPRE code (maximum seven digits) that disengages the user from a multi-user or dynamic port, or accept the default code. The default is #96.</p> <p>Note: The SPRE code is automatically prefixed with a pound (#) sign. This means users must dial # before the SPRE code when disengaging from a port.</p>
Local Call: Status	<p>This setting does not apply to Meridian Digital Telephone IP Adapters.</p>
Local Call: Local Calling Key Position	<p>This setting does not apply to Meridian Digital Telephone IP Adapters.</p>

Field	Description
Local Call: Autohold	This setting does not apply to Meridian Digital Telephone IP Adapters.
Local DN	This setting does not apply to Meridian Digital Telephone IP Adapters.
Analog Localization	This setting does not apply to Meridian Digital Telephone IP Adapters.
Modem Tones	This setting does not apply to Meridian Digital Telephone IP Adapters.
Phone Type	Select the type of digital telephone that the Meridian Digital Telephone IP Adapter unit attaches to, using the drop down list box. Valid options are: M2008, M2216, M2616, M2616CT, M3310, M3820, M3902, M3903, M3904, M3905, and OTHER.
Addon Module Type	Select the type of addon module attached to the Meridian Digital Telephone IP Adapter unit's telephone, if the telephone is an M3904 or M3905 telephone. Valid options are: DBA, KBA, and Not Configured.

IP configuration

This section explains how to change the IP address, subnet mask, and default gateway for the Meridian Digital Telephone IP Adapter unit.

Getting there 911x → Configuration Manager → IP Configuration

IP Configuration property sheet

The screenshot shows a dialog box titled "IP CONFIGURATION". At the top, there is a section for "Automatic DHCP Configuration" with two radio buttons: "Obtain IP Address from Server" (which is selected) and "Configure IP Address". Below this are three rows of IP address input fields, each with four boxes separated by dots. The "IP Address" row has all zeros. The "IP Network Mask" row has "255" in the first box and zeros in the others. The "IP Gateway" row has all zeros. Below the input fields are two groups of radio buttons: "DiffServ CodePoint" with "Enable" and "Disable" (selected), and "802.1p Mapping" with "Enable" and "Disable" (selected). At the bottom of the dialog are five buttons: "OK", "Default", "Send", "Retrieve", and "Help".

Configuring IP information

To change the IP information, complete the following procedure:

- 1 Complete the fields of the IP Configuration property sheet as described in “IP Configuration field descriptions”, on page 90.
- 2 Click on the **OK** button to save the information in the temporary work file.
- 3 Click on the **Send** button to update the **Meridian Digital Telephone IP Adapter unit with** the new information.

IF you are

THEN

logged on to the Meridian Digital Telephone IP Adapter unit,

the changes are written into the Meridian Digital Telephone IP Adapter unit's buffer. To save the changes in flash memory, choose Upload/Download › Save to Flash from the Menu Bar.

not logged on to the Meridian Digital Telephone IP Adapter unit,

the Configuration Manager dialog box displays, similar to the following:

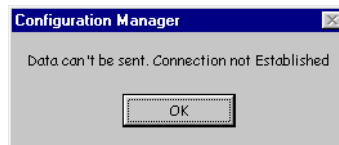

Do one of the following:

- a. Log on to the Meridian Digital Telephone IP Adapter unit, then click on the **Send** button again.
- b. Save the changes to a file on your administration PC.

- 4 Restart the Meridian Digital Telephone IP Adapter unit.

Note: To restart a Meridian Digital Telephone IP Adapter unit, use the procedure found under “Restarting the system”, on page 147.

IP Configuration field descriptions

Field	Description
Automatic DHCP Configuration	<ul style="list-style-type: none"> ■ Click on the Obtain IP Address from Server option button to allow the Meridian Digital Telephone IP Adapter unit to use an IP address dynamically assigned by a DHCP server on the IP network. Result: Configuration Manager disables the IP Address, IP Network Mask, and IP Gateway fields. ■ Click on the Configure IP Address option button to manually configure a static IP address for the Meridian Digital Telephone IP Adapter unit. Result: Configuration Manager enables the IP Address, IP Network Mask, and IP Gateway fields.
Address Information—IP Address, IP Network Mask, IP Gateway	If you clicked on the Configure IP Address option button, enter the IP address, IP network mask, and IP gateway in the appropriate fields.
DiffServ CodePoint	<ul style="list-style-type: none"> ■ Click on the Enable option button if you want to allow DiffServ prioritizing in the IP header. ■ Click on the Disable option button if you do not want to allow DiffServ prioritizing.
802.1p Mapping	<ul style="list-style-type: none"> ■ Click on the Enable option button, if you want to allow 802.1p prioritizing in the IEEE Media Access Control layer. ■ Click on the Disable option button, if you do not want to allow 802.1p prioritizing.

RLC connection configuration

This section shows you how to change the RLC connection information needed by the Meridian Digital Telephone IP Adapter unit to establish connections with the RLC on the host PBX.

Getting there 911x → Configuration Manager → RLC Connection Configuration

RLC Connection Configuration property sheet

RLC CONNECTION CONFIGURATION

Unit ID: 254

RLC Port Number: 0

IP Connection: Enable Disable

IP Address: 0 . 0 . 0 . 0

IP Signaling: Permanent On Demand

PSTN Connection: Enable Disable

PSTN Number to Connect to RLC: []

Security Level: No Security

Security Id: Outbound Security ID [] Inbound Security ID []

IDVR Feature Keys

OK Default Send Retrieve Help

Configuring the RLC connection information

To change the RLC connection information, complete the following procedure:

- 1 Complete the fields of the RLC Connection property sheet as described in “RLC Connection configuration field descriptions” on page 93.
- 2 Click on the **OK** button to save the information in the temporary work file.
- 3 Click on the **Send** button to update the Meridian Digital Telephone IP Adapter unit with the new information.

IF you are

THEN

logged on to the Meridian Digital Telephone IP Adapter unit,

the changes are written into the Meridian Digital Telephone IP Adapter unit's buffer. To save the changes in flash memory, choose Upload/Download › Save to Flash.

not logged on to the Meridian Digital Telephone IP Adapter unit,

the Configuration Manager dialog box displays, similar to the following:

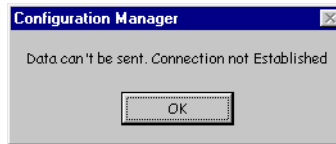

Do one of the following:

- a. Log on to the Meridian Digital Telephone IP Adapter unit, then click on the **Send** button again.
- b. Save the changes to a file on your administration PC.

RLC Connection configuration field descriptions

Field	Description
Unit ID	The RLC's non-configurable unit ID of 254.
RLC Port Number	Enter the RLC voice port number designated for the Meridian Digital Telephone IP Adapter unit on the RLC Remote connection configuration property sheet.
IP Connection	<p>Click on the Enable option button, if you want to route calls over your IP network.</p> <p>Click on the Disable option button, if you do not want to route calls over your IP network.</p>
IP Connection: IP Address	Enter the RLC's IP address. The Meridian Digital Telephone IP Adapter unit uses this IP address to connect to the RLC over the IP network.
IP Connection: IP Signaling	<p>Click on the Permanent option button to configure this port's IP connection to be up at all times.</p> <p>Click on the On Demand option button to configure this port's IP connection to be up only when needed.</p> <p>Refer to "Deployment", on page 36 for help in determining which setting to configure.</p>
PSTN Connection	This setting does not apply to Meridian Digital Telephone IP Adapters.
PSTN Connection: PSTN Number to Connect to RLC	This setting does not apply to Meridian Digital Telephone IP Adapters.

Field	Description
Security Level	Select No Security from the drop down list box if you do not want the RLC to perform a security check. Select Provision ID from the drop down list box to require the RLC to perform a security check every time a user tries to log on to a remote unit. This action enables the Security ID fields.
Security ID: Outbound Security ID	Enter the 10-digit Meridian Digital Telephone IP Adapter unit security identifier.
Security ID: Inbound Security ID	Enter the 10-digit RLC security identifier.

Chapter 6

Using the digital telephone

In this chapter

Modes of operation	96
Placing and receiving calls	98
Indicator updates	100
Display messages	101
Telephone features operation	103
Going online and offline	105

Modes of operation

Digital telephones at your Meridian Digital Telephone IP Adapter unit site can operate in the following modes:

- host-controlled
- online to host PBX
- offline from host PBX

Host-controlled mode

Host-controlled mode means that the host PBX controls the following:

- some display messages that appear on your telephone
- indicator updates such as the message waiting indicator
- calls that you receive from or place to someone at the host PBX site

In host-controlled mode, a voice path is established to the host PBX and signaling messages are passed between the host PBX and the Meridian Digital Telephone IP Adapter unit.

Online mode

When in online mode, calls initiated on the host calling key are directed through the host PBX. The display on your digital telephone set shows **Online Mode**.

Offline mode

When in offline mode, you cannot place or receive calls through the host PBX. The display on all digital telephone sets show **Offline Mode**.

What controls the online and offline modes

The online and offline modes can be controlled by one or both of the following:

- online/offline schedule configured for your site on the RLC at the host PBX

- special prefix (SPRE) codes configured on the Meridian Digital Telephone IP Adapter unit at your site

For more information, refer to “SPRE Codes: Online” on page 86 and “SPRE Codes: Offline” on page 86.

Placing and receiving calls

Place outgoing calls by pressing the calling key to receive an outgoing line.

Receiving incoming calls

A Meridian Digital Telephone IP Adapter unit receives host-controlled incoming calls over the IP network.

Methods for placing outgoing calls

You can place an outbound call from a Meridian Digital Telephone IP Adapter unit station in one of the following ways:

- method 1: Lift the telephone handset.
This method automatically initiates a host-controlled call.
- method 2: Press the calling key.
Pressing the host calling key initiates a host-controlled call.

Placing a host-controlled call

To place a host-controlled call, complete the following procedure:

- 1 Lift the telephone handset or press the host calling key.

Result: You hear a dial tone over a connection with the host PBX.

Note: If a connection to the host PBX cannot be established within a time-out period or no resources are available to carry the call, you hear a reorder dial tone (fast busy signal), and one of the following messages appears on the telephone display:

- Release and Try Again
- Bandwidth Limit
- DSP Limit

Bandwidth limit indicates that there was not enough bandwidth available in the system to complete to requested task.

DSP limit indicates that there were not enough available DSP resources in the system to complete the requested task.

- 2 Dial the number of the party you want to call.

Result: The host PBX receives and processes the dialed digits, and rings the called party.

To call another station at your site—host-controlled mode

Station-to-station calls should be attempted through the host PBX to allow all stations configured as multiple appearance DN (MADNs) to ring and provide access to voice mail, if the call is not answered.

If a connection cannot be established through the host PBX, you can use the local calling key to place the station-to-station call.

- 1 Lift the telephone handset or press the host calling key.

Result: A connection is established with the host PBX and you hear a dial tone. The indicator beside the host calling key lights up.

- 2 Dial the extension of the party you wish to reach.

Result: The host PBX receives and processes the dialed digits, and rings the station as well as any other stations that include the dialed DN as an MADN key.

Note: The MADN stations could be located at another site (such as the host PBX site). If the call is answered by a MADN station at another site, a voice path to the host PBX is established and the call proceeds.

Indicator updates

Digital telephone indicators reflect the current status of the telephone. For example, they identify when calls are waiting, active, on hold, or (if your office has voice mail) that messages are waiting.

The host PBX updates indicators when a connection between the host PBX and Meridian Digital Telephone IP Adapter unit is active.

Host-controlled indicator updates

The host PBX automatically updates indicators for host-controlled features each time any of the following occur:

- the host PBX receives an incoming call from your site
- the host PBX processes an outgoing call from your site
- the host PBX sends a message waiting indicator (MWI) update

Note: When online with a permanent connection to the host PBX, a remote site receives constant telephone indicator updates.

Display messages

This section describes the messages that can appear on your digital telephone display.

Message descriptions

Message	Description
Going Offline in 30 Secs Going Offline in 20 Secs Going Offline in 10 Secs	<p>This message warns you that all digital telephones at this site are about to go offline in the number of seconds indicated.</p> <p>If any calls are active, they disconnect when the offline mode activates.</p> <p>To override, enter the online SPRE code.</p>
Hostless Mode	<p>The connection to the host PBX cannot be established. The host PBX may be temporarily unavailable.</p> <p>Note: If Hostless Mode persists, contact your system administrator.</p>
Logged In	<p>If this message appears on your station, your station participates in a multi-user or dynamic pool port on the RLC. Your station is logged on.</p> <p>Note: This message only displays for approximately 10 seconds.</p>
Offline Mode	<p>This means you cannot place calls through the host PBX.</p> <p>Notes:</p> <ul style="list-style-type: none"> ■ If you need to place a call through the host PBX while in offline mode, enter the online SPRE code. Refer to “SPRE Codes: Online” on page 86 for further details. ■ The Offline Mode message is not persistent on the M3903 telephone display. This message sometimes does not appear for the entire Offline period.

Message	Description
Online Mode	This means you can place and receive calls through the host PBX.
Port Already in Use	<p>If this message appears on your station, your station participates in a multi-user or dynamic pool port on the RLC.</p> <p>This message appears if the port that you are attempting to log on to is already being used by someone else.</p>
Port Not Logged In	If this message appears on your station, your station participates in a multi-user or dynamic pool port on the RLC. Your station is logged off.
Release and Try Again	<p>There are not enough DSP resources to process the call. Try again at a later time.</p> <p>Note: Ensure to initiate calls from the appropriate calling key according to the following parameters:</p> <ul style="list-style-type: none">■ Use the host calling key to call someone at the host PBX site.
Bandwidth Limit	There is not enough bandwidth to complete the requested action.
DSP Limit	There were not enough DSP resources to complete the requested action.

Telephone features operation

This section describes how to use the following digital telephone features in host-controlled modes:

- call forward
- call transfer
- call waiting
- conference
- emergency service calls
- hold

Emergency service calls

Do not place an emergency service call, for instance a call for police, fire department, or ambulance help, using a telephone connected to a Meridian Digital Telephone IP Adapter unit.

Hold

When you press the Hold key on a host-controlled call, the holding party receives the Hold treatment defined on the host PBX. For example, if the host PBX is configured to play music for the holding parties, then the holding party hears music. You can press the local calling key to place a new call.

Call Waiting

Since the Meridian Digital Telephone IP Adapter unit does not use host-controlled indicators, there are never any indicator conflicts when a call is presented to the station.

The Meridian Digital Telephone IP Adapter unit always checks the status of your station before ringing it. If your station is busy with a call, the alert tone is sounded instead.

How Call Waiting works in host-controlled mode

If you are busy with a host-controlled call, incoming calls are handled as follows:

- An incoming host-controlled call is directed to the call waiting key by the host PBX.
- An incoming locally controlled call flashes the local calling key indicator and sounds the alert tone.

Call Transfer

To transfer a call, complete the following procedure:

- 1 Press the **Transfer** key.

Result: The active call is placed on hold and you hear dial tone.

- 2 Dial the number that you want to transfer the call to.

- 3 Press the **Transfer** key again to complete the transfer.

Note: You can press the Transfer key while the call is still ringing, or after the called party answers.

Going online and offline

Your Meridian Digital Telephone IP Adapter unit site can operate in either online mode or offline mode. This is controlled by one or both of the following:

- SPRE codes to manually toggle between online and offline modes.
- An online/offline schedule on the host PBX to automatically toggle your site between online and offline modes.

For a description of the online and offline modes, refer to “Modes of operation” on page 96.

Using the SPRE code to place your unit in online mode

To use the SPRE code to place your unit in online mode, complete the following procedure:

- 1 Lift the telephone handset, or press the local calling key.
- 2 Press the pound (#) key followed by the online SPRE code.

Note: Contact your system administrator for the online SPRE code.

Result: The connection to the host PBX is initiated and negotiated with the host PBX. During this negotiation period (up to five seconds), you cannot place host-controlled calls. When negotiation is completed and connection to the host PBX has been established, Online Mode appears on the telephone display and the system is ready to place and receive host calls.

Using the SPRE code to place your unit in offline mode

To use the SPRE code to place your unit in offline mode, complete the following procedure:

- 1 Dial the pound (#) key followed by the offline SPRE code.

Note: Contact your system administrator for the online SPRE code.

Result: Offline Mode appears on the telephone display.

Overriding an automatic offline event from the host PBX

If the host PBX attempts to process an offline event while you are on a host-controlled call, you are alerted by both an audible alert and a display message indicating that you are about to go offline in 30, 20, or 10 seconds. If you ignore this warning, your call disconnects.

To prevent your call from being disconnected, enter the online SPRE code. You can do this without putting your call on hold first. The online SPRE code cancels the offline event, leaving your telephone online until the next offline event occurs.

Chapter 7

Administration

In this chapter

Changing the administration password	108
Creating a backup configuration file	110
Restoring the configuration	113
Display logs	118
Statistics screens	122
Verifying the firmware and software version	139
Obtaining the latest upgrade file	141
Extracting upgrade files from the download file	142
Performing a firmware upgrade	144
Restarting the system	147
Performing a software upgrade	148

Changing the administration password

Two layers of password security protect the Meridian Digital Telephone IP Adapter unit's configuration. If you want to secure the Meridian Digital Telephone IP Adapter unit's configuration, then change the following items:

- Configuration Manager password
This password prevents unauthorized users from performing offline configuration changes.
- Meridian Digital Telephone IP Adapter unit's password
This password prevents unauthorized users from performing online changes of the configuration residing in the Meridian Digital Telephone IP Adapter unit's flash memory.

Note: Make sure that you record the password and store it in a safe, secure location. If you forget or lose the password, contact your Nortel Networks customer support representative.

Getting there 911x → Configuration Manager

Changing the Configuration Manager password

To change the Configuration Manager password, complete the following procedure:

- 1 From the Menu Bar, choose Connect → Change Password → Local.

Result: The Change Password dialog displays, similar to the following:



The image shows a Windows-style dialog box titled "Change Password - Local". It has a standard title bar with a close button (X). The dialog contains three text input fields, each with a label to its left: "Old Password", "New Password", and "Retype New Password". At the bottom of the dialog, there are two buttons: "OK" and "Cancel".

- 2 Complete the fields in the Change Password - Local dialog box.
- 3 Click on the **OK** button.

Changing the Meridian Digital Telephone IP Adapter unit's password

To change the Meridian Digital Telephone IP Adapter unit's password, complete the following procedure:

ATTENTION

Do not change the Meridian Digital Telephone IP Adapter unit's password until the system is up and working.

- 1 From the Menu Bar, choose Connect → Change Password → Node.

Result: The Change Password dialog box displays, similar to the following:

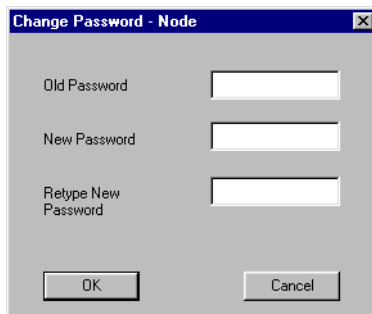

- 2 Complete the fields in the Change Password - Node dialog box.
- 3 Click on the **OK** button.

Creating a backup configuration file

Create a backup copy of the Meridian Digital Telephone IP Adapter unit's configuration by downloading the configuration flash memory to a text file on your administration PC. Nortel Networks recommends that you create a backup of your configuration file whenever you make configuration changes or after you perform a firmware upgrade.

Storing backup configuration files

The Meridian Digital Telephone IP Adapter unit is an extension of the telecommunications and data network. It is extremely important that you keep a backup copy of the Meridian Digital Telephone IP Adapter unit's configuration. If the Meridian Digital Telephone IP Adapter unit's flash memory or configuration becomes corrupted or is lost, you can easily restore it.

Store the configuration file in a safe, secure location, such as on backup tape or other media that is stored offsite.

Nortel Networks recommends that you keep the backup files indefinitely.

Getting there 911x → Configuration Manager

Creating the backup file

To create the backup file:

- 1 From the Menu Bar, choose Upload/Download → Download Config.

Result: The Download Configuration dialog box displays, similar to the following:

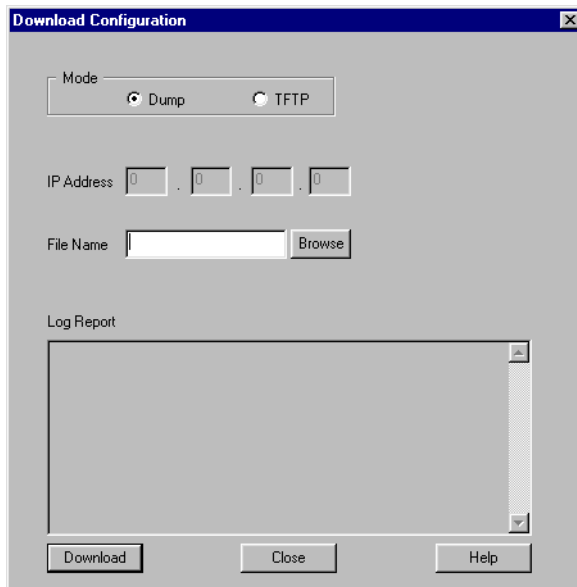

- 2 Choose the mode you want to use for the file transfer according to the following table:

IF you wish to save the configuration file to

the administration PC,
a different location on the IP network,

THEN do the following:

Click on the **Dump** option button.

- 1 Click on the **TFTP** option button.

Result: This enables the IP Address fields.

- 2 Enter the IP address of the PC that you want to save the configuration file on.

- 3 Click on the **Browse** button and navigate to the folder where you want to keep the configuration text file.

- 4 Enter a name for the file in the File name field.

Note: This configuration file becomes your backup file, so ensure the file name is meaningful. The file name's extension must be .TXT.

- 5 Click on the **Download** button.

Result: The Download configuration dialog box closes, and the following message displays in the status bar at the bottom of the screen:

Downloading Config From Board

When the download is complete, the Downloaded Configuration Data dialog box displays, similar to the following:

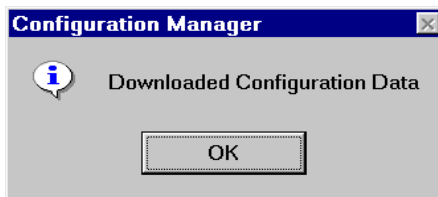

- 6 Click on the **OK** button.

Restoring the configuration

Restore the Meridian Digital Telephone IP Adapter unit's configuration in flash memory by uploading a configuration text file from your administration PC.

Perform the upload over the IP network using the TFTP protocol. You must have a TFTP server application running on your administration PC. The TFTP server's base directory must point to the directory that contains the configuration file you want to upload.

Before you begin

Before you can upload the configuration file to the Meridian Digital Telephone IP Adapter unit, you must complete the following steps:

- 1 Start the TFTP server application.
- 2 Ensure the TFTP base directory points to the location of the configuration file.

Getting there 911x → Configuration Manager

Uploading a configuration file over the IP network

To upload a configuration file over the IP network, complete the following procedure:

- 1 Navigate to the location of the configuration file.
- 2 From the Menu Bar, choose → Upload/Download → Upload Config.

Result: The Upload Configuration dialog box displays, similar to the following:.

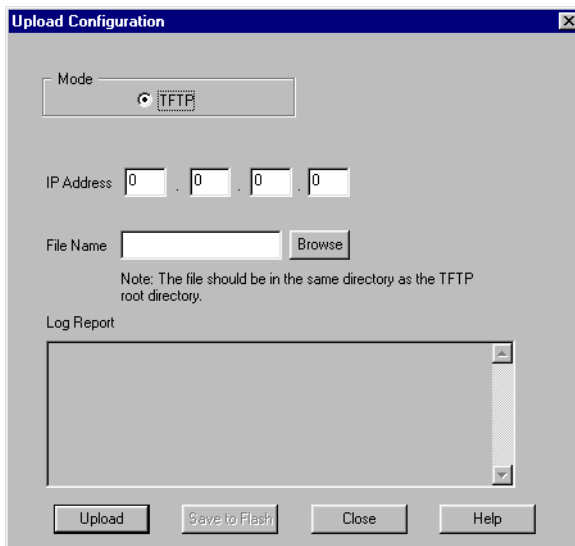

The screenshot shows a dialog box titled "Upload Configuration". It features a "Mode" section with a radio button selected for "TFTP". Below this is an "IP Address" field consisting of four separate input boxes, each containing the digit "0". A "File Name" field is followed by a "Browse" button. A note states: "Note: The file should be in the same directory as the TFTP root directory." There is a "Log Report" section with a large empty text area. At the bottom, there are four buttons: "Upload", "Save to Flash", "Close", and "Help".

- 3 Enter the IP address of the TFTP server in the IP Address fields.

Note: Since the TFTP server application is running on your administration PC, this is the IP address of that PC.

- 4 Click on the **Browse** button.

Result: The Open dialog box displays, similar to the following:

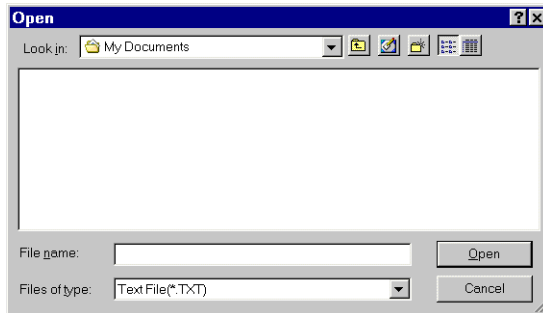

- 5 Ensure the Files of type list drop down box shows Text File (*.TXT)
- 6 Navigate to the folder containing the configuration file.
- 7 Select the file, then click on the **Open** button.

Result: The Upload Configuration dialog box displays with the file you selected shown in the File Name field.

8 Click on the **Upload** button.

Result: The middle of the Upload Configuration dialog box displays status messages relating to the upload. The following is an example.

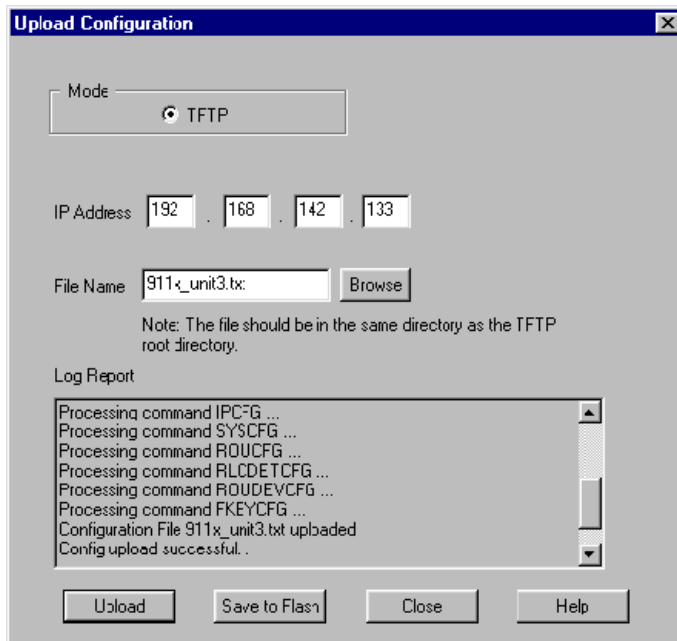

CAUTION

Risk of incorrect operation due to partial configuration

Do not interrupt the configuration upload. If you interrupt the configuration upload, this results in an incomplete configuration in the Meridian Digital Telephone IP Adapter unit's database.

If the configuration upload is interrupted, repeat this procedure immediately.

IF the upload was	THEN
successful,	the following message displays: CONFIG UPLOAD SUCCESSFUL... USE SAVECFG TO UPDATE FLASH.
not successful,	the following message displays in the middle of the Upload Configuration dialog box: CONFIG UPLOAD FAILED For further instructions, refer to Chapter 8, "Troubleshooting".

Note: Do not ignore error messages in Save to Flash process. If Save to Flash fails, retry uploading and saving to Flash. If the problem persists, check the file being uploaded and report the problem to Nortel Networks.

- From the Upload Configuration dialog box, click on the **Save to Flash** button.

Result: The FLASH CONFIG dialog box displays, similar to the following:

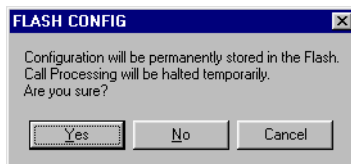

- Click on the **Yes** button.

Result: The following message displays in the status bar at the bottom of the screen:

Saving to Flash in Progress

When the save is finished, the following message displays in the middle of the Upload Configuration dialog box:

CONFIGURATION IS UPDATED INTO FLASH...

- Click on the **Close** button.
- Restart the RLC.

Note: For instructions, refer to "Restarting the system" on page 147.

Display logs

The Meridian Digital Telephone IP Adapter unit keeps track of system performance through the maintenance of display logs. Each line, or display log, represents a separate action completed by the unit.

Use the display logs when troubleshooting system problems. Click on the **Save Report** button if you need to print the display logs to a text file. Refer to Configuration Manager Help for a complete listing of all display logs and the condition indicated by each.

Getting there 911x → Configuration Manager

Viewing display logs

From the Menu Bar, choose Alarms/Stats/Logs → Display Logs.

Result: The Meridian Digital Telephone IP Adapter unit lists the display logs it maintains in a window similar to the following. You can use the scroll bar to browse through the display logs.

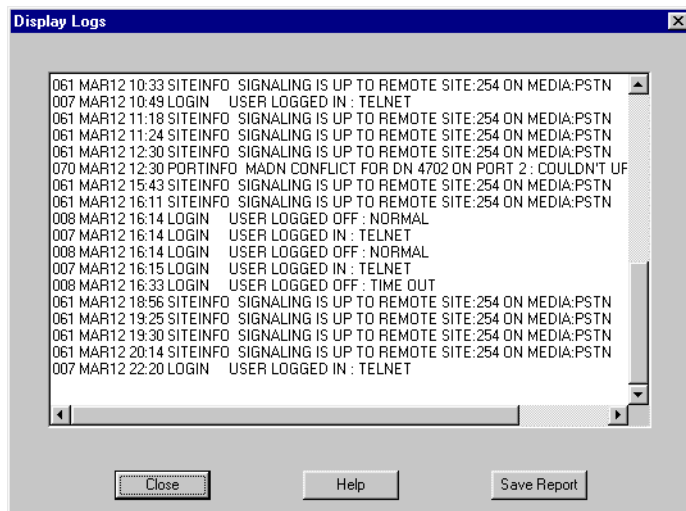

Printing the display logs to a file

If you request technical support, your support representative can ask you to provide a copy of the display logs. To recreate the log in a file on your administration PC, use the following procedure:

- 1 After listing the display logs using the procedure explained under “Viewing display logs” on page 118, click on the **Save Report** button on the Display Logs window.

Result: The Save As dialog box displays, similar to the following:

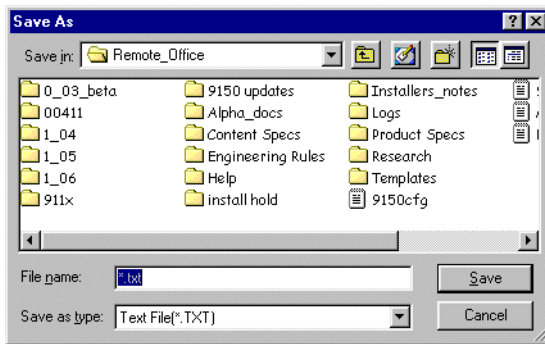

- 2 Enter a name for the configuration in the File name field.

Result: Configuration Manager saves the display logs to a text file in the location indicated in the Save As dialog box.

Changing the number of display logs retained by the Meridian Digital Telephone IP Adapter unit

A Meridian Digital Telephone IP Adapter unit retains a maximum of 1000 display logs, each requiring one line of text. When the unit's display logs reach 1000 lines, new display logs overwrite existing display logs on a first in, first out basis. If you want to change the number of display logs retained by the Meridian Digital Telephone IP Adapter unit, complete the following procedure:

- 1 From the Menu Bar, choose Alarms/Stats/Logs → Resize Logs.

Result: The Resize Log dialog box displays, similar to the following:



Note: “Maximum logs” refers to the number of text lines, or messages, maintained by the Meridian Digital Telephone IP Adapter unit. The Meridian Digital Telephone IP Adapter unit currently retains a maximum of 1000 text lines.

- 2 Enter the maximum number of text lines you want maintained by the Meridian Digital Telephone IP Adapter unit in the Maximum Logs field.
- 3 Click on the **OK** button.

Clear logs

The Meridian Digital Telephone IP Adapter unit allows you to delete unneeded information by clearing the display logs. To discard or clear display logs that are no longer useful, complete the following procedure:

- 1 From the Menu Bar, choose Alarms/Stats/Logs → Clear Logs.

Result: The CLEAR LOGS dialog box displays, similar to the following:

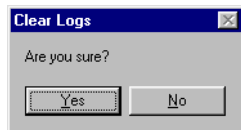

IF you select**THEN**

No,

the Clear logs dialog box closes and the retained display logs remain as they are.

Yes,

- the Meridian Digital Telephone IP Adapter unit deletes its stored display logs.
- the LOGS cleared dialog box displays, similar to the following:

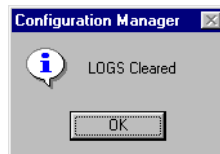

Click on the **OK** button.

To display the Bandwidth Connection Statistics screen, refer to “Displaying the Bandwidth Connection Statistics screen”, as follows. To obtain the definitions for the statistics presented on the Bandwidth Connection Statistics screen, refer to “Bandwidth Connection Statistics field descriptions” on page 124.

Displaying the Bandwidth Connection Statistics screen

Choose Alarms/Stats/Logs → BW Connection Statistics from the Menu Bar to display the Bandwidth Connection Statistics screen.

Result: Configuration Manager gathers statistics from the Meridian Digital Telephone IP Adapter unit and displays the Bandwidth Connection Statistics screen, similar to the example on page 122.

IF you want to	THEN click
update the statistics with the latest information,	on the Refresh button.
create a text file containing these statistics,	on the Save to File button.
close the Trunk Connection Statistics screen,	on the Close button.
obtain descriptions of the statistics in the Trunk Connection Statistics screen,	on the Help button.

Bandwidth Connection Statistics field descriptions

The following table describes the statistics on the Bandwidth Connection Statistics screen:

Statistic	Description
Remote Unit Number	Identifies the remote unit that initiated the call.
Signaling Status	Identifies whether a connection is up on this unit. Valid options are: Active and Idle.
No of Voice Calls on IP	Identifies the number of calls in progress on this unit's IP connection.
No of Voice Calls on PSTN	Note: PSTN statistics do not apply to Meridian Digital Telephone IP Adapter units.
Used IP BW	Identifies the IP bandwidth in use on this unit.
Used Trunk BW	Note: Trunk bandwidth statistics do not apply to Meridian Digital Telephone IP Adapter units.
Total Up Trunk BW	Note: Trunk bandwidth statistics do not apply to Meridian Digital Telephone IP Adapter units.
IP QoS Status	Note: QoS statistics do not apply to Meridian Digital Telephone IP Adapter units.

Displaying the Caller Info Statistics screen

Choose Alarms/Stats/Logs → Caller Info Statistics from the Menu Bar to display the Caller Info Statistics screen.

Result: Configuration Manager gathers the statistics from the Meridian Digital Telephone IP Adapter unit and displays the Caller Info Statistics screen, similar to the example on page 125:

IF you want to	THEN click
update the statistics with the latest information,	on the Refresh button.
create a text file containing these statistics,	on the Save to File button.
close the Trunk Connection Statistics screen,	on the Close button.
obtain descriptions of the statistics in the Trunk Connection Statistics screen,	on the Help button.

Caller Info Statistics field descriptions

The following table describes the statistics on the Caller Info Statistics screen:

Statistic	Description
Connection ID	Identifies the serial number of this call through the lifetime of the logged on unit.
Remote ID	Identifies the unit ID of the involved remote unit.
Current Media	PSTN statistics do not apply to Meridian Digital Telephone IP Adapters.
Type	Identifies the type of call. Valid options are: Signaling, Voice, and Local.
Priority	PSTN statistics do not apply to Meridian Digital Telephone IP Adapters.
Call BW	Identifies the amount of bandwidth used by the call.
Start Time	Identifies the time that the connection initiated.
Transitions to PSTN	Transition statistics do not apply to Meridian Digital Telephone IP Adapters.
Transitions to IP	Transition statistics do not apply to Meridian Digital Telephone IP Adapters.
Last Transition to PSTN	Transition statistics do not apply to Meridian Digital Telephone IP Adapters.
Last Transition to IP	Transition statistics do not apply to Meridian Digital Telephone IP Adapters.

Displaying the DSP Statistics screen

Choose Alarms/Stats/Logs → DSP Statistics from the Menu Bar to display the DSP Statistics screen.

Result: Configuration Manager gathers statistics from the Meridian Digital Telephone IP Adapter unit and displays the DSP Statistics screen, similar to the example on page 128.

IF you want to**THEN click**

update the statistics with the latest information,

on the **Refresh** button.

create a text file containing these statistics,

on the **Save to File** button.

close the Trunk Connection Statistics screen,

on the **Close** button.

obtain descriptions of the statistics in the Trunk Connection Statistics screen,

on the **Help** button.

DSP Statistics field descriptions

The following table describes the statistics on the DSP Statistics screen:

Statistic	Description
Single Digit Device ID	Identifies an internal sequence number for indexing this DSP device among all others on the RLC linked to the Meridian Digital Telephone IP Adapter unit.
Module Number	Identifies this DSP Application Module's module number on the RLC linked to the Meridian Digital Telephone IP Adapter unit. Valid options are: 0, 1, 2, 3, and 4.
Device Number	Identifies the DSP device that processed the call.
In Service	Identifies any voice channels operating on this DSP application module.
Total MIPS	Identifies the total millions of instructions per second (MIPS) capacity for this DSP device.
Available Mips	Identifies the millions of instructions per second (MIPS) currently available on this DSP device.
Total Channels	Identifies the total channel capacity for this DSP device.
Total Voice Channels	Identifies the total voice channel capacity for this DSP device.
Available Voice Channels	Identifies the number of unused voice channels on this DSP device.
Total Modem Channels	Identifies the number of channels on this DSP device that can transmit modem calls.

Statistic	Description
Available Modem Channels	Identifies the number of unused channels on this DSP that can transmit modem calls.
Total Flex Channels	Identifies the number of channels on this DSP that can provide multiple functionalities.
Available Flex Channels	Identifies the number of channels on this DSP currently available to provide multiple functionalities.
Total Tones Channels	Identifies the number of channels on this DSP that can transmit tones.
Total Reserved Channels	Identifies the number of special purpose channels on this DSP reserved for internal use.
Name	Identifies the name of the DSP load, that is, the combination of DSP algorithms, on the DSP module.

Displaying the Ethernet Interface Statistics screen

Choose Alarms/Stats/Logs → Ethernet Interface Statistics from the Menu Bar to display the Ethernet Interface Statistics screen.

Result: Configuration Manager gathers statistics from the Meridian Digital Telephone IP Adapter unit and displays the Ethernet Interface Statistics screen, similar to the example on page 132.

IF you want to**THEN click**

update the statistics with the latest information,

on the **Refresh** button.

create a text file containing these statistics,

on the **Save to File** button.

close the Trunk Connection Statistics screen,

on the **Close** button.

obtain descriptions of the statistics in the Trunk Connection Statistics screen,

on the **Help** button.

Ethernet Interface Statistics field descriptions

The following table describes the statistics on the Ethernet Interface Statistics screen:

Statistic	Description
Channel	Identifies the Ethernet device that the statistics on that line apply to. Valid option is: 1
LAN Drv	Identifies the LAN driver used by the call.
Admin	Identifies the desired state of the port.
Oper	Identifies the actual state of the port.
IfcType	Identifies the interface type used by the call.
IfcNo	Identifies the Ethernet interface used by the call. Valid options are: 0 (ELAN) and 1 (CLAN).
MTUlen	Identifies the Maximum Transmission Unit for this interface.
Speed	Identifies the data rate of this interface.
In - Octet	Identifies the number of inbound bytes.
UPkts	Identifies the number of inbound packets sent only to this recipient.
MPkts	Identifies the number of inbound packets sent to multiple recipients.
Disc	Identifies the number of packets discarded by the interface.
Err	Identifies the number of error packets received by the interface.
Out - Octet	Identifies the number of outbound bytes.
UPkts	Identifies the number of outbound packets sent only to this recipient.

Statistic	Description
MPkts	Identifies the number of outbound packets sent to multiple recipients.
Disc	Identifies the number of outbound packets discarded by the interface due to resource problems.
Err	Identifies the number of outbound packets discarded due to errors.
QLen	Identifies the number of bytes in the interface's outbound queue.

Network Statistics

Network Statistics allow you to see the performance of the Meridian Digital Telephone IP Adapter unit in terms of the transmission and reception of frames and packets during the last 24 hours. Use this log to identify periods when other network activity can adversely affect Remote Office system performance.

Network Statistics

Remote Unit Number = 1

Hour	Tx Frames	Rx Frames	Rx Error	Rx Dropped	Error %	BroadCast Packet	Tx UCastPkt	Tx DiscPkt	F
0	0	0	0	0	0.00	0	173	0	
1	0	0	0	0	0.00	0	303	0	
2	0	0	0	0	0.00	0	222	0	
3	0	0	0	0	0.00	0	209	0	
4	0	0	0	0	0.00	0	217	0	
5	0	0	0	0	0.00	0	213	0	
6	0	0	0	0	0.00	0	214	0	
7	0	0	0	0	0.00	0	216	0	
8	0	0	0	0	0.00	0	220	0	
9	0	0	0	0	0.00	0	219	0	
10	0	0	0	0	0.00	0	219	0	
11	0	0	0	0	0.00	0	218	0	
12	0	0	0	0	0.00	0	436	0	
13	816	698	0	1	0.14	0	1086	0	
14	1459	1376	0	0	0.00	0	1857	0	
15	1068	2183	0	0	0.00	0	1976	0	
16	0	122	0	0	0.00	0	4674	0	
17	0	0	0	0	0.00	0	2705	0	
18	0	0	0	0	0.00	0	1849	0	
19	0	0	0	0	0.00	0	1750	0	
20	0	0	0	0	0.00	0	1522	0	

Refresh Close Help

To display the Network Statistics screen, refer to “Displaying the Network Statistics screen” on page 137. To obtain the definitions for the statistics presented on the Network Statistics screen, refer to “Network Statistics field descriptions” on page 138.

Displaying the Network Statistics screen

Choose Alarms/Stats/Logs → Network Statistics from the Menu Bar to display the Network Statistics screen.

Result: Configuration Manager gathers statistics from the Meridian Digital Telephone IP Adapter unit and displays the Network Statistics screen, similar to the example on page 136.

IF you want to**THEN click**

update the statistics with the latest information,

on the **Refresh** button.

create a text file containing these statistics,

on the **Save to File** button.

close the Trunk Connection Statistics screen,

on the **Close** button.

obtain descriptions of the statistics in the Trunk Connection Statistics screen,

on the **Help** button.

Network Statistics field descriptions

The following table describes the information on the Network Statistics screen:

Statistic	Description
Hour	Identifies the hour that the statistics on that line apply to. These numbers refer to the most recent 24 hours, such that “1” refers to one hour ago, “2” refers to two hours ago, and so on.
Tx Frames	Identifies the number of frames transmitted in the given hour.
Rx Frames	Identifies the number of frames received in the given hour.
Rx Error	Identifies the number of frames received in the given hour with an error.
Rx Dropped	Identifies the number of received frames that the Remote Office system dropped in the given hour.
Error %	Identifies the percentage of frames received in the given hour with an error.
BroadCast Packet	Identifies the number of packets broadcast, or sent to all addresses on the network, by this unit in the given hour.
Tx UCastPkt	Identifies the number of packets unicast, or sent to one specific address, by this unit in the given hour.
Tx DiscPkt	Identifies the number of packets discarded by this unit in the given hour.
Rx MultiPkt	Identifies the number of packets received by this unit that were sent to multiple addresses in the given hour.
Rx UCastPkt	Identifies the number of packets received by this unit that were sent only to this unit in the given hour.
Rx DiscPkt	Identifies the number of received packets that were discarded by this unit in the given hour.

Verifying the firmware and software version

This section describes how to determine the version of firmware and software currently installed.

Before you perform a firmware or software upgrade, you should determine what version is currently installed. This ensures that you do not replace the installed firmware or software with an older version.

Verifying the software version

To verify the software version on your Meridian Digital Telephone IP Adapter unit, complete the following procedure:

- 1 From the Menu Bar, choose Help → About Configuration Manager.

Result: The About Configuration Manager dialog box displays, similar to the following:

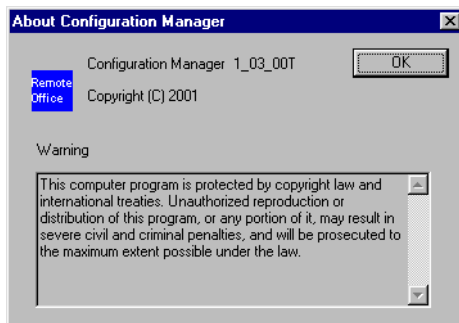

- 2 Review the About Configuration Manager dialog box. This identifies the version of software installed on the unit.
- 3 Click on the **OK** button.

Verifying the firmware version

To verify the firmware version on your Meridian Digital Telephone IP Adapter unit, complete the following procedure:

- 1 From the Menu Bar, choose System Information → System Data.
- 2 The System Configuration Details dialog box displays, similar to the following:

System Configuration Details

Unit Id	2	Site Name	UNIT
Unit Type	911X	Unit Version	1_03_001.7 911X
Database Version	1.20	Date	MAR-22-2001
		Time	16:26
IP Address	192.168.143.102	Mac Address	00:50:D7:00:12:04

Application Module Information

Successfully Read System Configuration Data

Close Help

- 3 Review the Unit Version box. This identifies the version of firmware installed on the unit.
- 4 Click on the **Close** button.

Determining the current firmware and software versions

To determine what the current firmware and software versions are, refer to the *Remote Office and RLC Release Notes* (NTP 555-8421-102).

Obtaining the latest upgrade file

If you need to upgrade the firmware or software, you can obtain the latest upgrade files by clicking on the Customer Support and Software Distribution links at the following website:

www.nortelnetworks.com

Nortel Networks provides upgrade files in self-extracting executable files. You must extract the upgrade files before you can perform the upgrade.

Types of upgrades

There are two types of upgrades that can be performed for your Meridian Digital Telephone IP Adapter unit:

1. Configuration Manager software upgrade

You use the Configuration Manager software to configure or administer the Meridian Digital Telephone IP Adapter unit.

2. Meridian Digital Telephone IP Adapter unit firmware upgrades

The firmware contains the code necessary for operating the Meridian Digital Telephone IP Adapter unit.

Downloading the upgrade file

To download the upgrade file, complete the following procedure:

- 1 With your web browser, connect to the Nortel Networks website at:
www.nortelnetworks.com/remoteoffice
- 2 Click Software and Documentation Distribution Center.
- 3 Locate the software and firmware you need.
- 4 Download the files into a temporary location on your PC.
- 5 Double-click on the **.exe** file to extract the files into a temporary location on your PC.
- 6 Continue with “Extracting upgrade files from the download file” on page 142.

Extracting upgrade files from the download file

Before you perform an upgrade, ensure you have obtained the latest upgrade files from your Nortel Networks distributor. The upgrade files are enclosed in self-extracting executable files. You must extract the upgrade files before you can perform the upgrade.

Performing the extraction using Windows

To perform the extraction using Windows, complete the following procedure:

- 1 Navigate to the directory that contains the .exe file you received from Nortel Networks.
- 2 Double-click on the .exe file.

Result: The WinZip Self-Extractor dialog box displays, similar to the following:

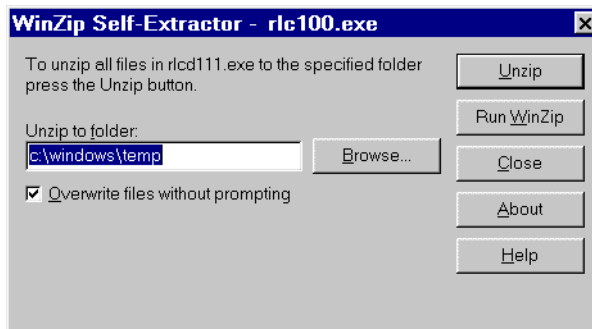

- 3 Review the information presented and make changes as necessary.

Notes:

- Nortel Networks recommends that you extract the files into a temporary directory.
- If you specify a directory that does not exist, the WinZip Self-Extractor creates it.

- 4 Click on the **Unzip** button.

Result: The file extraction begins. A status bar shows the extraction progress. When completed, an “unzipped successfully” message displays, similar to the following:

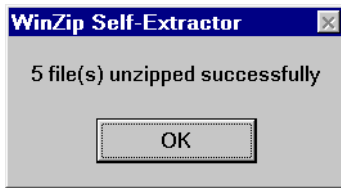

- 5 Click on the **OK** button.

Result: The WinZip Self-Extractor dialog box reappears.

- 6 Click on the **Close** button.

Performing a firmware upgrade

This section describes how to perform a firmware upgrade on your Meridian Digital Telephone IP Adapter unit. You perform the upgrade over the IP network using the TFTP protocol.

You must have a TFTP server application running on the administration PC. The TFTP server's base directory must point to the directory that contains the upgrade files.

When to perform a firmware upgrade

Perform a firmware upgrade if you have determined that you are using out-of-date firmware. For instructions on determining if you need to perform an upgrade, refer to “Verifying the firmware and software version” on page 139.

About firmware upgrades and configuration files

Each time you perform a firmware upgrade, the configuration database is also converted (if necessary) to a format that is compatible with the new firmware. Configuration settings are not affected by the conversion.

Nortel Networks recommends that, each time you perform a firmware upgrade, you create a backup copy of the converted configuration file, and store it in a safe secure location.

Before you begin

It is important to complete the procedures described under “Obtaining the latest upgrade file” on page 141 before performing a firmware upgrade. Then you must complete the following steps:

- 1 Start the TFTP server application.
- 2 Ensure the TFTP base directory reflects the directory where the firmware upgrade file you want to use resides.

Getting there 911x → Configuration Manager

Upgrading the Meridian Digital Telephone IP Adapter unit firmware

To upgrade the Meridian Digital Telephone IP Adapter unit firmware, complete the following procedure:

- 1 From the Menu Bar, choose Upload/Download → Upload S/W.

Result: The Software Upload dialog box displays, similar to the following:

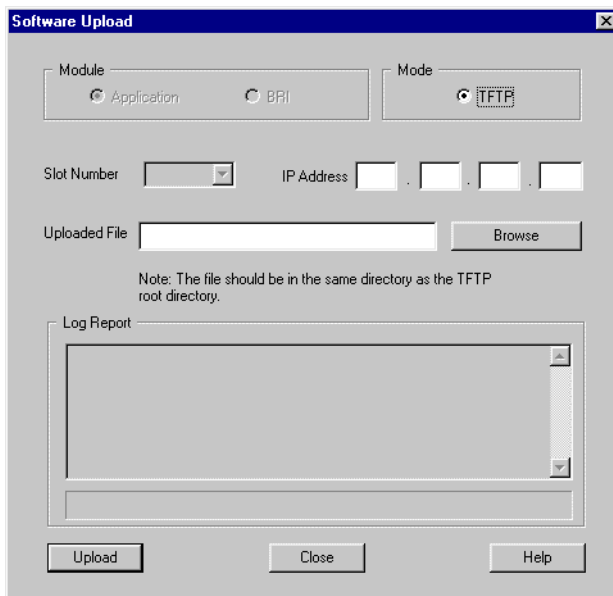

Note: In the Module section, the Application option button is the default selection.

- 2 Enter the IP address of the TFTP server into the IP Address fields.

Note: Since the TFTP server application is running on your administration PC, this is the IP address of the administration PC.

- 3 Click on the **Browse** button.

Result: The Open dialog box displays, similar to the following:

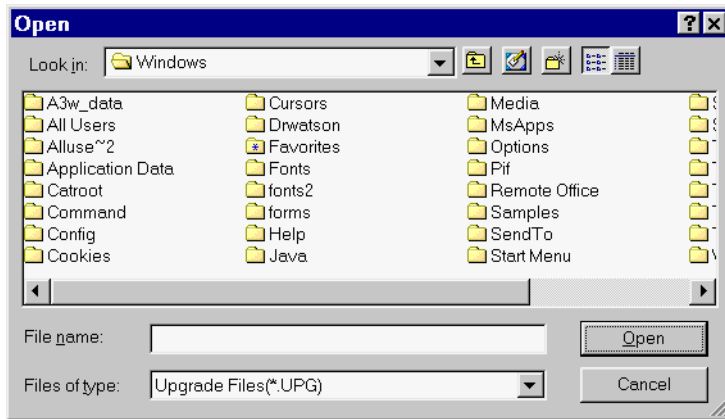

- 4 Ensure the Files of type drop down box shows Upgrade Files (*.UPG).
- 5 Navigate to the folder where the firmware file is located.
- 6 Select the file, and then click on the **Open** button.

Example: For Meridian Digital Telephone IP Adapter unit firmware, select 911X.upg, and click on the **Open** button.

Result: The Software Upload dialog box reappears. The file you selected is shown in the Uploaded File box.

- 7 Click on the **Upload** button.

Wait until the file uploads completely before entering any other commands. The Log Report window displays a confirmation message when the upgrade is completed.

Note: Configuration Manager prompts you to restart the Meridian Digital Telephone IP Adapter unit after upgrading the firmware. To do this, follow the procedure on page 147.

Restarting the system

After a firmware upgrade or a configuration change, it is often necessary to restart the Meridian Digital Telephone IP Adapter unit. Use the following procedure to restart the unit using Configuration Manager.

Note: After you restart the system, wait 7–10 seconds before placing a call.

Getting there 911x → Configuration Manager

To restart the unit

- 1 From the Menu Bar, choose Connect → System Reset → Restart.

Result: The System Restart dialog box displays, similar to the following:

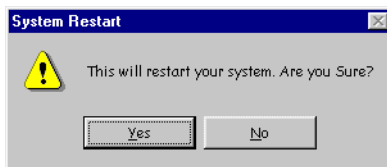

- 2 Click the **Yes** button.

Result: The Restarting the System. Please Wait.....progress bar displays indicating that Configuration Manager is restarting the system, similar to the following:



- 3 When the restart is complete, the system logs off the user.

Result: The Configuration Manager dialog box displays notifying you of the successful restart, similar to the following:

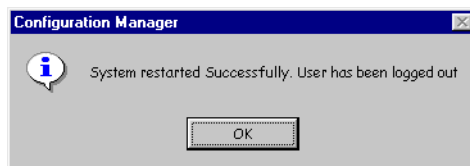

- 4 Configuration Manager then displays the User Authentication dialog box, so that you can resume Configuration Manager activities.

Performing a software upgrade

Perform a software upgrade if you have determined that you are using out-of-date software. For instructions on determining if you need to perform an upgrade, refer to “Verifying the firmware and software version” on page 139.

Upgrading the Configuration Manager software

To upgrade the Configuration Manager software, complete the following procedure:

- 1 Navigate to the directory that contains the upgrade files you extracted.
- 2 Double-click on the **setup.exe** file.
- 3 Follow the prompts on the screen.

ATTENTION

Do not ignore any warning messages that the InstallShield displays about versions of files (such as DLL files) that already exist on your PC. If you overwrite these files, you may inadvertently cause other applications on your PC to stop working.

Result: The InstallShield installs the software, overwriting the previous version.

Chapter 8

Troubleshooting

In this chapter

Before you begin	150
Meridian Digital Telephone IP Adapter unit LEDs	152
Digital telephone	153
Network connectivity	159
Software problems	162
Using Configuration Manager's PING	163
Recovering from a catastrophic failure	166
Repair and warranty information	167

Before you begin

The questions listed in this section can help you determine the proper course of action for addressing your problem.

Identifying why a problem occurred

If you experience problems in setting up or running your Meridian Digital Telephone IP Adapter unit, identify the problem first, using the table provided below.

Question	IF you answered	THEN do the following
Is this a new installation?	yes	1 Perform troubleshooting in the sequence presented in this chapter. 2 PING the unit to confirm that it is accessible on the network. Refer to “Using Configuration Manager’s PING,” on page 163.
	no	Answer the next question.
Did the Meridian Digital Telephone IP Adapter unit work, then suddenly stop working?	yes	Answer the next question.
	no	1 Perform troubleshooting in the sequence presented in this chapter. 2 PING the unit to confirm that it is accessible on the network. Refer to “Using Configuration Manager’s PING,” on page 163.

Question	IF you answered	THEN do the following
Did you modify the configuration or change any hardware components?	yes	<ol style="list-style-type: none">1 Verify that changes were completed correctly.2 Check the hardware components to ensure they are in working order.3 Perform troubleshooting for the specific component.
	no	Contact your telecom or data network administrator. There may be a problem with the network.

Meridian Digital Telephone IP Adapter unit LEDs

During the Meridian Digital Telephone IP Adapter unit power-up cycle, watch the front panel of the Meridian Digital Telephone External IP Adapter unit, or the rear panel of the digital telephone housing the Meridian Digital Telephone Internal IP Adapter circuit card. The LEDs should behave as follows:

- The Power LED should light up and remain lit.
- The remaining LEDs flash whenever there is network activity.

If the LEDs do not display correctly:

- Ensure that the Meridian Digital Telephone IP Adapter unit is connected to a power source.
- If you are using an uninterruptible power supply (UPS), ensure the UPS is powered on.
- Verify that the AC power source is operational.

Digital telephone

This section identifies some problems that can occur on the digital telephone, and describes what to do to resolve them.

Symptom descriptions

If you are having trouble with digital telephones, perform troubleshooting as described in the following tables, according to whether this is a first-time installation.

Symptom	What to do
There is no dial tone when pressing either the host calling or local calling keys and this is a first-time installation	<ol style="list-style-type: none">1 Ensure that the Meridian Digital Telephone IP Adapter unit completed its power-up cycle successfully. If it did, the Status LED remains lit.2 Verify the connections between the telephone network and the Meridian Digital Telephone IP Adapter unit.3 Use Configuration Manager to verify that the following configuration is correct on the Meridian Digital Telephone IP Adapter unit:<ul style="list-style-type: none">■ IP address■ subnet mask■ IP gateway■ RLC's IP address4 Verify the security IDs of both the Meridian Digital Telephone IP Adapter unit and the RLC, if a security ID is required to authenticate connection attempts.

Symptom	What to do
There is no dial tone when pressing either the host calling or local calling keys and this is a first-time installation. (continued)	<p data-bbox="623 220 1138 342">5 Use Configuration Manager to verify that the following configuration is correct on the Meridian Digital Telephone IP Adapter unit, as appropriate:</p> <ul data-bbox="667 362 1138 594" style="list-style-type: none"><li data-bbox="667 362 1138 594">■ station configuration, to ensure that the telephone you are using has the calling capabilities needed to complete the tests (that is, verify that the station is correctly configured as local only, remote only, or both local and remote) <p data-bbox="654 605 1138 735">Note: For instructions on using Configuration Manager, refer to Chapter 5, “Changing configuration settings using Configuration Manager”.</p> <p data-bbox="623 751 1138 813">6 Work with the administrator at the host PBX site to ensure the following:</p> <ul data-bbox="667 829 1138 1222" style="list-style-type: none"><li data-bbox="667 829 1138 927">■ The RLC is enabled and working in its PBX slot (restart the RLC, if necessary).<li data-bbox="667 943 1138 1073">■ The configuration of the IP address, telephone number, and security ID on the RLC port are correct (if these items are used).<li data-bbox="667 1089 1138 1222">■ Both the telecom and data networks are routing voice calls as expected (that is, calls are not being blocked in any way).

IF Symptom	THEN What to do
There is no dial tone when pressing either the host calling or local calling keys.	<ol style="list-style-type: none"> 1 Check the IP network to ensure the following: <ul style="list-style-type: none"> ■ The IP network is not down. ■ Traffic is being routed between the Meridian Digital Telephone IP Adapter unit and RLC on the host PBX. 2 Contact your telecom administrator. There might be problems at the host PBX.
Lamps or indicators are not lit after completion of a Meridian Digital Telephone IP Adapter unit power cycle.	<ol style="list-style-type: none"> 1 Check all cable connections to and from the Meridian Digital Telephone IP Adapter unit to ensure that they are all securely connected. 2 Check the IP network and ensure that: <ul style="list-style-type: none"> ■ it is not down ■ traffic is being routed between the Meridian Digital Telephone IP Adapter unit and RLC on the host PBX 3 PING the RLC from the Meridian Digital Telephone IP Adapter unit to verify IP network connectivity.
Lamps or indicators do not reflect the true status of the telephone.	It is possible that there is a synchronization error between the Meridian Digital Telephone IP Adapter unit and the host PBX. Contact your telecom network administrator.

IF Symptom	THEN What to do
The display is blank (that is, the time and date are not displayed).	<ol style="list-style-type: none"><li data-bbox="623 220 1134 407">1 Take the digital telephone handset off hook and dial the online SPRE code. The Meridian Digital Telephone IP Adapter unit attempts to connect to the host PBX. When the connection is established, the time and date appear.<li data-bbox="623 418 1134 638">2 Check the IP network and ensure that:<ul style="list-style-type: none"><li data-bbox="667 464 857 492">■ it is not down<li data-bbox="667 508 1098 638">■ traffic is being routed between the Meridian Digital Telephone IP Adapter unit and RLC on the host PBX<li data-bbox="623 651 1134 740">3 PING the RLC from the Meridian Digital Telephone IP Adapter unit to verify IP network connectivity.<li data-bbox="623 753 1134 842">4 Restart the RLC, wait one minute, and then restart the Meridian Digital Telephone IP Adapter unit.<li data-bbox="623 855 1134 915">5 Ensure that the RLC is enabled in its host PBX slot. In overlay 32 on the host PBX, check the status of the RLC, disable and enable it, or reseal it if necessary.<li data-bbox="623 1045 1134 1130">6 Contact your telecom administrator. There might be problems at the host PBX.

IF Symptom**THEN What to do**

There are noticeable gaps or poor quality when a voice call is active on the IP network.

Contact your network administrator to conduct a traffic study on your voice and IP network traffic patterns as described in the *Remote Office Network Engineering Guidelines* (NTP 555-8421-103). (This NTP is available from your Nortel Networks distributor.) It is possible that your IP network capacity cannot accommodate the additional voice data, especially during High Day Busy Hour (HDBH) periods. Make adjustments to your network as required.

Incoming calls are not being received from the host PBX.

- 1** Ensure your telephone is not on call forward.
- 2** Ensure that the Meridian Digital Telephone IP Adapter unit is not in offline mode by entering the online SPRE code at a digital telephone.
- 3** Ensure that the Meridian Digital Telephone IP Adapter unit is powered up. It cannot receive calls from the host PBX if it is not powered up.
- 4** The network administrator should ensure the RLC is correctly configured with your Meridian Digital Telephone IP Adapter unit's IP address, telephone number, and security ID (if they are used).

IF Symptom	THEN What to do
<p>Incoming calls are not being received from the host PBX. (continued)</p>	<ol style="list-style-type: none"> <li data-bbox="622 220 1141 505"> <p>5 The network administrator should check the IP network (if it is being used) and ensure that:</p> <ul style="list-style-type: none"> <li data-bbox="667 326 1141 367">■ it is not down <li data-bbox="667 370 1141 505">■ traffic is being routed between the Meridian Digital Telephone IP Adapter unit and RLC on the host PBX <li data-bbox="622 513 1141 643"> <p>6 The network administrator should PING the RLC from the Meridian Digital Telephone IP Adapter unit to verify IP network connectivity.</p> <li data-bbox="622 651 1141 756"> <p>7 If the problem persists, contact your telecom administrator or Nortel Networks distributor.</p>
<p>A call in progress was suddenly disconnected.</p>	<ol style="list-style-type: none"> <li data-bbox="622 773 1141 870"> <p>1 Does your telephone display "Offline Mode?" If so, enter the online SPRE code to go back online.</p> <li data-bbox="622 878 1141 967"> <p>2 Contact your telecom and data network administrators. Perhaps network problems caused the call to disconnect.</p>

Network connectivity

This section identifies some problems that can occur on the data network, and describes what to do to resolve them.

System descriptions

If you are not able to establish or maintain data network connectivity, perform troubleshooting as described in the following table:

Symptom	What to do
You cannot establish a connection from your administration PC to the Meridian Digital Telephone IP Adapter unit.	<ol style="list-style-type: none"> <li data-bbox="623 613 1134 703">1 Ensure that you entered the IP address correctly when trying to establish the connection. <li data-bbox="623 716 1134 805">2 Ensure that you entered the logon ID and password correctly when trying to establish the connection. <li data-bbox="623 818 1134 972">3 Ensure the Meridian Digital Telephone IP Adapter unit's IP address, network mask, and default gateway are correctly configured in the Meridian Digital Telephone IP Adapter unit. <li data-bbox="623 985 1134 1140">4 PING the Meridian Digital Telephone IP Adapter unit to see if it responds. Refer to "Using Configuration Manager's PING," on page 163 for proper procedure. <li data-bbox="623 1153 1134 1177">5 PING the gateway to see if it responds. <li data-bbox="623 1190 1134 1252">6 If the PING still does not work, contact your data network administrator.

Symptom	What to do
10060 TELNET CONNECTION FAILED appears when attempting to connect to the Meridian Digital Telephone IP Adapter unit.	<p data-bbox="623 224 1134 280">The Meridian Digital Telephone IP Adapter unit cannot be reached on the IP network.</p> <ol data-bbox="623 302 1134 945" style="list-style-type: none"><li data-bbox="623 302 1134 423">1 Check the configuration of network devices and ensure that Meridian Digital Telephone IP Adapter unit can be reached.<li data-bbox="623 435 1134 557">2 Verify that the Ethernet cable is connected at both ends (Meridian Digital Telephone IP Adapter unit and Internet Access Device).<li data-bbox="623 568 1134 625">3 Check the Ethernet cable and ensure it is good.<li data-bbox="623 636 1134 693">4 Ensure the Meridian Digital Telephone IP Adapter unit is powered up.<li data-bbox="623 704 1134 761">5 Power the Meridian Digital Telephone IP Adapter unit off, then back on.<li data-bbox="623 773 1134 829">6 PING the Meridian Digital Telephone IP Adapter unit.<li data-bbox="623 841 1134 945">7 Contact your Nortel Networks distributor. There may be a hardware problem.

Symptom	What to do
The Meridian Digital Telephone IP Adapter unit does not send or receive Ethernet traffic.	<ol style="list-style-type: none"><li data-bbox="623 220 1138 375">1 Ensure the Meridian Digital Telephone IP Adapter unit is powered up. The Meridian Digital Telephone IP Adapter unit cannot send or receive traffic if it is not powered up.<li data-bbox="623 386 1138 508">2 Check the Ethernet cable between the Meridian Digital Telephone IP Adapter unit and the network and ensure it is good.<li data-bbox="623 519 1138 547">3 Ensure the Ethernet cable is connected.<li data-bbox="623 558 1138 680">4 If the Meridian Digital Telephone IP Adapter unit still does not send or receive traffic, contact your data network administrator.<li data-bbox="623 691 1138 818">5 Data network administrator: Ensure other network devices are configured to allow traffic to and from the Meridian Digital Telephone IP Adapter unit.
An attempt to log out from the Meridian Digital Telephone IP Adapter unit does not work.	<p data-bbox="623 850 1138 943">It is possible that communication has been lost between the administration PC and the Meridian Digital Telephone IP Adapter unit.</p> <p data-bbox="623 959 1138 1024">Close the Configuration Manager, then restart it.</p>

Software problems

This section identifies some problems that can occur with the Configuration Manager software, and describes what to do to resolve them.

Symptom descriptions

If you are not able to complete a task with the Configuration Manager, perform troubleshooting as described in the following table.

Symptom	What to do
10060 TELNET CONNECTION FAILED appears when attempting to connect to the Meridian Digital Telephone IP Adapter unit.	It is possible that communication has been lost between the administration PC and the Meridian Digital Telephone IP Adapter unit. Close the Configuration Manager, then restart it.
The Meridian Digital Telephone IP Adapter unit does not send or receive Ethernet traffic.	It is possible that communication has been lost between the administration PC and the node you were logged on to. Close the Configuration Manager, then restart it.

Display Logs definitions

You can locate Display Logs definitions in Configuration Manager Help.

Using Configuration Manager's PING

PING, or Packet InterNet Groper, is a protocol and program to test that a device is accessible on a network. This section explains how to use the PING option provided in the Configuration Manager to verify network connectivity. Use this test as a troubleshooting tool to determine if you can reach the RLC, another remote unit, or any other device on the network.

Getting there 911x → Configuration Manager

Performing a Configuration Manager PING

To perform a Configuration Manager PING, complete the following procedure:

- 1 From the Menu Bar, choose Tests → PING.

Result: The PING Test dialog box displays, similar to the following:

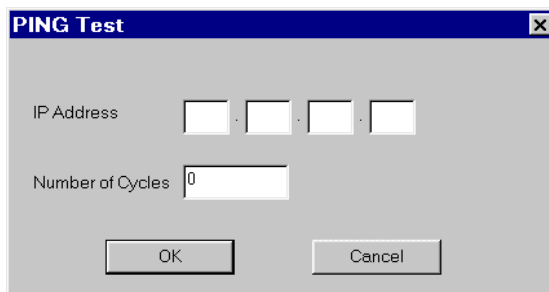

- 2 Enter the IP Address of the unit you want to PING in the IP Address field.
- 3 Enter the number of times you want to PING the unit in the Number of Cycles field (1 to 100).

- 4 Click on the **OK** button.

Result: The PING test window displays, showing the PING results. The following is an example of a successful PING.

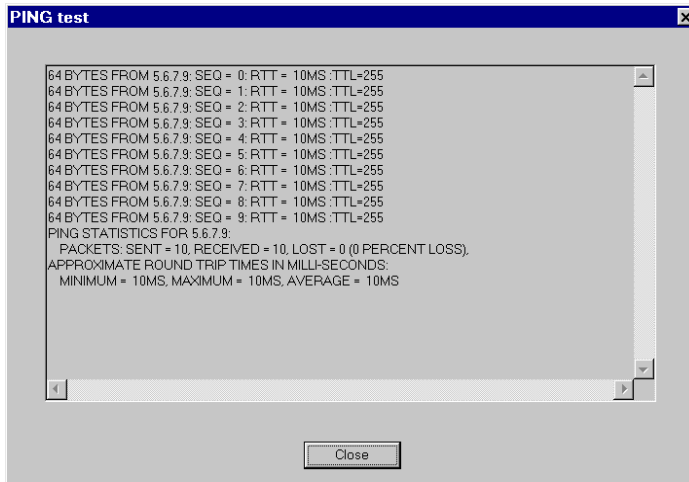

The following is an example of an unsuccessful PING.

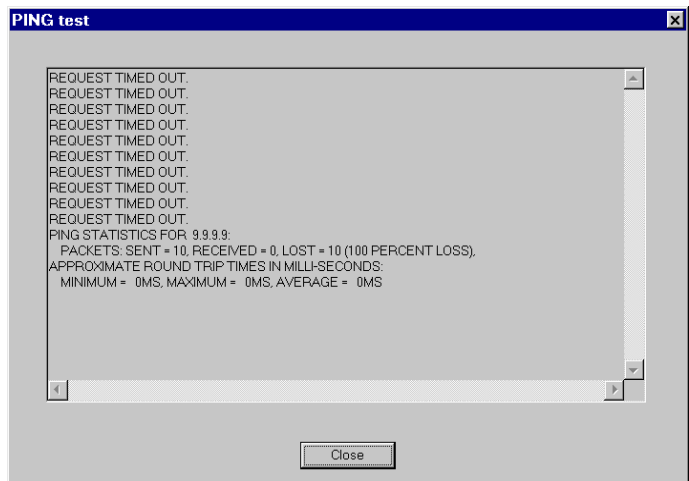

- 5 Click on the **Close** button.

Result: The PING test window closes.

Unsuccessful PING options

If the PING was unsuccessful, answer these questions:

- 1 Did you enter the IP address correctly?
- 2 Are the subnet mask and default gateway configured properly at your site? (Confirm this by checking the IP Configuration property sheets for the involved units.)
- 3 Are the subnet mask and default gateway configured properly at the site that you are PINGing? (Confirm with the site's network administrator.)
- 4 Does the gateway respond to a PING?

If you are able to answer “Yes” to the questions above and the PING still does not work, the problem lies somewhere in the network between the involved sites.

Recovering from a catastrophic failure

Catastrophic failure is defined as a failure of the equipment to operate after review of all troubleshooting information and implementation of appropriate procedures.

Should your Meridian Digital Telephone IP Adapter unit fail to operate after thorough review of the troubleshooting information in this and related Guides, consult your Nortel Networks distributor for hardware replacement.

Repair and warranty information

The Meridian Digital Telephone IP Adapter unit contains no user-serviceable components. If the problem experienced with your Meridian Digital Telephone IP Adapter unit persists after you have used all the appropriate procedures in this chapter, refer to the following contact information for repair and warranty help, depending upon your location:

Canada

Nortel Networks Service Selection Center
30 Norelco Drive
Weston, ON
M9L 2X6
Canada

Telephone: 1-888-977-9444

United States

Nortel Networks
Product Service Center
640 Massman Drive
Nashville, TN 37210
USA

Telephone: 1-800-251-1758

Europe

Nortel Networks (NI) Ltd.
FAO: Irish Express Cargo (IEC)
Raheen Industrial Estate
Raheen, Limerick
Ireland

Telephone: +33 4 9296 1568

Fax: +33 4 9296 1598

Asia/Pacific

Nortel Distribution Center
c/o ACCO Transport
21 South St. Unit#2
Rydalmere, NSW
2116 Australia

CALA

Note: When you need warranty and repair service in Central American and Latin American countries, you must first get an RR (repair and return) number from your Nortel Networks distributor before shipping to the Nortel CALA Repair Center.

Nortel c/o Wesbell
4019 S.W. 30th Avenue
Fort Lauderdale, FL 33312
USA
Notify: Receiving Department
RR no.:

Telephone:

Normal Service Hours (Monday to Friday 8:00 a.m. to 5:00 p.m. Central Time)

1-954-851-8841

After Normal Hours (weekends and holidays)

1-888-594-8474

Appendix A

Planning forms

In this appendix

IP Adapter Network Connections	170
IP Adapter Configuration Information—Dialing Plans	171
IP Adapter telephone menu— Configuration Values	172

Note: You can locate electronic Remote Office Planning forms on the Nortel Networks website at:

www.nortelnetworks.com

IP Adapter Network Connections

Security level:	<input type="checkbox"/> No security <input type="checkbox"/> Provisioned security				
Meridian Digital Telephone IP Adapter site identification					
Node number: _____	Node name: _____				
IP address:	<table border="1" style="width: 100%; height: 20px; border-collapse: collapse;"> <tr> <td style="width: 25%;"></td> <td style="width: 25%;"></td> <td style="width: 25%;"></td> <td style="width: 25%;"></td> </tr> </table>				
Subnet mask:	<table border="1" style="width: 100%; height: 20px; border-collapse: collapse;"> <tr> <td style="width: 25%;"></td> <td style="width: 25%;"></td> <td style="width: 25%;"></td> <td style="width: 25%;"></td> </tr> </table>				
Default gateway:	<table border="1" style="width: 100%; height: 20px; border-collapse: collapse;"> <tr> <td style="width: 25%;"></td> <td style="width: 25%;"></td> <td style="width: 25%;"></td> <td style="width: 25%;"></td> </tr> </table>				
If the security level is <i>provisioned security</i> , what is the Meridian Digital Telephone IP Adapter unit's security identifier?					
	Inbound _____ Outbound _____				
Connection to RLC information					
IP address to reach the host PBX (for IP network):					
<table border="1" style="width: 100%; height: 20px; border-collapse: collapse;"> <tr> <td style="width: 25%;"></td> <td style="width: 25%;"></td> <td style="width: 25%;"></td> <td style="width: 25%;"></td> </tr> </table>					
If security level is <i>provisioned security</i> , what is the RLC's security code?	Inbound _____ Outbound _____				

IP Adapter Configuration Information—Dialing Plans

Notes:

- The pound sign (#) is mandatory and is automatically preconfigured in Configuration Manager. The pound sign prevents conflicts with the dialing plan on the host PBX.

Description	Default code	Your code (maximum of 3 digits)
Online SPRE code	#99	#
Offline SPRE code	#98	#
Registration SPRE code (for multi-user or dynamic pool ports only)	#97	#
Deregistration SPRE code (for multi-user or dynamic pool ports only)	#96	#

IP Adapter telephone menu— Configuration Values

Use the values shown below to configure the Meridian Digital Telephone IP Adapter unit using the telephone menu.

Configuration Value Description	Value
User Name	GUEST (48378)
Password	_____
Unit ID (Meridian Digital Telephone IP Adapter unit)	_____
Time Offset	_____
Emergency Code	_____
Online SPRE Code	_____
Offline SPRE Code	_____
Registration SPRE Code	_____
Deregistration SPRE Code	_____
Enable DHCP	Y / N (circle one)
IP Address	_____
IP Subnet Mask	_____
IP Gateway	_____
Enable Diffserve	Y / N (circle one)
Enable 802.1p Mapping	Y / N (circle one)
Port # (RLC)	_____

Configuration Value Description	Value
Security Level (RLC)	_____
Enable IP (Voice over IP)	Y / N (circle one)
RLC IP Address	_____
IP Signaling	_____
Modem Tones	_____
Set Type	_____

Appendix B

Connection pin-out tables

In this appendix

RJ-45 ethernet connector	176
Admin (serial) connector pin-out table	177
Power connector pin-out table	178

RJ-45 ethernet connector

Pin #	Signal
1	RX+
2	RX-
3	TX+
4	NC
5	NC
6	TX-
7	NC
8	NC

Admin (serial) connector pin-out table

Pin number	Signal name	I/O	Description
1			
2	MMI-RXD	I	MMI RS-232C Receive Data
3	MMI-TXD	O	MMI RS-232C Transmit Data
4			
5	Ground	I	Logic Ground
6			
7			
8			
9			

Power connector pin-out table

Pin number	Signal name	I/O	Current	Description
1	Ground	I		Logic Ground
2	+24VAC	I	1.5 A	+24VAC

Appendix C

Equipment attachment notices

In this appendix

Industry Canada

180

Industry Canada

NOTICE: The Industry Canada label identifies certified equipment. This certification means only that the equipment meets telecommunications network protective, operational, and safety requirements as prescribed in the appropriate Terminal Equipment Technical Requirements document(s). The Department does not guarantee that the equipment operates to the user's satisfaction.

Before installing this equipment, users should ensure that it is permissible to be connected to the facilities of the local telephone company. The equipment must also be installed using an acceptable method of connection. The customer should be aware that compliance with the above conditions may not prevent degradation of service in some situations.

Repairs to certified equipment should be coordinated by a representative designated by the supplier. Any repairs or alterations made by the user to this equipment, or equipment malfunctions may give the telecommunications company cause to request the user to disconnect the equipment.

Users should ensure for their own protection that the electrical ground connections of the power utility, telephone lines, and internal metallic water pipe system, if present, are connected. This precaution may be particularly important in rural areas.

Caution: Users should not attempt to make such connections themselves, but should contact the appropriate electric inspection authority, or electrician, as appropriate.

Appendix D

Safety and regulatory information

In this appendix

International safety compliance	182
Electromagnetic compatibility	183
Electromagnetic immunity	184
Electrostatic discharge	185
FCC requirements	186

International safety compliance

The Meridian Digital Telephone IP Adapter unit and the Remote Office system comply with international safety regulations as listed on this page.

Underwriters Laboratory (UL)

The Meridian Digital Telephone IP Adapter unit complies with and is listed under UL 1950, Third Edition, including revisions based on the Fourth Amendment to IEC 950, Second Edition.

Canadian Standards Association (CSA)

The Meridian Digital Telephone IP Adapter unit complies with and is listed under CSA C22.2, No. 950-95.

Europe

The Meridian Digital Telephone IP Adapter unit complies with and is listed under EN60950: 1992, incorporating amendments 1, 2, 3, 4 & 11.

Australia

The Meridian Digital Telephone IP Adapter unit complies with and is listed under TS001\AS 3260.

Other Countries Deviations Assessed

Refer to Nemko Test Report # 2000 29173.

Electromagnetic compatibility

The Meridian Digital Telephone IP Adapter unit does not interfere with operation of other licensed communications systems according to the standards set forth by Australia, the United States, and Canada.

The Meridian Digital Telephone IP Adapter unit does not adversely effect the compliance of the Meridian 1 system to:

- AS 3548 Class B (Australia)
- Class A of FCC Part 15, Subpart J
- CSPR B requirements.

The margin is at least 2 dB better than the specified limit.

Electromagnetic immunity

The Meridian Digital Telephone IP Adapter unit resists electromagnetic interference.

The Meridian Digital Telephone IP Adapter unit performs correctly when subjected to narrow band radiated fields in frequency range 500 kHz to 1 GHz (field strength up to 10 V/m, 1 kHz, 50% modulated AM signal) per IEC 1000-4-3.

Electrostatic discharge

The Meridian Digital Telephone IP Adapter unit is immune to electrostatic discharges typical for an office environment (carpeted floors, low humidity) according to the test method specified by IEC 1000-4-2.

No damage or malfunction occurs when the Meridian Digital Telephone IP Adapter unit is exposed to up to +/-8kV of direct discharge. An indirect discharge of up to +/-16 kV does not result in malfunction of the system (to adjacent equipment or connected cabling).

The requirements for both “closed door” and “open door” have been met.

FCC requirements

Information in the following paragraphs pertains to FCC-required information. These paragraphs describe where to locate details concerning the Meridian Digital Telephone IP Adapter unit's compliance to FCC regulations, as well as these regulations' effects on the use of the Meridian Digital Telephone IP Adapter unit.

Part 68

The Meridian Digital Telephone IP Adapter units comply with Part 68 of the FCC rules. A label on the underside of the enclosure contains, among other information, the FCC certification number and ringer equivalence number (REN) for the Meridian Digital Telephone IP Adapter unit. If requested, you must provide this information to the telephone company.

Class B

This equipment passes tests for compliance with the limits for a Class B digital device, pursuant to part 15 of the FCC Rules. These limits provide reasonable protection against harmful interference in a residential installation. This equipment generates, uses, and can radiate radio frequency energy. If not installed and used in accordance with the instructions, this equipment can cause harmful interference to radio communications. However, there is no guarantee against interference in a particular installation. You can determine whether this equipment causes harmful interference to radio or television reception by turning the equipment off and on. The user can try to correct the interference by one or more of the following measures:

- Reorient or relocate the receiving antenna.
- Increase the separation between the equipment and the receiver.
- Connect the equipment to an outlet on a circuit different from the outlet that the receiver connects to when producing the interference.
- Consult your Nortel Networks dealer or an experienced radio/TV technician for help.

Note: Changes or modifications not expressly approved by Nortel Networks can void your right to operate Meridian Digital Telephone IP Adapter unit equipment.

Telephone network plug and jack

The Meridian Digital Telephone IP Adapter unit's package contains an FCC-compliant telephone cord and modular plug. The Meridian Digital Telephone IP Adapter unit's design calls for it to be connected to the telephone network or premises wiring using a Part 68-compliant modular jack. Refer to Chapter 3, "Installing the Meridian Digital Telephone IP Adapter unit," for complete details on proper installation of the Meridian Digital Telephone IP Adapter unit.

Equipment harmful to the telephone network

If the Meridian Digital Telephone IP Adapter unit causes harm to the telephone network, the telephone company notifies the customer in advance that temporary discontinuance of service may be required. But, if advance notice isn't practical, the telephone company notifies the customer as soon as possible. The customer also receives notification of their right to file a complaint with the FCC if the customer believes a complaint is necessary.

Party lines

Connection to party line service is subject to state tariffs. Contact the state public utility commission for information.

Glossary

10BaseT Ethernet

The Ethernet standard for baseband local area networks using twisted-pair cable carrying 10 megabits per second (Mbps) in a star topology.

A

A-law

A companding technique used in encoding and decoding audio signals in 30-channel pulse code modulated (PCM) systems. A-law companding is the primary method used in Europe. *See also* Mu-law.

adapter

Hardware required to support a particular device. For example, network adapters provide a port for the network wire. Adapters can be expansion boards or part of the computer's main circuitry.

administrator

A user who is responsible for maintaining the RLC or its associated remote units.

agent

A person who is responsible for handling customer calls.

analog

The type of signal used by most telephone connections. A modem converts a digital (computer) signal to analog, and vice versa, so that the signal can travel through telephone lines.

API

See application program interface.

application

A program that runs on a computer.

application program interface

A set of routines, protocols, and tools that programmers use to develop software applications. APIs simplify the development process by providing commonly used programming procedures.

Asynchronous Transfer Mode

A network technology that uses start bits and stop bits (identifying the beginning and end of digital code) to facilitate data transfer. ATM equipment can transmit video, audio, and computer data over the same network, ensuring that no single type of data dominates the line.

ATM

See Asynchronous Transfer Mode.

Automatic Call Distribution (ACD) applications

A separate system or built-in feature of a PBX that equally distributes incoming calls to agents. As calls come in, they are placed into a queue (or a waiting line) for the next available agent. The RLC and its associated remote units support all of Nortel Networks' ACD applications.

B**bandwidth**

The amount of data that the network can transmit, usually expressed in Mbytes per second.

baseboard

See motherboard.

Basic Input/Output System

Flash ROM-based code that runs the Power-On Self-Test (POST) and bootstrap loader. BIOS contains low-level access routines for hardware that can be called from DOS.

basic rate interface

An ISDN subscriber service that uses two B (64Kbps) channels and one D (64 Kbps) channel to transmit voice, video, and data signals.

BIOS

See Basic Input/Output System.

bit

Short for binary digit, the smallest unit of information on a machine. A single bit can hold only one of two values: 0 or 1.

Boolean logic

A logic system that enables a computer to use electricity to make complex decisions. The basic logic gates (And, Or, and Not) determine the flow of electricity through the computer's circuitry and whether specific computing functions are carried out.

boolean

A value that can only be true or false.

branch station

A Meridian Digital Telephone set located at the Remote Office 9110, 9115, or 9150 site.

BRI

See basic rate interface.

bridge

A protocol-independent device that connects two LANs or two segments of the same LAN. Bridges are faster (and less versatile) than routers because they forward packets without analyzing and rerouting messages.

bridge port

Bridge ports are configured on the Remote Office 9150 unit and are used to connect branch office trunks through the host PBX to accommodate conference calls, remote station to remote station calls, and so on.

bus

A collection of wires that connects the microprocessor and main memory to internal computer components. All buses consist of an address bus that transfers data and a data bus that transfers information about where the data should go.

In a network, the bus (also called the backbone) is the main cable that connects all devices on a LAN.

byte

Abbreviation for binary term, a unit of storage capable of holding a single character. On almost all modern computers, a byte is equal to eight bits. Large amounts of memory are indicated in terms of kilobytes (1024 bytes), megabytes (1 048 576 bytes), and gigabytes (1 073 741 824 bytes).

C**cache**

A temporary storage area in computer memory.

call on demand

A call connection that is opened only when a connection to the host PBX is required. This is different from a permanent connection, that is open all the time.

call treatment

A method of handling applied to a call while it is waiting to be answered or serviced.

caller ID

Caller ID is used on the RLC to identify the number of the caller requesting access to one of its ports. It is also used on remote units to authenticate incoming calls from the RLC.

calling line identification

An optional service that identifies the telephone number of the caller. This information can then be used to route the call to the appropriate agent or skillset. The caller's telephone number can also be displayed on a phoneset.

card

A thin, rectangular plate that chips and other electronic components are placed on. Examples of cards include motherboards, expansion boards, daughterboards, controller boards, network interface cards, and video adapters.

central processing unit

This is the system unit that holds a PC's essential components.

CBT

See computer-based training.

CD-ROM

A type of optical disk capable of storing large amounts of data (up to 1 Gbyte), although the most common size is 630 Mbytes. A single CD-ROM has the storage capacity of 700 floppy disks and is particularly well-suited to information that requires large storage capacity.

chip

The small flake of silicon crystal that makes up the microprocessor. 2. A type of controller.

CLAN

See customer local area network.

CLID

See calling line identification.

client

The part of a client/server architecture that runs on a personal computer or workstation and relies on a server to perform some operations. For example, an e-mail client is an application that enables you to send and receive e-mail.

COD

See call on demand.

codec

An acronym for COder-DECoder. A device that codes analog signals into digital signals for transmission and decodes digital signals into analog signals for receiving.

COM or COMM

Communications port. This usually refers to the Logical Device name of PC serial ports as defined by DOS.

computer-based training

A type of education that students learn by running special training programs on a computer. CBT is especially effective for training people to use computer applications, because the CBT program can be integrated with the applications.

Configuration Manager

The software application used to configure and administer remote units and the RLC port that they are connected to.

controller board

A special type of expansion board that contains a controller for a peripheral device. When you attach new devices to a computer, such as a disk drive, often a controller board must also be added.

CPU

See central processing unit.

CPU clock

The clock that regulates the execution of instructions inside a computer. *See also* real-time clock.

crash

A serious computer failure whereby the computer stops working or a program closes unexpectedly. A crash indicates a hardware malfunction or a serious software bug.

customer local area network

The LAN that your corporate services and resources connect to. The RLC and its associated remote units both connect to the CLAN.

D**daughterboard**

Usually used as a synonym for an expansion board, a daughterboard is any printed circuit board that connects directly or indirectly to a motherboard.

DB9 connector

A 9-pin connector labeled ADMIN that provides the RS-232 serial port interface. This serial port connection can be used to configure a Remote Office 9150 unit that is directly connected to a PC.

DB25 connector

The DB25 connector on the RLC Multi-I/O cable–Enhanced is for future use.

DC

See direct current.

DHCP

See dynamic host configuration protocol.

digital linear tape

A high-capacity 1/2-inch streaming tape cartridge format.

digital signal processor

A special type of coprocessor that manipulates analog data, such as sound or photographs, that has been converted to digital form.

DIMM

See dual in-line memory module.

direct current

DC, the electrical power used by computers, comes from a single source (such as a battery) that provides a single voltage that stays at a constant level. AC, the power provided by utility companies, must be converted to DC before it can be used in computer systems.

directory number

The number that identifies a phoneset on a switch. The directory number (DN) could be a local extension (local DN), a public network telephone number, or an automatic call distribution directory number (ACD-DN).

DIP

A type of protective packaging for silicon memory chips that provides a safe and convenient means of installing and removing the chip.

DIP switch

A series of tiny switches built into circuit boards that enables you to configure a circuit board for a particular type of computer or application. DIP switches are always toggle switches. This means that they have two possible positions: on or off (or 1 or 0).

direct memory access

DMA speeds up system performance by moving blocks of memory around inside the computer (typically between I/O devices and memory). This process enables the microprocessor to spend its time performing other functions.

DLL

See dynamic link library.

DLT

See digital linear tape.

DMA

See direct memory access.

DN

See directory number.

driver

A program that controls a device. Every device, whether it is a printer, disk drive, or keyboard, must have a driver program. A driver acts like a translator between the device and programs that use the device.

DSP

See digital signal processor.

dual in-line memory module

The protective packaging for microprocessor chips that provides a safe and convenient means of installing and removing the chip.

dynamic host configuration protocol

A protocol for dynamically assigning IP addresses to devices on a network.

dynamic link library

A library of executable functions or data that can be used by a Windows application. Typically, a DLL provides one or more particular functions and a program accesses the functions by creating either a static or dynamic link to the DLL. A DLL can be used by several applications at the same time.

dynamic port pool

A RLC feature that is similar to multiuser ports in that multiple stations can share ports on the RLC. However, users sharing ports from a dynamic pool are assigned to the first available port on the RLC.

E**ECC**

See error correction code.

ECP

See extended capabilities port.

EEPROM

See electronically erasable programmable read-only media.

EIDE

See enhanced IDE.

EISA

See extended industry standard architecture bus.

ELAN

See embedded local area network.

electronically erasable programmable read-only media

A memory chip that needs only a higher than normal voltage and current to erase its contents. An EEPROM chip can be erased and reprogrammed without taking it out of its socket. An EEPROM chip gives a computer and its peripherals a means of storing data without the need for a constant supply of electricity.

electrostatic discharge

Discharge of a static charge on a surface or body through a conductive path to ground. Can be damaging to integrated circuits.

embedded local area network

This is the network connection from the host PBX to the RLC. It is an Ethernet LAN that is segmented from the rest of the Ethernet network and enables signaling and administration access to the RLC. Nortel Networks recommends the following:

- IP traffic should not be routed between the main network and the ELAN.
- An IP route should not be established between the two LANs.

Emergency Service Number

The Remote Office 9150 unit allows you to program an emergency service number (such as 911).

EMI

Electro-magnetic interference. Interference in signal transmission or reception caused by the radiation of electrical and magnetic fields.

enhanced IDE

An IDE hard disk interface enhanced with hardware and firmware changes to support disks larger than 540 Mbytes, four disks instead of two, and faster transfer rates. *See also* IDE.

enhanced parallel port

A parallel port standard for PCs that supports bidirectional communication between the PC and attached devices (such as a printer).

EPP

See enhanced parallel port.

error correction code

A scheme that can detect and fix single-bit memory errors without crashing the system. Also known as Error Detection and Correction (EDAC).

ESD

See electrostatic discharge.

Ethernet

A widely used LAN protocol that uses a bus topology and supports data transfer rates of 10 Mbps.

event

An occurrence or action on the RLC or remote unit, such as the sending or receiving of a message, the opening or closing of an application, or the reporting of an error. Some events are for information only, while others can indicate a problem.

expansion board

Any board that plugs in to one of the computer's expansion slots. Expansion boards include controller boards, LAN cards, and video adapters.

expansion bus

Enables expansion boards to access the microprocessor and memory. *See also* bus.

expression

A building block of a script, used to test for conditions, perform calculations, or compare values within scripts. *See also* logical expression, mathematical expressions, and relational expression.

extended capabilities port

A parallel-port standard for PCs that supports bidirectional communication between the PC and attached devices (such as a printer).

extended industry standard architecture bus

A 32-bit bus that accommodates ISA PC boards.

F**first-level threshold**

The value that represents the lowest value of the normal range for a given field in a threshold class. The system tracks how often the value for the field falls below this value.

G

G.711

G.711 is the international standard for encoding telephone audio on a 64 Kbps channel. It is a pulse code modulation (PCM) scheme operating at an 8 kHz sample rate, with 8 bits per sample. According to the Nyquist theorem, that states that a signal must be sampled at twice its highest frequency component, G.711 can encode frequencies between 0 and 4 kHz. Telcos can select between two different variants of G.711: A-law and μ -law. A-law is the standard for international circuits.

G.726

G.726 is a standard ADPCM algorithm specified by the International Telecommunication Union (ITU) for reducing the 64 kbps A-Law or μ -law logarithmic data of a normal telephone line to 16, 24, 32, or 40 kbps.

G.729

G.729 is a voice compression International Telecommunications Union (ITU) standard that can be used in a wide range of applications including wireless communications, digital satellite systems, packetized speech, and digital leased lines. G.729 provides 8 Kbps bandwidth for compressed speech at toll quality (equivalent to G.726 32 Kbps ADPCM under clean channel condition).

gateway

A device that functions as a node on two or more networks, forwarding packets from one network to addresses in the other networks. In a Remote Office context, the gateway is the device on the network that directs traffic to and from the Remote Office 9150 unit or RLC.

Gbyte

See gigabyte.

general protection fault

A computer condition that causes a Windows application to crash. GPFs usually occur when one application attempts to use memory assigned to another application.

gigabyte

1 073 741 824 bytes. One Gbyte is equal to 1024 Mbytes.

GPCP

General purpose computing platform

GPF

See general protection fault.

graphical user interface

The information displayed on the monitor when a Windows application (or another non-command-based application) runs. A graphical user interface uses features such as pointers, icons, I-beams, and menus to make the program easier to use.

GUI

See graphical user interface.

H**handshaking**

A process involved in establishing a valid connection or signal between two pieces of hardware or communications software.

host call appearance key

An assigned key on the telephone set at the remote site that is used to establish a connection with the host PBX or to receive incoming calls from the host PBX.

host-controlled call mode

When a call is placed to someone at the host site, or when someone from the host site calls the remote site, the call is in host-controlled call mode. Calls in host-controlled mode are routed through the host PBX.

host station

A telephone set located at the host PBX site.

hub

A common connection point for all 10BaseT cables connected to a small network. A hub enables data to go from one device to another.

icon

A small picture that represents an object or program in a graphical user interface.

IDE

Commonly used to describe the AT attachment design, the dominant hard disk interface. IDE is a cost-effective interface technology for mass storage devices that the controller is integrated into the disk or CD-ROM drive in.

idle timer

Identifies the maximum length of time that an ISDN connection should remain idle before it can be closed. Idle means that a voice connection does not exist, and buttons are not being pressed on the digital telephone.

Industry Standard Architecture

A 16-bit standard interface for add-in cards.

input/output

Refers to any operation, program, or device that enters data into a computer or extracts data from a computer.

integrated services digital network

A worldwide digital communication protocol that permits telephone networks to carry data, voice, and other source material. There are two kinds of ISDN lines—Primary Rate Interface (PRI) and Basic Rate Interface (BRI). *See also* BRI.

internet protocol

The protocol within TCP/IP that governs the breakup of data messages into packets, the routing of the packets from sender to destination network, and the reassembly of the packets into the original data messages at the destination.

I/O

See input/output.

IP

See internet protocol.

IP address

Internet Protocol address. An identifier for a computer or device on a TCP/IP network. Networks use the TCP/IP protocol to route messages based on the IP address of the destination. The format of an IP address is a 32-bit numeric address written as four numbers separated by periods. Each number can be 0–255. For example, 1.160.10.240 could be an IP address.

IPX

Internetwork Packet Exchange. A networking protocol used by the Novell NetWare operating systems.

ISA

See Industry Standard Architecture.

ISDN

See integrated services digital network.

J**jumper**

A metal bridge that closes an electrical circuit. Typically, a jumper consists of a plastic plug that fits over a pair of protruding pins. Jumpers are sometimes used to configure expansion boards. By placing a jumper plug over a different set of pins, you can change a board's parameters.

K**Kbyte**

See kilobyte.

kilobyte

1024 bytes. Roughly the amount of information in half a typewritten page.

L**LAN**

See local area network.

LCD

Liquid crystal display. An alphanumeric display using liquid crystal sealed between two pieces of glass.

LED

Light emitting diode. A semiconductor diode that emits light when a current is passed through it.

local area network

A computer network that spans a relatively small area. Most LANs connect workstations and personal computers and are confined to a single building or group of buildings.

local call

A call that originates at your site.

local station

A telephone set located at a remote site.

logical expression

A symbol used in scripts to test for different conditions. Logical expressions are AND, OR, and NOT. *See also* mathematical expressions and relational expression.

M**M1**

Meridian 1 PBX

MAT

Meridian Administration Tools. This is a Nortel Networks software application that is used to administer the Meridian 1 PBX.

mathematical expressions

The expressions used in scripts to add, subtract, multiply, and divide values. Mathematical expressions are addition (+), subtraction (-), division (/), and multiplication (*). *See also* logical expression, relational expression.

Mbyte

See megabyte.

megabyte

A unit of measurement for data storage equal to 1 048 576 bytes.

megahertz

One million cycles per second.

MHz

See megahertz.

RLC

An abbreviation for Reach Line Card. The RLC is installed on the host PBX and relays voice and signaling information from the digital telephones connected at a remote site to the host PBX.

motherboard

The principal board that has connectors for attaching devices to the bus. Typically, the motherboard contains the CPU, memory, and basic controllers for the system. On PCs, the motherboard is often called the system board.

MTBF

Mean time between failures.

Mu-law

A companding method for encoding and decoding audio signals in 24-channel pulse-code-modulated (PCM) systems. Mu-law is the method used in North America and Japan *See also* A-law.

multiuser ports

A Remote Office 9150 unit port feature that allows multiple stations to time-share a single port on the host PBX. All stations that use a multiuser port are always assigned to the same port number (TN) on the host PBX.

N**NetBeui**

See NetBIOS enhanced user interface.

NetBIOS

See Network Basic Input Output System.

NetBIOS enhanced user interface

An enhanced version of the NetBIOS protocol used by network operating systems such as LAN Manager, LAN Server, Windows for Workgroups, Windows 95 and Windows NT.

Network Basic Input Output System

An application programming interface (API) that augments the DOS BIOS by adding special functions for local-area networks (LANs). Almost all LANs for PCs are based on the NetBIOS. Some LAN manufacturers have even extended it, adding additional network capabilities.

network interface card

An expansion board that enables a PC to be connected to a local area network (LAN).

NIC

See network interface card.

node

A device connected to the network capable of connecting to other network devices. For example, the RLC and each remote unit are nodes on the network.

NPA

See Number Plan Area.

Number Plan Area

Area code

NVRAM

Non-Volatile Random Access Memory. RAM that doesn't lose its memory when you shut the electricity off to it.

O**OA&M**

Operations, administration, and maintenance

object linking and embedding

A compound document standard that enables you to create objects with one application and then link or embed them in a second application.

ODBC

See Open Database Connectivity.

OEM

Original Equipment Manufacturer. The maker of equipment marketed by another vendor, usually under the name of the reseller. The OEM may only manufacture certain components, or complete computers, that are then often configured with software and/or other hardware, by the reseller.

OLE

See object linking and embedding.

online/offline table

The online/offline table is configured on the RLC. It allows you to schedule times that the host PBX connection is made available to the remote site and the times all telephones at the remote site can use only the local telephone service.

The online/offline table is used for controlling ISDN BRI costs.

Open Database Connectivity

A Microsoft-defined database application program interface (API) standard.

Open System Interconnection

A worldwide communications standard that defines a framework for implementing protocols in seven layers.

OS

Operating Standard

OSI

See Open System Interconnection.

P

packetized voice

Digital signal processors (DSPs), located in the Remote Office 9150 unit and RLC, convert analog voice into digital data. The data is constructed as a UDP/IP voice packet for transmission over an IP network.

parity

The quality of being either odd or even. The fact that all numbers have parity is commonly used in data communications to ensure the validity of data.

parallel port

A type of interface used to connect an external device such as a printer to a PC. Most personal computers have both a parallel port and at least one serial port.

PBX

See private branch exchange.

PC

Personal computer. A computer with an architecture that is compatible with the IBM PC.

pegging

The action of incrementing statistical counters to track system events.

pegging threshold

A threshold used to define a cut-off value for statistics such as short call and service level. Pegging thresholds are used in reports and historical statistics.

personal directory number

A DN that an agent can be reached directly on, usually for private calls.

phoneset

The physical device, connected to the switch, calls are presented to.

PING

Packet Internet Groper. A protocol that can be used to test the Ethernet connection to devices on the network (such as the RLC and its associated remote units).

position ID

A unique identifier for a phoneset, used by the switch to route calls to the phoneset.

POST

See power-on self-test.

power-on self-test

Initializes and performs rudimentary tests on baseboard hardware, including CPU, floating point unit, interrupts, memory, real-time clock, video, and auto-initializing PCI and EISA bus.

private branch exchange

A telephone switch, typically used by a business to service its internal telephone needs. A PBX usually offers more advanced features than are generally available on the public network. Users of the PBX share a certain number of outside lines for placing telephone calls external to the PBX.

protocol

A standard format used for communication between two devices. The protocol determines the type of error checking to be used, the data compression method (if any), how the sending device will indicate that it has finished sending a message, and how the receiving device will indicate that it has received a message.

PSTN

See public switched telephone network.

public switched telephone network

Any common carrier network that provides circuit switching between public users. The term is usually applied to the public telephone network.

R

RAM

Random Access Memory. This is the most common type of memory found in computers and other devices, such as printers. The term RAM is usually synonymous with main memory, the memory available to programs. For example, a computer with 8 Mbytes of RAM has approximately 8 million bytes of memory that programs can use.

RAS

Remote Access Server. A host on the local area network that is equipped with modems to enable users to connect to the network over telephone lines.

real-time clock

A clock that keeps track of the time even when the computer is turned off. *See also* CPU clock.

recorded announcement route

A resource installed on the switch that offers a recorded announcement to callers.

relational expression

An expression used in scripts to test for different conditions. Relational expressions are less than (<), greater than (>), less than or equal (<=), greater than or equal (>=), and not equal (<>). *See also* logical expression and mathematical expressions.

Remote Access Services

A feature built into Windows NT and Windows 95 that enables users to log in to an NT-based LAN using a modem, X.25 connection, or WAN link. Also known as Dial Up Networking.

remote station

A telephone set located at the Remote Office 9150 or Remote Office 911x series site.

RJ-11 Connector

A six-conductor modular jack that is typically wired for four conductors. The RJ-11 jack is the most common telephone jack in the entire world.

RJ-45 Connector

An eight position, eight conductor modular jack used for data transmission over a standard telephone wire. The RJ-45 jack provides the 10BaseT Ethernet connection.

ROM

Read-Only Memory. This is the computer memory that data has been prerecorded on and cannot be removed from.

router

A device that connects two LANs. Routers are similar to bridges but provide additional functionality, such as the ability to filter messages and forward them to different places based on various criteria.

RTC

See real-time clock.

S**SCA**

See single connector architecture.

second-level threshold

The value used in display thresholds that represents the highest value of the normal range for a given statistic.

security identifier

The remote unit sends the branch office security identifier (password) to the RLC for each connection request. The RLC matches the identifier configured for the RLC port. When it finds a match, it grants access to the port and allows the call to proceed.

sequenced packet exchange

A transport layer protocol (layer 4 of the OSI Model) used in Novell Netware networks. The SPX layer sits on top of the IPX layer (layer 3) and provides connection-oriented services between two nodes on the network. SPX is used primarily by client/server applications.

serial port

A general-purpose interface that can be used for almost any type of device, including modems, mice, and printers (although most printers are connected to a parallel port). Most serial ports on personal computers conform to the RS-232C or RS-422 standards.

server

A computer or device on a network that manages network resources. Examples of servers include file servers, print servers, network servers, and database servers.

service

A process that adheres to a Windows NT structure and requirements. A service provides system functionality.

Service Control Manager

A Windows NT process that manages the different services on the PC.

service profile identifier

When you order an ISDN line, your phone company provides you with a SPID for every phone number you have.

silence suppression

A feature that prevents packet transmission during periods when there is no voice data present.

SIMM

Single In-line Memory Module. Used on Macs and PCs. A form of chip packaging where leads (pins) are arranged in a single row protruding from the chip.

simple network management protocol

A set of protocols for managing complex networks. SNMP works by sending messages, called protocol data units (PDUs), to different parts of a network and then analyzing the responses.

single connector architecture

A method for supplying power and data lines in one connector on hard disks. Provides hot-swap capability.

single-user ports

A RLC port that supports one remote station.

Small Computer System Interface

A standard for connecting and controlling mass storage devices such as CD-ROMS, tape drives, and hard disks.

SNMP

See simple network management protocol.

SPID

See service profile identifier.

SPRE code

A Special Prefix code that is used to initiate use of a host PBX feature. In a Remote Office context, SPRE codes are used to

- toggle a remote site between online and offline modes
- use the paging feature
- switch an analog or ATA equipped station from host-controlled mode to locally controlled mode so that local calls can be made
- register a Remote Office 9150 unit for a multiuser or dynamic port

SPX

See sequenced packet exchange.

SRAM

Static Random Access Memory. A form of RAM that retains its data without the constant refreshing that DRAM requires.

station

A telephone or fax machine located at a remote site.

stop bit

In asynchronous communications, a bit that indicates a byte has just been transmitted. Every byte of data is preceded by a start bit and followed by a stop bit.

subnet mask

A subnet mask is the part of the IP address used to represent a subnetwork within a network. A typical IP address might be 192.210.34.144. Each part of this address is made up of eight bits. The subnet mask identifies to the RLC or remote unit what portion of the IP address represents the network (and subnetwork) and what portion represents the host.

SVGA

Super Video Graphics Adapter. An extension of the VGA video standard.

switch

In a telecommunications network, a switch is the hardware that receives phone calls and provides connections to telephone sets. The switch allows a connection to be established as necessary and terminated when there is no longer a session to support it.

In networks, a device that filters and forwards packets between LAN segments. Switches operate at the data link layer (layer 2) of the OSI Reference Model and therefore support any packet protocol. LANs that use switches to join segments are called switched LANs or, in the case of Ethernet networks, switched Ethernet LANs.

switch resource

A device that is configured on the switch.

T**TAPI**

See telephone application programming interface.

TCP/IP

Transport Control Protocol/Internet Protocol. The communication protocol used to connect devices on the Internet. TCP/IP is the standard for transmitting data over networks.

telephone application programming interface

A term that refers to the Windows Telephony API. TAPI is a changing (i.e. improving) set of functions supported by Windows that allow Windows applications to program telephone-line based devices such as single and multi-line phones (both digital and analog), modems and fax machines in a device-independent manner.

telephony

The science of translating sound into electrical signals, transmitting them, and then converting them back to sound. The term is used frequently to refer to computer hardware and software that perform functions traditionally performed by telephone equipment.

TFTP

See trivial file transfer protocol.

threshold

A value for a statistic that system handling of the statistic changes at.

threshold class

A set of options that specifies how statistics are treated in reports and real-time displays. *See also* pegging threshold.

Token Ring

A PC network protocol developed by IBM. A Token Ring network is a type of computer network whereby all the computers are arranged schematically in a circle.

trivial file transfer protocol

A simplified version of FTP that transfers files but does not provide password protection or user-directory capability. It is associated with the TCP/IP family of protocols. TFTP depends on the connectionless datagram delivery service, UDP.

trunk

A communications link between a PBX and the public central office, or between PBXs. Various trunk types provide services such as Direct Inward Dialing (DID), ISDN, and central office connectivity.

trunk access digits

Trunk access digits are numbers that are used by the remote unit to determine the trunk to use when routing a call. For example, 9 is a common trunk access digit used to obtain an outside line.

trunk groups

A trunk group consists of one or more trunk lines that are logically grouped. You can configure up to eight trunk groups on the Remote Office 9150 unit.

U**uninterruptible power supply**

A power supply that includes a battery to maintain power in the event of a power outage. Typically, a UPS keeps a computer running for several minutes after a power outage, enabling you to save data that is in RAM and to shut down the computer safely.

UPS

See uninterruptible power supply.

utility

A program that performs a specific task, usually related to managing system resources. Operating systems contain a number of utilities for managing disk drives, printers, and other devices.

V**V.35**

An ITU-T standard describing a synchronous, physical layer protocol used for communications between a network access device and a packet network. V.35 is most commonly used in the United States and in Europe, and is recommended for speeds up to 48 Kbps. In practice, V.35 is used for synchronous transmission up to 2.048 Mbps.

V.35 interface

A Frame Relay network technology used to carry the voice conversation and telephone set control signals over:

- a Frame Relay Access Device to send the voice and signal packets to the Remote Office 9150 unit via a Frame Relay Network

- a Channel Service Unit/Data Service Unit (CSU/DSU) to access a switched 56K line service

voice compression

Prior to transmission, the voice data is compressed; after transmission, the data is converted back to voice data at the destination. Voice compression means that voice consumes less bandwidth, leaving more bandwidth for data or other voice or fax communications.

voice jitter attenuation

A feature that removes the variable delays from the voice packets sent across the IP network, thus avoiding awkward-sounding speech.

Voice over Internet Protocol (VoIP)

Technology that uses the IP data network to carry the voice conversation and telephone set control signals between a remote site and the host PBX.

W**WAN**

Wide area network. A computer network that spans a relatively large geographical area. Typically, a WAN consists of two or more local area networks (LANs). The largest WAN in existence is the Internet.

Fields Index

Symbols

802.1p Mapping 90

A

Addon Module Type 87

Address Information

IP Address 90

IP Gateway 90

IP Network Mask 90

Analog Localization 87

Autohold 87

Automatic DHCP Configuration 90

Available Flex Channels 131

Available MIPS 130

Available Voice Channels 130, 131

B

Bandwidth (BW) Connection Statistics

IP QoS Status 124

No of Voice Calls on IP 124

No of Voice Calls on PSTN 124

Remote Unit Number 124

Signaling Status 124

Total Up Trunk BW 124

Used IP BW 124

Used Trunk BW 124

BroadCast Packet 138

Browse

Upload Configuration 115

Browse (button)

Software Upload 146

C

Call BW 127

Caller Info Statistics

Call BW 127

Connection ID 127

Current Media 127

Last Transition to IP 127

Last Transition to PSTN 127

Priority 127

Remote ID 127

Start Time 127

Transitions to IP 127

Transitions to PSTN 127

Type 127

Connection ID 127

Current Media 127

D

Device Number 130

DiffServ CodePoint 90

DSP Gain 85

DSP Statistics

Total Voice Channels 130

DSP statistics

Available Flex Channels 131

Available MIPS 130

Available Voice Channels 130, 131

Device Number 130

In Service 130

Module Number 130

Name 131

Single Dig Dev ID 130

Total Channels 130

Total Flex Channels 131

Total MIPS 130
Total Modem Channels 130
Total Reserved Channels 131
Total Tones Channels 131

E

Emergency Activation Code 85
Error % 138
Ethernet Interface Statistics
 UPkts 134

H

Hour 138

I

In Service 130
Inbound Security ID 94
IP Address 90
 Software Upload 145
 Upload Configuration 114
IP Connection 93
 IP Address 93
 IP Signaling 93
IP Gateway 90
IP Network Mask 90
IP QoS Status 124

L

Last Transition to IP 127
Last Transition to PSTN 127
Local Call
 Autohold 87
 Local Calling Key Position 86
Local DN 87

M

Messages 120
Modem Tones 87
Module Number 130

N

Name 131
Network statistics
 BroadCast Packet 138
 Error % 138
 Hour 138
 Rx DiscPkt 138
 Rx Dropped 138
 Rx Error 138
 Rx Frames 138
 Rx MultiPkt 138
 Rx UCastPkt 138
 Tx DiscPkt 138
 Tx Frames 138
 Tx UCastPkt 138
No of Voice Calls on IP 124
No of Voice Calls on PSTN 124
Node Name 85

O

Outbound Security ID 94

P

Phone Type 87
Priority 127
PSTN Connection 93
 PSTN Number to Connect to RLC 93

R

registration 86
Remote ID 127

Remote Unit Number 124
 Resize Logs
 Messages 120
 RLC Port Number 93
 Rx DiscPkt 138
 Rx Dropped 138
 Rx Error 138
 Rx Frames 138
 Rx MultiPkt 138
 Rx UCastPkt 138

S

Security ID
 Inbound Security ID 94
 Outbound Security ID 94
 Security Level 94
 Signaling Status 124
 Single Dig Dev ID 130
 SPRE Codes
 DeRegistration 86
 Offline 86
 Online 86
 registration 86
 Start Time 127
 statistics
 Bandwidth (BW) Connection Statistics
 IP QoS Status 124
 No of Voice Calls on IP 124
 No of Voice Calls on PSTN 124
 Remote Unit Number 124
 Signaling Status 124
 Total Up Trunk BW 124
 Used IP BW 124
 Used Trunk BW 124
 Caller Info Statistics
 Call BW 127
 Connection ID 127
 Current Media 127
 Last Transition to IP 127
 Last Transition to PSTN 127
 Priority 127
 Remote ID 127
 Start Time 127
 Transitions to IP 127
 Transitions to PSTN 127
 Type 127
 Caller Info Statistics field descriptions 127
 DSP statistics
 Available Flex Channels 131
 Available MIPS 130
 Available Voice Channels 130, 131
 Device Number 130
 In Service 130
 Module Number 130
 Name 131
 Single Dig Dev ID 130
 Total Channels 130
 Total Flex Channels 131
 Total MIPS 130
 Total Modem Channels 130
 Total Reserved Channels 131
 Total Tones Channels 131
 Total Voice Channels 130
 Ethernet Interface Statistics
 UPkts 134
 Network statistics
 BroadCast Packet 138
 Error % 138
 Hour 138
 Rx DiscPkt 138
 Rx Dropped 138
 Rx Error 138
 Rx Frames 138
 Rx MultiPkt 138
 Rx UCastPkt 138
 Tx DiscPkt 138
 Tx Frames 138
 Tx UCastPkt 138
 Resize Logs
 Messages 120

T

Time Offset 85
Total Channels 130
Total Flex Channels 131
Total MIPS 130
Total Modem Channels 130
Total Reserved Channels 131
Total Tones Channels 131
Total Up Trunk BW 124
Total Voice Channels 130
Transitions to IP 127

Transitions to PSTN 127
Tx DiscPkt 138
Tx Frames 138
Tx UCastPkt 138
Type 127

U

Unit ID 85, 93
UPkts 134
Used IP BW 124
Used Trunk BW 124

Index

Numerics

- 10BaseT Ethernet
 - connection options 11
 - description 2

A

- ACD features
 - features
 - ACD features 20
- Admin 134
- Admin connector 177
- Automatic Call Distribution (ACD)
 - applications 21

B

- backup
 - creating a backup configuration file 111
 - introduction 110
 - restoring the configuration 113
 - storing configuration files 110
- bandwidth
 - measuring with Bandwidth Connection Statistics 122
- Bandwidth Connection Statistics screen 122
- bandwidth limit 98
 - display message 102

C

- cable connectors
 - RJ-11 7
 - RJ-45 7
- cable modem 10
- cables

- included 30
 - not included 30
- cabling
 - cables included with the External IP Adapter unit 30
 - cables included with the Meridian Digital Telephone External IP Adapter 30
 - cables you must supply 30
 - Internal IP Adapter
 - TCM 7
- call forward feature 20
- call modes
 - host-controlled 13
- call transfer 104
- call waiting 20, 103
 - host-controlled mode 103
- call waiting feature
 - features
 - call waiting 20
- Caller Information Statistics
 - displaying 126
- Caller Information Statistics screen 125
 - QoS Transitioning Technology 125
- calls
 - call transfer feature 104
 - call waiting feature 103
 - conference feature 105
 - display messages 101
 - emergency service calls feature 103
 - hold feature 103
 - host-controlled indicator updates 100
 - host-controlled mode 96
 - incoming 13
 - methods for placing outgoing calls 98
 - offline mode 96
 - online mode 96
 - online/offline modes
 - putting unit in online mode 105
 - outgoing 13

- placing a host-controlled call 98
 - bandwidth limit 98
 - DSP limit 98
- Canadian Standards Association
 - CSA C22.2, No 950 182
- Canadian Standards Association (CSA) 182
- Channel 134
- computer telephony integration applications 20
- conference 105
- conference feature 20
- configuration
 - default values
 - restoring 58, 59
 - deregistration SPRE code 66
 - emergency code 62
 - IP information 57
 - offline SPRE code 64
 - online SPRE code 63
 - registration SPRE code 65
 - telephone menu 57
 - default password 57
 - display local IP 57
 - modify deregistration SPRE code 66
 - modify emergency code 62
 - modify offline SPRE code 64
 - modify online SPRE code 63
 - modify registration SPRE code 65
 - modify unit ID 60
 - restore default values 58, 59
 - time offset 61
 - user name 57
 - time offset 61
 - unit ID 60
- Configuration Manager
 - Help
 - Display Logs definitions 162
- configuring the unit using the telephone menu
 - accessing the telephone menu 55
 - before you begin 57
 - information you need 54
 - running the telephone menu script 57
 - telephone menu key function 55
- configuring the unit with Configuration Manager
 - IP addresses
 - configuring 88

- RLC connection information
 - configuring 91
 - system settings
 - configuring 83
 - field descriptions 85
 - system identification information 82
- connection options
 - 10BaseT Ethernet 11
 - administration PC 31
 - introduction 11
- CSA C22.2, No. 950 182

D

- DB-9 connector
 - Meridian Digital Telephone External IP Adapter 7
- deployment
 - IP options 37
 - on-demand 37
 - permanent 37
 - media 36
 - NAT 36
 - PNAT 36
- deployment options
 - introduction 36
 - Meridian Digital Telephone IP Adapter 36
- deregistration 86
 - SPRE code 66
- digital telephones
 - display messages
 - introduction 101
 - message descriptions 101
 - going online and offline
 - introduction 105
 - overriding an automatic offline event 106
 - using the SPRE code for online mode 105
- indicator updates
 - host-controlled indicator updates 100
 - introduction 100
- modes of operation
 - controlling online and offline modes 96
 - host-controlled mode 96
 - introduction 96
 - offline mode 96

- online mode 96
- placing and receiving calls
 - methods for placing outgoing calls 98
 - placing host-controlled calls 98
- supported sets 19
- telephone features
 - introduction 103
- troubleshooting 153
- Disc 134, 135
- Display Logs
 - definitions 162
- display messages
 - bandwidth limit 102
 - going offline 101
 - hostless mode 101
 - offline mode 101
 - online mode 102
 - port already in use 102
 - port not logged in 102
 - release and try again 102
- documents
 - related xxii
- DSP
 - DSP Statistics screen 128
- DSP application modules
 - Hardware Statistics 128, 132
- DSP limit 98
 - display message
 - display messages
 - DSP limit 102
- DSP Statistics screen 128

E

- electromagnetic compatibility 183
 - AS 3548 Class B (Australia) 183
 - Class A of FCC Part 15, Subpart J 183
 - CSPR B requirements 183
 - margin 183
- electromagnetic immunity 184
- electrostatic discharge 185
- emergency
 - service number description 23
- emergency calls
 - placing 103

- emergency code 62
- emergency service calls 103
- emergency service calls feature 103
- EN90650 182
- equipment
 - equipment attachment notices 179
- equipment attachment notices 179
 - Industry Canada 180
- Err 134, 135
- Ethernet
 - Ethernet Interface Statistics screen 132
- Ethernet Interface Statistics
 - Admin 134
 - Channel 134
 - Disc 134, 135
 - Err 134, 135
 - Ifc Type 134
 - IfcNo 134
 - In - Octet 134
 - LAN Drv 134
 - MPkts 134, 135
 - MTU Len 134
 - Oper 134
 - Out - Octet 134
 - QLen 135
 - Speed 134
 - UPkts 134
- Ethernet Interface Statistics screen 132
- extracting upgrade files from the download file
 - 142

F

- features
 - call forward 20
 - call transfer 104
 - call waiting 20, 103
 - host-controlled mode 103
 - conference 20, 105
 - hold 20
 - transfer 20
- firmware
 - extracting upgrade files 142
 - upgrade
 - downloading files 141

performing 144

G

going offline

display message 101

H

Hardware Statistics

introduction 128, 132

Help

Display Logs definitions 162

hold 20, 103

hold feature 20

host-controlled calls

placing 98

bandwidth limit 98

DSP limit 98

host-controlled mode

indicator updates 100

overview 96

hostless mode

display message 101

I

Ifc Type 134

IfcNo 134

In - Octet 134

incoming calls 13

Industry Canada notice 180

installation

External IP Adapter unit

powering up 52

general safety 40

Internal IP Adapter unit

connecting 46

Meridian Digital Telephone Internal IP

Adapter unit

powering up 47

removing the base of the digital telephone

42

Meridian Digital Telephone IP Adapter 40

unpacking and inspecting the equipment 41

international safety compliance 182

Australia 182

Canadian Standards Association 182

EN90650 182

Underwriters Laboratory (UL) 182

Internet Access Device

description 10

IP

addressing and routing 34

PSTN and IP network diagram 12

remote unit 57

IP deployment 37

IP on-demand 37

IP permanent 37

IP on-demand 37

IP permanent 37

ISDN Basic Rate Interface (BRI) router 10

L

LAN Drv 134

LEDs

description 5

Meridian Digital Telephone IP Adapter 152

Meridian Digital Telephone IP Adapter unit

LED display diagrams 6

troubleshooting 152

logs

clearing

introduction 121

displaying

introduction 118

viewing 118

M

media 36

Meridian Communication Adapters (MCA) 20

Meridian Digital Telephone External IP Adapter

cables included 30

universal power supply 9

Meridian Digital Telephone External IP Adapter

unit

cables included 30

Meridian Digital Telephone Internal IP Adapter
 universal power supply 8

Meridian Digital Telephone IP Adapter
 cable connections 7
 cable connectors 7
 cables you must supply 30
 configuring using the telephone menu 53
 deployment options 36
 installing 40
 LEDs 152
 network considerations 34
 password 108
 physical environment 28
 using the digital telephone 95

Meridian Digital Telephone IP Adapter units
 power requirements 25

mounting options
 Meridian Digital Telephone External IP
 Adapter 30

MPkts 134, 135
 MTU Len 134

N

NAT 36
 network address translation (NAT) 36
 network considerations
 introduction 34
 IP addressing and routing 34
 no security 18
 notices
 equipment attachment 179
 Industry Canada 180

O

offline 86
 offline mode
 display message 101
 offline SPRE code 64
 online 86
 online mode
 display message 102
 online SPRE code 63
 online/offline table

configuration 22
 how the table works 22
 introduction 22
 offline mode 96
 online mode 96

Oper 134
 Out - Octet 134
 outgoing calls 13

P

password
 Configuration Manager password 108
 default 57
 Meridian Digital Telephone IP Adapter
 password 108

PC administration
 administering multiple nodes 32
 connection options 31
 Ethernet connection 31

PC requirements 32

PING
 using 163

pin-out tables
 connector
 Admin 177
 Power 178
 RJ-45 ethernet connector 176

placing calls
 host-controlled 98
 bandwidth limit 98
 DSP limit 98

PNAT 36

port already in use
 display message 102

port not logged in
 display message 102

port number and network address translation
 (PNAT) 36

Power
 connector 178

power requirements
 Meridian Digital Telephone IP Adapter units
 25

preinstallation preparation

unpacking and inspection 41

Q

QLen 135

QoS Transitioning Technology
 Caller Information Statistics 125

R

Reach Line Card (RLC)

 description 3

registration

 registration SPRE code 65

related documents xxii

release and try again

 display message 102

restoring

 introduction 113

 uploading a configuration file 114

RJ-11 connector 7

routers

 NAT routers 36

 PNAT routers 36

S

safety and regulatory information 181

 electromagnetic compatibility 183

 AS 3548 Class B (Australia) 183

 Class A of FCC Part 15, Subpart J 183

 CSPR B requirements 183

 margin 183

 electromagnetic immunity 184

 electrostatic discharge 185

 international safety compliance 182

 Australia

 TS001AS 3260 182

 CSA C22.2, No. 950 182

 EN90650 182

 UL 1950 182

security

 no security 18

 security identifier 18

security identifier 18

software

 upgrades

 performing 148

Speed (statistic) 134

SPRE code

 deregistration

 modifying 66

 offline

 modifying 64

 online

 modifying 63

 registration

 modifying 65

SPRE codes 63–66

 deregistration 86

 offline 86

 online 86

 registration 86

statistics

 Bandwidth Connection Statistics screen 122

 Caller Information Statistics screen 125

 QoS Transitioning Technology 125

 DSP Statistics screen 128

 Ethernet Interface Statistics

 Admin 134

 Channel 134

 Disc 134, 135

 Err 134, 135

 Ifc Type 134

 IfcNo 134

 In - Octet 134

 LAN Drv 134

 MPkts 134, 135

 MTU Len 134

 Oper 134

 Out - Octet 134

 QLen 135

 Speed 134

 UPkts 134

 Ethernet Interface Statistics screen 132

T

TCM 7

- telephone features
 - emergency service calls 103
 - hold 103
 - introduction 103
 - telephone menu 57
 - accessing 55
 - default password 57
 - IP 57
 - display local IP 57
 - modify deregistration SPRE code 66
 - modify emergency code 62
 - modify offline SPRE code 64
 - modify online SPRE code 63
 - modify registration SPRE code 65
 - modify unit ID 60
 - password
 - default 57
 - restore default values 58, 59
 - time offset 61
 - user name 57
 - telephones
 - supported digital telephones 19
 - supported features 20
 - supported telephone modules 19
 - TFTP
 - and upgrades 144
 - defined 32
 - time offset 61
 - transfer 20
 - transfer feature 20
 - transport media 36
 - troubleshooting
 - before you begin 150
 - recovering from a catastrophic failure 166
 - using PING 163
 - TSS001AS 3260 182
- ## U
- UL 1950 182
 - Underwriters Laboratory (UL) 182
 - UL 1950 182
 - unit ID
 - modifying 60
 - universal power supply
 - Meridian Digital Telephone External IP Adapter 9
 - Meridian Digital Telephone Internal IP Adapter 8
 - upgrades
 - performing 142
 - firmware upgrade 144
 - obtaining the latest file 141
 - software upgrade 148
 - upgrades and configuration files 144
 - verifying the firmware and software versions 139
 - when to perform 144
 - UPkts 134
 - user name 57

Meridian Digital Telephone IP Adapter

Installation and Administration Guide

Copyright © 2001 Nortel Networks, All Rights Reserved.

Printed in Canada.

All information contained in this document is subject to change without notice. Nortel Networks reserves the right to make changes to equipment design or program components, as progress in engineering, manufacturing methods, or other circumstances may warrant.

*Nortel Networks, the Nortel Networks logo, the Globemark, and Unified Networks, Meridian 1, MSL-100, and Succession Communication Server for Enterprise 1000 are trademarks of Nortel Networks.

MICROSOFT, MS-DOS, WINDOWS, and WINDOWS NT are trademarks of Microsoft Corporation.

Publication number:	555-8421-220
Product release:	1.3
Document release:	Standard 1.1
Date:	October 2001



Free Manuals Download Website

<http://myh66.com>

<http://usermanuals.us>

<http://www.somanuals.com>

<http://www.4manuals.cc>

<http://www.manual-lib.com>

<http://www.404manual.com>

<http://www.luxmanual.com>

<http://aubethermostatmanual.com>

Golf course search by state

<http://golfingnear.com>

Email search by domain

<http://emailbydomain.com>

Auto manuals search

<http://auto.somanuals.com>

TV manuals search

<http://tv.somanuals.com>