

# 808.2/808.2i Signature Reference CD Player User Guide

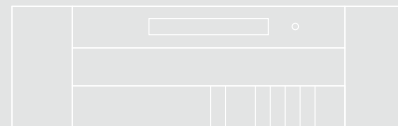

# Important safety instructions

- Read the instructions.
- Keep these instructions.
- Follow all instructions.
- Do not use this apparatus near water.
- Clean only with a dry cloth.
- Install only in accordance with the manufacturer's instructions.
- Refer all servicing to approved service personnel.

**WARNING: TO REDUCE THE RISK OF FIRE OR ELECTRIC SHOCK, DO NOT EXPOSE THIS APPARATUS TO RAIN OR MOISTURE.**

This apparatus has been designed with Class 1 construction and must be connected to a mains socket outlet with a protective earthing connection (the third grounding pin).

This apparatus uses a single-pole power switch. As a result it is not isolated from AC mains power when switched off at the rear panel. The apparatus may be isolated from mains power either by unplugging the power connector from the rear of the unit, or by unplugging the connector at the opposing end of the power cord or cable from its supply outlet. As a result, either or both of these connectors should remain accessible

## Safety warnings

**WARNING: TO REDUCE THE RISK OF FIRE OR ELECTRIC SHOCK, DO NOT EXPOSE THIS APPARATUS TO RAIN OR MOISTURE**

- Do not expose the unit to dripping or splashing.
- Do not place any object filled with liquid, such as a vase, on the unit.
- Do not place naked flame sources, such as lighted candles, on the unit.

## To avoid overheating

- Leave at least 10cm around the equipment to ensure sufficient ventilation.

Do not position the unit:

- In direct sunlight.
- Near heat sources, such as a radiator.
- Directly on top of heat producing equipment, such as a power amplifier.

## To avoid interference

Do not position the unit:

- Near strong electrical or magnetic radiation, such as near a power amplifier.

## Radio interference

**FCC Warning:** This equipment generates and can radiate radio frequency energy and if not installed and used correctly in accordance with our instructions may cause interference to radio communications or radio and television reception. It has been type-tested and complies with the limits set out in Subpart J, Part 15 of FCC rules for a Class B computing device. These limits are intended to provide reasonable protection against such interference in home installations.

**EEC:** This product has been designed and type-tested to comply with the limits set out in EN55013 and EN55020.



# Contents

|  |           |                                  |           |
|--|-----------|----------------------------------|-----------|
| <b>Introduction</b>                                  | <b>1</b>  | <b>Installing the CD player</b>  | <b>21</b> |
| The 808.2 Signature Reference CD Player              | 2         | Unpacking                        | 22        |
| Specifications                                       | 3         | Applications                     | 24        |
| <b>Using the 808.2 Signature Reference CD Player</b> | <b>5</b>  | <b>Configuring the CD player</b> | <b>29</b> |
| Front panel keys                                     | 6         | Choosing a standard setting      | 30        |
| MSR+ keys  | 7         | Setting up sources               | 31        |
| Switching on and off                                 | 8         | <b>Index</b>                     | <b>33</b> |
| Playing a disc                                       | 9         |                                  |           |
| Stopping and pausing play                            | 10        |                                  |           |
| Repeat   | 11        |                                  |           |
| Scanning a disc                                      | 12        |                                  |           |
| Programming a selection                              | 13        |                                  |           |
| Changing the absolute phase                          | 14        |                                  |           |
| Changing the front-panel display                     | 15        |                                  |           |
| <b>Using the CD player preamplifier features</b>     | <b>17</b> |                                  |           |
| Selecting a source                                   | 18        |                                  |           |
| Adjusting the system volume                          | 19        |                                  |           |
| Changing the balance                                 | 20        |                                  |           |

# Copyright and acknowledgements

## **Sales and service in the UK**

Meridian Audio Ltd  
Latham Road  
Huntingdon  
Cambridgeshire  
PE29 6YE  
England

Tel (01480) 445678  
Fax (01480) 445686

## **Sales and service in the USA**

Meridian America Inc  
8055 Troon Circle  
Suite C  
Austell  
GA30168-7849  
USA

Tel (404) 344 7111  
Fax (404) 346 7111

<http://www.meridian-audio.com>

## **Designed and manufactured in the UK**

Meridian Audio Ltd  
Latham Road  
Huntingdon  
Cambridgeshire  
PE29 6YE  
England

Copyright © 1999-2008 Meridian Audio Ltd.  
Part no: 808U/2 (P80813)

Boothroyd|Stuart Meridian, and Meridian are registered  
trademarks of Meridian Audio Ltd.

This guide was produced by:  
Human-Computer Interface Ltd,  
<http://www.interface.co.uk>

# Introduction

Welcome to the Meridian 808.2 Signature Reference CD Player.

This User Guide provides full information about using the CD player in conjunction with your other equipment, to achieve the superb results you can expect from it.

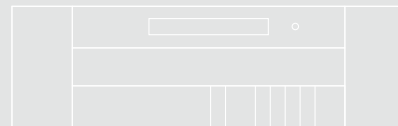

# The 808.2 Signature Reference CD Player

The 808.2 Signature Reference CD Player takes Compact Disc playback to an entirely new level, with a heritage that includes the multiple award winning 508 and 800, and two dozen optical disc players from 1984 to the present day. The 808.2 is specifically designed as a CD-optimised machine, able to play audio CDs, CD-Rs, and CD-R/Ws. It also plays the CD layer of an SACD disc.

At the heart of the 808.2 are fully-integrated electronics and a computer-style CD/DVD-ROM drive. The drive normally operates at standard CD speed, but is capable of much faster reading, using multiple high-speed re-reads to ensure accurate recovery of data from even the most difficult disc. This capability alone provides over ten times the error correction of a conventional CD player.

## Signal Processing

Once the digital data stream has been recovered from the disc, powerful on-board digital signal processing (DSP) with a capability of an impressive 150 MIPs upsamples the digital information from the 16-bit 44.1kHz signal of conventional CD to a 24-bit signal with a sample rate of 176.4kHz. This signal is fed to the latest DVD-Audio quality delta-sigma DACs to drive the analogue outputs, while a digital signal at an 88.2kHz sample rate is supplied to the digital outputs. Upsampling is performed with very high-accuracy filters which minimise pre-echo arising from ADCs and DACs used in the recording and replay process so that the total chain closely represents transmission of sound through air, for ultimate transparency from a CD source.

The 808.2 employs a triple buffering system to minimise jitter, and therefore maximise HF transparency and stereo image precision and stability. This, and the digital electronics as a whole, are driven by a new design of high-stability clocking system which further reduces jitter and ensure that the highest level of detail

is recovered from a disc. All digital data is accurately re-clocked.

Multiple power supplies ensure that digital and analogue circuitry are kept apart and can provide the required power when called upon to do so.

## Integrated preamplifier

The 808.2i version of the 808.2 Signature Reference CD Player includes a built-in stereo preamplifier with the ability to handle six stereo analogue inputs, three digital coaxial S/PDIF inputs, and two Toslink optical digital inputs, making it ideal as the heart of a superb stereo system.

## System integration

The 808.2 Signature Reference CD Player provides balanced and unbalanced analogue outputs for connecting to an external power amplifier or preamplifier. Alternatively, it provides SpeakerLink and coax digital outputs, allowing it to drive Meridian DSP Loudspeakers directly. The digital outputs support MHR (Meridian High Resolution) and operate at up to 2 x CD sample rate (88.2kHz), 24-bit.

Meridian Comms sockets (2 x DIN) allow communication with other Meridian components, while an RS232 interface provides full remote control capability as well as the ability to configure the unit with Meridian's innovative Windows-based graphic configuration application. Three programmable trigger outputs are provided for direct control of external devices, for example powering-up amplifiers, etc.

The Meridian 808.2 Signature Reference CD Player is supplied with the MSR+ learning/programmable remote control, which not only operates all Meridian products but also includes an extensive database of third-party products and the capability to learn commands from existing remotes.

# Specifications

## Drive

- Internal CD/DVD-ROM drive.

## Audio in and out

The 808.2 is supplied as standard with:

- 2-channel balanced audio output.
- 2-channel unbalanced audio output.
- 2-channel digital coax output.
- 2-channel Meridian SpeakerLink output.
- Optional MHR encryption on digital outputs at high rate

The 808.2i version also includes:

- Six 2-channel unbalanced analogue inputs. Adjustable sensitivity. Renameable legends.
- Three 2-channel digital coax inputs. Renameable legends. 32 to 96kHz sampling and up to 24-bit precision.
- Two 2-channel digital optical inputs. Renameable legends. 32 to 96kHz sampling and up to 24-bit precision.

## Signal processing

The 808.2 uses Meridian's proprietary DSP software to provide the following powerful features:

- Upsampling.
- FIFO and error correction.
- Resolution enhancement.

## Controls

Front-panel facia controls for:

- Open/Close, Play, Stop, Pause, Previous, Next, and On/Off.

A hinged control panel provides additional controls for:

- Repeat, Fast Forward/Reverse, Source, Store, Clear, Display, Mute, and Volume +/-.

## Display

- 20-character dot-matrix display with adjustable brightness and contrast.
- Indicators for Emphasis, Repeat, and Phase.





# Using the 808.2 Signature Reference CD Player

This chapter provides a summary of the functions of the 808.2 Signature Reference CD Player to identify the controls which you use to operate the unit.

It also provides step-by-step instructions for operating the CD player, using either the front panel or the MSR+.

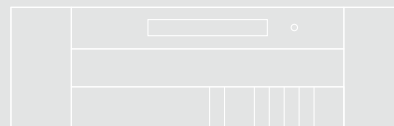

## Front panel keys

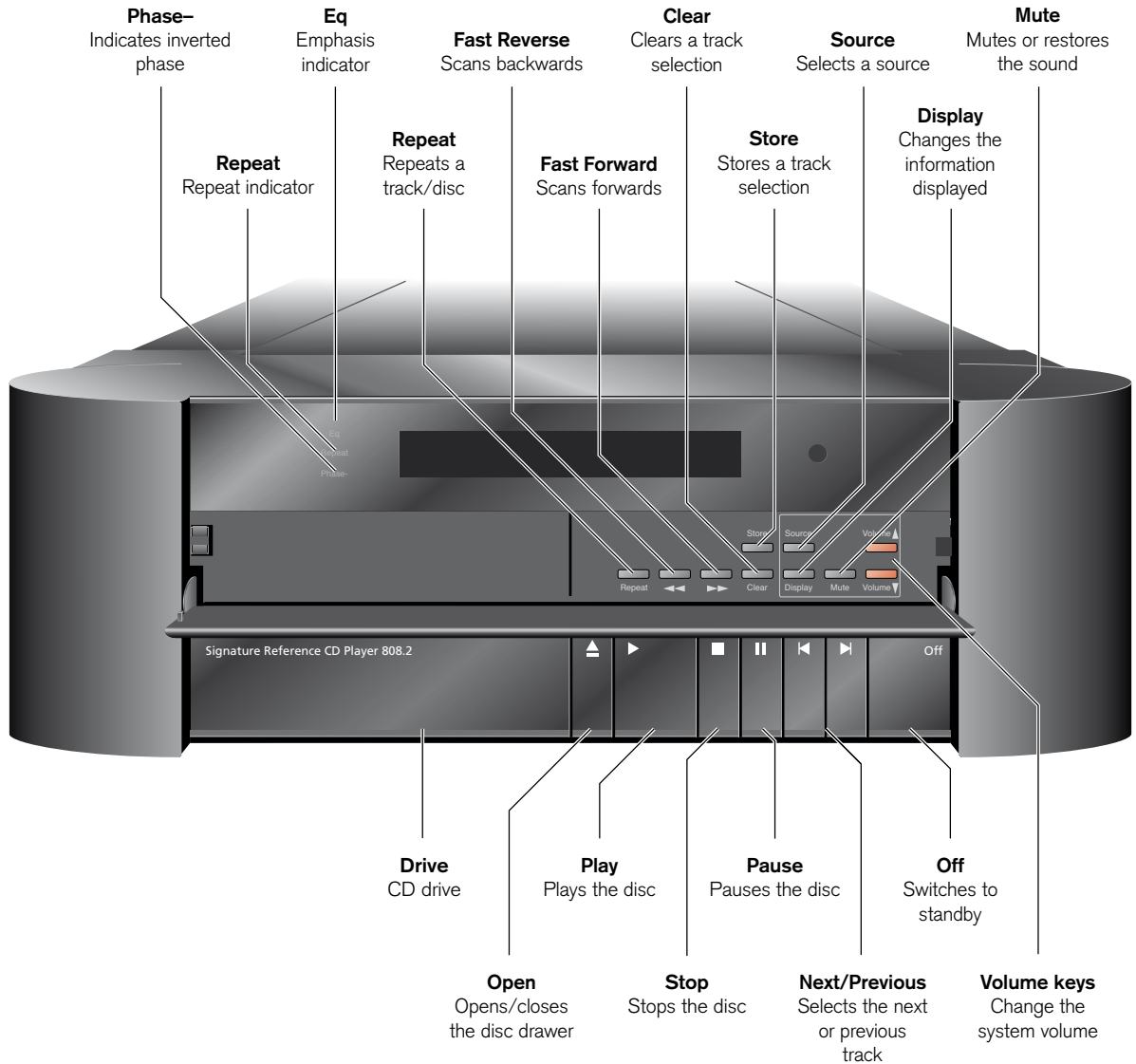

## MSR+ keys

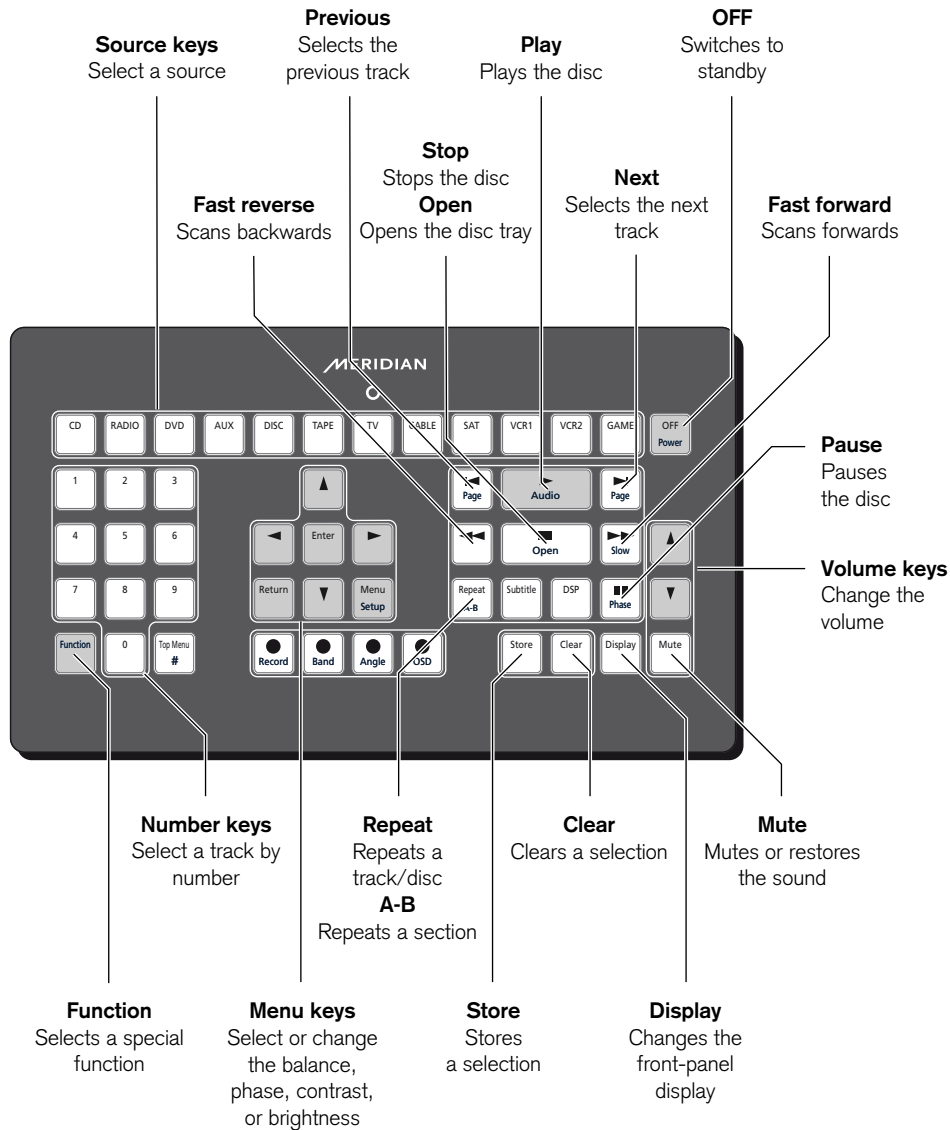

## Switching on and off

When not playing, the CD player should be left in the standby state. This uses a minimal amount of electricity, but ensures that the components of the CD player operate at maximum efficiency from the moment you start.

If you are not going to use the CD player for several days you should switch the unit off completely at the rear panel, and disconnect it from the AC power supply.

### To switch on from standby

- Press ▲, ■, or ► (front panel), or select a source on the remote.

If the CD player is part of a Meridian system it will automatically switch on any other units in the system, such as the 861 Reference Digital Surround Controller and Meridian DSP Loudspeakers.

### To insert a disc

- Press ▲ (front panel) or **Function** ■ (remote) to open the tray.
- Place your disc in the tray, label side up.
- Press ▲ (front panel), **Function** ■ (remote), or ► to close the tray.

### To switch to standby

- Press **Off** (front panel or remote).

If you have other Meridian equipment or Meridian DSP Loudspeakers connected to the CD player these units will also switch to standby.

If a disc is currently playing, switching to standby will stop the disc, and the disc can safely be left in the unit.

Always remove any disc before moving or shipping the 808.2.

## Playing a disc

The compact disc player allows you to play an entire disc, or start playing from any track. While a disc is playing you can go back to the start of the track or skip to the start of the next track.

If you have programmed a selection, these functions also work with the selection of tracks you have programmed. For information about programming see *Programming a selection*, page 13.

*If you have other Meridian sources you should ensure that the 808.2 is the currently selected source.*

### To play the disc

- Press ► (front panel or remote).

The display will show your selection.

For example:

A black rectangular display showing the word "Play" on the left and the number "1" on the right.

The display will then show the track number and elapsed time.

For example:

A black rectangular display showing the number "1" on the left and the time "00:12" on the right.

### To restart the current track

- Press ◀ (front panel or remote).

### To move to the next track

- Press ► (front panel or remote).

### To play starting from a particular track

- Press ► or ◀ (front panel or remote) to step through the track numbers until the track you want to play is displayed, or type the number of the track (remote only).

For example:

A black rectangular display showing the word "Track" on the left and the number "4" on the right.

After a short delay the track you have selected will start to play.

## Stopping and pausing play

You can pause a disc while keeping it spinning, so that you can resume play instantly.

### To stop playback

- Press ■ (front panel or remote).

The display will show the total number of tracks on the disc.

For example:

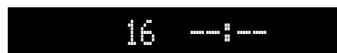

### To pause playback

- Press || (front panel or remote).

You can change tracks while the disc is paused using ◀ or ▶ (front panel or remote).

### To continue after pausing

- Press || or ▶ (front panel or remote).

# Repeat

You can choose to play a track, disc, or selection repeatedly, so that when it has played it will start again from the beginning.

## To continuously repeat a disc

- Press **Repeat** (remote or under the front panel) to select between the following options:

| Display      | Description           |
|--------------|-----------------------|
| Repeat track | Repeat current track. |
| Repeat disc  | Repeat entire disc.   |

## To repeat between two positions

- Press **A-B (Function Repeat)** on the remote) at the start of the section you want to repeat.

The display shows:

Repeat A-

- Move to the end of the section you want to repeat.
- Press **A-B (Function Repeat)** on the remote) again.

The display shows:

Repeat A-B

The section you have specified will be played repeatedly.

## To cancel A-B repeat

- Press **A-B**.

## To cancel the repeat function

- Press **Repeat** (remote or under the front panel) again.

## Scanning a disc

The scan controls allow you to move quickly to any position on the disc at either twice or eight times normal speed.

### To scan through a disc

- Press ►► or ◀◀ (remote or under the front panel) to select twice normal speed.
- Press ►► or ◀◀ again to select eight times normal speed.

The display will show you the position on the disc.

For example:



- Press ► (front panel or remote) when you have reached the position you want to play.

Alternatively press ►► or ◀◀ again from eight times normal speed to return to normal playback.



## Programming a selection

You can programme a selection of tracks and then play only the tracks you have programmed.

You can programme a selection either by storing the tracks you want to play, or by clearing the tracks you do not want to play. If you programme a selection by storing the tracks you want to hear, you can play the tracks in any order and repeat tracks in the sequence.

You can programme a selection while the disc is playing, in which case the selection will be played after the current track finishes.

### To choose a track to programme

- Press **◀** or **▶** (front panel or remote) to step through the track numbers until the track you want is displayed, or type the number of the track you want.

### To make a selection by adding tracks

- Choose the first track you want to play, as described above.

The display will show the track number.

For example:



- Press **Store** (remote or under the front panel).

The track will change from **Track** to **Store**, and all the other tracks will be marked **Clear**.

For example:



You should store the first track for a selection within two seconds, or it will begin to play.

### To make a selection by omitting tracks

- Choose one of the tracks you do not want to play, as described above.

The display will show the track number.

For example:



- Press **Clear** (remote or under the front panel).

The track will change from **Track** to **Clear**, and all the other tracks will be marked **Store**.

For example:



You should clear the first track for a selection within two seconds, or it will begin to play.

### To add or remove a track from a selection

- Select the track using **◀** or **▶** (front panel or remote).

Alternatively you can enter the track number using the remote.

- Press **Store** to add the track, or **Clear** to remove the track.

### To clear a programme

- Press **■** (front panel or remote) twice.

The display will show:



A programme is automatically cleared if you open the disc drawer, or press **Off**.

## Changing the absolute phase

You can use the remote to invert the absolute phase of the analogue output signal, which in some circumstances can give a noticeable improvement in realism.

### To display the phase setting

- Press **Phase (Function II)** on the remote).

The display will show: 

### To change the phase setting

- Press **Phase** again.

The display will show the new phase setting.

For example: 

# Changing the front-panel display

The 808.2 Signature Reference CD Player displays information about the current disc and settings on the 20-character front-panel display.

You can adjust the contrast and brightness of the front-panel display for optimum viewing, and choose what information is displayed.

## To change the contrast or brightness

- Press ► or ◀ (remote), until the display shows the current contrast or brightness.

For example:



- Press ▲ or ▼ (remote), to change the selected setting.

You can change the contrast or brightness between 0 and 15.

## To change the displayed information

- Press **Display** (remote or under the front panel).

Each time you press **Display** the display will step between the following options:

| Display option                             | Initial value in Type 1 |
|--|-------------------------|
| Track and elapsed time                     | 1 68:57                 |
| Sampling rate, precision, and audio format | 44k1 16Bit LPCM CD      |
| Blank                                      |                         |

If the **Diagnostic displays** option has been selected, additional diagnostic displays are included; see the *Meridian Configuration Program Guide*.



# Using the CD player preamplifier features

The 808.2i version of the 808.2 Signature Reference CD Player includes a preamplifier, and can act as the controller for up to 11 other sources.

Both models feature an optional volume control for the analogue inputs.

This chapter explains how to use these features from either the front panel or the MSR+.



## Selecting a source

If you are using the 808.2i Signature Reference CD Player as a controller you can connect up to 11 other sources to it, and select them from the front panel or remote.

The CD player provides the following 12 sources:

CD, Radio, DVD, Aux, Disc, Tape, TV, Cable, Sat, VCR1, VCR2, and Game.

The CD source usually corresponds to the internal drive.

The input associated with each of the other sources depends on how the CD player has been set up; for more information refer to the *Meridian Configuration Program Guide*.

*Your installer may have customised the labels displayed for each source to suit your other equipment.*

### To select a source

- Press **Source** (under the front panel) until the display shows the source you want, or press the appropriate source key on the remote; eg **CD**.

The display shows the source and volume setting.

For example, if you select the Radio source:

The display shows:

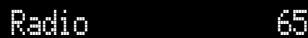

Radio 65

*The 808.2 CD player mutes the sound while you change source.*

# Adjusting the system volume

The 808.2 Signature Reference CD Player provides an optional volume control on the analogue outputs, enabling it to drive amplifiers or active loudspeakers directly, and you can adjust the volume using the front panel or remote.

The volume changes in precise steps of 1dB, where 9dB is equivalent to doubling the loudness. The current volume setting is displayed in dB on the front-panel display, and can be varied in the range 1 to 99dB.

## To change the volume

- Press **Volume ▲** or **Volume ▼** (under the front panel), or the red **▲** or **▼** keys on the remote.

As you adjust the volume setting the display shows the current volume level.

For example:



## To mute the sound

- Press **Mute** (remote or under the front panel).

The display shows:



## To restore the sound

- Press **Mute** again.

Alternatively, the sound will be restored if you adjust the volume.

## Changing the balance

### To change the balance

- Press ◀ or ▶ (remote) until the display shows the current balance.

For example:

A rectangular display area with a black background and white text. The text reads "CD Balance &lt;0&gt;" in a monospaced font. The "0" is centered between two angle brackets.

- Press ▲ or ▼ (remote) to move the listening position.

The display shows the direction and position of the listening position.

For example:

A rectangular display area with a black background and white text. The text reads "CD Balance &lt;3" in a monospaced font. The "3" is centered between two angle brackets.

The arrow indicates the direction, and the number indicates the position where 0 is central, 8 is in line with the corresponding main speaker, and 10 is fully to one side.



# Installing the CD player

This chapter explains how to install the 808.2 Signature Reference CD player. It describes what you should find when you unpack the product, and how you should connect it to the other equipment in the system.

You should not make any connections to the product or to any other component in the system while the AC power supply is connected and switched on.



# Unpacking

The 808.2 Signature Reference CD Player is supplied with the following accessories:

- MSR+ remote control with batteries, manual, and spare key caps.
- Meridian Comms lead.
- Power cord.
- This manual.

If any of these items are missing please contact your dealer.

**NOTE:** You should retain the packaging in case you need to transport the unit.

## Back panel

The following diagram gives details of the back panel connections:

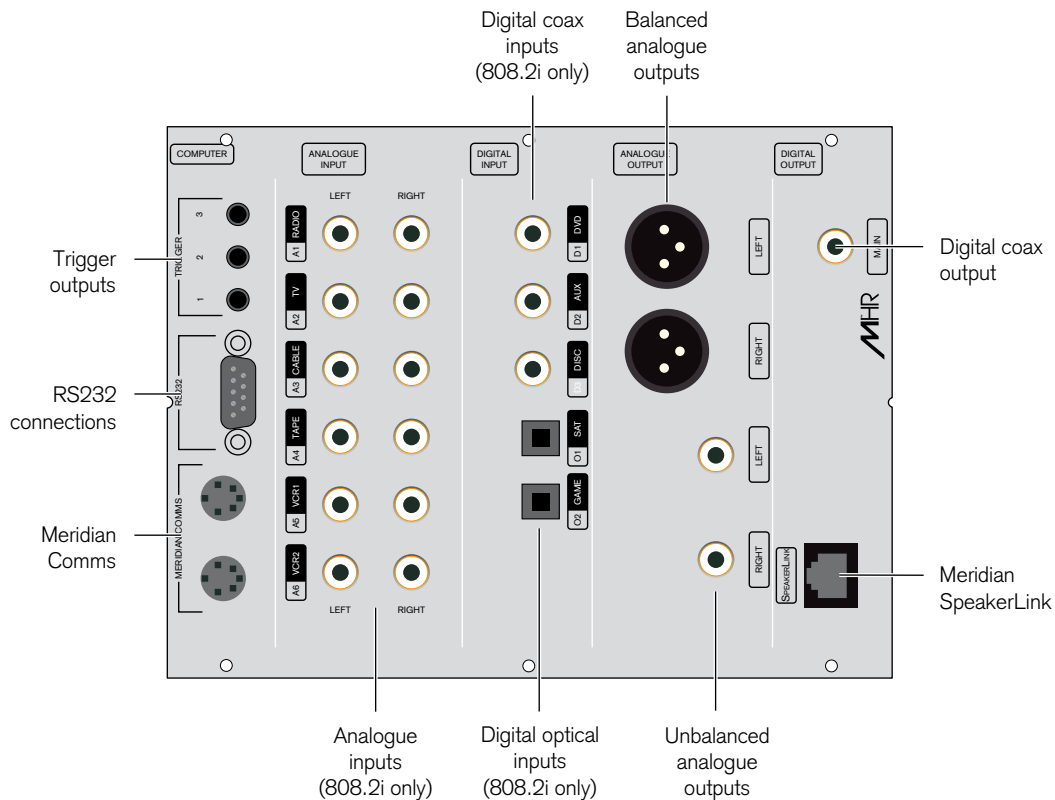

## Audio outputs

| Use this output         | To connect to this   |
|-------------------------|--|
| BALANCED OUT            | The balanced analogue inputs of a preamplifier, or a power amplifier such as the G57, using XLR leads.   |
| ANALOGUE OUT            | The unbalanced analogue inputs of a preamplifier, or a power amplifier such as the G57, using analogue phono leads.                                |
| DIGITAL OUT             | The digital input of a surround processor, such as the 861 Reference Digital Surround Controller, or DSP loudspeakers, using a 75Ω digital cable.  |
| MERIDIAN<br>SPEAKERLINK | DSP Loudspeakers with Meridian SpeakerLink connectors, using a Meridian SpeakerLink lead. Alternatively a standard CAT5 network cable may be used. |

## Communications connections

| Use this connection       | To connect to this  |
|---------------------------|---|
| MERIDIAN COMMS            | Other Meridian G Series, 500 Series, or 800 Series equipment, or Meridian DSP loudspeakers. |
| RS232 connection          | A computer, for configuring the CD player.  |
| TRIGGER OUTPUT<br>1, 2, 3 | Equipment that can be triggered by a 12V 100mA signal.                                      |

## Audio inputs (808.2i only)

| Use this input   | To connect to this   |
|--|--|
| ANALOGUE IN A1 (Radio), A2 (TV), A3 (Cable), A4 (Tape), A5 (VCR1), A6 (VCR2) | The analogue outputs of a source, such as a TV or tape deck. |
| DIGITAL INPUT D1 (DVD), D2 (Aux), D3 (Disc)                                  | The digital output of a source such as a DVD player.         |
| OPTICAL INPUT O1 (Sat), O2 (Game)  | The optical output of a source such as a satellite receiver. |

The default assignment of the source to each input is shown in brackets after the input name in the above table. CD corresponds to the internal CD player.

# Applications

## To connect to an analogue preamplifier (Type 1 or 2)

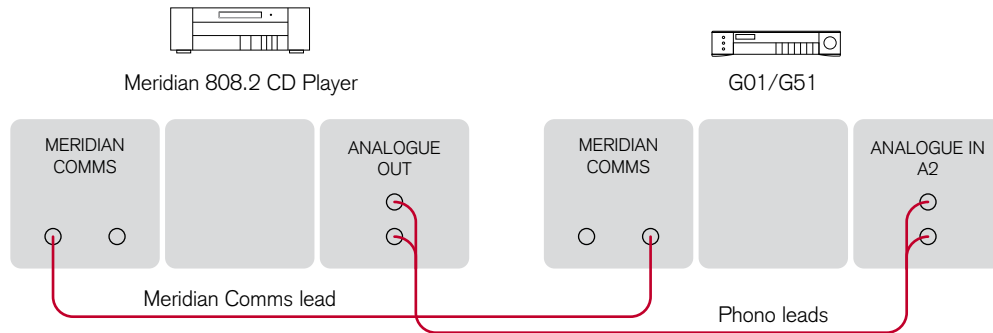

Connect the balanced or unbalanced analogue outputs to the appropriate inputs on the preamplifier.

- If the preamplifier is a Meridian product, such as a G02, connect together the COMMS sockets using the Comms lead provided.
- Configure to Type 1 if using an 808.2 or 808.2i with no external inputs, or Type 2 for an 808.2i with other inputs in use; see *Choosing a standard setting*, page 30.

## To connect to an 861 Reference Digital Surround Controller (Type 1 or 2)

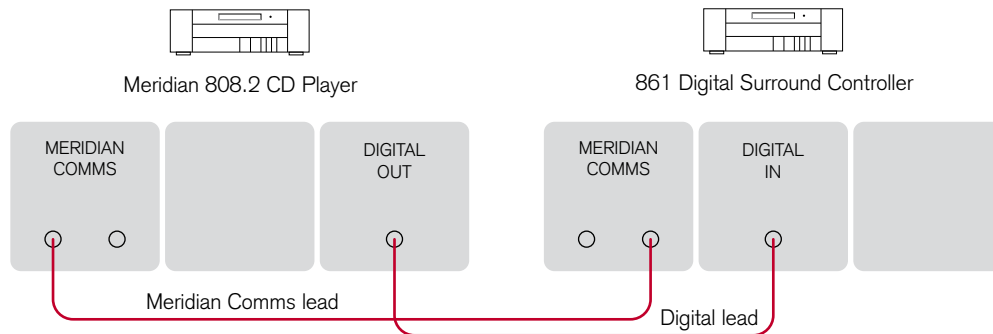

- Connect the DIGITAL output from the 808.2/808.2i to a suitable Digital input on the digital surround controller, using a digital lead.
- Connect together the COMMS sockets using the Comms lead provided.
- Configure to Type 1 if using an 808.2 or 808.2i with no external inputs, or Type 2 for an 808.2i with other inputs in use; see *Choosing a standard setting*, page 30.

## To connect to two-channel DSP loudspeakers using SpeakerLink (Type 1 or 2)

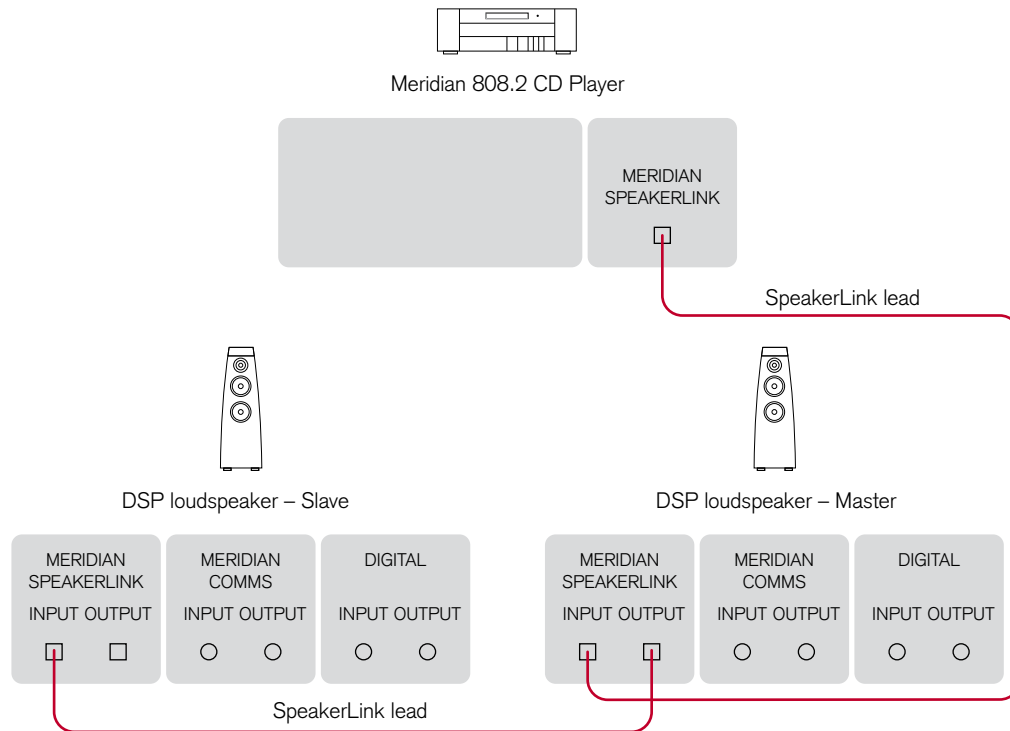

The 808.2/808.2i can be connected directly to Meridian DSP loudspeakers to create a complete compact stereo system, with volume and other preamplifier controls provided by the loudspeakers via the MSR+ or the front panel. The 808.2i provides additional analogue and digital inputs allowing you to use it to control the other sources in your system.

The Meridian SpeakerLink connection provides both two-channel digital audio and Meridian Comms control.

- Connect the SpeakerLink output from the CD player to the SpeakerLink input on the DSP loudspeaker chosen as the master, using a SpeakerLink lead.
- Connect the SpeakerLink output from the master DSP loudspeaker to the SpeakerLink input on the other (slave) DSP loudspeaker, using a second SpeakerLink lead.
- Configure the loudspeakers as described in the *Meridian DSP Loudspeaker User Guide*.
- Configure to Type 1 if using an 808.2 or 808.2i with no external inputs, or Type 2 for an 808.2i with other inputs in use; see *Choosing a standard setting*, page 30.

## To connect to two-channel DSP loudspeakers using the digital and Comms connections (Type 1 or 2)

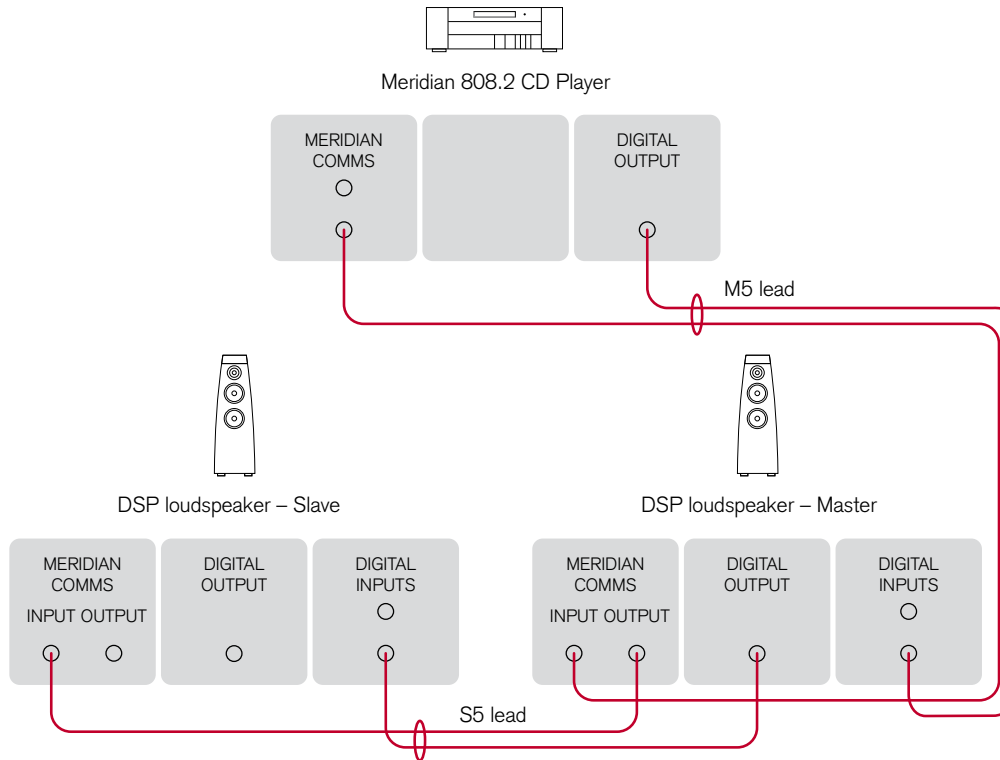

If your DSP loudspeakers do not provide Meridian SpeakerLink connections you can connect to them using the Digital and Meridian Comms connections.

- Connect the DIGITAL OUTPUT and a COMMS socket from the CD player to DIGITAL INPUT 1 and the COMMS input on the DSP loudspeaker chosen as the master, using an M5 lead.
- Connect the DIGITAL and COMMS outputs from the master DSP loudspeaker to DIGITAL INPUT 1 and the COMMS input on the other (slave) DSP loudspeaker, using an S5 lead.
- Configure the loudspeakers as described in the *Meridian DSP Loudspeaker User Guide*.
- Configure to Type 1 if using an 808.2 or 808.2i with no external inputs, or Type 2 for an 808.2i with other inputs in use; see *Choosing a standard setting*, page 30.

## To connect the 808.2/808.2i to a power amplifier (Type 0 or 3)

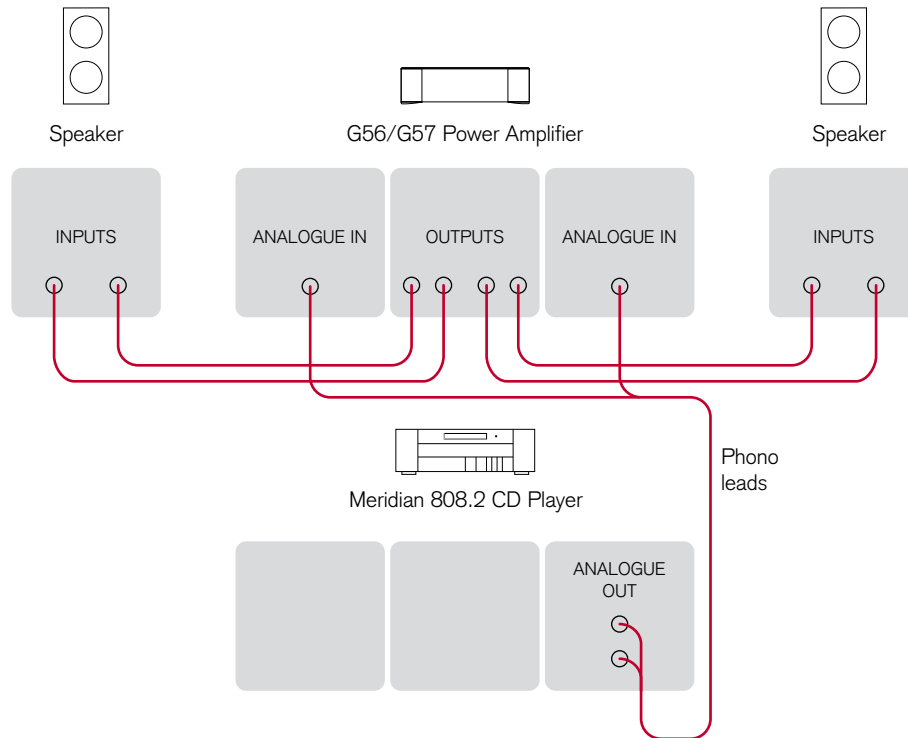

The 808.2 includes an integrated preamplifier, allowing you to connect it directly to a pair of analogue active loudspeakers, or to analogue passive loudspeakers via a power amplifier such as the G56 or G57.

- Connect the ANALOGUE OUTPUT connections from the CD player to the inputs of the analogue active loudspeakers or power amplifier, using phono leads.
- If you are using an 808.2i connect your other sources to the appropriate inputs.
- Configure to Type 0 if using an 808.2 or 808.2i with no external inputs, or Type 3 for an 808.2i with other inputs in use; see *Choosing a standard setting*, page 30.

## To connect to other Meridian G Series or 800 Series equipment

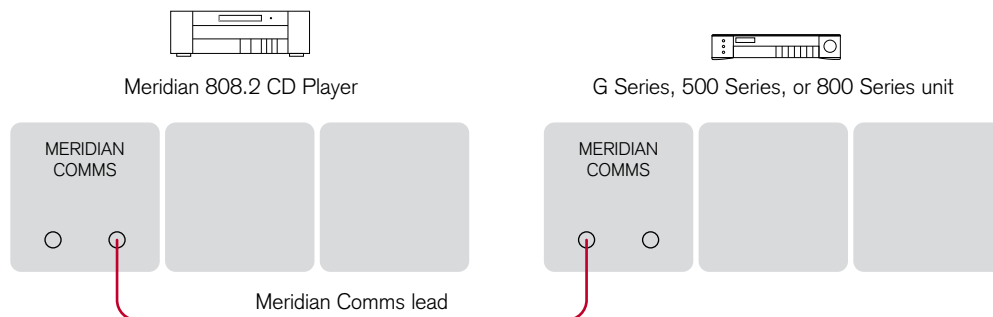

In a system of Meridian products, one of the products acts as the controller for the system, receiving infra-red commands from the MSR+ and then, if appropriate, relaying them to the other products via the Comms link.

The following automatic setup procedure should be used to set up the Comms correctly between several products:

- Connect one of the DIN COMMS sockets on the back panel of the CD player to one of the COMMS sockets on another G Series, 500 Series, or 800 Series unit, using the Comms leads provided with the products.

The sequence in which you connect the units is not important.

- Switch all the units to standby.
- Press **Clear** (remote).

Each unit will display: **Auto**

One unit will then be designated as the controller.

The display shows: **Controller**

All the other units will be configured as non-controllers.

The displays show:

**Not Con.**

If for any reason the automatic setup does not work, make sure you are operating the remote from a position where all the units can receive the infra-red, and try again.

If this fails:

- Restore the default operation by selecting one of the standard types; see *Choosing a standard setting*, page 30.

*Do not, under any circumstances, connect any equipment other than Meridian G Series or 800 Series to any socket marked COMMS on the back of the product.*



# Configuring the CD player

This chapter explains how to set up the 808.2 Signature Reference CD Player for most standard configurations of your other equipment, using just the front-panel controls and MSR+.

For complete control over all aspects of the CD player's configuration it is recommended that you set up the unit using the Meridian Configuration Program; for full information see the *Meridian Configuration Program Guide* available separately.



## Choosing a standard setting

The CD player provides several sets of standard settings, called Types, which configure all aspects of the 808.2 into one of a number of alternative standard configurations.

Types 0 to 3 are factory settings, designed to cater for the most commonly needed configurations of associated equipment.

These standard Types are shown in the following table:

| Type | Description  |
|------|--|
| 0    | CD player, variable output, all sources internal.                                  |
| 1    | CD Player, fixed output, all sources internal.                                     |
| 2    | Preamplifier, fixed output, CD internal, all other sources external (808.2i only). |
| 3    | Preamplifier as above but variable output (808.2i only).                           |

In addition, your installer may have provided one or more named User Types, with settings appropriate to the configuration of equipment when your 808.2 was installed.

You can reset the configuration of the CD player to any of these Types to restore it to the state it was in when it was installed. **Note:** Selecting a Type will clear any configuration changes you have made.

### To select a standard setting

**Warning: this procedure will reset any configuration changes you have made.**

- Switch off any power amplifiers that are connected to the 808.2 and put any digital speakers into standby.
- Put the CD player into standby by pressing **Off** (front panel or remote).
- Press and hold down **Volume ▲** (under the front panel).

The display shows:

Type in... 3

- Keep holding down **Volume ▲** for a further three seconds.

The display shows:

Type- please wait

Then after a short delay the display shows the current Type.

For example:

Type 1

- Press **▲** or **▼** on the front panel to change the Type number.

The display shows:

Typing, please wait

- Wait for one second, and then put the CD player into standby by pressing **Off** (front panel or remote).
- Switch on again to use the standard settings you have selected.

# Setting up sources

This section explains how to use Gain mode to set up the analogue sources connected to the CD player.

## To turn on Gain mode

- Put the CD player into standby by pressing **Off** (front panel or remote).
- Press and hold the **Volume ▼** key under the front panel for at least five seconds.

The display shows: 

The CD player will then return to standby with Gain mode turned on.

Gain mode adds an extra **Sensitivity** option to the menus.

## To turn off Gain mode

- Repeat the above procedure.

The display shows: 

## To adjust the sensitivity of a source

To obtain the best signal-to-noise ratio for your analogue sources you can adjust the sensitivity of each input to give the highest level that does not produce clipping.

- Turn on Gain mode, as described above.
- Select the source you want to adjust, with loud source material playing.
- Press ◀ or ▶ (remote) until the display shows the current sensitivity.

For example: 

- Press ▲ or ▼ (remote) to change the sensitivity.

You can select between sensitivities of 0.5V (most sensitive), 1.0V, 2.0V, or 2.5V (least sensitive).

If the sensitivity is set too high the input will clip the loudest passages. The display shows:

For example:



In this case reduce the sensitivity.

If you have selected a digital source you cannot adjust the sensitivity. The display shows:

For example:





# Index

## A

---

absolute phase 14  
 accessories 22  
 automatic setup 27  
 auxiliary output 22

## B

---

back panel connections 22  
 balance, changing 20  
 balanced outputs 22  
 brightness, front-panel display 15

## C

---

clip indicator 31  
 Comms, connecting 23, 26, 28  
 communications connections 23  
 configuring 29  
 connecting  
   to an 861 Reference Digital Surround Controller 24  
   to a power amplifier 27  
   to DSP loudspeakers 25, 26  
   to Meridian G Series, 500 Series, or 800 Series equipment 28  
 continuing play 10  
 contrast, front-panel display 15

## D

---

display, front panel 15  
 DSP loudspeakers  
   connecting via SpeakerLink 25  
   connecting via the digital and Comms connectors 26

## F

---

front panel keys 6

## G

---

Gain mode 31

## I

---

inputs 23

## M

---

Meridian Digital Surround Controller, connecting to 24  
 Meridian DSP loudspeakers, connecting to 25, 26  
 Meridian System Remote keys 7  
 muting the sound 19

## O

---

outputs 23

## P

---

pausing play 10  
   continuing after pausing 10  
 phase  
   changing 14  
   reviewing 14  
 playing a disc 9  
   from a particular track 9  
   repeatedly 11  
 preamplifier features 17  
 programming a selection 13  
   clearing 13

## R

---

repeating play 11  
   cancelling 11  
 restarting the current track 9  
 RS232 connection 23

## S

---

safety warnings ii  
 scanning a disc 12  
 selections  
   adding a track 13  
   clearing 13  
   programming 13  
   specifying tracks not to play 13  
 sound, muting 19  
 sources 18  
   adjusting sensitivity 31  
   selecting 18  
 SpeakerLink 23  
   connecting with 25  
 specification 3  
 standard settings, selecting 30  
 standby, switching to 8  
 stopping play 10  
 switching on and off 8

## T

---

tracks  
   playing from a particular track 9  
   restarting the current track 9  
 trigger outputs 23  
 Types 30

**U**

---

unpacking 22

**V**

---

volume, adjusting 19

## Free Manuals Download Website

<http://myh66.com>

<http://usermanuals.us>

<http://www.somanuals.com>

<http://www.4manuals.cc>

<http://www.manual-lib.com>

<http://www.404manual.com>

<http://www.luxmanual.com>

<http://aubethermostatmanual.com>

Golf course search by state

<http://golfingnear.com>

Email search by domain

<http://emailbydomain.com>

Auto manuals search

<http://auto.somanuals.com>

TV manuals search

<http://tv.somanuals.com>