

MESA/BOOGIE
BASIS M • 2000
OWNER'S MANUAL

The Spirit of Art in Technology



1317 Ross Street Petaluma, CA 94954
USA

Hello from the Tone Farm...

Congratulations on your choice of the BASIS M-2000 as your amplifier and welcome to the MESA/Boogie family! As a discriminating player you probably know that you have purchased the most comprehensive instrument for amplifying bass that is available. What you might not realize is that this entitles you to all the experience, resources and commitment our twenty-five years of service to musicians world wide has to offer. Our responsibility is to help you sound great! So, if at any time you feel you need help or direction, we are here for you...a phone call away.

BASIS M·2000

TABLE OF CONTENTS

Precautions

Overview

Page # 

FRONT PANEL	Description	1
Initial Set-Up — Connect Speaker / Foot Controller / Choose Switching Logic		2
Output Level Control (Adjusting Listening Level)		2
Select Instrument Inputs		2
VACUUM TUBE CHANNEL		
Set Rotary Tone Controls & Graphic E.Q. — Setting Mini-Toggles		3
Set Compressor, Threshold & Frequency — Set Listening Level		3
Set Bright & Normal Switch 9 Band EQ		4
Compressor		4
FIELD EFFECT CHANNEL		
Set Rotary Controls & Graphic E.Q.		4 & 5
Tunable Bass Control — Set Mini Toggles		5
Set Compressor Threshold & Frequency — Set Master Control		5
Set Bright Normal Switch — 9 Band EQ — Compressor		6
Settings Thus Far — Mix Mode Select — Mix Mode Blend Control		7
Mixing A Distortion & Clean Sound		8
Graphic E.Q. Mix Assign		8
REAR PANEL	Description	9
Channel Select		9
Footswitch Function Assign		9
Balanced Output / Balanced Level		9 & 10
Footswitch Control		9
Effects Loop		10 & 11
Speaker Out		11 & 12
External Select — Fuse — A.C. Receptacle		12
Sample Settings... <i>Personal, Field Effect Ch. and Vacuum Tube Ch.</i>		13 - 14 - 15
Parts Sheet		16

Your MESA/Boogie Amplifier is a professional instrument. Please treat it with respect and operate it properly.

USE COMMON SENSE AND ALWAYS OBSERVE THESE PRECAUTIONS:

- Do not expose amplifier to moisture, rain or water, direct sunlight or extremely high temperatures.
- Always insure that amplifier is properly grounded.
- Always unplug AC power cord before changing fuse or any tubes.
- When replacing fuse, use only same type and rating.
- Avoid direct contact with heated tubes.
- Insure adequate air circulation behind amplifier.
- Keep amplifier away from children.
- Be sure to connect to an AC power supply that meets the power supply specifications listed on the rear of the unit.
- If there is any danger of lightning occurring nearby, remove the power plug from the wall socket in advance.
- To avoid damaging your speakers and other playback equipment, turn off the power of all related equipment before making the connections.
- Do not use excessive force in handling control buttons, switches and controls.
- Remove the power plug from the AC mains socket if the unit is to be stored for an extended period of time.
- Do not use solvents such as benzene or paint thinner to clean the unit. Wipe off the exterior with soft cloth.

YOUR AMPLIFIER IS LOUD! EXPOSURE TO HIGH SOUND VOLUMES MAY CAUSE PERMANENT HEARING DAMAGE!

No user serviceable parts inside. Refer service to qualified personnel. Always unplug AC power before removing chassis.

EXPORT MODELS: Always insure that unit is wired for proper voltage. Make certain grounding conforms with local standards.

READ AND FOLLOW INSTRUCTIONS OF PROPER USAGE.

OVERVIEW

For ease of understanding the **M-2000** and to reduce the intimidation factor that one might experience upon first glance, it should be noted that the unit may be digested one channel at a time. The only shared controls on the entire front panel are the MIX control and the Output Level control. Thinking of the **M-2000** as two completely separate pre-amplifiers - sharing one common power section, may help you to understand it at a faster rate.

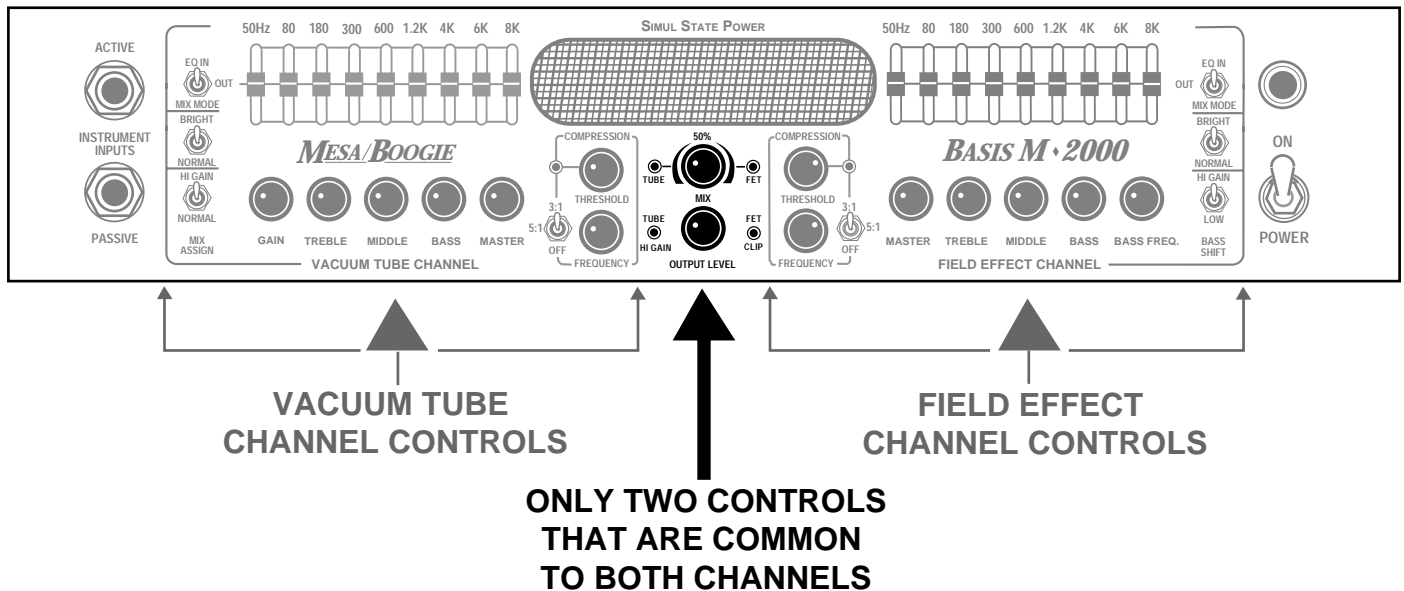

NOTE You may be much too excited about playing your new toneship to spend the time now to read this manual cover to cover explaining the **M-2000's** many controls and features. For those of you with the most serious tone "jones" we've included this B-Line to great Bass sound. By all means...ENJOY! So that you get the most from your **M-2000** for years to come, please take the time and read this manual at some point. It contains information that you will need to know in order to optimize the **M-2000's** performance so that it can, in return, catapult your playing to a new level of inspiration.

INSTANT GRATIFICATION (DEMO)

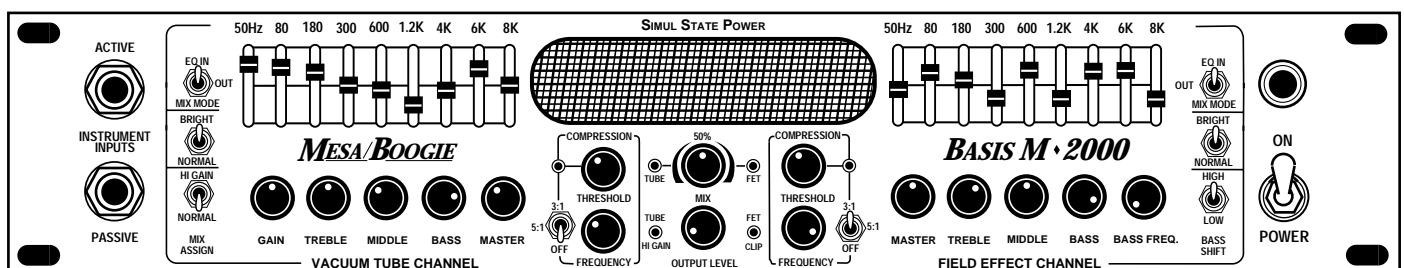

BASIS M • 2000

Description:

By now you see the **M-2000** houses two completely different pre-amplifiers, one all tube, one FET. These may be footswitched between and/or combined by utilizing the Mix Mode, in which any blend of the two may be created. The Tube Channel offers the choice of a normal (low gain) mode operation and an all tube Hi Gain overdrive mode for wilder applications. Each of these pre-amps offers the full array of rotary style tone controls, producing a rich, warm blend...fast! Each Channel may then be further customized by engaging its own nine band graphic equalizer. These channel specific EQ's may be triggered in three ways: 1. Via the front panel's mini toggle switch 2. Via the foot controller and 3. Programmed to engage in the Mix Mode automatically. Both EQ's, as well as the modes, can be triggered remotely by using most tip to ground switches, such as the kind found on many Master Rack Control systems. These ports appear as 1/4 inch jacks found on the rear panel in the External Select section.

Each channel also houses a Frequency Activated (shelving type) Compressor that can be bypassed or applied in 3:1 and 5:1 ratios. The **M-2000** is fitted with a parallel effects loop with a crossover enabling frequency specific effect placement as well as a dry/wet blend control. This loop may be assigned to auto engage in any or all of the modes as well as bypassed. This crossover can also be used to send a pre-amp signal of a selected frequency to another power amplifier for bi-amping. A Balanced Output with pre and post EQ positions and a level control is provided for recording or live sound reinforcement applications. An output for a Tuner is included and may be triggered remotely by the Gain switch on the Foot Controller.

The **M-2000's** Simul-State power section feeds two mono 1/4 inch jacks or two 3-pin XLR jacks to deliver a robust 600 Watts RMS into 4 Ohms which is the recommended load. The toneful Simul-State circuit uses a 12AX7 driver tube to feed the power block of 12 high quality mosfets. This design boasts the smooth warmth found in all tube circuits and the tight, immediate response often associated with solid state amplification. As you can see, the **M-2000** has all the needed features to elevate your playing to new plateaus, yet it remains simple and straightforward to use. The following is an explanation of the controls and a few setting examples.

CAUTION: NEVER BLOCK AIR VENT

FRONT VIEW BASIS M-2000

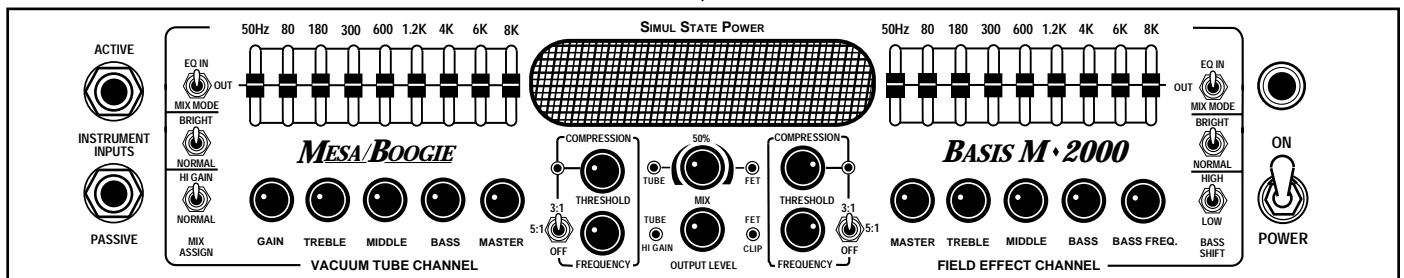

REAR VIEW BASIS M-2000

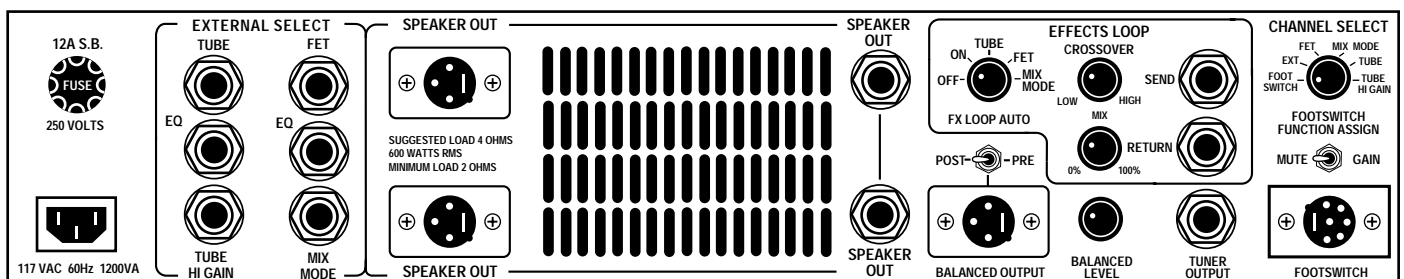

INITIAL SET-UP

CONNECT SPEAKER

First connect the *M-2000* to your favorite speaker cabinet using either the 1/4 inch jacks or the 3-pin XLR's. **The recommended load is 4 Ohms.**

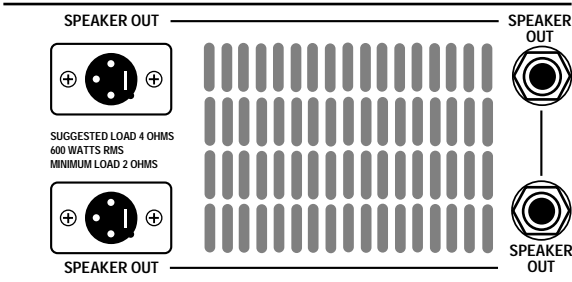

CONNECT FOOT CONTROLLER

Then connect the *M-2000's* Foot Controller to its 6-Pin Male XLR Jack.

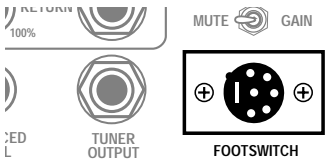

CHOOSE SWITCHING LOGIC

Select FOOTSWITCH with the rotary control. (If the Foot Controller is not available, use the rotary control to select the channels during this exercise.)

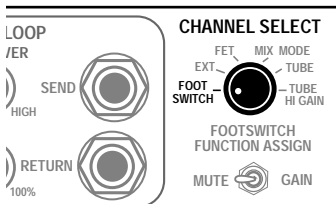

OUTPUT LEVEL CONTROL

Important... Set the Output Level Control located in the center of the front panel to 0. (7 O'Clock)

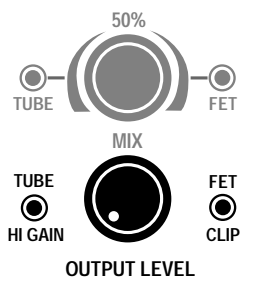

SELECT INSTRUMENT INPUT

Connect your instrument to the appropriate Input jack (Active or Passive.) If your instrument incorporates a pre-amp which uses a battery for power, you will probably want to use the Active Input Jack. Most other instruments should work well with the Passive Input.

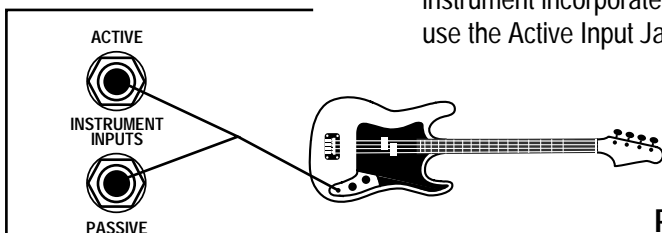

VACUUM TUBE CHANNEL

ROTARY CONTROLS & GRAPHIC EQ

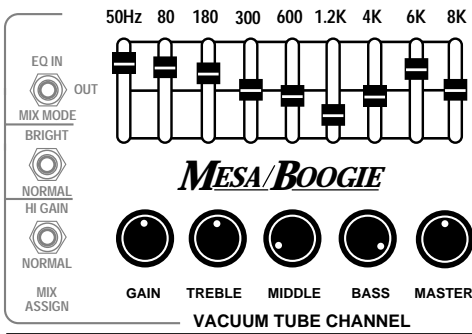

Select the VACUUM TUBE CHANNEL using the footswitch labeled TUBE on the Foot Controller and set the controls as per this example.

NOTE The *M-2000* automatically returns to the mode that was last used upon power-up, (when the Channel Select rotary switch is set to Footswitch.) When the Foot Controller is not being used, the *M-2000* will power-up with the mode chosen on the Channel Select rotary switch.

MINI TOGGLES

Locate the 3 mini toggle switches on the left side of this channel and set to these positions.

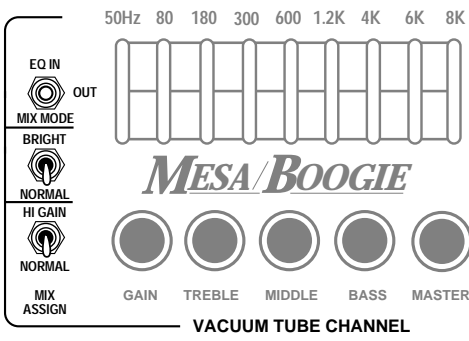

COMPRESSOR THRESHOLD & FREQUENCY

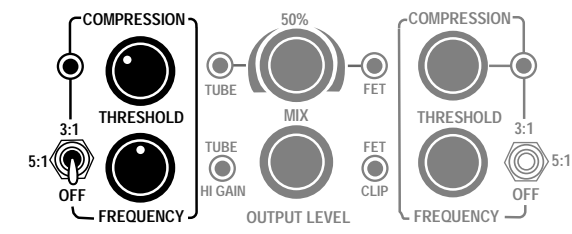

Set the Vacuum Tube Channel's Compressor Threshold and Frequency Controls per this example, while leaving the Ratio toggle switch in the OFF (down position.)



LISTENING LEVEL

With your instrument connected to the proper Input jack (Passive or Active,) SLOWLY bring up the volume with the Output Level control while playing a note.

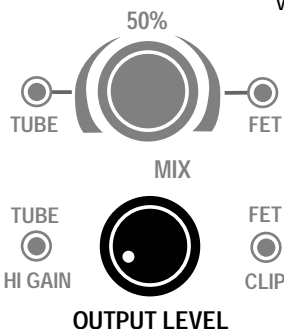

NOTE Use care as this control is capable of unleashing substantial power which can result in either speaker or hearing damage.

BRIGHT / NORMAL SWITCH

While playing an open string, activate the **BRIGHT / NORMAL** switch to the  (up position.)

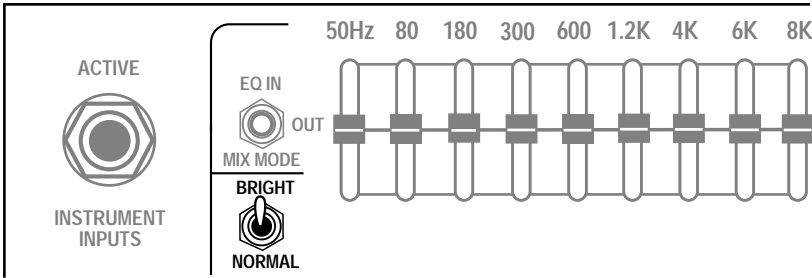

Become familiar with the frequencies that this switch enhances as it works along side the Graphic Equalizers' top 3 bands (4 - 6 - & 8K) to bring out the upper harmonics and sparkle.

9 BAND EQ

Set the Tube Channel's 9 Band Equalizer per this example (if you have not done so) and activate it by using the 3 position mini toggle switch  (up position.)

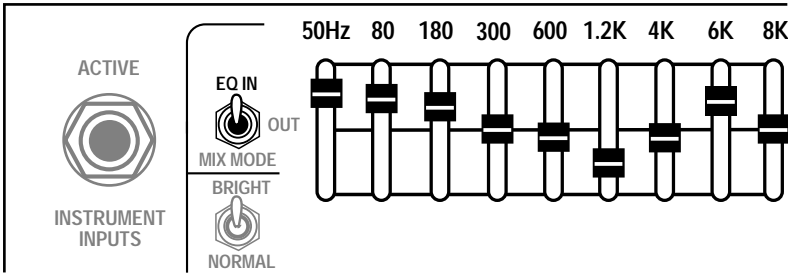

To activate the 9 Band Equalizer via the Footcontroller, you must have the front panel 3 position mini toggle switch in the OUT position or in the MIX MODE position. There are two of these switches, one per channel located to the right and left respectfully. When the E.Q. 3 position switch is in the MIX MODE, the E.Q. will automatically be engaged.

COMPRESSOR

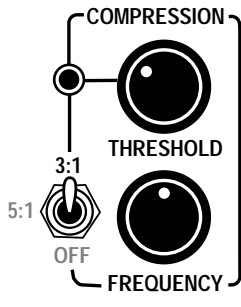

Turn on the Compressor by selecting the 3:1 position on the face panel of the *M-2000*. With the Threshold set per the example to the left, play a low note and sweep the Frequency control clockwise. You will notice less compression as you pass 12 O' clock until there is none at all. Now reverse this procedure. Play a high note (you may have to change the Threshold to maximize the effect for this test) and sweep the Frequency control counter-clockwise. As you pass 12 O' clock you will again hear the compression effect lessen. This "Shelving" (frequency specific) control allows the compression of the low frequencies without affecting the high frequencies and similarly the opposite. **To compress the lows and highs equally, set the Frequency control straight up to 12 O' clock and adjust the Threshold control accordingly.** Select the 5:1 ratio position for a much "thicker" compression. Remember that the Threshold setting is crucial to obtaining a usable, musical compression setting. Following the same procedure, we will run through the Field Effect Channel.

FIELD EFFECT CHANNEL

ROTARY CONTROLS & GRAPHIC EQ

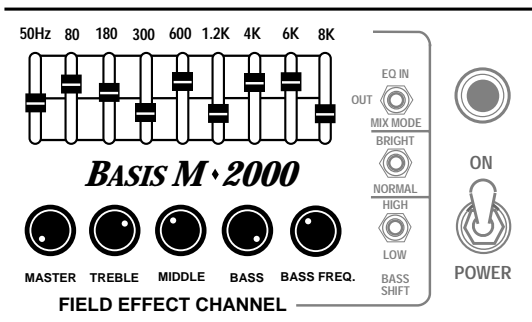

Set the FIELD EFFECT CHANNEL rotary controls and the 9 Band Graphic E.Q. per this example, **making sure that the FET channel's MASTER control is set to zero.** You will notice there is no Gain control in this channel. This was done to make room for a different tone control wiring scheme. The FET channel's Treble and Mid are wired in the same fashion as that of the Tube channel (though they may seem to enhance different frequencies because of the very nature of the FET design.) The Bass controls are where the similarity ends.

TUNABLE BASS CONTROL

In this channel the bass frequencies are shaped utilizing a pair of parametric type controls.

NOTE When switch is in the "Down" position the controls, **BASS** and **BASS FREQ.**, shape and control frequencies from 30Hz to 100Hz.

NOTE When switch is in the "Up" position the controls, **BASS** and **BASS FREQ.**, shape and control frequencies from 100Hz to 200Hz.

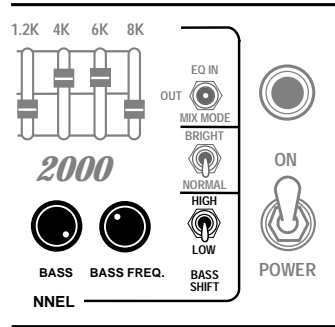

Two rotary controls, Bass and Bass Frequency enable you to center in on the region of lows that you wish to enhance and boost or cut them to your desire. Just to the right of these two controls there is a mini-toggle switch that enables you to "Shift" the region of bass that the Bass Frequency rotary control affects.

As you might have guessed, **this mini-toggle switch lowers the action of the control when in the down position and shifts the region up higher when the toggle is in the up position.** So that you have complete control of the entire range of low frequencies, the Low and High ranges of the Bass Shift overlap at 100Hz.. This overlap occurs at 5:30

(fully cranked) on the Bass Frequency control when the Bass Shift switch is in the Low position. When the Shift is switched to High you will find this 100Hz. overlap at 7:30 (all the way down) on the Bass Frequency control. This difference in Bass controls in the FET channel is crucial to its tighter attack and cut-off point characteristics, which is an integral part of the FET channel's personality...making it strikingly different in nature to the Vacuum Tube channel.

MINI TOGGLES

Locate the 3 mini toggle switches on the right side of this channel and set to these positions.

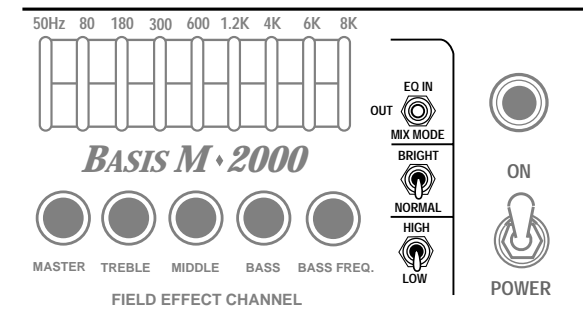

COMPRESSOR THRESHOLD & FREQUENCY

Set the Field Effect Channel Compressor's Threshold and Frequency Controls per this example, while leaving the Ratio toggle switch in the OFF (down position.)

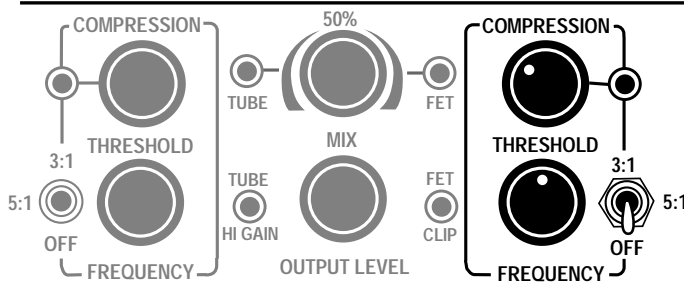

MASTER CONTROL

With your instrument still connected to the appropriate jack, **SLOWLY** bring up the FET channel's **MASTER** Control to the desired volume.

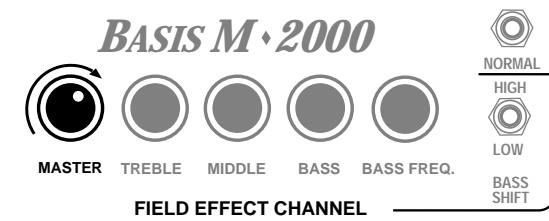

BRIGHT / NORMAL SWITCH

Again, play an open string and activate the Bright / Normal switch by selecting the (up position.)

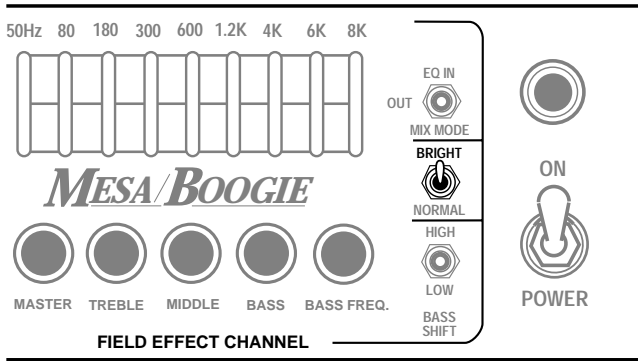

9 BAND EQ

Engage the 9-Band Graphic Equalizer

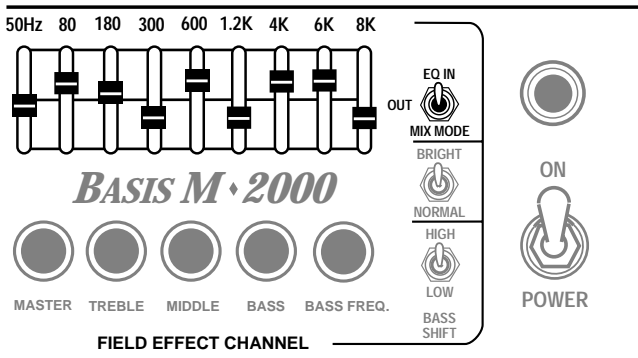

(toggle in the up position) and notice that though they are the same controls, they react differently because of the FET channel's personality.

To activate the 9 Band Equalizer via the Footcontroller, you must have the front panel 3 position mini toggle switch in the OUT position or in the MIX MODE position. There are two of these switches, one per channel located to the right and left respectfully.

When one of the E.Q. 3 position switches is in the MIX MODE, that E.Q. will automatically be engaged when the MIX MODE is selected.

COMPRESSOR

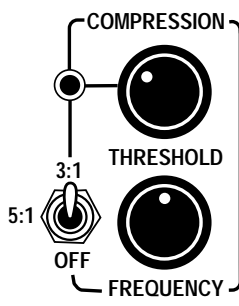

Turn on the Compressor by selecting the 3:1 position on the Face Panel of the *M-2000*. With the Threshold set per the example to the left, play a low note and sweep the Frequency control clockwise.

You will notice less compression as you pass 12 O' clock until there is none at all. Now reverse this procedure. Play a high note (you may have to change the Threshold to maximize the effect for this test) and sweep the Frequency control counter-clockwise. As you pass 12 O' clock you will again hear the compression effect lessen. This "Shelving" (frequency specific) allows the compression of the low frequencies without affecting the high frequencies and similarly the opposite.

To compress the lows and highs equally, set the Frequency control straight up to 12 O' clock and adjust the Threshold control accordingly. Select the 5:1 ratio position for a much "thicker" compression, remembering that the Threshold setting is crucial to obtaining a useful, musical compression setting.

VACUUM TUBE CHANNEL SETTINGS THUS FAR

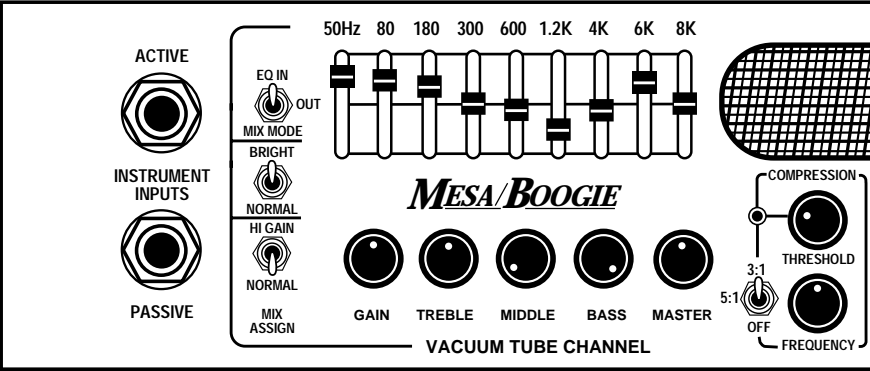

FIELD EFFECT CHANNEL SETTINGS THUS FAR

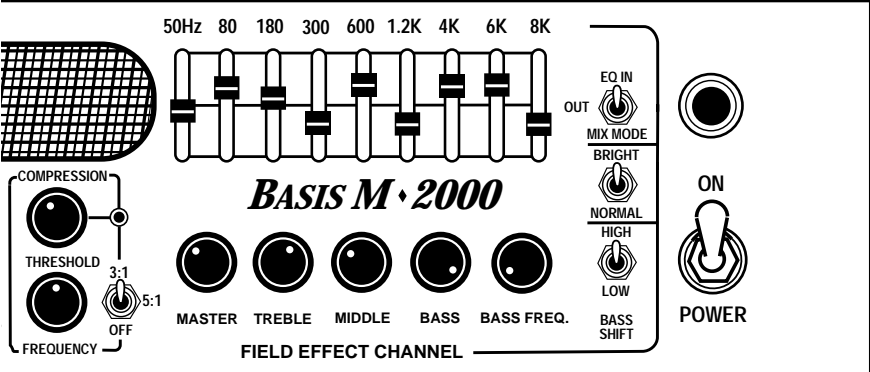

MIX MODE

MIX MODE SELECT

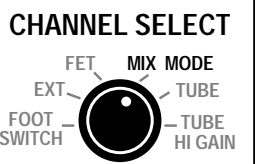

Engage the MIX Mode by triggering the MIX switch on the *M-2000* Foot Control panel. (If the foot controller is not available, use the rotary switch on the right side of the Rear Panel and select the MIX position.)

MIX MODE BLEND CONTROL

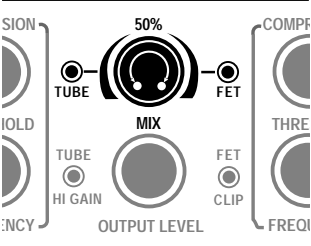

While playing a note on an open string, sweep the MIX Control from the center (Equal Blend of Tube and FET), to the left (100% Tube) and to the right (100% FET.) Between these three positions lie a myriad of unique and outrageous sounds that you will find yourself exploring for many years. The ability to combine two completely separate front end technologies allows you to "custom-build" the pre-amp of your *dreams*, by simply using the MIX Pan Pot.

The MIX Mode also makes possible a third footswitchable sound from a two channel layout that is distinctly different from either channel. Now that you have heard one possible way of using the MIX Mode, we encourage you to experiment and create some sounds of your own!

MIXING A DISTORTION and a CLEAN SOUND

Next, let's try mixing a distortion (or maybe just a slightly overdriven) sound from the VACUUM

TUBE CHANNEL with a tight clean sound from the FIELD EFFECT CHANNEL. While still in the MIX Mode, select the HI-GAIN setting of the MIX ASSIGN Switch in the TUBE Channel's lower left corner.

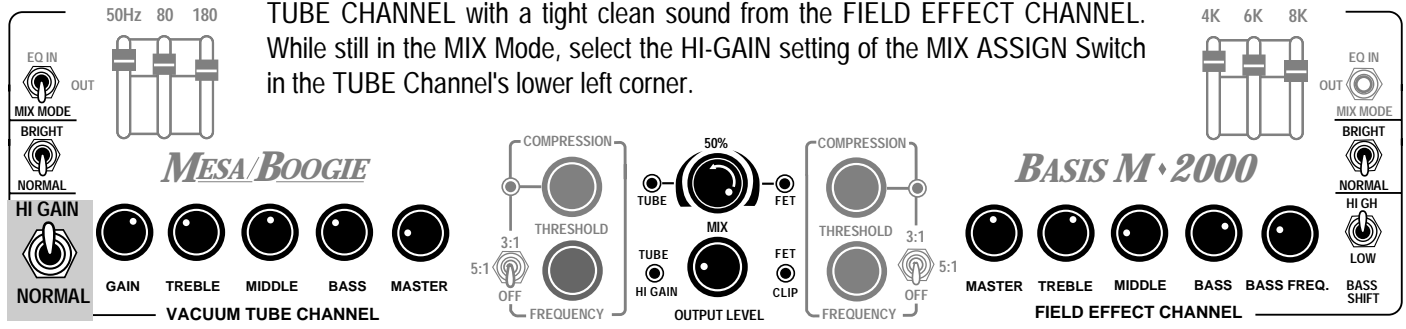

Set the controls in both channels to the setting shown in the above illustration. For this example, we have chosen a medium overdrive sound to audition. Select the MIX Mode (if you have not already done so.)

Start with the MIX Control panned hard right (100% FET) and sweep left. At slightly before 12:00, you will hear the overdrive from the TUBE Channel's HI-GAIN Mode start to come into the mix. Continue sweeping toward the TUBE Channel until the desired blend is reached. To adjust the amount of overdrive in the TUBE Channel, simply raise or lower the GAIN Control until you find the intensity (amount of distortion) that you desire.

NOTE It may be helpful to reduce the setting of the rotary BASS Control in the TUBE Channel when using the HI-GAIN Mode, especially with higher settings of the GAIN Control. High settings of these two controls simultaneously will often produce a flubby, indistinct attack. If you need more low frequencies when dialing up Hi Gain sounds, try using the lower bands (50 - 80 - & 180K) of the Graphic Equalizer as it occurs later in the signal path and is therefore less likely to be detrimental to the attack characteristic.

GRAPHIC E.Q. MIX ASSIGN

One or both 9 Band Equalizers may be automatically engaged when the MIX Mode is called up via the footswitch (or via the Rear Panel rotary switch.) Simply select the MIX ASSIGN (down position) of the 3 position E.Q. mini-toggle switch that is adjacent to each Equalizer and it will be activated automatically every time you choose the MIX Mode. Needless to say, this increases the sonic power of the MIX Mode exponentially.

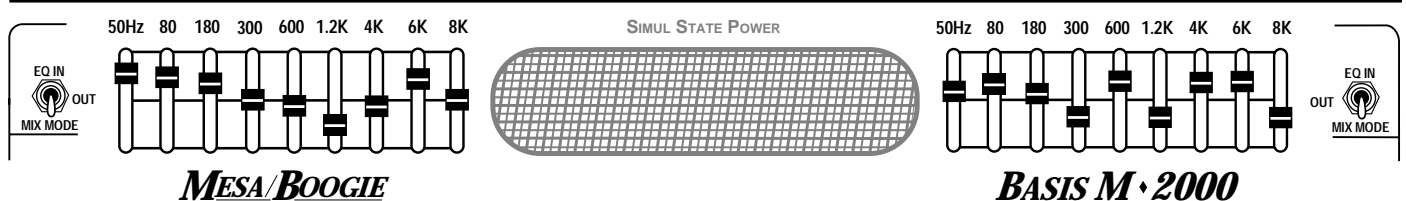

Now that we've run through the two channels, we are ready to spin the unit around and review the *M-2000s'* Rear Panel.

REST AREA

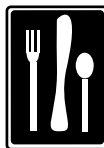
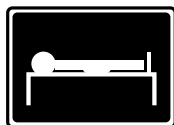

REAR PANEL

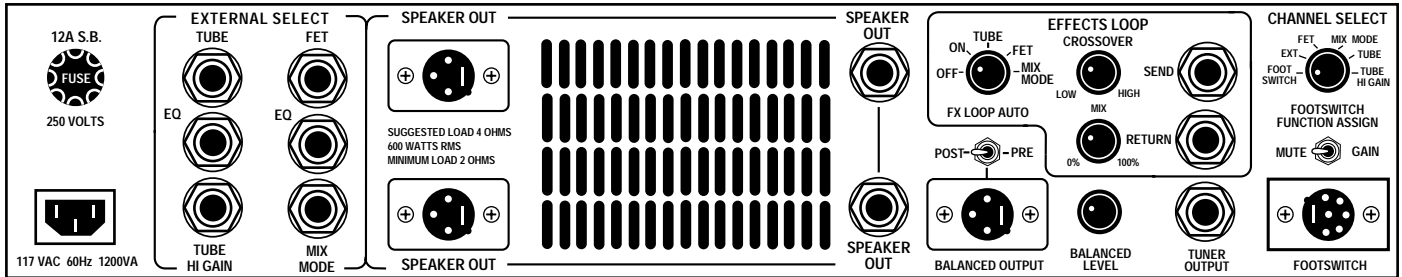

Let's start from the right, as you are looking at the Rear Panel and go through the features one at a time. We are starting from the right because the more frequently used features begin here, as you have probably already experienced.

CHANNEL SELECT

This rotary control engages the two channels and their Modes of operation. When the **M-2000** Foot Controller is not available, use this rotary control to choose the desired mode of operation. To use the **M-2000** Foot Controller, set the CHANNEL SELECT Rotary Switch to the "Footswitch" position. **The M-2000** may also be controlled via an external switching source that uses 1/4 inch "tip to ground" ports. This way, the **M-2000** can easily be interfaced to existing MIDI controlled systems, allowing instant access to the Modes under MIDI *program change* commands. Set the CHANNEL SELECT to "EXT" and connect the six 1/4 inch jacks found in the EXTERNAL SELECT section (far left of the Rear Panel) to the switching source. Unshielded cable is preferable for this application. Trigger the **M-2000** Modes by programming your switching system to "ground" the corresponding **M-2000** External Select jack to bring up the Mode of your choice under a given MIDI *program number*.

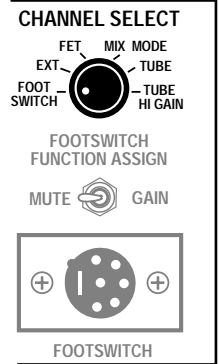

FOOTSWITCH FUNCTION ASSIGN

This mini-toggle switch programs the GAIN switch on the **M-2000** Foot Controller. The GAIN switch serves a dual purpose in the switching scheme of the **M-2000**. It may be used in its normal mode to select the TUBE Channel's HI-GAIN Mode. In this case, set the FOOTSWITCH FUNCTION ASSIGN Switch to the GAIN (right) position. This toggle switch may also be used in conjunction with the TUNER Output to produce a "silent tuning" mode for stage use.

Connect a tuner to the 1/4 inch jack labeled TUNER OUTPUT (located just to the left of the 6 pin XLR Footswitch jack.) Select "MUTE" with the FOOTSWITCH FUNCTION ASSIGN (toggle switch to the left.) When the GAIN switch is selected on the **M-2000** Foot Controller, all sound to the power section will be muted and the instrument signal will pass straight through to the TUNER OUTPUT jack.

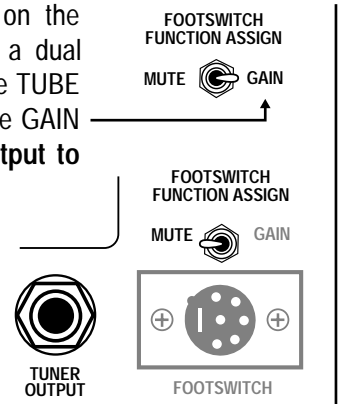

BALANCED OUTPUT / BALANCED LEVEL

This electronically balanced XLR jack provides two possible ways of interfacing to mixing consoles for live and recording situations. **POST:** captures all the robust warmth of the **M-2000's** two powerful and distinct pre-amp circuits, as well as giving you the added flexibility of 18 bands (9 per channel) of "Bass friendly" graphic equalization. Add to this the frequency specific compression circuits in each channel that are tweaked for Bass - and we think you too will find the **M-2000** is the ultimate way to capture Bass direct. Switched to **PRE:** all **M-2000** circuitry is removed from the signal path and the signal is then fed straight from either Instrument Input jack to the Balanced Level control and straight on to the

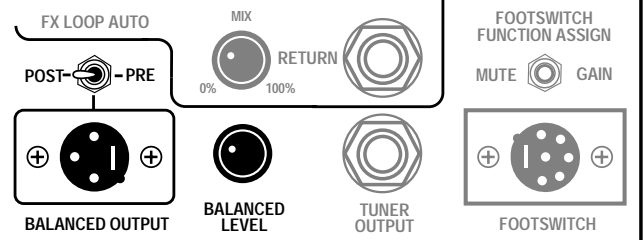

BALANCED OUTPUT / BALANCED LEVEL (Continued)

going directly into the console with no alteration from the **M-2000**. Sometimes this is preferred when playing venues with large sound systems that have plenty of low frequency power of their own and don't always need the added shaping that is happening on the stage.

The BALANCED LEVEL control enables you to match the optimum levels required by most mixing consoles. It is always good practice to "zero out" the level on the **M-2000** before connecting it to a console, just in case the channel at the console was last used for a weak signal and is set to extremes.

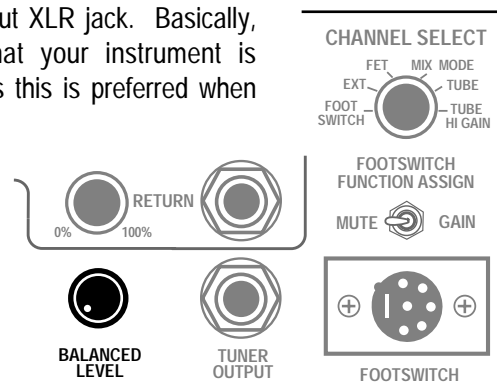

NOTE It is NOT necessary to connect a speaker load to the **M-2000** when using the BALANCED OUTPUT for recording or live use. No damage to the amplifier will occur from having no load connected. Simply turn the OUTPUT LEVEL (located in the center, bottom portion of the Front Panel) to 7:00 (this would be the Off position for this control.)

NOTE In certain situations a hum or buzz may occur when using the direct BALANCED OUTPUT. This occurs due to different references (impedance) to ground between the **M-2000** and the console. If this occurs you may want to lift the **M-2000** ground path by either using an XLR Ground Lift Adapter or by simply making a cable with the grounds disconnected. You might also try a simple A.C. Ground Lift (3 to 2 adapter) on the **M-2000's** power cord just to make sure the noise that you are experiencing is not A.C. Ground related.

FOOTSWITCH CONTROL

This 6 pin XLR jack accepts and powers the **M-2000** FOOT CONTROL unit. It uses a locking type jack so that the foot controller will not be accidentally removed during a performance. Depress the catch on the plug when removing the foot controller's cable from the amplifier.

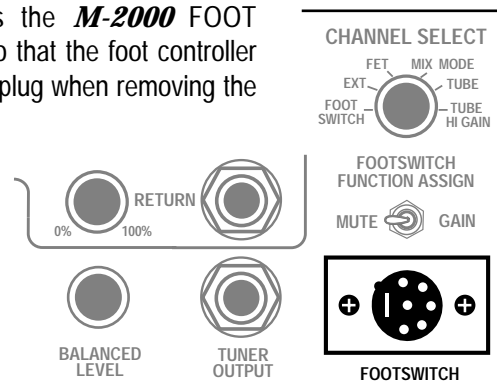

EFFECTS LOOP

The **M-2000** has an advanced way of dealing with signal processing. You may choose not only **how much** of a given effect you wish to blend with the dry signal, but also **which frequencies** will receive processing! The loop is wired in parallel with the direct signal, ensuring that your tone stays bold and authoritative. It is comprised of a SEND and a RETURN that appear as a pair of 1/4 inch jacks forming a bridge between the pre-amp and power sections of the **M-2000**. These are then fed to the crossover circuit, allowing you control of the frequencies that you wish to apply signal processing to, via the CROSSOVER rotary control. To either side (and slightly below this rotary control,) you will see LOW and HIGH. When this control is swept to the left toward the LOW position, the low frequencies will be the primary ones that receive processing.

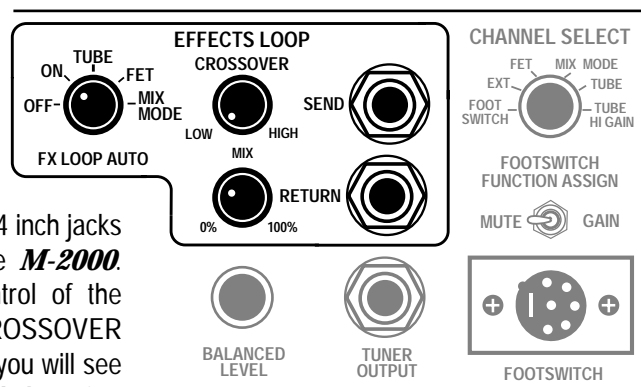

EFFECTS LOOP (Continued)

When panned hard left (7:00), mostly lows will pass this junction. When the rotary control is swept toward HIGH, the crossover will allow more of the upper harmonic range to receive processing. Panned hard right (5:00), mostly highs will be present in the loop's signal path. With the CROSSOVER control set straight up (12:00), the whole range of frequencies (lows and highs) pass equally through the EFFECTS LOOP. The MIX Control lets you decide how much of the frequency specific affected signal you wish to blend with the dry (unaffected) signal. Panned hard left, (0%) removes all the wet signal from the mix. Panned hard right (100%) allows only the wet signal to pass the MIX Control. In general, it's always a good idea to set up your signal processor with its mix control at 100% wet and then slowly raise the *M-2000's* FX LOOP MIX Control until you reach the desired blend. This scheme preserves the integrity of the attack and punch characteristics the *M-2000* is capable of delivering (when no processing is being used.) Finally, the FX LOOP AUTO ASSIGN rotary control activates the loop as well as allowing you to engage it automatically in any of the three Modes when they are called up with either the CHANNEL SELECT Rotary Control or the FOOT CONTROLLER.

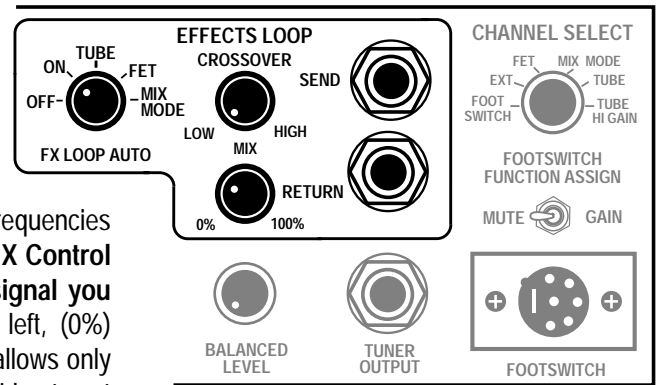

NOTE A great way to check out the power of this advanced loop is to try this simple exercise: **1.** Connect your favorite signal processor to the SEND and RETURN (Input to SEND - Output to RETURN.) May we humbly suggest a "chorus" program as these seem to be great for the purpose of this exercise. **2.** Set the signal processor's Dry / Wet Blend to 100% Wet. **3.** Sweep the CROSSOVER control to approximately 3:00 (this will allow mostly high frequencies to be processed.) **4.** Use the FX LOOP AUTO assign rotary to activate the loop in the Mode that you wish to play in. **5.** While playing an open string, slowly increase the FX LOOP MIX control until you reach the desired dry / wet blend.

Right away you should be able to appreciate the fact, that, while you have chorus (or whatever effect you choose) on "top" of your sound, you have not lost the punch and authority that is so often sacrificed when using effects...especially less expensive units that don't incorporate high quality operational amplifiers in their mixer and output stages. At this time you may also want to sweep the CROSSOVER control over to 9:00 to experience the same test passing mostly low frequencies through the loop. While quite different and interesting, we think most players will want to process their highs, keeping the bottom end tight with unprocessed definition.

SPEAKER OUT

The *BASIS M-2000* provides two types of interconnects for powering speaker enclosures, XLR and the standard 1/4 inch phono jacks. Each of these formats include a pair of jacks that are wired in parallel and which may be used individually or together to power additional cabinets. The recommended speaker load impedance for the *M-2000* is 4 Ohms at which the mighty SIMUL-STATE power section is capable of delivering a whopping 625 watts RMS before clip, and peaks of over 2000 watts! A speaker load of 8 Ohms may also be used and at this impedance, though the overall power will be reduced to roughly 300 watts.

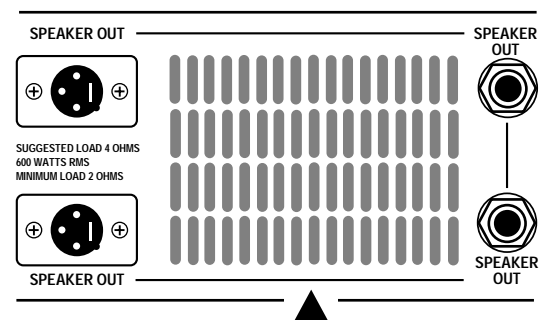

CAUTION: NEVER BLOCK AIR VENTS

EXTERNAL SELECT

This section of the Rear Panel as we mentioned earlier, while explaining the CHANNEL ASSIGN section, is provided to make possible the triggering of the **M-2000** Modes from remote switching sources. The six 1/4 inch jacks represent all four Modes of operation and the two channels' Graphic Equalizers. These functions may be controlled by connecting most any "tip to ground" type switcher to the appropriate jacks and grounding them. This method of Mode selection is provided so that the **M-2000** may be easily interfaced to a system using MIDI Program Change Commands as a switching format.

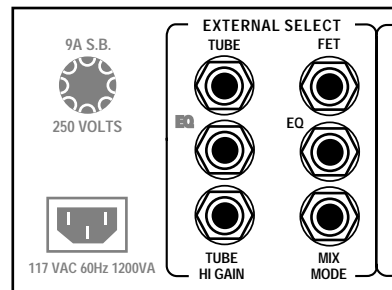

NOTE

If you wish to use the External Select Jacks to call up a Mode or E.Q., you must have the Rotary Mode Select Switch (located on the right side of the Rear Panel) set to the EXT position. These External Select Jacks can always be used to select a Mode, regardless of the state of any other switching logic.

FUSE

This is the A.C. Mains Fuse for the **M-2000**. REPLACE ONLY WITH A SLO-BLO TYPE FUSE OF THE SAME RATING. THIS IS EXTREMELY IMPORTANT, AS THE **M-2000** DRAWS A SUBSTANTIAL AMOUNT OF CURRENT AT HIGH OUTPUT LEVEL SETTINGS.

FUSE RATING (USA) 10 A S.B. / 250 VOLTS ONLY = 117

**FUSE RATING (IEXPORT) 6 1/4 A S.B. / 250 VOLTS ONLY = All Others
100 / 220 / 230 / 240**

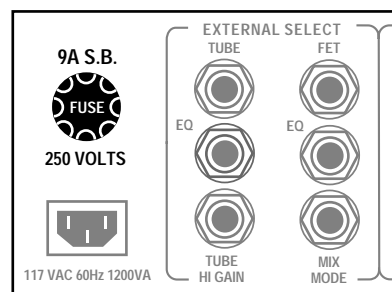

A.C. RECEPTACLE

The "Euro Style" A.C. cord connector that is supplied with the **M-2000** makes set-ups and tear-downs after the gig a snap. It also makes de-racking much easier when you wish to remove the unit from a hard wired rack system where all the A.C. cords have been cut to length. Additional heavy duty cords are available should you ever need one...simply call us direct and we can ship one directly to you for a nominal charge, plus shipping costs. Make sure the A.C. Cord is firmly in its socket (receptacle) before powering up the unit.

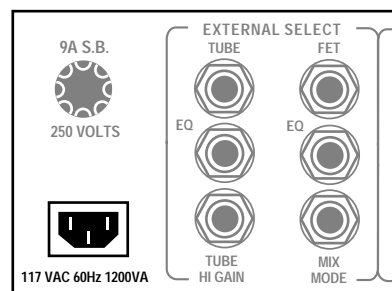

CAUTION: NEVER BLOCK AIR VENTS

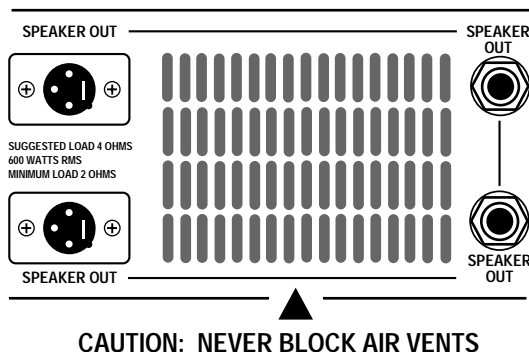

CAUTION: NEVER BLOCK AIR VENTS

EPILOGUE

We hope this manual has answered most of your operating questions and that you now feel confident to start experimenting on your own. The **M-2000** was created in the pioneer spirit and from its conception, was intended to be an instrument of limitless expression. As you become more familiar with the unit, we're sure that you will realize that the **M-2000** is a wise investment in your future as a bassist and one of the best things you ever did for your musical pursuits. We are proud to be your amplifier company. Thank you for trusting us with your sound...**Best Wishes!**

Settings Templates for Your Personal Favorite *M-2000* Sounds

VACUUM TUBE CHANNEL

50Hz 80 180 300 600 1.2K 4K 6K 8K

MESA/BOOGIE

GAIN TREBLE MIDDLE BASS MASTER

FIELD EFFECT CHANNEL

50Hz 80 180 300 600 1.2K 4K 6K 8K

BASIS M·2000

MASTER TREBLE MIDDLE BASS BASS FREQ.

SIMUL STATE POWER

COMPRESSION THRESHOLD 50% TUBE MIX FET

3:1 THRESHOLD 5:1 OFF FREQUENCY

3:1 THRESHOLD 5:1 OFF FREQUENCY

OUTPUT LEVEL TUBE HI GAIN FET CLIP

50% MIX

5:1 OFF FREQUENCY

ACTIVE INSTRUMENT INPUTS PASSIVE

EQ IN OUT MIX MODE BRIGHT NORMAL HI GAIN NORMAL MIX ASSIGN

EQ IN OUT MIX MODE BRIGHT NORMAL HI GAIN NORMAL MIX ASSIGN

ON POWER

VACUUM TUBE CHANNEL

50Hz 80 180 300 600 1.2K 4K 6K 8K

MESA/BOOGIE

GAIN TREBLE MIDDLE BASS MASTER

FIELD EFFECT CHANNEL

50Hz 80 180 300 600 1.2K 4K 6K 8K

BASIS M·2000

MASTER TREBLE MIDDLE BASS BASS FREQ.

SIMUL STATE POWER

COMPRESSION THRESHOLD 50% TUBE MIX FET

3:1 THRESHOLD 5:1 OFF FREQUENCY

3:1 THRESHOLD 5:1 OFF FREQUENCY

OUTPUT LEVEL TUBE HI GAIN FET CLIP

50% MIX

5:1 OFF FREQUENCY

ACTIVE INSTRUMENT INPUTS PASSIVE

EQ IN OUT MIX MODE BRIGHT NORMAL HI GAIN NORMAL MIX ASSIGN

EQ IN OUT MIX MODE BRIGHT NORMAL HI GAIN NORMAL MIX ASSIGN

ON POWER

VACUUM TUBE CHANNEL

50Hz 80 180 300 600 1.2K 4K 6K 8K

MESA/BOOGIE

GAIN TREBLE MIDDLE BASS MASTER

FIELD EFFECT CHANNEL

50Hz 80 180 300 600 1.2K 4K 6K 8K

BASIS M·2000

MASTER TREBLE MIDDLE BASS BASS FREQ.

SIMUL STATE POWER

COMPRESSION THRESHOLD 50% TUBE MIX FET

3:1 THRESHOLD 5:1 OFF FREQUENCY

3:1 THRESHOLD 5:1 OFF FREQUENCY

OUTPUT LEVEL TUBE HI GAIN FET CLIP

50% MIX

5:1 OFF FREQUENCY

ACTIVE INSTRUMENT INPUTS PASSIVE

EQ IN OUT MIX MODE BRIGHT NORMAL HI GAIN NORMAL MIX ASSIGN

EQ IN OUT MIX MODE BRIGHT NORMAL HI GAIN NORMAL MIX ASSIGN

ON POWER

VACUUM TUBE CHANNEL

50Hz 80 180 300 600 1.2K 4K 6K 8K

MESA/BOOGIE

GAIN TREBLE MIDDLE BASS MASTER

FIELD EFFECT CHANNEL

50Hz 80 180 300 600 1.2K 4K 6K 8K

BASIS M·2000

MASTER TREBLE MIDDLE BASS BASS FREQ.

SIMUL STATE POWER

COMPRESSION THRESHOLD 50% TUBE MIX FET

3:1 THRESHOLD 5:1 OFF FREQUENCY

3:1 THRESHOLD 5:1 OFF FREQUENCY

OUTPUT LEVEL TUBE HI GAIN FET CLIP

50% MIX

5:1 OFF FREQUENCY

ACTIVE INSTRUMENT INPUTS PASSIVE

EQ IN OUT MIX MODE BRIGHT NORMAL HI GAIN NORMAL MIX ASSIGN

EQ IN OUT MIX MODE BRIGHT NORMAL HI GAIN NORMAL MIX ASSIGN

ON POWER

VACUUM TUBE CHANNEL

50Hz 80 180 300 600 1.2K 4K 6K 8K

MESA/BOOGIE

GAIN TREBLE MIDDLE BASS MASTER

FIELD EFFECT CHANNEL

50Hz 80 180 300 600 1.2K 4K 6K 8K

BASIS M·2000

MASTER TREBLE MIDDLE BASS BASS FREQ.

SIMUL STATE POWER

COMPRESSION THRESHOLD 50% TUBE MIX FET

3:1 THRESHOLD 5:1 OFF FREQUENCY

3:1 THRESHOLD 5:1 OFF FREQUENCY

OUTPUT LEVEL TUBE HI GAIN FET CLIP

50% MIX

5:1 OFF FREQUENCY

ACTIVE INSTRUMENT INPUTS PASSIVE

EQ IN OUT MIX MODE BRIGHT NORMAL HI GAIN NORMAL MIX ASSIGN

EQ IN OUT MIX MODE BRIGHT NORMAL HI GAIN NORMAL MIX ASSIGN

ON POWER

Sample Settings - Field Effect Channel

Punch Funk

UL STATE POWER

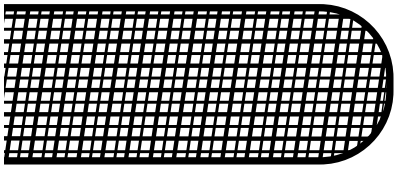

50%
MIX
OUTPUT LEVEL

FET
CLIP

COMPRESSION
THRESHOLD 3:1
FREQUENCY 5:1 OFF

50Hz 80 180 300 600 1.2K 4K 6K 8K

BASIS M·2000

MASTER TREBLE MIDDLE BASS BASS FREQ.

FIELD EFFECT CHANNEL

EQ IN
OUT

MIX MODE
BRIGHT
NORMAL
HIGH
LOW
BASS
SHIFT

ON
POWER

Scooped FET

UL STATE POWER

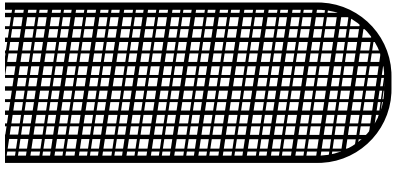

50%
MIX
OUTPUT LEVEL

FET
CLIP

COMPRESSION
THRESHOLD 3:1
FREQUENCY 5:1 OFF

50Hz 80 180 300 600 1.2K 4K 6K 8K

BASIS M·2000

MASTER TREBLE MIDDLE BASS BASS FREQ.

FIELD EFFECT CHANNEL

EQ IN
OUT

MIX MODE
BRIGHT
NORMAL
HIGH
LOW
BASS
SHIFT

ON
POWER

Articulate Solo

UL STATE POWER

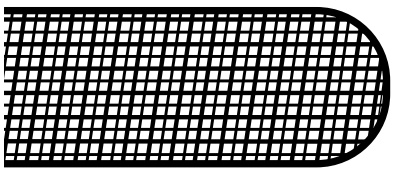

50%
MIX
OUTPUT LEVEL

FET
CLIP

COMPRESSION
THRESHOLD 3:1
FREQUENCY 5:1 OFF

50Hz 80 180 300 600 1.2K 4K 6K 8K

BASIS M·2000

MASTER TREBLE MIDDLE BASS BASS FREQ.

FIELD EFFECT CHANNEL

EQ IN
OUT

MIX MODE
BRIGHT
NORMAL
HIGH
LOW
BASS
SHIFT

ON
POWER

Sample Settings - Vacuum Tube Channel

Fat R & B

ACTIVE

INSTRUMENT INPUTS

PASSIVE

EQ IN

OUT

MIX MODE

BRIGHT

NORMAL

HI GAIN

NORMAL

MIX ASSIGN

50Hz 80 180 300 600 1.2K 4K 6K 8K

MESA/BOOGIE

GAIN TREBLE MIDDLE BASS MASTER

VACUUM TUBE CHANNEL

SIMUL STATE Po

COMPRESSION

3:1 THRESHOLD

5:1 OFF FREQUENCY

50%

TUBE MIX

TUBE HI GAIN

OUTPUT LEVEL

Thumb Funk

ACTIVE

INSTRUMENT INPUTS

PASSIVE

EQ IN

OUT

MIX MODE

BRIGHT

NORMAL

HI GAIN

NORMAL

MIX ASSIGN

50Hz 80 180 300 600 1.2K 4K 6K 8K

MESA/BOOGIE

GAIN TREBLE MIDDLE BASS MASTER

VACUUM TUBE CHANNEL

SIMUL STATE Po

COMPRESSION

3:1 THRESHOLD

5:1 OFF FREQUENCY

50%

TUBE MIX

TUBE HI GAIN

OUTPUT LEVEL

Driving Rock

ACTIVE

INSTRUMENT INPUTS

PASSIVE

EQ IN

OUT

MIX MODE

BRIGHT

NORMAL

HI GAIN

NORMAL

MIX ASSIGN

50Hz 80 180 300 600 1.2K 4K 6K 8K

MESA/BOOGIE

GAIN TREBLE MIDDLE BASS MASTER

VACUUM TUBE CHANNEL

SIMUL STATE Po

COMPRESSION

3:1 THRESHOLD

5:1 OFF FREQUENCY

50%

TUBE MIX

TUBE HI GAIN

OUTPUT LEVEL

FRONT VIEW BASIS M-2000

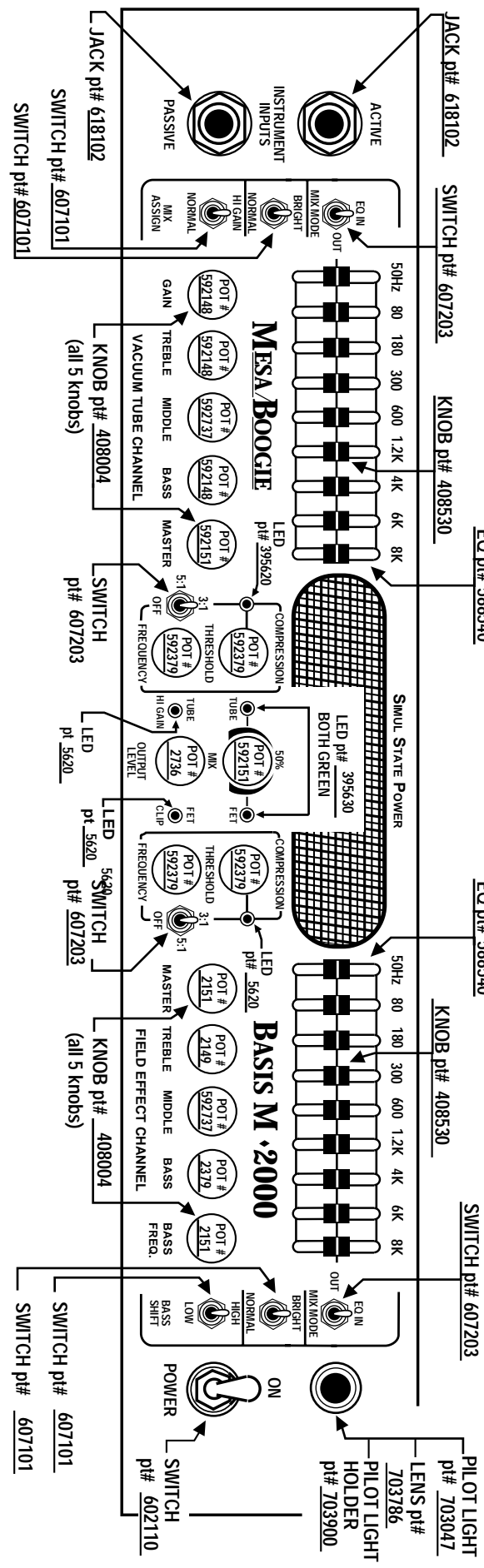

REAR VIEW BASIS-M2000

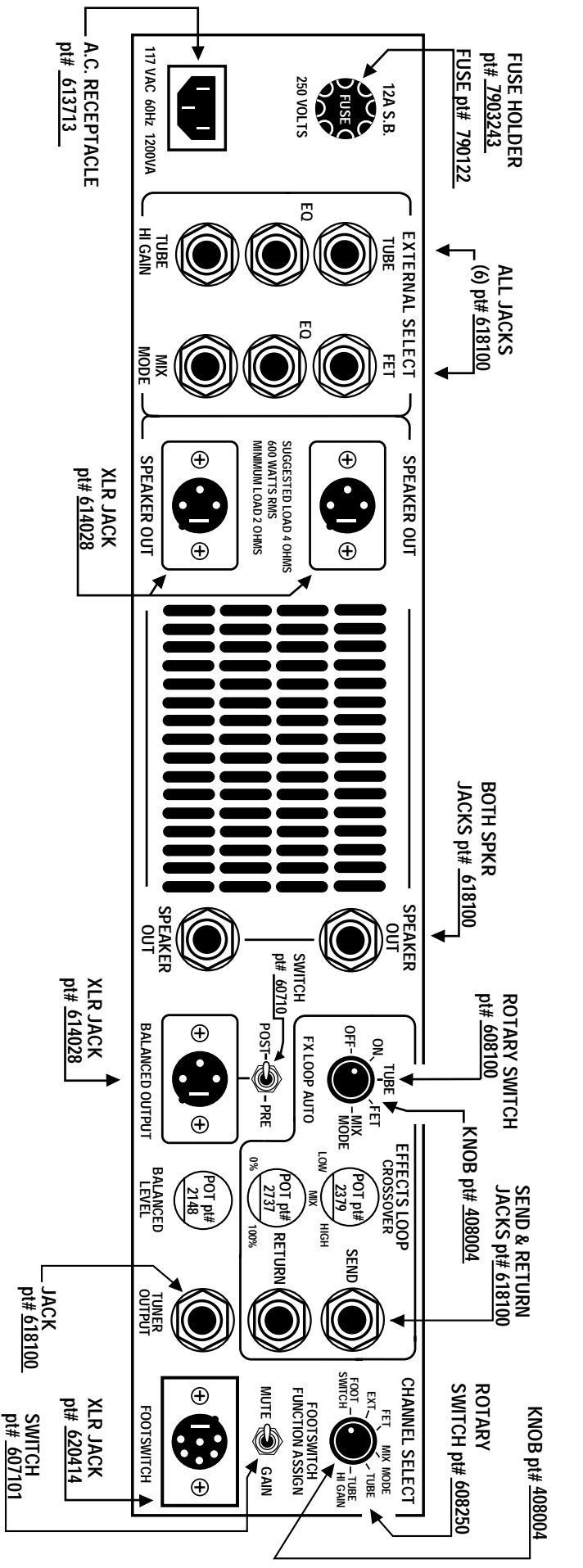

MESA/BOOGIE

The Spirit of Art in Technology

Thank you for trusting MESA/Boogie to be your amplifier company. We wish you many years of toneful enjoyment from this handbuilt all tube instrument.

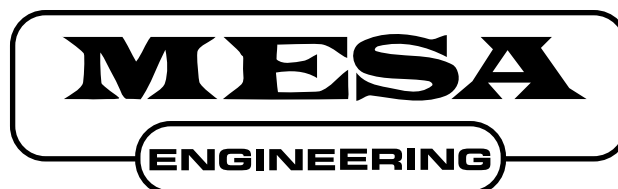

Free Manuals Download Website

<http://myh66.com>

<http://usermanuals.us>

<http://www.somanuals.com>

<http://www.4manuals.cc>

<http://www.manual-lib.com>

<http://www.404manual.com>

<http://www.luxmanual.com>

<http://aubethermostatmanual.com>

Golf course search by state

<http://golfingnear.com>

Email search by domain

<http://emailbydomain.com>

Auto manuals search

<http://auto.somanuals.com>

TV manuals search

<http://tv.somanuals.com>