

*MESA/BOOGIE*



*Owner's Manual*

## *Greetings from the Home of Tone*

*Congratulations on your choice of the M-PULSE as your Bass amplifier and welcome to the MESA/Boogie family! As a discriminating player you probably know that you have purchased the most comprehensive instrument for amplifying Bass that is available. What you might not realize is that this entitles you to all the experience, resources and commitment our twenty-five years of service to musicians world wide has to offer. Our responsibility is to help you sound great! So, if at any time you feel you need help or direction, we are here for you...a phone call away.*



## Table of Contents

Precautions	0
Overview	1/2

Instant Gratification	2
-----------------------	---

Helpful Hints	3
---------------	---

### FRONT PANEL:

Instrument Inputs: ACTIVE & PASSIVE	4
-------------------------------------	---

GAIN	4
------	---

BASS	5
------	---

MID	5
-----	---

TREBLE	5/6
--------	-----

PARAMETRIC EQUALIZER	6
----------------------	---

GAIN CONTROL: <i>Parametric EQ</i>	6/7
------------------------------------	-----

FREQUENCY CONTROLS: <i>Parametric EQ</i>	7
--	---

COMPRESSOR	8
------------	---

THRESHOLD	8
-----------	---

RATIO	8/9
-------	-----

MAIN <i>Output</i>	9
--------------------	---

SOLO <i>Output</i>	9
--------------------	---

POWER SWITCH	9
--------------	---

### REAR PANEL:

FUSE	10
------	----

A.C. RECEPTACLE	10
-----------------	----

SLAVE OUT	11
-----------	----

SPEAKER OUT	11
-------------	----

DIRECT OUT: LEVEL, POST / PRE, GROUND LIFT and XLR jack	11
---	----

EFFECTS: SEND, RETURN, MIX and PROGRAM switch	12
---	----

TUNER OUTPUT	12
--------------	----

FOOTSWITCH	12
------------	----

FACTORY SAMPLE SETTINGS	13/14
-------------------------	-------

TUBE NOISE & DIAGNOSING PRE-AMP TUBE PROBLEMS	15
---	----

PERSONAL SETTING PAGES	16/17
------------------------	-------

PARTS SHEET	18
-------------	----

# PRECAUTIONS & WARNINGS

*Your MESA/Boogie Amplifier is a professional instrument. Please treat it with respect and operate it properly.*

## USE COMMON SENSE AND ALWAYS OBSERVE THESE PRECAUTIONS:

**WARNING:** Vacuum tube amplifiers generate heat. To insure proper ventilation always make certain there is at least four inches (100mm) of space behind the rear of the amplifier cabinet. Keep away from curtains or any flammable objects.

**WARNING:** Do not block any ventilation openings on the rear or top of the amplifier. Do not impede ventilation by placing objects on top of the amplifier which extend past the rear edge of its cabinet.

**WARNING:** Do not expose the amplifier to rain, moisture, dripping or splashing water. Do not place objects filled with liquids on or nearby the amplifier.

**WARNING:** Always make certain proper load is connected before operating the amplifier. Failure to do so could pose a shock hazard and may result in damage to the amplifier.

Do not expose amplifier to direct sunlight or extremely high temperatures.

Always insure that amplifier is properly grounded. Always unplug AC power cord before changing fuse or any tubes. When replacing fuse, use only same type and rating.

Avoid direct contact with heated tubes. Keep amplifier away from children.

Be sure to connect to an AC power supply that meets the power supply specifications listed on the rear of the unit. Remove the power plug from the AC mains socket if the unit is to be stored for an extended period of time. If there is any danger of lightning occurring nearby, remove the power plug from the wall socket in advance.

To avoid damaging your speakers and other playback equipment, turn off the power of all related equipment before making the connections.

Do not use excessive force in handling control buttons, switches and controls. Do not use solvents such as benzene or paint thinner to clean the unit. Wipe off the exterior with soft cloth.

Be sure to have the warranty card filled out by the store at which it was purchased and return to *Mesa/Boogie*.

**YOUR AMPLIFIER IS LOUD! EXPOSURE TO HIGH SOUND VOLUMES MAY CAUSE PERMANENT HEARING DAMAGE !**

**No user serviceable parts inside.** Refer service to qualified personnel. Always unplug AC power before removing chassis.

**EXPORT MODELS:** Always insure that unit is wired for proper voltage. Make certain grounding conforms with local standards.

**READ AND FOLLOW INSTRUCTIONS OF PROPER USAGE.**



## OVERVIEW:

Congratulations on your choice of the *M-PULSE* as your Bass amplifier. This latest offering is our most comprehensive amplifier for electric bass and it brings together both new and old technology, solid state and vacuum tube design to create an instrument of unparalleled performance and soulful sound.

*M-PULSE* amplifiers start with an all-tube pre-amp for the most musical response and this feeds the three standard rotary tone controls BASS, MID and TREBLE. Most first time players comment that we could have stopped right there after hearing the sweet, tight, huge sound from this first section of the *M-PULSE* pre-amp. But that's just the beginning!

From there, signal is routed to an ultra-powerful 5 Band Parametric Equalizer that has been optimized for the frequencies found on today's 5 & 6 string instruments. A bandwidth from 30Hz to 12Khz is found on the 5 frequency controls and each overlaps to assure a smooth transition between bands. The 5 GAIN controls allow a boost and cut of 15db in either direction to provide 30db of band specific shaping power. This EQ can be assigned On, Off or Footswitch, which is activated when the *M-PULSE* Footcontroller is connected. Build a rich, complex, sound utilizing the parametric as your main voice or, add the EQ for a footswitchable solo or slap sound to an already amazing fundamental tone...either way this 5 Band EQ is a great addition you will come to find invaluable.

Next in the signal path is a new improved Compressor that features both THRESHOLD and RATIO controls. First included on our *M-2000* Bass amplifier, this updated version allows for much greater fine-tuning of the dynamics. The THRESHOLD control is extremely sensitive to your attack and can be set for either subtle or dramatic compression effects. The RATIO control allows for anything from slight dynamic trimming all the way to a hard knee squash with a range from 1:1 to Infinity. The Compressor is also assignable On, Off or Footswitch giving you the choices of active or inactive all the time or triggering it remotely during a performance as an effect.

After the Compressor we jump over to the Output section that serves up the mighty *SIMUL STATE* power with its awesome 600 (or 360) watts of rich, tube-driven MOSFET tone. This innovative circuit combines the best attributes of tube and solid state technology to arrive at a magical blend that breathes and yet, tracks tight while producing massive power.

## FRONT VIEW : M- PULSE 600

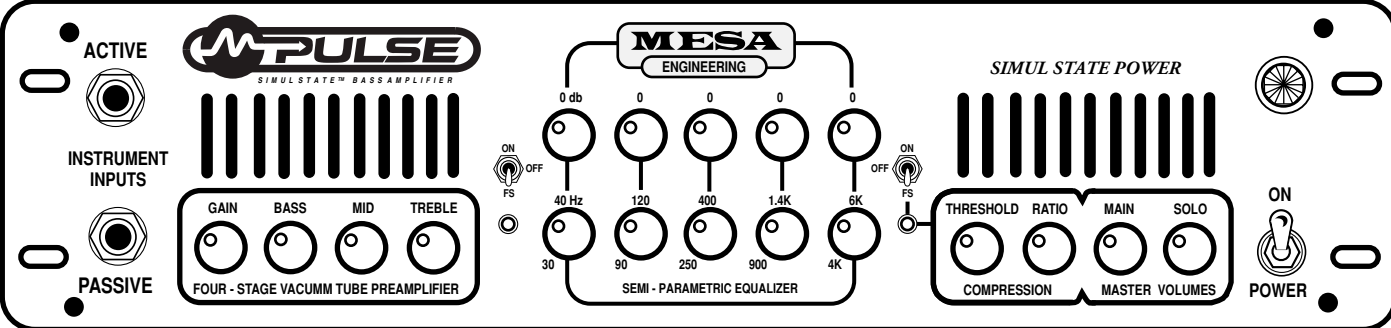

## OVERVIEW: *Continued*

This power is interfaced to you via a pair of Output controls that serve as overall MASTER VOLUMES. These are MAIN and SOLO and the two astound bassists much as they did when we began including them on our guitar amplifiers. The logic is in their names MAIN and SOLO. When players get this scheme they say “why hasn’t there always been two”. There will be from now on as imitators follow, but right now we are giving you another footswitchable feature in the form of this SOLO control. This is an additional Master pot wired in parallel with the MAIN Output and it allows a footswitchable SOLO boost. This feature lets you step out for a showcased part or allows you to compensate for a sound that has a lower output due to either notching in the Parametric EQ or Compression or both.

Looking to the Rear Panel you can see that all your interfacing needs are well provided for. A dedicated TUNER Output is provided for tuning without having to disconnect. The Parallel Effects Loop and MIX control provides seamless interfacing of all your outboard processing. The Loop is also footswitchable allowing you to call up your effects on the fly.

## REAR VIEW : *M- PULSE 600*

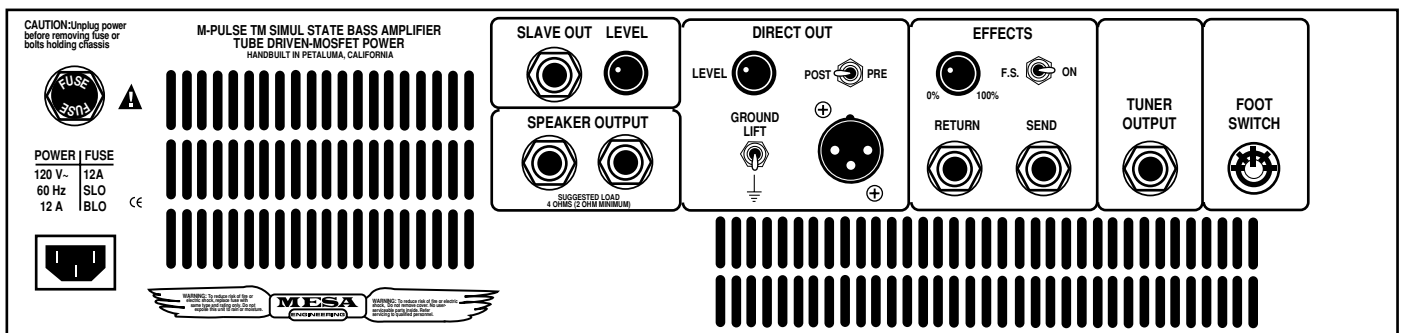

A Balanced XLR DIRECT OUTPUT and LEVEL control is provided with both Post and Pre settings to capture your sound through house main or recording consoles. In addition a SLAVE Output with LEVEL control is provided capturing both pre-amp and power section in a padded format. This enables you to use additional power for large venues or for deriving a post signal for effects to be sent to additional amplifier(s) in a 1 dry / 1 wet scenario. And finally, 2 SPEAKER OUTPUTS are provided to harness the robust output of the *M-PULSE* power amp. With this pair of jacks almost any speaker cabinet or combination of cabinets can be accommodated.

Now that we have covered the basics of *your* new *M-PULSE*, let’s connect up the A.C. and your favorite cabinet and Bass and give this instrument of fundamental enlightenment a listen with a quick reference setting.

## Instant Gratification:

### INSTANT GRATIFICATION (Parametric EQ Optional)

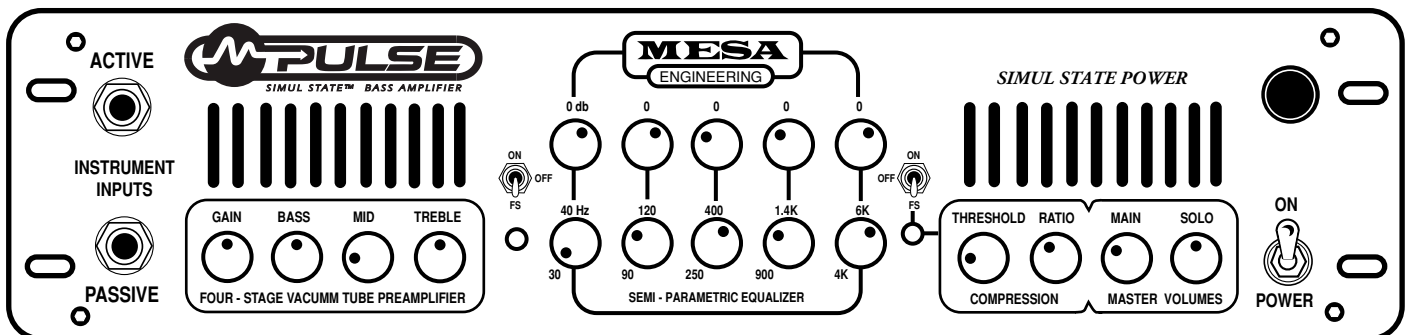

Now that you have had a listen to your *M-PULSE*, here are a few quick tips to help you in case you don’t have time to read the rest of this manual right now.

## HELPFUL HINTS:

---

1. Connect your A.C. Power Cable to a grounded outlet. Avoid ground lifts (3 to 2 prong adapter) whenever possible.
2. **The optimum speaker load for your *M-PULSE* is 4 Ohms.** You may use a cabinet (s) of a higher rating safely (8 Ohm) with no degradation in tone, however the amplifier will not produce its full rated wattage. Minimum load rating is 2 Ohms and while the *M-PULSE* will handle this lower load condition - and in fact produce more than its rated power, it is not recommended. Prolonged use of a 2 Ohm load will cause the power mosfets to run hot causing the protection circuit to trigger and mute the output signal until such time as the mosfets can return to a safe operating temperature. Avoid using 2 Ohm loads whenever possible.
3. **Use high quality cable from your instrument to the *M-PULSE* and from the *M-PULSE* to your speaker.** Instrument cable should be relatively low capacitance shielded cable. Whenever possible use lengths of 15 feet or shorter. Longer than 15' tends to introduce too much capacitance resulting in reduced punch and top end clarity. Speaker cable should be at least 14 gauge (or thicker) unshielded cable and again try to keep the length of cable as short as possible for the best tonal results.
4. **The BASS and TREBLE controls are active** type controls with a broad response even though they are acting primarily on their center frequency Q point. This broader response works extremely well with the passive, broad-band MID control. Because BASS and TREBLE are active controls, they actually cut (or notch) the region around the Q point when the control is set below 12:00, and boost these frequencies when the control is set above 12:00. The MID works like a normal passive control and boosts a broad band of frequencies as it is increased.
5. **When using the Parametric EQ keep in mind that cutting (notching) undesirable frequencies is often preferable to boosting desirable ones.** By using this technique you will keep noise to a minimum and ensure ample headroom at all times. The Parametric is a powerful tone shaping tool when used tastefully, but all too often they are abused and set to their extremes which can result in an unbalanced tone that is "full of holes" or excessive noise.
6. When using the EFFECTS LOOP to patch in your outboard processing, the best sonic results are usually found with the processors' dry/wet mix set to 100% wet, and the *M-PULSE* EFFECTS MIX control set as close to 10% as possible. Following this scheme preserves the integrity of the *M-PULSEs'* tone by mixing in a very small amount of a very wet signal with a high ratio of the original dry signal.
7. The Footcontroller must be connected and SOLO triggered for it to affect the signal.
8. The DIRECT OUTPUT circuit provides a GROUND LIFT that disconnects chassis ground from circuit ground. Should you encounter a hum or buzz when interfacing to live or recording consoles, try flipping this ground lift after you have muted that channels' input or zero'ed the fader. Many times (but not all) the hum is created by a ground loop between the *M-PULSE* and the console and lifting the *M-PULSE* chassis to circuit ground will remedy the situation.
9. Extreme settings of the Compressor will affect the overall output available, making the amplifier seem not quite as powerful. This is a result of removing the dynamic content of the signal. May we suggest using the COMPRESSOR tastefully and at less than extreme settings to attain the best all around performance...unless a desired special effect requires that you disregard more "normal" settings.

Hopefully these hints have helped get you up and running with your new *M-PULSE* and you are well on your way to having the best tone you have ever heard! Now that you have a better idea of the layout and features, we are ready to move on to understanding the individual controls and circuits in more detail.

## FRONT PANEL:

**INSTRUMENT INPUTS: ACTIVE / PASSIVE** These are the Instrument Input jacks and between them you can match the signal output level of virtually any instrument.

The **ACTIVE** Input is padded down for greater input stage headroom and this works well with basses that use an on-board pre-amp with an active tone control circuit. Usually these instruments put out a much hotter signal than conventional basses, even when their tone controls are set “flat”. The added headroom is needed to prevent clipping in the first stage of the pre-amp and the **ACTIVE** Input should be used whenever instruments that utilize active style pickup/EQ harnesses are used.

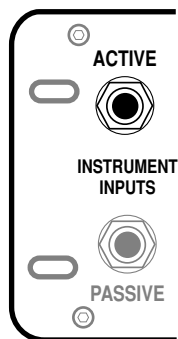

You can use the **ACTIVE** Input for conventional passive instruments also, for heavy handed players needing extra headroom or simply a “cleaner” sound. However, note that unless you have Kong size hands it may be difficult to bring the amplifier to full power with this reduced front end sensitivity.

The **PASSIVE** Input is set up for more conventional basses with passive pickups that produce lower output signal levels. This jack is more sensitive than the **ACTIVE** Input and therefore can drive the first stage to clip with a much lower signal. Keep this in mind if you

play with a heavy touch or want a little bit of growl or front end clip. In those scenarios this jack can be quite useful to push the first stage of the pre-amp.

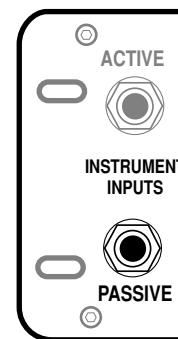

## FRONT PANEL CONTROLS:

**GAIN:** This control determines the overall character of the input sensitivity. The lower regions of the control (below 12:00) lend greater headroom and provide a scooped, brighter personality. The upper harmonics come through more prominently in this area of the control making the top end sound more transparent and sweet. This region is especially useful for funkier stuff when thumbing is in order. It keeps the rubber-band feel intact in the lows and mids while voicing the snap just high enough to avoid harshness, or the dreaded “gak” when the G string is plucked.

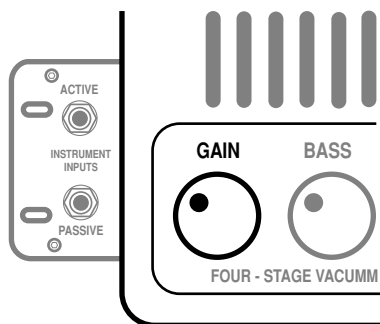

As the **GAIN** control is increased past 12:00 a richer, more “well-rounded” voice becomes dominant and headroom starts to diminish in increments until eventually, a tube overdrive sound appears as the 12AX7 input tube is driven into saturation.

The region between 12:00 and 2:30 is where the classic, warm tube sound resides and within this narrow band you will discover a world of tone. Tiny increments here produce subtle, but important differences in the attack characteristic which in turn, feel like changes in the time domain. By experimenting with the amount of gain, you can actually voice the amp to feel as if it bounces just ahead of the groove - or lays back a little deeper to produce a more

Fatback feel. The difference in attack and sustain produces striking results as to how the bassist - and in fact the whole band - perceives things in the time domain.



## FRONT PANEL CONTROLS: (Continued)

**BASS:** This control is responsible for the basic mix of low frequencies in the tube pre-amp. As mentioned earlier in the Helpful Hints section, the **BASS** control is an active shelving type control as opposed to a passive style control. This means that a center Q point has been chosen and this control allows you to either boost or cut that frequency. This control differs from the low bands of the Parametric in that it has a broader Q point with a more gentle ramp as opposed to the Parametrics' narrow Q that is used with a separate GAIN control.

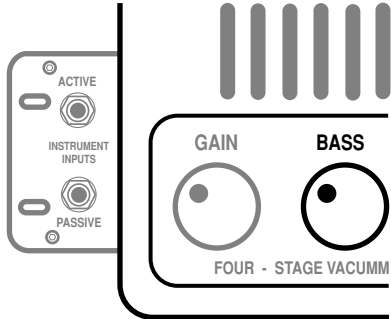

The **BASS** control is actually a gain and frequency control all rolled into one with the Q center at 55Hz and harmonics in both low and high directions are affected because of its broader band nature. As the control is increased past 12:00 there is a 6db per octave rise in gain with the frequency topping out at 321Hz. With 12:00 straight-up representing "flat" (a no boost/no cut setting). As the **BASS** control is dialed below 12:00, 55Hz and all associated harmonics are reduced and eventually notched completely out of the signal. Conversely, there is a 6db per octave cut beginning at 55Hz going down to 20Hz where the shelving ends with a *cut gain* of -20db as the control approaches 7:30 (off).

This type of broad band, active rotary control makes it possible to achieve bass characteristics far beyond that of a conventional passive type control. It can increase the low end to an almost absurd level and with a flick of the wrist, dip it to near transistor radio skinniness. Needless to say, with any control this powerful a certain amount of finesse must be applied to achieve musical results. Be especially mindful of this when using the 5 Band Parametric in conjunction with the **BASS** control.

**MID:** This is the only passive style control in the string of rotary tone controls. This scheme was chosen for its inherently musical blend and for the way the passive style midrange control, with its wide spread and smooth taper, *fills in the holes*. Unlike the BASS, this control is a **boost only**, and while it can competently remove this broad spectrum of midrange from the mix, it cannot provide the extreme attenuation of an active style control.

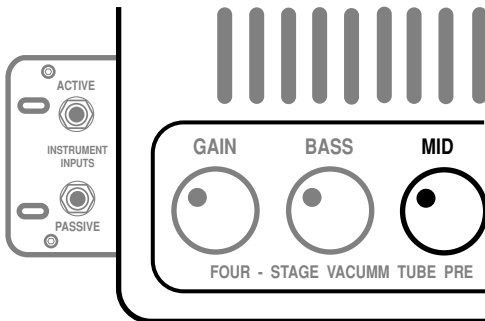

You will find, as we did, that this control works amazingly well for shaping the midrange frequencies with a natural earthiness and character that is a perfect counterpart to its neighbors. It is hard to dial wrong with this more forgiving control as it seems to give you just enough and no more. This simplicity can be a welcome respite from the higher tech power of the adjacent tone controls...not to mention the 5 Band Parametric. For radical and specific scooping of the midrange frequencies for modern R&B and Funk styles, there is plenty of notching power that is

infinitely more accurate to be found in the 5 Band Parametric. Because of this, we opted for the tried and true passive style midrange control that has been working great in all of our amplifiers for decades. It's hard to improve on a classic.

**TREBLE:** The **TREBLE** is also an active shelving style control like that found in the BASS and again, it was chosen for its ability to radically shape the upper harmonic region. Like the BASS, it also has a center Q point with harmonics above and below responding in harmony as it is dialed for either cut or boost.

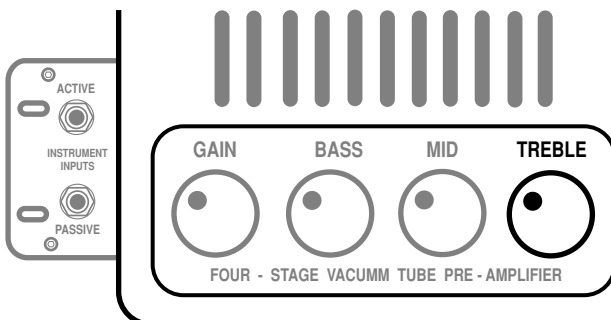

As the control is increased past 12:00, it produces a 6db per octave rise in gain starting at 723Hz until +20db is reached. From this point, gain remains constant at +20db for all frequencies above 723Hz all the way out to 20Khz. This scheme lends a sweetness of sound while

## FRONT PANEL CONTROLS: (Continued)

**TREBLE:** *Continued* retaining all the necessary cut and focus associated with a traditional passive **TREBLE** control.

As the control is dialed below 12:00, it begins a 6db per octave cut from 3.2Khz to the shelving point at 723Hz, where it continues to attenuate all frequencies above 723Hz until - 20db is reached where *cut gain* remains constant until the control reaches 7:30 (off). The ability to cut these frequencies more radically makes it possible to obtain incredibly rich and warm old-school R&B and Jazz sounds that rival any recordings of the day.

This active shelving **TREBLE** control completes the rotary tone control string to create a powerful and extremely accurate network to use as your fundamental platform. It's no wonder many first time *M-PULSE* players make the comment that just these controls combined with the GAIN create the best tone they have ever heard!

**NOTE:** *As with the BASS control, may we remind you that a control of this type with its increased power should be used with finesse. In the TREBLE'S case, almost more so, because higher frequencies seem louder to the ear and are generally more painful when set to extremes. Another reason to use care is that high frequencies tend to increase the ambient noise floor when set too high. This is then exacerbated if the 5 Band Parametric is combined for added top end boost. Dial with care and music in mind.*

**PARAMETRIC EQUALIZER:** Your *M-PULSE* is equipped with a powerful **5 BAND SEMI-PARAMETRIC EQUALIZER** that allows you to shape your signal to achieve virtually any sound. Anything from subtle enhancement to extreme notching or boosting is

possible with the only limit being your imagination. The **EQ** can be used in combination with the rotary tone controls and left active in the signal path to achieve your main sound or, it may be remotely triggered from the Footcontroller to achieve unique footswitchable solo sounds or a different sound for an alternate instrument.

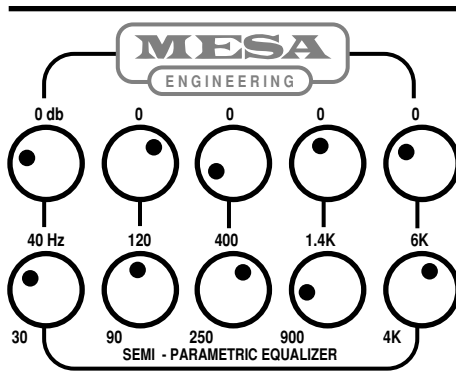

As you can see the **EQ** section is comprised of three elements; the Program toggle switch and LED indicator, the 5 **GAIN** controls on the top row, and the **FREQUENCY** controls on the bottom row. The Program toggle puts the **EQ** "in" where you want it, the **GAIN** control for each band lets you decide how much cut or boost of the corresponding frequency you want, and the **FREQUENCY** control lets you decide the specific frequency within that band.

Since the Program switch is pretty much straightforward with ON and OFF being just that - and F.S. being controlled by the Footcontroller, we will move right to the **GAIN** and **FREQUENCY** controls.

**GAIN CONTROLS: Parametric EQ** These 5 **GAIN** controls adjust the amount of whatever frequency has been zeroed-in on for manipulation with the **FREQUENCY** control. Each of the 5 **GAIN** controls allows a full 30db of gain adjustment with 15db of cut and 15db of boost from the center (12:00) 0db position. When searching for sounds it is sometimes faster to either notch or boost the respective **GAIN** control radically and the sweep for the desired frequency with the **FREQUENCY** control. This way it will be very apparent what you are doing to the sound.

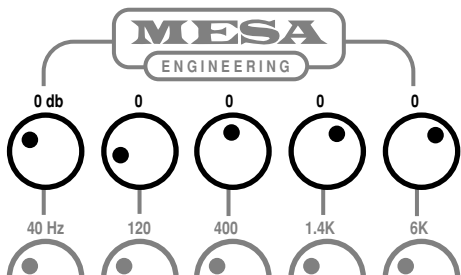

This is a good place to mention again that, because of the strength of the 5 **GAIN** controls, it is possible to very quickly go beyond the realm of balanced musical tone and blow holes in your mix. Therefore, start by building a great sound using the standard rotary **TONE** controls and then begin with subtle tweaking of the frequencies using the **PARAMETRIC**. Don't start boosting everything all over the bandwidth and

## FRONT PANEL CONTROLS: (Continued)

**GAIN CONTROLS: Parametric EQ** *Continued* expect to have a great sound. Make small moves and then allow your ears time to adjust to the difference. With controls this powerful, EQ Hangover is a part of the buzz. Don't be surprised if after tweaking for an hour with the PARAMETRIC, you go back to your starting point and think the amp is broken...it's not...your ears are suffering from an overdose of EQ.

May we suggest the old saying "less is more" applies here beautifully. More often than not, a better sound is achieved by notching (cutting) frequencies you don't want so much of with the respective GAIN control, rather than boosting them. In this way your ears can evaluate the differences better and get a bead on the next adjustment because you are not escalating the volume level as you go. More importantly, you are less likely to create a sound with excess noise.

**FREQUENCY CONTROLS:** These 5 rotary controls divide up the frequency spectrum into five sweepable Q bands that allow you to center-in on any frequency within each of the five ranges with accuracy and then cut or boost each with the accompanying

GAIN control. As you may have noticed, the bands overlap so that you can use adjacent bands to manipulate frequencies that are very close to each other, frequency-wise. For ease of understanding, you can think of the bands like this; Lows, Low-Mid, Mid, Highs and Super Highs (harmonics). This type of division can sometimes help when you are trying to identify and dial up sounds quickly.

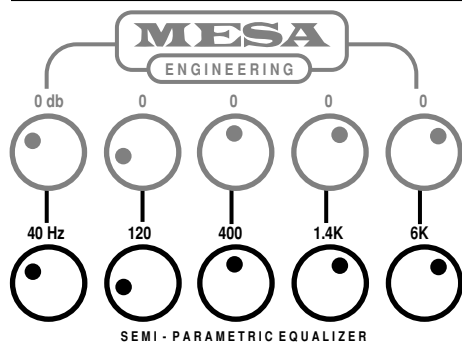

The Bands are labeled in order from low to high frequency as **40Hz, 120, 400, 1.4K** and **6K**. These numbers represent the Bands' center Q point frequency and the **FREQUENCY** control sweeps the range from the two numbers at opposing ends of the control range. For example the 40Hz Band can be set to focus on frequencies between 30 and 100Hz with 40Hz being the control Center Q found at 12:00 (straight up).

Certain frequencies are heard by the ear differently and it is a fair assumption to say that the majority of us are much more sensitive to midrange and lower-treble frequencies, while we are more "tolerant" of sub-low, low and super high frequencies. You have probably heard the soundman at many a gig say "take some 1K out of that snare or guitar mic". This high-mid frequency is often called the *pain zone* because we are extremely sensitive to these frequencies. Conversely you may have experienced someone (especially veteran house sound guys) cranking the super high frequencies 3K - 12K causing pain in others who are more sensitive to these regions. Because we all hear differently and this frequency specific sensitivity exists in all of us to a degree, it is normal for some FREQUENCY settings within the bands to seem much more powerful and others weaker for the same relevant GAIN setting. This is normal and no, your *M-PULSE* is not misbehaving. Usually the lowest (40Hz) and highest (6K) are the most susceptible to this - with the most extreme low and extreme high settings on the two controls showcasing this phenomenon. These settings may require a slightly higher GAIN setting than you are use to seeing to achieve the desired shaping result.

**NOTE:** The two high BANDS of the **PARAMETRIC EQ** may be extremely powerful and sensitive to GAIN settings, especially between 1.4K and 12K. For this reason use care with the GAIN controls in these ranges as high settings will produce unwanted background noise in the form of hiss or white noise. This is made worse if the TREBLE control is set in its higher range. If you need a sound with a large amount of these Treble frequencies in your mix, approach it from a different angle. Begin by notching lower frequencies in the other bands, as opposed to boosting the higher bands with the lower bands set more flat. This scheme will greatly improve the noise floor and still allow you to achieve the desired boost in higher frequencies.

**NOTE:** May we again humbly suggest using the **PARAMETRIC EQ** to fine-tune your sound with subtle adjustments. Much like a car with an engine capable of ridiculous speeds, the *M-PULSE* incorporates this shaping device capable of ruining a great tone in the hands of the unwary driver. Use this powerful tool with taste and music in mind and avoid settings that are so extreme that they blow holes in what could otherwise be a great sound.

## FRONT PANEL CONTROLS: (Continued)

**COMPRESSION:** This section of your *M-PULSE* controls the processing of dynamics and this in turn, feeds the *SIMUL-STATE* power section. It is another powerful tool that should be used with taste as it also has the power to be easily misused resulting

in an unnatural sound with slaughtered dynamics. Most experienced players use compression minimally, but there are times when a radical compression effect is in order and the *M-PULSE* is capable of the entire range of signature compression characteristics.

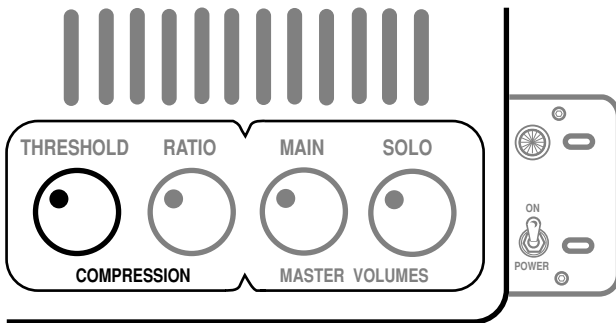

It is comprised of three elements and these are the Program toggle switch, the THRESHOLD control and the RATIO control. Like the PARAMETRIC it can also be programmed ON (in all the time), OFF (out all the time) or F.S. (triggered remotely from the Footcontroller).

**THRESHOLD:** This control is like an input sensitivity meter to the compressor. Think of it this way; the lower the setting (toward 0db), the less sensitive the input and therefore the bigger the signal it takes to activate the compressor. As the **THRESHOLD** is swept

toward -40 the input becomes increasingly more sensitive and a smaller signal will be required to bring the compressor into action. At a maximum setting of -40 the COMPRESSOR will be basically "on" all the time as it's input will begin to trigger compression at -40db of whatever your input signal is, making this extremely sensitive. To achieve a subtle and musical compression effect, try using a relatively low RATIO setting and then set the **THRESHOLD** so that compression begins with only your most dynamic (hardest) hits of the strings, which will probably occur somewhere in the vicinity of 9:00 - 10:30 with most basses. Experiment with the way your instrument signal responds to the **THRESHOLD** control to learn the trigger points for various effects.

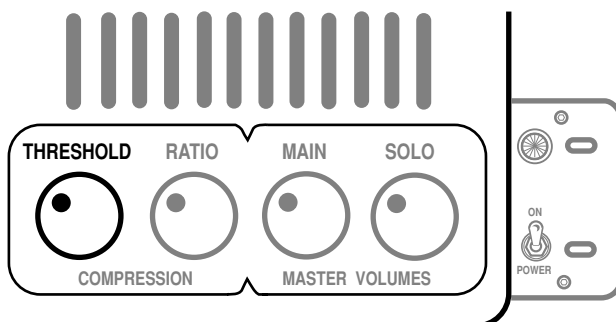

**RATIO:** As its name infers, the **RATIO** control determines the ratio of compression as it relates to the input signal. Compression may be from a subtle soft-limiting effect - to an extreme, pumping squash and anywhere in between.

At 7:30 the **RATIO** control begins with a minimal 1:1 ratio setting. This means that for every 1db of signal (over the THRESHOLD setting) there will be an equal 1db of compression. This setting works well for keeping your dynamic range consistent when recording or for thumbing styles where the pluck of the higher strings is popping out a little too much. Many of the best sounds can be found down around this range.

As the **RATIO** is dialed up toward 12:00, a whole range of useful settings appear as you sweep through the larger ratios of 2:1, 3:1, 5:1, 7:1 and so on. In this range the compression effect multiplies and a

much more definitive effect is produced. The lower settings of this range (up to 10:30) works well for thickening and "occupying mix space" while not increasing volume level.

## FRONT PANEL CONTROLS: (Continued)

**RATIO:** *Continued* From 12:00 on up to the maximum setting of “00” (Infinity) is reached at 5:30, an extremely powerful compression effect is produced - at which point the signal is fully compressed. There are very few times you will ever need this much compression, but if you ever do, it is all here in this upper range. As you might have guessed, the **RATIO** control is perhaps the best example of a case where using the lower ranges of a control with tastefulness creates the best sounds. Like many places in your amplifier, the “less is more” rule applies here. Compression is a valuable tool and can be an important part of your sound if you learn to apply it only when needed in subtle amounts.

**NOTE:** *Keep in mind that the compression **RATIO** control alone does not determine the amount of compression effect you will hear. The **THRESHOLD** must be set to your instruments' output level and your individual playing style (how hard you hit the strings) to trigger the compression circuit at the desired dynamic point. May we suggest setting the **THRESHOLD** first to the point dynamically you wish compression to begin and then use the **RATIO** control to set the desired amount of compression.*

**MAIN: OUTPUT** This basic control determines the overall final output level of your **M-PULSE** so that you can adjust the front end **GAIN** control to your tonal needs and then push the **SIMUL-STATE** power section to the desired listening level.

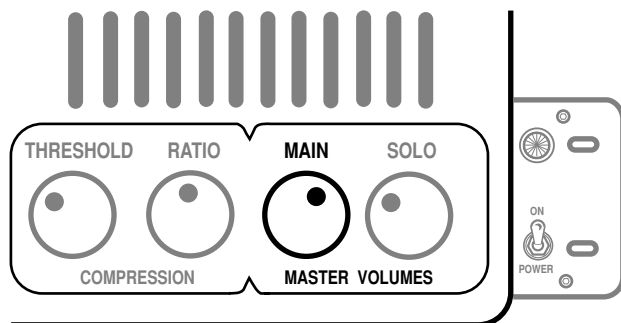

**NOTE:** *Use the **MAIN** output level control with care. The **M-PULSE** is capable of very loud output volumes that could potentially cause damage to your hearing or the hearing of others. May we suggest always beginning your set-up by zeroing-out the **MAIN** output level control to avoid accidental volume attacks on unsuspecting bandmates, engineers or audiences.*

**SOLO: Output** This control adjusts the amount of footswitchable boost in output level that occurs when the **SOLO** feature is triggered from the Footcontroller. It is defeated from the circuit when the Footcontroller is disconnected from the **FOOTSWITCH DIN** jack found on the Rear Panel. It is basically a second output level control wired in parallel with the **MAIN** output control and can be used to showcase sections of a performance by allowing you to increase your volume by a preset amount and switch to this level on the fly. It can also be used to balance volume levels when you select either the Parametric EQ, the Compressor or both from the Footcontroller.

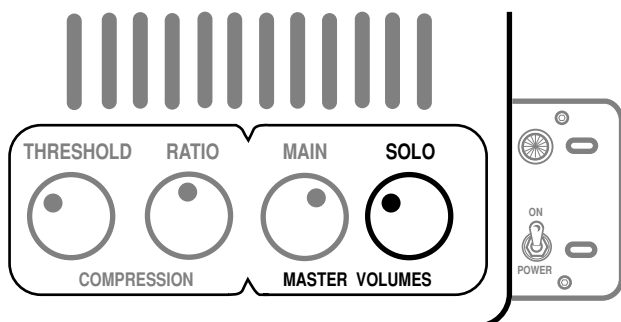

**NOTE:** *Remember when demoing the **SOLO** control that, when turned off (7:30), all signal will be muted when you select **SOLO** on the Footcontroller.*

**POWER:** This switch delivers the A.C. power to the **M-PULSE**. Make sure the unit is grounded (all three terminals of the A.C. power cord must be connected whenever possible to avoid injury to the user as well as to the amplifier). Also, make sure that the proper voltage requirements are present at the A.C. wall socket receptacle.

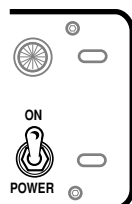

**NOTE:** *As a reminder, never alter the A.C. power cord in anyway for possible damage to the amplifier may occur not to mention the possibility of a fire outbreak.*

# REAR PANEL CONTROLS:

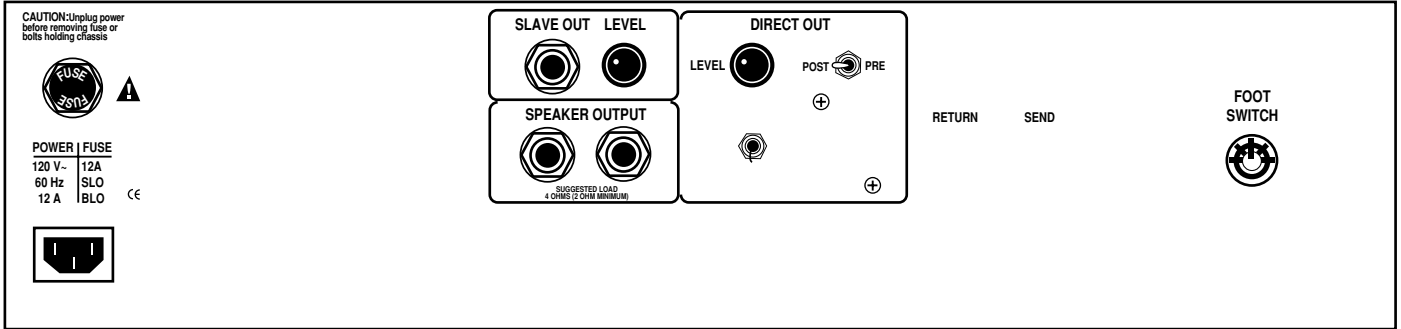

**FUSE:** This is the A.C. Mains Fuse for the *M-PULSE* REPLACE ONLY WITH A SLO-BLO TYPE FUSE OF THE PROPER RATING. THIS IS EXTREMELY IMPORTANT, AS THE *M-PULSE* DRAWS A SUBSTANTIAL AMOUNT OF CURRENT AT HIGH OUTPUT LEVEL SETTINGS.



**FUSE RATING (USA) 12 A S.B. / 120 VOLTS**

**AC RECEPTACLE:** The removable “Euro” Style” A.C. cord that is supplied with the *M-PULSE* makes set-ups and tear-downs after the gig a snap. It also makes de-racking much easier when you wish to remove the unit from a hard wired rack system where all the A.C. cords have been cabled in. Additional heavy duty cords are available should you ever need one...simply call us direct and we can ship one directly to you for a nominal charge, plus shipping cost. Make sure the A.C. cord is firmly in its socket (receptacle) before powering up the amplifier.

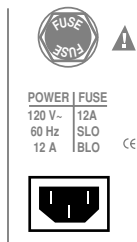

**NEVER ALTER THE THREE PRONG POWER CORD IN ANY WAY.**

**CAUTION: NEVER BLOCK AIR VENTS**

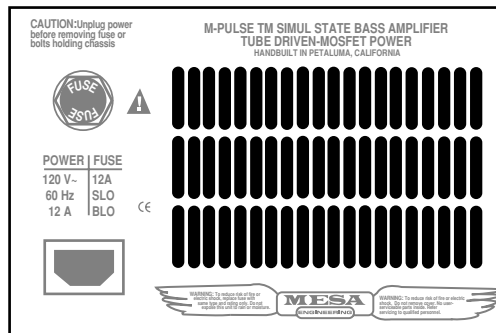

**CAUTION: NEVER BLOCK AIR VENTS**

**NOTE: NEVER BLOCK OR ALTER AIR ANY OF THE VENTED AREAS ON THE REAR PANEL OF THE AMPLIFIER. Damage to the unit is imminent and so is the risk of fire.**

## REAR PANEL CONTROLS: *(Continued)*

**SLAVE OUT:** This 1/4" jack and control provide a signal derived from the speaker jack. Perfect for using the *M-PULSE* as a master pre-amp, or slaving to additional power amps for more power when needed. Some players use the **SLAVE** to derive an FX Send Signal and go to other amps for their wet sound.

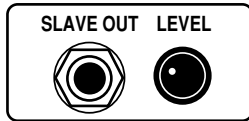

**NOTE:** When the **SLAVE OUT** is used to obtain a signal for driving an external processing device or rack of effects, you must route the output of the last effect to another amplifier and not back to the *M-PULSE*.

**Once signal has been taken from the SLAVE jack, it cannot be connected to the EFFECTS LOOP**

**RETURN** jack of the same *M-PULSE* or a feedback loop will occur producing a squeal.

**SPEAKER OUTPUT:** The *M-PULSE* provides two 1/4 inch speaker jacks for powering speaker enclosures. The recommended speaker load impedance for the *M-PULSE* is 4 Ohms at which the mighty *SIMUL STATE* power section is capable of delivering a whopping 625 watts RMS before clip and peaks of over 2000 watts! A speaker load of 8 Ohms may also be used though the overall power will be reduced to roughly 300 watts using this rate of impedance.

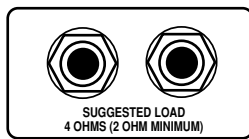

**DIRECT OUT:** This section captures the entire pre-amp signal including the Parametric EQ, the Compressor and the Effects Loop and allows you to send a Balanced signal to either a House Main Board or a Recording console. There are four elements to this circuit which are; (1) a male XLR jack, (2) a LEVEL control, (3) a POST / PRE switch and (4) a GROUND LIFT switch. Here are their functions and how to use them.

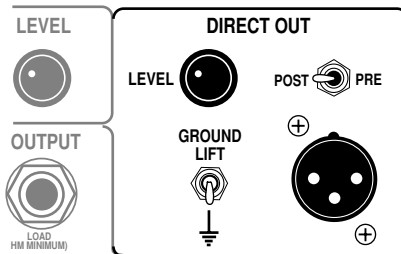

**LEVEL:** This rotary control allows you to set an appropriate level for the Direct Signal to match the input sensitivity of the console. It is always best to start with the LEVEL control zeroed-out before connecting a cable to the DIRECT output. This practice will help to avoid accidental damage to the speakers or your engineers' ears from too hot a setting upon hitting your first note.

**POST / PRE:** This switch lets you choose the type of signal you wish to send to the console. **POST** gives you the entire sound of the pre-amp with the Parametric EQ, Compressor and the Effects Loop (including processing from anything in the loop).

**PRE** gives you just the sound of your instrument and no *M-PULSE* enhancement so that an engineer can create their own sound with your unprocessed signal at the console. This is very handy for sound reinforcement applications as the sound you use on stage may be too big with enhanced low end for a large venue house application.

**GROUND LIFT:** This switch removes the circuit-to-chassis ground connection from the XLR jack. Leave it in the grounded position (switch down) normally unless you experience a hum when connecting to a console. If you do experience a hum when connecting the XLR Output to a console, try lifting the ground (switch up) on the circuit. This will usually (but not always) remedy most ground loop type noise from the signal path. Sometimes it may also be necessary to lift the A.C. Cable Ground also by using a 3-2 ground adapter to achieve a quiet signal path.

**NOTE:** Ground loops can occur in many places in a complex signal path. The DIRECT OUTPUT GROUND LIFT switch is not a cure-all and therefore should not be expected to remedy every type of ground related problem.





# FACTORY SAMPLE SETTING

## Huge & Round (Parametric EQ Optional)

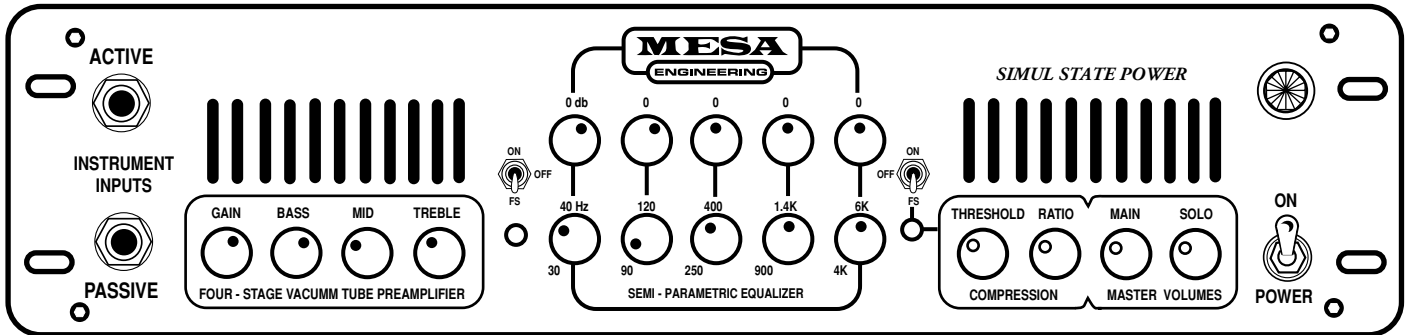

## Scooped R & B

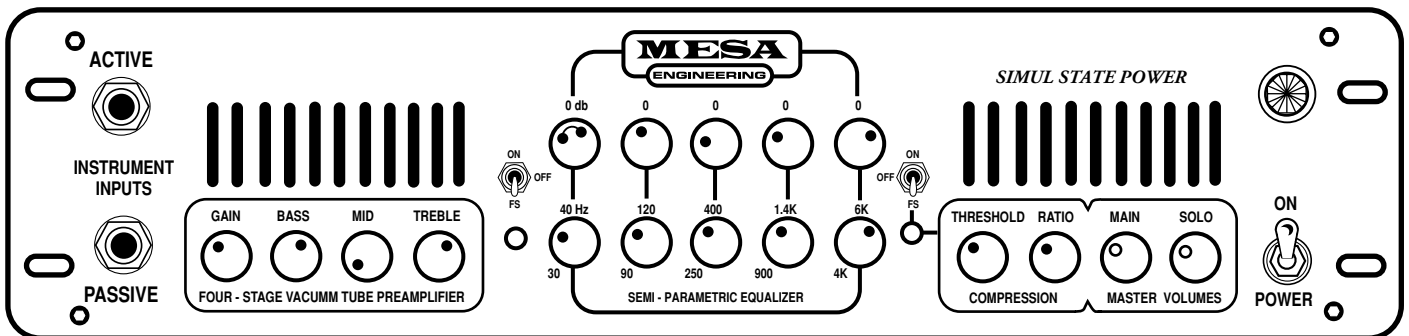

## Articulate Solo

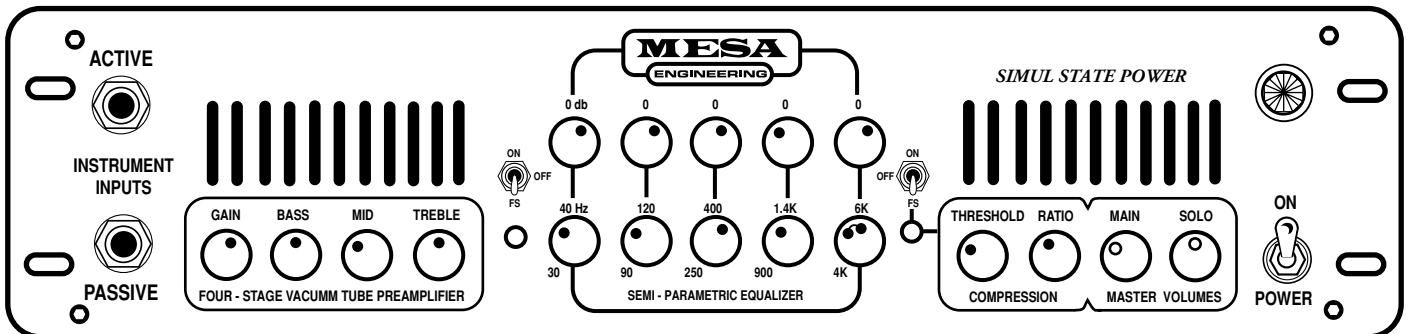

## Driving Rock (Parametric EQ Optional)

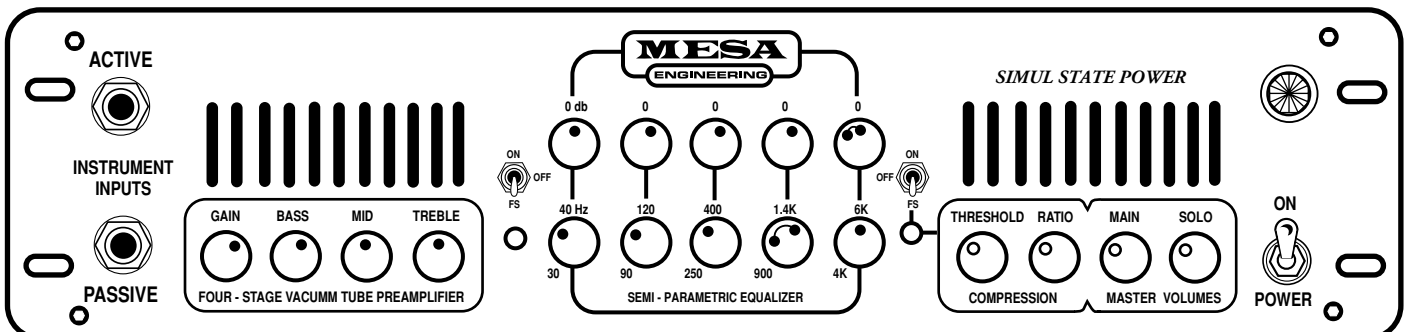

# FACTORY SAMPLE SETTING

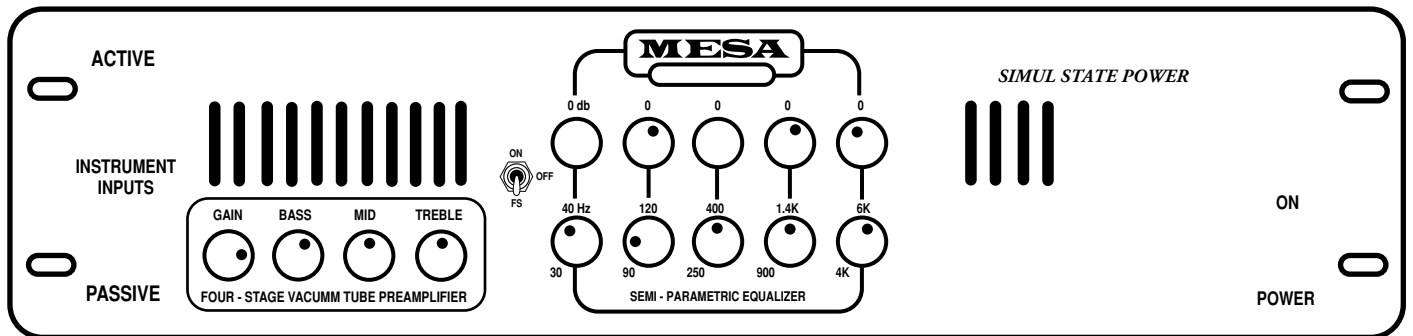

## Pizzicato

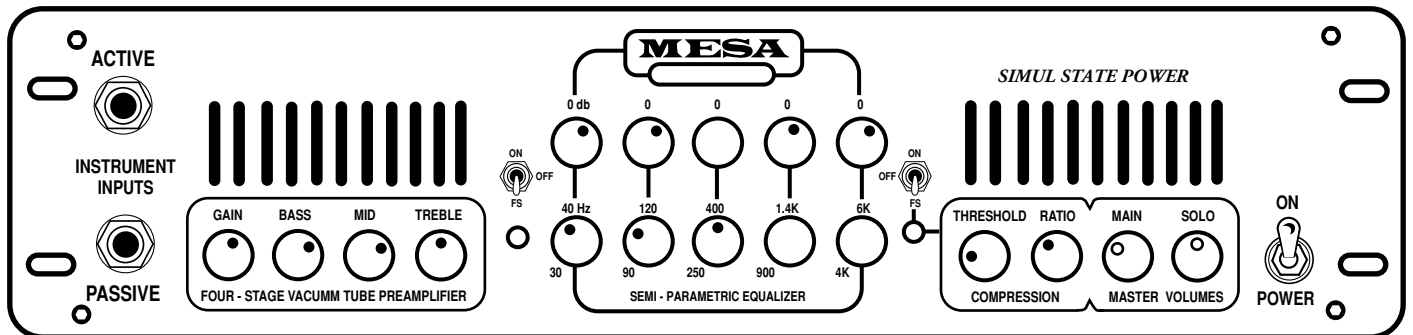

## **TUBE NOISE & MICROPHONICS**

You may occasionally experience some form of tube noise or microphonics. Certainly no cause for alarm, this quirky behavior comes with the territory and the Tone. Much like changing a light bulb, you don't need a technician to cure these types of minor user serviceable annoyances and in fact, you'll be amazed at how easy it is to cure tube problems...by simply swapping out a pre-amp or power tube!

First may we suggest that you set the amplifier up on something so that you can get to the tubes comfortably without having to bend down. It also helps to have adequate lighting as you will need to see the tube sockets clearly to swap tubes. **Use caution and common sense when touching the tubes after the amplifier has been on as they may be extremely hot!** If they are hot and you don't want to wait for them to cool off, try grasping them with a rag and also note that the glass down around the bulbous silvery tip is considerably less hot which makes it easier to handle. Gently rock the tube back and forth as you pull it away from its socket.

## **DIAGNOSING PRE-AMP TUBE PROBLEMS:**

Because your amplifier is an all tube design, it is quite possible that you will at some point experience minor pre-amp tube noise. Rest assured - this is no cause for alarm and you can take care of the problem yourself in a matter of minutes by simply swapping tubes.

Let us begin by saying; It is a "very good" idea to keep at least a couple of spare pre-amp tubes on hand at all times to insure uninterrupted performance. These minor pre-amp tube problems can take many forms but can generally be described in two categories: Noise and Microphonics. Noise can be in the form of crackling, sputtering, white noise/hiss and/or hum. Microphonic problems usually appear in the form of a ringing or high pitched squealing that gets worse as the gain or volume is increased thus are more noticeable in the higher gain "HI" modes. Microphonic problems are easily identified because the problem is still present even with the instruments' volume off or unplugged altogether - unlike pick-up feedback which ceases as the instrument is turned down. Microphonic noise is caused by mechanical vibration and shock: think of banging a microphone around and you'll understand where the word came from.

The best way to approach a pre-amp tube problem is to see if it occurs only in one specific mode or channel. This should lead you to the tube needing replacement. Then all that remains is to swap the suspect tube for a known good performer. If you cannot narrow down the trouble to a specific mode or channel, the problem may be the small tube that drives the power tubes which is operational in all modes and channels. Though rare, a problem with the driver tube would show up in all aspects of performance - so if you can't narrow the problem down to being mode or channel specific, you may want to try replacing the driver tube. Driver problems generally show themselves in the form of crackling or hum in all modes of performance and/or weak overall output from the amplifier. Occasionally an anemic driver tube will cause the amplifier to sound flat and lifeless, but this is somewhat uncommon, as worn power tubes are a more likely suspect for this type of problem.

# PERSONAL SETTINGS PAGE

ACTIVE  
INSTRUMENT INPUTS  
PASSIVE

FOUR - STAGE VACUUM TUBE PREAMPLIFIER

MESA ENGINEERING

SEMI - PARAMETRIC EQUALIZER

SIMUL STATE POWER

THRESHOLD RATIO MAIN SOLO  
COMPRESSION MASTER VOLUMES

POWER

Detailed description: This panel features a 'MESA ENGINEERING' logo at the top center. On the left, there are two input jacks labeled 'ACTIVE' and 'PASSIVE', and a 'FOUR - STAGE VACUUM TUBE PREAMPLIFIER' section with four knobs labeled 'GAIN', 'BASS', 'MID', and 'TREBLE'. The center section is a 'SEMI - PARAMETRIC EQUALIZER' with five frequency sliders (0 db, 40 Hz, 120, 400, 1.4K, 6K, 4K) and two 'ON/OFF' switches with 'FS' labels. On the right, there is a 'SIMUL STATE POWER' section with four knobs labeled 'THRESHOLD', 'RATIO', 'MAIN', and 'SOLO', and two sub-sections labeled 'COMPRESSION' and 'MASTER VOLUMES'. A 'POWER' switch is located on the far right.

ACTIVE  
INSTRUMENT INPUTS  
PASSIVE

FOUR - STAGE VACUUM TUBE PREAMPLIFIER

MESA ENGINEERING

SEMI - PARAMETRIC EQUALIZER

SIMUL STATE POWER

THRESHOLD RATIO MAIN SOLO  
COMPRESSION MASTER VOLUMES

POWER

Detailed description: This panel is identical in layout to the first one, featuring the same 'MESA ENGINEERING' logo, input jacks, preamplifier knobs, equalizer sliders, and power/compression controls.

ACTIVE  
INSTRUMENT INPUTS  
PASSIVE

FOUR - STAGE VACUUM TUBE PREAMPLIFIER

MESA ENGINEERING

SEMI - PARAMETRIC EQUALIZER

SIMUL STATE POWER

THRESHOLD RATIO MAIN SOLO  
COMPRESSION MASTER VOLUMES

POWER

Detailed description: This panel is identical in layout to the first one, featuring the same 'MESA ENGINEERING' logo, input jacks, preamplifier knobs, equalizer sliders, and power/compression controls.

ACTIVE  
INSTRUMENT INPUTS  
PASSIVE

FOUR - STAGE VACUUM TUBE PREAMPLIFIER

MESA ENGINEERING

SEMI - PARAMETRIC EQUALIZER

SIMUL STATE POWER

THRESHOLD RATIO MAIN SOLO  
COMPRESSION MASTER VOLUMES

POWER

Detailed description: This panel is identical in layout to the first one, featuring the same 'MESA ENGINEERING' logo, input jacks, preamplifier knobs, equalizer sliders, and power/compression controls.

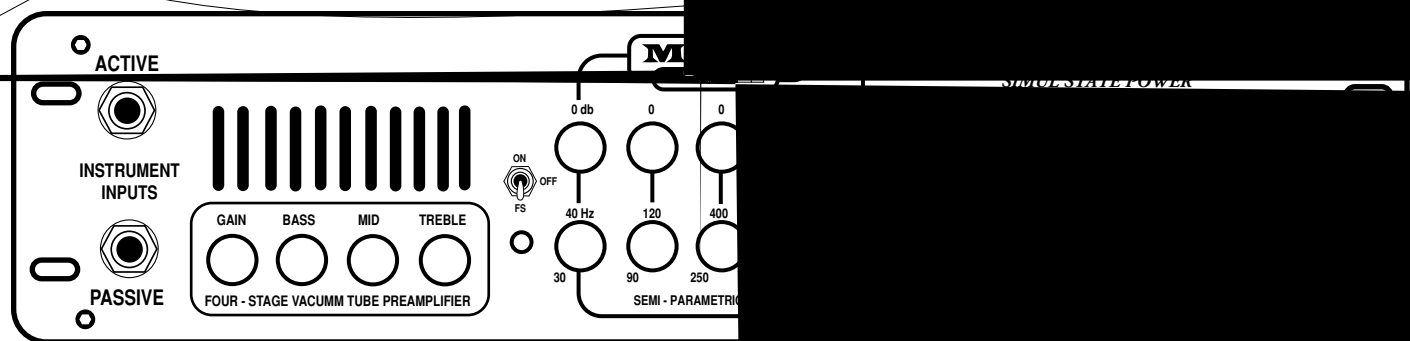
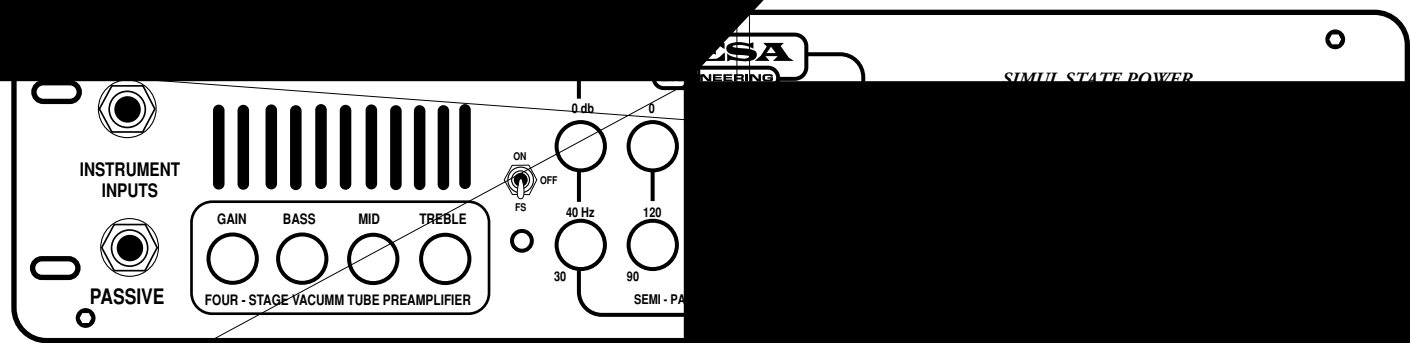
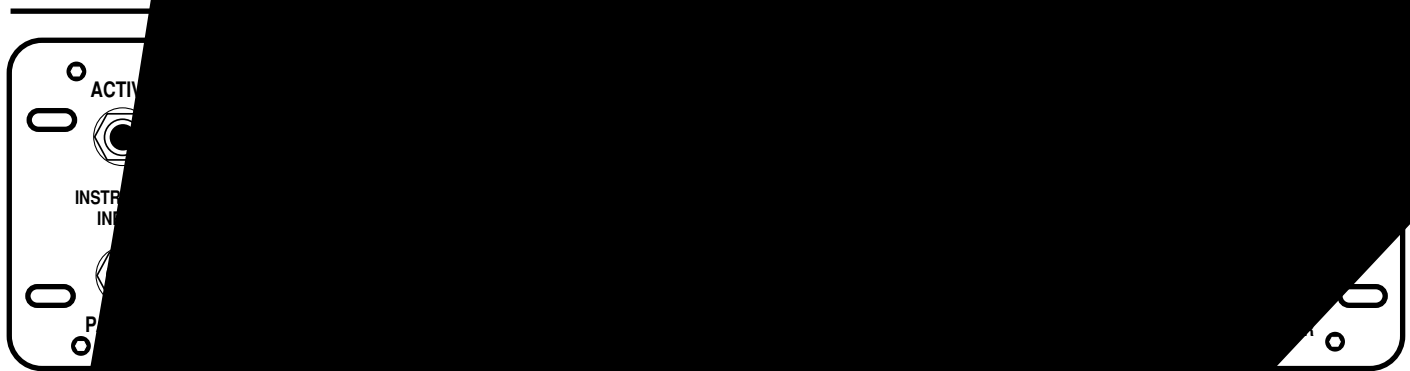

# FRONT PANEL CONTROLS:

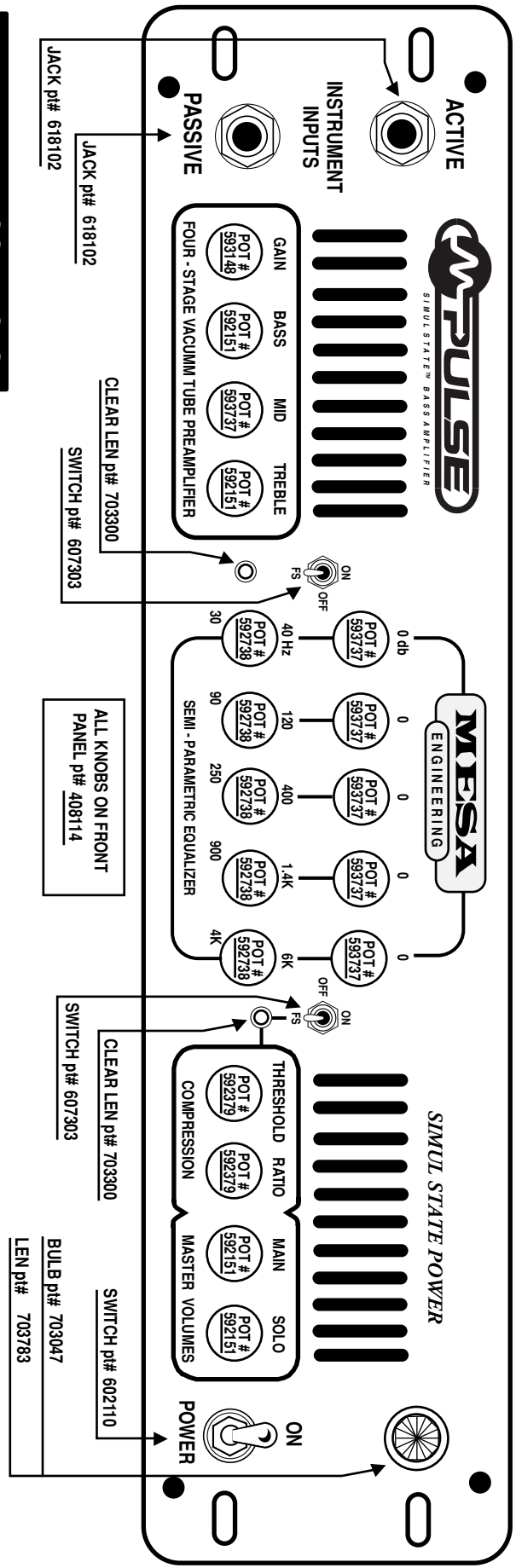

# REAR PANEL CONTROLS:

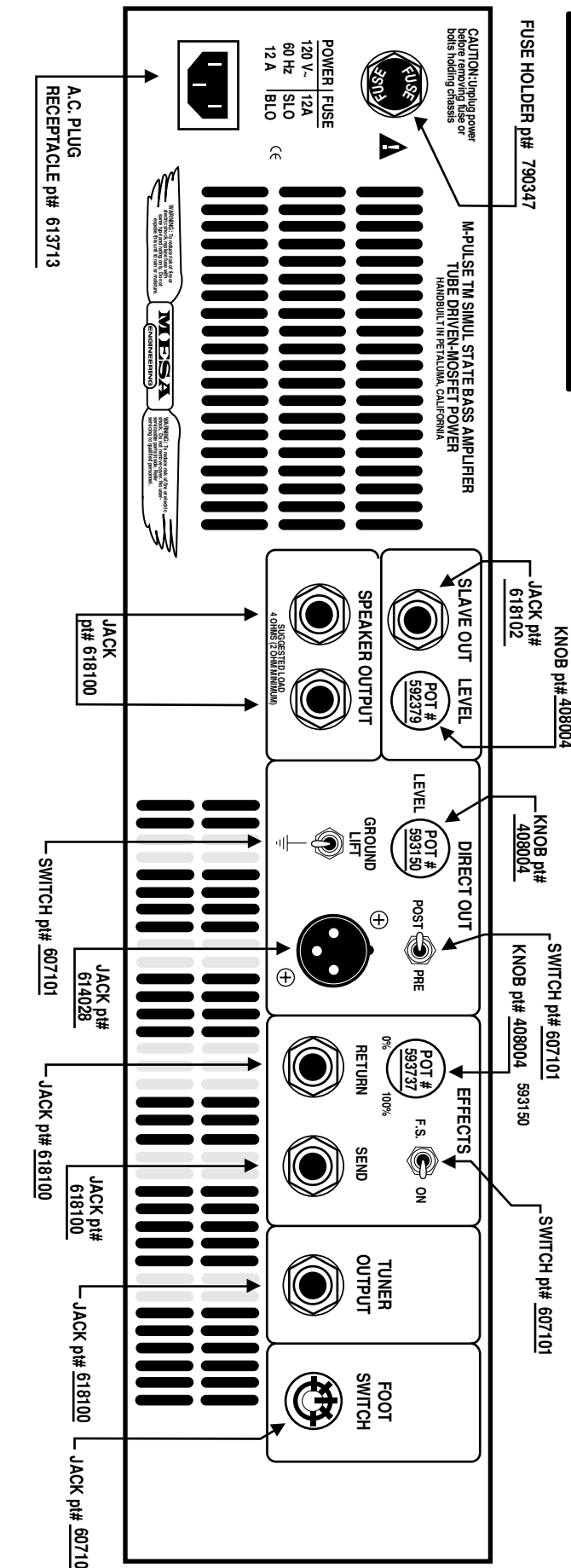

# ***MESA/BOOGIE***

*The Spirit of Art in Technology*

*Thank you for trusting MESA/Boogie to be your amplifier company and we wish you many years of toneful enjoyment from this handbuilt all tube instrument.*

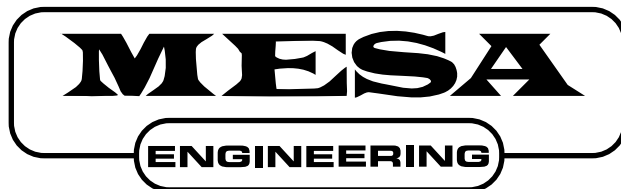

*The Spirit of Art in Technology*



*(707) 778-6565      FAX NO. (707) 765-1503*

*1317 Ross Street Petaluma, CA 94954*

*USA*



## Free Manuals Download Website

<http://myh66.com>

<http://usermanuals.us>

<http://www.somanuals.com>

<http://www.4manuals.cc>

<http://www.manual-lib.com>

<http://www.404manual.com>

<http://www.luxmanual.com>

<http://aubethermostatmanual.com>

Golf course search by state

<http://golfingnear.com>

Email search by domain

<http://emailbydomain.com>

Auto manuals search

<http://auto.somanuals.com>

TV manuals search

<http://tv.somanuals.com>