

*Vacuum Tube Audio*



---

# *Owner's Manual*

*1317 Ross Street Petaluma  
California 94954  
USA*

***Thank you for selecting a Mesa Engineering amplifier to be your instrument of choice in your home or studio playback system. We know how many different products you had to choose from and are honored that you have entrusted us with your hard-earned entertainment funds. We have worked hard to make your new TIGRIS amplifier the best and most comprehensive Tube Integrated we could conceive of and are confident that it will provide you with countless hours of emotional satisfaction and musical enjoyment.***

***With this owner's manual, we have attempted to answer every possible question about the TIGRIS we could think of as being asked. It is thus rather lengthy and contains much information to which you need not refer until after your first listening sessions. If you're impatient, Chapter 3 is all you should read now- it will take you through the correct hook-up procedure step-by-step and have you up and running in less than half an hour.***

***Allow the tubes to warm up for 15 minutes while you stow away the packing materials. Then make yourself comfortable with your favorite tunes and refreshments and discover what we like to call:***

***"The Spirit of Art in Technology."***

***Cheers. Randall Smith, president and chief designer - Mesa/Boogie***



## TABLE OF CONTENTS

CHAPTERS:	Page #	CHAPTERS:	Page #
1 - Precautions.....	01	5 - Advanced Features ( <i>Continued</i> )	
2 - Overview.....	1-2	5 - 2 Power Tube Blend.....	11
3 - Installation.....	3	5 - 3 Headphone Output.....	11
3 - 1 Unpacking.....	3	5 - 4 Auto Bias.....	11-12
3 - 2 Location.....	3	5 - 5 Class A Operation.....	13-14
3 - 3 Speaker Binding Posts.....	3-4	6 - On Triodes, Pentodes & Irishmen.....	14-15
3 - 4 Hook-Up Options.....	4-6	6 - 1 Triodes.....	15-16
A: Line Level Inputs.....	4-5	6 - 2 Pentodes.....	16-17
B: Subwoofer.....	5	7 - Tube Maintenance & Tube Rolling.....	17
C: Surround Sound Processor.....	5	7 - 1 Maintenance Plan.....	17
D: Bi-Amplification.....	5-6	7 - 2 Tube Rolling.....	17
3 - 5 Detachable Power Cord.....	6-7	8 - Evolution of the <b>TIGRIS</b> .....	18-19
3 - 6 A.C. On / Off Switch.....	7	9 - <b>Mesa/Boogie</b> Professional Heritage.....	19
3 - 7 Warm / Operate Switches.....	7	10 - Customer Service.....	20
3 - 8 Grounding Switch.....	7-8	11 - Trouble Shooting.....	20-21
3 - 9 Congratulations.....	8	12 - On Specs Versus Performance.....	21
4 - On Break-In.....	9	13 - Basic Specs.....	22
5 - Advanced Features.....	9-14	14 - Warranty.....	22-24
5 - 1 Tandem-State Imaging.....	9-11	14 - 1 With the US.....	22
A: Triode / Pentode Switching.....	9-10	14 - 2 Outside of the US.....	22
B: Adjustable Negative Feedback.....	10-11	Registration Form.....	23-24



Your *Mesa* Engineering amplifier is a professional instrument. Please treat it with respect and operate it properly.

### USE COMMON SENSE AND ALWAYS OBSERVE THESE PRECAUTIONS:

- **Do not expose** amplifier to moisture, rain or water, direct sunlight or extremely high temperatures.
- **Always insure** that amplifier is properly grounded.
- **Always unplug** A.C. power cord before changing fuse or any tubes.
- **When replacing** fuse, only use same type and rating.
- **Avoid direct** contact with heated tubes.
- **When handling** tubes, use gloves or a paper towel to prevent getting oils from your skin in contact with the tube's glass envelope. This could cause premature tube failure.
- **Insure adequate** air circulation around your amplifier.
- **Use tube** cage in the presence of small children and animals.
- **Be sure** to connect to an A.C. power supply that meets the power supply specifications listed on the rear of the unit. This is especially important if you use your amplifier in a country other than the USA. Check that the voltage indicated on the rear chassis matches that of your country's line voltage.
- **If there** is any danger of lightning occurring nearby, remove the power plug from the wall socket in advance.
- **To avoid** damage to your speakers and other playback equipment, turn off power to all related components before making any connections.
- **Do not** use excessive force in handling control buttons and switches.
- **Remove** the power plug from the A.C. mains socket if the unit is to be stored for an extended period of time.
- **Do not** use solvents such as benzene or paint thinner to clean the unit. Wipe off the exterior with soft cloth.
- **Do not** remove rubber feet. This would restrict air flow underneath the amplifier and could result in damage due to overheating.
- **Do not** install in enclosed space unless proper ventilation is provided.
- **In the** unlikely event of massive tube failure (arcing and lightning inside the glass envelop), immediately turn off power and disconnect power cord.
- **Do not** remove any chassis parts to get inside your amplifier. There are no user-serviceable parts inside. Tube amplifiers operate with very high voltage. Unskilled repair attempts could result in serious injury. Leave repairs to qualified technicians.

**YOUR AMPLIFIER IS CAPABLE OF VERY HIGH VOLUMES. EXPOSURE TO EXCESSIVE PLAYBACK LEVELS CAN RESULT IN PERMANENT HEARING DAMAGE. THIS IS ESPECIALLY TRUE FOR HEADPHONE LISTENING!**

# *Tigris* Operating Instructions

## Chapter 2 OVERVIEW:

Your new Mesa TIGRIS is an audiophile amplifier with a musical heritage. More than just a playback amp, the TIGRIS is a musical instrument in its own right, handbuilt with the same commitment and passion that we bestow upon our entire line of Mesa/Boogie products. In the realm of live performance, Mesa/Boogie products have earned a stellar reputation for 25 years of innovation, reliability, customer service and for providing the individual soul of a treasured musical instrument. The variety of musical styles played through our guitar tube amplifiers by some of the world's finest musicians might serve as a model of what you can expect from the TIGRIS: true fidelity to the soul of your favorite music...and the flexibility to account for many different hook-up options, system interfaces and listening preferences.

Our first High-End product, the Mesa BARON, established somewhat of a cult following as early as 1987, eight years prior to first production. During an audiophile society demonstration of a BARON prototype, a famed designer demanded to purchase the very unit on the spot. The Audio Critic publication called this early BARON truly astonishing and an embarrassment to the high-end tube scene in the audiophile market. The legions of working musicians already relying on our support in the professional arena were such a full-time commitment for us that it took many more years of growth before we could make a similar long-term commitment to you, the music lover at home. Upon introduction at WCES 95/96, the BARON impressed many astute audio critics with its uncommon value, construction quality and impressive musical ability. Numerous superb home audio systems have been assembled since around the Mesa BARON amplifier, and our file of satisfied commentaries in BARON warranty cards is steadily expanding. However, it also has become clear to us that in many respects, our flagship BARON is more amp than a lot of people actually need, with power output so prodigious that only a minority of listeners will ever experience its full capability.

So the desire was born to design a less powerful amplifier that would offer comparable quality, but be more affordable. For most universal appeal, we decided on the integrated amplifier model as our second High-End entry. An integrated amplifier combines all the virtues of separate components, but simplifies the interface between the pre- and power amplifiers by building them into a common chassis. This eliminates the need for careful impedance matching between two separate components and the cable connecting them. It also frees the engineer to optimize the performance between these two stages to work as a fixed unit. Separate components, on the other hand, have to be designed for maximum compatibility to accommodate the ever growing number of available partnering components. By definition then, affordable separate components will rarely be as finely tuned a design as an integrated component, and only in very expensive separate components can the design limitations inherent in maximum compatibility be successfully addressed. The ultimate "designer's dream" would be to build a complete system where nothing is left to chance, every variable removed. This would include speakers and cabinetry - exactly as we do with our many guitar amplifiers. With the TIGRIS, the critical parameters of your system's center, the pre-amp / power-amp - have indeed been optimized. Beyond that, your choice of associated components will reflect your personal preferences and needs, allowing you to customize, change and grow.

The TIGRIS was designed to work well in most every system by offering real-world drive capability. It will work equally well with dynamic, planar or electrostatic speakers of efficiencies as low as 83 dB. For applications requiring extreme output levels due to very low efficiency speakers, extra large room volumes, listening habits or a combination thereof, the TIGRIS is thoughtfully set up for easy bi-amplifying without the need for an external crossover or attenuator. Beginning with the basic premise of the integrated design, we looked at features audiophiles and music lovers would want. Some of these features, represented by visible knobs, switches, input and output jacks, are discussed in Chapter 3, Installation. Advanced features and those which aren't visible to the eye, but equally important, are discussed in Chapter 5.

We assume that you must now be eager to leave the printed word behind and hear for yourself, in your home, how all of this technical stuff translates to heavenly sonics. Please, do read through this owner's manual first. If you are an old hand at system set-up and confident that you don't need our manual, be sure that you have connected your speakers via speaker cable to the speaker output terminals of the TIGRIS before you do anything else. Turning on a tube amplifier without a load connected to the output terminals can cause serious damage to the amplifier, especially if you accidentally run signal into it. Such damages are NOT covered by the warranty. So, prevent yourself from making such a costly mistake and connect your speakers even before plugging in the

**2 - OVERVIEW: (Continued, Chassis Illustrations)**

**FRONT VIEW: TIGRIS**



**TUBE BAY: TIGRIS**

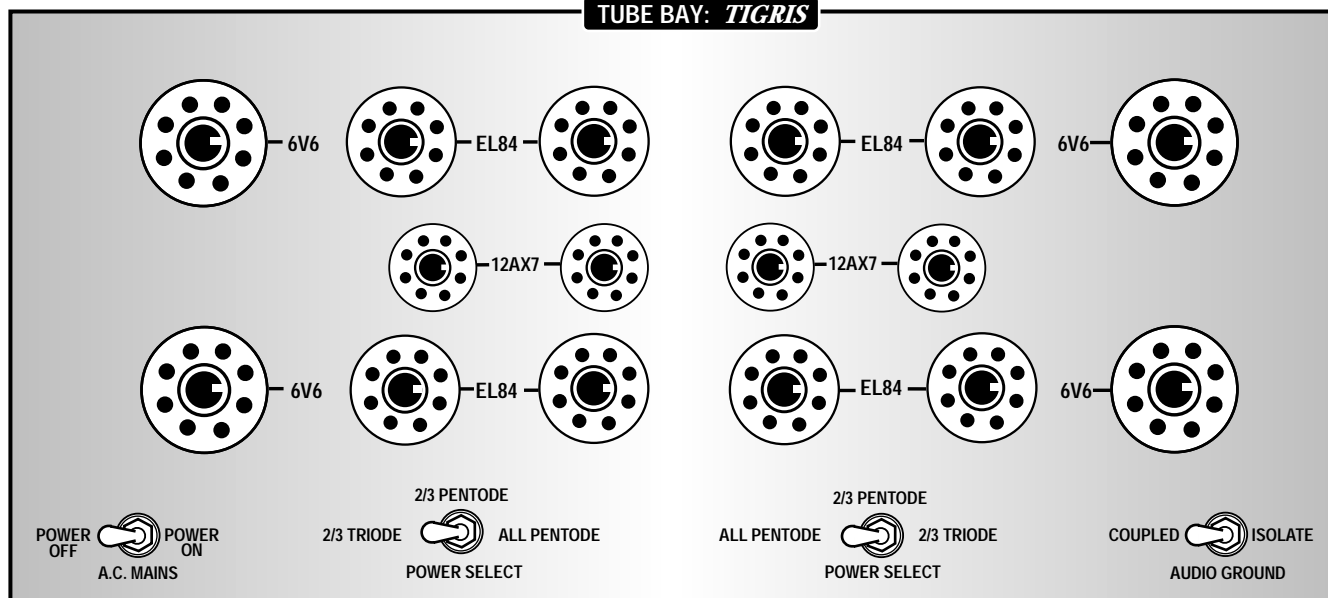

**REAR BAY: TIGRIS**

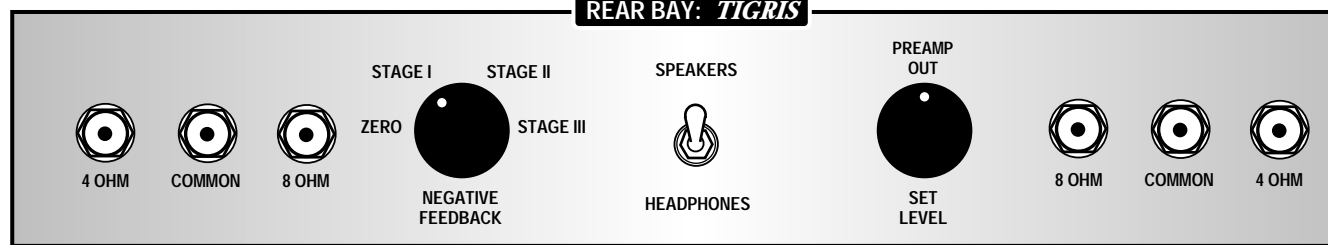

**REAR PANEL: TIGRIS**

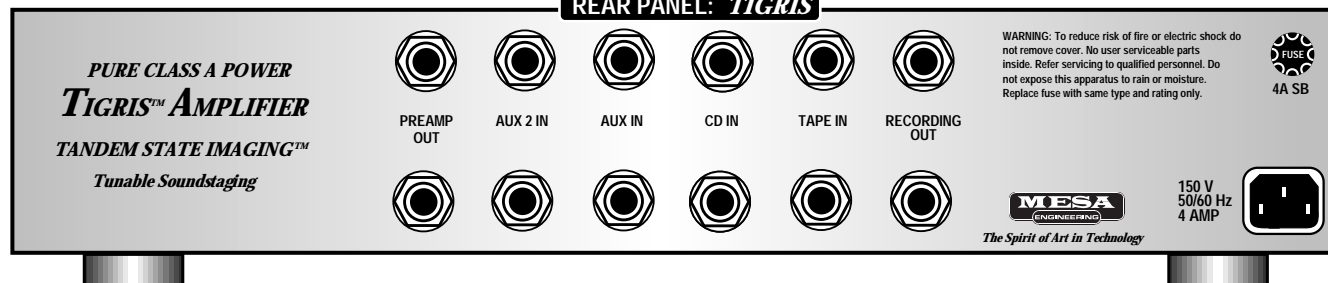

## Chapter 3 INSTALLATION:

### 3-1 UNPACKING:

power cord! Please retain the packing materials for future use and store in a cool, dry place. Should your TIGRIS ever require service at the factory, it is mandatory to ship the amplifier in the original packing materials to prevent in-transit damage. Also, should you change your living quarters, you'll be glad to have this packing to protect your investment from the hazards of moving.

### 3-2 LOCATION:

The ideal location for the TIGRIS would result in the shortest lengths of speaker cable and interconnects. If you have to favor one over the other, we recommend keeping the speaker cable as short as possible. Being a Class A biased vacuum tube device, the TIGRIS produces considerable heat. Care needs to be exercised to insure proper ventilation. If the surrounding area includes objects, shelving or cabinetry, you should check temperatures after initial use to insure that nearby materials remain cool to the touch.

Do not remove the rubber feet. This would rest the amplifier directly on the bottom panel and prevent airflow to the transformers which could cause serious damage due to overheating. If you plan to experiment with cones or tiptoes, place them under or next to the rubber feet. The later option temporarily bypasses the factory-supplied footers and allows you to evaluate the sonic results of the aftermarket cones. If you plan to place the TIGRIS directly on a carpet, insert a slab of stone between it and the carpet, especially if your floor covering has long fibres - otherwise even with the rubber feet, airflow will be restricted. The top shelf of a medium-height equipment rack would be the most ideal placement. If you decide on an enclosed location, make sure you leave room for adequate ventilation or install a temperature-sensing whisper fan.

### 3-3 SPEAKER BINDING POSTS:

Once you have determined your optimum location for the TIGRIS, proceed to connect your speakers to the four-way binding posts on the Rear Bay. These binding posts are identical to those used on the BARON amplifier and some of the finest available. Do not connect the power cord yet!

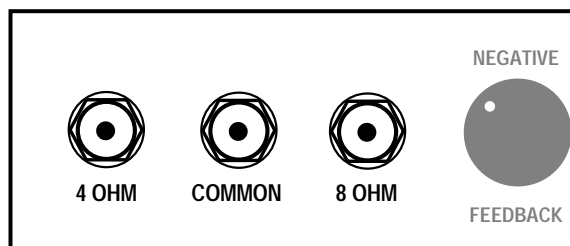

You'll notice three posts per channel. The red center post is the Ground / Common, the grey the 8 Ohm tap, and the black the 4 Ohm tap. Because the TIGRIS inverts phase, you must use either the 8 or 4 Ohm post for the ground lead, and the center post for the hot lead. This is why the center post features the red marking as a visual reminder!\*

However, use the common method on the speaker terminals - reverse the hot-ground only on the amplifier terminals. On most speaker cable, hot is referenced with the color red or "+" markers, and ground with the

color black, white or "-" markers. If your identifications are different, don't worry. Merely insure that you reverse your connections on the amplifier, not the speaker end - do not use the same lead for hot on both sides. If you make a mistake, your speakers will be wired out-of phase. This does not cause any damage, but can make some recordings sound less than optimal. If you accidentally wire one speaker in-phase, the other out-of-phase, you will experience partial cancellation in bass output. This is easily remedied by re-connecting the speaker cable properly.

\* If you have a CD-only system and your CD player or separate D/A converter offers a phase switch, you can compensate for the phase rotation of the TIGRIS by selecting the 180° setting. You could then maintain the usual practice for speaker connection and use the red common terminal of the TIGRIS for the ground lead of your speaker cable. Don't use both 8 Ohm and 4 Ohm posts together, not even for bi-wiring!

How should you determine which tap to use, 8 or 4 Ohm? Mathematically, it seems a given that a speaker with a nominal 4 Ohm rating or lower should be connected to the 4 Ohm tap. However, experience indicates that sometimes a connection to the 8 Ohm tap

### 3-3 SPEAKER BINDING POSTS: ( Continued )

sounds superior - or vice versa. Trust your ears! You will not cause damage to your speakers or the TIGRIS by mismatching. Experiment to obtain the most pleasing results! Spades or steel spring bananas, gold- or rhodium plated, are the preferred cable terminations. Spades may be stacked for bi-wiring, or you can use spades and bananas simultaneously. Bare wire should be dressed with solder to prevent strays and offer the binding post lugs a firm and even contact. Biwiring requires two pairs of binding posts on the speakers and runs separate leads to either set. Both leads connect at the amplifier, while the shorting straps or bars at the speaker terminals are removed. In theory, separating the high- and low frequency driver elements in the loudspeaker reduces possible interference caused by back EMF from the bass driver to the treble unit, but not all speaker designers agree. A definite side benefit is the increased current capability of doubling the amount of conductors. Before you spend extra money to add second runs of speaker cable, use your existing pair of speaker cable to run one speaker in mono and compare single- and bi-wire hook-up - testing speakers monaurally is actually the most exacting method to determine tonal changes and distortion artifacts because you remove the distractions of stereo effects and imaging.

Hand-tighten the lugs first, then add a quarter turn with a small wrench if necessary. Do not overtighten! The threads on these posts are very fine, and automobile tire-like torque will strip them.

### 3-4 HOOK-UP OPTIONS:

A: Line Level Inputs - The TIGRIS offers four line level RCA single-ended inputs, with corresponding positions on the front-mounted input selector - CD, Tape, Aux 1, Aux 2. For convenience's sake, these inputs have been labeled. Remember, however, that with the exception of a turntable, these inputs are fully interchangeable to accommodate the components that you wish to hook-up.

For example, if you do not presently own a CD player but have two tape decks, a tuner and a TV, you may connect those components without worry. You will only have to remember that the CD input now corresponds with the TV, tape II with Aux 1 - or however you have arranged your connections.

The inputs and outputs are arranged in two horizontal rows, with the left channel jacks, marked white, in the lower row and the right channel jacks, marked red, in the upper row. The two output terminals are the outermost left and right pairs, with all the input terminals inbetween. Each pair is clearly marked.

If you are not sure whether you have accidentally reversed channels, use a classical recording to check the location of the violins and double basses- the violins should be to the left, the double basses to the right.

### REAR PANEL: TIGRIS

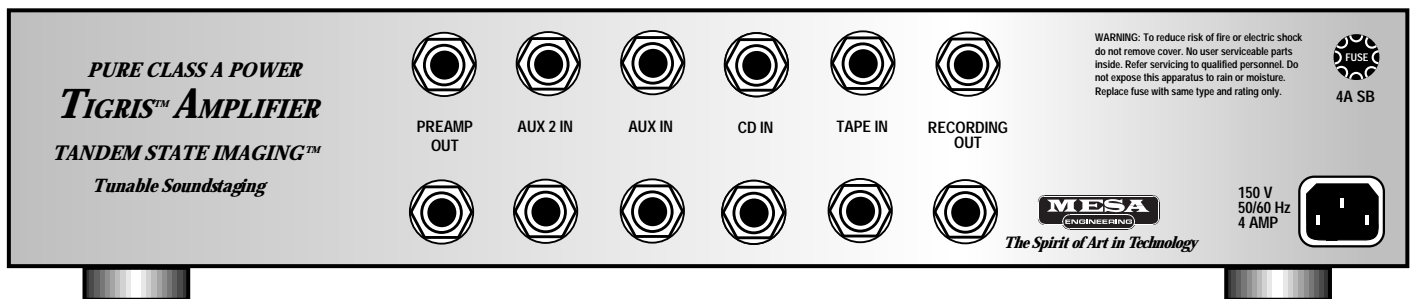

Due to its minute output ( Millivolts as opposed to the .5 or 2 Volts of a tapedeck or CD player ), a turntable is NOT a standard line level input and needs its signal preamplified and equalized for RIAA before the TIGRIS can amplify it properly. Turntable preamps, also called phono stages, are available from a variety of manufacturers such as McCormack, Parasound, Creek and others. A turntable connected to such a phono stage may now be connected to any of the inputs of the TIGRIS. Do NOT connect a turntable DIRECTLY to a line level input!

The Tape Output is a unity-level output and not controlled by the TIGRIS Volume control. Whatever incoming signal has been selected via the rotary input selector on the Front Panel, is fed through to the Tape Output. You could also consider a tape output a



### **3-4 HOOK-UP OPTIONS: (Continued)**

Y connector of sorts, because it effectively adds a second pair of outputs to every source component you own. If you want to run two systems from the same source component, you can connect a preamplifier to the Tape Output, which in turn would control a second amplifier. This of course would obliterate this output for recording purposes. To record, the Tape Outputs are connected to the inputs of an analog recording machine such as a tape deck or VCR (audio only), or the analog inputs of a digital recorder such as a DAT, CDR or Minidisc.

Again, the OUT / PLAY terminals from your tape deck connect to the jacks labeled TAPE IN on the TIGRIS, and the IN / RECORD ports of your tape deck connect to the TAPE OUT jacks on the TIGRIS. The Tape Out of the TIGRIS is NOT suitable to feed a powered subwoofer. The non-attenuated music signal will overload your subwoofer and result in excessive playback levels, with likely damage to the bass driver. Because the TAPE OUT signal is unaffected by the Volume control, a proper level balance with a subwoofer could only be achieved for one fixed volume setting, which is also true for a surround sound processor or equalizer. Thus use the Tape Outs for recording purposes only - or to feed another preamplifier if you desire two separate systems to be fed from the same source components, and don't mind losing this output for recording purposes. The TIGRIS does not have provisions for separate listen / record functions - thus connecting a preamplifier to the Tape Outs does not result in a truly independent second system; you cannot listen to two different music sources simultaneously.

Because the Tape Out derives its signal directly from the music source, you should evaluate whether connecting your tape deck causes degradation to the main signal. This will depend entirely on the match-up of components, but it is conceivable that a tubed phono preamp ( for example ) would be noticeably loaded by some tape decks. If this is the case, you should plug into the Tape Out only when you actually want to record.

**B: Subwoofer Connection** - The Preamp Output with its own dedicated Level Set attenuator is a very flexible feature that allows additional hook-up options. It is controlled by two attenuators, the front-mounted main rotary Volume control, and the "level set" attenuator located in the Rear Bay. You may connect to a powered subwoofer's line level inputs. Because the preamp output inverts phase like the speaker outputs, your subwoofer phase control should be set to 180 degrees. If your subwoofer does not allow phase compensation, then you should hook-up your main speakers with the ground leg of the speaker cable connected to the red common tap inverted hook-up. This creates a proper phase relationship between subwoofer and main speakers, a prerequisite for proper bass performance. The Level Set control should be opened ca. 25%. The subwoofer's Volume control is then used to fine-adjust the relative level of subwoofer to main speakers. This adjustment is done by ear or with the help of a sound pressure meter. You only set it once, unless the physical set-up of the speakers or subwoofer within the room, or the room itself, changes. After the subwoofer/main speaker level has been set to create an even, flat composite frequency response between the speakers and subwoofer, the TIGRIS' Front Panel Volume control will then control both main speakers and subwoofer in tandem. ( For further details on proper level matching, refer to the equivalent section below where bi-amplification is discussed.)

**C: Surround Sound Processor Connection** - If you plan to use the TIGRIS as the control center of a stereo / home theater system, you may use the Preamp Out to drive your surround sound processor. Your primary speakers, front left and right, will be driven by the TIGRIS, while the subwoofer, center and rear speakers will be fed from the surround sound processor's built-in amplifier or the multi channel amp the processor is hooked up to. Just like the previously discussed subwoofer option, the surround sound processor hook-up utilizes the Level Set attenuator in approximately a 25% open position. The speakers fed from the processor ( center and rear ) must be connected out-of-phase, with the hot and ground leads reversed, if the processor is phase-correct, and standard if the processor is phase-inverting. Your processor will have its own, built-in Master Volume control and secondary attenuators to balance the relative level of center-and rear channel speaker outputs. To adjust the balance between front, center and surround speakers, use the processor's test tone generator and the individual channel trim pots. Thereafter, the front-mounted Volume control of the TIGRIS will be the Master Volume control of your surround sound system. With a subwoofer connected to the surround sound processor, your main speakers will run full-range irregardless of what high-pass frequency the processor allows you to select. Such a processor crossover, if set to limit the response of the main, center and rear channels, will only affect the center and rear speakers because the main speaker are being driven by the TIGRIS directly.

**D: Bi-Amplification** - If you plan on vertically bi-amplifying your main speakers, ( they will need to have 2 pairs of speaker binding posts with removable bridging straps,) you may use the Preamp Out to feed your secondary power amplifier. Many speakers are designed with the option to biwire or biamp, and will in fact not offer their full performance potential until they are properly bi-amplified.

### **3-4 HOOK-UP OPTIONS: (Continued)**

Passive vertical bi-amplification does not require an electronic crossover. It simply means having two amplifiers of equal or unequal power drive the high - and low frequency drive units of your loudspeakers separately. This is different from using monoblocks where each one-channel amplifier drives only one speaker, or from horizontal bi-amping, where one 2-channel amplifier per speaker drives the high and low frequency inputs with one channel each. In a vertical bi-amplification set-up, the more powerful amplifier is dedicated to the speaker's bass drivers because they require higher power than the tweeter / midrange units.

If you have a basic stereo power amp of equal or higher power output than the TIGRIS, that amplifier can drive the woofer inputs of your speakers, while the TIGRIS' speaker outputs connect to your speaker's tweeter / midrange terminals. Because the TIGRIS is phase-inverting, the signal fed to the second amplifier is 180 degrees out-of-phase. If the second amp is a phase-correct design, the speaker leads connected to it must be inverted just like the speaker leads on the TIGRIS. If the second amp is a phase-inverting design, hook up the speaker leads in normal fashion, hot-to-hot, ground-to-ground. To account for the difference in power output and input sensitivity between the TIGRIS power amp section and your second power amplifier, you now use the Level Set attenuator on the TIGRIS Rear Bay to equalize their power outputs. Take your time and do this accurately!

If for example, your second amplifier is a 150 Watt per channel amp, its output is approximately 5 times higher than the TIGRIS depending also on the Pentode / Triode configuration and Feedback level you have chosen. Without adjusting the Level Set attenuator, your speaker's woofers will play in excess of 6dB louder than the midrange / tweeters - not what the speaker designer labored over or the recording engineer worked for.

To insure flat frequency response, it is easiest to playback a test CD with prerecorded signals of decreasing frequency but steady amplitude, such as Stereophile's Test CD. You may order this particular CD by calling 1-800-358-6274. While the tone signals slowly traverse the frequency range from high to low like a musical scale, your speaker's tweeter will hand over playback to the midrange and then to the bass driver. Your job will be to determine whether all test tones will be equally loud at your listening position, especially where the TIGRIS hands over playback responsibilities to your bass amplifier.

To make sure you recognize the frequency window where the amplifiers hand over, turn off the second amp while the test tones play back and make a mental note at which tone the apparent volume begins to drop and at which note playback stops entirely. The window is between these two spots. Now turn on the second amp and repeat the playback of the entire scale. Adjust the Level Set control if necessary. Even though your ears alone are a good judge, a more precise way to check for linearity would be to use a sound level meter.

If you notice irregularities outside of this frequency window, you have less-than-linear speakers, room-induced anomalies or a combination of both. Room-induced aberrations, such as boominess of certain notes or a suck-out of others (a region of apparent signal loss,) can be addressed with room treatments, speaker placement, equalizers or a combination of these variables. Room treatments are objects that either reflect or absorb sound waves at predetermined frequencies to counteract how the room responds to what the speakers are reproducing. Sometimes repositioning the speakers by merely inches can address most or all of such problems.

Thus before you invest in room treatments, experiment with speaker location, i.e. distance from the rear wall, distance between speakers, distance from the listening seat, toe-in and tilt-back angle and, on stand-mounted speakers, speaker height. If you have reason to believe that your room or speaker location is less than satisfactory, and you fail to resolve the problem to your satisfaction, consult your retailer for advice. Whenever you bi-amp, make sure the bridging straps between your speaker's dual binding posts are removed! You risk seriously damaging the TIGRIS and your other power amplifier if you leave the two hot and the two ground terminals on the rear of your speakers connected !

E: Basic Multi Room Connection - A fourth hook-up option for the Preamp Output is in a multi-room installation where a second power amp, rather than driving a section of your main speakers, powers a second pair of speakers in a different room. Now the Level Set attenuator of the TIGRIS is used to adjust the relative output level between rooms. Should you wish to mute the speakers in the main room while the secondary room remains active, engage the Headphone selector. When muting speakers with the Headphone switch in this scenario, it is best to operate with the lowest possible setting of the Master Volume control by turning up the Level Set

### 3-4 HOOK-UP OPTIONS: (Continued)

control instead. This avoids running the load resistor of the headphone circuit unnecessarily hot. To mute the speakers in the secondary room while the main room remains active, either turn off the secondary amplifier or turn the Level Set to zero. We recommend turning off the second amp so that your favorite inter-room level balance stays put by leaving the Level Set at the predetermined setting.

Please note that this is merely a basic multi room scenario - you won't be able to play back two different musical programs simultaneously.

### 3-5 DETACHABLE POWER CORD:

You may be surprised to note that the power cord of the TIGRIS unplugs from the main chassis. This allows you to experiment with after market power cords which can result in surprising differences. It also makes for easier installations. Make sure the A.C. switch is in its off position before you plug in the A.C. power cord. If all the component connections have now been made, you should connect the TIGRIS to your electrical wall outlet, power strip or line conditioner. Check that your line conditioner is not a current-limiting device.



### 3-6 A.C. ON / OFF SWITCH:

Above the Front Panel, you'll find the primary ON / OFF toggle switch in the left-most position. Upon power-on, the LEDs will light up to confirm status - dim in WARM mode, bright in OPERATE mode.

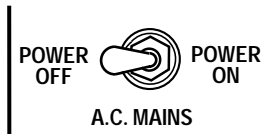

The TIGRIS should be fully powered down and unplugged during severe thunder storms that might cause power failure and line surges, as well as during vacation periods. With the TIGRIS connected to your power source, you should now turn on the A.C. Switch. The front-mounted push button switches should still be in the WARM position.

### 3-7 WARM / OPERATE SWITCHES:

The TIGRIS allows instantaneous start-up by switching from WARM to OPERATE. Think of the WARM feature as an idle current that operates the tubes in standby at highly reduced Hv. This is similar to an advanced rheostat that keeps halogen bulbs under current even when the lights are extinguished, thus extending the bulbs' life span. The status LEDs will turn from dim to bright whenever operate is engaged, and will fully extinguish only when the A.C. ON / OFF switch is turned off.

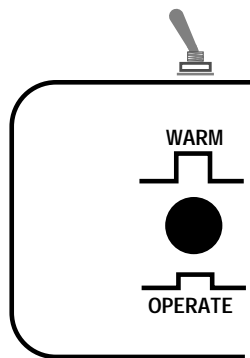

Whenever you have to change and disconnect interconnects, turn the TIGRIS off. There is enough Hv in the WARM position to reproduce signal at much reduced output level - this could cause minor feedback noise to your speakers if you unplugged interconnect cables in WARM mode. If you listen a lot, leaving the tube circuitry in the WARM mode actually extends the life of the active components because the sudden turn-on / turn-off power fluctuations are avoided. The load on your electric bill is negligible, and you won't have to wait for the tubes to warm up! \*

If, on the other hand, you listen rarely, turn on/turn off wear is not an issue, so you should power down the amplifier after each listening session. Like its pro-music brethren, we designed the TIGRIS expecting a certain amount of unintentional abuse, so you won't have to concern yourself with handling your new amplifier with velvet gloves.

\* During summer months, you may want to shut down the amplifier when you don't listen to it - especially in smaller rooms, this will ease the burden on your air conditioner. If your system is fully hooked-up now, the A.C. Power ON and the Standby switches in the WARM position, you are about to begin your first listening session. One final step remains - setting the grounding switch appropriately.

### 3 - 8 GROUND SWITCH:

At the very right of the Tube Bay is a mini-toggle switch which you will probably set once and then leave alone. The easiest way to understand the purpose of this switch is to consider the TIGRIS as having two separate reference groups to ground: one external and two internal. The internal Grounds are the common zero voltage points for the power supply and audio circuitry. The external Ground is the safety connection of the metal chassis to your home's Ground Circuit.

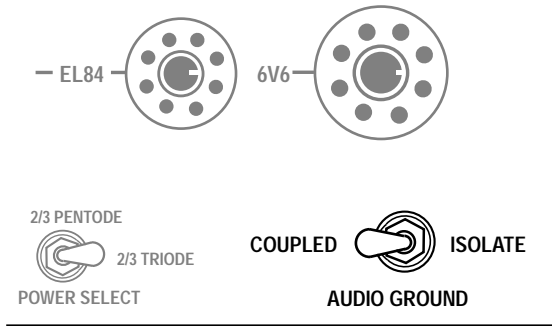

The grounding switch either connects (coupled position) the internal grounds with the external, or floats (isolated position) them. In either case, the chassis remains connected to your home's Ground Circuit for safety reasons.

Ideally, only one component in your system should be internally referenced to A.C. ground. Customarily, this is the source component. If more than one component of the system is tied to power ground in this fashion, audible hum and buzz may occur. To find out what position ( grounds isolated / grounds coupled ) is appropriate for your system, engage the WARM switches to their OPERATE position. Open Volume control of the TIGRIS to about its 9 o'clock position while you have one ear pressed close to the drive units of one of your speakers. If the length of your speaker cable does not permit control over the volume and ground switch while close to the speaker, you might ask a friend to help you.

You do NOT feed signal, but merely listen for the level of noise.

Slowly increase gain until you hear noise reproduced by your speakers. Now change the switch setting. If the noise level drops or becomes inaudible, you have found the optimum setting. If it increases, keep the switch in the original setting and experiment with cheater plugs on some of the other components, one at a time. NEVER saw off the ground leg of a three prong connector to reduce noise - use an adaptor!

If you don't notice any noise in either the coupled or isolated position, you may, with critical listening, still discern a difference in overall sound quality. The isolated position will probably provide a more open and spacious soundstage.

### 3 - 9 CONGRATULATIONS:

You are now ready to commence your first listening session. Cross off the following check list in your mind: • The Headphone / Speaker selector on the Rear Bay is set to SPEAKERS.

- The Input Selector shows the source you intend to play
- The Volume control is fully turned down.

Now select PLAY on your source component and slowly open the Volume control until a pleasing play back level is achieved. As a reminder...always raise the level of the volume that you are going to listen to gradually. Its a lot easier on your speakers and your ears. It might be a good idea to get into the habit of reducing the 'TIGRIS' volume when your listening session is over and you shut down

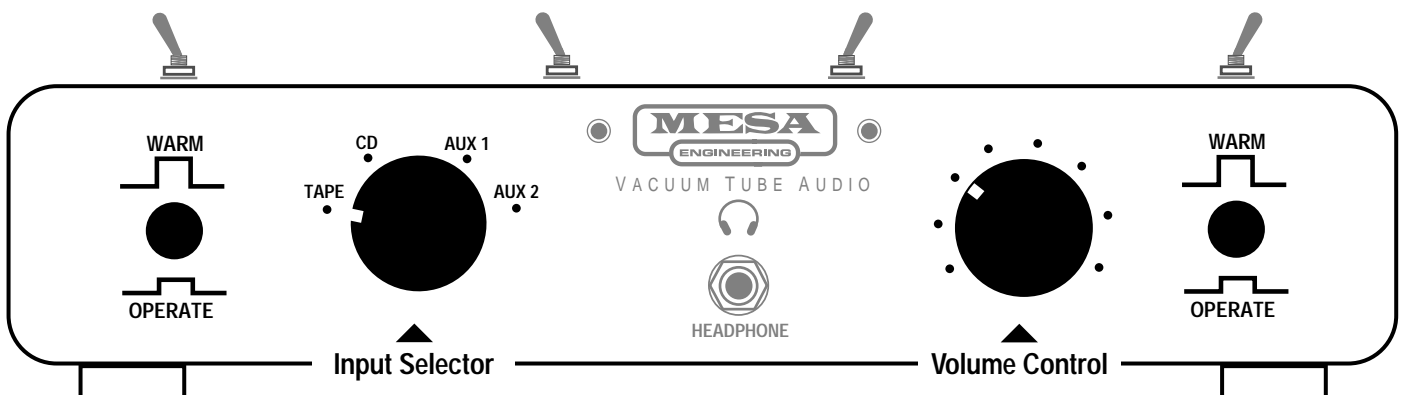

### 3 - 9 CONGRATULATIONS: *(Continued)*

the amplifier in order to avoid unwanted sudden volume surprises when you are ready to enjoy your music again. You now have successfully installed your new TIGRIS amplifier, enjoy and happy listening!

The following chapters include more in-depth coverage of technical issues and explain the advanced features - but if you're impatient, go ahead and enjoy the music now! Changing the Pentode / Triode switches or the Negative Feedback selector is self-explanatory and will have immediate sonic effects - you should read up on it eventually, but you may postpone it for the moment.

#### TUBE BAY TOGGLE SWITCHES:



## Chapter 4 - ABOUT BREAK-IN:

Even though every Mesa amplifier undergoes a burn-in at the factory prior to shipping, a complete burn-in of all the internal components and the tubes will take about 100 hours. You may notice a slow and continuous improvement of the sound until this mechanical/electrical burn-in is complete. Elevated playback levels will not accelerate this process. However, you may opt to set a CD on endless repeat during absent periods from home to hasten break-in while you are away from the system.

Break-in is equally necessary and noticeable with new speakers where the physical back-and-forth motion of the drivers softens the rubber surrounds to their appropriate compliance. Some audiophiles go as far as demagnetizing their systems periodically by using specially encoded Cds, holding that a system builds up an electromagnetic charge over time that interferes with optimum performance. Many parameters in the High-End industry are still not fully understood. Certain cause-effect relationships, even though established, cannot be fully explained yet. This creates an atmosphere where scientific reason and mumbo-jumbo combine to address, and sometimes exploit, our desire for ever greater performance and our ignorance in electronic matters. It is important to use common sense and to trust your own ears. If you can't hear the difference, or if the difference is too negligible to matter to you, don't spend your hard-earned funds.

We recommend to evaluate power cords, power line conditioners and interconnect/speaker cables by the same standards. Very often, the magic is not a function of fancy white papers and final funds spent, but a matter of trial-and-error which culminates in a synergistic effect that exceeds the sum total of the individual parts. The adaptability of the TIGRIS will help you make the most out of the components you already own!

## Chapter 5 - ADVANCED FEATURES:

### 5 - 1 TANDEM STATE IMAGING:

A: TRIODE / PENTODE SWITCHING – Amongst experienced audiophiles, it is a foregone conclusion that in tubed components, the choice of tubes, their type and origin, will significantly impact the sound of the component. Direct-heated Triodes, Tetrodes, Pentodes, 6550s, 5881s, EL34s and 84s, Czech, Russian, Chinese... they all have unique sonic signatures, and audiophiles have favorites based on listening preferences as well as personal theories.

Some of the more advanced tube amplifiers allow the end user to switch between Pentode / Triode or Tetrode / Triode operation. But this always remains an either/or scenario. And that's where Tandem-State Imaging differs.

Imagine, for a moment, a plant- or animal breeder who carefully selects and then cross-breeds different species to combine desirable

## 5 - 1 TANDEM STATE IMAGING: (Continued)

genetic traits into a new hybrid - such as a rose with no thorns but bigger flowers and stronger scent.

With Tandem-State Imaging, you can combine varying amounts of Pentode / Triode operation simultaneously, effectively creating a sonic hybrid that marries the harmonic "rightness" of Triode operation with the dynamics and frequency extension of Pentode power; midrange lushness and bass slam; transparency plus soundstage width; control with finesse. Astute audio critics have repeatedly stated in print that Tandem-State Imaging results in an uncommon quality, seemingly neither solid-state nor typically tube, but rather... musical. This would validate our design goal: to build musical instrument quality amplifiers.

The TIGRIS is a push-pull design, utilizing 6 power tubes per channel, arranged in two rows of three, each row amplifying one half of the wave form, phase-split by the preceding dual-triode 12AX7. The power tubes are wired in pairs into one each of the three positions of the front-mounted Triode / Pentode toggle switch. The three switch positions correspond to:

- inwards = all three pairs wired in Pentode (35 W/Ch)
- upwards = 2 EL84, 2 6V6 in Pentode / 2 EL84 in Triode (28 W/Ch)
- outwards = 2 EL 84, 2 6V6 in Triode / 2 EL84 in Pentode (20 W/Ch)

All Pentode operation demonstrably widens the soundstage and creates a front row perspective, while increased Triode activity reduces stage width and assumes an apparent 10th row perception. These imaging differences are initially the most easy to discern, followed, with a little experience, by the change of tonal character and the emphasis shift into the midrange with higher Triode participation.

But that's not all.

Inherent in Tandem-State Imaging is a second function that allows you to optimally tune the TIGRIS to your system requirements and listening preferences: adjustable Negative Feedback.

**B: ADJUSTABLE NEGATIVE FEEDBACK** - Negative Feedback is a corrective technique wherein a portion of signal voltage is taken from the speaker terminal and fed back into the amplifier's input, but out-of-phase with the original input signal. Because it is of opposite phase, the feedback is termed inverse or "Negative" and it works by cancellation to reduce amplifier inaccuracies. Distortion would be defined as any signal components appearing at the amplifier's output which weren't present at the input. Picture the cancellation effect of Negative Feedback as being equivalent to a reduction in circuit gain: the amount of output of both distorted and non-distorted signal, is reduced. Thus by feeding back a part of the output voltage to the input, out-of-phase, circuit gain and distortion are reduced simultaneously.

Example: take an amplifier with 2% distortion and add 6 dB of Negative Feedback. The output, a combination of distorted and undistorted signal, will then be reduced by half. Now doubling amplifier gain will restore the original signal strength, but the distortion element will remain halved and now only constitute 1% of the total signal.

Negative Feedback would theoretically seem an ideal measure to design an amplifier with zero distortion, by simply applying the requisite amounts of feedback. However, high amounts of feedback, while indeed measuring well in the lab, don't work well in the musical performance domain because minute micro-information about the original event becomes veiled.

It is easy to see why. For a corrective measure to become active, the fault has to occur first. If the time-lag between occurrence and correction is a matter of milli-seconds, then signal portions of exactly such milli-second duration will be affected. Feedback never quite catches up with the changing musical signal and tends to obscure inner detail, ambient cues and micro dynamics - all of which alerts our brain that what we are listening to isn't real, but artificial. This would be the antithesis of what high-end equipment aspires to: convincing our brain that real musicians, occupying real space, are making music in our listening environments.

Thus, Negative Feedback must be used sparingly, as a subtle calibration device rather than a cheap perfume to hide flaws of a poorly designed circuit. A properly designed amplifier needs to work well without any feedback to begin with.

### 5 - 1 TANDEM STATE IMAGING: ( Continued )

The feedback settings of the TIGRIS correspond with the following approximate values ( your actual speaker load and the output tab chosen will affect the values slightly ):

	Full Pentode	2/3 Pentode	2/3 Triode
Stage 1	5dB	4dB	3dB
Stage II	8dB	7dB	5dB
Stage III	12dB	10dB	8dB

Higher amounts of feedback affect driver control in speakers by increasing the amplifier's damping factor and reducing speaker motion. Damping factor refers to the impedance relationship of source impedance (TIGRIS ) to load impedance ( speaker ). The lower the source impedance, the higher the damping factor. Increased feedback lowers the amplifier's output impedance. If your speakers feature main drivers larger than 8 inches, you may notice tighter, more articulate bass performance by selecting one of the higher Feedback settings. The highest amount of feedback in the TIGRIS is well below the industry standard in amplifier design, and the TIGRIS was designed to operate flawlessly without any feedback whatsoever - the Zero setting. User-adjustable Negative Feedback is thus implemented merely as a fine-tuning and system-matching device.

To correctly evaluate the appropriate amount of feedback for your system, remember to adjust the Volume control during comparative listening sessions with various feedback settings. You need to offset reduced output with increased feedback by slightly raising playback levels.

A quick counting survey of the features of Tandem-State Imaging will add to twelve (12) different possible combinations between Pentode / Triode operation and Negative Feedback. Before this figure begins to look alarmingly complex, take a slow breath: after a get-to-know period of a week or two, most owners settle for one very obvious setting as the best-sounding for their system. From our BARON'S returned warranty cards we have learned that one person's favorite setting is another one's least used, thus proving the value of such flexibility. We also have reports on file where, due to a move, redecoration or system upgrade, the favorite setting changed. Tandem-State Imaging thus also becomes an insurance policy against obsolescence. This feature is so easy to operate - a flick of a switch, a turn of a knob is all it takes. All adjustments were designed to be operational on-the-go, under signal and during the performance where changes would be immediately perceivable.

### 5 - 2 POWER TUBE BLEND:

Returning briefly to the power tubes of the TIGRIS, you will notice that here, too, the principle of cross-breeding is in operation: two different kinds of tubes are employed, in a predetermined, optimal 2:1 ratio. The EL84 tube is known for its dynamic prowess and a lively, bubbly presentation filled with air and extension. The 6V6, on the other hand, excels with its warmth and prodigious bass. Combined, the presentation features the sum total of these ingredients: full-range frequency extension, dynamics, warmth, airiness and liveliness.

### 5 - 3 HEADPHONE OUTPUT:

An unusual feature of the Headphone Output of the TIGRIS is its linkage to the full array of power tubes, which provide access to complete Tandem-State Imaging and true Class A output power. Unlike other designs where an op-amp or the preamp stage drive the headphones, the TIGRIS, via a load resistor, connects the headphones directly to the speaker outputs. Whenever the Headphone switch on the Rear Bay is set to speaker mute, the entire TIGRIS literally converts into a dedicated headphone amplifier of reference caliber. Our ultra-low noise output stage was especially optimized to cater to high-resolution Headphones that would reveal background noise in a lesser design. If you initially experience uncertainty about the exact impact the various settings of Tandem-State Imaging exhibit over your speakers, we recommend you take an educational tour via a pair of good-quality Headphones. Because you side step room interactions, the effects will be very pronounced and easily recognizable. With a little experience, you will then know

**5 - 3 HEADPHONE OUTPUT: (Continued)**

what to listen for when you resume listening to your speakers. If you wish to mute your main speakers not to listen to Headphones but while a second pair of speakers is active in a multi-room application via the Preamp Output, we recommend adjusting the multi-room volume with the Level Set attenuator, leaving the Master Volume control at the lowest possible setting. This avoids running the load

**FRONT PANEL: TIGRIS**



resistor of the Headphone circuitry unnecessarily hot. Should you own Headphones so efficient that the usable gain range is restricted to just a few “clicks” on the Volume control, select one of the higher stages of Feedback and/or more treble activity. This procedure decreases overall output and widens the usable range of the Attenuator.

**WARNING:** Similar to the warning signs in your car’s review mirror ( objects are closer than they appear ), volume levels during headphone listening are often higher than they might

appear. This is especially true after prolonged listening sessions, when listener’s fatigue reduces our sensitivity and we compensate by increasing the volume. Abnormally elevated playback levels during headphone listening can permanently damage your hearing!

**REAR BAY: TIGRIS**



**5 - 4 AUTO BIAS:**

The TIGRIS uses cathode biasing for its power tubes and thus no adjustments are ever required. This is one of the invisible features we mentioned in the Introduction and it is attractive because it removes the need to monitor and maintain the biasing of the power tubes. Cathode biasing is so effective it is also known as self biasing or Auto Biasing. For the technically minded who want to know more about Bias techniques, here is a brief explanation:

A tube’s operating conditions are established by striking a balance between attracting and repelling forces. Remember, unlike charges attract, like charges repel. At the center of the tube is the cathode which, when heated, emits a cloud of electrons. Possessing an inherently negative charge, these electrons are strongly attracted to the plate (or anode) which is charged to a high positive voltage from the main power supply. Located in between the cathode and the plate is a spiral of thin wire called the control grid. In order to restrict the flow of electrons from the cathode to the plate, the plate is made to be more negative than the cathode. Because like charges repel, negative electrons from the cathode are both repelled by the more negative grid and attracted by the highly positive plate. A small change in the negativity of the grid can cause a large change in the amount of electrons flowing to the plate. And that’s the essence of amplification: a small change in the grid voltage causing a large change in the plate current.

But first, a proper zero-signal, static state current flow must be established and that is accomplished by achieving the proper relationship of voltages between the cathode, plate and grid.

In a fixed bias system, such as the BARON, the power tube cathodes are tied directly to ground at zero Volts. A negative voltage from a separate small power supply is then applied to the control grids and that voltage ( called the Bias voltage ) is set such that a predetermined idle current flows through the power tubes under zero-signal conditions. The more negative the grid is with respect to the cathode, the less idle current will flow through the tube to its plate.

Cathode.....	0
Plate.....	+ 450
Grid.....	- 50 (voltage generated by separate power supply)

In a self-bias system, such as the TIGRIS, the power tube cathodes are tied to ground - not directly - but through resistors. When current flows through the tubes, a voltage drop occurs across these cathode resistors and this provides a positive voltage on the cathodes. The control grids may then be operated at a zero D.C. voltage - but they will still be negative with respect to the cathodes because the cathodes are now slightly positive.



#### 5 - 4 AUTO BIAS: ( Continued )

Note that the voltage relationship between the three elements is similar and that the difference between cathode and the grid voltages is the same in both examples: The grid is 50 Volts more negative or less positive in both. Thus as far as the electrons are concerned, the static operating conditions between the two systems are quite similar.

Cathode.....	+ 50	(voltage generated across cathode resistor)
Plate.....	+ 450	
Grid.....	0	

However, there are two important differences between the systems. First, if the tube in the cathode biased system tries to draw too much plate current, the voltage drop across the cathode resistor increases, raising the positive cathode voltage. This has the same effect as would increasing the fixed negative bias voltage, only it happens automatically. Idle current through the tube decreases whenever the grid becomes more negative relative to the cathode. Only in the self-bias system it's the cathode which becomes increasingly positive relative to the grid. Either way, the effect is identical.

In mechanical terms, cathode bias is like having a governor on an engine's throttle: if the engine tries to speed up, the throttle is automatically reduced. If it tries to slow down, the throttle is increased.

If you wonder why every tube amplifier isn't auto-biased, it is because this system is unable to deliver as much power from the same tubes and transformers as can the fixed bias method. The key to this short fall is apparent by looking at the voltage charts above.

The maximum power a tube can transfer is dependent on the difference between cathode and plate voltages. In order to generate the cathode bias, the difference between plate and cathodes is 400 Volts versus 450 Volts in the fixed bias example above.

#### 5 - 5 CLASS A OPERATION:

Often considered the Holy Grail of tube operation, Class A is just as widely misunderstood. While there is no way an Owner's Manual can successfully convey all of its intricacies, we will try to give you that little bit of knowledge which is not dangerous but may help to de-mystify Class A. In the section above we've discussed two separate methods of biasing tubes to draw their correct idle current as determined by the circuit designer. When we speak of classes of tube or transistor operation, we're considering the effect of applying signal voltages of various magnitudes on top of the steady-state idle conditions.

Remember, the idle current flowing through the tubes under zero signal conditions has been established by biasing via either method so that the grid is charged somewhat negative in relation to the cathode. If it becomes more negative, less current flows. When it is less negative, more current flows. Now, if we apply an audio signal to that grid and look at it instant by instant, the effect is exactly the same as changing the bias voltage. As the audio signal swings negative, it augments the steady-state bias by driving the grid further negative and reducing the amount of current flow through the tube. When the audio signal swings positive, it counteracts the negative bias by adding a positive voltage to a negative voltage such that the sum is not as negative as it first was and thus current flow increases.

What Class A operation means is simply that current will continue to flow AT ALL TIMES through all the tubes during all normal signal voltages. That's it! The only reason this is important is because it avoids the non-linear region of a tube's amplifying characteristic which occurs at and near cut-off which is when current ceases to flow. Any single-ended design must, by necessity, operate in Class A, otherwise tremendous distortion would occur as the amplifier literally cuts itself off by having a signal voltage that at times became so negative that all current ceased to flow.

But in a push-pull design, the signal is divided into two halves which are alternately amplified by each side of the circuit. To be more precise, a class AB amplifier would simultaneously use both halves of the amplifier at lower volumes that's the Class A part, but at some level of signal magnitude, the negative half of the signal would drive one side of the push-pull circuit into cut-off while all the

## 5 - 5 CLASS A OPERATION: (Continued)

amplification was going on in the opposite half circuit. That's the Class B part.

The trick is to get the large magnitude signal to pass back and forth in a push-pull circuit without major distortion occurring due to cut-off. That's because the tubes, having first been driven into cut-off, must then resume drawing current. That off and on action no longer reflects voltage changes at the grid (musical signal) and thus distortion occurs.

By contrast, Class A operation comprises merely increases and decreases of current flow, but current cut-off is avoided. Grid voltage and plate current maintain a simple linear relationship without exceeding the tube's preferred operational boundaries. You could call Class A the sweet spot of tube amplification characteristics.

The TIGRIS is both push-pull and Class A. This means that while the signal is divided into two complementary halves for increased power, some current continues to flow in both halves at all times. There is no point at which a normal signal voltage causes cut-off and thus the distortion products which accompany Class B are avoided.

Notice that word, normal. It would be possible to drive the TIGRIS into cut-off by turning it up too loud, but by then saturation and its obvious distortion would already be occurring. Thus the signal condition would be abnormal.

In the TIGRIS, the onset of saturation and cut-off occur almost simultaneously in the all Pentode position thus maximizing the available power under Class A conditions. In power settings utilizing partial Triode performance, saturation occurs well before cut-off and, as noted, output power is also reduced. In other words, saturation occurs in the positively driven half of the signal well before cut-off occurs in the negatively driven half.

If Class A is superior, then why aren't all amplifiers operated that way? Because the need for high idle current causes more power to be wasted as heat than is provided for doing useful work.

Is that why the Class A TIGRIS is modestly powered while its big sibling, the BARON, runs Class AB? Yes. However, the BARON is so powerful that it almost never shifts out of the Class A portion of AB operation - at least not until shattering volumes of Pentode power have been attained.

There's also an added sonic advantage to lower power amplification and that is that smaller output transformers tend to sound sweeter and more open. Physically larger output transformers exhibit increases in both distributed capacitance and stray inductance which tend to roll-off and phase-shift extreme high frequencies. Also, to provide full power down into the lowest frequencies requires large transformers with very high iron flux capability - a dilemma discussed further in the BARON Owner's manual. Basically, smaller is better - until low end performance audibly suffers.

Nevertheless, we expect you'll be pleasantly surprised - if not somewhat shocked - by what a muscular punch your new TIGRIS packs. Wimpy it is NOT! In Full Pentode mode with moderate feedback, you can expect to Rock the House with tight, well-defined, powerful sounding response! Check your lease before seeing just how loud the TIGRIS can play! Not that we advocate high listening levels, but listening to music is supposed to be fun, and sometimes that equates high volumes.

## Chapter 6 - ON TRIODES, PENTODES & IRISHMEN:

With apologies to Friends and Relatives from the Emerald Isle - who will make their appearance soon enough - the humor which follows is dedicated to the memories of Spec McAuliff and Fae (Rafael) McNally, two of the True Greats.

As their numerical references suggest, the terms Diode, Triode and Pentode indicate the number of elements within the vacuum tube i.e. two, three or five. All tubes also require a filament or heater which is not included in the count. Its purpose is to excite electrons from the cathode coating by raising the temperature such that they are able to boil out of the electron-rich coating material and form a cloud of free electrons in the vacuum space surrounding the cathode.

## **ON TRIODES, PENTODES & IRISHMEN: (Continued)**

Although the term filament and heater are often used interchangeably, there are specific differences: A filament is a directly heated cathode where cathode coating is applied directly to the heating element. Examples are 5U4 twin diode rectifier and 300B triode amplifier tubes.

A heater, on the other hand, is a heating element which is separate from the cathode and is usually inserted within the tubular cathode sleeve. Examples are 12AX7 twin triode amplifier and 6V6 or EL84 beam power pentode tubes. In all cases this fundamental aspect of each tube's construction is clearly visible, especially when the heating element is glowing red hot.

The cathode, then, would be considered the first numbered element because it is the source of the electrons. The word itself is from the Greek literally meaning completely down, which implies a sense of central origin - like the center of the earth where Tone begins. It might be said that an ecstatic audiophile experiences a positive catharsis, his soul being purified when his system transports him to Audio Nirvana. The only trouble with taking this positive imagery too far is that the cathode is, unfortunately, negative... at least electrically speaking. However this is easily remembered since virtually all musicians and audiophiles have also experienced the more common negative catharsis when they emerge from the emotional rebirth kicking and screaming in rage and frustration.

Once heated, the intrinsically negative electrons are energetic little fellows of almost no mass. Thus they may be accelerated almost instantaneously and will travel through a vacuum a nearly the speed of light. Being of like, negative charge, they tend to repel one another and thus within the electron cloud surrounding the cathode, there is much jostling and elbowing as each one tries to maintain his distance from all the others... unless there is a strong and universal attraction from an outside influence.

Visualize, if you will, a group of sub-atomic Irishmen milling about and in a repellent, negative state of mind. All are scowling and none wants to have anything to do with the other. Now introduce a strong attraction say, a public bar, and you can easily picture an orderly, if rapid movement of the lot in a single direction. This is what happens when a positively charged element called the anode or plate is introduced into the vacuum.

The plate is the large metal element most prominently visible through the glass of an electron tube. It is the outermost element of a tube's structure and it surrounds all the others. The cathode is at the center radiating electrons outwards. As higher and higher positive voltage is applied to the plate, the attraction for the electrons surrounding the cathode is increased and with nothing standing in the way, full uninhibited flow to the plate occurs... sort of like removing the doors and offering free drinks to the crowd of surly Irishmen milling around outside.

As electrons flow to the plate, the space charge will continually be replenished by further 'boiling' of the hot, electron-rich cathode as you can easily imagine other Irishmen impatiently taking up the places of those who've gone inside - until the entire village is deserted.

Now, where do they come from and how do they emerge? Well, a grand and elegant lady once showed me how to revive flat champagne: She dropped a raisin into the glass. There was a dramatic and immediate increase in effervescence with the introduction of a cathoding surface. Thousands of tiny bubbles suddenly appeared - and continued to flow from the raisin. Of course the bubbles were made up of gas dissolved in the beverage, but the analogy makes it easy to visualize the loosely bound electrons dissolved in the rich cathode coating as they effervesce from its heated surface.

But back to the electron flow. If the electrons are strongly attracted to a positively charged plate, then it follows that they are strongly repelled by a negatively charged plate and they are. Thus, if an alternating current - such as comes from a transformer - is applied to the plate, electrons will flow only during the times when the plate is positively charged. During periods of negative plate charge, electron flow is stopped and the space charge of electrons remains compressed in the area around the cathode.

Thus a diode tube - one with a cathode and an anode - is mostly used to rectify alternating current into direct current by passing it without restriction, but in one direction only. This also explains why closing time is strictly enforced at Irish pubs: During normal operation, the traffic flow is similarly unimpeded and uni-directional toward the bar and this process rectifies the work-day negativity. It goes without saying that no one leaves as long as the atmosphere around the bar remains positively charged.

## 6 - 1 TRIODES:

This section is a continuing technical treatise on the workings of Irish Pubs but to make it easier for the layman to understand, it is explained in terms of vacuum tube technology. Enter the original bar - free beer and no doors. Well, it turns out that some control over the flow can be a necessary and useful advantage. This led to the invention of those swinging louvered saloon doors which are open at the top and bottom. They are patterned after the control grid of the vacuum tube, which is a loosely wound coil of thin wire located between the cathode and the plate.

In a Triode the plate is always positively charged with high voltage D.C. and even though the grid is blocking the path, those negative electrons can still FEEL the strong attraction - just as the Irishmen can see in through the louvers of the bar doors. They know what pleasures lie beyond, but to get there requires overcoming the negative influences controlling the access. This negative influence is typically called a Bias. In electronic terms that means the grid is supplied with a voltage which is slightly MORE NEGATIVE than the already negative electrons. The more negative the Bias, the more it tends to neutralize the attraction of the plate and repel the electrons back toward the cathode.

The Irish can be similarly charged with Bias, but unless you are Irish yourself, this type of Biasing may be more difficult to understand. The effect is similar though: The more negative the Bias, the more it impedes forward progress. Generally speaking though, the electronic Bias of the grid is easier to overcome, and for two main reasons: First, the Bias is set - like the bar doors - to allow some passage. Second, the grid is mostly NOT THERE, like the louvered doors which are mostly open spaces. Unlike the plate which is solid, the grid is like a coiled bed spring. It can create a repelling field but mostly it's empty space in between widely separated windings of wire. It's very easy to control the electrons as they pass through the grid's force field: Changing the grid voltage only slightly will have an enormous effect on how much current flows through... and that's what AMPLIFICATION is: a small change in voltage at the grid causing a large change in current flowing to the plate.

The purpose of the louvered bar doors is similar to that of the grid, namely, to give momentary pause while still revealing the promise within. Hesitation mostly gives way to temptation, but there are those few stalwart Irishmen who think twice and decide to come back later. Most just pause slightly then go on through. That is the purpose of the bar doors: to prevent everyone from crowding in all at once - and as the door is made less of a barrier, wider spaces between the louvers, more of the bar's attractive influence is felt outside thus amplifying the customer flow and increasing the crowd at the bar.

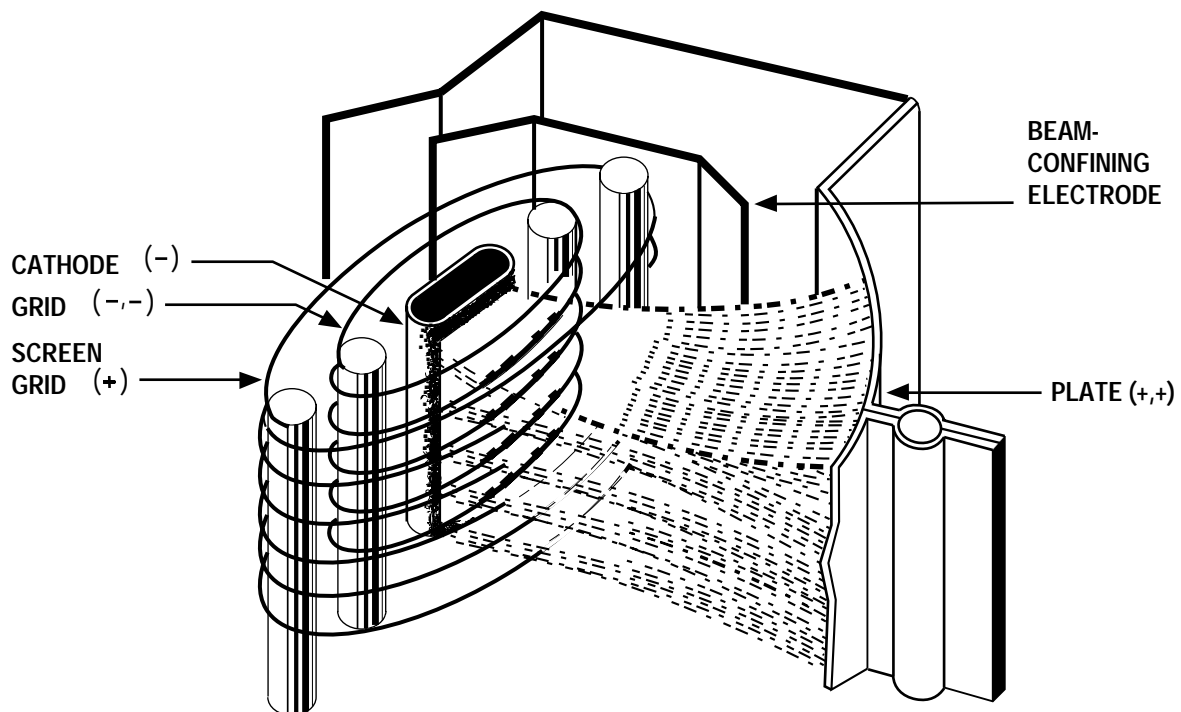

*Structure of a 6L6 / 5881  
Beam Power Pentode.*

## **6 - 2 PENTODES:**

Occasionally though, bar doors - even the louvered type - were found to be too effective, and too many customers turned away. Something further was needed to increase the attraction of the bar and overcome the resistance created by the door. Thus the cocktail waitress was invented.

Once again the idea was inspired by the vacuum tube. It had been discovered in some tubes, often large power types, that the distance to the plate was too great to attract enough electrons past the negative influence of the control grid. So another grid coil of fine wire was inserted between the first grid and the plate. This was called the screen grid and carrying a highly positive charge, it functioned as a "bait" for the plate.

In a properly designed power tube such as an EL84 or a 6V6, the windings of the screen grid are precisely aligned to fall in the shadow of the control grid. This way the electrons responding to the pull of the screen grid are lined up in sheets as they pass between windings of the inner control grid... only to find that they have been fooled! Once past the control grid and drawn toward the screen grid, they discover...there's almost nothing there. The path they're on has them aligned to zing straight through the spaces BETWEEN screen grid windings. So rather than a close and personal encounter, they just fly on past - and once they're out that far, there's no stopping them. The influence of the plate takes over and - being solid metal and of the highest positive attraction - it is at this final destination that the electrons congregate.

Thus the proper cocktail waitress - visible through the louvers - is scantily clad so as to be all the more effective at reinforcing the attractive influence of her bar and by being located in between the door and the bar, she serves as bait to lure customers past the door's negative influence. Once through the door however, it is the rare Irishman who actually comes in personal contact with the cocktail waitress as, for all intents and purposes, she - like the screen grid - turns out to be a vanishing illusion. Yet, having come this far, the solid influence of the bar itself now takes over and attracts the customers to congregate, having happily reached their destination.

Since each channel of the TIGRIS uses three pairs of power tubes, the Pentode / Triode switch is configured in three positions so you can hear any combination of characteristics and sample for yourself the extra juice provided when those wenches lay bait to the plate. If you're still following this and haven't lost track of the count, you'll know we're still one element short of the five needed to make a Pentode. This last part is a pair of beam-confining shields which being negatively charged, serve to direct the flow right toward the plate. This is much the way a short entrance hall to the bar prevents wandering accidentally into the Men's room on the way.

Once at the bar though, the circuit is complete and the process of soul-nourishing works its ritual magic. Biases having been overcome, illusory nightingales having vanished, the spirits truly soar and the once surly Irishmen now are filled with warmth, wit and kindred friendship, enjoying the music and glowing nicely with their heaters on.

With appreciative thanks to the inhabitants of the Land of the Leprechaun, we have now concluded our little diversion into the mechanics of proper bar lay-out.

## **Chapter 7 - TUBE MAINTENANCE & TUBE ROLLING:**

### **7 - 1 TUBE MAINTENANCE:**

Just as light bulbs have a limited life span - from a few hundred hours to automobile head lights rated for thousands - so all tubes eventually wear out and need replacement. The tubes used in the TIGRIS are of the industrial type and highly rugged and reliable. They should provide years of trouble-free operation and carry a 6 months warranty.

Eventually, even the hardiest of tubes will have to be replaced, and to support your maintenance, we offer the original owner a unique plan in the industry: a 50% discount on replacement tubes for as long as you own our amplifier. At the time of this writing, a complete retube kit consisting of 4 x 12AX7A, 4 x 6V6 and 8 x EL84, is available factory-direct for \$77.00 plus shipping! ( Prices may increase over time. ) Call us at ( USA ) 707-778-9505.

### **7 - 1 TUBE MAINTENANCE: (Continued)**

When the time comes to replace tubes, make a note of the color code on your power tubes before you call us with your order. At the bottom of the tubes, you will find a label listing a three letter abbreviation such as GRY, WHT, YEL, GRN...this is our in-house system of separating our computer- tested tubes into different Bias categories. Tubes with the same color coding draw identical current and thus insure perfectly matched behavior. This is important when you only replace isolated tubes and don't retube the entire amp. Being a push-pull design, the two rows of three tubes per channel need to be perfectly matched to each other, and left to right channel. Even a single mismatched tube will throw off the balance, resulting in performance degradation and potential premature tube failure. It also prevents the auto-bias system from working properly.

### **7 - 2 TUBE ROLLING:**

This term refers to experimenting with brands of tubes other than those supplied by the manufacturer. You have good reason to assume that we equip our amplifiers with the best tubes available for the purpose. After all, we select particular tubes to be part of the individual models from the very beginning of the design stage. Any and all modifications we incorporate during the design process are in response to these tubes chosen and account for a finished product that was optimized and voiced to work perfectly with the type and origin tubes that the amp is shipped with.

However, some listeners may wish to experiment and have access to tubes of the same type, but by a different manufacturer that could result in a change of the amp's sonic signature. You are welcome to experiment along those lines, but please remember to only substitute tubes of the same type and pin configuration!

**Any damages caused by shorting out Internal Circuitry due to a tube mismatch are NOT covered by the warranty.**

The term NOS stands for New Old Stock and is applied to never-used surplus tubes that are no longer manufactured. You may find 12AX7s by Mullard, Telefunken or Tesla, or EL 84s from Sylvania or other old manufacturers. Inserting any of these tubes will result in a definite overall sonic change of character - whether for better or worse will be for you to decide. If you find NOS tubes that you prefer over our stock tubes, remember to purchase excess amounts for continuous maintenance - you might otherwise find that the limited supplies of your NOS have sold out by the time you need to retube your amplifier.

## **Chapter 8 - EVOLUTION OF THE *TIGRIS*:**

---

For those curious about the design process, from idea to prototype to final product, we like to give you some background on the evolution of the TIGRIS: from the original prototype through generation II and III to the final production version. This will help you understand the passion for refinement and the concern for your satisfaction that went into it.

Beginning with our Mesa BARON as an engineering platform, we originally conceived of the TIGRIS as a dual-mono design taken to the equivalent extreme. The BARON'S dual-mono nature duplicates On/Off, Standby, Meter and Ground switches, even the power cords, and the circuit board layout is fully mirror-imaged and features separate power- and output transformers for each channel.

In the TIGRIS, this concept manifested externally as dual Volume controls, dual Input selectors and a single row of mirror-imaged RCA input terminals on the Rear Panel, while internally duplicating the BARON'S parameters of mirror-image layout and dual power- and output transformers: dual-mono taken to its logical conclusion. However, potential customers and retailers alike felt that taken this far, dual-mono would be more inconvenient to use than offer a real performance advantage. This would be of interest only to a small group of dedicated audiophiles willing to trade basic convenience for the theoretical purity of the design's uncompromising execution. We quickly returned to the drawing room.

Without altering the design's internal dual-mono construction, we redesigned the Rear-Panel for the more conventional dual rows of closely-spaced RCA jacks and simplified operations and the appearance of the Front Panel by substituting stereo controls for the formerly duplicated Input selector and attenuator. We also added the Headphone Output and buffered Preamp Output. To investigate

## **EVOLUTION OF THE TIGRIS: (Continued)**

the headphone potential, we initially jerry-rigged a headphone jack to the speaker outputs. This proved impressive enough, so we re-engineered some of the internal earthing arrangements to further quiet the power amp stage which, rather than the preamp stage, would drive the headphones. This transferred Tandem-State Imaging - access to the headphones, a first in the industry.

The new Preamp Output required an extra 12AX7 over the original three which meant additional redesign of the board-layout to accommodate the extra tube position. To create the necessary space on the board required changing the positioning of the storage capacitors which ended up actually increased their capacity, improving dynamic headroom. This is but one of many examples how a hands-on rather than theoretical approach to design and engineering, though time-consuming, pays off .

Generation II was how we introduced the TIGRIS at WCES 1997 in Las Vegas: dual-mono internally, but with a single Volume and Input Selector control and two new features. Returning to the factory with enormous amounts of congratulatory feedback for the TIGRIS prototype, we determined that an additional feature would make this amplifier yet more versatile and attractive: the Level Set attenuator dedicated to the Preamp Output. This attenuator would enable convenient level matching for bi-amplification schemes. It's an upgrade path that has frustrated many music lovers with integrated units who usually need to add active crossovers or otherwise insert a means to level-balance the second amplifier.

We decided to build a provision for such an application right into the unit, though now another issue reared its head. Every change of feedback or Triode / Pentode setting in the TIGRIS would alter the level balance with the second amp and require an adjustment, making use of these tuning options while bi-amping less than convenient. We were also concerned that the output level of the Preamp Out jacks during very low volumes might be insufficient to drive an amplifier of lowish input sensitivity. So we decided upon sourcing the signal for the Preamp Output not from the extra 12AX7 we had previously installed for this purpose, but from the final section, thus feeding the same signal to the second amp which the TIGRIS is sending to the speakers. This both solved drivability concerns and made subsequent level matching between the TIGRIS and the second amp a non-issue. Any change in feedback or Pentode / Triode activity now affects both units simultaneously. (Please note that the moniker 'Preamp Out' is for convenience's sake - it is technically different from a conventional preamplifier signal!)

However, now the fourth 12AX7 was suddenly obsolete!

We then looked at various possible applications to make use of this tube in a different way. Based on critical listening tests, we wired it in parallel with the first preamp 12AX7, thus increasing current delivery and subtracting noise, adding body and bloom to the presentation. This became generation III: an extra attenuator and an improved preamp section. However, one further incarnation was to occur when repeated tests showed us that our selectable tube / solid state rectification, a feature of the first three versions of the TIGRIS, was sonically invisible. Sonic transparency is usually a good thing, but in this case we had incorporated an advanced tuning feature to make a distinct sonic contribution. We hold the patent for User-Selectable Silicon Diode / Tube Rectification, and in our A/B biased guitar amps the sonic effects are very noticeable and useful. We automatically decided to incorporate such a novel feature into our assault on affordable state-of-the-art tube amplification, aka the TIGRIS. You might have seen some of our first TIGRIS ads and postcards which still clearly show the dual 5AR4 / GZ34 rectifier tubes.

However, we learned that selectable tube / solid state rectification in a Class A design such as the TIGRIS has decidedly less of an impact than in high-power Class A/B design routinely driven into clip. With the TIGRIS, even experienced retailers couldn't tell either setting apart. Neither could we, and we had to admit that a feature for feature's sake simply wasn't worth having. So out it went. One final trip to the drawing board now dealt with the last challenge: how to utilize the two outer toggle switches that previously controlled tube / solid state rectification. Visually, the design simply looked incomplete without them.

We came upon a simple and elegant solution: to relocate the formerly rear-mounted A.C. ON / OFF and Ground switches up front, thereby making them more accessible, and to move the Level Set attenuator from its former Rear Panel to its present Rear Bay location, mirror-imaging the Negative Feedback selector, with the Headphone / Speaker selector in between. The design was now finalized and production, a year since the first prototype, could finally begin. Generation IV is how we introduced the finalized TIGRIS to the public at large during HiFi 97 in San Francisco, May / June 1997 and first shipments commenced simultaneously.

You will appreciate the fact that your new amplifier went through this lengthy process of development and evolution prior to going into

## **Chapter 8 - EVOLUTION OF THE *TIGRIS* (Continued)**

production! Rather than worrying about future 'Mark II and III' upgrades with additional expenses and down-time for shipping, you can rest assured that you purchased a fully matured design. Rather than using our customers as beta-testers to fine-tune a design, we spent two trade shows and a year's worth of collaboration with retailers and consumers alike to get it right from the beginning. Anything we could think of as essential has been incorporated, and extraneous features were deleted.

It is thus highly unlikely that any future modifications will occur.

## **Chapter 9 - THE *Mesa/Boogie* PROFESSIONAL HERITAGE:**

If you are not a musician, this unique aspect of the TIGRIS amplifier might not be readily apparent to you. For those of you interested in a more complete history of our company, we refer you to an interview between Randall Smith, owner and chief designer, and Chip Stern, writer for the magazine *Stereophile*, that appeared in January 1997 and is included with your original kit.

Briefly stated, we have been designing, building and maintaining guitar tube amplifiers since the early 1970s, and have a world-wide following of devoted musicians who rely on our technical expertise, factory support and warranty back-up to, quite literally, keep performing. We support working musicians whose livelihood and creativity is deeply connected to their amplifiers of choice. This is a responsibility we take very seriously. Our road-going *Mesa/Boogie* gear is built to the very highest standards that reflects the level of abuse that is part and parcel of the Pro Music world.

We know only one way to build equipment. The assemblers and technicians building and QC-ing our MI gear are the very same that build and test the HiFi products. So the concern for reliability and detail that fuels our passion for musical instruments manufacture is likewise evident in our High-End products, the TIGRIS and BARON amplifiers.

We are so confident of our quality of design and execution that we offer a full three years parts and labor warranty. (See chapter 14.) Many of our first, by now quite legendary, *Mesa/Boogies* are still fully operational and grace the stage of international concerts.

## **Chapter 10 - CUSTOMER SERVICE:**

There may be occasions when you need service that goes beyond what the retailer from whom you bought your amplifier can provide. Or you may have a question which he can't answer. When this happens, you may call our factory directly. Our MI division employs 3-4 people just to answer customer inquiries and questions 10 hours a day. This service comes with your purchase, too - and free. All we ask of you is that you have read and tried to understand this owner's manual first before you call with a problem. You might be surprised to know how many calls we receive where the caller has never read the manual. Most problems have to do with tubes and merely require exchanging the culprits.

### **Learning how to recognize and eliminate a potentially troublesome tube is important for owners of any tube gear.**

This is explained in chapter 11 on trouble shooting, but should you find yourself at a loss, or simply want to give us feedback on how the TIGRIS performs in your system, we always welcome your calls. We promise you our very best efforts in making ownership of the TIGRIS one of the most rewarding purchases of your life, but please - do not call us with questions on how amplifier X compares with amplifier Z! We are not in a position to audition various components or study competing designs and frankly do not have the time to act as audio consultants in this fashion - such feedback is best obtained from a retailer. Also, it goes without saying that we have a very biased Class A opinion of our own amplifiers...



## Chapter 11 -TROUBLE SHOOTING:

The most common failure in a tube amp are ... tubes, you guessed right. There are two main types of tube failure: shorts and noise. Both large and small tubes may fall prey to either of these problems, but diagnosis and remedy is usually simple. Let's begin with noise:

Often caused by contamination within a tube, a noisy tube can usually be identified by lightly tapping on the outer glass envelope. When tapping a tube causes the noise to change, you have probably found the culprit. Hearing some residual noise through the speakers while tapping on the 12AX7s is normal, however. The power tubes, EL84s and 6V6s, should be all but quiet when tapped. If crackling or hissing changes with the tapping, you have likely found the problem. To confirm a noisy power tube, simply put the corresponding channel in WARM mode, remove the tube from its socket and turn the TIGRIS back on. It will cause no damage to run the TIGRIS briefly with one tube missing. However, you may notice a slight background hum as the push-pull balance offsets.

Whenever you are trying to diagnose a suspect tube, keep your other hand on the A.C. ON / OFF switch to shut off the amplifier in the unlikely event that you provoke a major tube short. If you're unsure about whether you have properly identified a problem tube, we recommend substituting the suspect with a tube from the same location in the other channel. The second, less benign cause for tube failure is the severe short. In the worst case scenario, a major arcing short occurs between the plate and cathode with visible lightning inside the glass and a major noise through the speaker. If you witness such a short, immediately turn the amp off while unplugging the A.C. power cord from the rear of the TIGRIS. By this time the rear-mounted fuse will probably have blown but the current drawn by the shorted tube can be so excessive that pulling the cord is recommended. Such a short is usually caused by a physical breakdown inside the tube including contaminate coming loose or physical or near contact between the elements.

**NO SOUND:** Check that the amp is in operate, the selected input corresponds with the source you are trying to listen to, all cable connections are proper, and the Headphone selector is disengaged. If the trouble occurs with a subwoofer or a multi room amplifier connected to the Preamp Out, check that the Level Set control isn't fully closed.

Intermittent sound/no sound could indicate a bad cable termination - check the interconnects attached to your currently active source. Turn the TIGRIS off, disconnect the RCAs from the input jacks and unscrew the RCA cover to visually inspect the internal solder joint of the hot and ground conductors to the center pin and sleeve. If the cover doesn't unscrew or is encased in heat shrink, try wiggling the cables right behind the RCA jacks while signal is playing. Often this physical movement will make intermittent contact when a solder joint has broken and thus indicate a faulty termination. Should only one channel suffer from a muted condition, try reversing the input leads to see whether the muted channel follows. This could indicate a broken cable or trouble with a channel of your source component.

For conditions you cannot adequately trouble-shoot yourself, don't hesitate to contact your retailer or call us direct at (USA) 707-778-9505 to obtain personal assistance.

## Chapter 12 - SPECS VERSUS PERFORMANCE :

At Mesa Engineering, we strongly believe that musical enjoyment from listening to recorded music is a matter of the heart and soul of the listener, while specs appeal primarily to the mind. With the advent of ultra-sophisticated military- and medical-grade measuring equipment, specs are obtainable that look mightily impressive on paper but bear little correlation to the real world, such as distortion specs of less than 1/2%. It is very easy to obsess about the theoretical advantages of components that measure better, entirely forgetting that many of these measurements are beyond our human hearing capabilities. Unfortunately, assembling a system of Class A rated components with state-of-the-art specs is, in itself, no guarantee for first-rate performance.

This is because, besides matters of synergy, specs don't tell the whole story, and many factors influencing final results aren't measurable, or don't mean what they suggest.

It is well-known, for example, that vacuum tubes have higher distortion specs than transistors, and that electrostatic speakers don't measure as flat as many dynamic designs. Many listeners, however, much prefer the sound of tubes to solid state, and the transparency of electrostats to conventional speaker designs.

## Chapter 12 - SPECS VERSUS PERFORMANCE: (Continued)

When evaluating and choosing components, specs may be used as a starting point to reduce the number of options to a realistic figure, but then it becomes vitally important to remember how these components will be ultimately used: for the joy of music in a home environment, as opposed to on a test bench in an anechoic chamber.

We thus encourage you to trust your dealer's advice with regard to system compatibility, which is based on a combination of elemental specs and the specialty retailers' experience. This will ensure a good match, beyond which this owners manual contains everything you need to know about operating your new component.

It is a sad truth amongst audiophiles that, during our sometimes compulsive search for perfection, we unlearn the art of listening from the heart and act like judges during a music competition or audition, looking for things to criticize rather than allowing the music to take a hold over our emotions.

So we haven't included the usual spec sheet with this manual. Besides the reasons already given, the unique flexibility of the TIGRIS would necessitate 12 sets of most measurements to address the effects of all possible settings - frankly more information than we think meaningful.

We are hoping that instead, you trust your ears and your heart's response that the TIGRIS delivers where it counts: to help create the illusion that Louis Satchmo Armstrong or Sasha Heifetz ( or any of your favorite musicians ) have, magically, been transported into your living room for a private performance at your beck and call.

If you can close your eyes and see the performers with your ears as if they were truly there with you, living and breathing and playing, then our specs have succeeded.

## Chapter 13 - BASIC SPECS :

---

For those wanting a little bit more information about the basic construction of the TIGRIS, here are a few highlights which cover some aspects previously discussed:

- true dual-mono design with separate power- and output transformers for each channel and mirror-imaged circuit board layout
- three-ounce copper traces with plated-through epoxy circuit board
- "flying leads" point-to-point hand wiring in critical places
- 1% metal film resistors and audiophile-grade capacitors
- proprietary ceramic tube sockets with silver-plated contacts
- gold-plated fine-thread 4-way speakers binding posts accommodate the bulkiest terminations
- dual warm / operate switches allow instantaneous playback without thermal stabilization time lag
- Class A, auto-bias push-pull design with ultra low-noise preamplification stage
- proprietary Tandem-State Imaging
- variable output power: 35 Watts per Ch. full Pentode, 28 Watts per Ch. 2/3 Pentode and 20 Watts per Ch. 2/3 Triode
- 4 position adjustable Negative Feedback, from Zero Feedback to Stage III
  - in full Pentode, stage I = 5dB, stage II = 8dB and stage III = 12dB
  - in 2/3 Pentode, stage I = 4dB, stage II = 7dB and stage III = 10dB
  - in 2/3 Triode, stage I = 3dB, stage II = 5dB and stage III = 8dB
- massive 8-pole industrial switch converts Integrated into dedicated Headphone amplifier which is driven from the entire array of output power tubes
- 4 line level inputs, 1 fixed output, 1 variable buffered output with dedicated Level Set attenuator
- ground switch
- detachable power cord
- two color options: gold or silver anodized front panel, Front Panel controls and full-width transformer cover
  - dimensions: 17.25 inches wide x 16.25 inches deep by 6 inches high
  - (depth measurement includes RCA output jacks and frontal controls)
- weight: 35 lbs

## Chapter 14 - WARRANTY :

---

### 14 - 1 WITHIN THE US:

Your Mesa TIGRIS Integrated & Headphone amplifier is covered by a limited 30 days warranty. To extend it to its full three years coverage on parts & labor, you must complete the warranty registration form in Chapter 15 and return it to us by mail within 30 days from date of purchase. In the event your TIGRIS needs service under warranty, we pay for return shipping to you, while you are responsible for shipping charges to us. It is mandatory to use the original packing material. (If you no longer have it, let us send you an empty box to insure safe transit of your amplifier.)

Do not return the **TIGRIS** to the factory without first obtaining a four digit return authorization number via phone. Any product shipped to the factory without prior authorization will be refused and returned to you freight collect. When you do have to return your amp to us for service, remember to insure it for full value to protect yourself from potential shipping damage or loss! We recommend using FedEx as your carrier of choice.

### 14 - 2 OUTSIDE THE US:

Export models, which only differ from domestic models to comply with international line voltages are warranted under the particular warranty issued by the importer / distributor who assumes responsibility for setting up authorized repair stations for which we supply parts, schematics and technical support. If you have purchased your TIGRIS outside the US, please contact your local retailer for details on the warranty offered in your country. Similar return authorization procedures to the one above may apply. Check with your retailer or importer first before returning product for service.

We still request you return the warranty registration form to us - the questionnaire part provides us very valuable feedback from our customers, and in order to properly address the global community of music lovers, we want to also hear from end users outside of our own country. So even though your warranty services won't be handled by us directly, do return the form to us nonetheless. Thank you.

# 15 - WARRANTY REGISTRATION FORM:

Congratulations! You have just purchased one of the finest integrated amplifiers on the market. You should enjoy countless hours of musical magic in the comfort of your home for years to come. To help us serve you with your purchase, please fill out this form and return to us together with a copy of your original sales receipt.

This automatically extends your limited 30 days warranty on the TIGRIS to its full three year length on parts & labor. Your initial set of tubes is guaranteed for 6 months and replacement tubes are available thereafter as we said earlier in this owner's manual at a discount, factory-direct or from your Mesa dealer.

**How did you first hear about the *Mesa TIGRIS*?  
(you may check more than one)**

- word-of-mouth
- read about it in a review
- other
- saw it at a retail store
- saw an ad in:

**How do you rate the following publications on a scale of 1-10 (1 poor - 10 excellent)?**

- Stereophile
- Absolute Sound
- Audiophile Voice
- HiFi Choice
- Bound for Sound
- Inner Ear Report
- FI
- Audio Adventure
- Positive Feedback
- HiFi News
- Sensible Sound
- other

**What feature / quality of the *TIGRIS* most contributed to your purchase? Establish a sequence of importance, 1 for most, 8 for least important, using numbers 1-8 once each.**

- sound quality
- output power
- Mesa/Boogie* MI heritage
- price / performance ratio
- tandem state imaging
- ruggedness & reliability
- appearance
- other ( please specify )

**What is your favorite setting, with what stage of feedback?**

\_\_\_\_\_

**Which is your least favorite setting in your system?**

\_\_\_\_\_

**Tell us about your system (brand. model):**

Source component \_\_\_\_\_  
 Speakers \_\_\_\_\_  
 Cables \_\_\_\_\_  
 Accessories \_\_\_\_\_

**What other amplifiers did you consider before choosing the *TIGRIS*?**

\_\_\_\_\_

**What is the approximate value of your system total?**

- 1 month salary
- 2 months
- 3 months
- 4 months
- 5 months
- 6 months or more

**What is the approximate value of your CD / record collection?**

- below \$500
- up to \$1,000
- up to \$2,000
- up to \$5,000
- more

**How much time weekly do you listen to your system?**

- 1-5 hours
- 5-10 hours
- 10-20 hours
- more (lucky you!)

**Do you have a surround sound home theater?**

- yes
- no

**If you do, what is the approximate percentage between 2 channel and surround sound use?**

*(list 2 channel first, like 70/30)*

\_\_\_\_\_

**If you don't, do you plan to expand your 2 channel system into home theater?**

- yes
- no --OR--
- eventually to add a dedicated home theater system?
- yes
- no

**Any comments on the *TIGRIS*?**

\_\_\_\_\_  
 \_\_\_\_\_  
 \_\_\_\_\_  
 \_\_\_\_\_  
 \_\_\_\_\_

**WARRANTY REGISTRATION FORM: ( Continued )**

What other products would you like to see from us in the future?

---

How do you rate your dealer in terms of presentation? poor  good  excellent

Product knowledge? poor  good  excellent  Customer Service?  poor  good  excellent

Anything else about your dealer we should know? \_\_\_\_\_

---

How important are specs versus listening to you when you make a purchasing decision?

(Use percentages, specs first, like 25/75) \_\_\_\_\_

Your Name \_\_\_\_\_

Date of Purchase \_\_\_\_\_ Serial # \_\_\_\_\_

Address \_\_\_\_\_

Phone (\_\_\_\_) \_\_\_\_\_

Dealer Name and Location \_\_\_\_\_

*Thank you for your purchase and for taking part in our on-going customer research!*

**FROM:** \_\_\_\_\_

\_\_\_\_\_

\_\_\_\_\_

Postage

**Mesa Engineering**  
**1317 Ross Street**  
**Petaluma, CA 94954**

# ***MESA/BOOGIE***

***The Spirit of Art in Technology***

***Thank you*** for trusting MESA/Boogie to be your amplifier company. We wish you many years of toneful enjoyment from this handbuilt all tube instrument.

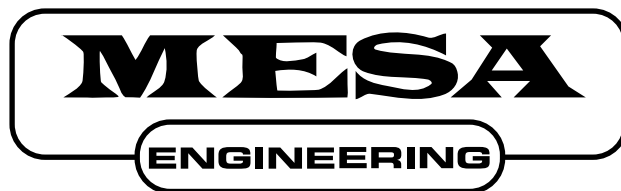

*The Spirit of Art in Technology*



*1317 Ross Street Petaluma, CA 94954  
USA*

*(707) 778-6565 Phone  
(707) 765-1503 Fax*

## Free Manuals Download Website

<http://myh66.com>

<http://usermanuals.us>

<http://www.somanuals.com>

<http://www.4manuals.cc>

<http://www.manual-lib.com>

<http://www.404manual.com>

<http://www.luxmanual.com>

<http://aubethermostatmanual.com>

Golf course search by state

<http://golfingnear.com>

Email search by domain

<http://emailbydomain.com>

Auto manuals search

<http://auto.somanuals.com>

TV manuals search

<http://tv.somanuals.com>