



INSTALLATION INSTRUCTIONS FOR PART 99-7952

APPLICATIONS 2005-2007 Suzuki Aerio

99-7952

KIT FEATURES

- DIN head unit provision
- ISO DIN head unit provision



KIT COMPONENTS

A) Radio Housing | B) ISO Brackets | C) Trim Plate

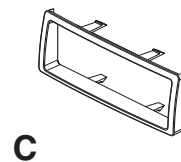
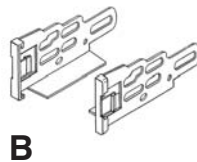
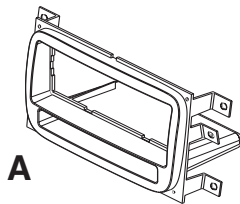

TOOLS REQUIRED:

Phillips Screwdriver | Small Flat Blade Screwdriver | Utility Knife

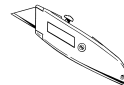
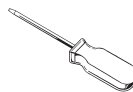
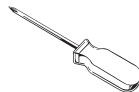

1-800-221-0932



www.metraonline.com

© COPYRIGHT 2004 METRA ELECTRONICS CORPORATION



TABLE OF CONTENTS

***Dash Disassembly* 1**

***Kit Assembly* 2, 3**

***Final Assembly* 4**

2005-2007 SUZUKI AERIO

- 1 Disconnect the negative battery terminal to prevent an accidental short circuit.
- 2 Unclip and remove the trim panels from both sides of radio/climate controls. (Figure A)
- 3 Remove (4) Phillips screws holding radio to sub dash and remove radio. (Figure B)
- 4 Remove (4))Phillips screws securing the radio and brackets to the factory radio trim panel. (Figure C)

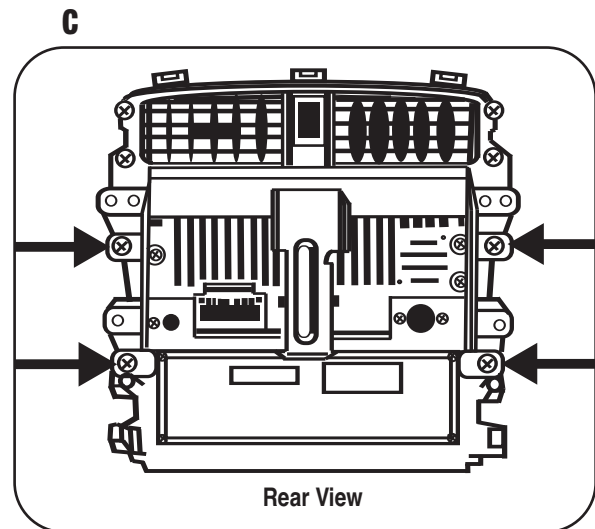
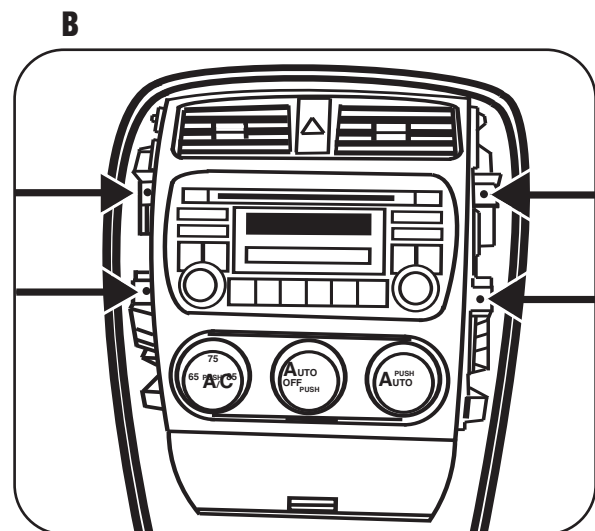
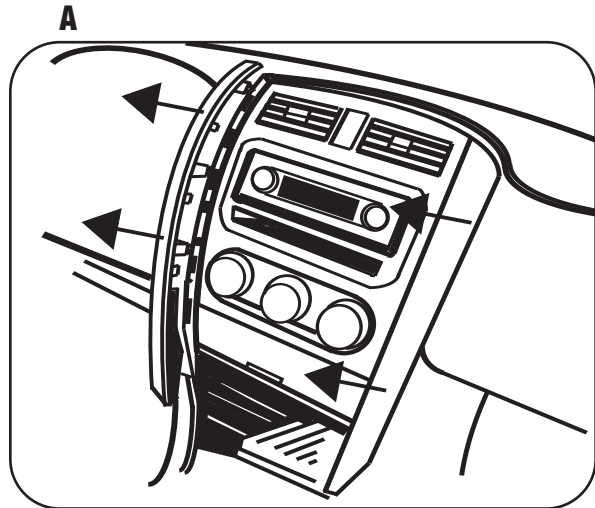

DIN HEAD UNIT PROVISION

- 1** Cut and remove the center bar in the DIN opening of the 99-7952 Radio Housing.
- 2** Secure the 99-7952 radio housing to the factory radio trim panel using the factory hardware.
- 3** Slide the DIN cage into the Radio Housing and secure by bending the metal locking tabs down. (Figure A)
- 4** Slide the aftermarket head unit into the cage and secure. (Figure B)

A

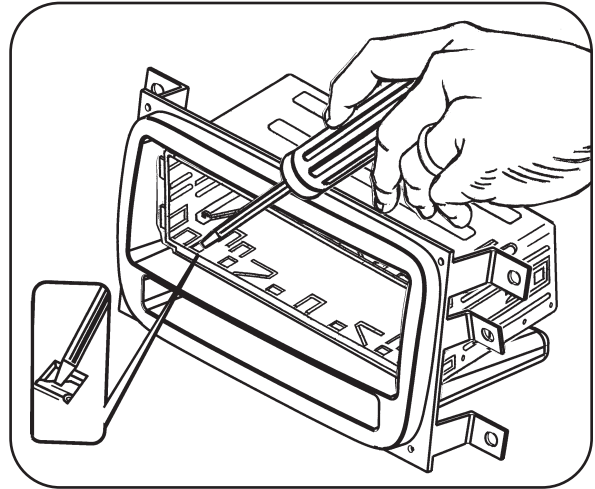

B

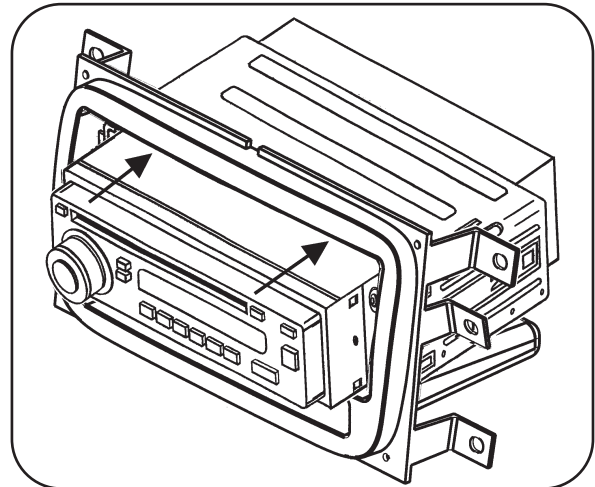

ISO DIN HEAD UNIT PROVISION

- 1** Cut and remove the center bar in the DIN opening of the 99-7952 Radio Housing.
- 2** Secure the 99-7952 radio housing to the factory radio trim panel using the factory hardware.
- 3** Mount the ISO Brackets to the head unit with the screws supplied with the unit. (Figure A)
- 4** Slide the head unit into the radio opening until the side clips engage. (Figure B)
- 5** Snap the Trim plate into the Radio Housing. (Figure B)

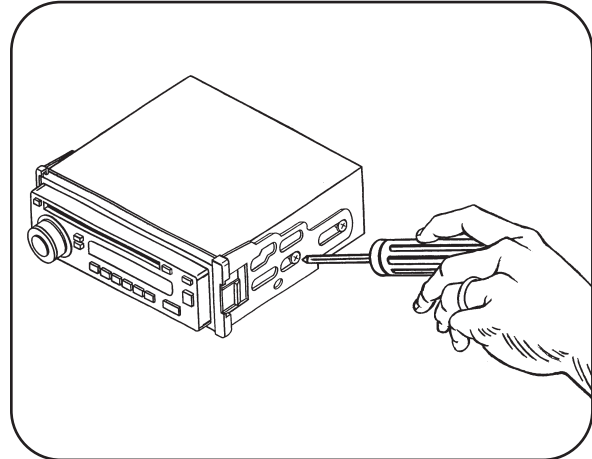
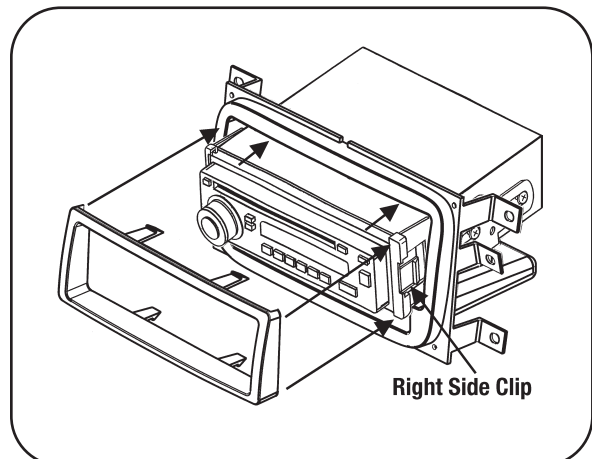
A

B

FINAL ASSEMBLY

- 1 Locate the factory wiring harness in the dash and make the connection as shown. Metra recommends using the proper mating adapter and making the connections as shown. (Isolate and individually tape off the ends of any unused wires to prevent electrical short circuit.)
- 2 Re-connect the negative battery terminal and test the unit for proper operation.
- 3 Reassemble radio and dash assemblies in reverse order of disassembly.

FINAL WIRING CONNECTIONS

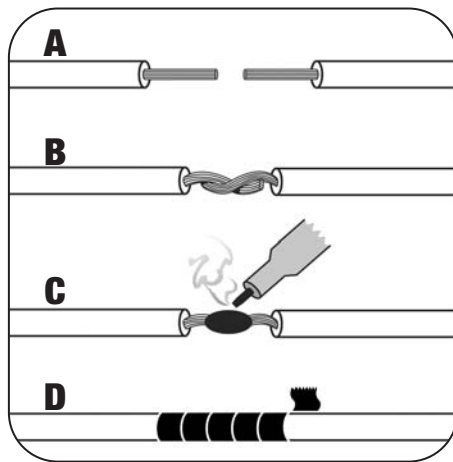
Make wiring connections using the EIA color code chart shown below and the instructions included with the head unit. Metra recommends making connections as shown below; Strip, Splice, Solder, Tape. Isolate and individually tape off ends of any unused wires to prevent electrical short circuit.



- A) Strip wire ends back 1/2"**
- B) Twist ends together**
- C) Solder**
- D) Tape**

METRA / EIA WIRING CODE

12V Ignition / Acc . . . Red	Right Front (+) Gray
12V Batt / Memory . . Yellow	Right Front (-) Gray / Black
Ground Black*	Left Front (+) White
Power Antenna Blue	Left Front (-) White / Black
Amp Turn-On Blue / White	Right Rear (+) Violet
Amp Ground Black / White	Right Rear (-) Violet / Black
Illumination Orange	Left Rear (+) Green
Dimmer Orange / White	Left Rear (-) Green / Black

***NOTE:** When Black a wire is not present, ground radio to vehicle chassis.

All colors may not be present on all leads due to manufacturer's specifications.

INST997952



1-800-221-0932



www.metraonline.com

REV. 04/10/07

© COPYRIGHT 2004 METRA ELECTRONICS CORPORATION

INST99-7952

Free Manuals Download Website

<http://myh66.com>

<http://usermanuals.us>

<http://www.somanuals.com>

<http://www.4manuals.cc>

<http://www.manual-lib.com>

<http://www.404manual.com>

<http://www.luxmanual.com>

<http://aubethermostatmanual.com>

Golf course search by state

<http://golfingnear.com>

Email search by domain

<http://emailbydomain.com>

Auto manuals search

<http://auto.somanuals.com>

TV manuals search

<http://tv.somanuals.com>