



INSTALLATION INSTRUCTIONS FOR PART 99-7322

APPLICATIONS Hyundai Azera 2006-2010

99-7322



KIT FEATURES

- DIN Radio Provision with Pocket
- ISO Radio Provision with Pocket

KIT COMPONENTS

A) Radio Housing • B) ISO Brackets • C) Trim Plate

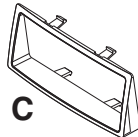
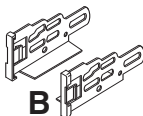
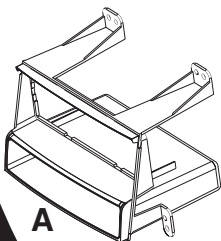

WIRING AND ANTENNA CONNECTIONS (Sold Separately) Wiring Harness:

- 70-1004 - Hyundai/KIA harness 2004-up
- 70-7303 - Hyundai/KIA harness 2009

Antenna Adapter:

- 40-K110 KIA antenna adapter 2007-up

TOOLS REQUIRED:

- Small Flat Blade Screwdriver/ Panel Removal Tool
- Phillips Screwdriver



1-800-221-0932



www.metraonline.com

© COPYRIGHT 2004-2010 METRA ELECTRONICS CORPORATION



TABLE OF CONTENTS

Dash Disassembly

- Hyundai Azera 2006-2010..... 1,2

Kit Assembly

- DIN Radio Provision 3

- ISO Radio Provision 4

Final Assembly 5

***Note:**

Refer also to the instructions included with the aftermarket radio.

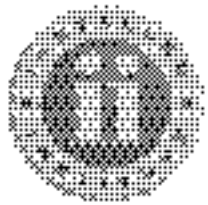

KNOWLEDGE IS POWER

Obtain your information and education only by reading the most recognized and respected mobile electronics journal in our industry. Log onto www.metradirect.com or call 800-368-0788 for more information and take steps to ensure a better tomorrow.

HYUNDAI AZERA 2006-2010

- 1** Disconnect the negative battery terminal to prevent an accidental short circuit.
- 2** Remove (1) Phillips head screw from bottom right hand corner then unclip and let the panel below the steering column hang. (Figure A)
- 3** Remove (1) Phillips screw from the lower left side of the radio panel behind panel removed in step 2. (Figure B)
- 4** Unclip and remove the trim panel above the radio that extends across the dash to the passenger side. (Figure C)

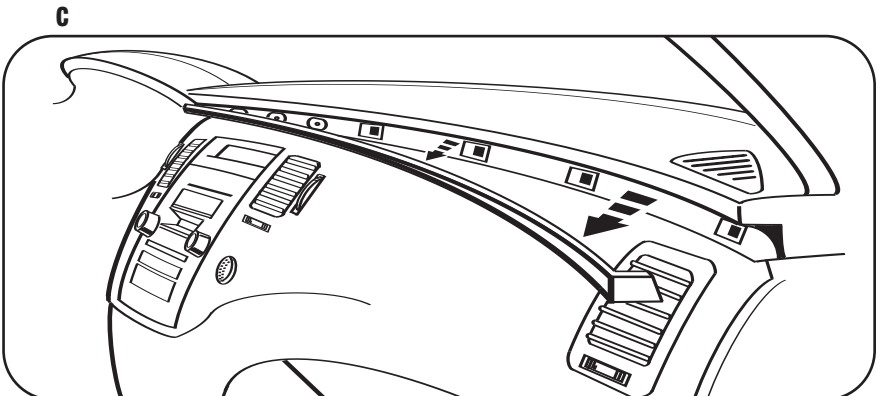
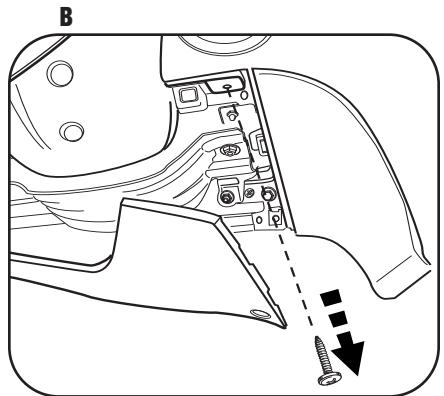
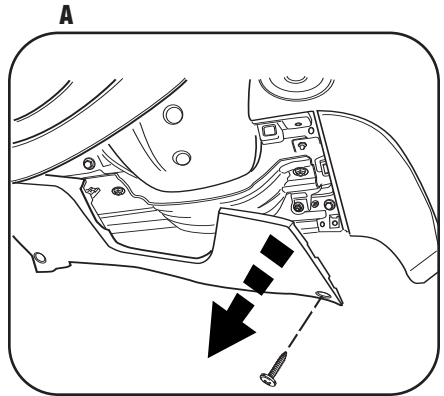

HYUNDAI AZERA 2006-2010

- 5** Remove (3) Phillips screws from the top of the radio trim panel. (Figure D)
- 6** Remove (2) Phillips screws from under radio trim panel. (Figure E)
- 7** Unclip and remove the entire trim panel surrounding the radio. (Figure F)
- 8** Remove (4) Phillips screws securing the radio. Unplug and remove radio. (Figure G)

Continue to kit assembly.

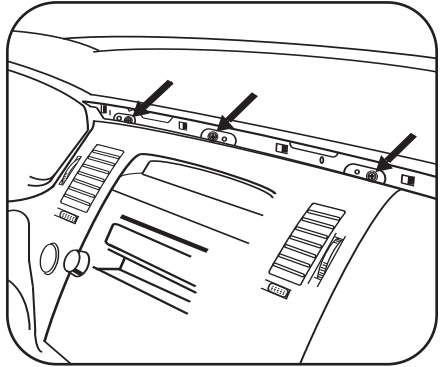
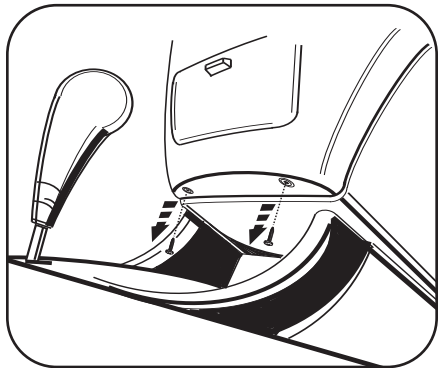
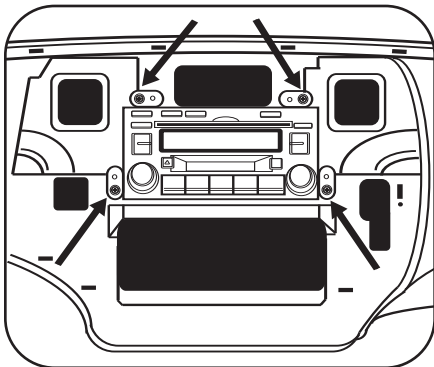
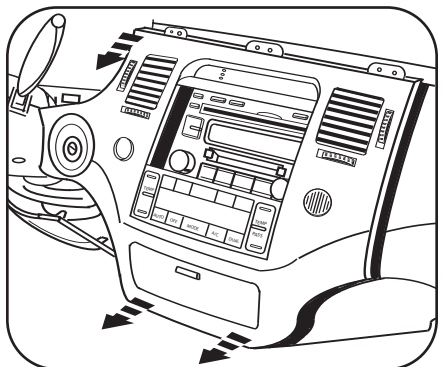
D**E****G****F**

DIN RADIO PROVISION

**Note: Refer also to the instructions included with the aftermarket radio.*

- 1 Slide the DIN cage into the Radio Housing and secure by bending the metal locking tabs outward. (Figure A)
- 2 Slide the aftermarket radio into the cage and secure. (Figure B)

Continue to final assembly.

A

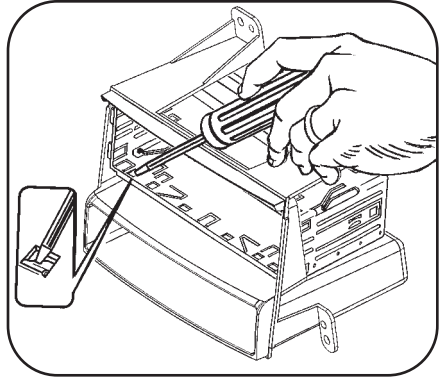

B

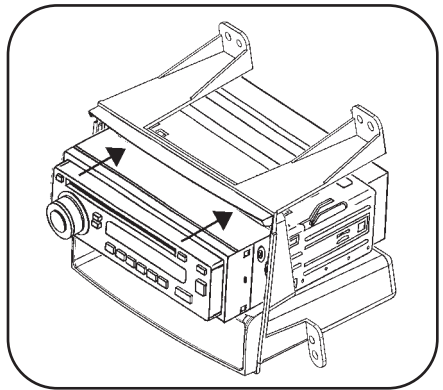

ISO DIN RADIO PROVISION

**Note: Refer also to the instructions included with the aftermarket radio.*

- 1** Mount the ISO Brackets to the aftermarket radio using the screws supplied with the radio. (Figure A)
- 2** Slide the radio into the radio opening until the side clips snap into place. (Figure B)
- 3** Snap the trim plate into the Radio Housing. (Figure B)

Continue to final assembly.

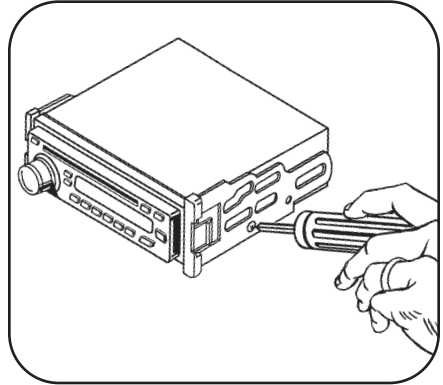
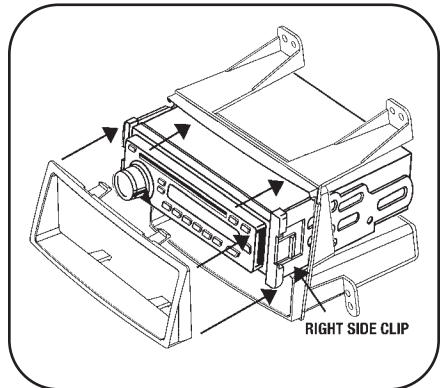
A**B**

FINAL ASSEMBLY

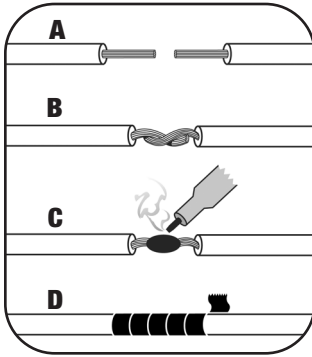

(A) Strip wire ends back 1/2"

B) Twist ends together

C) Solder

D) Tape

- 1** Locate the factory wiring harness in the dash. Metra recommends using the proper mating adapter and making connections as shown. (Isolate and individually tape off the ends of any unused wires to prevent electrical short circuit.)
- 2** Re-connect the negative battery terminal and test the unit for proper operation.
- 3** Reassemble radio and dash assemblies in reverse order of disassembly.

FINAL WIRING CONNECTIONS

Make wiring connections using the EIA color code chart shown below and the instructions included with the head unit. Metra recommends making connections as shown below; Strip, Splice, Solder, Tape. Isolate and individually tape off ends of any unused wires to prevent electrical short circuit.

METRA / EIA WIRING CODE

12V Ignition / Acc Red	Right Front (+) Gray
12V Batt / Memory Yellow	Right Front (-) Gray/ Black
Ground Black*	Left Front (+) White
Power Antenna Blue	Left Front (-) White / Black
Amp Turn-On Blue / White	Right Rear (+) Violet
Amp Ground Black / White	Right Rear (-) Violet / Black
Illumination Orange	Left Rear (+) Green
Dimmer Orange / White	Left Rear (-) Green / Black

***NOTE:** When a Black wire is not present, ground radio to vehicle chassis.

All colors may not be present on all leads due to manufacturer's specifications.

99-7322 INSTRUCTIONS



1-800-221-0932



www.metraonline.com

REV. 04/27/10 © COPYRIGHT 2004-2010 METRA ELECTRONICS CORPORATION INST99-7322

Free Manuals Download Website

<http://myh66.com>

<http://usermanuals.us>

<http://www.somanuals.com>

<http://www.4manuals.cc>

<http://www.manual-lib.com>

<http://www.404manual.com>

<http://www.luxmanual.com>

<http://aubethermostatmanual.com>

Golf course search by state

<http://golfingnear.com>

Email search by domain

<http://emailbydomain.com>

Auto manuals search

<http://auto.somanuals.com>

TV manuals search

<http://tv.somanuals.com>