

C a r A u d i o H i f i S y s t e m

## Mobile multimedia receiver **MIN-T66**

IN-DASH 7 INCH WIDE COLOR LCD WITH DVD RECEIVER



# Contents

<b>Safety Precautions.....</b>	<b>2</b>	<b>Radio Operation.....</b>	<b>10</b>
<b>Electric Connection.....</b>	<b>3</b>	Band	
Reception collection		Band tuner	
Speaker collection		AS/PS	
<b>Installation.....</b>	<b>4</b>	<b>Remote Control.....</b>	<b>11</b>
Install the unit		Loading and Replacing the battery	
Remove the unit		Basic operation	
<b>General Features.....</b>	<b>5</b>	<b>Accessories.....</b>	<b>15</b>
Open/Close		<b>Specifications.....</b>	<b>16</b>
Source/Power		<b>Trouble Shooting.....</b>	<b>17</b>
Mute			
N/P			
PBC			
Eject			
TFT-LCD adjustment			
play/pause			
Display position adjustment			
TV tuner			
CD changer			
How to set clock			
<b>Speaker setting.....</b>	<b>9</b>		
Volume setting			
Bass setting			
Treble setting			
Balance setting			
Fader setting			

## Safety precautions

---

### ▲ CAUTION

**To prevent injury or fire, Please take the following precautions:**

- Do not operate when driving.
- Be sure to store the liquid crystal panel inside the main unit when parking the car outdoors for long time.
- To prevent electric, etc., Please do not let the metal goods (silver, coin, tools, ...) fall into the installation.
- If you smell or see smoke, turn off the power immediately and consult our dealer.
- Be careful not to drop or shock the unit strongly.
- Do not touch the liquid crystal to avoid the life hurt. If the clothes is stained with it, Please clean it immediately by soap.
- In extremely cold weather, the display movement may slow down and the display may darken, but this is not a malfunction. Then display will work normally when the temperature increases.

### ▲ WARNING

**To prevent damage to the machine, take the following precautions:**

- Be sure the unit is connected to a 12V DC power with a Negative Ground.
- Do not install the unit in places where it is exposed to direct sunlight, high heat or humidity, water splash or dust.
- To change fuse, please use the same one in specification and capacity.
- When changing fuse, please do it after pulling down power wires to avoid short circuit.
- Do not place anything on the display when then panel is tilted.
- If the unit seems not work properly press the reset button to reset the memory of the unit.

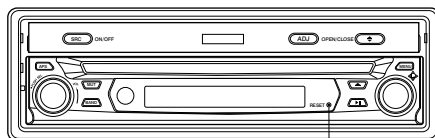

RESET

# Electric Connection

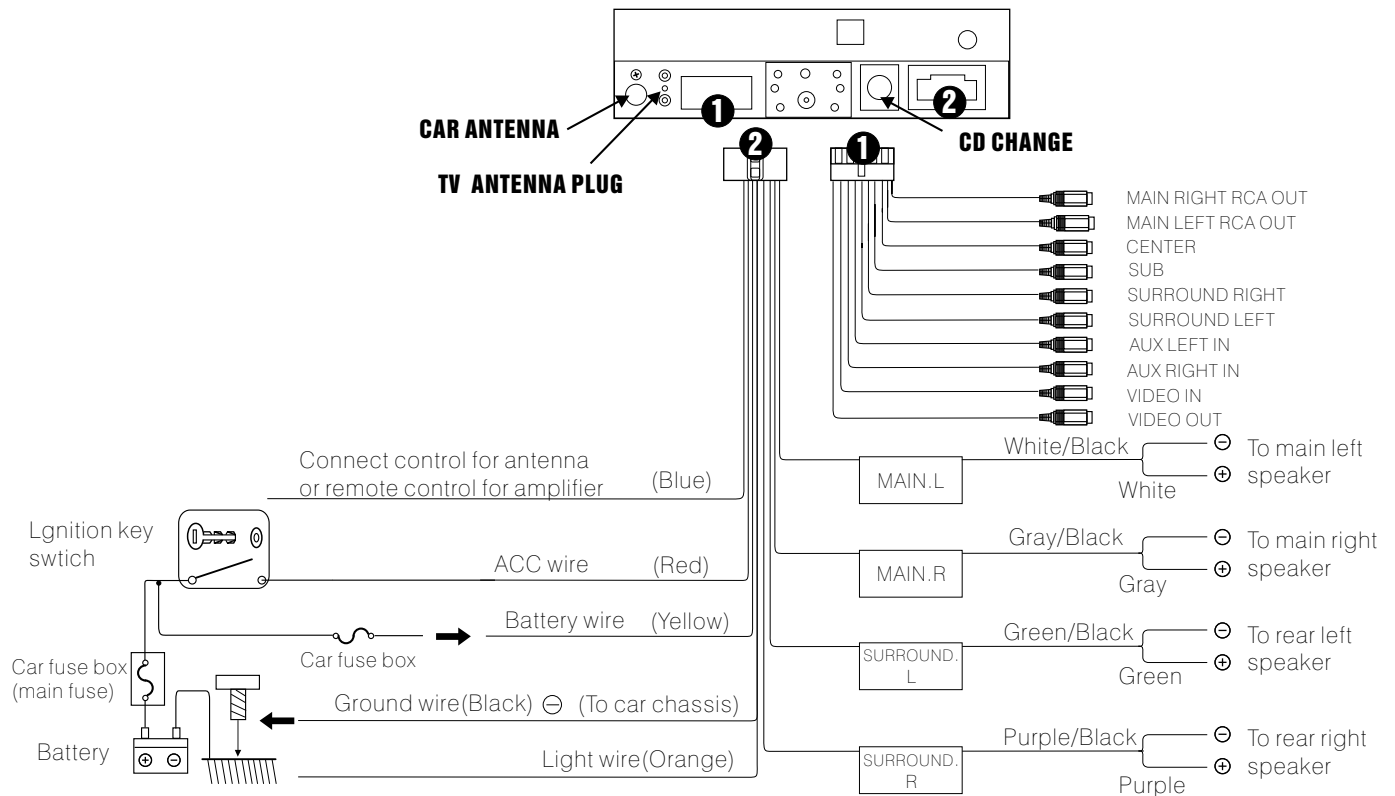

# Installation

- Before installing the receiver permanently, fit it in the approximate place in your car, and connect the equipment according to the speakers and electrical connections. When your system is operated properly, (preferably with the car engine running), follow the instructions for permanent installation of your system.

## INSTALL THE UNIT

- 1) Install half sleeve, can be with or without adapter. It will fit better with adapter.
- 2) Bend over some tabs to secure the half sleeve inside of dash.
- 3) Support strap to be strutted under dash, secure this strip to avoid skipping of disc.

## REMOVE THE UNIT

- Insert removal wrench into the small gap on the right side of the unit and pull the unit slightly out on the same side, then release the wrench. Repeat the same action for the left side. By now, you can remove the unit and unplug the wires connector.

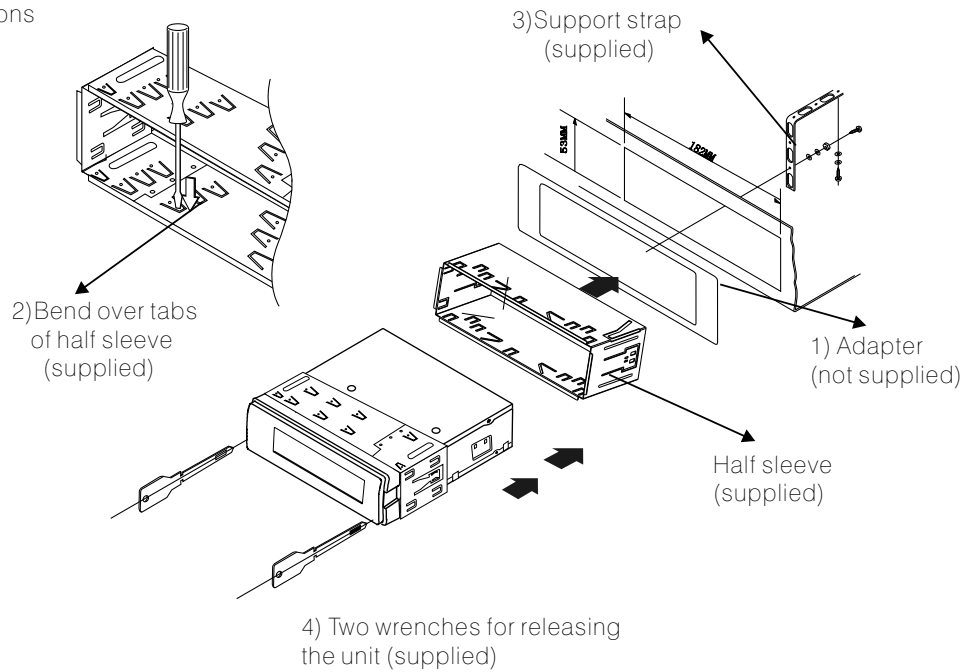

# General Features

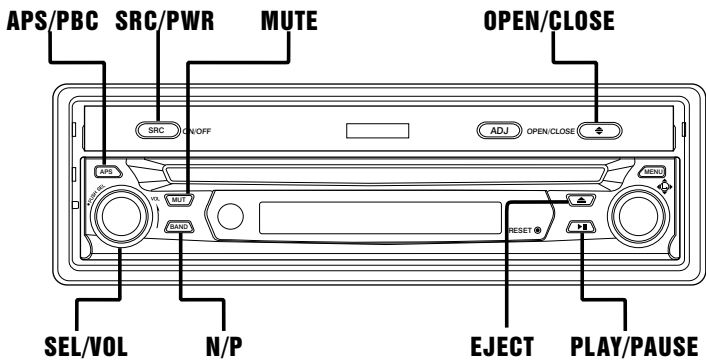

## Display Open/Close

Press [ ] (OPEN/CLOSE)  
 Press [ ] (OPEN/CLOSE) again.

- Notes:**
- If the unit stops halfway, press [ ] again and draw it all the way in.
  - Opening/closing the display can also be done when the power is off.

### ⚠ WARNING

- Do not touch the unit while the display is moving. Inserting hands, fingers or foreign objects into the unit can cause injuries and damage to the unit.
- Keep babies and children away from the unit.

## SOURCE/POWER

Turn your car`s ignition key to ACC or ON position.

**ON:** On being off, please short press [SRC] and it can be turned on, and still keep the showing angle when it was turned off last time.

**OFF:** On being open, please long press [SRC] then it can be turned off.

**SRC:** On being open, please short press [SRC] then can transit among the following status.

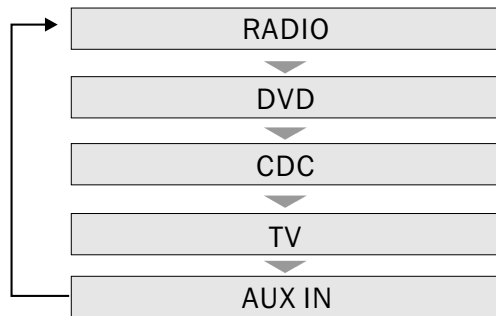

- CDC/AUX IN can be skipped when no external devices are connected.

## General Features

### Mute

Press the [MUT] button  
Press the [MUT] button again.

### N/P

- Under the playing, press [BAND] and can transit among PAL/AUTO/NTSC

### PBC

- Under the songs, press [APS] then show song content of disc and stop the playing song. If press again then come back the playing status.

### Eject

- Press the [▲] button to eject the disc out of the unit.



### Play/Pause

If with DISC in unit, Press the [▶||] to pause music.  
Press the [▶||] button again, come back DISC playing.

- If a disc is loaded, a sector sign will show on the display.

7 inches wide LCD display

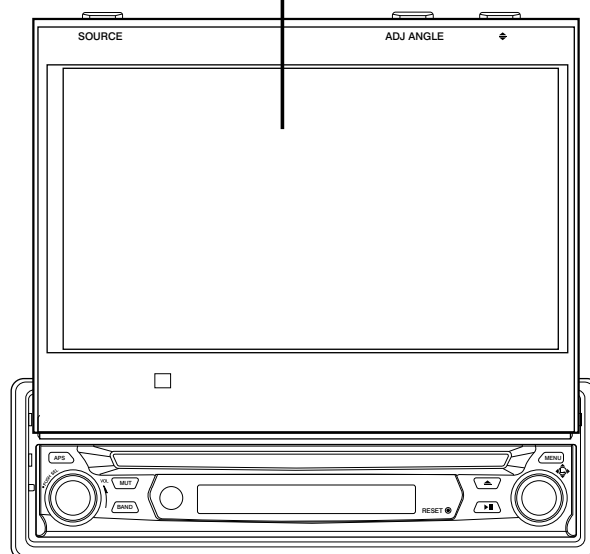

## General Features

### Display position Adjustment

- For smooth adjustment, make sure to first return the lateral angle to the neutral position and then adjust the tilt angle.
- Avoid physical shock on the display.

#### Tilt angle

Press [ADJ] button, it can adjust screen angle gradationally. The unit has 4 grades for adjustment, and each time you press the button, it can move one grade down along indication; it can resume up along indication.

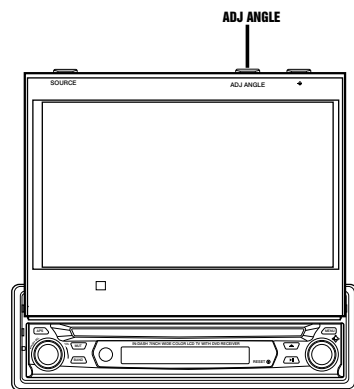
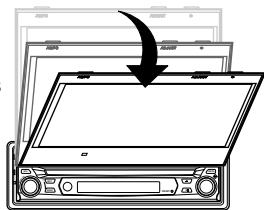

#### CAUTION

- Do not place any object on the display unit, or subject it to undue force.
- Do not move the display forcibly.
- The monitor movable range may be limited by a type of car, a position where the display is mounted, etc.

Press the [MENU] button, it will show as follows:

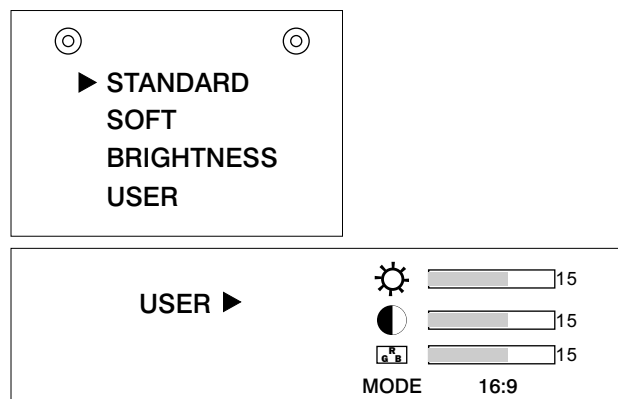

Press ▲ and ▼ to remote cursor up and down, and press ◀ or ▶ to adjust.

- In radio mode, 16:9 don't operation.



## General Features

### TV Tuner

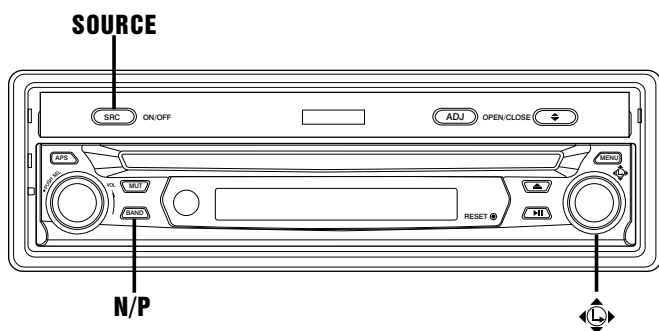

#### Preparation:

- To receive TV broadcasts, install the TV antenna.
- For receiving TV broadcasts, stop your car where there is no obstacle to broadcast reception around.

#### TV mode

Press [MODE] to change to TV mode.

#### Channel Selection

- [▶](CHANNEL):Up
- [◀](CHANNEL):Down

#### Channel Search

Long press the [APS] button and automatically search and keep TV station

#### Transit the channels (Page 14)

Under TV mode, press [N/P] button to switch the TV audio style.

#### Direct Channel Selection (Only for remote control)

Enter a channel number by pressing [0] to [9].  
Example: Channel Number 17  
press [1] and [7].

### CD Changer

(Only select sanyo CD Change 10disc or 6disc)

#### CD Change/Video CD Change Mode

Press [MODE] to change to CD/Video CD Change mode and playback starts.

#### Disc Selection

- [▶](CHANNEL):Up
- [◀](CHANNEL):Down

### How to set clock

Press [CLOCK] button can show clock.

Long press [CLOCK] button, when hour hand twinkling, press VOL- or VOL+ to adjust hour. then Press [CLOCK] button, when minute hand twinkling, press VOL- or VOL+ to adjust minute.

## Speaker setting

### Speaker mode

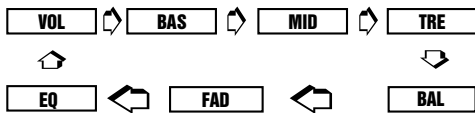

#### • VOL set mode

Press SEL/VOL button once, display will show VOL on, then rotate the button in clockwise direction to increase volume level; rotate the button in anticlockwise direction to decrease volume level.

#### • BAS set mode

Press SEL/VOL button twice, display will show BAS on, then rotate the button to adjust bass level up/down in different direction.

#### • MID set mode

Press SEL/VOL button third, display will show MID on, then rotate the button to adjust MID level up/down in different direction.

#### • TRE set mode

Press SEL/VOL button fourth, display will show TRE on, then rotate the button to adjust treble level up/down in different direction.

#### • BAL set mode

Press SEL/VOL button fifth, display will show BAL on, then rotate the button to adjust BAL level up/down in different direction.

#### • FAD set mode

Press SEL/VOL button sixth, display will show FAD on, then rotate the button to adjust FAD level up/down in different direction.

#### • EQ set mode

Press SEL/VOL button fifth, display will show EQ on, can be select sound effect:

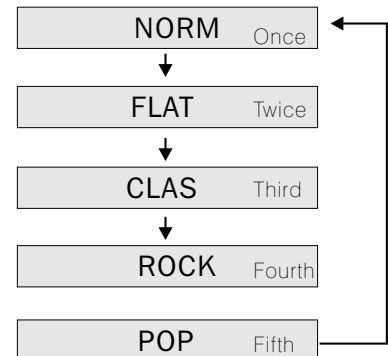

## Radio Operation

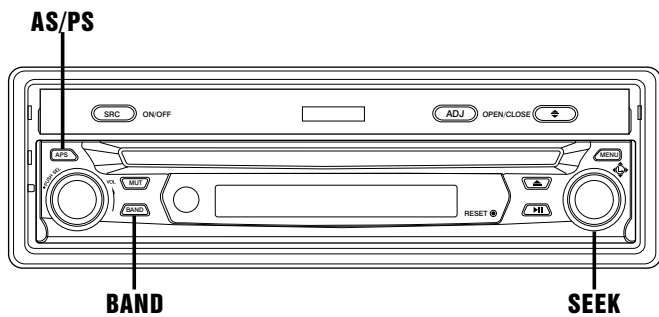

### Tuner

#### In radio mode: manual tuning:

- short press ►► button it can select higher frequency station.  
Short press ◄◄ can select lower frequency station.

#### Auto loading tuning:

- the long press ►► button it can automatically select higher frequency station. And the long press ◄◄ it can automatically select lower frequency station.

### Select station

#### Press [APS]button

- Seek Tune:  
In FM (FM1 FM2 FM3) or AM (AM1 AM2) playing mode, long press "APS" button, it can seek and store strong frequency station automatically in to 1-6 memory buttons.  
FM can memorize 18 stations. AM can memorize 12 stations.

### Band

#### Selecting band

- Press BAND button to select among three FM or two AM bands.  
(FM1-FM2-FM3-AM1-AM2)

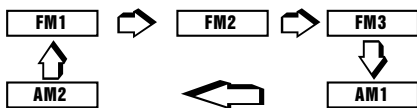

# Remote control

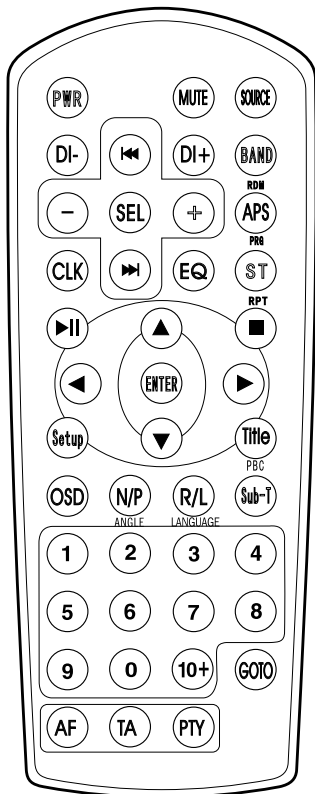

## Loading and replacing the battery

Use one lithium battery(CR2025)  
Insert the batteries with the + and - poles aligned properly.  
Following the illustration inside the case.

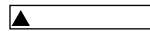
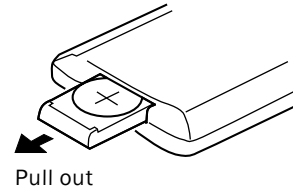

- Store unused batteries out of the reach of children. Contact a doctor immediately if the battery is accidentally swallowed.



Do not set the remote on hot places such as the above dashboard.

## **Basic operation**

---

### **POWER**

---

Press this button to turn on/off the unit.

### **CLK**

---

Press this button can show the time, and long press to enter clock adjustment.

### **SOURCE**

---

Press this button can select needed receiving and playing mode.

### **SEEK +/SEEK-**

---

Press this button can manually search tune, fast, back and track searching control.

### **SEL**

---

Repeatfully press this button can select needed mode.

### **BAND RDM**

---

Under receiving position, press this button can select band; under VCD, DVD position, press this button can play randomly.

### **VOL +/VOL-**

---

Press this button can increase or decrease volume.

### **APS/PRG**

---

Under receiving position, press this button can do seek station; under VCD, CD playing, press this button can play program.

### **▶|| Play/pause**

---

Press this button can switch between play and pause. Under stop state, similarly press it to play.

### **ST/RPT**

---

Under receiving state, press this button can select stereo or single track; under playing state, it can play repeat.

### **N/P(Angle)**

---

#### **N/P**

Under the playing, press [N/P] and can transit among PAL/AUTO/NTSC

#### **Angle**

In DVD mode, Long press can adjust the angle of the video. (The DVD disc record the angle with this function.)

## Basic operation

---

### ◀ ▶ ▲ ▼ [ENTER]

---

Under DVD mode, press this button can move cursor in up,down,left and right directions after entering SETUP Menu.Press ETR button can confirm selected item.



Press this button once to stop play music .

### SETUP

---

Under playing mode, press this button can open SETUP Menu.

### TITLE

---

Under VCD mode,press this button to enter Menu selection same as PBC.

Under DVD mode,press this button to return to the top of Menu.

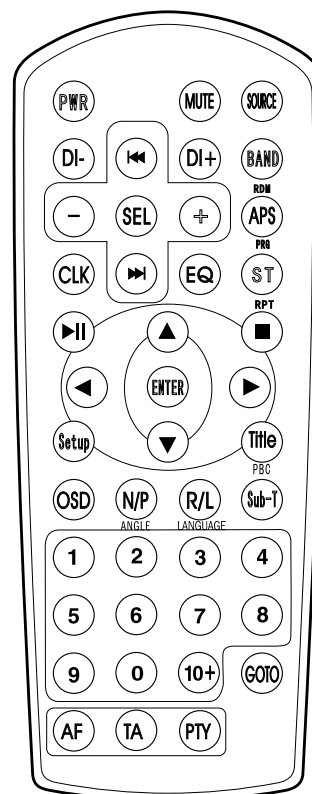

## Basic operation

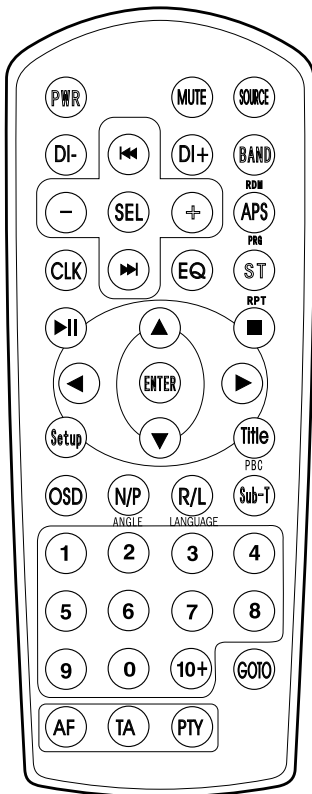

### SUBTITLE

Under DVD mode, press this button can switch dialogue language.

Press this button can directly select track and chapter, and 1-6 buttons can select preset stations.

### R.L/LANGUAGE

Under VCD mode, press this button can switch track.

Under DVD mode, press this button can switch dialogue language.

When playing DVD, long press this button for 3 seconds, sound can be switched between 4.0CH and 5.1CH.

Under TV mode, press this button to switch the TV audio style.

### MUTE

Press this button to turn off volume out, and again to resume.

### OSD

Press this button can show play time, surplus time.

### EQ

Press SEL/VOL button fifth, display will show EQ on, can be select sound effect:

FLAT → CLAS → ROCK → POP  
↑

## Accessories



---

External view  
..... Number of Items



External view  
..... Number of Items



  The use of any accessories except of those provided might result in damage to the unit .Make sure only to use the accessories shipped with the unit ,as shown above.





## ***Trouble shooting guide***

---

What might seem to be a malfunction in your unit may just be the result of slight misoperation or miswiring. Before calling service, first check the following table for possible problems.

---

### ✓ **There is an obstacle**

 Install the unit where the unit moves freely.

---

### ✓ **The display stops on the way to the home position.**

 Press [  ](OPEN/CLOSE)

---

### ✓ **The fuse has blown.**

 Confirm whether the lead short circuit, then replace fuse with same capacity.

---

### ✓ **The cable connect incorrectness.**

 Exactitude connect of the cable.

---

### ✓ **Antenna and Antenna Cable.**

 Check antenna and antenna cable, the antenna base must be grounded and connected with good condition, replace antenna or antenna cable if needed.

### ✓ **Poor ground, dirty or corroded at the car Battery posts**

 Check the black wire for proper grounding clean and tighten ground connection.

---

### ✓ **Speakers or speaker wiring or volume, Balance and Fader setting**

 Check the speaker wiring and test the speakers all in good condition check the setting of volume, Balance and Fader controls.

---

### ✓ **Installation the unit angle is greater than 45°, or mounting is not fixed and the back strap is not secure.**

 Adjust the unit with mounting angle less than 45° and make sure the unit is mounted securely and tighten with the back strap(supplied)

---

### ✓ **Incorrect wire connection, Power RED/YELLOW or Ground wire or Blown fuse**

 Check the Red wire to +12 Volts with key Ignition witch, yellow wire to +12 Volts battery and black wire to ground. Check Fuse with red/yellow wire, or check the fuse block on your car.

# **OWNER'S MANUAL**

---

Before installation and operating the unit please read  
this manual thoroughly and retain  
it for future reference

## Free Manuals Download Website

<http://myh66.com>

<http://usermanuals.us>

<http://www.somanuals.com>

<http://www.4manuals.cc>

<http://www.manual-lib.com>

<http://www.404manual.com>

<http://www.luxmanual.com>

<http://aubethermostatmanual.com>

Golf course search by state

<http://golfingnear.com>

Email search by domain

<http://emailbydomain.com>

Auto manuals search

<http://auto.somanuals.com>

TV manuals search

<http://tv.somanuals.com>