

Tiros	63 TF 51 – 100 MT
Crystal	70 TF 53 – 100 MT

Operating Instructions



Hints for use of the Operating Instructions

Do not be put off by the size of the Operating Instructions. Initially, it is sufficient to read the instructions in Sections 1.1, 2 and 4. In order to familiarise yourself with the TV set and its many functions, we recommend that you read the Operating Instructions step by step, carrying out the described actions on your TV set as you do so.

This method, often called "learning by doing", is the easiest way of learning how to execute the various functions.

Do not be afraid to change the settings in the various menus (the TV menu, the TV station table, programming of the function keys, etc.). If you make any changes to these settings, the TV set reacts immediately, but the changes are not yet stored. After each change in a menu, a red box is displayed at the bottom right of the screen, asking if you want to save the changes.

- If you want to save the changes, press the **OK** key to do so.
- If you are not sure, or if you do not want to save a changed setting, press the **MENU** key and then the **TV** key to exit from the menu without saving the new settings.

We have made every effort to provide a detailed table of contents and a comprehensive index to help you to find the information you need. The Section "Glossary" contains explanations of various technical terms used in the manual.

In the descriptions of the various functions, the left-hand column shows which keys you must press in order to see the screen display given in the centre column. Do not press the keys too quickly. It may occur that the TV set will not recognise the next key you press and may therefore not display the menu shown in the centre column but something completely different. The right-hand column of the function description provides additional information which may be useful but is not absolutely necessary for execution of the function.

If you comply with these hints, you should have no problems in the operation of your TV set.

Your Metz-Werke

Contents

Remote control handset RB 11	3	8.2 Recording with the timer	28
1. Setting up and connecting	4	9. Connecting headphones	29
1.1 Turning the TV on and off	5	Adjusting the headphones volume	29
2. Language selection in the TV menu	6	10. Megatext	30
2.1 TV menu and operator help	6	Basic functions	30
2.2 Programme selection	6, 7	Multiple pages	32
3. Presetting TV stations	8	Direct page selection	33
Direct channel entry/station search	8	Return to last index page	34
Autostore function	9	Doubling the font size	35
3.1 Sorting stations	10	Setting marks	36
Move, exchange, copy, delete	10	Mark-by-mark advance	38
3.2 Fine tuning	11	Erasing marks	39
3.3 Allocating a station logo	12	Subtitles	40
4. Changing individual picture settings	13	Riddle solutions key	40
4.1 Changing individual sound settings	13	11. Special picture effects	41
4.2 Adjusting the video and audio standard values	14	Variable Zoom	41
5. Equipment configuration	15	Frame freeze	42
Assigning the function keys	15	12. Operation without remote control	42
Setting for programme change	17	13. Connecting peripheral equipment	43
Setting the RGB priority	18	Connecting a video recorder / camcorder	43
Volume adaptation	18	Connecting external devices	44
6. Volume adjustment and forced mono	19	Connecting a video recorder	45
6.1 Correcting picture deviations	20	Video recorders/video signal	46
Noise reduction and CTI function	20	Video recorders	47
Picture format	21	Pay TV decoder (e.g. Premiere)	48
7. AV recording	22	14. Technical data	50
Camcorder → video recorder	22	14.1 Upgrade kits	50
Video recorder → video recorder	23	14.2 Maintenance and care	50
8. Time settings	24	15. Glossary	51
Switch-on/off and reminder time	24	16. Remote control handset for video recorders	52
8.1 Childlock	26	17. Index	53
Switching on	26		
Permitted programmes	26		
Personal code	27		
Beginning and end of viewing period	27		
Switching off	27		

Remote control handset RB 11

The remote control sends commands to the TV set with the aid of infrared light. For this reason, you should always point the remote control at the TV set for reliable operation. Use of the remote control may interfere with the operation of other devices or systems controlled which use infrared light (such as infrared headphones).

If the TV set is exposed to direct sunlight, it may sometimes not function correctly because it cannot recognise the commands transmitted by remote control.

The television must be switched on or in standby mode (ON/OFF key depressed) when it is to be operated by remote control. Always point the remote control in the direction of the TV for operation. A **pilot lamp** starts to flash as soon as a key on the remote control handset is pressed.

Nota:

For explanation of the video level for the remote control of video recorders, please refer to Section 16, page 52.



Do not point the remote control unit into your eyes and press a key on it !

Do not use rechargeable batteries in the remote control unit.

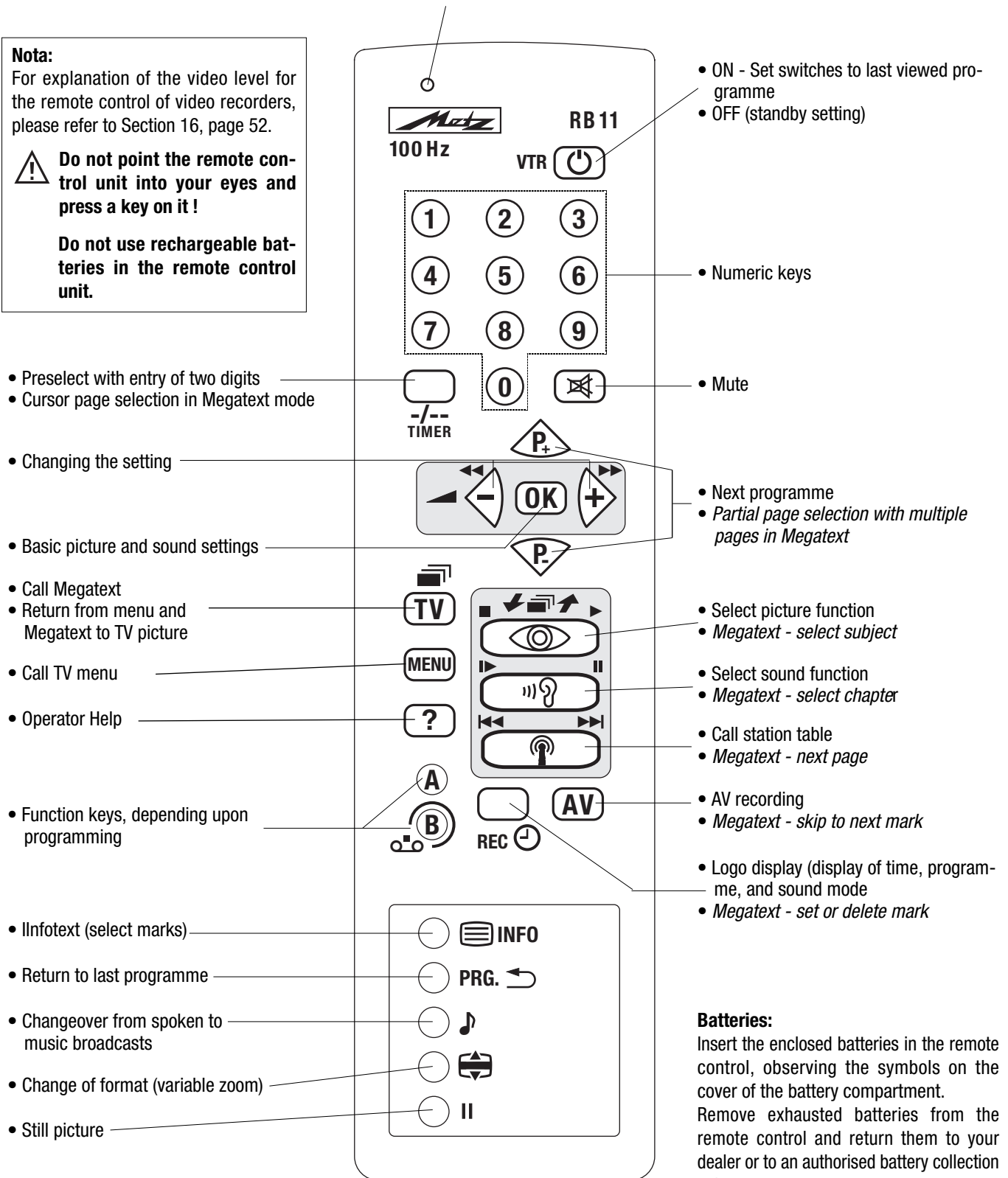

Batteries:

Insert the enclosed batteries in the remote control, observing the symbols on the cover of the battery compartment. Remove exhausted batteries from the remote control and return them to your dealer or to an authorised battery collection point.

1. Setting up and connecting

Setting up

When selecting a suitable place for the TV, be sure that no bright light or sunlight falls on the screen. Light may cause reflections and impair the brilliance of the image.

The best viewing distance is five times the picture tube diagonal, e.g. about 3.5 m for TV sets with a 70 cm screen.

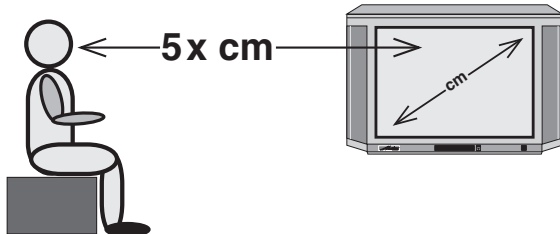

! TV sets require adequate ventilation. The ventilation slots at the rear of the set should therefore never be covered by curtains, doilies, newspapers or similar objects. Likewise, all slots at the bottom of the set must be freely accessible so that the intake of air is not impaired in any way

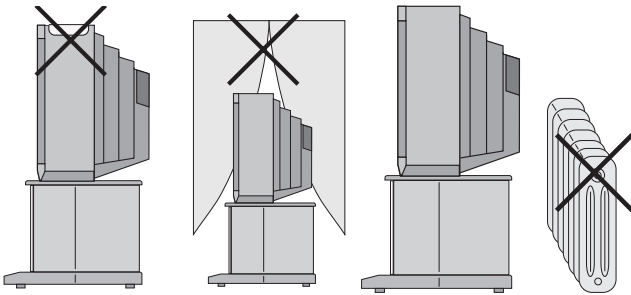

! Do not set up the TV near a radiator as this would impair adequate cooling.

! Do not place

- burning candles or
- flower vases filled with water

on top of the TV set.
Hot wax and liquids destroy the electrical components and jeopardize the electrical safety of the set

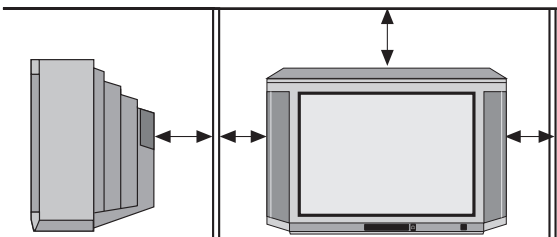

! If you place the set in a wall unit, leave sufficient space on all sides so that the air can circulate freely.

! Your TV set is intended for use in dry rooms. If you wish to use it occasionally outdoors, be sure to protect it against any kind of moisture (rain, splashes, dew, etc.).

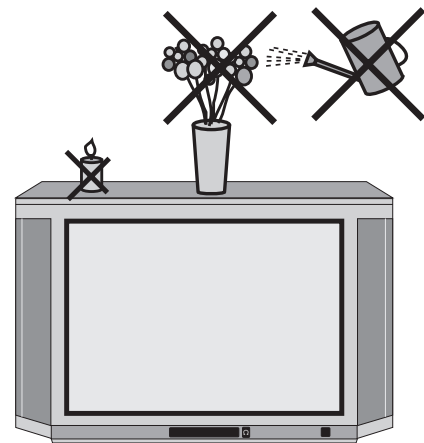

Connecting the aerial

Standard SAT and terrestrial station aerial sockets are fitted at the rear of the TV.

Thunderstorms represent a danger for all electrical appliances! If lightning strikes the power line or the aerial, the TV may be damaged even if it is switched off. Therefore, always unplug the mains lead AND aerial during thunderstorms. If the TV is not going to be used for an extended period of time, for instance when on holiday, then disconnect the set both from the mains and the aerial.

Aerial connection

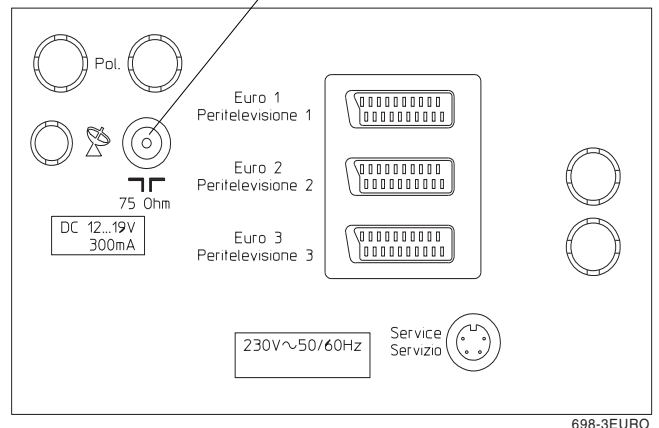

Mains voltage

Plug the mains lead into a wall outlet. The TV set is equipped for 230 V ac (Australia 240 V ac).

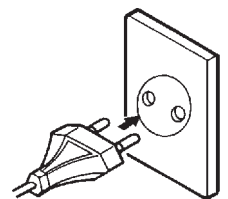

1.1 Turning the TV on and off

Turning on with the ON/OFF key

! Before turning on a cold TV in a warm room, first allow any condensation mist that may have formed on the screen to evaporate.

Press the ON/OFF key.

Programme position 1 is then selected. Depending on the assignments made, the following information will appear in the screen box:

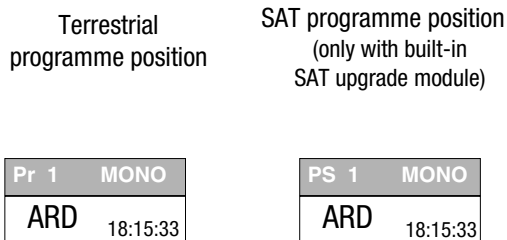

Turning off with the ON/OFF key

Press the ON/OFF key. The television is now disconnected from the mains.

You are advised to turn off the TV with the ON/OFF key after station closedown and when it is not going to be used for an extended period of time.

Turning on with the remote control

The programmes can be directly selected with the 0-9 keys when the television is in standby mode.

Select single-digit programme numbers by pressing the corresponding numeric key.

Two-digit programme numbers are entered with the preselect key:

- The television is switched to the last watched programme.
- The preselect box is displayed on the screen.

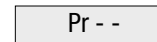

- The 2-digit programme number can now be entered with the numeric keys.

The last programme watched before the television was switched off can be set with the key.

The television is automatically set to standby mode ten minutes after station closedown. However, this is not the case if the station starts to transmit a test card within these ten minutes.

Turning off with the remote control

Press the key to switch the TV to standby mode.

The standby status is indicated by the red lamp.

2. Language selection in the TV menu

Press this key on the remote control....	The screen displays	Explanation
<p>1. Call the Equipm. Configuration menu</p> <p>MENU → red → green</p>	<p>MENU return TV TV picture ? Help</p>	<p>The desired language for the entire TV menu is adjusted in the „Equipm.Configuration“ menu.</p>
<p>2. Adjust the language</p> <p>← →</p>	<p>Equipm. configuration</p> <p>blue Function keys</p> <p>yellow Device connection</p> <p>white SAT settings</p> <p>green Language: English</p> <p>red further</p>	<p>Select the desired language with the keys when the submenu for the language is displayed on a green background.</p>
<p>3. Store the selected language</p> <p>OK</p>	<p>store? OK</p>	<p>Press the key to confirm and store the selection made. The complete text in the TV menu is then displayed in the selected language.</p>
<p>4. Return to TV picture</p> <p>TV</p>	<p>TV picture</p>	

2.1 TV menu and operator help

Menu control of the TV, and the versatility of the system, ensure that supposed complicated settings and entries are made easily and clearly comprehensible for everyone. Operator Help can be called with the (?) key when in TV mode. Operator Help indicates the functions of the individual keys.

All settings are entered by way of different submenus. Simply call Operator Help with the (?) key should you encounter difficulties in entering the different equipment configurations or if problems arise in operating the TV. Operator Help is specifically matched to the corresponding menu and functions as a reminder when settings are entered or programmed.

Press this key on the remote control....	The screen displays	Explanation
--	---------------------	-------------

Operator Help: Call/exit

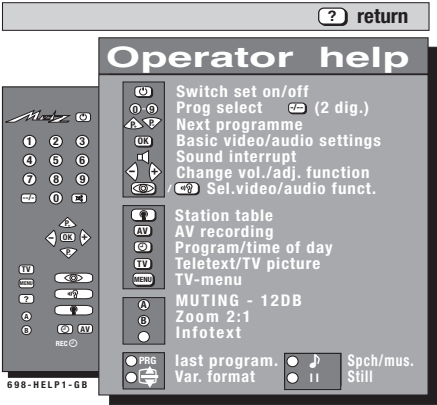

Operator Help shows the functions of the individual keys when in TV mode.

The **A** and **B** function keys can be programmed by the user. Consequently their functions can differ to those shown in the adjoining picture.

TV menu: Call/exit

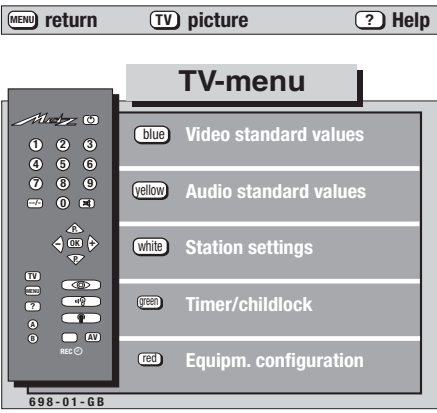

The individual menu lines are selected with the coloured keys of the remote control, to open the corresponding submenu. Keys not enhanced in white or colour on the displayed menu have no function in the current operating state.

Settings in the submenus can be changed with the keys.

Press the key to confirm and store the new setting.

Press the key to move back by one step within the TV menu.

Operator Help in TV menu: Call/exit

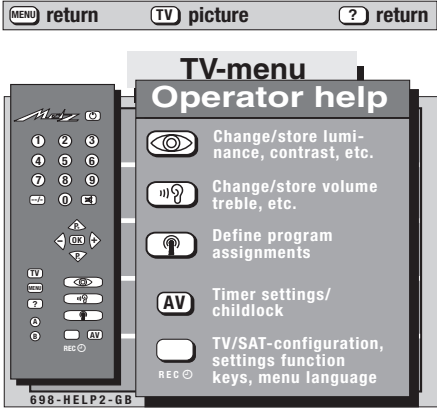

Operator Help can be called for each menu displayed on the screen (Example: Operator Help with displayed TV menu).

2.2 Programme selection

Press this key on the remote control....

The screen displays

Explanation

1. Select the programme position (e.g. Prog number 10)

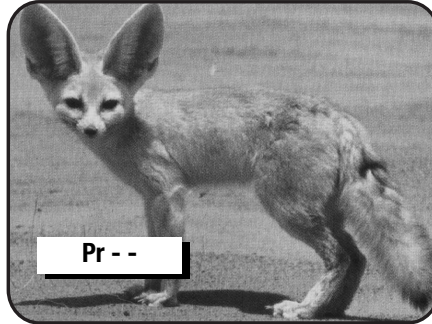
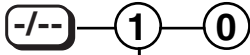

Press the key when the TV is in standby mode. The TV then switches to the programme viewed before the receiver was turned off to standby.

Now enter the programme number with the numeric keys. The TV is changed over to the selected programme position as soon as the last digit has been entered.

With single-digit programme numbers it is only necessary to press the corresponding key, e.g. key 4 for programme position 4.

After the programme position has been selected an information box appears indicating the programme position number, the time, and the currently valid sound mode, e.g. stereo.

2. Next programme



Press the keys to run through the programmes. Keeping the or key depressed for more than 2 seconds will cause a programme box to be displayed on the screen for selection of the programme position. Release the or key as soon as the desired logo is highlighted in white. The corresponding programme position will then be selected.

3. Last programme



With this key, you can switch back and forth between the last two programme positions you selected.

Example:

*You are watching a programme on ITN; during the commercials, you switch to BBC with the aid of the numeric keys **0** . **9***

*You can now switch back and forth between ITN and BBC by pressing the **PRG.** key.*







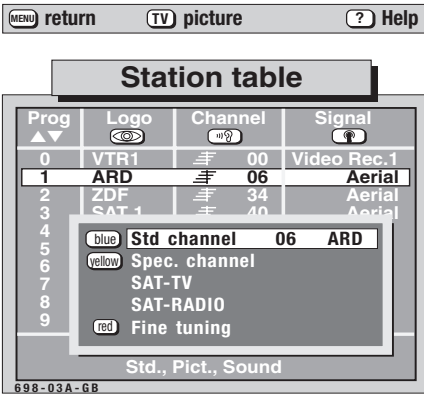

3. Presetting TV stations

Direct channel entry/ station search

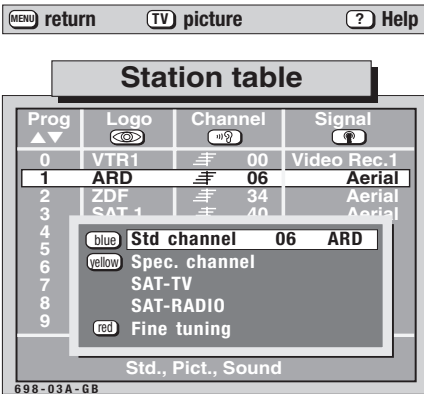
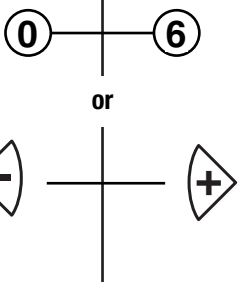
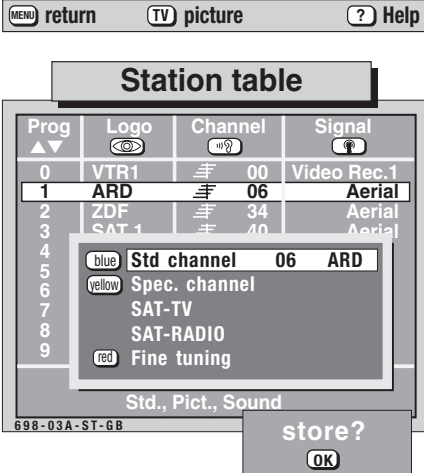
The TV is supplied with factory preprogrammed TV stations. However, if you can receive TV stations in your area that are not listed in the station table, then these transmitters can be entered and programmed at any time.

You can choose one of the following three programming possibilities:

- a) Direct channel entry
- b) Station search
- c) Autostore function





Press this key on the remote control....	The screen displays	Explanation
<p>1. Call the station table and channel type survey</p> 		<p>With direct channel entry it is necessary to know the type of channel and the channel number.</p> <p>If type and number of channel are not known, you can scan through the entire reception range with the search function to locate stations.</p> <p>The station table lists all the preset stations.</p> <p>These stations can be changed at any time.</p> <p>The cursor always highlights the type of channel currently preset in the given programme position.</p> <p>For the search function it is advisable to switch to a vacant programme position.</p>
<p>2. Select the type of channel (e.g. standard channel)</p> 		<p>The yellow framed field offers four types of channels. Select the channel type with the assigned coloured key.</p> <p>After the channel type has been selected, a channel number is displayed in the bar when a station is stored in this programme position. Two lines are shown if this position is still vacant.</p> <p>„SAT channel“ and „SAT radio channel“ can only be selected if a SAT upgrade module has been installed in the TV receiver.</p>
<p>3. Enter the channel number (Example: Standard channel 06) or start station search</p> 		<p>With direct channel entry, the station table is briefly faded out when the channel number is entered, and the selected station is displayed.</p> <p>The station search proceeds from the displayed channel number in a forward sequence with the  key, and in a reverse sequence with the  key. Search proceeds from the lower channel area upwards or downwards when two lines are displayed. The search stops when a station has been found.</p> <p>Proceed as described in step 4 if the located station is to be stored.</p> <p>Press the  or  key if the located station is not to be stored so that the search can be continued.</p> <p>Complete fine tuning if station reception is not clear (see Section 3.2).</p>
<p>4. Store the setting and return to TV picture</p> 	<p style="text-align: center;">TV picture</p>	

3. Presetting TV stations

Autostore function,
sorted to countries

The autostore function automatically scans through the entire reception range to locate stations. The located stations are presented in the station table and can then be stored by way of the **OK** key.

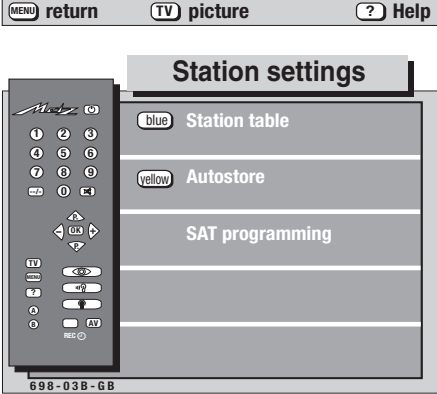
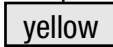
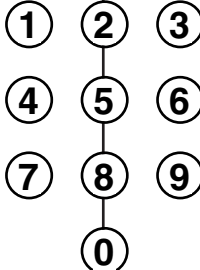
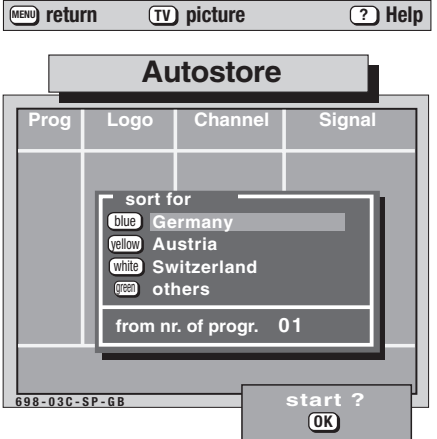
If you do not like the order in which the stations appear in the station table, you can sort the stations to match your own requirements as described on the next page.

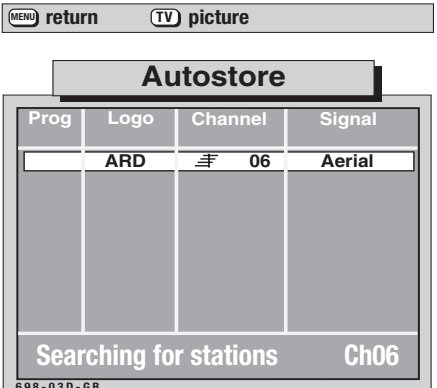
Press this key on the remote control....	The screen displays	Explanation
<p>1. Call the menu „Station settings“</p>  	 <p>The screen displays the 'Station settings' menu with options: blue Station table, yellow Autostore, and SAT programming.</p>	
<p>2. Call the autostore function and enter a programme number (e.g. 01)</p>  	 <p>The screen displays the 'Autostore' menu with a 'sort for' overlay showing options: blue Germany, yellow Austria, white Switzerland, and others. Below the overlay, it says 'from nr. of progr. 01' and 'start ?' with an OK key.</p>	<p>Press the yellow key to call the autostore function. Use the numeric keys to enter the two-digit programme number (e.g. 01) at which the station is to be stored.</p> <p>After entry of this number, a red box with the text „Start ?“ is displayed.</p>
<p>3. Start the autostore function</p> 	 <p>The screen displays the 'Autostore' menu with a table showing a found station: ARD on channel 06 with an Aerial logo. At the bottom, it says 'Searching for stations' and 'Ch06'.</p>	<p>The TV now scans through the entire reception range.</p> <p>The first „standard-channel“ station to be found is shown on the screen after all stations have been located. The channel number and an automatic logo are displayed. The auto logo only appears for stations which transmit a VPS signal.</p> <p>Now proceed as described in Section 3.1 Sorting stations.</p>

3.1 Sorting stations

In the „Sort“ submenu you can move, exchange, copy, or delete the stations stored in the programme positions. The „Sort“ submenu is displayed automatically after the autostore function has found all available stations.

This menu can also be called at any time from the station table display for subsequent modification of the station programming.

Press this key on the remote control....

The screen displays

Explanation

1. Call the „Sort“ submenu and move the station

either automatically after autostore
or



2. Exchanging two programme positions

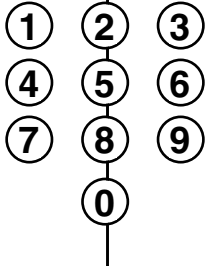

3. Store the settings



4. Return to TV picture



[MENU] return [TV] picture [?] Help

Station table

Prog	Logo	Channel	Signal
0	VTR2	02	Video Rec.2
1	ARD	06	Aerial
2	ZDF	34	Aerial
3	SAT 1	40	Aerial
4	RTL	36	Aerial
5	BR 3	59	Aerial
6	N 3	S23	Aerial
7	MDR 3	12	Aerial
8	SWF 3	45	Aerial
9	MDR 3	S05	Aerial

sort
 blue move
 yellow change
 white copy Pr 1 → Pr --
 green Pr 1 delete

When the „Sort“ submenu is displayed, the function „Move“ is preset.

Use the and keys to select the programme position to be modified.

Select one of the functions „move“, „exchange“, „copy“ or „delete“ with the related coloured key.

*If you inadvertently delete a programme position, you can restore it by pressing the **B** key.*

[MENU] return [TV] picture [?] Help

Station table

Prog	Logo	Channel	Signal
0	VTR2	02	Video Rec.2
1	ARD	06	Aerial
2	ZDF	34	Aerial
3	SAT 1	40	Aerial
4	RTL	36	Aerial
5	BR 3	59	Aerial
6	N 3	S23	Aerial
7	MDR 3	12	Aerial
8	SWF 3	45	Aerial
9	MDR 3	S05	Aerial

sort
 blue move Pr1 → Pr --
 yellow exchange Pr1 → Pr --
 white copy Pr 1 → Pr --
 green Pr 1 delete

When moving, exchanging or copying a programme position, the new programme position must be selected by entering **two digits** on the numeric keys.

The blinking hyphen on the right of the sub-menu now prompts you for input of a programme position number.

The selected function is executed as soon as you enter the new number.

[MENU] return [TV] picture [?] Help

Station table

Prog	Logo	Channel	Signal
0	VTR2	02	Video Rec.2
1	ARD	06	Aerial
2	ZDF	34	Aerial
3	SAT 1	40	Aerial
4	RTL	36	Aerial
5	BR 3	59	Aerial
6	N 3	S23	Aerial
7	MDR 3	12	Aerial
8	SWF 3	45	Aerial
9	MDR 3	S05	Aerial

sort
 blue move Pr1 → Pr --
 yellow exchange Pr1 → Pr --
 white copy Pr 1 → Pr --
 green Pr 1 delete

store?
 OK

After the contents of a programme position have been moved, exchanged, copied or deleted, a red store box is displayed to ask if you want to store the new settings.







Press the key to store the new settings or press the key to abort the operation.

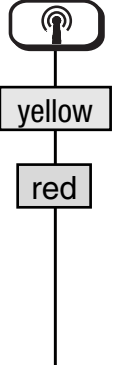
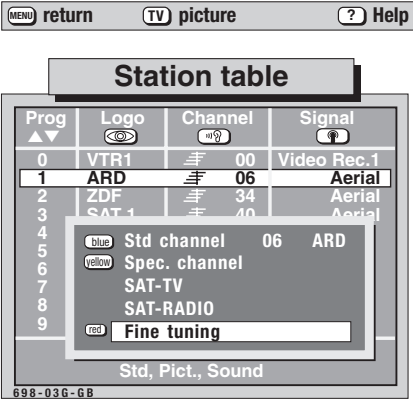
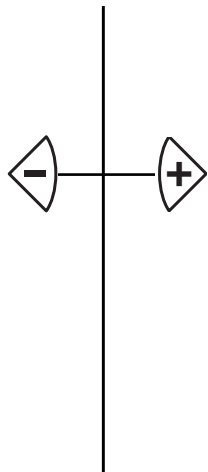

3.2 Fine tuning

The individual channels are automatically tuned to channel centre for station tuning. As a rule, this automatic tuning will be sufficient. Apply manual fine tuning if automatic tuning does not produce satisfactory results.

Select the programme number at which fine tuning is to be completed.

Press this key on the remote control....	The screen displays	Explanation
<p>1. Select the fine tuning function</p> 		<p>The „Fine tuning“ function is only activated when the red bar is displayed.</p>
<p>2. Adjust the fine tuning</p> 		<p>Adjust fine tuning within the range of -99 to +99 with the   keys.</p> <p>The station table is blanked out for better picture assessment.</p>
<p>3. Store the fine tuning and return to TV picture</p> 		<p>Once the station is correctly tuned, press the  key to store the new setting.</p>

3.3 Allocating a station logo

A logical logo consisting of up to 5 characters can be allocated to each station. The station RTL 2, for example, can be allocated the logo RTL 2.

Manual logo allocation is not necessary with most stations. The corresponding station logo appears a few seconds after the picture when a station is selected by direct channel entry. However, an automatic logo only appears for stations which transmit a VPS signal.

Press this key on the remote control....

The screen displays

Explanation

1. Call the logo menu

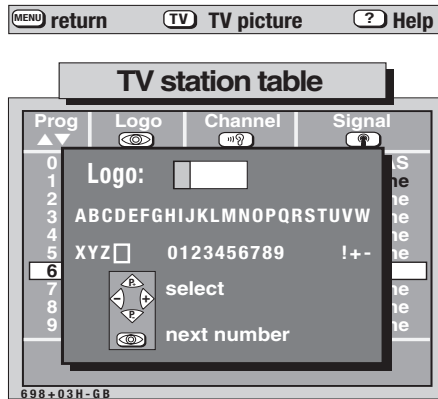
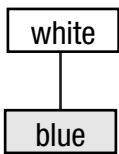

The logo is automatically displayed if the selected programme position already has a logo. The field remains blank if a logo has not yet been allocated.

Any existing logo will be overwritten.

2. Select the first character

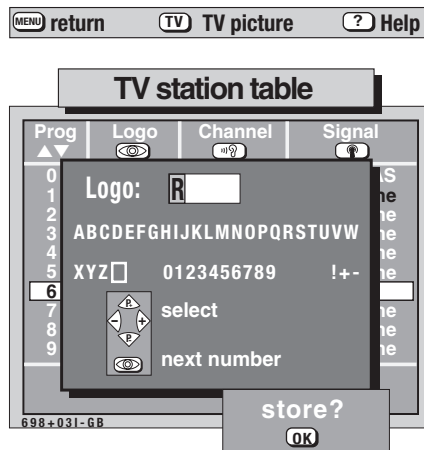
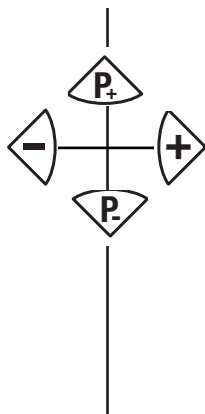

Select the desired character (in our example the letter R) with the keys \leftarrow , \rightarrow , \uparrow , \downarrow .

This will overwrite any existing logo.

3. Move the cursor to the second position and select the second character

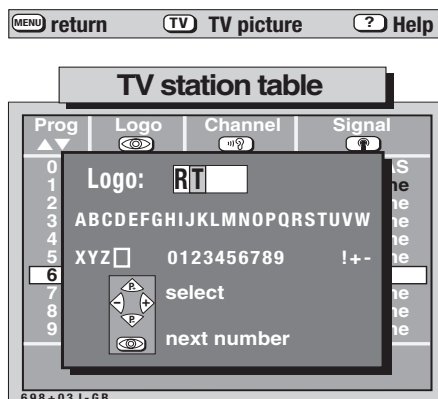
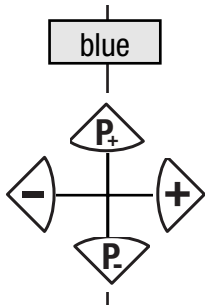

The cursor is moved within the logo field with the blue key.

Select the desired character (in our example the letter T) with the keys \leftarrow , \rightarrow , \uparrow , \downarrow .

Repeat this procedure to enter the entire logo.

4. Store the setting and return to TV picture

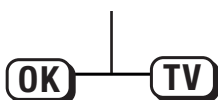









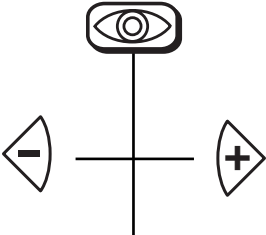



TV picture



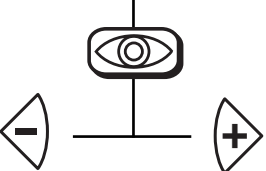







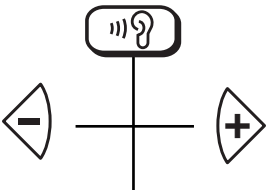

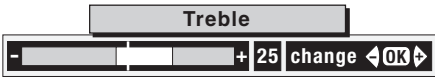



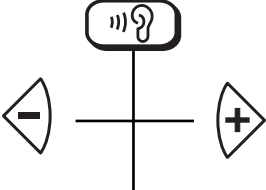

After input of the desired logo, press the **OK** key to store it.

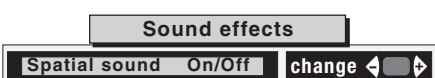
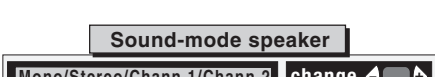

The programmed logo automatically appears in the station table.

4. Changing individual picture settings

Press this key on the remote control....	The screen displays	Explanation
<p>1. Adjusting the luminance</p> 	    <p style="text-align: right; font-size: small;">694-00E-GB</p>	<p>Press the  key to display the last adjusted function.</p> <p>Continue pressing the  key until the picture setting value to be changed is displayed.</p> <p>Adjust the required value with the   keys.</p>
<p>2. Adjusting the contrast</p> 	<p>Press the  key a number of times until the contrast field is displayed on the screen.</p> <p>Adjust the required value with the   keys.</p> <p>Chrominance and sharpness are adjusted in the same manner.</p>	

4.1 Changing individual sound settings

Press this key on the remote control....	The screen displays	Explanation
<p>1. Adjusting the volume</p> 	  	<p>Press the  key to display the last adjusted function.</p> <p>Continue pressing the  key until the volume field is displayed on the screen.</p> <p>Adjust the required value with the   keys.</p>
<p>2. Adjusting the treble setting</p> 	   <p style="text-align: right; font-size: small;">695-D-GB</p>	<p>Press the  key a number of times until the treble field is displayed on the screen.</p> <p>Adjust the required value with the   keys.</p> <p>Bass, balance, sound effects and speaker sound-mode settings are adjusted in the same manner.</p>
<p>3. Sound mute</p> 	 <p style="text-align: right; font-size: small;">695-DX-GB</p>	<p>Press the  key to mute the sound.</p> <p>Renewed depression of the  key resets the sound to the previously adjusted volume.</p>

Note: All settings modified in this menu can be stored by calling the „Video standard values“ or „Audio standard values“ menu respectively and pressing the  key. The stored values can be recalled at any time with the  key.

4.2 Adjusting the video and audio standard values

Press this key on the remote control....

The screen displays

Explanation

1. Call the TV menu

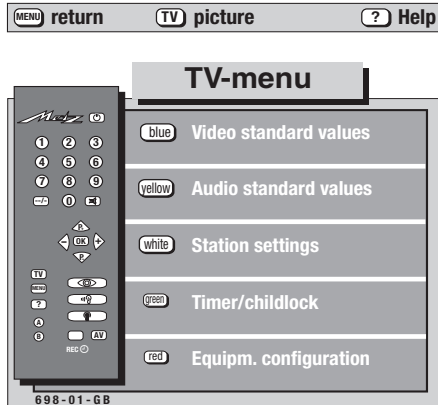

Press any coloured key to step through the submenus. Pressing the blue key selects the „Video standard values“ submenu, pressing the yellow key selects the „Audio standard values“ submenu

2. Example 1: Call the „Video standard values“ submenu. Adjust and store the luminance.

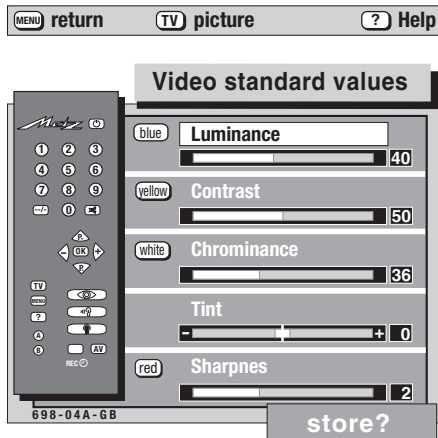
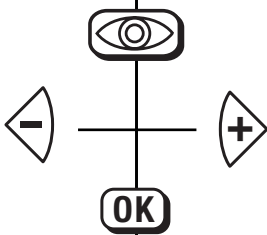

Luminance, contrast, chrominance and tint* can be adjusted in the „Video standard values“ submenu. Select the menu line with the value to be changed by pressing the assigned colour keys.

* (only if a multi-standard upgrademodule has been installed)

The volume, treble, bass and balance settings, as well as the headphones volume, can be adjusted in a similar manner in the „Audio standard values“ submenu. Adjust the desired value with the \leftarrow \rightarrow keys.

3. Example 2: Call the „Audio standard values“ submenu. Adjust and store the volume.

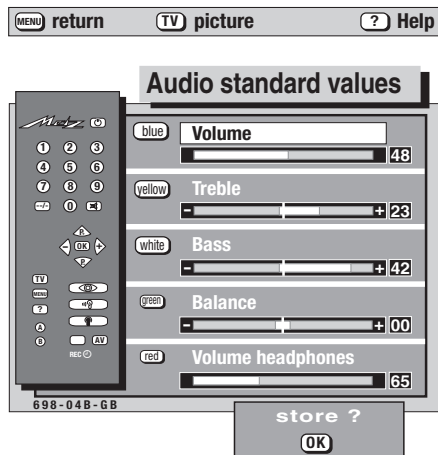
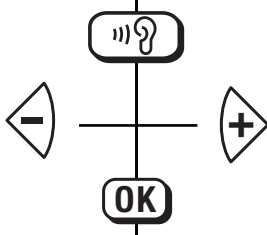

If no other video standard values or audio standard values are to be changed, then press the OK key to store the new setting.

The red store box disappears when the OK key is pressed.

4. Return to TV picture









5. Equipment configuration

Assigning the function keys

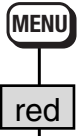
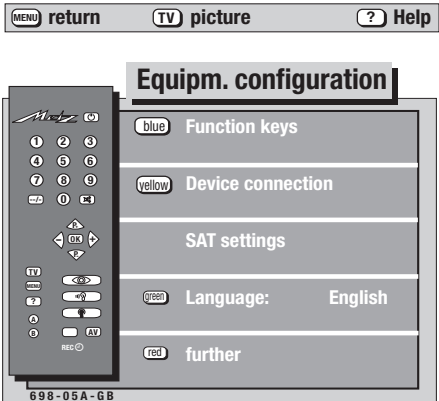
The remote control handset has two factory programmed function keys A and B. Press the  key in normal television mode to reveal the factory programming. The displayed Operator Help text describes the current programming in the last-but-one paragraph. This programming can be changed according to your requirements in conformity with the displayed selection. This choice is described in the „Glossary“ chapter.

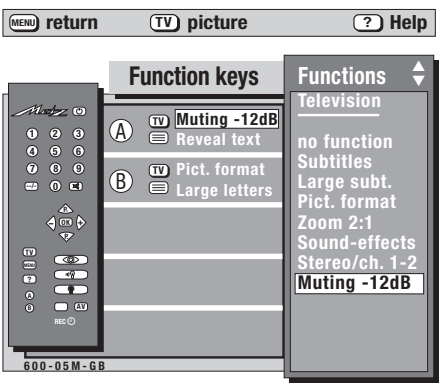
Example of programming function key B:

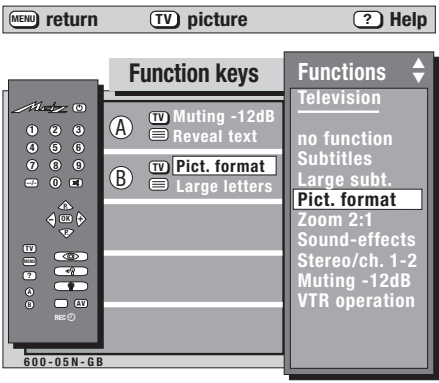
In TV mode, the **B** key is to activate the „subtitles“ function; in Megatext mode, you can use it for the „page stop“ function.

Press this key on the remote control....	The screen displays	Explanation
<p>1. Call the „Equipment configuration“ menu</p> 		
<p>2. Call the „Function keys“ menu</p> 		<p>The left-hand side of this menu shows the currently valid programming of the function keys.</p> <p>The window on the right-hand side indicates the selection that can be programmed.</p> <p><i>The individual functions are explained in detail in the „Glossary“ on page 52.</i></p>
<p>3. Press the function key to be programmed (in this example: B key)</p> 		<p>Two functions can be programmed for function key B. The upper line indicates the function programmed for TV mode, the lower line the function programmed for Megatext mode.</p> <p>Press the  key to switch between the two lines. Press the B key to display the currently programmed function.</p>

5. Equipment configuration

Assigning the function keys

Press this key on the remote control....

The screen displays

Explanation

4. Select the function for TV mode (in this example „Subtitles“)

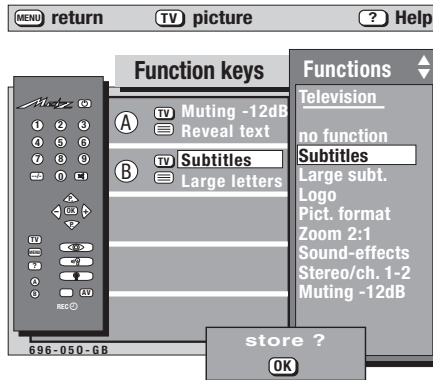
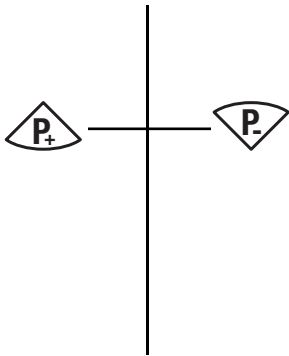

Select the function in the right-hand field with the \triangle or ∇ key. The text on the left-hand side changes as soon as the cursor (a white bar) is moved.

If the function „Subtitles“ has been programmed for key B, the subtitles will be displayed when the TV set is switched, if subtitles are actually transmitted with the programme.

5. Switch to Megatext mode and program the function keys

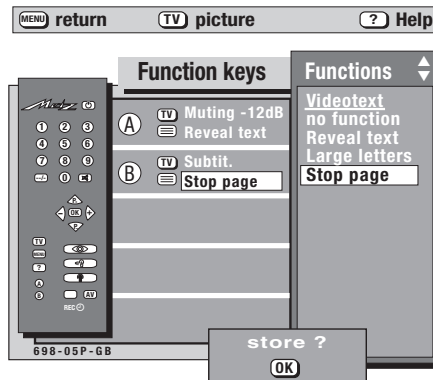
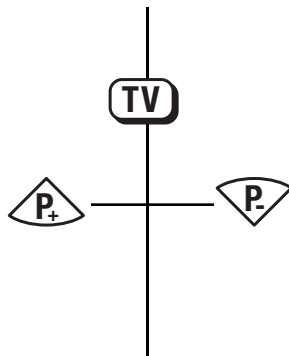

The cursor (a white bar) is now located in the second line, on the currently programmed function.

The desired Megatext functions can now be programmed in the sequence described in steps 3 and 4, above.

6. Store the assignments and return to the „Equipment Configuration“ menu

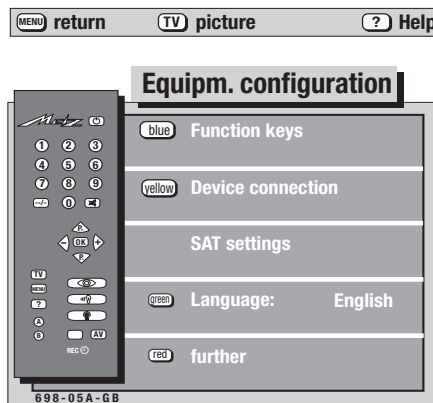

7. Return to TV picture



5. Equipment configuration

Settings for programme change

Press this key on the remote control....

The screen displays

Explanation

1. Call the settings for programme change

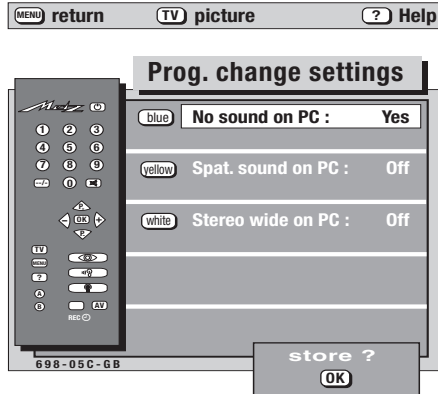
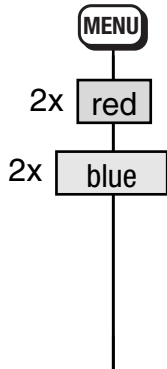

In this menu you can define the sound functions for a programme change.

In the first line of the menu, use the \leftarrow \rightarrow keys to select whether the mute function is to be retained („Yes“) or to be cancelled („No“) when you change programmes.

The new settings can be stored by pressing the **OK** key.

2. Set spatial sound when changing programmes

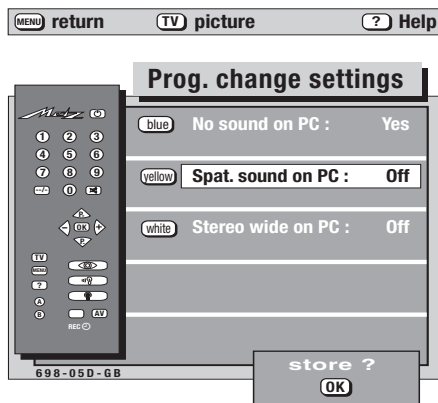
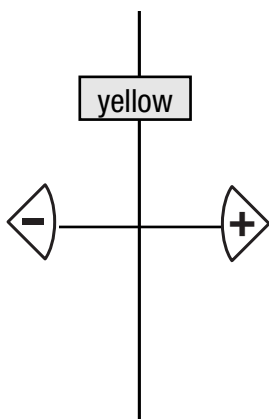

Use the \leftarrow \rightarrow keys in this menu line to define whether the spatial sound is to be switched on or off when the programme is changed to a monaural station.

When in mono mode, you can change over to spatial sound by pressing a self-defined function key (sound effects).

If no other values are to be changed, then press the **OK** key to store the new setting.

The term „spatial sound“ is explained in the section „Glossary“ on page 52.

3. Select stereo wide when changing program

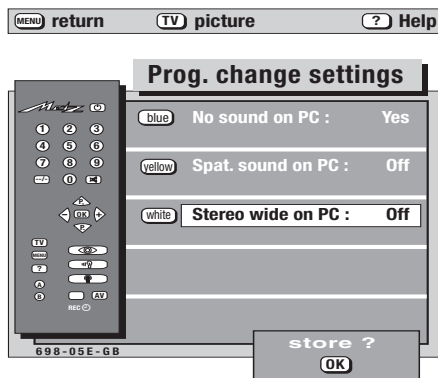
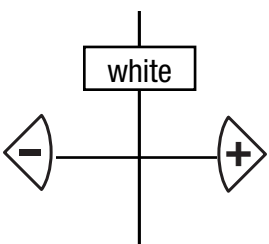

Use the \leftarrow \rightarrow keys in this menu line to select whether stereo wide is to be switched on or off when the programme is changed to a stereo station.

When in stereo mode you can change over to stereo wide by pressing a self-defined function key (sound effects).

If no other values are to be changed, then press the **OK** key to store the new setting.

The term „stereo wide“ is explained in the Section „Glossary“ on page 52.

4. Store the settings and return to TV picture

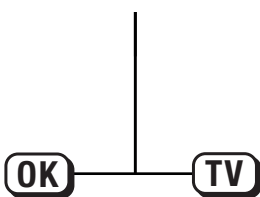

5. Equipment configuration

RGB priority
Volume adaptation

Press this key on the remote control....	The screen displays	Explanation
--	---------------------	-------------

1. Call the „Equipment configuration“ menu

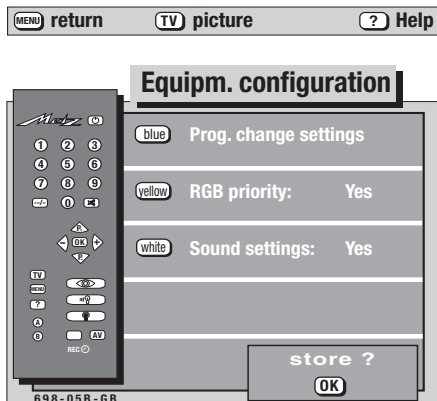
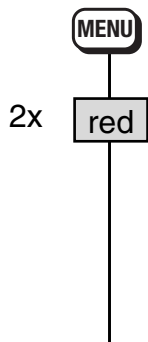

2. Set the RGB priority

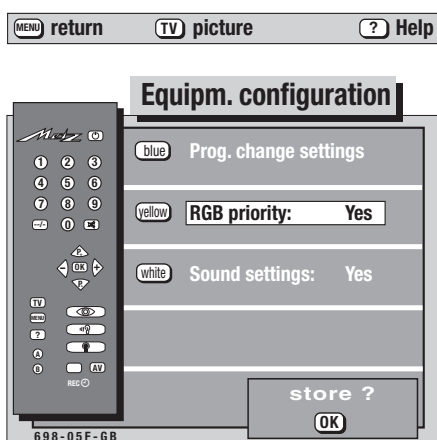
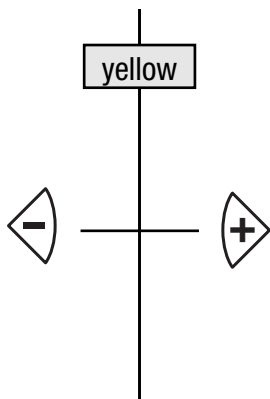

The RGB priority must be set to **Yes** if a Pay-TV decoder (Premiere) is to be connected to the TV.

Select the setting **Yes** or **No** with the \leftarrow \rightarrow keys.

Store the new settings with the **OK** key

3. Activate and deactivate the volume adaptation

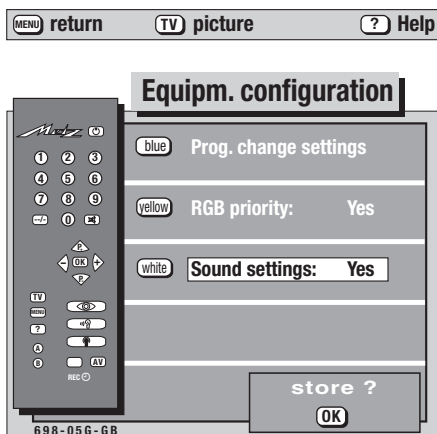
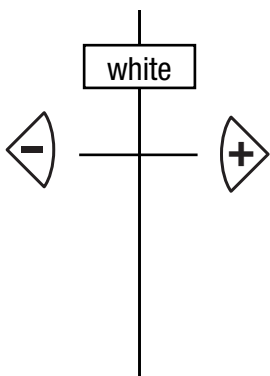

Some stations transmit commercials at a higher volume than the normal programme. You can activate an automatic volume adaptation function so that you do not have to adjust the volume with the remote control each time.

When this function is active, differences in the volume are automatically equalised.

The setting you select here applies to all programme positions.

4. Store the settings and return to TV picture



6. Volume adjustment and forced mono

It is possible for TV stations to be received at different volume levels although the volume level settings on the individual programme positions are identical. To overcome this problem, you can set a volume correction factor for each programme position.

Example:

Programme 1 is soft: volume value 40. Programme 3 is loud: volume value 40. Programme 1 is to be adjusted to the same volume as Programme 3. **Switch over to programme position 1.**

Press this key on the remote control....

The screen displays

Explanation

1. Call the sound submenu and adjust the volume

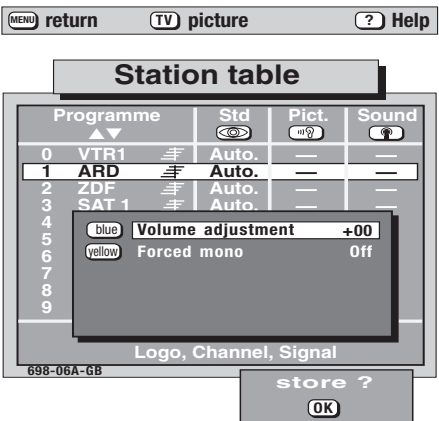
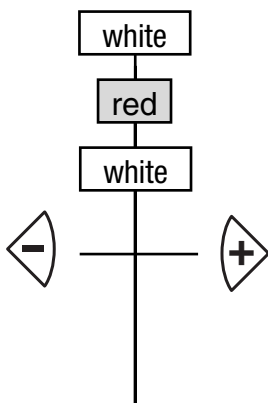

In this submenu, you can assign a volume correction factor to a programme position and, if necessary, activate forced mono sound mode.

A volume correction factor can be set with the <+> keys when the text is displayed on a blue background.

Press the <+> key to enter a positive correction factor which is added to the standard volume value (increasing the volume). Press the <-> key to enter a negative correction factor which is subtracted from the standard volume value (decreasing the volume).

In our example:

Press the <+> key and increase the volume until it is the same as the volume on Programme 3. The resulting correction factor could, for example, be displayed as 05.

2. Set forced mono

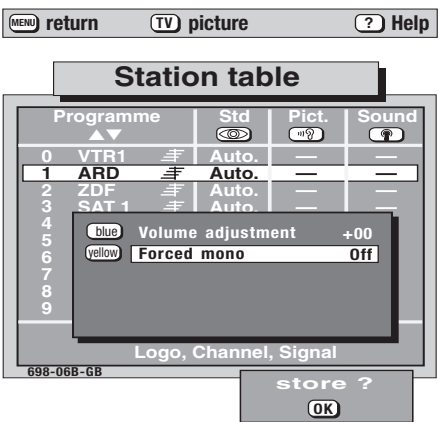
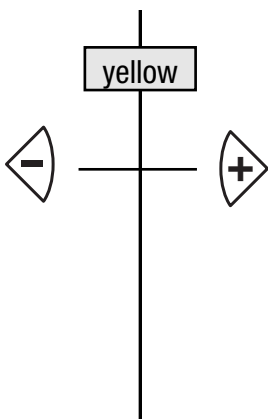

It may happen that the TV set inadvertently switches from mono to stereo during a transmission, although no stereo programme is being received. This usually depends upon the prevailing reception conditions.

Use the <+> keys to select forced mono.

If this setting is stored, all transmissions received in this programme position will always be reproduced in mono.

3. Store the setting and return to TV picture



All changed settings are stored.

6.1 Correcting picture deviations

It is possible for stations to be received with differing levels of chrominance, picture sharpness and contrast, even though the settings on the individual programme positions are identical. For this reason, your TV set enables you to correct the value for each programme position and/or to select a picture correction function (CTI, noise reduction).

Press this key on the remote control....

The screen displays

Explanation

1. Call the first picture menu in the station table and correct the picture sharpness

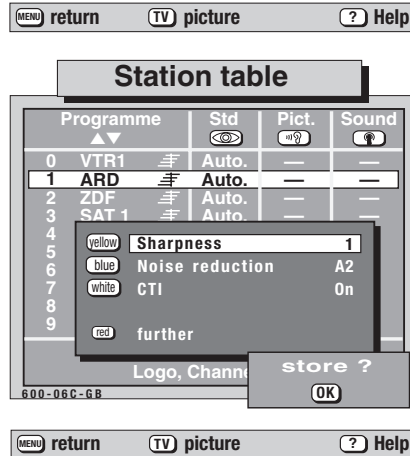
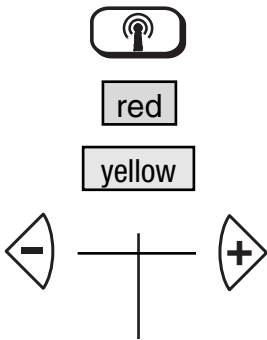

The picture menu contains all settings which can change the picture.

If the pictures received from a station are unsharp, this function permits you to correct the picture sharpness for an individual programme position and to store this adjustment.

The picture sharpness can be changed with the

2. Switch on the noise reduction

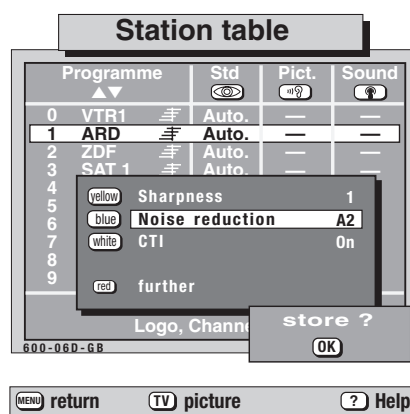
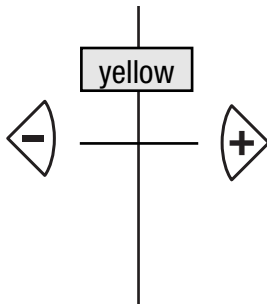

This noise reduction function can be switched on if the picture contains snow or noise.

The noise reduction function can be switched **OFF** or **A1** or **A2**.

3. Switch on the CTI function

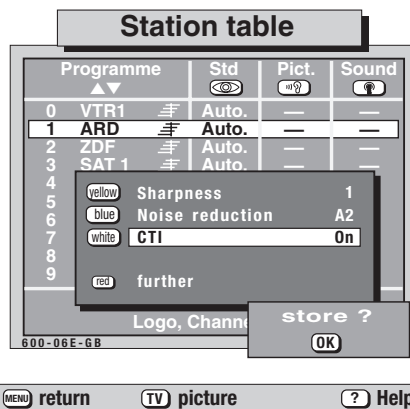
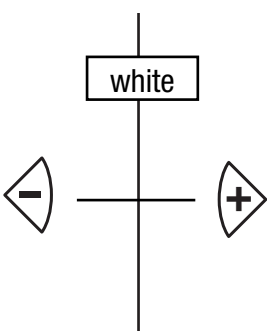

CTI stands for Colour Transient Improvement and improves the transitions between different coloured areas of the picture, making the picture appear much sharper. The CTI function is effective for both transmissions received by way of the aerial input and for signals received via the AV sockets. CTI also provides a visible improvement when playing back from a video recorder.

However, in certain applications (such as playing back from an S-VHS video recorder), the CTI function may just have the opposite effect.

When playing back from such recorders, CTI can result in a lower-quality picture. For this reason, this menu permits you to switch off the CTI function for specific programme positions.

4. Call the second picture menu and adjust the chrominance

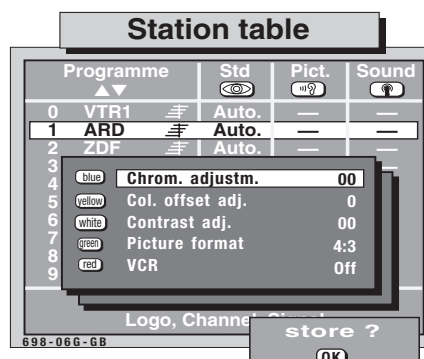
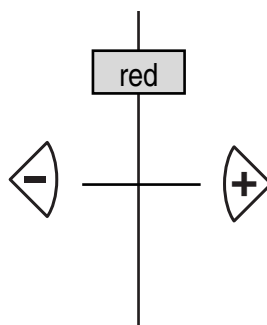

In this second picture menu, the chrominance, colour offset and contrast can be corrected individually for each programme position.

In our example, the chrominance of Programme 1 is to be diminished. Hold down the ◀ key until the colour intensity is the same as in programme position 3.

The chrominance adjustment range is -15 to +15.

If no other values are to be changed, then press the **OK** key to store the new setting.

6.1 Correcting picture deviations

Press this key on the remote control....

The screen displays

Explanation

5. Adjust the colour offset or contrast

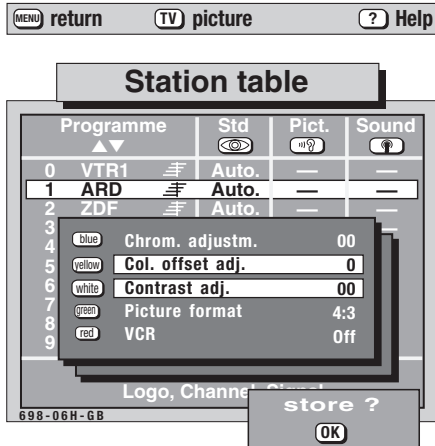
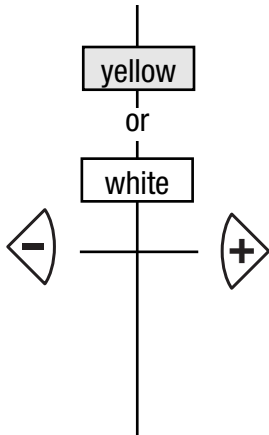

Normally, it is not necessary to adjust the colour offset.

However, if external units are connected it is possible that colour and black-and-white pictures are not accurately superimposed. A similar effect is sometimes encountered in journals when the black-and-white and colour impressions do not register, with the result that the contours are blurred.

The colour offset range is between -3 and +3.

The contrast adjustment range is -15 to +15.

If no other values are to be changed, then press the **OK** key to store the new settings.

6. Change the picture format

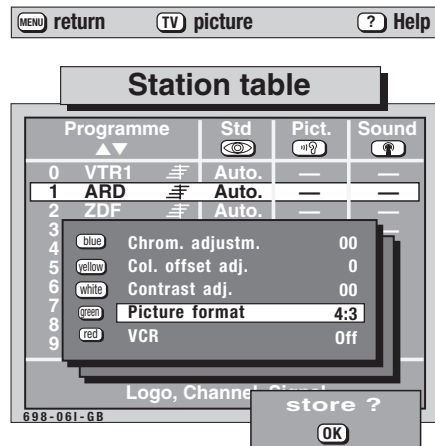
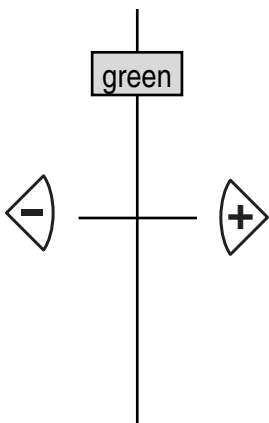

The picture format of each TV programme position must be set to 4:3.

If a video recorder with 16:9 format detection is connected, the picture format of the related programme position must be set to 16:9.

If a 16:9 input signal is applied to the phono sockets or the mini-DIN (YC) socket, the picture format must be changed manually.

An external switching voltage of 4-7 V at the EURO1 or EURO 2 socket automatically switches the TV to 16:9 format, provided that the signal type was stored under the heading „...controls AV operation“ in the menu „Equipm. configuration, device connection“.

7. Store all settings and return to TV picture

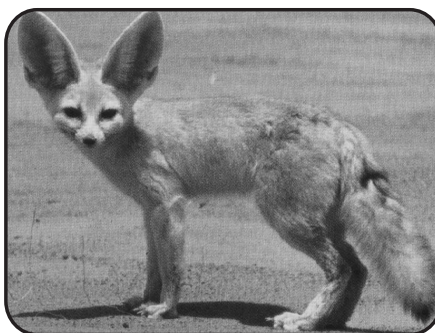





7. AV recording

Camcorder → video recorder

In the „AV recording“ menu, you can define which of the connected peripheral AV devices are to be used for copying a recording.





AV device is a generic term for all external video units, such as video recorders, camcorders, video disk players, photo CD players, etc which can be connected to a TV.

Example: You wish to copy a film recorded with an S-VHS/Hi8 camcorder to an S-VHS/Hi8 video recorder which is also connected to the TV set.

Press this key on the remote control....	The screen displays	Explanation
1. Call the AV menu		<p>In the „AV recording“ menu , you can select how the AV devices connected to your TV set (see Section 13, „Equipment configuration/Connecting external devices“) are to be used for copying a recording.</p> <p>The left side of the menu (Input) shows the devices which supply picture and sound for the copy operation. Selection of an input for a programme is meaningful only for SAT or decoder operation.</p> <p>The right side of the menu (Output) shows the devices capable of recording the picture and sound.</p>
2. Select the desired AV devices (in this example: Camcorder and Video Rec. 1)		<p>After calling this menu, you must first select the input device, i.e. the device which is to supply the picture. Once you have done this, the cursor moves to the output side of the menu and the keys are displayed in colour. If there is more than one AV device shown on the output side, you must select the desired device manually. If you make a mistake, you can switch between the input and output sides of the menu with the \leftarrow/\rightarrow keys.</p> <p>Back to the example: You want to copy the film from the camcorder to video recorder 1. Press the white key to display the signal from the camcorder on the screen. Then press the yellow key to select the output device.</p>
3. Store the settings and clear the menu		<p>The copy operation with the selected devices is now active.</p> <p>If any subsequent switching operations could interfere with copying, a warning box with the text „AV recording“ will be displayed and the requested switching operation will not be executed.</p>
4. Terminate or abort the copy operation		<p>To check the progress of the operation, press the AV key to display the picture from the input device on the screen.</p> <p>If you wish to execute the copy operation in standby mode, you can switch the TV set to this mode by pressing the TV key.</p>

7. AV recording Video recorder → video recorder

Example: You wish to copy a film from video recorder 1 to video recorder 2.

Press this key on the remote control....	The screen displays	Explanation
<p>1. Call the AV menu</p> <p style="text-align: center;">AV</p>		
<p>2. Select the desired AV device (in this example: video rec. 1)</p> <p style="text-align: center;">yellow</p>		<p>After calling the menu, you must first select the input device which is to supply the picture. In our example, you select video rec. 1 by pressing the yellow key.</p> <p>Once you have done this, the cursor moves to the output side of the menu and video rec. 2 is selected automatically, since there is no other choice.</p>
<p>3. Store the settings and clear the menu</p> <p style="text-align: center;">OK</p> <p style="text-align: center;">TV</p>		<p>The copy operation with the selected devices is now active.</p> <p>If any subsequent switching operation could interfere with copying, a warning box with the text „AV recording“ will be displayed and the requested switching operation will not be executed.</p> <p>To check the progress of the operation, press the AV key to display the picture from the input device on the screen.</p>
<p>4. Terminate or abort the copy operation</p> <p style="text-align: center;">AV</p> <p style="text-align: center;">OK</p>	<p>TV picture</p>	<p>If you wish to execute the copy operation in standby mode, you can switch the TV set to this mode by pressing the  key.</p>

8. Time settings







Switch-on/off and reminder time

In the „Time settings“ menu, you can enter settings which will instruct the TV to switch itself on or off, and to display a reminder at a given time.

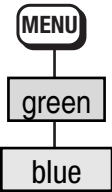
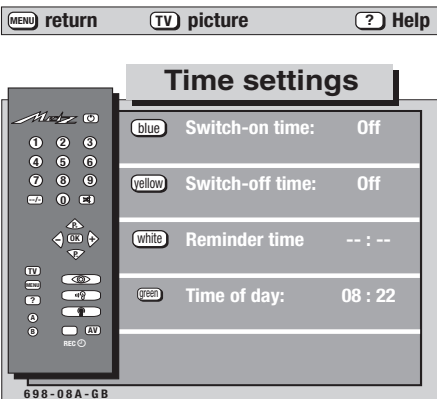
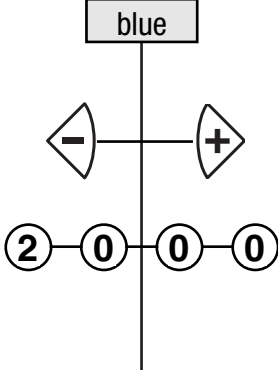
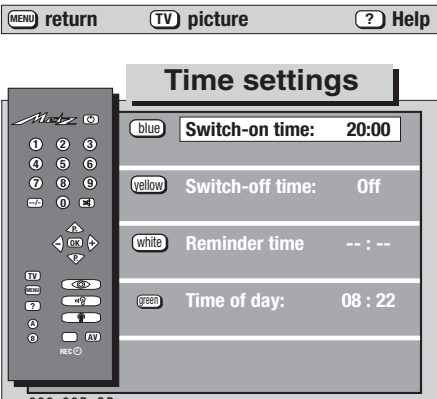
Switching from summer time to winter time and vice versa is carried out automatically by the teletext clock.

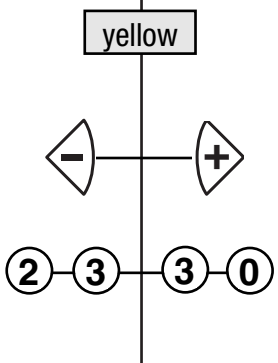
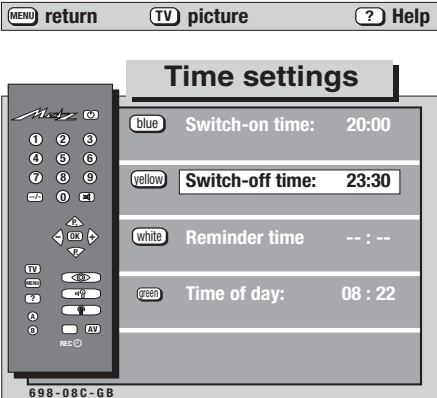
The switch-on time function will automatically turn on the TV at the preset time if the television is in standby mode. The switch-off time function will automatically switch it off as desired. The reminder service is intended to help you remember things which you have to do later on, for instance a telephone call. All three settings can be jointly programmed.

Example: The TV is to switch itself on at 20:00 hr, remind you of something at 21:45 hr, and switch itself off at 23.30 hr.

Press this key on the remote control....	The screen displays	Explanation
<p>1. Call the „Time settings“ menu</p> 		<p>The adjoining picture shows the appearance of the „Time settings“ menu when no times have been programmed.</p>
<p>2. Enter the switch-on time (Example: 20.00 hr)</p> 		<p>If you press the blue key, the text in the first line is displayed on a blue background.</p> <p>Now press the  or the  key to switch on the function. Enter the desired switch-on time with the numeric keys. The function is activated after input of the last digit. Henceforth the TV set will switch itself on every day at the preprogrammed time.</p> <div style="border: 1px solid black; padding: 5px;"> <p>When the set has switched itself on automatically, you must press any key you choose on the remote control, otherwise the set will return to standby mode after about 10 min. This is a safety precaution to ensure that the television does not stay on if you are not at home.</p> </div>
<p>3. Enter the switch-off time (Example: 23.30 hr)</p> 		<p>If you press the yellow key, the text in the second line is displayed on a yellow background.</p> <p>Now press the  or the  key to switch on the function. Enter the desired switch-off time with the numeric keys. The function is activated after input of the last digit.</p> <p>The switch-on/switch-off times can be deleted with the   keys (function OFF).</p>

8. Time settings

Switch-on/off and reminder time

Press this key on the remote control....

The screen displays

Explanation

4. Enter the reminder time (Example: 21.45 hr)

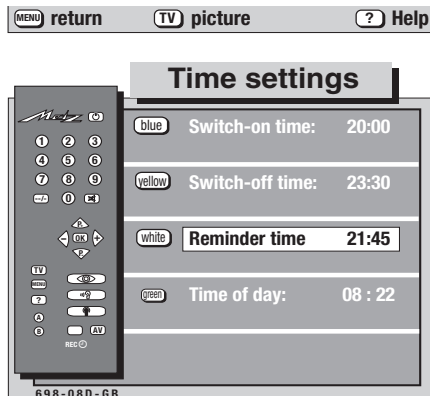
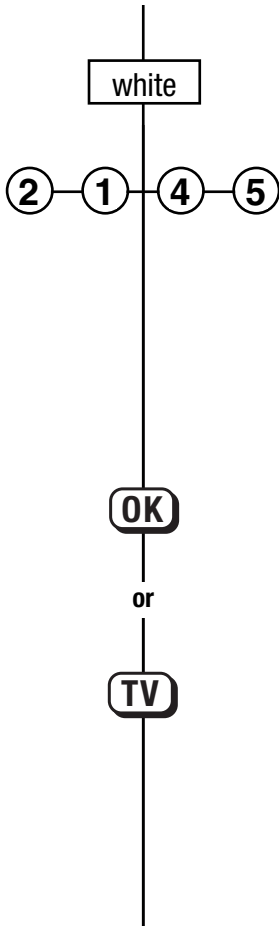

If you press the white key, the text in the third line is displayed on a white background.

Enter the desired reminder time with the numeric keys. The function is activated after input of the last digit.

The reminder time can be deleted with the key.



At the programmed time, a box with the text „Hallo“ is displayed on the screen if the TV set is switched on.

This box disappears if you press the or key or switch to a different programme position.

5. Enter the time manually (Example: 14.24 hr)

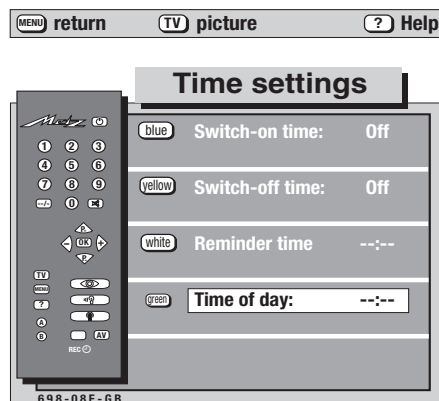
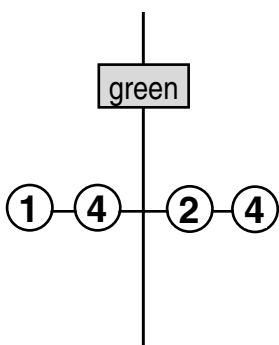

If you switch to a programme position in which teletext has been stored, the current time automatically appears in this menu and the green key is not displayed. In such a case the time setting cannot be changed.

If, for the reason stated above, the clock is to be set manually, simply enter the time with four digits.

6. Switch to standby mode



From the standby mode, the TV set will switch itself on at 20.00 hr, remind you of the telephone call you wish to make at 21.45 hr, and switch back to standby mode at 23.30 hours.





TV picture

8.1 Childlock

Switching on

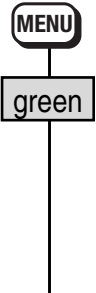
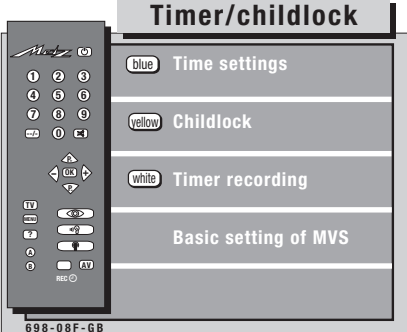
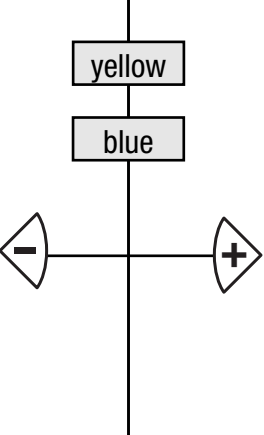
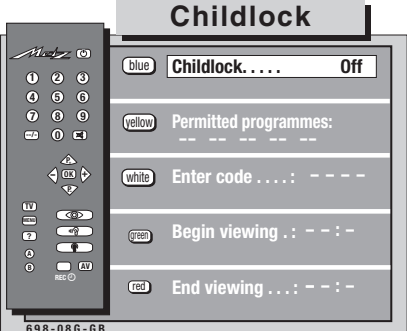
Your TV set can be protected against unauthorized use. It is possible to prevent any use of the television at all or to permit viewing of up to five specific programmes. Consequently, the childlock can be set to prevent a child from seeing violent films, yet still provide access to children's programmes on selected channels. Access to such permitted programmes can be provided in general or within a specified period of time.

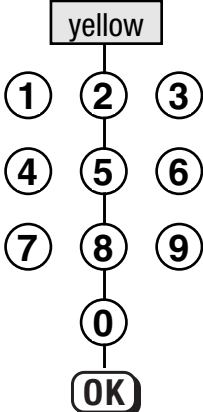
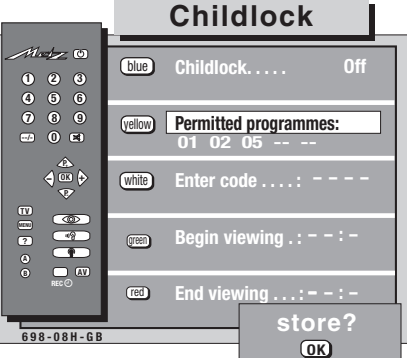
Example: The children shall only be allowed to watch programmes on the programme positions 01, 02 and 05 from 14.00 to 18.00 hr. Access to all other programme positions shall be excluded.

Press this key on the remote control....	The screen displays	Explanation
<p>1. Call the „Timer/childlock“ menu</p> 		
<p>2. Call the „Childlock“ submenu and switch on the childlock</p> 		<p>The childlock can be switched on and off with the  keys. If you set the childlock to „ON“, you must also enter a 4-digit personal code number.</p> <p>The TV set can now still be switched on, but programmes will not be shown on the screen. Instead the „Childlock“ menu will be displayed with the cursor on the „Enter code“ line.</p> <p>The childlock can be turned off again by entering the 4-digit personal code number. The TV is automatically switched to standby mode after approx. 10 minutes if it has not been switched off manually in the meantime.</p>
<p>3. Select and store permitted programmes</p> 		<p>A maximum of 5 programme positions can be entered to which access is permitted.</p> <p>These programme positions are entered with the numeric keys; all entries can be erased with the  key.</p> <p>Back to the example:</p> <p>Enter two digits for each programme position that may be watched. In our example the child has access to the programme positions 01, 02 and 05.</p> <p>Before continuing with the next programming steps, the permitted programme positions entered above must be stored; otherwise the entries will be lost.</p>

8.1 Childlock

Switching on

Press this key on the remote control....

The screen displays

Explanation

4. Enter your personal code

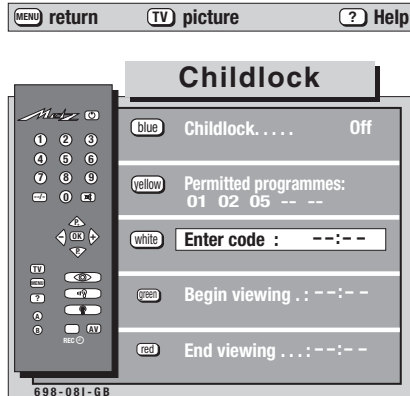
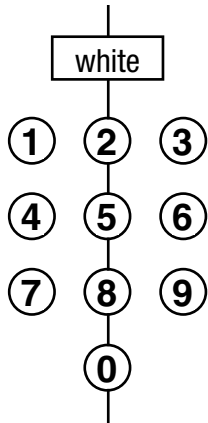

Enter your personal 4-digit code at this point.

The digits are entered with the numeric keys. The entered code number is NOT displayed!

Ask your local dealer for help if you have forgotten your personal code number.

5. Enter the beginning and end of the viewing period

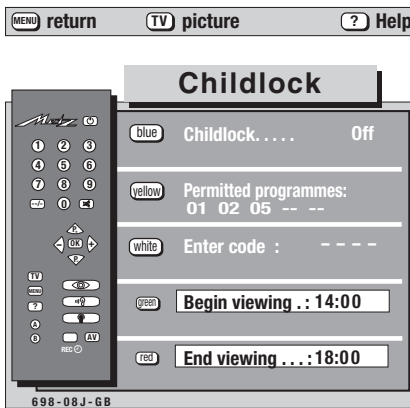
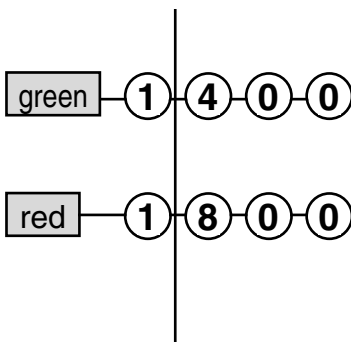

Here you can enter the times between which viewing of the permitted programmes is allowed.

The TV is not automatically switched on at the beginning of this period; it is, however, automatically switched off at the end of it.

If no permitted programmes have been entered all TV transmissions within this period can be viewed.

6. Activate the childlock

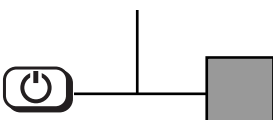

The childlock is activated when the set is switched off with the key or with the ON/OFF key.

8.1 Childlock

Switching off

Call the TV menu and enter your personal code

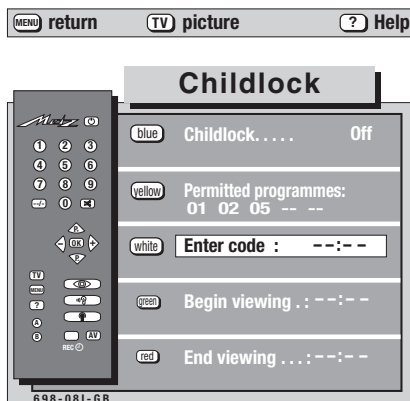
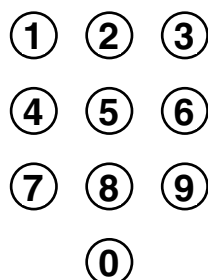

Entry of the personal code number switches off the childlock and the selected programme is displayed on the screen.







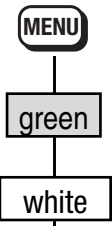

Ask your local dealer for help if you have forgotten your personal code number.

8.2 Recording with the timer

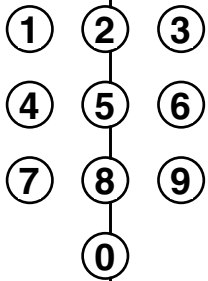
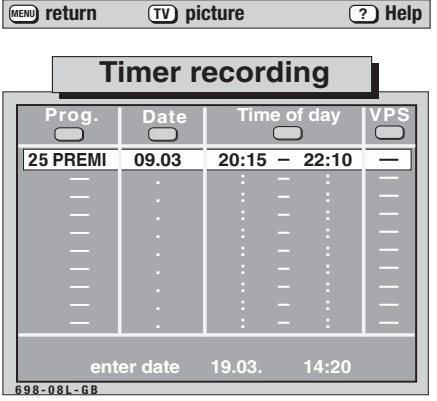
The menu „Timer recording“ is intended primarily for recording Pay-TV programmes (e.g. Premiere) in cases where the decoder is connected to a EURO socket of the TV set.

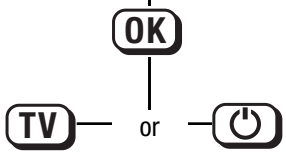
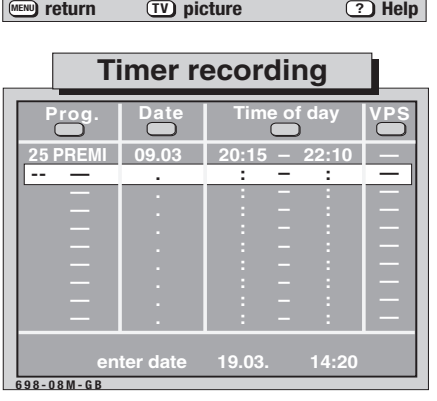
8 timers can be programmed up to 2 months in advance.

Example: A VHS video recorder which has only one EURO socket is connected to the EURO 1 socket of the TV, while a Pay-TV decoder is connected to the EURO 3 socket. You now wish to record a film running on the Pay TV channel.

Press this key on the remote control....	The screen displays	Explanation
<p>1. Call the „Timer recording“ menu</p> 		<p>If no timers have been programmed before, the table in the menu is empty. If you have previously programmed timer recordings, these will be displayed in the table.</p> <p>The current time of day and the current date are needed for programming in the timer menu. The time is normally obtained from the Megatext function and the date from the VPS signal. Note that some stations do not transmit VPS signals and/or Megatext.</p> <p>If the time and/or date are not detected automatically, you must enter them manually.</p>
<p>2. Enter the date and time of the film to be recorded (see example)</p> 		<p>The month, the day, the hours and the minutes must each be entered in the form of two digits, e.g. 01.09 for September 1 and 09:00 for 9 AM.</p> <p>If you make a mistake when entering the date and time, you can delete the entry in the current column or the entire line by pressing the  key. The entire line can be deleted only if the key symbols at the top of the menu are displayed in colour.</p>
<p>3. Store the programmed data and return to the TV picture or standby mode</p> 		<p>At the moment, PAY TV stations do not transmit a VPS signal.</p> <p>The recording can be aborted at any time by pressing the keys ,  and  sequentially, in this order, or by pressing the  key with the timer menu displayed.</p> <p>The same data must also be entered on the AV programme position of the video recorder or on a programme position where the video recorder does not receive a station.</p>

9. Connecting headphones

Headphones can be connected to the TV by way of the connecting socket underneath the fascia cover at the front. The socket will only accept headphones with a **3,5 mm** jack plug.

We recommend the use of headphones with an impedance of at least 32 Ohms. Headphones of a lower impedance (down to approx. 8 Ohms) will impair the sound quality.

The headphones volume can be stored as a standard value. The headphones and the TV speakers can be used together.

In the event of 2-channel sound transmissions it is possible to listen to either channel 1 or 2 on the headphones, irrespective of the channel set for the TV speakers.

9. Headphones

Volume

Press this key on the remote control....

The screen displays

Explanation

1. Switch off the TV speakers and adjust the headphones volume

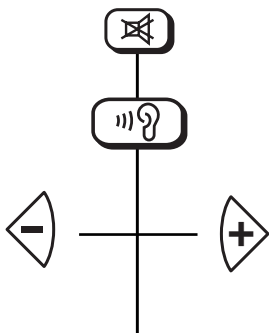

It is advisable to switch off the TV speakers with the key when adjusting the volume for the headphones.

Press the yellow key to display the bar for the headphones volume.

Adjust the volume with the keys.

2. Store the headphones volume as a standard value

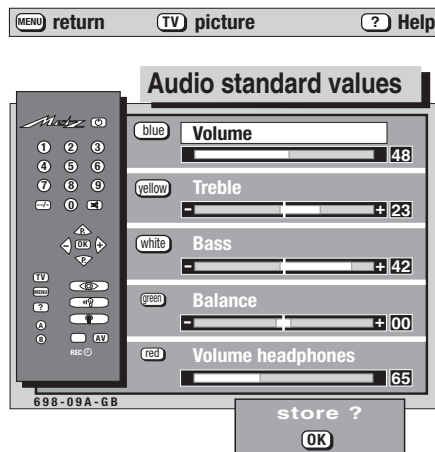

The standard value for the headphones volume can only be stored by way of the TV menu.

All standard values can be stored in the „Audio standard values“ submenu.

The volume has already been adjusted (see step 1).

It is now only necessary to press the key to store the headphones volume.

3. Return to TV picture



TV picture

Sound mode selection for headphones

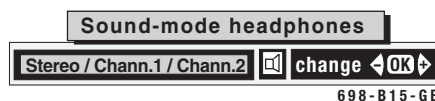

With 2-channel sound transmissions it is possible to select either channel 1 or channel 2.

If headphones are connected, it is possible to listen, for example, to the English sound track on the speakers (channel 1) and to the other language on the headphones (channel 2).

This setting can also be called by pressing repeatedly the yellow key.

The desired channel can then be selected with the keys..

10. Megatext

Basic functions

Press this key on the remote control....

The screen displays

Explanation

1. Call Megatext

TV

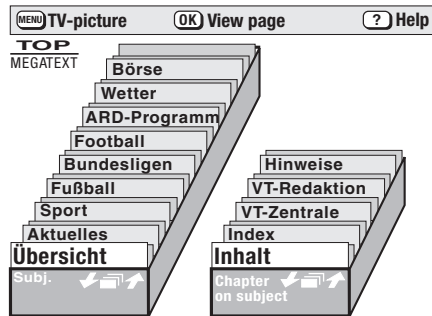

The Megatext file displays all the subjects available on a specific programme position and the chapters belonging to the currently selected subject.

The range of subjects and chapters depend on the transmitting station and can therefore be completely different in each programme position.

For some stations, for example, only numbers, rather than the header lines, appear in the Megatext file.

2. Select a subject

blue

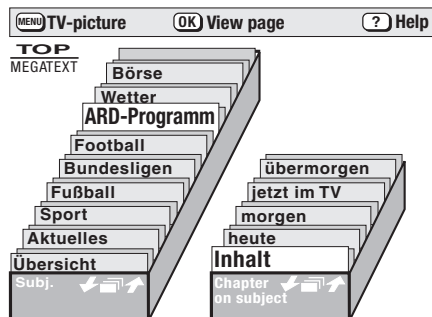

Each time the blue key is pressed, the next subject is selected and the corresponding file card is raised. Prolonged depression of the blue key raises all of the subjects sequentially.

Press the right side of the key to step backwards through the subjects, or the left side of the key to step forwards.

The displayed choice of chapters is adapted to the currently selected subject.

3. Select a chapter

yellow

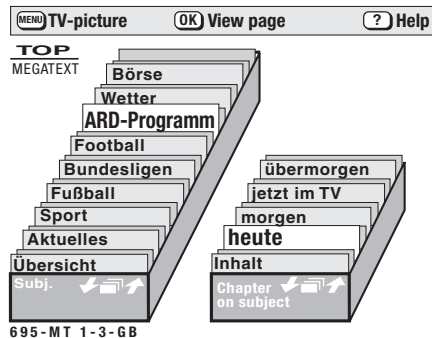

Each time the yellow key is pressed, the next chapter is selected and the corresponding file card is raised.

Press the right side of the key to step backwards, or the left side of the key to step forwards.

Prolonged depression of the yellow key raises all the chapters sequentially.

4. Open the first page of the chapter

OK

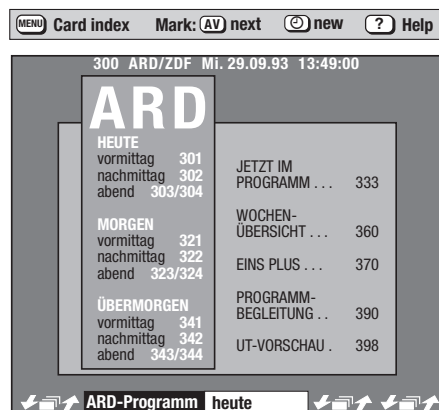

The first page of the selected subject and chapter is displayed.

File symbols with arrows in the bottom line indicate that the corresponding coloured keys will activate subject-by-subject, chapter-by-chapter or page-by-page leafing.

The blue text window shows the name of the currently selected subject, while the yellow shows the name of the currently selected chapter.

10. Megatext

Basic functions

Press this key on the remote control....

The screen displays

Explanation

5. Page-by-page leafing

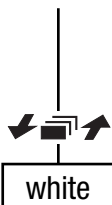

This function enables you to run through the individual pages. Just as in a book, you can leaf forwards or backwards from the displayed page.

Press the right side of the key to step backwards, and the left side of the key to step forwards.

6. Chapter-by-chapter leafing



This function enables you to run through the individual chapters.

Each time you press the yellow key, the first page of the next or previous chapter is opened.

Press the right side of the key to step backwards, and the left side of the key to step forwards.

7. Subject-by-subject leafing



Each time you press the blue key, the first page of the next or previous subject is opened. In most cases, this will be an index page.

Press the right side of the key to step backwards, and press the left side of the key to step forwards.

10. Megatext

Multiple pages

Press this key on the remote control....

The screen displays

Explanation

1. Recognizing multiple pages

MENU Card index Mark: (AV) next (C) new (?) Help

422 ARD/ZDF Di. 12.10.93 13:08:00

börse frankfurt

Fortlaufende Notierungen 1/4
12.10.93 Kassa Vortag

/1	AEG	164,8	164,8	165,0
/2	AMB	1270,0	1270,0	1270,0
/3	AGIV	532,0	529,0	528,0
/4	Allianz	2709,0	2710,0	2730,0
/5	Altana	578,0	578,0	578,0
/6	Asko	891,0	894,0	875,0
/7	BSAF	263,0	263,8	267,0
/8	Bayer	312,0	312,7	316,5
/9	Bay. Hypo	470,0	470,5	472,0
/10	BHF-Bank	493,0	491,0	496,5
/11	BMW	589,0	591,0	596,0
/12	Bay. Verbank	518,0	518,0	524,0

ohne Gewähr

Börse Kurse Ffm.

Multiple pages are indicated by a dark bar with the subpage numbers on the left-hand side of the displayed page.

The bright numbers indicate the number of subpages contained in this multiple page. The number of subpages is transmitted by the stations at intervals of 20 seconds. Consequently, it may take some time until all subpage numbers are displayed.

If there are more than 15 subpages, the cursor (white bar) can be moved downwards with the ∇ key to display the next group of subpage numbers (for example /16 to /30).

Some stations do not provide multiple page identification; in this case, the subpages are displayed sequentially. To stop a page for reading, one of the A or B function keys must be programmed with the „Stop page“ function in Megatext mode. Renewed depression of the „Stop page“ function key advances to another subpage (the one the station is currently transmitting).

2. Selecting subpages

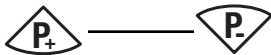

MENU Card index Mark: (AV) next (C) new (?) Help

422 ARD/ZDF Di. 12.10.93 13:08:00

börse frankfurt

Fortlaufende Notierungen 2/4
12.10.93 Kassa Vortag

/1	Commerzbank	325,0	324,7	326,5
/2	Continental	225,6	227,5	232,0
/3	Daimler	741,5	740,5	741,0
/4	Degussa	384,5	384,0	383,0
/5	Dt. Babcock	206,5	206,0	206,5
/6	Dt. Bank	808,4	808,0	809,0
/7	Douglas	579,0	576,0	580,0
/8	Dresdn. Bk.	430,5	431,5	435,0
/9	FAG	123,5	125,0	125,0
/10	Henkel Vz.	580,0	580,0	588,0
/11	Hochtief	1125,0	1122,0	1140,0
/12	Hoechst	285,5	286,5	291,5
/13	Holzmann	935,0	930,0	962,0

ohne Gewähr

Börse Kurse Ffm.

Use the ∇ \triangle keys to move the cursor (white bar) up or down. The subpage selected with the cursor is displayed on the screen.

The numbers in the top right corner of the displayed page (in this example 2/4) indicate the currently displayed subpage and the total number of subpages (in the example: subpage 2 of a total of 4 pages).

10. Megatext

Page selection by cursor



MENU Card index Mark: (AV) next (C) new (?) Help

300 ARD/ZDF Mi. 29.09.93 13:49:00

ARD

HEUTE		
vormittag	301	JETZ IM PROGRAMM ... 333
nachmittag	302	
abend	303/304	
MORGEN		WOCHEN-ÜBERSICHT ... 360
vormittag	321	
nachmittag	322	EINS PLUS ... 370
abend	323/324	
ÜBERMORGEN		PROGRAMM-BEGLEITUNG ... 390
vormittag	341	
nachmittag	342	UT-VORSCHAU . 398
abend	343/344	

ARD-Programm heute

694-006-D

Use the ∇ key to move the cursor (coloured bar) downwards through the page numbers. The page number highlighted by the cursor can be directly called with the (OK) key.

10. Megatext

Direct page selection

Press this key on the remote control....

The screen displays

Explanation

1. Select the subject

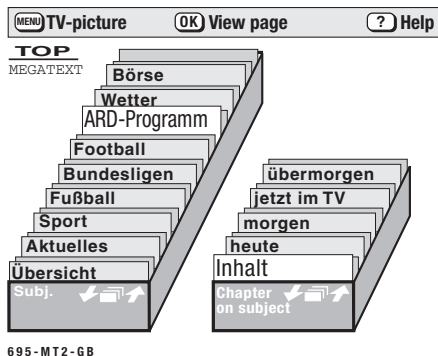
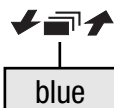

Select a file card for any desired subject.

Continue pressing the blue key to run through the file-card box.

The displayed choice of chapters is adapted to the selected subject.

2. Select the chapter

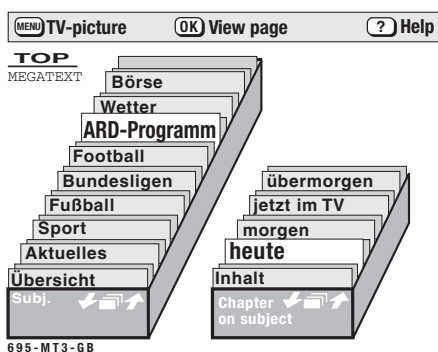
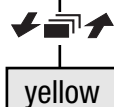

Select a file card for any desired chapter.

Continue pressing the yellow key to run through the file-card box.

3. Open the first page of the chapter



The first page of the selected subject and chapter is displayed.

4. Enter the page number e.g. page 422



After depression of the first numeric key, the number of this key, followed by two hyphens, appears at the top left of the screen. Enter the complete 3-digit number. A green line with the text „Wait for page ...“ is displayed at the top of the screen after the last digit has been entered. A red line with the message „Page is not transmitted“ is displayed if the entered page number does not exist. Otherwise the TV searches for the specified page and displays it as soon as it is located.

10. Megatext

Direct page selection

Press this key on the remote control....

The screen displays

Explanation

5. Return to TV picture

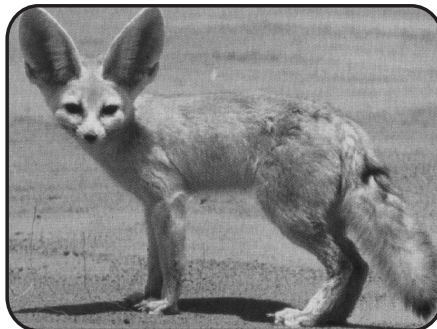

10. Megatext

Return to last index page

Return to last index page

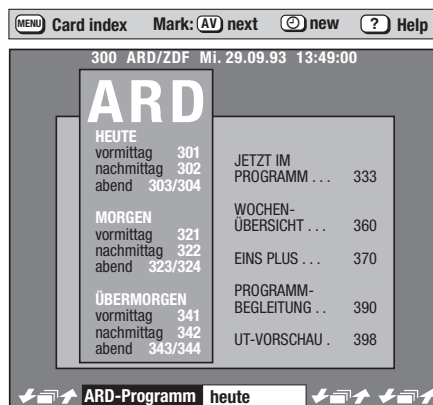

Press the **0** key to return to the previous numerically called page or, if not numerically called, to the index page of the displayed choice.

The adjoining picture shows the index page of the ARD channel as an example.

10. Hi Text

Topical or news-flash pages

Suppressing news-flash pages

white



Some stations transmit Teletext pages with news flashes, general information, football results, etc.

Once you have selected such a page and hidden it by pressing the **TV** key, the page will be displayed again whenever it is updated by the TV station.

In some cases, it may not be possible to switch to another programme position while a news flash page is displayed.

If this happens, simply select a „normal“ Teletext page with the white key: you will then be able to switch to the desired programme position without problems.

10. Megatext

Doubling the font size

Press this key on the remote control....

The screen displays

Explanation

1. Select double font size, e.g. press the B* key



When the B* key is pressed for the first time, the upper part of the selected page is displayed with the font size doubled.

You can scroll slowly through the page by holding down the key.

* The B key was programmed in the factory for this function, but this programming can be changed (see Section „Equipment configuration - Assigning the function keys“).

2. Scroll the page upwards, e.g. press the B* key

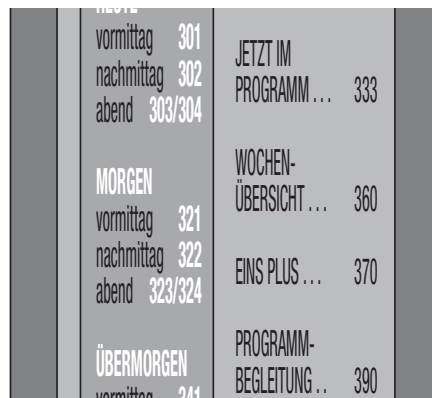

When the B* key is pressed for the second time, the displayed page is scrolled upwards.

3. Scroll the page further, e.g. press the B* key

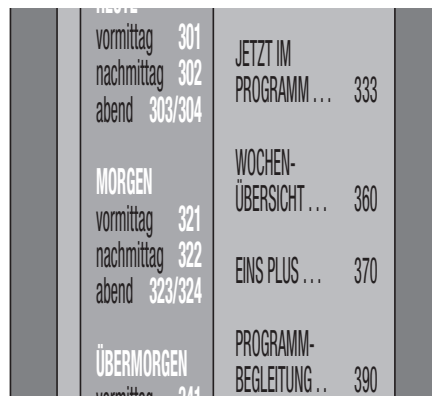

When the B* key is pressed for the third time, the displayed page is scrolled further, and so on.

4. Return to normal font size



Press the B* key for a fifth time to return to normal font size.

* Depending on the assignment of the function keys. The factory setting is B.

10. Megatext

Infotext - Setting marks

There will be certain Megatext pages, e.g. stock market, news, weather forecast, etc., that you will want to read repeatedly. We have programmed a way of making it easier to read such pages.

10 marks per position can be set on each of the first ten programme positions. These marks can be set on any desired text page of your choice, and they can be erased at any time. After marks have been assigned to a programme position it will be possible to step sequentially through the marked pages with the **INFO** key. Marks can also be set on all programme positions above Pr 10, but these marks are erased when you switch to another programme position.

Press this key on the remote control....

The screen displays

Explanation

1. Call the desired page e.g. page 400

4 0 0



2. Set the first mark

red



If marks have not yet been set in this programme position, then press the red key to set the 1st mark.

„MARK 1“ is displayed in green lettering in the top left-hand corner of the screen.

3. Select the next page e.g. 422

white



In the ARD channel, for example, page 422 is a multiple page.

With multiple pages, marks can be set on any subpage.

10. Megatext

Infotext - Setting marks

Press this key on the remote control....

The screen displays

Explanation

4. Set the second mark

red

MENU Card index Mark: (AV) next (C) new (?) Help

MARKE 2 422 ARD/ZDF Di. 12.10.93 13:08:00

börse frankfurt

Fortlaufende Notierungen 2/4
12.10.93 Kassa Vortag

1			
2			
3			
4			
5			
6			
7			
8			
9			
10			
11			
12			
13			
14			
15			
>>			

ohne Gewähr

Börse Kurse Ffm.

When the required page is displayed (in our example subpage 422/2), press the red key again.

„MARK 2“ is now displayed in green lettering in the top left-hand corner of the screen.

5. Set further marks e.g. page 110

1

1

0

red

MENU Card index Mark: (AV) next (C) new (?) Help

MARKE 3 110 ARD/ZDF Do. 14.10.93 08:11:00

AKTUELLES

Letzte Meldung 111

Nachrichten 112-115

Politik, Wirtschaft, Kultur
Umwelt, Ratgeber, Aus aller Welt

Wetter 400

Börsenkurse 420

Kirche 155/156

Am Wochenende (Freitag - Sonntag):

Reise 560

Gesundheit 580

*** Sport 200 ***

Aktuelles Inhalt

10 marks can be set as described in steps 1 - 4 in each of the first 10 programme positions.

6. Return to TV picture

TV



10. Megatext

Infotext - Mark-by-mark advance

Press this key on the remote control....

The screen displays

Explanation

1. From TV picture to the first mark



After the **INFO** key has been pressed, a panel with „Mark 1“ will be displayed.

On programme positions without a mark, a white field will be displayed with the text „No mark“.

2. Step forward to the next mark



or



Each time the **INFO** key is pressed, you advance to the next mark. In this manner you can run through all pages on which marks are set.

3. Return to TV picture



or

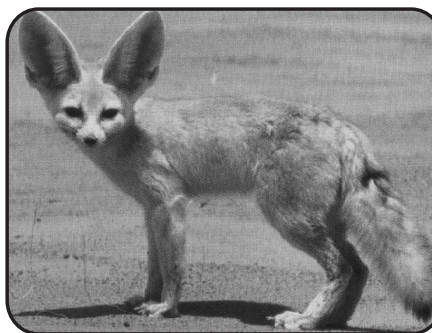

The **INFO** key will return you to the TV picture after having run through all marks.

Press the **TV** key to return directly to the TV picture without having to run through all the marks.

10. Megatext

Infotext - Erasing marks

Press this key on the remote control....

The screen displays

Explanation

1. Call the desired page
e.g. page 422/2



or

green

MENU Card index Mark: (AV) next (new) (?) Help

MARKE 2 422 ARD/ZDF Di. 12.10.93 13:08:00

börse frankfurt

Fortlaufende Notierungen 2/4
12.10.93 Kassa Vortag

		Kassa	Vortag
/1	Commerzbank	325,0	324,7
/2	Continental	225,6	227,5
/3	Daimler	741,5	740,5
/4	Degussa	384,5	384,0
/5	Dt. Babcock	206,5	206,0
/6	Dt. Bank	808,4	808,0
/7	Douglas	579,0	576,0
/8	Dresdn. Bk.	430,5	431,5
/9	FAG	123,5	125,0
/10	Henkel Vz.	580,0	580,0
/11	Hochtief	1125,0	1122,0
/12	Hoechst	285,5	286,5
/13	Holzmann	935,0	930,0
/14			
/15			
>>			

ohne Gewähr

Börse Kurse Ffm.

Press the key to call the page where the mark is to be erased.

2. Erase the mark

red

MENU Card index Mark: (AV) next (new) (?) Help

422 ARD/ZDF Di. 12.10.93 13:08:00

börse frankfurt

Fortlaufende Notierungen 2/4
12.10.93 Kassa Vortag

		Kassa	Vortag
/1	Commerzbank	325,0	324,7
/2	Continental	225,6	227,5
/3	Daimler	741,5	740,5
/4	Degussa	384,5	384,0
/5	Dt. Babcock	206,5	206,0
/6	Dt. Bank	808,4	808,0
/7	Douglas	579,0	576,0
/8	Dresdn. Bk.	430,5	431,5
/9	FAG	123,5	125,0
/10	Henkel Vz.	580,0	580,0
/11	Hochtief	1125,0	1122,0
/12	Hoechst	285,5	286,5
/13	Holzmann	935,0	930,0
/14			
/15			
>>			

ohne Gewähr

Börse Kurse Ffm.

Erasure of the mark on the current text page changes the sequence of the remaining marks.

Example:

3 marks have been set in the current programme position:

- Mark 1 on text page 400
- **Mark 2 on text page 422/2**
- Mark 3 on text page 503

You now erase the mark 2 on text page 422/2.

The sequence of the remaining marks is immediately re-arranged and is now::

- Mark 1 on text page 400
- **Mark 2 on text page 503**

3. Return to TV picture

TV





10. Megatext

Subtitles

This TV enables you to display programme subtitles automatically.

For this purpose one of the two A or B function keys must be programmed on the remote control handset. Please refer to Section „**Equipment configuration - Assigning the function keys**“ for programming. The subtitles will only be displayed automatically after a function key has been programmed accordingly.

Example: You wish to watch the news with its subtitles. Program a function key with the „Subtitle“ function.

Press this key on the remote control....	The screen displays	Explanation
<p>1. Display of subtitles in the current programme</p> <p>automatically</p>		<p>The teletext transmitted by the station is superimposed on the picture at the bottom of the screen.</p> <p>The subtitle function can be activated or deactivated with the A or B function key.</p>
<p>2. Blank out the subtitles*</p> <p>Ⓐ or Ⓑ</p>		<p>The subtitle function can be switched off and on again with the correspondingly programmed function key.</p> <p>Note: If the subtitle function is programmed for one of the function keys, it will automatically be activated when the TV set is switched on.</p>

* Depending on the assignment of the function keys

10. Megatext

Riddle solutions key

Access to riddle solutions

Megatext contains riddles with hidden answers.

The solutions to these riddles can be displayed with the **A*** or **B** function key.

Ⓐ*
or
Ⓑ

* Depending on the assignment of the function keys. The factory setting is **A**.

11. Special picture effects

Variable Zoom

All programmes that are not transmitted in the traditional 4:3 screen format, such as cinema films in Cinemascope or Super-Cinemascope or 16:9 format, have black bars at the top and bottom of the screen.

With the zoom function, you can increase the size of the picture and make the black bars disappear. Although this also causes part of the picture to move off the screen at each side, the resulting loss of information is slight and less disturbing than the black bars.

Press this key on the remote control....

The screen displays

Explanation

1. Switch on the zoom function and enlarge the picture





Press the  button until the black bars at the top and bottom of the screen have disappeared. The entire picture is enlarged uniformly.

The selected enlargement factor is automatically stored for this programme position as long as the TV set is not switched off. Switching to another station will restore the picture to its normal size. If you return to the station for which you activated the zoom function, the picture will be automatically enlarged if the same programme is still running.

2. Call the zoom function for the current programme position



If you wish to use the selected enlargement also for other programmes, press the  key again after setting the zoom factor with the  key. This returns the picture to its normal size, but stores the current enlargement factor for subsequent use.

3. Switch off the zoom function



If the TV set has been switched off with the remote control or the main switch, the stored enlargement factor can be recalled by pressing the  key twice.

11. Special picture effects

Frame freeze

Press this key on the remote control....

The screen displays

Explanation

1. Activating frame freeze



When you press this key, the current frame is „frozen“ on the screen. The TV programme (or the video film) continues to run in the background.

2. Deactivating frame freeze



Pressing the key again switches back to the current programme (or video film).

12. Operation without remote control

This mode is only intended for an emergency when the battery in the remote control handset is flat, or if the remote control is not available.

The TV controls are underneath a cover at the front of the set.

You can control the following functions on the TV without the remote control handset. The preselection of the function is valid for 10 seconds, only 5 of which are shown in the permanent display.

Programme selection:

Press the - + keys.

Volume:

Hold down the **preselect key** until the bar display for the volume appears on the screen. Now press the - + keys to adjust the volume.

Contrast:

Hold down the **preselect key** until the bar display for contrast appears on the screen. Then press the - + keys to adjust the contrast.

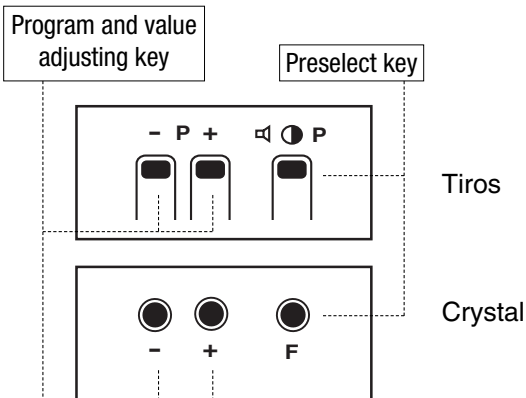

13. Connecting peripheral equipment

Video recorders can be connected to the TV set via the antenna socket or a EURO socket.

We recommend connection via a EURO (Scart) socket, since only such sockets have separate inputs and outputs for the picture and sound signals.

Camcorders can be connected to the TV set with special cables (available from your dealer).

The following connection diagram applies in principle to all of our products, although the various sockets may be located in different positions on different units.

TV set (rear view)

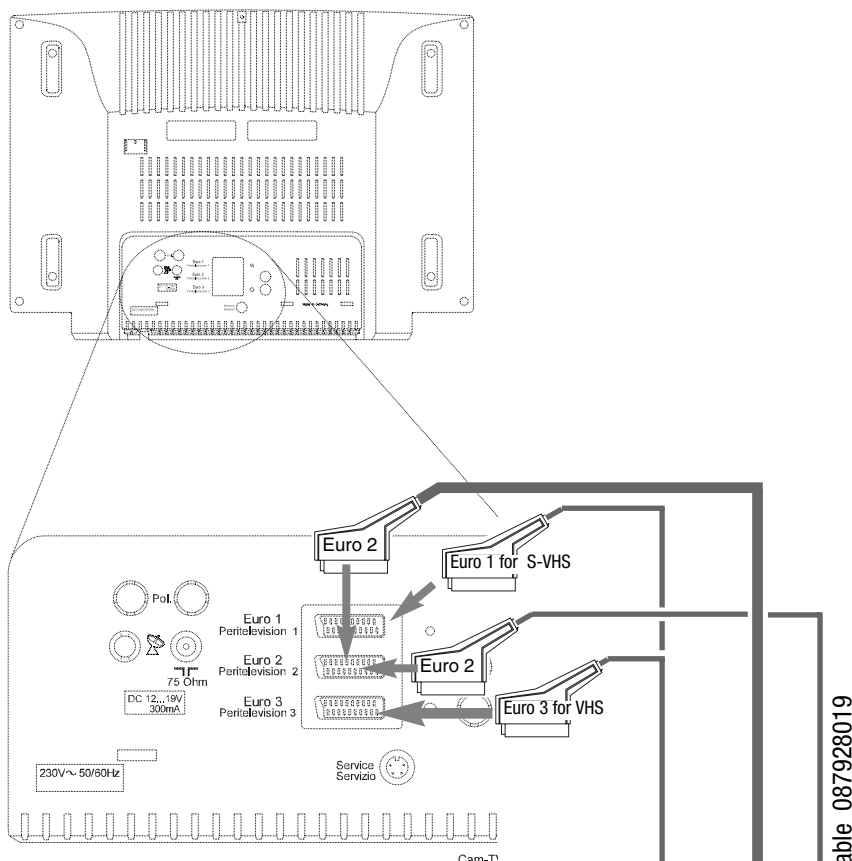

Phono-Scart cable for VHS-Scart or S-VHS-Scart connection

e.g. hama Item No. 42387 or hama Item No. 42394

Euro or Scart cable

Metz-cable 087928019

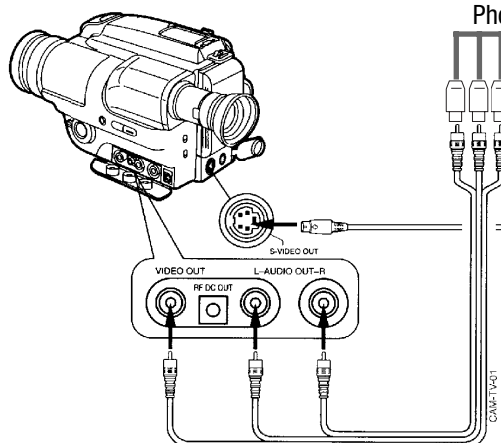

Camcorder (video camera)

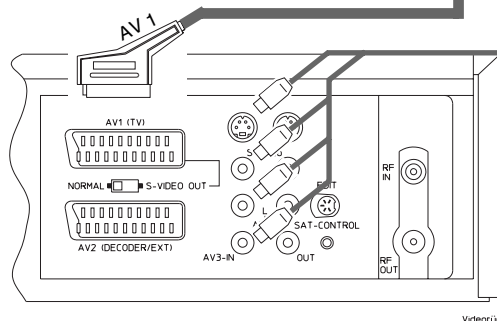

Video recorder (rear view)

Metz-cable 087928019

only for copying S-VHS/Hi-8 films from EURO 2 to AV 3 In (phono input)

13. Equipment configuration

Connecting external devices

In the menu „Device connection“, you can define which AV devices are connected to the various sockets on the TV set. The box „Devices“ contains a list of common AV devices. Only certain devices can be connected to the FRONT sockets.

Wherever possible, the AV devices should be connected to specific EURO sockets, namely:

EURO 1: S-VHS or VHS play back video recorder, S-VHS or VHS camcorder (videocamera), PC, games console (e.g. Nintendo), laser disk, photo CD, SAT receiver/ Pay-TV decoder, SAT/Set Top unit, S-VHS playback unit.

EURO 2: S-VHS/Hi8 video recorder, S-VHS/Hi8 video recorder, VHS video recorder, S-VHS or Hi8 camcorder (videocamera), SAT receiver.

EURO 3: VHS play back video recorder, VHS video recorder + Pay-TV decoder, Pay-TV decoder.

The connections are pre-programmed in the factory as shown in the picture for step 2.

Press this key on the remote control....	The screen displays	Explanation
--	---------------------	-------------

1. Call the „Device connection“ menu

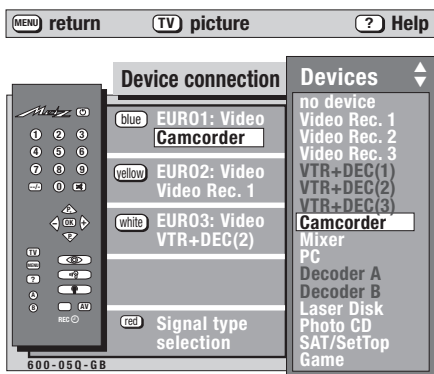
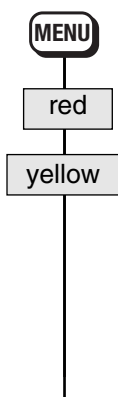

In the „Device connection“ menu, you can assign one of the defined AV devices to each of the EURO sockets.

The abbreviations in the box on the right have the following meanings:

Video rec. = video recorder (up to 3 may be connected). Video rec. 1 is the video recorder which is always connected; Video rec. 2 and 3 are used for copying from one recorder to another.

VTR+Dec. = video recorder and Pay-TV decoder (e.g. Premiere), where the decoder is connected only to the video recorder.

Camcorder = video camera

Decoder = Pay-TV decoder (e-g- Premiere)

SAT = external satellite receiver

Game = games console

2. Change the device connections

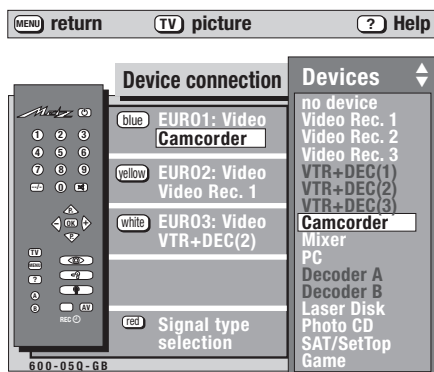
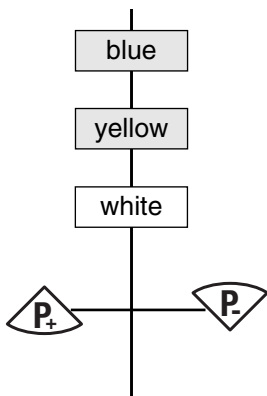

The default settings can be modified to meet your own requirements. You should, however, note the following input and output signal allocations when doing this.

	S-VHS / Hi8 (= Y/C =S-Video)		VHS (= Video)		RGB
	Input	Output	Input	Output	Input
EURO 1	Yes	No	Yes	No	Yes
EURO 2	Yes	Yes	Yes	Yes	No
EURO 3	No	No	Yes	Yes	No

To change the settings, select the appropriate EURO socket with the coloured keys and then select the device to be connected with the and keys.

3. Change the signal type

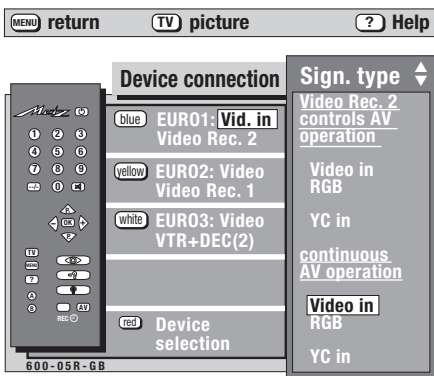
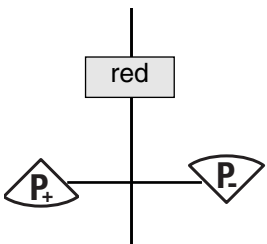

When the devices are selected, the signal type is always set to „video“. Pressing the red key displays a box for selection of the signal type.

Differences between the signal types:

• **continuous AV operation:** the screen displays the picture provided by the AV device. The channel setting of the TV set has no effect.

• **... controls AV operation:** if the AV device is set to „play“, the screen displays the picture provided by the AV device; if the AV device is set to „stop“, the screen displays the picture of the selected TV programme position.

4. Store the settings and return to TV picture

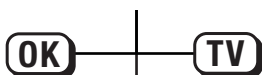

TV picture

13. Connecting peripheral equipment

A video recorder can be connected to the TV set via the aerial socket or via one of the EURO sockets.

We recommend connecting the video recorder via a EURO (Scart) socket, since only these sockets have separate inputs and outputs for the video and audio signals.

A **VHS video recorder** can be connected to the EURO2 or EURO3 sockets. An **S-VHS/Hi8 video recorder** must be connected to the EURO socket 2 if you wish to take advantage of the full picture quality provided by such a recorder (see the table on page 45). A second S-VHS/Hi8 video recorder can be connected to EURO socket 1 to play back films recorded on the S-VHS/Hi8 video recorder connected to the EURO socket 2.

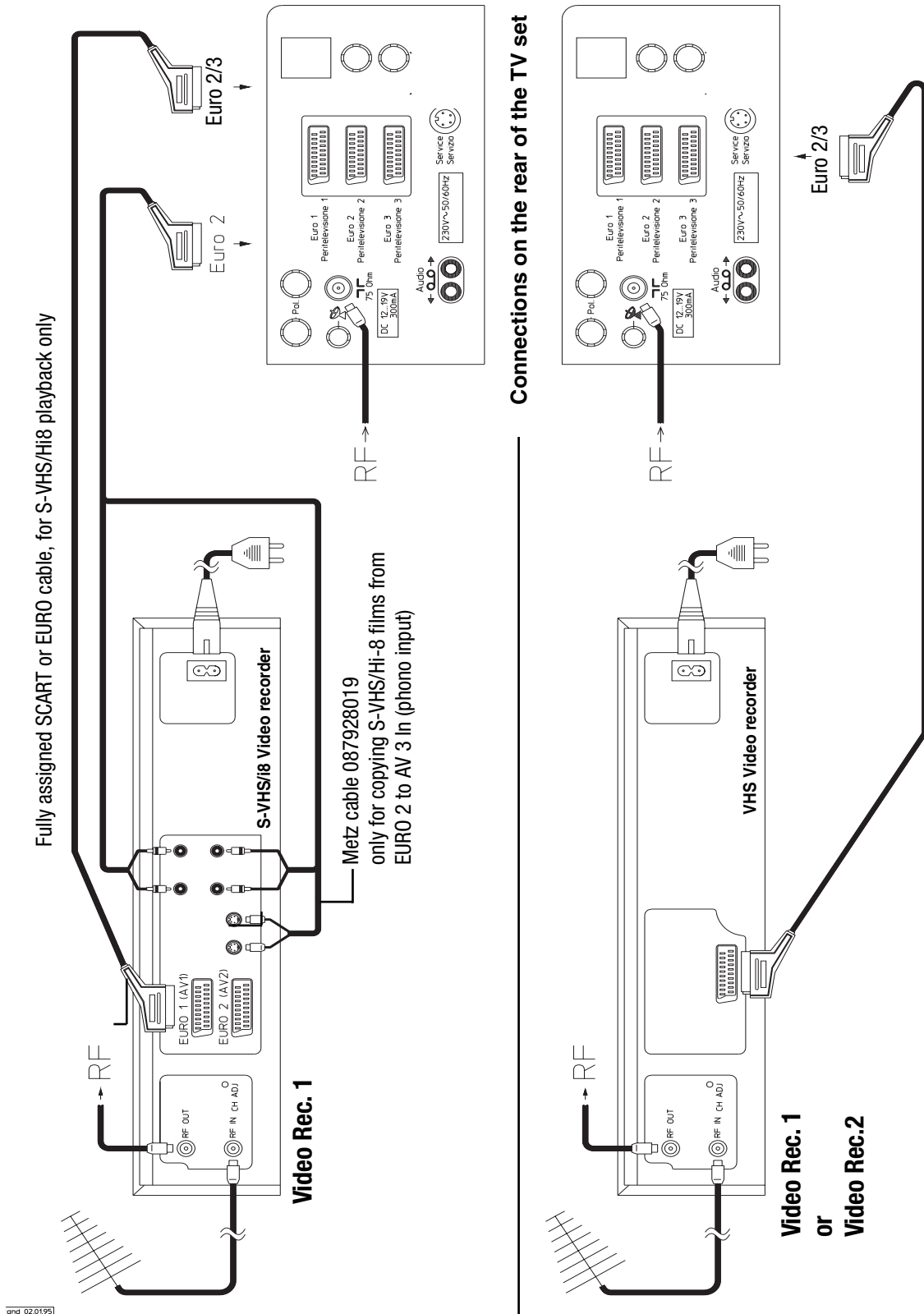

56120 P10

13. Connecting peripheral equipment

In the following example, video recorder 1 is to be connected to the EURO 2 socket.

Video recorder 1 is programmed in the factory on programme position 0. For this reason, connect the video recorder via a EURO cable to the EURO 2 socket, insert a recorded cassette, press the ► key and select programme position 0 on the TV set.



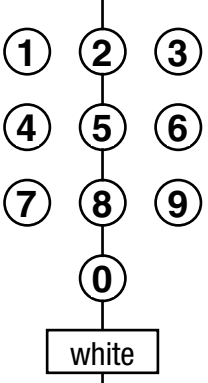
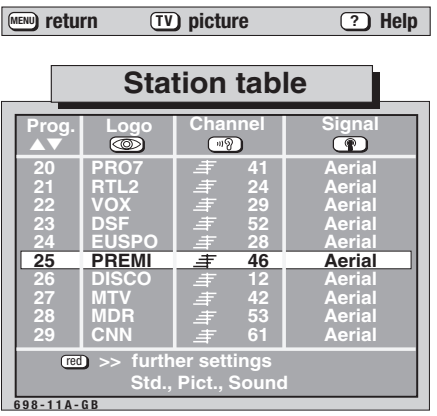
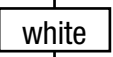
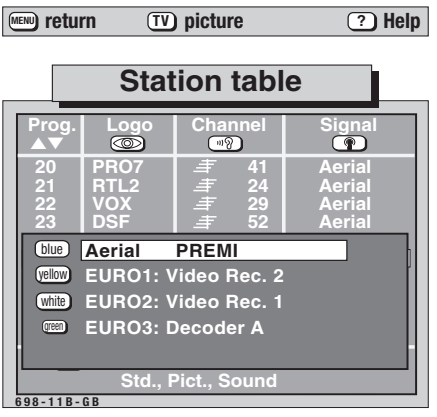
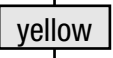
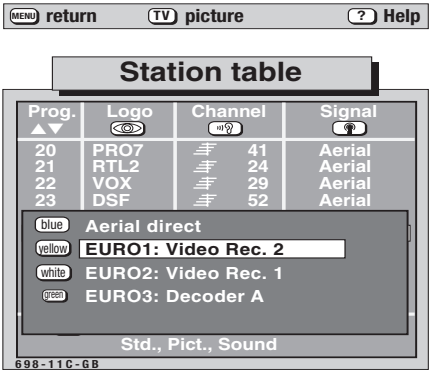
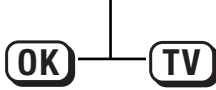

Example: Connect Video recorder 1 to the EURO 2 socket, as shown on page 44.

Press this key on the remote control....	The screen displays	Explanation
<p>1. Select any desired programme position and call the station table</p> 		<p>Select any desired programme position (in this example: position 25).</p>
<p>2. Call the submenu „Video signal“</p> 		<p>The video signal is normally supplied directly by the aerial.</p>
<p>3. Select the video signal EURO 1: „LogicVTR+D“</p> 		<p>In order to display the picture from the video cassette on the screen, the video signal must be set to „EURO1“.</p>
<p>4. Store the setting and return to the TV picture</p> 	<p>TV picture</p>	

13. Connecting peripheral equipment Video recorders

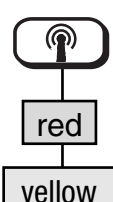
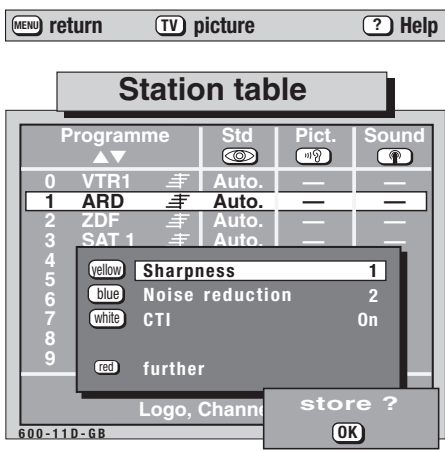
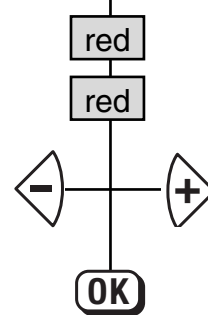
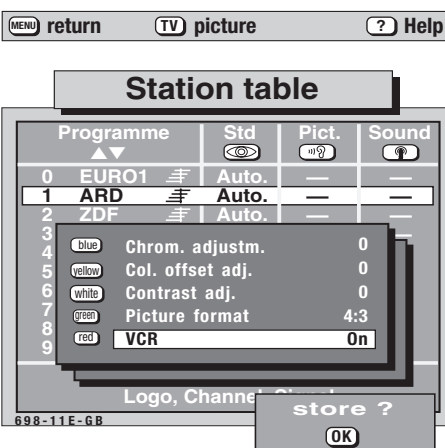
Connecting a video recorder via the aerial socket

- Connect the aerial output (RF-out) of the video recorder to the aerial socket of your TV by means of the aerial cable.
- Load a recorded video cassette in the video recorder.
- Start playback or switch on the test pattern of the video recorder. The test pattern of most video recorders is located within the standard channels Ch 30 to Ch 40 (see operating instructions of the video recorder).
- Execute a station search, beginning with standard channel 25. See Section 3. **Presetting TV stations, station search.**
- If the playback picture or the test pattern of the video recorder is displayed on the screen, then this channel can be stored. See Section 3. **Presetting TV stations.**
- In order to ensure optimum picture quality at all times, select the option „VCR On“. To do so, proceed as described below.

Press this key on the remote control....	The screen displays	Explanation
<p>1. Select the station table and call the picture submenu</p> 		<p>The picture quality of a video film can be improved in a terrestrial programme position with a standard channel.</p> <p>The video signal for this programme position must be set to „Aerial“.</p>
<p>2. Call the second picture submenu and adjust VCR</p> 		<p>To ensure optimum picture quality the „VCR“ function must be switched on.</p> <p>Set the „VCR“ function to „On“ with the  keys and press the  key to store the setting in the programme position.</p> <p>Press the  key to return to the TV picture.</p>

13. Connecting peripheral equipment

Pay-TV decoder

This Pay-TV decoder decodes the scrambled signals of a Pay-TV station (e.g. Premiere) so that they can be displayed on the screen of the TV set. For connection of a Pay-TV decoder, you need a EURO (=Scart) cable in which all 21 pins are assigned.

If you want to record Pay-TV programmes with a video recorder, we recommend that you connect the Pay-TV decoder directly to the video recorder. If this is not possible, the Pay-TV decoder can be connected to the EURO 3 socket (see also „Connecting external devices“ on page 45).

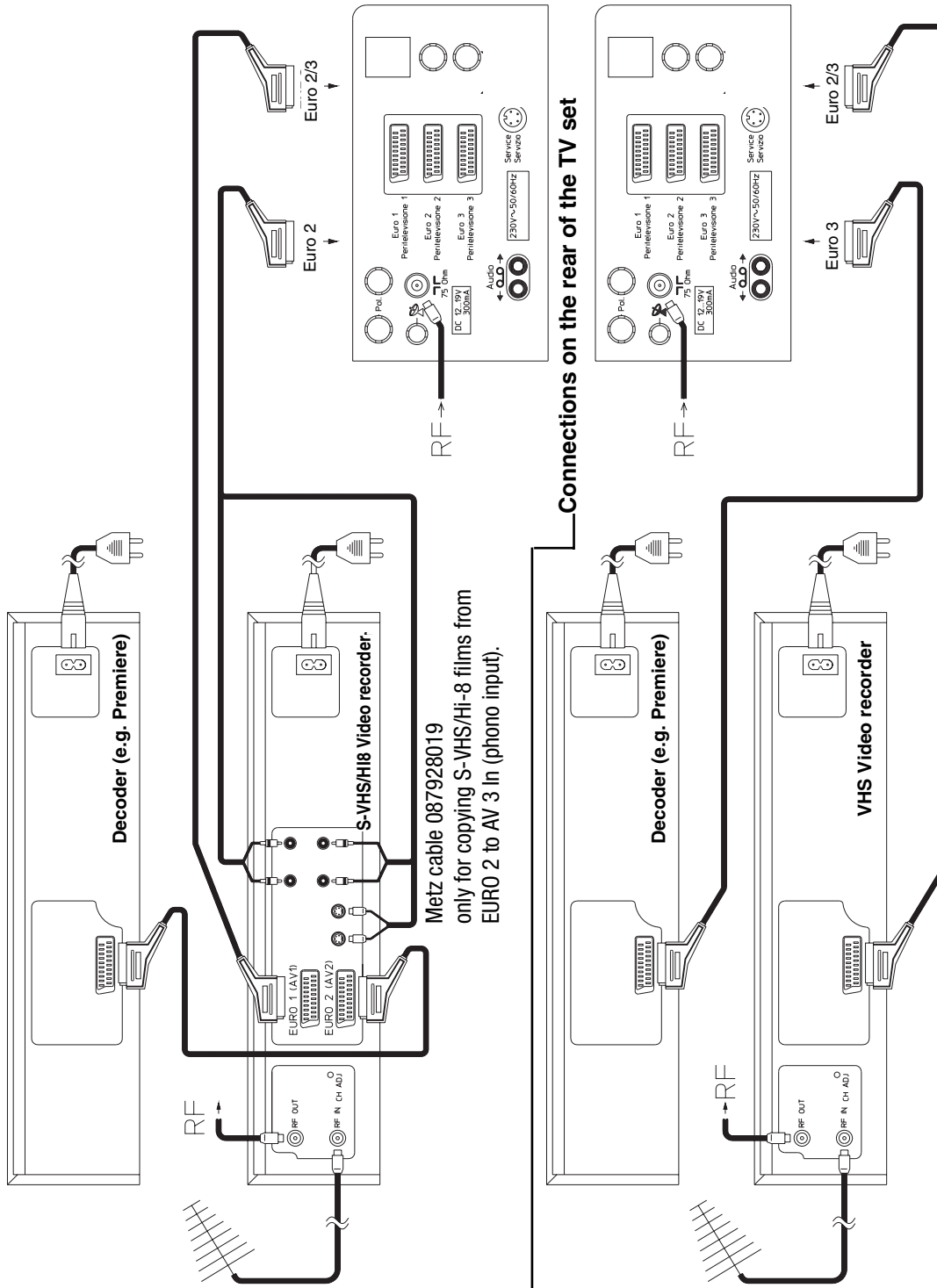

The following diagram shows the connection of a Premiere decoder Typ G2.



13. Connecting peripheral equipment

Pay-TV decoder

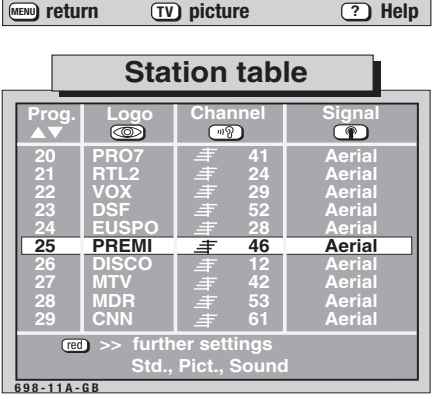
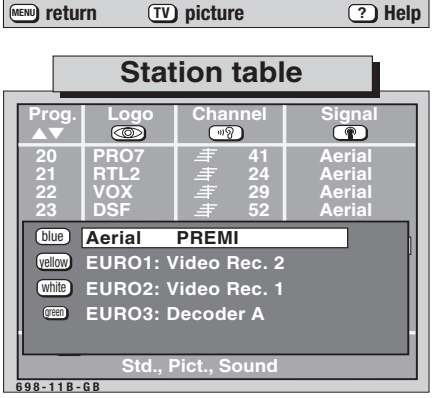
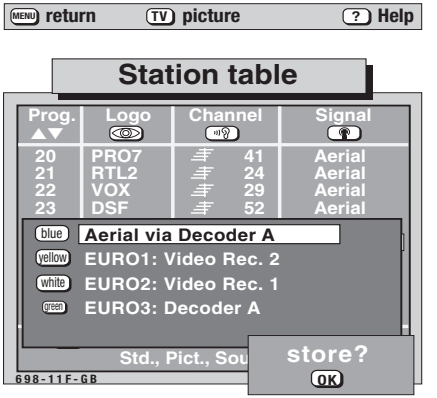
For the following explanation it is assumed that the Pay-TV decoder A (Premiere) is connected to the EURO 3 socket. The following settings must be made on the TV set:

Press this key on the remote control....	The screen displays	Explanation
<p>1. Select the Pay-TV programme position and call the station table</p>		
<p>2. Call the submenu „Signal“</p>		<p>The video signal is normally supplied directly from the aerial.</p>
<p>3. Select video signal „via decoder“</p>		<p>A Pay-TV signal must always be unscrambled in a decoder before it can be displayed on the screen. You can switch between „Aerial direct“ and „Aerial via decoder“ with the aid of the <math>\leftarrow\rightarrow</math> keys.</p>
<p>4. Store the setting and return to TV picture</p>		<p>Note: You can call the Premiere Info-Service only if the RBG priority is set to „Yes“ in the menu „Equipment configuration“. See Section 5. Equipment configuration, RGB priority.</p>

14. Technical data

Mains voltage: 230 V ac, 50/60 Hz
- Australia: 240 V ac

Power consumption:

	Power consumption (to CENELEC/TC 59 X):	Music power output to DIN 45324 at 4 Ohms and 1 kHz (sine output)
all TV-sets	ca. 110 W	2 x 10 W (2 x 6 W)

Consumption of energy per hour: 110 Wh

Standby (all sets): ca. 1.5 W

Aerial input: 75 Ohms, asymmetric DIN 45325
Channel coverage: Standard channels 2...12, 21...69
Special channels S1...S20, S21...S41
S42...S46 (Belgian OIR channels)

14.1 Upgrade kits

- **Multi-standard upgrade kit 031 NB 1038**
For reception of „Standard M“ and „Standard L“ stations.
- **NICAM upgrade kit 041 NB 1048**
- **SAT upgrade kit 082 NB 1014**
SAT receiver to replace the terrestrial receiver.

Contact your dealer for further upgrade kits.

14.2 Maintenance and care

Guarantee

When you purchase the television, ensure that your dealer includes the completed TV „passport“. It must specify the date, the dealer's stamp and signature. Keep this document in a safe place, together with the invoice. Any claims under the warranty will only be accepted if these documents are submitted. Keep your TV clean and handle it with care.

Cleaning the set



Always switch off the TV with the ON/OFF key before you clean it!

Use a soft, dry or slightly moist cloth to clean the cabinet. Do not use any strong detergents as they may damage the finish and labels. Use a damp chamois leather to clean the screen.

Repairs



The TV should only be opened and repaired by qualified service personnel!

CAUTION! DANGER!

Consult your dealer when repairs are necessary.

Any unauthorized attempts to open or repair the TV may result in the guarantee becoming null and void.

Adequate shielding is provided against X-ray radiation (see approval certificate on the rear panel of the TV).

Changing the high voltage or fitting a different type of picture tube may cause an increased amount of X-ray radiation. Televisions modified in such a manner are no longer in keeping with this approval certificate and must not be used!

15. Glossary

2-channel sound transmission:

Separate reproduction of 2 sound channels, e.g. 2 different languages.

Audio

Latin for „I hear“ - The sound frequency range audible to the human ear is between 60 to 20,000 Hz approx.

Camcorder

A video camera with integrated video recorder.

Cinch (phono)

Single-pole plug connector for separate audio and/or video copying.

Decoder

An electronic circuit that decodes TV signals; required to receive coded TV transmissions, such as Premiere.

Dual-Band LNC

An LNC that can simultaneously process two transponder frequency ranges (11 GHz and 12 GHz)

EURO socket assignments:

	S-VHS / Hi8 (= Y/C =S-Video)		VHS (= Video)		RGB
	Input	Output	Input	Output	Input
EURO 1	Yes	No	Yes	No	Yes
EURO 2	Yes	Yes	Yes	Yes	No
EURO 3	No	No	Yes	Yes	No

FBAS = CVBS

C = composite, **V** = video, **B** = blanking, **S** = signal

Function keys - Television:

- *No function*
No function has been assigned to this key.
- *Subtitles*
Displays the subtitle with corresponding transmissions.
- *Large subtitles*
50% enlarged subtitles are displayed with corresponding programmes.
- *Logo*
The display of the station logo is meaningful only if a PIP upgrade kit has been installed.
- *Picture format (variable zoom)*
Changes from 4:3 to 16:9 in the presence of a switching voltage.
- *Zoom 2:1*
The picture can be zoomed to double its size and then back again to 1:1

- *Sound effects*

Spatial sound or stereo wide can be activated or deactivated.

- *Muting - 12 dB*

The sound can be muted by 12 dB.

Function keys - Teletext

- *No function*

No function has been assigned to this key.

- *Riddle solutions*

Display of the hidden answers to riddles

- *Large font*

Doubles the font size in teletext.

- *Stop page*

Running through multiple pages consisting of more than 15 subpages is automatic. This can be stopped at any page with the „Stop page“ key so that „leafing“ can be continued manually.

Noise reduction

Can be switched on to enhance the picture quality.

OSD (On Screen Display)

Convenient display of all functions to adjust the television. They are superimposed on the current programme.

Phono (cinch)

Single-pole plug connector for separate audio and/or video copying.

RGB control

R = red, **G** = green, **B** = blue. Indicates separate colour signal processing.

Spatial sound

Mono transmissions can be reproduced with an artificial stereo effect.

Standard channels

02-12 and 21-69 can be received by way of the aerial and cable system.

Standby mode

The TV has been switched off with the remote control, or it has switched itself off.

Stereo wide

For stereo broadcasts, the distance between the speakers can be increased artificially to achieve a wider stereo effect.

Timer

Used to program automatic recording, or to switch a video recorder or TV automatically on and off at a preset time.

16. Remote control handset for video recorders

The remote controls RB11 are capable of controlling the basic functions of the current series of Metz video recorders. Remember to point the remote control at the video recorder !



In order to permit control of a video recorder, function key B for the TV level must be programmed to „VTR operation“ in the menu „Equipment configuration/Assigning the function keys“ on the TV set.

Whenever a key is pressed, an indicator on the remote **control unit** blinks.

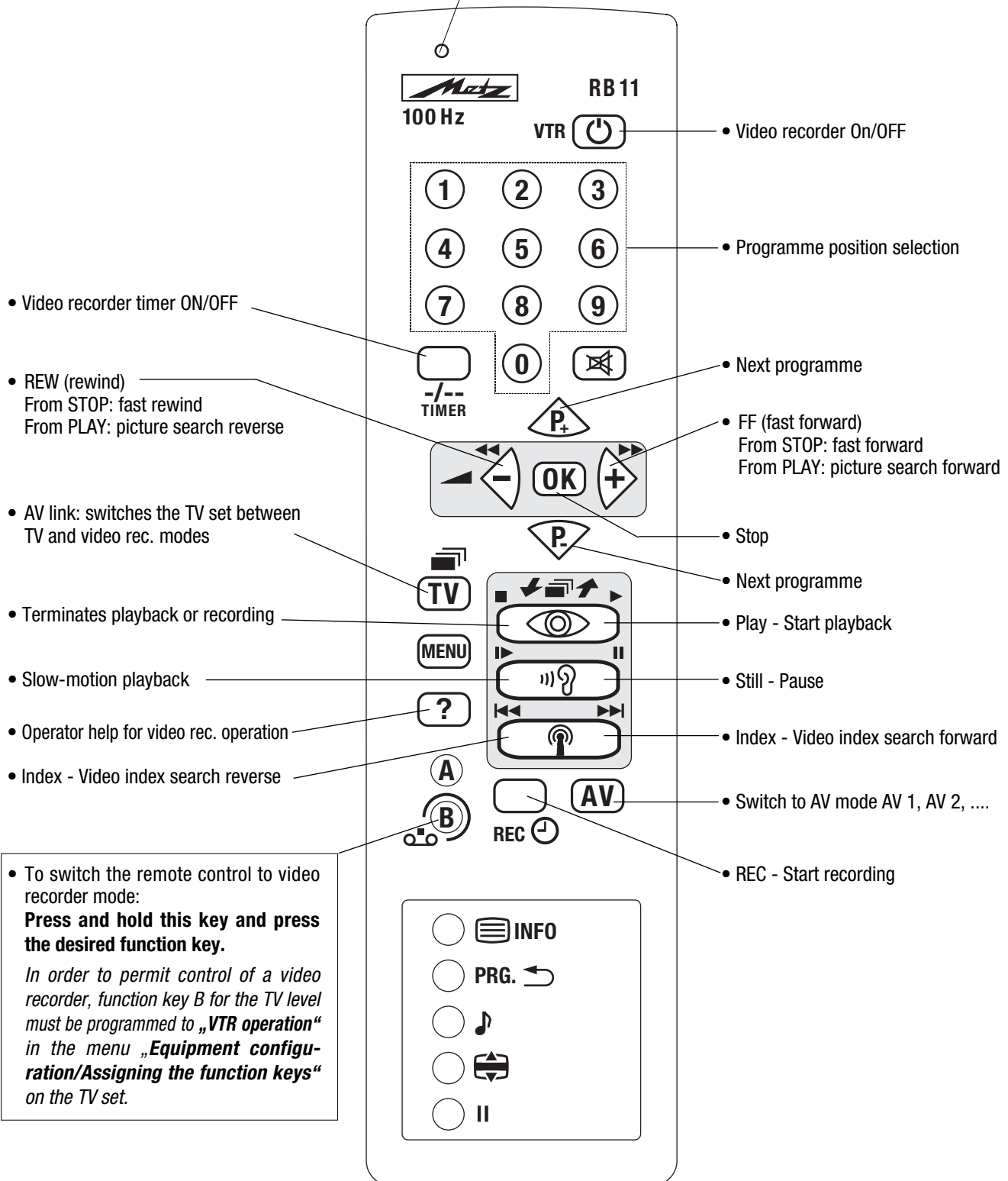

17. Index

- A**ccess to riddle solution40
- Aerial connection4
- Allocating a station logo12
- Audio51
- Audio standard values14
- Autostore function9
- AV equipment, connecting45
- AV recording22

- B**alance13, 14
- Bass13, 14
- Brightness, luminance13, 14

- C**hannel entry8
- Childlock26
- Chrominance, colour intensity13, 14
- Cleaning51
- Code27
- Connecting peripheral equipment43, 44
- Contrast13, 14
- Cooling4
- Copying (programme positions)10
- CTI function21
- CVBS51

- D**irect page selection33
- Double font size35

- E**ntering the time manually24
- Equipment configuration15
- Erasing marks39

- F**BAS (CVBS)51
- Fine tuning11
- Forced mono19
- Frame freeze42
- Function keys15, 51

- G**lossary51

- H**eadphones29

- Infotext3, 36-39

- L**anguage selection5
- Logo12

- M**ains connection4
- Mark-by-mark advance38
- Megatext (Teletext)30

- Moving stations8
- Multiple pages32

- N**oise reduction20, 51

- O**perator help6

- P**age selection by cursor33
- Peripheral equipment44, 45
- Picture format21, 51
- Picture settings13, 22
- Picture sharpness13, 20
- Premiere decoder49, 50
- Presetting stations8
- Programme selection7

- R**eminder time25
- Remote control3
- RGB priority18
- Riddle solutions key40

- S**etting marks36
- Sorting stations10
- Sound channels1/229
- Sound effects13
- Sound mute3, 13
- Spatial sound17, 51
- Standby5
- Station closedown5
- Station search8
- Stereo wide17
- Stop page32, 51
- Subtitles40
- Switch ON/OFF time25

- T**hunderstorms4
- Time settings24
- Timer28
- Treble14
- TV menu5, 6

- V**ariable zoom41
- Video recorder, connecting43-47
- Video signal47
- Video standard values13
- Volume13, 14
- Volume adjustment18

Subject to technical changes. Errors and omissions excepted.



TV. VIDEO. AUDIO. MECABLITZ



Quality – A matter of principle.

With the trend-setting Metz technology you will allways make the correct choice.

See your Metz dealer.

He will be happy to demonstrate the current Metz range.



Metz-Werke GmbH & Co KG
Postfach 1267, D-90506 Zirndorf

Internet: www.metz.de
E-Mail: info@metz.de

Availability and technical details
subject to change without notice.



Videorecorder



Camcorder



DVD



Audio



mecablitz

Free Manuals Download Website

<http://myh66.com>

<http://usermanuals.us>

<http://www.somanuals.com>

<http://www.4manuals.cc>

<http://www.manual-lib.com>

<http://www.404manual.com>

<http://www.luxmanual.com>

<http://aubethermostatmanual.com>

Golf course search by state

<http://golfingnear.com>

Email search by domain

<http://emailbydomain.com>

Auto manuals search

<http://auto.somanuals.com>

TV manuals search

<http://tv.somanuals.com>