

MJF-212A™ High-Power Stage Monitor



*Keep these important operating instructions.
Check www.meyersound.com for updates.*

DECLARATION OF CONFORMITY ACCORDING TO ISO/IEC GUIDE 22 AND EN 45014

Manufacturer's Name:

Meyer Sound Laboratories Inc.

Manufacturer's Address:

2832 San Pablo Avenue
Berkeley, CA 94702-2204, USA

declares that the product

Product Name: MJF-212A loudspeaker

Product Options: All

conforms to the following Product Specifications

Safety: EN60065: 2002

IEC60065: 2001

EMC: EN55103-1: 1997 emission¹

EN55103-2: 1997 immunity²

Operation is subject to the following two conditions:

- (1) this device may not cause harmful interference, and
- (2) this device must accept any interference received, including interference that may cause undesired operation.

Supplementary Information

The product herewith complies with the requirements of the Low Voltage Directive 73/23/EEC and the EMC Directive 89/336/EEC.

Office of Quality Manager
Berkeley, California USA
June 1, 2007

European Contact: Your local Meyer Sound dealer or Meyer Sound Germany, GmbH. Carl Zeiss Strasse 13, 56751 Polch, Germany. Telephone: 49.2654.9600.58 Fax: 49.2654.9600.59

Environmental specifications for Meyer Sound Electronics products

Operating temperature	0°C to +45°C
Non-operating temperature	-40°C to +75°C
Humidity	to 95% at 35°C
Operating altitude	to 4600 m (15,000ft)
Non-operating altitude	to 6300 m (25,000ft)
Shock	30 g 11 msec half-sine on each of 6 sides
Vibration	10 Hz to 55 Hz (0.010 peak-to-peak excursion)

Made by Meyer Sound Laboratories
Berkeley, California USA
European Office:
Meyer Sound Lab. GmbH
Carl Zeiss Strasse 13
56751 Polch, Germany



©2007 Meyer Sound. All rights reserved.

MJF-212A™ High-Power Stage Monitor Operating Instructions

The contents of this manual are furnished for informational purposes only, are subject to change without notice, and should not be construed as a commitment by Meyer Sound Laboratories Inc. Meyer Sound assumes no responsibility or liability for any errors or inaccuracies that may appear in this manual. Except as permitted by applicable copyright law, no part of this publication may be reproduced, stored in a retrieval system, or transmitted, in any form or by any means, electronic, mechanical, recording or otherwise, without prior written permission from Meyer Sound.





MJF-212A, Galileo, Compass, Intelligent AC, RMS, and all alphanumeric product names are trademarks of Meyer Sound. Meyer Sound, Meyer Sound MAPP Online, and SIM are registered trademarks of Meyer Sound Laboratories Inc. (Reg. U.S. Pat. & TM. Off.). All third-party trademarks mentioned herein are the property of their respective trademark holders.

Printed in the U.S.A.

Part Number: 05.157.005.02 A

SYMBOLS USED

These symbols indicate important safety or operating features in this booklet and on the chassis:

			
Dangerous voltages: risk of electric shock	Important operating instructions	Frame or chassis	Protective earth ground
Pour indiquer les risques résultant de tensions dangereuses	Pour indiquer important instructions	Masse, châssis	Terre de protection
Zu die gefahren von gefährliche spanning zeigen	Zu wichtige betriebsanweisung und unterhaltsanweisung zeigen	Rahmen oder chassis	Die schutzerde
Para indicar voltajes peligrosos.	Instrucciones importantes de funcionamiento y/o mantenimiento	Armadura o chassis	Tierra proteccionista

IMPORTANT SAFETY INSTRUCTIONS

1. Read these instructions.
2. Keep these instructions.
3. Heed all warnings.
4. Follow all instructions.
5. Do not use this loudspeaker near water.
6. Clean only with dry cloth.
7. Do not block any ventilation openings. Install in accordance with Meyer Sound's installation instructions.
8. Do not install near any heat sources such as radiators, heat registers, stoves, or other apparatus that produce heat.
9. Do not defeat the safety purpose of the grounding-type plug. A grounding-type plug has two blades and a third grounding prong. The third prong is provided for your safety. If the provided plug does not fit into your outlet, consult an electrician for replacement of the obsolete outlet.
10. Protect the power cord from being walked on or pinched, particularly at plugs, convenience receptacles, and the point where they exit from the loudspeaker. The AC mains plug or appliance coupler shall remain readily accessible for operation.
11. Only use attachments/accessories specified by Meyer Sound.
12. Use only with the caster rails or rigging specified by Meyer Sound, or sold with the loudspeaker. Handles are for carrying only.
13. Unplug this loudspeaker during lightning storms or when unused for long periods of time.
14. Refer all servicing to qualified service personnel. Servicing is required when the loudspeaker has been damaged in any way, such as when the power-supply cord or plug has been damaged; liquid has been spilled or objects have fallen into the loudspeaker; rain or moisture has entered the loudspeaker; the loudspeaker has been dropped; or, when for undetermined reasons, the loudspeaker does not operate normally.



CAUTION: To reduce the risk of electric shock, do not expose this loudspeaker to rain or moisture. Do not install the loudspeaker in wet or humid locations without using weather protection equipment from Meyer Sound.

SAFETY SUMMARY

English

- To reduce the risk of electric shock, disconnect the loudspeaker from the AC mains before installing audio cable. Reconnect the power cord only after making all signal connections.
- Connect the loudspeaker to a two-pole, three-wire grounding mains receptacle. The receptacle must be connected to a fuse or circuit breaker. Connection to any other type of receptacle poses a shock hazard and may violate local electrical codes.
- Do not install the loudspeaker in wet or humid locations without using weather protection equipment from Meyer Sound.
- Do not allow water or any foreign object to get inside the loudspeaker. Do not put objects containing liquid on or near the unit.
- To reduce the risk of overheating the loudspeaker, avoid exposing it to direct sunlight. Do not install the unit near heat-emitting appliances, such as a room heater or stove.
- This loudspeaker contains potentially hazardous voltages. Do not attempt to disassemble the unit. The unit contains no user-serviceable parts. Repairs should be performed only by factory-trained service personnel.

Français

- Pour réduire le risque d'électrocution, débrancher la prise principale de l'haut-parleur, avant d'installer le câble d'interface allant à l'audio. Ne rebrancher le bloc d'alimentation qu'après avoir effectué toutes les connections.
- Branchez l'haut-parleur dans une prise de courant à 3 dérivations (deux pôles et la terre). Cette prise doit être munie d'une protection adéquate (fusible ou coupe-circuit). Le branchement dans tout autre genre de prise pourrait entraîner un risque d'électrocution et peut constituer une infraction à la réglementation locale concernant les installations électriques.
- Ne pas installer l'haut-parleur dans un endroit où il y a de l'eau ou une humidité excessive.

- Ne pas laisser de l'eau ou tout objet pénétrer dans l'haut-parleur. Ne pas placer de récipients contenant un liquide sur cet appareil, ni à proximité de celui-ci.
- Pour éviter une surchauffe de l'haut-parleur, conserver-la à l'abri du soleil. Ne pas installer à proximité d'appareils dégageant de la chaleur tels que radiateurs ou appareils de chauffage.
- Ce haut-parleur contient des circuits haute tension présentant un danger. Ne jamais essayer de le démonter. Il n'y a aucun composant qui puisse être réparé par l'utilisateur. Toutes les réparations doivent être effectuées par du personnel qualifié et agréé par le constructeur.

Deutsch

- Um die Gefahr eines elektrischen Schlages auf ein Minimum zu reduzieren, den Lautsprecher vom Stromnetz trennen, bevor ggf. ein Audio-Schnittstellensignal angeschlossen wird. Das Netzkabel erst nach Herstellung aller Signalverbindungen wieder einstecken.
- Der Lautsprecher an eine geerdete zweipolige Dreiphasen-Netzsteckdose anschließen. Die Steckdose muß mit einem geeigneten Abzweigschutz (Sicherung oder Leistungsschalter) verbunden sein. Der Anschluß der unterbrechungsfreien Stromversorgung an einen anderen Steckdosentyp kann zu Stromschlägen führen und gegen die örtlichen Vorschriften verstoßen.
- Der Lautsprecher nicht an einem Ort aufstellen, an dem sie mit Wasser oder übermäßig hoher Luftfeuchtigkeit in Berührung kommen könnte.
- Darauf achten, daß weder Wasser noch Fremdkörper in das Innere den Lautsprecher eindringen. Keine Objekte, die Flüssigkeit enthalten, auf oder neben die unterbrechungsfreie Stromversorgung stellen.
- Um ein Überhitzen dem Lautsprecher zu verhindern, das Gerät vor direkter Sonneneinstrahlung fernhalten und nicht in der Nähe von wärmeabstrahlenden

Haushaltsgeräten (z.B. Heizgerät oder Herd) aufstellen.

- Im Inneren diesem Lautsprecher herrschen potentiell gefährliche Spannungen. Nicht versuchen, das Gerät zu öffnen. Es enthält keine vom Benutzer reparierbaren Teile. Reparaturen dürfen nur von ausgebildetem Kundendienstpersonal durchgeführt werden.

Español

- Para reducir el riesgo de descarga eléctrica, desconecte de la red de voltaje el altoparlante antes de instalar el cable de señal de audio. Vuelva a conectar la alimentación de voltaje una vez efectuadas todas las interconexiones de señalización de audio.
- Conecte el altoparlante a un tomacorriente bipolar y trifilar con neutro de puesta a tierra. El tomacorriente debe estar conectado a la protección de derivación apropiada (ya sea un fusible o un disyuntor). La conexión a cualquier otro tipo de tomacorriente puede constituir peligro de descarga eléctrica y violar los códigos eléctricos locales.
- No instale el altoparlante en lugares donde haya agua o humedad excesiva.
- No deje que en el altoparlante entre agua ni ningún objeto extraño. No ponga objetos con líquidos encima de la unidad ni cerca de ella.
- Para reducir el riesgo de sobrecalentamiento, no exponga la unidad a los rayos directos del sol ni la instale cerca de artefactos que emiten calor, como estufas o cocinas.
- Este altoparlante contiene niveles de voltaje peligrosos en potencia. No intente desarmar la unidad, pues no contiene piezas que puedan ser reparadas por el usuario. Las reparaciones deben efectuarse únicamente por parte del personal de mantenimiento capacitado en la fábrica.

CONTENTS

INTRODUCTION	1
CHAPTER 1: Introducing the MJF-212A High-Power Stage Monitor	3
Advanced MJF-212A Driver Technology	3
Integrated Amplifier and Processing	4
Total System Approach	4
CHAPTER 2: Power Requirements	5
AC Power Distribution	5
Looping and Cabling	5
Power Connector Wiring Conventions	6
Voltage Requirements	6
Current Requirements	7
Electrical Safety Issues	8
CHAPTER 3: Amplification and Audio	9
Audio Input	9
Amplification and Protection Circuitry	9
MJF-212A Interconnections	10
Cabling	10
The Limiting System	10
Low-Frequency Limiter	10
High-Frequency Limiter	10
Cooling System	11
CHAPTER 4: RMS™ Remote Monitoring System	13
Understanding the RMS module	13
Service LED (Red)	13
Service Button	14
Wink LED (green)	14
Reset Button	14
Activity LED (Green)	14
User Interface	14
APPENDIX A: Optional VEAM Multipin Connector	15
APPENDIX B: MJF-212A Specifications and Dimensional Drawings	17

INTRODUCTION

These operating instructions provide important information about the form, features, function, and specifications of the MJF-212A™ high-power stage monitor.

Chapter 1: Introducing MJF-212A provides a general description of MJF-212A and its capabilities and functionality.

Chapter 2: Power Requirements discusses power distribution and voltage and current requirements, as well as electrical safety issues.

Chapter 3: Amplification and Audio will help you understand and harness the power of the MJF-212A amplifier. Amplifier specifications, connectivity, limiting, and the cooling system are all covered.

Chapter 4: RMS™ Remote Monitoring System introduces the optional RMS communication module that can be installed in the MJF-212A amplifier to make use of Meyer Sound's RMS remote monitoring system.

Appendix A: Optional VEAM Multipin Connector includes information on the optional factory-installed VEAM Connector.

Appendix B: Specifications and Dimensional Drawings provides detailed acoustic and electrical specifications for the MJF-212A monitor, along with detailed dimensional drawings.

HOW TO USE THIS MANUAL

As you read this manual, you'll find figures and diagrams to help you understand and visualize what you're reading. You'll also find icons that flag important information or warn you against improper or potentially harmful activities. These icons include:



A **NOTE** identifies an important piece of information relating to the topic under discussion.



A **TIP** offers a helpful tip relevant to the topic at hand.



A **CAUTION** gives notice that an action can have serious consequences and could cause harm to equipment or personnel, delays, or other problems.

Information and specifications are applicable as of the date of this printing. Updates and supplementary information are posted on the Meyer Sound website at:

<http://www.meyersound.com>

You can contact Meyer Sound Technical Support at:

Tel: +1 510 486.1166

Fax: +1 510 486.8356

E-mail: techsupport@meyersound.com

CHAPTER 1: INTRODUCING THE MJF-212A HIGH-POWER STAGE MONITOR

The Meyer Sound MJF-212A is a self-powered stage monitor designed to meet critical monitoring requirements in professional applications. Exhibiting flat amplitude and phase responses and exceptional impulse response, the MJF-212A meets and exceeds the capabilities of conventional stage monitors while offering the simplicity of setup and operation provided by self-powered systems.

The MJF-212A monitor's phase-corrected frequency range of 55 Hz to 18 kHz enables accurate reproduction of both vocals and instruments with high gain before feedback, and provides excellent intelligibility at high output levels with low distortion and no coloration added to the signal. The MJF-212A is engineered to have exceptional low-frequency headroom, which can be helpful in some applications such as the extreme low-frequency demands of high-level drum monitoring. The face of the low-profile cabinet slopes at 40 degrees from the stage to permit optimal placement relative to the talent, while its medium-Q horn provides even coverage in both the horizontal and vertical planes.



Figure 1.1. MJF-212A high-power stage monitor

The MJF-212A is ideal for high-power monitoring with a very low profile for applications that require clear sight lines. With its self-powered advantage, the MJF-212A is equally suited to touring, rental, and fixed installation applications. High power, low profile, and ease of use make it an outstanding performer in large to medium concerts, as well as corporate AV applications and clubs. The MJF-212A produces a peak output of 139 dB SPL with exceptionally flat phase and frequency response.

The cabinet is constructed from premium birch plywood and coated with a durable, textured black finish. It is available in custom color finishes, allowing it to blend in with any environment. A metal grille lined with acoustical black mesh protects the drivers. The rugged MJF-212A includes plastic skids on the bottom of the unit to prevent damage to the enclosure or stage floor.

ADVANCED MJF-212A DRIVER TECHNOLOGY

The MJF-212A monitor and its high-powered drivers were designed and manufactured at Meyer Sound's factory in Berkeley, California.

The low-frequency section features two high-power, 12-inch cone drivers with 4-inch voice coils that easily meet the power requirements of the system. The proprietary drivers employ neodymium magnets for higher efficiency and power handling with reduced weight. The lowest frequency range is reproduced by these high-power drivers mounted in an optimally vented enclosure, working in tandem, and each powered by a dedicated amplifier channel.

The high-frequency section uses a 1.5-inch exit, 4-inch diaphragm compression driver with a neodymium magnet, also powered by a dedicated amplifier channel. The output of the driver is coupled to a symmetrical 50-degree constant-directivity horn, which allows the performer to experience full bandwidth sound at generous distances from the monitor.

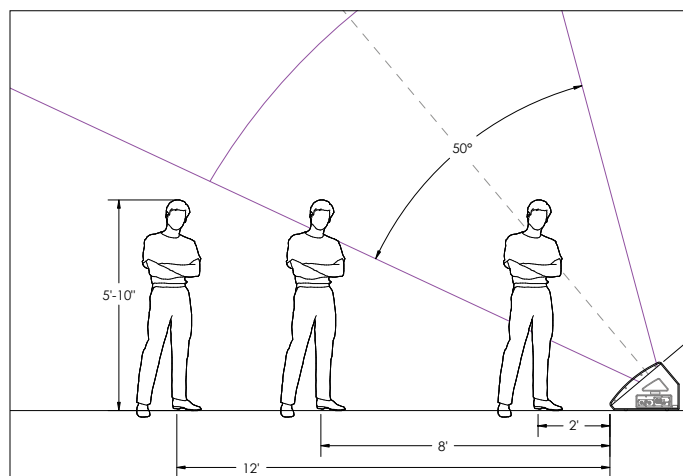

Figure 1.2. MJF-212A coverage, with the performer at 2, 8, and 12 feet from the monitor

INTEGRATED AMPLIFIER AND PROCESSING

As a self-powered loudspeaker, the MJF-212A incorporates a high-power, three-channel, class AB/H power amplifier using complementary power MOSFET output stages. In addition, sophisticated control circuitry is housed within the cabinet, dramatically simplifying setup and installation. To use the MJF-212A, simply supply power distribution to the stage monitor, connect a line level signal, and it's ready — freeing you to focus on mixing instead of making the monitor work.

The on-board amplifier delivers 1275 watts of total burst power (2 x 500 watts, 1 x 275 watts) and 2550 watts peak. Dedicated limiters extend the life of the drivers at very high levels and prevent severe non-linear circumstances.



Figure 1.3. MJF-212A amplifier

This modular, field-replaceable amplifier/processing package also incorporates Meyer Sound's Intelligent AC™ power supply, which automatically adjusts for common line voltage worldwide and provides both soft turn-on and transient protection. The MJF-212A monitor can be optionally fitted with Meyer Sound's exclusive RMS module, allowing you to monitor and troubleshoot an entire RMS-equipped Meyer Sound system remotely from your Windows-based computer.



NOTE: In order to use RMS, you will need Meyer Sound's RMS software, an interface card, and a computer running Windows® 2000/XP or later.



NOTE: Complete acoustical and electrical specifications are covered in Appendix B.

TOTAL SYSTEM APPROACH

The MJF-212A monitor integrates seamlessly with other Meyer Sound products, with compatible acoustical and performance characteristics. Used in conjunction with other Meyer Sound self-powered loudspeakers, the MJF-212A monitor can provide you with everything you need to design and implement complete self-powered systems for optimum performance in venues of any size or shape.

CHAPTER 2: POWER REQUIREMENTS

The MJF-212A monitor combines advanced self-powered loudspeaker technology with equally advanced power capabilities. Understanding the power distribution, voltage, and current requirements, as well as electrical safety issues, is critical to the safe and correct operation and deployment of the MJF-212A monitor. The MJF-212A uses a PowerCon® power connector with a loop output and complies with worldwide product safety standards.

AC POWER DISTRIBUTION

All audio components (self-powered loudspeakers, mixing consoles, processors, etc.) must be properly connected to the AC power distribution, preserving AC line polarity and connecting earth ground such that all grounding points are connected to a single node or common point using the same cable gauge as the neutral and line cables.

 **NOTE:** Improper grounding connections between loudspeakers and the rest of the audio system may produce noise or hum, or cause serious damage to the input and output stages in the system's electronic equipment.

 **CAUTION:** Before applying AC to any Meyer Sound self-powered loudspeaker, make sure that the voltage potential difference between neutral and earth ground is less than 5 V AC.

Figure 2.1 shows a sample three-phase AC distribution system, with the load between loudspeakers distributed among the three phases and all of the loudspeakers connected to common neutral and earth-ground points.

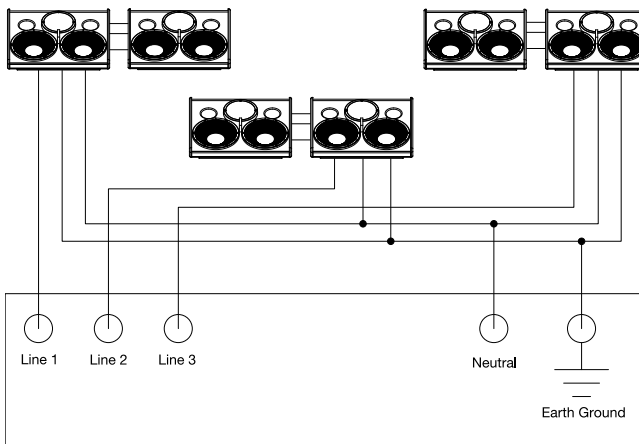



Figure 2.1. A sample AC power distribution block diagram

LOOPING AND CABLING

MJF-212A stage monitors use a PowerCon 3-pole AC mains system with locking connectors to prevent accidental disconnection. Two female inlets (one colored blue and the other gray) are provided. To loop units, simply attach a cable from the gray connector of the first loudspeaker system to the blue connector of the looped unit (Figure 2.2).



Figure 2.2. PowerCon input and loop out AC connectors

 **CAUTION:** A 10-foot blue power connector cable is provided with MJF-212A loudspeakers. This cable is rated for 15 amps. When using it, do not loop more than two MJF-212A loudspeakers from the loop out connector when connected at 115 V (three total in the same circuit), and not more than five when driven at 230 V (six total in the same circuit).

 **CAUTION:** If you replace the AC power cable shipped with the loudspeaker, make sure that you select the correct power plug for the AC power in the area in which you will use the MJF-212A monitor. In addition, the connector must be rated for the load of all the MJF-212As looped to the same power plug.

 **TIP:** A cable-mount gray loop out PowerCon connector is provided with MJF-212A monitor to make looping cables.

The blue input connector serves as the input for **all** the units looped in that circuit and is rated at 20 amps maximum. Please make sure never to exceed 20 amps on any single connector. Refer to Table 2.1.

Table 2.1: Maximum looping capabilities for MJF-212A

Circuit Breaker/ Connector Rating	115 V AC	230 V AC	100 V AC
15 amps	2 Looped-out (3 total)	5 Looped-out (6 total)	1 Looped-out (2 total)
20 amps	3 Looped-out (4 total)	7 Looped-out (8 total)	2 Looped-out (3 total)

CAUTION: Do not exceed the current capability of the 20-amp MJF-212A loudspeaker AC connector. When looping always take into account the current draw of all the speakers in the circuit, **including** the first unit.

NOTE: For best performance, the AC cable voltage drop should not exceed 10 volts, or 10 percent at 115 volts and 5 percent at 230 volts.

POWER CONNECTOR WIRING CONVENTIONS

The MJF-212A monitor requires a grounded outlet. Use the AC cable wiring diagram below (Figure 2.3) to create power connectors.

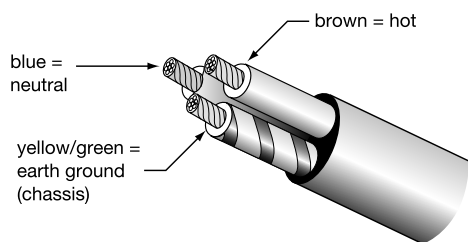

Figure 2.3. AC cable color code

If the colors referred to in the diagrams don't correspond to the terminals in your plug, use the following guidelines:

- Connect the blue wire to the terminal marked with an N or colored black.
- Connect the brown wire to the terminal marked with an L or colored red.
- Connect the green and yellow wire to the terminal marked with an E or colored green or green and yellow.

NOTE: For units shipped with the VEAM all-in-one multipin connector, please refer to Appendix A for AC Power pin-out.

CAUTION: When creating AC cables and distribution systems, it is important to preserve AC line polarity and connect earth ground on both sides of the cable. MJF-212A monitors require a ground connection. Always use a grounded outlet and plug. It is very important that the system be properly grounded in order to operate safely and properly. Do not ground-lift the AC cable.

VOLTAGE REQUIREMENTS

When AC power is applied to the MJF-212A stage monitor, the Intelligent AC power supply automatically selects the correct operating voltage, allowing the unit to be used internationally without manually setting voltage switches or jumpers. In addition to selecting the operating voltage, the Intelligent AC power supply performs the following protective functions to compensate for hostile conditions on the AC mains:

- Suppresses high-voltage transients up to several kilovolts
- Filters common mode and differential mode radio frequencies (EMI)
- Sustains operation temporarily during low-voltage periods
- Provides soft-start power-up, eliminating high inrush current

The MJF-212A stage monitor operates safely and without audio discontinuity if the AC voltage stays within either of two operating windows at 50 or 60 Hz:

- 85 to 134 volts
- 165 to 264 volts

The MJF-212A can withstand continuous voltages up to 275 volts and allows any combination of voltage to GND (that is neutral-line-ground or line-line-ground).

CAUTION: Continuous voltages higher than 275 volts can damage the unit.



TIP: Since the MJF-212A does not require a dedicated neutral, it can tolerate elevated voltages from ground and can be connected between line-line terminals in a 120 V 3-phase Wye system. This results in 208 V AC between lines (nominal) and will therefore draw less current for the same output power compared to operating a MJF-212A from 120 V AC (line-neutral). Make sure that the voltage remains within MJF-212A's recommend operating window (180 V AC to 250 V AC). The ground terminal must always be used for safety and the line to ground voltage should never exceed 250 V AC (typically there will be 120 V AC from line to ground in the above example).

After applying AC power, the proper operating voltage is automatically selected, but the system is muted. During the next three seconds the following events occur:

1. The main power supply slowly ramps on.
2. The green Active LED on the user panel lights up, indicating that the system is enabled and ready to pass audio signals.



CAUTION: If the Active LED does not illuminate or if the system does not respond to audio input after 10 seconds, remove AC power immediately. Verify that the voltage is within the proper range. If the problem persists, please contact Meyer Sound or an authorized service center.

If voltage drops below the low boundary of either safe operating range (brownout), the MJF-212A monitor uses stored energy to continue functioning briefly, and shuts down only if voltage does not rise above the low boundary before the loudspeaker's storage circuits are depleted. How long the monitor continues to function during brownout depends on the amount of voltage drop and the audio source level during the drop. If the voltage increases above the upper boundary of either range, the power supply rapidly turns off to prevent damage to the unit.



NOTE: If voltage fluctuates within either operating range, automatic tap selection stabilizes the internal operating voltage. This tap selection is instantaneous, and there are no audible artifacts.

If the MJF-212A monitor shuts down due to either low or high voltage, its power supply automatically turns on again after three seconds if the voltage has returned to either normal operating window. If the MJF-212A stage monitor does not turn back on after 10 seconds, remove AC power immediately (see previous Caution).



NOTE: It is recommended that the supply be operated in the rated voltage windows at least a few volts away from the turn on/off points. This ensures that AC voltage variations from the service entry — or peak voltage drops due to cable runs — do not cause the amplifier to cycle on and off.

CURRENT REQUIREMENTS

The current draw for the MJF-212A monitor is dynamic and fluctuates as its operating levels change. Since different cables and circuit breakers heat up at varying rates, it is essential to understand the types of current ratings and how they correspond to circuit breaker and cable specifications.

The *maximum long-term continuous current* is the maximum rms current during a period of at least ten seconds. It is used to calculate the temperature increase in cables in order to select a cable size and gauge that conforms to electrical code standards, and to select the rating for slow-reacting thermal breakers.

This rating is also used to calculate the looping capabilities of MJF-212A.

The *burst current* is the maximum rms current during a period of approximately one second, used to select the rating of most magnetic breakers and to calculate the peak voltage drop in long AC cables according to the formula:

$$V_{pk}(\text{drop}) = I_{pk} \times R(\text{cable total})$$

The *ultimate short-term peak current* is used to select the rating of fast-reacting magnetic breakers

Use Table 2.2 as a guide when selecting cable gauge size and circuit breaker ratings for your operating voltage.

Table 2.2: MJF-212A Current Ratings

Current Draw	115 V AC	230 V AC	100 V AC
Idle current	.650 A rms	.310 A rms	.760 A rms
Max. long-term continuous (>10 sec)	4.67 A rms	2.37 A rms	5.25 A rms
Burst current (1 sec)	7.90 A rms	4.10 A rms	9.24 A rms
Ultimate short-term peak	20.0 A pk	10.0 A pk	21.8 A pk



CAUTION: When looping MJF-212A monitors, always take into account the current draw of **all** the loudspeakers looped in the circuit, **including** the first unit, to select the cable gauge that will avoid voltage drops.



NOTE: For best performance, the AC cable voltage drop should not exceed 10 volts, or 10 percent at 115 volts and 5 percent at 230 volts. Make sure that even with the AC voltage drop, the AC voltage always stays in the operating windows.

The minimum electrical service amperage required by an MJF-212A system is the sum of each loudspeaker's *maximum long-term continuous current*. An additional 30 percent above the minimum amperage is recommended to prevent peak voltage drops at the service entry.

ELECTRICAL SAFETY ISSUES

Pay close attention to these important electrical and safety issues.



CAUTION: In the unlikely event that the circuit breakers on the monitor's user panel trip (the white center buttons pop out), disconnect the AC power cable. Do not reset the breakers with the AC connected. Contact Meyer Sound for repair information.



CAUTION: The MJF-212A monitor requires a grounded connection. Always use a grounded outlet and plug.



CAUTION: Do not use a ground-lifting adapter or cut the AC cable ground pin.

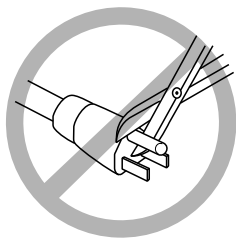
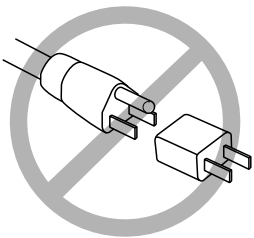

CAUTION: Do not exceed the current capability of the monitor's 20-amp AC connector. When looping, always take into account the current draw of all loudspeakers on the circuit, **including** the first unit.



CAUTION: Make sure that the power plug is appropriate for the AC power at the site where you will operate the MJF-212A monitor. In addition, the connector must be rated for the total load of **all** MJF-212A loudspeakers looped to the same power plug.

CHAPTER 3: AMPLIFICATION AND AUDIO

More than just a self-powered stage monitor, the MJF-212A uses sophisticated amplification and protection circuitry and an advanced limiting system to produce consistent and predictable results in any system design. This chapter will help you understand and harness the power of the MJF-212A monitor's amplifier and audio systems.

AUDIO INPUT

The MJF-212A stage monitor presents a 10 kOhm balanced input impedance to a three-pin XLR connector with the following connections:

- Pin 1 — 220 kOhm to chassis and earth ground (ESD and RF clamped)
- Pin 2 — Signal (+)
- Pin 3 — Signal (-)
- Case — Earth (AC) ground and chassis



CAUTION: Shorting an input connector pin to the case can form a ground loop and cause hum.

Pins 2 and 3 carry the input as a differential signal; pin 2 is hot relative to pin 3, resulting in a positive pressure wave when a positive signal is applied to pin 2. Pin 1 is connected to earth through a 220 kOhm, 1000 pF, 15 V clamp network.

This ingenious circuit provides virtual ground lift at audio frequencies, while allowing unwanted signals to bleed to ground. Use standard audio cables with XLR connectors for balanced signal sources. Make sure that pin 1 (shield) is always connected on both ends of the cable. Telescoping grounding schemes are not recommended.



CAUTION: Make sure that all cabling carrying signals to MJF-212A monitors in a looped system is wired correctly: Pin 1 to Pin 1, Pin 2 to Pin 2, and so forth, to prevent the polarity from being reversed.



TIP: If abnormal noises such as hissing and popping are produced by the loudspeaker, disconnect the audio cable from the loudspeaker. If the noise stops, most likely the problem is not with the loudspeaker. Check the audio cable, source, and AC power to pinpoint the problem.

Audio signals can be daisy-chained using the Loop output connector on the user panel of the MJF-212A stage monitor (Figure 3.1). A single source can drive multiple MJF-212A monitors with a paralleled input loop, creating an unbuffered hard-wired loop connection.



Figure 3.1. Side panel audio input connectors

When driving multiple MJF-212A loudspeakers in a system, make certain that the source device can drive the total load impedance required by the paralleled input circuit. The source device must be capable of producing 20 dBV (10 volts rms into 600 ohms) in order to produce the maximum peak SPL over the operating bandwidth of the loudspeaker.

To avoid distortion, make sure the source device provides an adequate drive circuit design for the total paralleled load impedance of the system.



NOTE: Meyer Sound's Galileo™ loudspeaker management system is highly recommended. In addition to maintaining signal integrity for long cable paths, it offers independent outputs and filters to help you optimize performance.



NOTE: For details on the MJF-212A monitor's audio input characteristics and amplification, see Appendix B.

AMPLIFICATION AND PROTECTION CIRCUITRY

The MJF-212A is powered by Meyer Sound MJF amplifier modules in a three-channel amplifier configuration with a total power of 1275 watts (2550 watts peak). The MJF amplifier utilizes complementary-power MOSFET output stages (class AB/H). The specific functions for the MJF-212A stage monitor such as crossover point, frequency and phase response, and driver protection are determined by the control card installed in one of the MJF amplifier modules.

CAUTION: Please note that the amplifier for the MJF-212A monitor is different from those found in other Meyer Sound loudspeakers. Specific functions for each model, such as crossover points, frequency and phase correction, and driver protection are determined by the control cards installed inside the amplifier. Do not exchange amplifiers between the MJF-212A and M'elodie or other Meyer Sound loudspeakers.

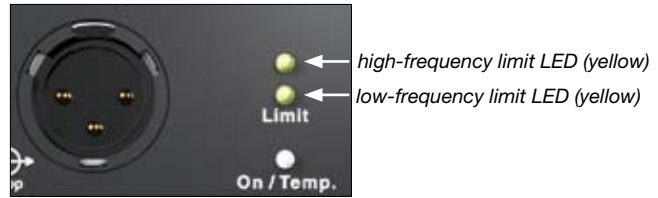

Figure 3.2: The limit LEDs on the side user panel indicate high- and low-frequency limiter activity

MJF-212A INTERCONNECTIONS

The two 2-ohm, 12-inch, low-frequency cone drivers are each powered with 500 watts from two MJF channels of the MJF-212A amplifier. The 4-inch diaphragm, 8-ohm, high-frequency compression driver is powered with 275 watts from the third MJF channel.

All Meyer Sound loudspeakers are tested and shipped with the drivers in correct alignment. If a driver needs to be replaced, make sure the replacement is reinstalled with the correct polarity.

CAUTION: Failure to connect a replacement driver using the proper polarity will result in severe degradation in frequency and phase response and can harm the drivers and amplifier.

High-Frequency Limiter

The 4-inch diaphragm, high-frequency compression driver is powered by a single channel with its own detector. The upper limit LED is used to indicate any limiting activity for the high-frequency driver. When engaged, the limiter not only protects the driver, but also prevents signal peaks from causing excessive distortion in the amplifier channel, preserving headroom and maintaining smooth frequency response at high levels. When the level returns to normal — below the limiter's threshold — the limiter ceases operation.

TIP: The MJF-212A monitor has a side panel with another set of Limit LEDs so the status of the monitor can be conveniently viewed from either side of the stage.

CABLING

The MJF-212A system uses three separate cables and connectors per cabinet for the AC line current, signal, and RMS data (if installed). However, the three can be consolidated to create a “multi-cable” by looming them together for quick connection to each cabinet. As an alternative, units can be ordered from the factory with VEAM all-in-one connectors. (Refer to Appendix A for more information on VEAM.)



Figure 3.3: Limit LEDs on the side of the cabinet mirror the limiter activity of the user panel on the opposite side

THE LIMITING SYSTEM

Low-Frequency Limiter

The MJF-212A monitor's left and right 12-inch cone drivers are powered by separate amplifier channels, each with a detector but routed to one limiter. The lower limit LED on the user panel indicates limiting activity for these two drivers. When the level for both low channels returns to normal — below the limiter's threshold — the limiter will cease operation.

CAUTION: The limit LEDs indicate when the safe power level is exceeded. If any channel on an MJF-212A monitor begins to limit before reaching the required sound pressure level (SPL), consider adding more monitors to satisfy the SPL requirements. This will avoid exposing the drivers on that channel to excessive heat and/or excursion, reducing the life-span of the drivers and electronics.

The MJF-212A is performing within its acoustical specifications and operating at a normal temperature if the limit LEDs are lit for no longer than two seconds, and then go off for at least one second. If an LED remains on for longer than three seconds, that channel enters **hard limiting**, with the following negative consequences:

- Increasing input level will not increase volume.
- Distortion increases due to clipping and nonlinear driver operation.
- The lifespan of the driver is reduced because it is subjected to excessive heat and/or excursion, and eventual damage over time may occur.



NOTE: The limiting circuitry utilizes optical limiters that add no noise and have no effect on the signal when the limiter is not engaged and the LED is inactive.

COOLING SYSTEM

The MJF-212A amplifier modules rely solely on natural convection for cooling. The heatsinks used in the amplifier modules allow natural convection cooling from air flowing over them. The efficient design of the amplifier and heatsink profile helps keep the temperature on the amplifier low even when the monitors are being used at high ambient temperature, in tightly packed conditions, and/or at high continuous levels.

If the temperature of the heatsink reaches 75° C (167° F), the On/Temp LED on the rear panel turns from green (On) to red (Temp). The unit continues to operate normally even if the On/Temp LED is red, but this is an indication that the unit is reaching its maximum dissipation. A reduction of the SPL is recommended at this point.



NOTE: In the highly unlikely event that the heatsink temperature reaches 95° C (203° F), the MJF-212A monitor automatically shuts down until AC power is removed to allow the heatsink to cool down. If the MJF-212A loudspeaker shuts down again after cooling and reapplying AC power, contact Meyer Sound for repair information.



CAUTION: The heatsink can reach temperatures of up to 95° C (203° F) during extreme, high-level operation for extended periods of time. Use caution when approaching the rear of the cabinet.



CAUTION: To keep the heatsink from getting too hot, make sure there is proper ventilation around the loudspeaker.

When the heatsink temperature decreases to 65° C (145° F), the On/Temp LED changes from red to green.



CAUTION: If loudspeakers in a system begin to shut down due to excessive heatsink temperatures before reaching the required SPL, consider adding more monitors to satisfy the SPL requirements.





TIP: The RMS remote monitoring system can be used to monitor both limiting and the temperature of the heatsinks. Refer to Chapter 4: RMS Remote Monitoring System for more information.

CHAPTER 4: RMS REMOTE MONITORING SYSTEM

RMS is a real-time monitoring system that connects Meyer Sound self-powered loudspeakers with a Windows-based PC at the sound mix position or other location. Optional RMS software delivers extensive status and system performance data from every installed loudspeaker. The MJF-212A monitor is RMS-ready and can be upgraded by installing an RMS communication board in its user panel.

RMS allows the monitoring of amplifier voltages, limiting activity, power output, temperature, driver status, warning alerts, and other key data for up to 62 loudspeakers without a network repeater. Data is updated 2–5 times per second.

 **NOTE:** Optional loudspeaker Mute and Solo functions are helpful for acoustic setup or troubleshooting. A jumper is installed in the RMS communication board inside the MJF-212A amplifier to enable Mute and/or Solo functionality. To use these features, the software needs to be enabled.

 **NOTE:** The RMS software allows you to disable Mute and Solo functions to eliminate any chance of an operator error (a muting error, for example). However, these functions can be disabled permanently by removing the jumper in the RMS communication board.

 **NOTE:** RMS does not control AC power.

Loudspeakers are identified on the network by Node Names assigned during a one-time “commission” into the RMS database that resides on your computer (as a part of the software), as shown in Figure 4.1. This information is permanently retained on each RMS communication board and in the computer RMS database until you modify it. Loudspeaker View labels can be modified at any time, allowing you to customize how you view the data.

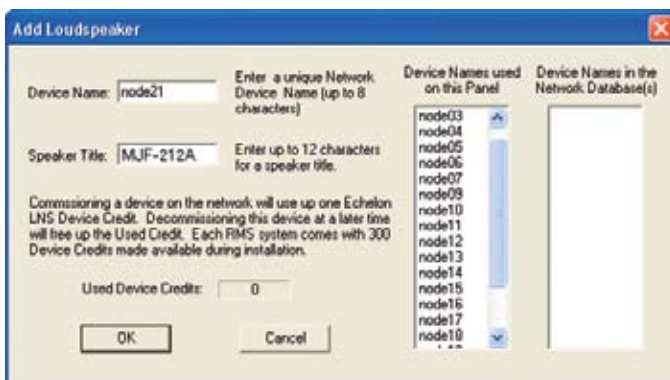

Figure 4.1. Commissioning an MJF-212A loudspeaker using RMS

Two-way communication between the RMS software and the MJF-212A monitor makes identifying and matching loudspeakers and icons easy. Pressing the “service” button on the MJF-212A loudspeaker’s RMS module will help quickly identify the MJF-212A in the RMS software window; an icon corresponding to its Node Name will appear on screen. In addition, clicking on the icon’s Wink command will turn on the LED labeled “Wink” on the MJF-212A’s RMS module. This way any MJF-212A can be easily identified from the RMS software.

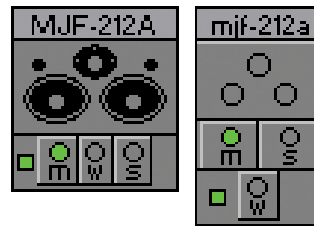

Figure 4.2. MJF-212A RMS icon

UNDERSTANDING THE RMS MODULE

When upgraded, the MJF-212A’s user panel contains an RMS communications module, as shown in Figure 4.3.



Figure 4.3. The RMS communications module

The RMS module has three LEDs and two buttons. Their functions are described below and on the following page.

 **NOTE:** The LEDs and buttons on the RMS communications module shown in Figure 4.3 are used **exclusively** by RMS, and have no effect on the acoustical and/or electrical activity of the MJF-212A monitor — unless Mute or Solo is enabled at the board and from the RMS software.

Service LED (Red)

The Service LED blinks every two seconds to indicate that the network hardware is operational, but the loudspeaker is not installed (commissioned) on the network.

 **NOTE:** The Service LED indicates that the stage monitor is not commissioned on the network and has no effect on the acoustical and/or electrical activity of the MJF-212A. The monitor must be commissioned on a network using the RMS software for the service LED to stop blinking.

When a loudspeaker has been installed on the network, the Service LED will be unlit and the Activity LED will flash continuously.

 **NOTE:** When continuously lit, the Service LED indicates that the loudspeaker has had a local RMS hardware failure. In this case, the RMS communications module may be damaged and you should contact Meyer Sound Technical support.

Service Button

Pressing the Service Button will display an icon on the corresponding loudspeaker display on the RMS screen. When used in combination with the Reset Button, the card will be decommissioned from the network and the red Service LED will blink.

Wink LED (green)

When lit, the Wink LED indicates that an ID signal has been sent from the host station computer to the loudspeaker. This is accomplished using the Wink button on the loudspeaker Icon, Meter, or Text views in the RMS monitoring program.

Reset Button

Pressing the Reset Button will cause the firmware code within the RMS card to reboot. However, the commissioning state of the card will not change (this is stored in flash memory). When used in combination with the Service Button, the card will be decommissioned from the network and the red Service LED will blink.

Activity LED (Green)

When the loudspeaker has been commissioned, the Activity LED will flash continuously. When the Activity LED is unlit, the loudspeaker has not been installed on the network.

USER INTERFACE

The RMS software features an intuitive, graphical Windows user interface. As mentioned earlier, each loudspeaker appears on the computer's color monitor as a View in the form of a status icon, bar graph meter, or text meter (numerical values), depending on your preferences.

Each View contains loudspeaker identification information and data from the amplifier, controller, drivers, and power supply of that particular unit. System status conditions cause changes in icon and bar graph indicators, alerting the operator to faults or excessive levels. The views are moveable and are typically arranged on the screen to reflect the physical layout of the loudspeakers. You can design a screen "panel" of icons or meters, as shown in Figure 4.4, and save it on the computer's hard drive, with the panel conveniently named for a unique arrangement or performer.

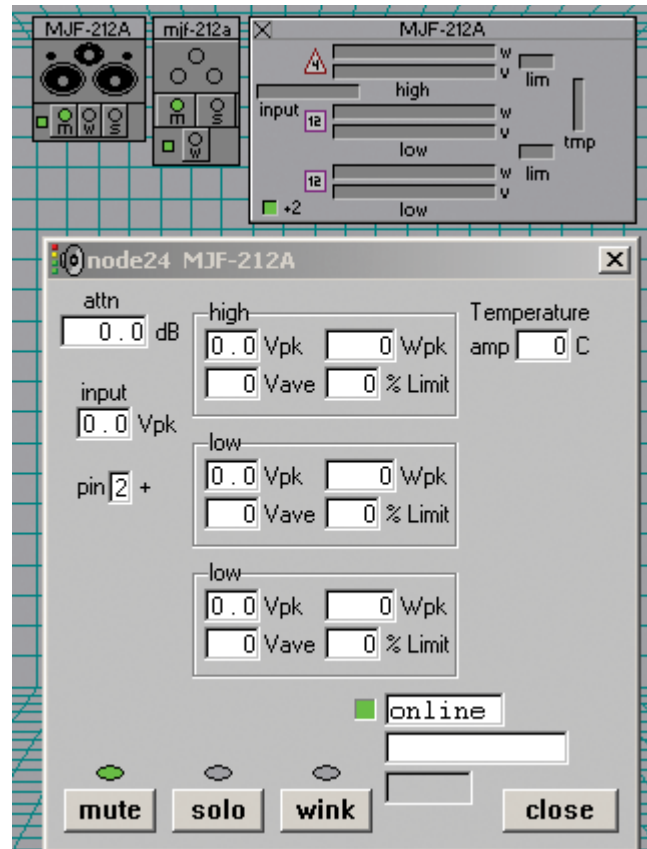



Figure 4.4. The RMS user interface

If the loudspeaker installation pattern changes completely, a new screen panel can be built. If a different subset of installed loudspeakers will be used for a subsequent show, only selected loudspeakers need to appear on the monitoring screen for that performance.

 **NOTE:** For more information on RMS, please refer to the RMS User Guide included with the software, or visit www.meyersound.com.

APPENDIX A: OPTIONAL VEAM MULTIPIN CONNECTOR

The MJF-212A monitor requires a grounded outlet. It is very important that the system be properly grounded in order to operate safely and properly. Figure A.1 illustrates correct wiring for the creation of power cables and distribution systems for MJF-212A stage monitors shipped from the factory with the VEAM multipin connector.

For complete wiring conventions and pin-outs for AC, audio, and RMS connections, please refer to the Meyer Sound document VEAM Cable Wiring Reference (PN 06.033.113.01).

In addition, Meyer Sound offers the VIM-4 (VEAM interface module) with four VEAM connectors in the front and a single-phase IEC 309 32-amp connector in the rear to distribute power, audio, and RMS to MJF-212A monitoring systems fitted with VEAM connectors.

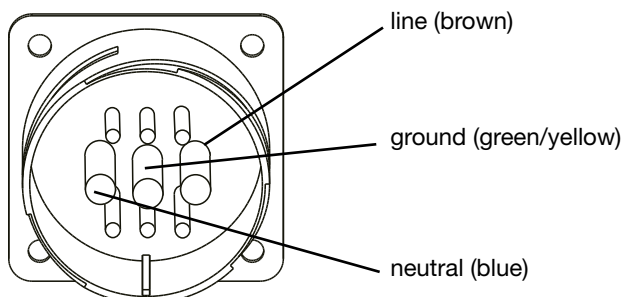

Figure A.1. VEAM multipin connector power pin-out

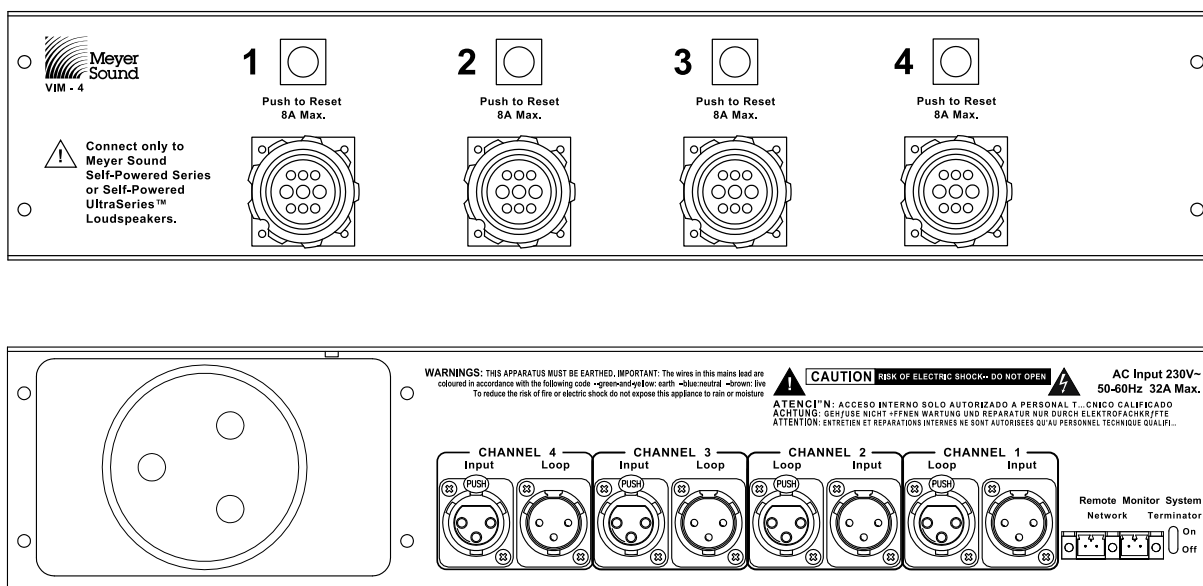

Figure A.2. VIM-4 module, front (top) and rear (bottom)

APPENDIX B: MJF-212A SPECIFICATIONS AND DIMENSIONAL DRAWINGS

ACOUSTICAL	
Note: Recommended maximum operating frequency range. Response depends on loading conditions and room acoustics.	
Operating frequency range	55 Hz – 18 kHz Note: Recommended maximum operating frequency range. Response depends on loading conditions and room acoustics.
Frequency response	60 Hz – 16 kHz ± 4 dB Note: Half-space loading measured with 1/3-octave frequency resolution at 4 meters.
Phase response	500 Hz – 16 kHz $\pm 45^\circ$
Maximum peak SPL	139 dB Note: Measured with music, half-space loading, referred to 1 meter.
Dynamic range	>110 dB
Coverage	50° symmetrical
Acoustical crossover	1600 Hz Note: At this frequency, the transducers produce equal sound pressure levels.
TRANSDUCERS	
Low/low-mid frequency	Two high-power 12" cone drivers with neodymium magnets Nominal impedance: 2 Ω Voice coil size: 4" Power handling capability: 1200 W (AES) Note: Power handling is measured under AES standard conditions: transducers driven continuously for two hours with band limited noise signal having a 6 dB peak-average ratio.
High frequency	4" compression driver Nominal impedance: 8 Ω Voice coil size: 4" Diaphragm size: 4" Exit size: 1.5" Power handling capability: 250 W (AES) Note: Power handling is measured under AES standard conditions: transducers driven continuously for two hours with band limited noise signal having a 6 dB peak-average ratio.

AUDIO INPUT	
Type	Differential, electronically balanced
Max. common mode range	± 15 V DC, clamped to earth for voltage transient protection
Connectors	Female XLR input with male XLR loop output or VEAM all-in-one connector (integrates AC, audio, and network)
Input impedance	10 k Ω differential between pins 2 and 3
Wiring	Pin 1: Chassis/earth through 220 k Ω , 1000 pF, 15 V clamp network to provide virtual ground lift at audio frequencies Pin 2: Signal + Pin 3: Signal – Case: Earth ground and chassis
DC Blocking	Differential DC blocking up to maximum common mode voltage
CMRR	>50 dB, typically 80 dB (50 Hz – 500 Hz)
RF filter	Common mode: 425 kHz Differential mode: 142 kHz
TIM filter	<80 kHz, integral to signal processing
Nominal input sensitivity	0 dB V (1 V rms, 1.4 V pk) continuous is typically the onset of limiting for noise and music.
Input level	Audio source must be capable of producing +20 dBV (10 V rms, 14 V pk) into 600 Ω in order to produce maximum peak SPL over the operating bandwidth of the loudspeaker
AMPLIFIERS	
Amplifier type	Three-channel complementary MOSFET output stages (class AB/H)
Output power	1275 W (three channels; 2 x 500 W, 1 x 275 W); 2550 W peak
	Note: Amplifier wattage rating based on the maximum unclipped burst sine-wave rms voltage that the amplifier will produce for at least 0.5 seconds into the nominal load impedance.
THD, IM TIM	< .02%
Load capacity	2 Ω low channels; 8 Ω high channel
Cooling	Convection
AC POWER	
AC power connector	PowerCon with looping output or VEAM
Voltage selection	Automatic, two ranges, each with high-low voltage tap (uninterrupted)
Safety agency rated operating voltage	95 V AC – 125 V AC, 208 V AC – 235 V AC, 50/60 Hz
Turn on/turn off points	85 V AC – 134 V AC; 165 V AC – 264 V AC
<i>Current Draw</i>	
Idle current	.650 A rms (115 V AC); .310 A rms (230 V AC); .760 A rms (100 V AC)
Max. long-term continuous current (>10 sec)	4.67 A rms (115 V AC); 2.37 A rms (230 V AC); 5.25 A rms (100 V AC)
Burst Current (<1 sec)	7.90 A rms (115 V AC); 4.10 A rms (230 V AC); 9.24 A rms (100 V AC)
	Note: AC power cabling must be of sufficient gauge so that under burst current RMS conditions, cable transmission losses do not drop voltage below specified operating range at the speaker.
Ultimate Short-Term Peak Current Draw	20.0 A pk (115 V AC); 10.0 A pk (230 V AC); 21.8 A pk (100 V AC)
Inrush Current	10 A pk (115 and 100 V AC); 18 A pk (230 V AC)
RMS NETWORK (Optional)	
	Equipped with two-conductor twisted-pair network, reporting all operating parameters of amplifiers to system operator's host computer.

PHYSICAL

Enclosure	Premium birch plywood
Finish	Black textured
Protective grille	Powder-coated, hex-stamped steel, black mesh
Dimensions	27.07" w x 16.11" h x 23.00" d (688 mm x 409 mm x 584 mm)
Weight	108 lbs (49 kg)

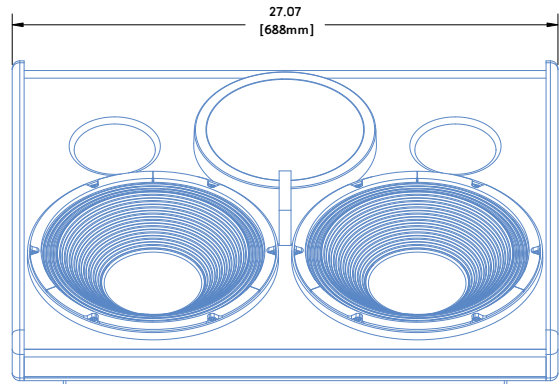
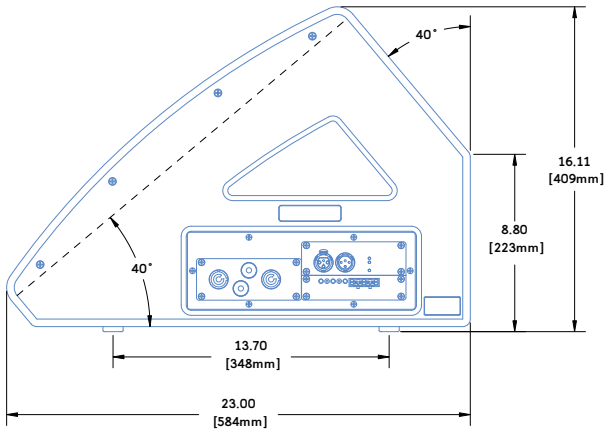



Meyer Sound Laboratories Inc.
2832 San Pablo Avenue
Berkeley, CA 94702

www.meyersound.com
T: +1 510 486.1166
F: +1 510 486.8356

©2007
Meyer Sound Laboratories Inc.
05.157.005.02 A

Free Manuals Download Website

<http://myh66.com>

<http://usermanuals.us>

<http://www.somanuals.com>

<http://www.4manuals.cc>

<http://www.manual-lib.com>

<http://www.404manual.com>

<http://www.luxmanual.com>

<http://aubethermostatmanual.com>

Golf course search by state

<http://golfingnear.com>

Email search by domain

<http://emailbydomain.com>

Auto manuals search

<http://auto.somanuals.com>

TV manuals search

<http://tv.somanuals.com>