

P35 Neo/ G33 Neo series

MS-7360 (V1.X) Mainboard

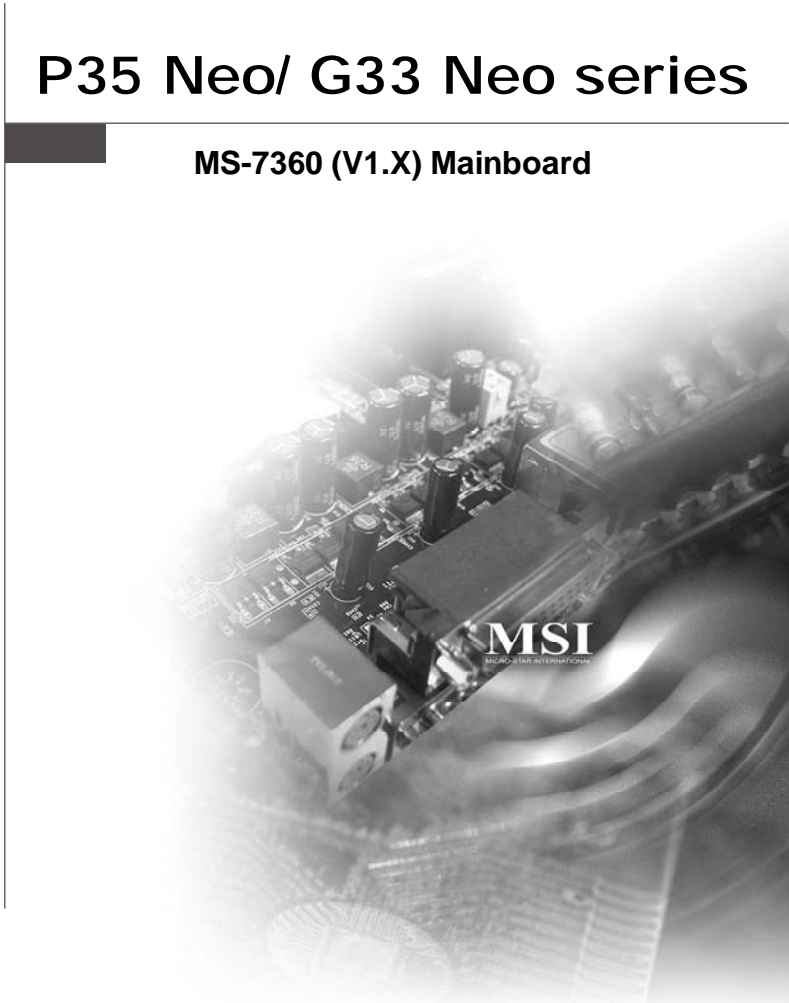

G52-73601X1

Copyright Notice

The material in this document is the intellectual property of **MICRO-STAR INTERNATIONAL**. We take every care in the preparation of this document, but no guarantee is given as to the correctness of its contents. Our products are under continual improvement and we reserve the right to make changes without notice.

Trademarks

All trademarks are the properties of their respective owners.

NVIDIA, the NVIDIA logo, DualNet, and nForce are registered trademarks or trademarks of NVIDIA Corporation in the United States and/or other countries.

AMD, Athlon™, Athlon™ XP, Thoroughbred™, and Duron™ are registered trademarks of AMD Corporation.

Intel® and Pentium® are registered trademarks of Intel Corporation.

PS/2 and OS®/2 are registered trademarks of International Business Machines Corporation.

Windows® 95/98/2000/NT/XP are registered trademarks of Microsoft Corporation.

Netware® is a registered trademark of Novell, Inc.

Award® is a registered trademark of Phoenix Technologies Ltd.

AMI® is a registered trademark of American Megatrends Inc.

Revision History

Revision	Revision History	Date
V1.0	First release for P35/G33 Neo Series	March 2007

Technical Support

If a problem arises with your system and no solution can be obtained from the user's manual, please contact your place of purchase or local distributor. Alternatively, please try the following help resources for further guidance.

- 🔍 Visit the MSI website for FAQ, technical guide, BIOS updates, driver updates, and other information: http://www.msi.com.tw/program/service/faq/faq/esc_faq_list.php
- 🔍 Contact our technical staff at: <http://support.msi.com.tw/>

Safety Instructions

1. Always read the safety instructions carefully.
2. Keep this User's Manual for future reference.
3. Keep this equipment away from humidity.
4. Lay this equipment on a reliable flat surface before setting it up.
5. The openings on the enclosure are for air convection hence protects the equipment from overheating. **DO NOT COVER THE OPENINGS.**
6. Make sure the voltage of the power source and adjust properly 110/220V before connecting the equipment to the power inlet.
7. Place the power cord such a way that people can not step on it. Do not place anything over the power cord.
8. Always Unplug the Power Cord before inserting any add-on card or module.
9. All cautions and warnings on the equipment should be noted.
10. Never pour any liquid into the opening that could damage or cause electrical shock.
11. If any of the following situations arises, get the equipment checked by service personnel:
 - † The power cord or plug is damaged.
 - † Liquid has penetrated into the equipment.
 - † The equipment has been exposed to moisture.
 - † The equipment does not work well or you can not get it work according to User's Manual.
 - † The equipment has dropped and damaged.
 - † The equipment has obvious sign of breakage.
12. **DO NOT LEAVE THIS EQUIPMENT IN AN ENVIRONMENT UNCONDITIONED, STORAGE TEMPERATURE ABOVE 60°C (140°F), IT MAY DAMAGE THE EQUIPMENT.**



CAUTION: Danger of explosion if battery is incorrectly replaced. Replace only with the same or equivalent type recommended by the manufacturer.



警告使用者:
這是甲類的資訊產品，在居住的環境中使用時，可能會造成無線電干擾，在這種情況下，使用者會被要求採取某些適當的對策。



廢電池請回收

For better environmental protection, waste batteries should be collected separately for recycling or special disposal.

FCC-B Radio Frequency Interference Statement

This equipment has been tested and found to comply with the limits for a Class B digital device, pursuant to Part



15 of the FCC Rules. These limits are designed to provide reasonable protection against harmful interference in a residential installation. This equipment generates, uses and can radiate radio frequency energy and, if not installed and used in accordance with the instructions, may cause harmful interference to radio communications. However, there is no guarantee that interference will not occur in a particular installation. If this equipment does cause harmful interference to radio or television reception, which can be determined by turning the equipment off and on, the user is encouraged to try to correct the interference by one or more of the measures listed below.

- † Reorient or relocate the receiving antenna.
- † Increase the separation between the equipment and receiver.
- † Connect the equipment into an outlet on a circuit different from that to which the receiver is connected.
- † Consult the dealer or an experienced radio/television technician for help.

Notice 1

The changes or modifications not expressly approved by the party responsible for compliance could void the user's authority to operate the equipment.

Notice 2

Shielded interface cables and A.C. power cord, if any, must be used in order to comply with the emission limits.

VOIR LANOTICE D'INSTALLATIONAVANT DE RACCORDER AU RESEAU.



This device complies with Part 15 of the FCC Rules. Operation is subject to the following two conditions:

- (1) this device may not cause harmful interference, and*
- (2) this device must accept any interference received, including interference that may cause undesired operation.*

WEEE (Waste Electrical and Electronic Equipment) Statement



ENGLISH

To protect the global environment and as an environmentalist, MSI must remind you that...

Under the European Union ("EU") Directive on Waste Electrical and Electronic Equipment, Directive 2002/96/EC, which takes effect on August 13, 2005, products of "electrical and electronic equipment" cannot be discarded as municipal waste anymore and manufacturers of covered electronic equipment will be obligated to take back such products at the end of their useful life. MSI will comply with the product take back requirements at the end of life of MSI-branded products that are sold into the EU. You can return these products to local collection points.

DEUTSCH

Hinweis von MSI zur Erhaltung und Schutz unserer Umwelt

Gemäß der Richtlinie 2002/96/EG über Elektro- und Elektronik-Altgeräte dürfen Elektro- und Elektronik-Altgeräte nicht mehr als kommunale Abfälle entsorgt werden. MSI hat europaweit verschiedene Sammel- und Recyclingunternehmen beauftragt, die in die Europäische Union in Verkehr gebrachten Produkte, am Ende seines Lebenszyklus zurückzunehmen. Bitte entsorgen Sie dieses Produkt zum gegebenen Zeitpunkt ausschließlich an einer lokalen Altgerätesammelstelle in Ihrer Nähe.

FRANÇAIS

En tant qu'écologiste et afin de protéger l'environnement, MSI tient à rappeler ceci...

Au sujet de la directive européenne (EU) relative aux déchets des équipements électriques et électroniques, directive 2002/96/EC, prenant effet le 13 août 2005, que les produits électriques et électroniques ne peuvent être déposés dans les décharges ou tout simplement mis à la poubelle. Les fabricants de ces équipements seront obligés de récupérer certains produits en fin de vie. MSI prendra en compte cette exigence relative au retour des produits en fin de vie au sein de la communauté européenne. Par conséquent vous pouvez retourner localement ces matériels dans les points de collecte.

РУССКИЙ

Компания MSI предпринимает активные действия по защите окружающей среды, поэтому напоминаем вам, что...

В соответствии с директивой Европейского Союза (ЕС) по предотвращению загрязнения окружающей среды использованным электрическим и электронным оборудованием (директива WEEE 2002/96/EC), вступающей в силу 13 августа 2005 года, изделия, относящиеся к электрическому и электронному оборудованию, не могут рассматриваться как бытовой мусор, поэтому производители вышеперечисленного электронного оборудования обязаны принимать его для переработки по окончании срока службы. MSI обязуется соблюдать требования по приему продукции, проданной под маркой MSI на территории ЕС, в переработку по окончании срока службы. Вы можете вернуть эти изделия в специализированные пункты приема.

ESPAÑOL

MSI como empresa comprometida con la protección del medio ambiente, recomienda:

Bajo la directiva 2002/96/EC de la Unión Europea en materia de desechos y/o equipos electrónicos, con fecha de rigor desde el 13 de agosto de 2005, los productos clasificados como "eléctricos y equipos electrónicos" no pueden ser depositados en los contenedores habituales de su municipio, los fabricantes de equipos electrónicos, están obligados a hacerse cargo de dichos productos al término de su período de vida. MSI estará comprometido con los términos de recogida de sus productos vendidos en la Unión Europea al final de su período de vida. Usted debe depositar estos productos en el punto limpio establecido por el ayuntamiento de su localidad o entregar a una empresa autorizada para la recogida de estos residuos.

NEDERLANDS

Om het milieu te beschermen, wil MSI u eraan herinneren dat...

De richtlijn van de Europese Unie (EU) met betrekking tot Vervuiling van Electriche en Electronische producten (2002/96/EC), die op 13 Augustus 2005 in zal gaan kunnen niet meer beschouwd worden als vervuiling.

Fabrikanten van dit soort producten worden verplicht om producten retour te nemen aan het eind van hun levenscyclus. MSI zal overeenkomstig de richtlijn handelen voor de producten die de merknaam MSI dragen en verkocht zijn in de EU. Deze goederen kunnen geretourneerd worden op lokale inzamelingspunten.

SRPSKI

Da bi zaštitili prirodnu sredinu, i kao preduzeće koje vodi računa o okolini i prirodnoj sredini, MSI mora da vas podesti da...

Po Direktivi Evropske unije ("EU") o odbačenju elektronskoj i električnoj opremi, Direktiva 2002/96/EC, koja stupa na snagu od 13. Avgusta 2005, proizvodi koji spadaju pod "elektronsku i električnu opremu" ne mogu više biti odbačeni kao običan otpad i proizvođači ove opreme biće prinudeni da uzmu natrag ove proizvode na kraju njihovog uobičajenog veka trajanja. MSI će poštovati zahtev o preuzimanju ovakvih proizvoda kojima je istekao vek trajanja, koji imaju MSI oznaku i koji su prodati u EU. Ove proizvode možete vratiti na lokalnim mestima za prikupljanje.

POLSKI

Aby chronić nasze środowisko naturalne oraz jako firma dbająca o ekologię, MSI przypomina, że...

Zgodnie z Dyrektywą Unii Europejskiej ("UE") dotyczącą odpadów produktów elektrycznych i elektronicznych (Dyrektywa 2002/96/EC), która wchodzi w życie 13 sierpnia 2005, tzw. "produkty oraz wyposażenie elektryczne i elektroniczne" nie mogą być traktowane jako śmieć komunalne, tak więc producenci tych produktów będą zobowiązani do odbierania ich w momencie gdy produkt jest wycofywany z użycia. MSI wypełni wymagania UE, przyjmując produkty (sprzedawane na terenie Unii Europejskiej) wycofywane z użycia. Produkty MSI będzie można zwracać w wyznaczonych punktach zbiorczych.

TÜRKÇE

Çevreci özelliğiyle bilinen MSI dünyada çevreyi korumak için hatırlatır:

Avrupa Birliği (AB) Kararnamesi Elektrik ve Elektronik Malzeme Atığı, 2002/96/EC Kararnamesi altında 13 Ağustos 2005 tarihinden itibaren geçerli olmak üzere, elektrikli ve elektronik malzemeler diğer atıklar gibi çöpe atılmayacak ve bu elektronik cihazların üreticileri, cihazların kullanım süreleri bittikten sonra ürünleri geri toplamakla yükümlü olacaktır, Avrupa Birliği'ne satılan MSI markalı ürünlerin kullanım süreleri bittiğinde MSI ürünlerin geri alınması isteği ile işbirliği içerisinde olacaktır. Ürünlerinizi yerel toplama noktalarına bırakabilirsiniz.

ČESKY

Záleží nám na ochraně životního prostředí - společnost MSI upozorňuje...

Podle směrnice Evropské unie ("EU") o likvidaci elektrických a elektronických výrobků 2002/96/EC platné od 13. srpna 2005 je zakázáno likvidovat "elektrické a elektronické výrobky" v běžném komunálním odpadu a výrobci elektronických výrobků, na které se tato směrnice vztahuje, budou povinni odebírat takové výrobky zpět po skončení jejich životnosti. Společnost MSI splní požadavky na odebrání výrobků značky MSI, prodávaných v zemích EU, po skončení jejich životnosti. Tyto výrobky můžete odevzdat v místních sběrnách.

MAGYAR

Annak érdekében, hogy környezetünket megvédjük, illetve környezetvédőként fellépve az MSI emlékezteti Önt, hogy ...

Az Európai Unió („EU”) 2005. augusztus 13-án hatályba lépő, az elektromos és elektronikus berendezések hulladékairól szóló 2002/96/EK irányelve szerint az elektromos és elektronikus berendezések többé nem kezelhetők lakossági hulladékként, és az ilyen elektronikus berendezések gyártói kötelessé válnak az ilyen termékek visszavételére azok hasznos élettartama végén. Az MSI betartja a termékvisszavétellel kapcsolatos követelményeket az MSI márkánév alatt az EU-n belül értékesített termékek esetében, azok élettartamának végén. Az ilyen termékeket a legközelebbi gyűjtőhelyre viheti.

ITALIANO

Per proteggere l'ambiente, MSI, da sempre amica della natura, ti ricorda che....

In base alla Direttiva dell'Unione Europea (EU) sullo Smaltimento dei Materiali Elettrici ed Elettronici, Direttiva 2002/96/EC in vigore dal 13 Agosto 2005, prodotti appartenenti alla categoria dei Materiali Elettrici ed Elettronici non possono più essere eliminati come rifiuti municipali: i produttori di detti materiali saranno obbligati a ritirare ogni prodotto alla fine del suo ciclo di vita. MSI si adegnerà a tale Direttiva ritirando tutti i prodotti marchiati MSI che sono stati venduti all'interno dell'Unione Europea alla fine del loro ciclo di vita. È possibile portare i prodotti nel più vicino punto di raccolta.

CONTENTS

Copyright Notice	ii
Trademarks	ii
Revision History	ii
Technical Support	ii
Safety Instructions	iii
FCC-B Radio Frequency Interference Statement	iv
WEEE (Waste Electrical and Electronic Equipment) Statement	v
Chapter 1 Getting Started	1-1
Mainboard Specifications	1-2
Mainboard Layout	1-4
Packing Checklist	1-5
Chapter 2 Hardware Setup	2-1
Quick Components Guide	2-2
CPU (Central Processing Unit)	2-3
Memory	2-7
Power Supply	2-9
Back Panel	2-12
Connectors	2-14
Jumper	2-19
Slots	2-20
Chapter 3 BIOS Setup	3-1
Entering Setup	3-2
The Main Menu	3-4
Standard CMOS Features	3-6
Advanced BIOS Features	3-9
Integrated Peripherals	3-11
Power Management Setup	3-13
PNP/PCI Configurations	3-16
H/W Monitor	3-18
Frequency/Voltage Control	3-19
Load Fail-Safe/ Optimized Defaults	3-23
BIOS Setting Password	3-24
Appendix A Dual Core Center	A-1
Activating Dual Core Center	A-2
Main	A-3
DOT(Dynamic Over Clocking)	A-5

Clock	A-6
Voltage	A-7
FAN Speed	A-8
Temperature	A-9
User Profile	A-10
Appendix B Realtek ALC888 Audio	B-1
Installing the Realtek Audio Driver	B-2
Software Configuration	B-4
Hardware Setup	B-19

Chapter 1

Getting Started

Thank you for choosing the P35 Neo/ G33 Neo Series (MS-7360 v1.X) ATX mainboard. The P35 Neo/ G33 Neo Series mainboards are based on **Intel® P35/G33 & ICH9/ ICH9R** chipsets for optimal system efficiency. Designed to fit the advanced **Intel®** Core 2 Extreme, Core 2 Quad, Core 2 Duo, Pentium and Celeron processor, the P35 Neo/ G33 Neo Series deliver a high performance and professional desktop platform solution.

Mainboard Specifications

Processor Support

- Intel® Core 2 Extreme, Core 2 Quad, Core 2 Duo, Pentium and Celeron in the LGA775 package
(For the latest information about CPU, please visit <http://www.msi.com.tw/cpusupport.htm>)

Supported FSB

- 1333/ 1066/ 800 MHz

Chipset

- North Bridge: Intel® P35/ G33 (optional)
- South Bridge: Intel® ICH9/ ICH9R (optional)

Memory Support

- DDR2 667/800 SDRAM (240pin/ non-ECC)
- 4 DDR2 DIMMs (8GB Max)
(For more information on compatible components, please visit <http://www.msi.com.tw/testreport.htm>)

LAN

- Supports Giga LAN 10/100/1000 Fast Ethernet by Realtek RTL8111B

IEEE 1394(optional)

- Chip integrated by VIA VT6308
- Transfer rate is up to 400Mbps

Audio

- Controlled by Realtek ALC888
- Supports 7.1 channels audio out
- Compliant with Azalia Spec

IDE

- 1 IDE port controlled by Marvell 88SE6111
- Supports Ultra DMA 66/100/133, PIO & Bus Master operation mode

SATA

- 4 SATA ports (SATA1~4) are controlled by ICH9
- 6 SATA ports (SATA1~6) are controlled by ICH9R
- SATA 7 is controlled by Marvell 88SE6111 (optional)
- Supports storage and data transfers at up to 300 MB/s

RAID

- SATA1~6 support RAID 0/ 1/ 0+1/ 5 or JBOD mode (for ICH9R only)

Floppy

- 1 floppy port
- Supports 1 FDD with 360KB, 720KB, 1.2MB, 1.44MB and 2.88MB

Connectors

● **Back panel**

- 1 PS/2 mouse port
- 1 PS/2 keyboard port
- 1 Parallel port supporting SPP/EPP/ECP mode
- 1 serial port (COM1)
- 1 VGA port (for G33 Neo series only)
- 1 IEEE1394 port (optional)
- 4 USB 2.0 Ports
- 1 LAN jack
- 6 audio jacks

● **On-Board Pinheaders**

- 4 USB 2.0 pinheaders
- 1 IEEE1394 pinheader (optional)
- 1 Chassis Intrusion Switch pinheader
- 1 Front Panel Audio pinheader
- 1 CD-In pinheader
- 1 SPDIF-out pinheader

Slots

- 1 PCI Express x 16 slot
- 3 PCI Express x 1 slots
- 2 PCI slots, support 3.3V/ 5V PCI bus Interface

Form Factor

- ATX (30.5 cm X 22.0 cm)

Mounting

- 6 mounting holes

Mainboard Layout

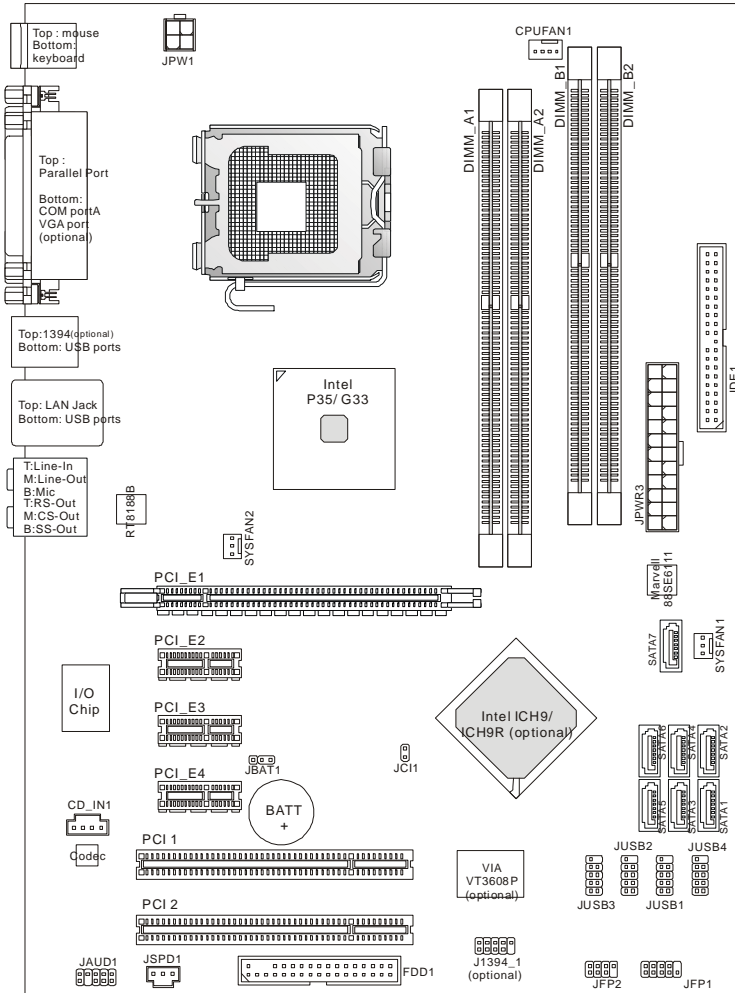

P35 Neo/ G33 NeoSeries (MS-7360 v1.X) ATX Mainboard

Packing Checklist

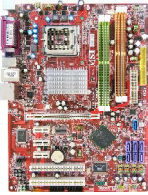

MSI motherboard

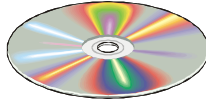

MSI Driver/Utility CD



Standard Cable for IDE Devices (Optional)



Power Cable



SATA Cable



USB Bracket (Optional)



Back IO Shield



1394 Bracket (Optional)



User's Guide

* The pictures are for reference only and may vary from the packing contents of the product you purchased.

Chapter 2

Hardware Setup

This chapter provides you with the information about hardware setup procedures. While doing the installation, be careful in holding the components and follow the installation procedures. For some components, if you install in the wrong orientation, the components will not work properly.

Use a grounded wrist strap before handling computer components. Static electricity may damage the components.

Quick Components Guide

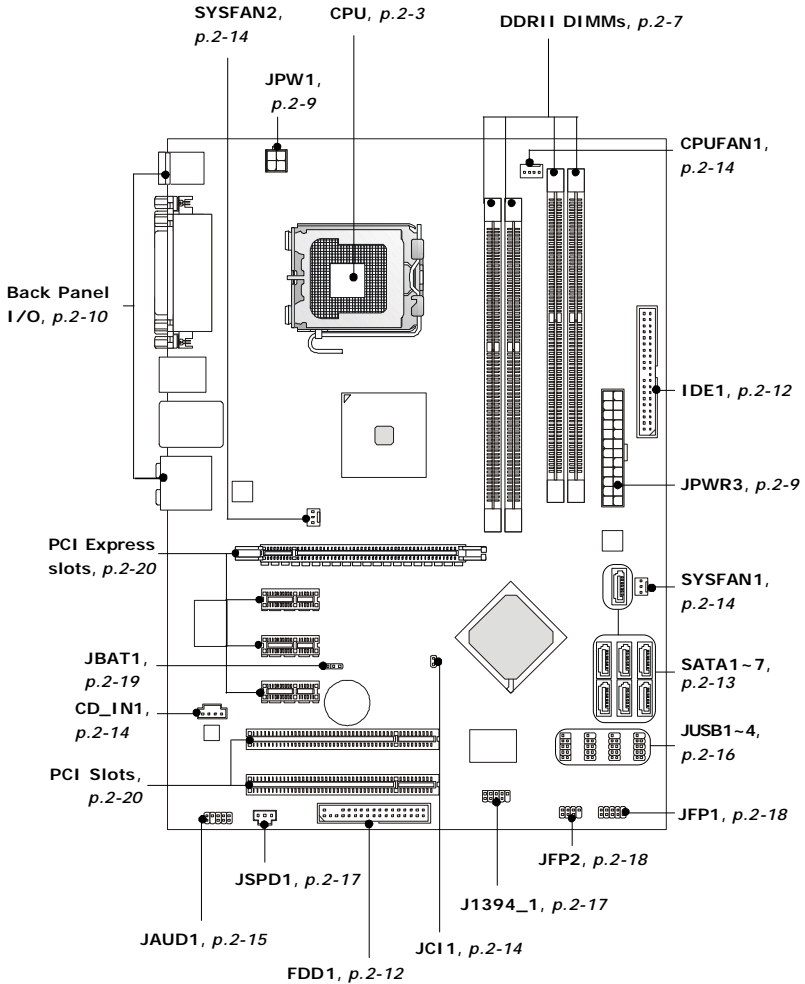

CPU (Central Processing Unit)

This mainboard supports Intel® Core 2 Extreme, Core 2 Quad, Core 2 Duo, Pentium and Celeron processor in LGA 775 package. When you are installing the CPU, **make sure to install the cooler to prevent overheating.** If you do not have the CPU cooler, consult your dealer before turning on the computer. For the latest information about CPU, please visit <http://www.msi.com.tw/testreport.htm>



Important

Overheating

Overheating will seriously damage the CPU and system. Always make sure the cooling fan can work properly to protect the CPU from overheating. Make sure that you apply an even layer of thermal paste (or thermal tape) between the CPU and the heatsink to enhance heat dissipation.

Replacing the CPU

While replacing the CPU, always turn off the ATX power supply or unplug the power supply's power cord from the grounded outlet first to ensure the safety of CPU.

Overclocking

*This mainboard is designed to support overclocking. However, please make sure your components are able to tolerate such abnormal setting, while doing overclocking. Any attempt to operate beyond product specifications is not recommended. **We do not guarantee the damages or risks caused by inadequate operation or beyond product specifications.***

Introduction to LGA 775 CPU

The pin-pad side of LGA 775 CPU.

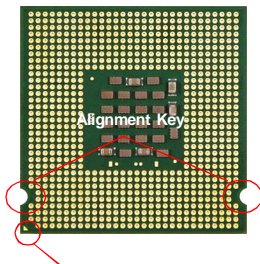

Yellow triangle is the Pin 1 indicator

The surface of LGA 775 CPU. Remember to apply some thermal paste on it for better heat dispersion.

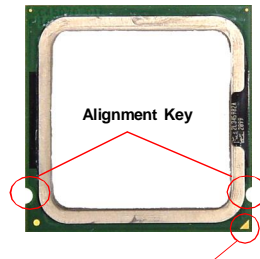

Yellow triangle is the Pin 1 indicator

CPU & Cooler Installation

When you are installing the CPU, **make sure the CPU has a cooler attached on the top to prevent overheating**. Meanwhile, do not forget to apply some thermal paste on CPU before installing the heat sink/cooler fan for better heat dispersion. Follow the steps below to install the CPU & cooler correctly. Wrong installation will cause the damage of your CPU & mainboard.

1. The CPU socket has a plastic cap on it to protect the contact from damage. Before you install the CPU, always cover it to protect the socket pin.
2. Remove the cap from lever hinge side (as the arrow shows).

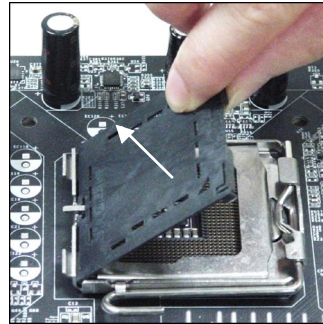
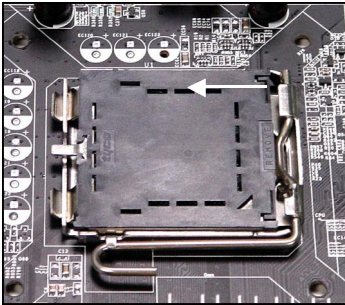

3. The pins of socket reveal.

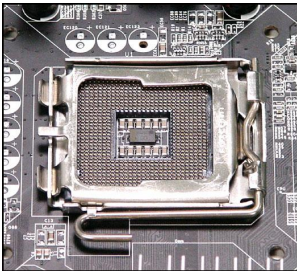

4. Open the load lever.

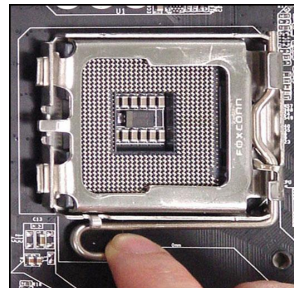

Important

1. Confirm if your CPU cooler is firmly installed before turning on your system.
2. Do not touch the CPU socket pins to avoid damaging.
3. The availability of the CPU land side cover depends on your CPU packing.

5. Lift the load lever up and open the load plate.

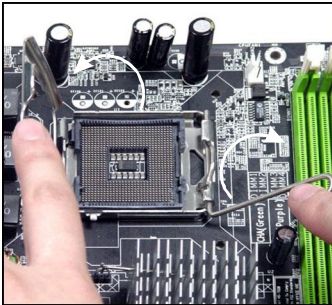

6. After confirming the CPU direction for correct mating, put down the CPU in the socket housing frame. Be sure to grasp on the edge of the CPU base. Note that the alignment keys are matched.

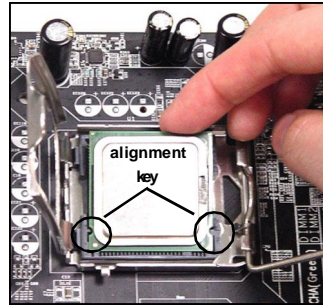

7. Visually inspect if the CPU is seated well into the socket. If not, take out the CPU with pure vertical motion and reinstall.

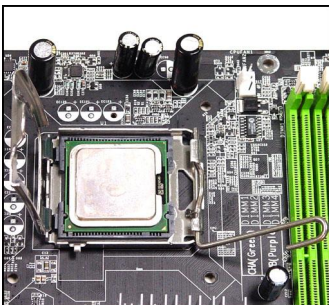

8. Cover the load plate onto the package.

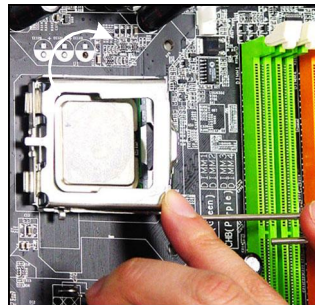

MS-7360 Mainboard

9. Press down the load lever lightly onto the load plate, and then secure the lever with the hook under retention tab.

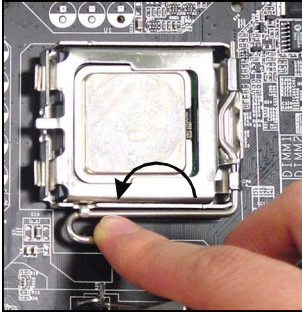

10. Align the holes on the mainboard with the heatsink. Push down the cooler until its four clips get wedged into the holes of the mainboard.

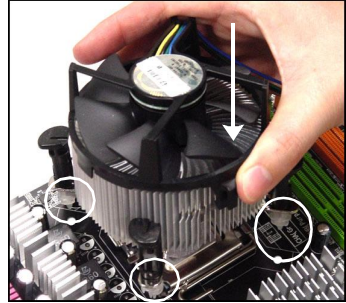

11. Press the four hooks down to fasten the cooler. Then rotate the locking switch (refer to the correct direction marked on it) to lock the hooks.

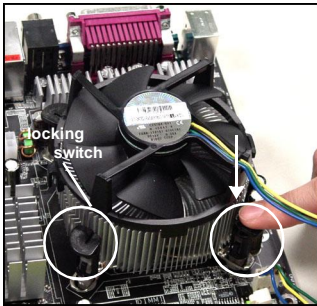

12. Turn over the mainboard to confirm that the clip-ends are correctly inserted.

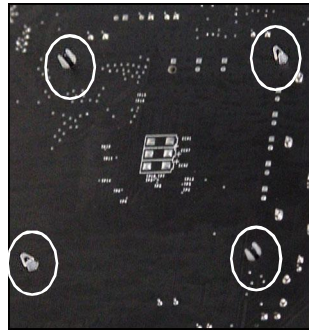

Important

1. Read the CPU status in BIOS (Chapter 3).
2. Whenever CPU is not installed, always protect your CPU socket pin with the plastic cap covered (shown in Figure 1) to avoid damaging.
3. Mainboard photos shown in this section are for demonstration of the CPU/cooler installation only. The appearance of your mainboard may vary depending on the model you purchase.

Memory

These DIMM slots are used for installing memory modules.

For more information on compatible components, please visit <http://www.msi.com.tw/testreport.htm>

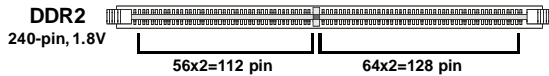

Dual-Channel mode Population Rule

In Dual-Channel mode, the memory modules can transmit and receive data with two data bus lines simultaneously. Enabling Dual-Channel mode can enhance the system performance. Please refer to the following illustrations for population rules under Dual-Channel mode.

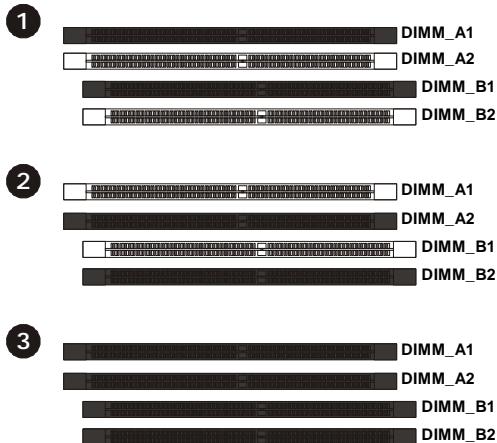

Installing Memory Modules

1. The memory module has only one notch on the center and will only fit in the right orientation.
2. Insert the memory module vertically into the DIMM slot. Then push it in until the golden finger on the memory module is deeply inserted in the DIMM slot.



Important

You can barely see the golden finger if the memory module is properly inserted in the DIMM slot.

3. The plastic clip at each side of the DIMM slot will automatically close.

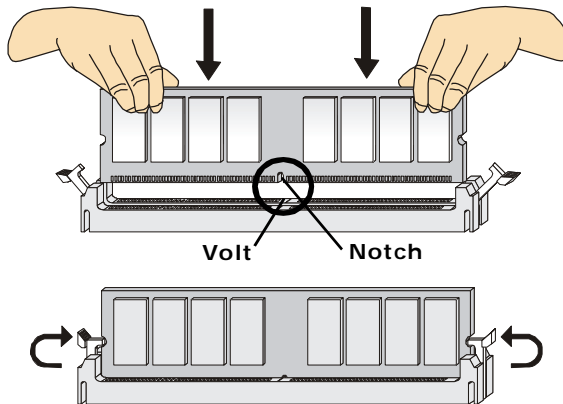

Important

- DDR2 memory modules are not interchangeable with DDR and the DDR2 standard is not backwards compatible. You should always install DDR2 memory modules in the DDR2 DIMM slots.
- In Dual-Channel mode, make sure that you install memory modules of **the same type and density** in different channel DIMM slots.
- To enable successful system boot-up, always insert the memory modules into the **DIMM1 first**.
- Due to the chipset resource deployment, the system density will only be detected up to 7+GB (not full 4GB) when each DIMM is installed with a 2GB memory module.

Power Supply

ATX 24-Pin Power Connector: JPWR3

This connector allows you to connect an ATX 24-pin power supply. To connect the ATX 24-pin power supply, make sure the plug of the power supply is inserted in the proper orientation and the pins are aligned. Then push down the power supply firmly into the connector.

You may use the 20-pin ATX power supply as you like. If you'd like to use the 20-pin ATX power supply, please plug your power supply along with pin 1 & pin 13 (refer to the image at the right hand). There is also a foolproof design on pin 11, 12, 23 & 24 to avoid wrong installation.



Pin Definition			
PIN	SIGNAL	PIN	SIGNAL
1	+3.3V	13	+3.3V
2	+3.3V	14	-12V
3	GND	15	GND
4	+5V	16	PS-ON#
5	GND	17	GND
6	+5V	18	GND
7	GND	19	GND
8	PWROK	20	Res
9	5VSB	21	+5V
10	+12V	22	+5V
11	+12V	23	+5V
12	+3.3V	24	GND

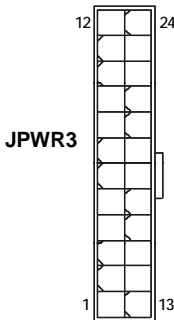

ATX 12V Power Connector: JPW1

This 12V power connector JPW1 is used to provide power to the CPU.

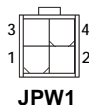

Pin Definition

PIN	SIGNAL
1	GND
2	GND
3	12V
4	12V



Important

1. Make sure that all the connectors are connected to proper ATX power supplies to ensure stable operation of the mainboard.
2. Power supply of 350 watts (and above) is highly recommended for system stability.

Back Panel

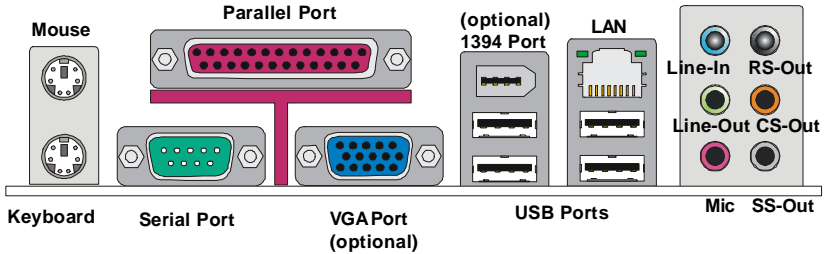

► Mouse/Keyboard Connector

The standard PS/2[®] mouse/keyboard DIN connector is for a PS/2[®] mouse/keyboard.

► Parallel Port Connector

A parallel port is a standard printer port that supports Enhanced Parallel Port (EPP) and Extended Capabilities Parallel Port (ECP) mode.

► Serial Port

The serial port is a 16550A high speed communications port that sends/ receives 16 bytes FIFOs. You can attach a serial mouse or other serial devices directly to the connector.

► VGA Port (for G33 Neo Series)

The DB15-pin female connector is provided for monitor.

► 1394 Port (optional)

The IEEE1394 port on the back panel provides connection to IEEE1394 devices.

► USB Port

The USB (Universal Serial Bus) port is for attaching USB devices such as keyboard, mouse, or other USB-compatible devices.

► LAN (RJ-45) Jack

The standard RJ-45 jack is for connection to single Local Area Network (LAN). You can connect a network cable to it.

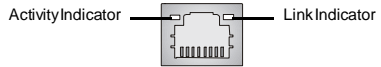

LED	Color	LED State	condition
Left	Orange	Off	LAN link is not established.
		On (steady state)	LAN link is established.
		On (brighter & pulsing)	The computer is communicating with another computer on the LAN.
Right	Green	Off	10 Mbit/sec data rate is selected.
		On	100 Mbit/sec data rate is selected.
	Orange	On	1000 Mbit/sec data rate is selected.

► Audio Ports

These audio connectors are used for audio devices. You can differentiate the color of the audio jacks for different audio sound effects.

- **Line-In (Blue)** - Line In, is used for external CD player, tapeplayer or other audio devices.
- **Line-Out (Green)** - Line Out, is a connector for speakers or headphones.
- **Mic (Pink)** - Mic, is a connector for microphones.
- **RS-Out (Black)** - Rear-Surround Out in 4/ 5.1/ 7.1 channel mode.
- **CS-Out (Orange)** - Center/ Subwoofer Out in 5.1/ 7.1 channel mode.
- **SS-Out (Gray)** - Side-Surround Out 7.1 channel mode.

Connectors

Floppy Disk Drive Connector: FDD1

This connector supports 360KB, 720KB, 1.2MB, 1.44MB or 2.88MB floppy disk drive.

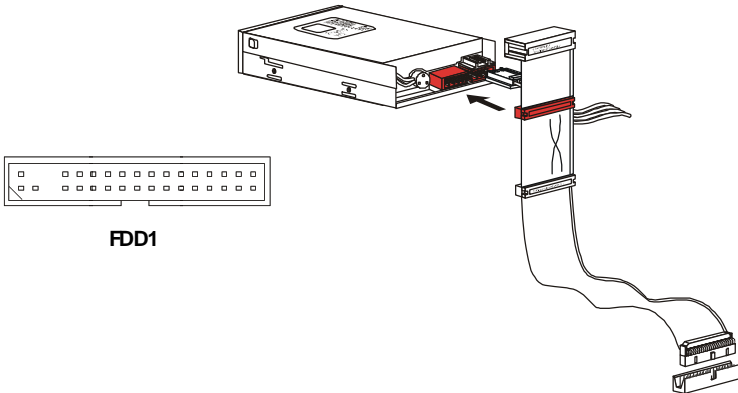

IDE Connector: IDE1

This connector supports IDE hard disk drives, optical disk drives and other IDE devices.

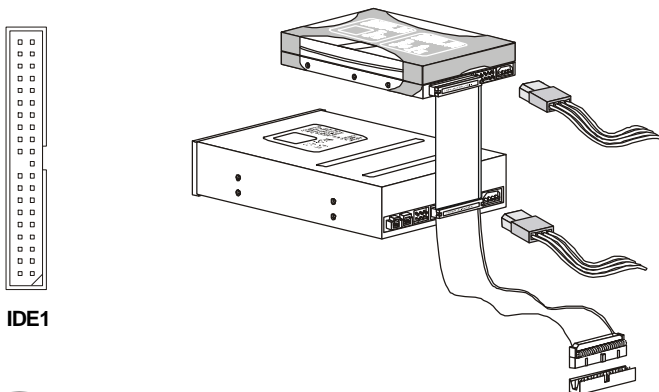

Important

If you install two IDE devices on the same cable, you must configure the drives separately to master / slave mode by setting jumpers. Refer to IDE device's documentation supplied by the vendors for jumper setting instructions.

Serial ATA Connector: SATA1/ SATA2/ SATA3/ SATA4/ SATA5/ SATA6/ SATA7 (SATA5 & SATA6 are for ICH9R only, SATA7 is controlled by Marvell 88SE6111)

This connector is a high-speed Serial ATA interface port. Each connector can connect to one Serial ATA device.

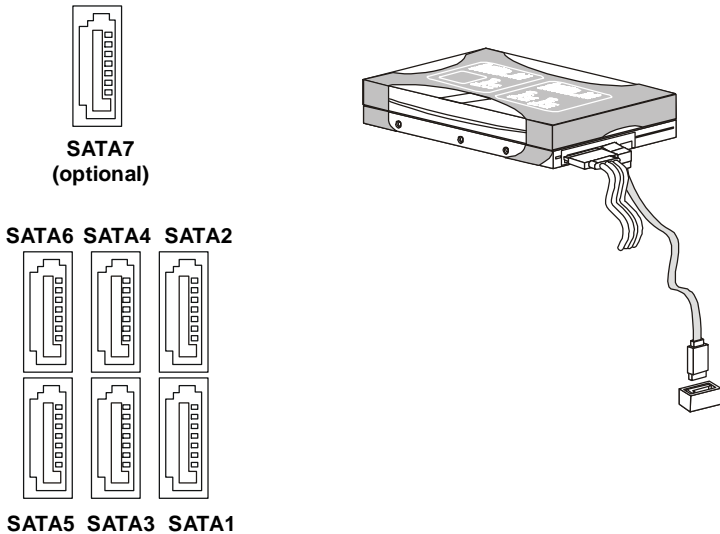

*SATA5 & SATA6 are for ICH9R only.



Important

Please do not fold the Serial ATA cable into 90-degree angle. Otherwise, data loss may occur during transmission.

Fan Power Connectors: CPUFAN1, SYSFAN1, SYSFAN2

The fan power connectors support system cooling fan with +12V. When connecting the wire to the connectors, always note that the red wire is the positive and should be connected to the +12V; the black wire is Ground and should be connected to GND. If the mainboard has a System Hardware Monitor chipset on-board, you must use a specially designed fan with speed sensor to take advantage of the CPU fan control.

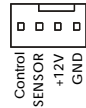

CPUFAN1

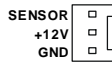

SYSFAN1

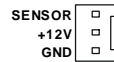

SYSFAN2



Important

1. Please refer to the recommended CPU fans at processor's official website or consult the vendors for proper CPU cooling fan.
2. Fan cooler set with 3 or 4 pins power connector are both available for CPUFAN1.
3. CPUFAN1 supports fan control. You can setup it in H/W Monitor of BIOS Setup. You can install **Dual Core Center** utility that will automatically control the CPU fan speed according to the actual CPU temperature.

Chassis Intrusion Switch Connector: JCI1

This connector connects to a 2-pin chassis switch. If the chassis is opened, the switch will be short. The system will record this status and show a warning message on the screen. To clear the warning, you must enter the BIOS utility and clear the record.

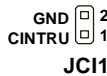

CD-In Connector: CD_IN1

This connector is provided for external audio input.

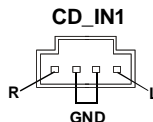

Front Panel Audio Connector: JAUD1

This connector allows you to connect the front panel audio and is compliant with Intel® Front Panel I/O Connectivity Design Guide.



HD Audio Pin Definition

PIN	SIGNAL	DESCRIPTION
1	MIC_L	Microphone - Left channel
2	GND	Ground
3	MIC_R	Microphone - Right channel
4	PRESENCE#	Active low signal-signals BIOS that a High Definition Audio dongle is connected to the analog header. PRESENCE# = 0 when a High Definition Audio dongle is connected
5	LINE out_R	Analog Port - Right channel
6	MIC_JD	Jack detection return from front panel microphone JACK1
7	Front_JD	Jack detection sense line from the High Definition Audio CODEC jack detection resistor network
8	NC	No control
9	LINE out_L	Analog Port - Left channel
10	LINEout_JD	Jack detection return from front panel JACK2

AC'97 Audio Pin Definition

PIN	SIGNAL	DESCRIPTION
1	MIC	Microphone input signal
2	GND	Ground
3	MIC_PWR	Microphone power
4	NC	No Control
5	LINE out_R	Right channel audio signal to front panel
6	NC	No Control
7	NC	No Control
8	Key	No pin
9	LINE out_L	Left channel audio signal to front panel
10	NC	No Control

Front USB Connector: JUSB1 / JUSB2 / JUSB3 / JUSB4

This connector, compliant with Intel® I/O Connectivity Design Guide, is ideal for connecting high-speed USB interface peripherals such as **USB HDD, digital cameras, MP3 players, printers, modems and the like.**

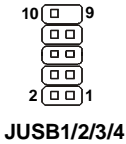

Pin Definition

PIN	SIGNAL	PIN	SIGNAL
1	VCC	2	VCC
3	USB0-	4	USB1-
5	USB0+	6	USB1+
7	GND	8	GND
9	Key (no pin)	10	USBOC

**USB 2.0 Bracket
(Optional)**

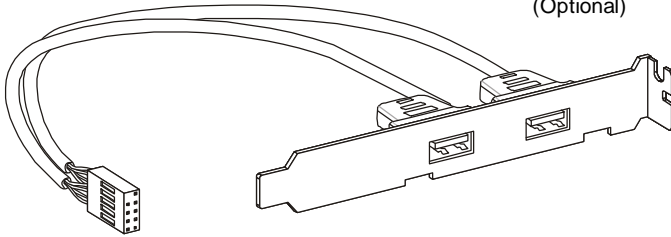

Important

Note that the pins of VCC and GND must be connected correctly to avoid possible damage.

S/PDIF-Out Connector: JSPD1 (Optional)

This connector is used to connect S/PDIF (Sony & Philips Digital Interconnect Format) interface for digital audio transmission.

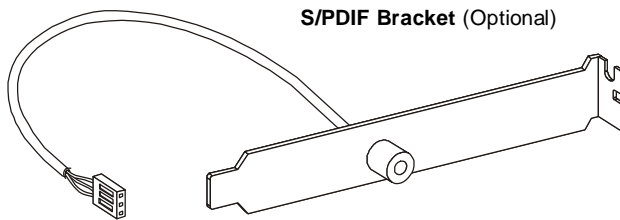
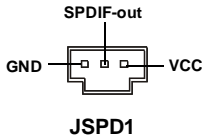

IEEE1394 Connector: J1394_1 (Optional)

This connector allows you to connect the IEEE1394 device via an optional IEEE1394 bracket.

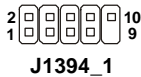

Pin Definition

PIN	SIGNAL	PIN	SIGNAL
1	TPA+	2	TPA-
3	Ground	4	Ground
5	TPB+	6	TPB-
7	Cable power	8	Cable power
9	Key (no pin)	10	Ground

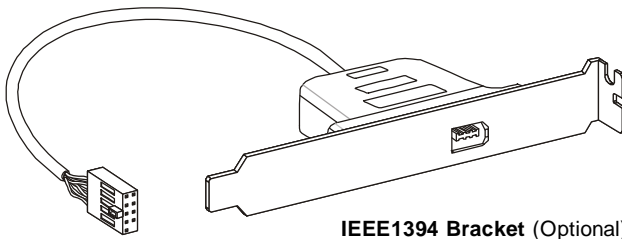

Front Panel Connectors: JFP1, JFP2

These connectors are for electrical connection to the front panel switches and LEDs. The JFP1 is compliant with Intel® Front Panel I/O Connectivity Design Guide.

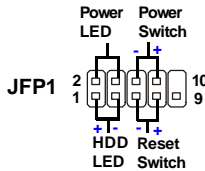

JFP1 Pin Definition

PIN	SIGNAL	DESCRIPTION
1	HD_LED +	Hard disk LED pull-up
2	FPPWR/SLP	MSG LED pull-up
3	HD_LED -	Hard disk active LED
4	FPPWR/SLP	MSG LED pull-up
5	RST_SW -	Reset Switch low reference pull-down to GND
6	PWR_SW-	Power Switch high reference pull-down to GND
7	RST_SW +	Reset Switch high reference pull-up
8	PWR_SW+	Power Switch low reference pull-up
9	RSVD_DNU	Reserved. Do not use.

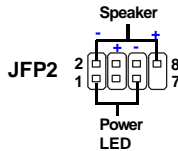

JFP2 Pin Definition

PIN	SIGNAL	DESCRIPTION
1	GND	Ground
2	SPK-	Speaker-
3	SLED	SuspendLED
4	BUZ+	Buzzer+
5	PLED	PowerLED
6	BUZ-	Buzzer-
7	NC	No connection
8	SPK+	Speaker+

Jumpers

Clear CMOS Jumper: JBAT1

There is a CMOS RAM onboard that has a power supply from an external battery to keep the data of system configuration. With the CMOS RAM, the system can automatically boot OS every time it is turned on. If you want to clear the system configuration, set the jumper to clear data.

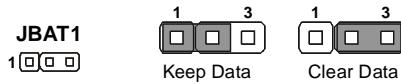

Important

You can clear CMOS by shorting 2-3 pin while the system is off. Then return to 1-2 pin position. Avoid clearing the CMOS while the system is on; it will damage the mainboard.

Slots

PCI (Peripheral Component Interconnect) Express Slot

The PCI Express slot supports the PCI Express interface expansion card.

The PCI Express x 16 supports up to 4.0 GB/s transfer rate.

The PCI Express x 8 supports up to 2.0 GB/s transfer rate.

The PCI Express x 4 supports up to 1.0 GB/s transfer rate.

The PCI Express x 1 supports up to 250 MB/s transfer rate.

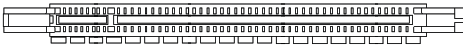

PCI Express x16 Slot

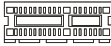

PCI Express x1 Slot

PCI (Peripheral Component Interconnect) Slot

The PCI slot supports LAN card, SCSI card, USB card, and other add-on cards that comply with PCI specifications.

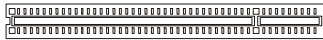

32-bit PCI Slot



Important

1. When adding or removing expansion cards, make sure that you unplug the power supply first. Meanwhile, read the documentation for the expansion card to configure any necessary hardware or software settings for the expansion card, such as jumpers, switches or BIOS configuration.
2. The mainboard supports SLI technology with two PCI Express X 16 slots.

PCI Interrupt Request Routing

The IRQ, acronym of interrupt request line and pronounced I-R-Q, are hardware lines over which devices can send interrupt signals to the microprocessor. The PCI IRQ pins are typically connected to the PCI bus pins as follows:

	Order 1	Order 2	Order 3	Order 4
PCI Slot 1	INT Y#	INT Z#	INT W#	INT X#
PCI Slot 2	INT Z#	INT W#	INT X#	INT Y#

Chapter 3

BIOS Setup

This chapter provides information on the BIOS Setup program and allows you to configure the system for optimum use.

You may need to run the Setup program when:

- ≈ An error message appears on the screen during the system booting up, and requests you to run SETUP.
- ≈ You want to change the default settings for customized features.

Entering Setup

Power on the computer and the system will start POST (Power On Self Test) process. When the message below appears on the screen, press key to enter Setup.

Press DEL to enter SETUP

If the message disappears before you respond and you still wish to enter Setup, restart the system by turning it OFF and On or pressing the RESET button. You may also restart the system by simultaneously pressing <Ctrl>, <Alt>, and <Delete> keys.



Important

1. The items under each BIOS category described in this chapter are under continuous update for better system performance. Therefore, the description may be slightly different from the latest BIOS and should be held for reference only.
2. Upon boot-up, the 1st line appearing after the memory count is the BIOS version. It is usually in the format:

A7360IMS V1.0 032407 where:

1st digit refers to BIOS maker as A = AMI, W = AWARD, and P = PHOENIX.

2nd - 5th digit refers to the model number.

6th digit refers to the chipset as I = Intel, N = nVidia, and V = VIA.

7th - 8th digit refers to the customer as MS = all standard customers.

V1.0 refers to the BIOS version.

032407 refers to the date this BIOS was released.

Control Keys

<↑>	Move to the previous item
<↓>	Move to the next item
<←>	Move to the item in the left hand
<→>	Move to the item in the right hand
<Enter>	Select the item
<Esc>	Jumps to the Exit menu or returns to the main menu from a submenu
<+/PU>	Increase the numeric value or make changes
<-/PD>	Decrease the numeric value or make changes
<F6>	Load Optimized Defaults
<F8>	Load Fail-Safe Defaults
<F10>	Save all the CMOS changes and exit

Getting Help

After entering the Setup menu, the first menu you will see is the Main Menu.

Main Menu

The main menu lists the setup functions you can make changes to. You can use the arrow keys (↑↓) to select the item. The on-line description of the highlighted setup function is displayed at the bottom of the screen.

Sub-Menu

If you find a right pointer symbol (as shown in the right view) appears to the left of certain fields that means a sub-menu can be launched from this field. A sub-menu contains additional options for a field parameter. You can use arrow keys (↑↓) to highlight the field and press <Enter> to call up the sub-menu. Then you can use the control keys to enter values and move from field to field within a sub-menu. If you want to return to the main menu, just press the <Esc >.

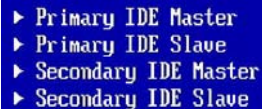

```

▶ Primary IDE Master
▶ Primary IDE Slave
▶ Secondary IDE Master
▶ Secondary IDE Slave

```

General Help <F1>

The BIOS setup program provides a General Help screen. You can call up this screen from any menu by simply pressing <F1>. The Help screen lists the appropriate keys to use and the possible selections for the highlighted item. Press <Esc> to exit the Help screen.

The Main Menu



► Standard CMOS Features

Use this menu for basic system configurations, such as time, date etc.

► Advanced BIOS Features

Use this menu to setup the items of AMI® special enhanced features.

► Integrated Peripherals

Use this menu to specify your settings for integrated peripherals.

► Power Management Setup

Use this menu to specify your settings for power management.

► PNP/PCI Configurations

This entry appears if your system supports PnP/PCI.

► H/W Monitor

This entry shows your PC health status.

► Frequency/Voltage Control

Use this menu to specify your settings for frequency/voltage control and overclocking.

► Load Fail-Safe Defaults

Use this menu to load the default values set by the BIOS vendor for stable system performance.

► Load Optimized Defaults

Use this menu to load the default values set by the mainboard manufacturer specifically for optimal performance of the mainboard.

► BIOS Setting Password

Use this menu to set the password for BIOS.

► Save & Exit Setup

Save changes to CMOS and exit setup.

► Exit Without Saving

Abandon all changes and exit setup.

Standard CMOS Features

The items in Standard CMOS Features Menu includes some basic setup items. Use the arrow keys to highlight the item and then use the <PgUp> or <PgDn> keys to select the value you want in each item.

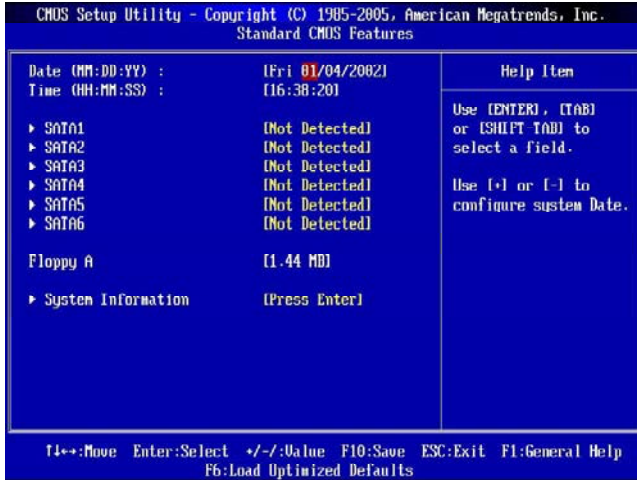

► Date (MM:DD:YY)

This allows you to set the system to the date that you want (usually the current date). The format is <day><month> <date> <year>.

- day** Day of the week, from Sun to Sat, determined by BIOS. Read-only.
- month** The month from Jan. through Dec.
- date** The date from 1 to 31 can be keyed by numeric function keys.
- year** The year can be adjusted by users.

► Time (HH:MM:SS)

This allows you to set the system time that you want (usually the current time). The time format is <hour> <minute> <second>.

► SATA1 / SATA2 / SATA3 / SATA4 / SATA5 / SATA6

Press <Enter> to enter the sub-menu, and the following screen appears.

► Device

It will showing the device information that you connected to the SATA connector.

► **LBA/Large Mode**

This allows you to enable or disable the LBA Mode. Setting to Auto enables LBA mode if the device supports it and the devices is not already formatted with LBA mode disabled.

► **DMA Mode**

Select DMA Mode.

► **Hard Disk S.M.A.R.T.**

This allows you to activate the S.M.A.R.T. (Self-Monitoring Analysis & Reporting Technology) capability for the hard disks. S.M.A.R.T. is a utility that monitors your disk status to predict hard disk failure. This gives you an opportunity to move data from a hard disk that is going to fail to a safe place before the hard disk becomes offline.



Important

SATA1~6 are appearing when you connect the HD devices to the SATA connector on the mainboard.

Due to the IDE1 & SATA7 is controlled by Marvell 88SE6111, the BIOS will not detect the IDE & SATA device and will not show the status.

► **Floppy A**

This item allows you to set the type of floppy drives installed. Available options: [None], [360K, 5.25 in.], [1.2M, 5.25 in.], [720K, 3.5 in.], [1.44M, 3.5 in.], [2.88M, 3.5 in.].

► **System Information**

Press <Enter> to enter the sub-menu, and the following screen appears.

CMOS Setup Utility - Copyright (C) 1985-2005, American Megatrends, Inc.		
System Information		
		Help Item
CPU Type	06F4h/80h	
CPU ID/MicroCode	2-666Hz (266x10)	
CPU Frequency	01.086	
BIOS Version	512MB	
Physical Memory	503MB	
Usage Memory	10544 KB	
Cache Size	0 KB x 2	
L3 Cache Size		

This sub-menu shows the CPU information, BIOS version and memory status of your system (read only).

Advanced BIOS Features



▶ Boot Sector Protection

This function protects the BIOS from accidental corruption by unauthorized users or computer viruses. When enabled, the BIOS' data cannot be changed when attempting to update the BIOS with a Flash utility. To successfully update the BIOS, you'll need to disable this Flash BIOS Protection function.

You should enable this function at all times. The only time when you need to disable it is when you want to update the BIOS. After updating the BIOS, you should immediately re-enable it to protect it against viruses.

▶ Full Screen LOGO Display

This item enables you to show the company logo on the bootup screen. Settings are:

- | | |
|------------|--|
| [Enabled] | Shows a still image (logo) on the full screen at boot. |
| [Disabled] | Shows the POST messages at boot. |

▶ Quick Booting

Setting the item to [Enabled] allows the system to boot within 10 seconds since it will skip some check items.

▶ Boot Up Num-Lock LED

This setting is to set the Num Lock status when the system is powered on. Setting to [On] will turn on the Num Lock key when the system is powered on. Setting to [Off] will allow users to use the arrow keys on the numeric keypad.

► **IOAPIC Function**

This field is used to enable or disable the APIC (Advanced Programmable Interrupt Controller). Due to compliance with PC2001 design guide, the system is able to run in APIC mode. Enabling APIC mode will expand available IRQ resources for the system.

► **MPS Table Version**

This field allows you to select which MPS (Multi-Processor Specification) version to be used for the operating system. You need to select the MPS version supported by your operating system. To find out which version to use, consult the vendor of your operating system.

► **CPU Feature**

Press <Enter> to enter the sub-menu and the following screen appears:



► **Execute Disable Bit**

Intel's Execute Disable Bit functionality can prevent certain classes of malicious "buffer overflow" attacks when combined with a supporting operating system. This functionality allows the processor to classify areas in memory by where application code can execute and where it cannot. When a malicious worm attempts to insert code in the buffer, the processor disables code execution, preventing damage or worm propagation.

► **Set Limit CPUID MaxVal to 3**

The Max CPUID Value Limit is designed to limit the listed speed of the processor to older operating systems.

► **Chipset Feature**

Press <Enter> to enter the sub-menu and the following screen appears:



► **HPET**

The HPET (High Precision Event Timers) is a component that is part of the chipset. You can to enable it, and will provide you with the means to get to it via the various ACPI methods.

► **VGA Share Memory Size**

The system shares memory to the onboard VGA card. This setting controls the exact memory size shared to the VGA card.

► Boot Sequence

Press <Enter> to enter the sub-menu and the following screen appears:

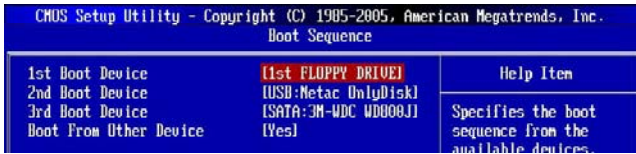

CMOS Setup Utility - Copyright (C) 1995-2005, American Megatrends, Inc.		
Boot Sequence		
1st Boot Device	[1st FLOPPY DRIVE]	Help Item
2nd Boot Device	(USB:Metac OnlyDisk)	
3rd Boot Device	(SATA:3M-WDC WD000JJ)	
Boot From Other Device	[Yes]	Specifies the boot sequence from the available devices.

► 1st/ 2nd/ 3rd Boot Device

The items allow you to set the first/ second/ third boot device where BIOS attempts to load the disk operating system.

► Boot From Other Device

Setting the option to [Yes] allows the system to try to boot from other device. if the system fails to boot from the 1st/ 2nd/ 3rd boot device.

Integrated Peripherals

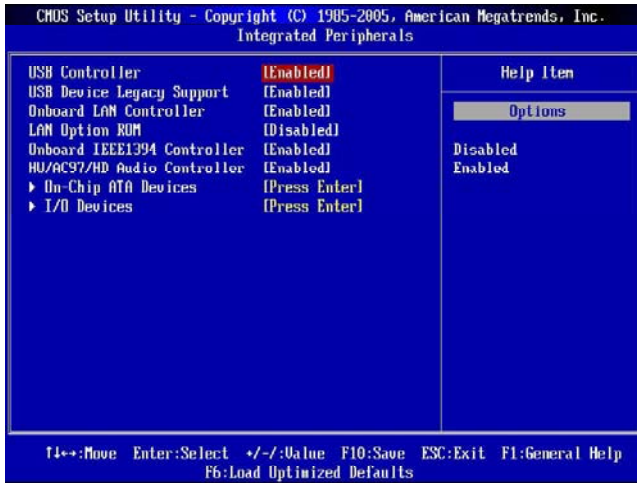

▶ USB Controller

This setting allows you to enable/disable the onboard USB controller.

▶ USB Device Legacy Support

Select [Enabled] if you need to use a USB-interfaced device in the operating system.

▶ Onboard LAN Controller

This item is used to enable/disable the onboard LAN controller.

▶ LAN Option ROM

This item is used to decide whether to invoke the Boot ROM of the LAN controller.

▶ Onboard IEEE1394 Controller

This item allows you to enable/disable the onboard IEEE1394 controller.

▶ HW/AC97/HD Audio Controller

This setting is used to enable/disable the onboard audio controller.

► **On-Chip ATA Devices**

Press <Enter> to enter the sub-menu and the following screen appears:

CMOS Setup Utility - Copyright (C) 1985-2005, American Megatrends, Inc.		
On-Chip ATA Devices		
PCI IDE BusMaster	[Disabled]	Help Item
On-Chip SATA Controller	[IDE]	ENABLED: BIOS uses PCI busmastering for

► **PCI IDE BusMaster**

This item allows you to enable/ disable BIOS to used PCI busmastering for reading/ writing to IDE drives.

► **On-Chip SATA Controller**

This setting is used to specify the operating mode for SATA devices.

► **I/O Devices**

Press <Enter> to enter the sub-menu and the following screen appears:

CMOS Setup Utility - Copyright (C) 1985-2005, American Megatrends, Inc.		
I/O Devices		
COM Port 1	[3F8/IRQ4]	Help Item
Parallel Port	[378]	Allows BIOS to Select Serial Port1 Base
Parallel Port Mode	[Normal]	

► **COM Port 1**

Select an address and corresponding interrupt for the first serial port.

► **Parallel Port**

There is a built-in parallel port on the on-board Super I/O chipset that provides Standard, ECP, and EPP features. It has the following options:

[3BC]	Line Printer port 0
[278]	Line Printer port 2
[378]	Line Printer port 1

► **Parallel Port Mode**

[Normal]	Standard Parallel Port
[EPP]	Enhanced Parallel Port
[ECP]	Extended Capability Port
[Bi-Directional]	Extended Capability Port + Enhanced Parallel Port

To operate the onboard parallel port as Standard Parallel Port only, choose [Normal]. To operate the onboard parallel port in the EPP mode simultaneously, choose [EPP]. By choosing [ECP], the onboard parallel port will operate in ECP mode only. Choosing [Bi-Direction] will allow the onboard parallel port to support both the ECP and EPP modes simultaneously.

Power Management Setup

CMOS Setup Utility - Copyright (C) 1985-2005, American Megatrends, Inc.
Power Management Setup

		Help Item
ACPI Function	[Enabled]	Enable / Disable ACPI support for Operating System.
ACPI Standby State	[S1]	
Suspend Time Out (Minute)	[Disabled]	ENABLE: If OS supports ACPI. DISABLE: If OS does not support ACPI.
Power Button Function	[Power Off]	
Restore on AC Power Loss	[Off]	
▶ Wakeup Event Setup	[Press Enter]	

F4: Move Enter: Select +/-: Value F10: Save ESC: Exit F1: General Help
F6: Load Optimized Defaults



Important

S3-related functions described in this section are available only when your BIOS supports S3 sleep mode.

► ACPI Function

This item is to activate the ACPI (Advanced Configuration and Power Management Interface) Function. If your operating system is ACPI-aware, such as Windows 2000/XP, select [Enabled].

► ACPI Standby State

This item specifies the power saving modes for ACPI function. If your operating system supports ACPI, such as Windows 2000/XP, you can choose to enter the Standby mode in S1(POS) or S3(STR) fashion through the setting of this field. Settings are:

- [S1] The S1 sleep mode is a low power state. In this state, no system context is lost (CPU or chipset) and hardware maintains all system context.
- [S3] The S3 sleep mode is a lower power state where the information of system configuration and open applications/files is saved to main memory that remains powered while most other hardware components turn off to save energy. The information stored in memory will be used to restore the system when a "wake up" event occurs.

► **Re-Call VGA BIOS From S3**

When **ACPI Standby State** is set to [S3], users can select the options in this field. Selecting [Enabled] allows BIOS to call VGABIOS to initialize the VGA card when system wakes up (resumes) from S3 sleep state. The system resume time is shortened when you disable the function, but system will need an VGA driver to initialize the VGA card. Therefore, if the VGA driver of the card does not support the initialization feature, the display may work abnormally or not function after resuming from S3.

► **Suspend Time Out (Minute)**

If system activity is not detected for the length of time specified in this field, all devices except CPU will be shut off.

► **Power Button Function**

This feature sets the function of the power button. Settings are:

- [Power Off] The power button functions as normal power off button.
- [Suspend] When you press the power button, the computer enters the suspend/sleep mode, but if the button is pressed for more than four seconds, the computer is turned off.

► **Restore On AC Power Loss**

This item specifies whether your system will reboot after a power failure or interrupt occurs. Settings are:

- [Off] Always leaves the computer in the power off state.
- [On] Always leaves the computer in the power on state.
- [Last State] Restores the system to the status before power failure or interrupt occurred.

► **Wakeup Event Setup**

Press <Enter> and the following sub-menu appears.

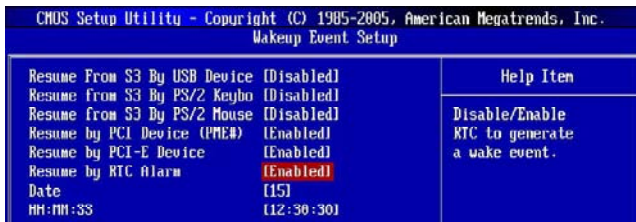

► **Resume From S3 By USB Device**

The item allows the activity of the USB device to wake up the system from S3 (Suspend to RAM) sleep state.

► **Resume From S3 by PS/2 Keybo**

This setting determines whether the system will be awakened from what power saving modes when input signal of the PS/2 keyboard is detected.

▶ Resume From S3 by PS/2 Mouse

This setting determines whether the system will be awakened from what power saving modes when input signal of the PS/2 mouse is detected.

▶ Resume by PCI Device (PME#)

When set to [Enabled], the feature allows your system to be awakened from the power saving modes through any event on PME (Power Management Event).

▶ Resume by PCI-E Device

When set to [Enabled], the feature allows your system to be awakened from the power saving modes through any event on PCI Express device.

▶ Resume by RTC Alarm

The field is used to enable or disable the feature of booting up the system on a scheduled time/date.

PNP/PCI Configurations

This section describes configuring the PCI bus system and PnP (Plug & Play) feature. PCI, or Peripheral Component Interconnect, is a system which allows I/O devices to operate at speeds nearing the speed the CPU itself uses when communicating with its special components. This section covers some very technical items and it is strongly recommended that only experienced users should make any changes to the default settings.

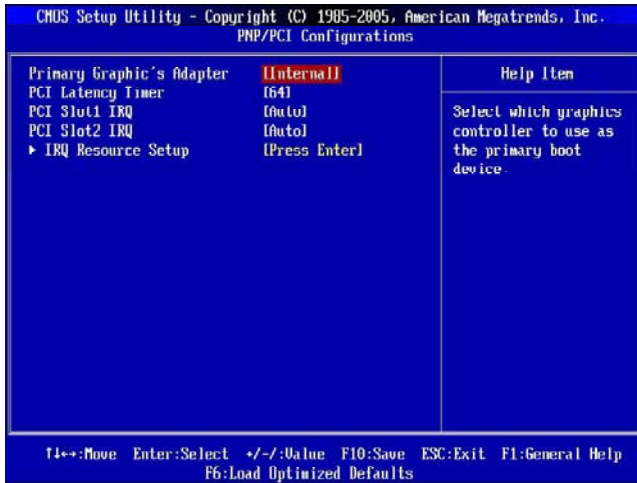

▶ Primary Graphic's Adapter

This setting specifies which graphics card is your primary graphics adapter.

▶ PCI Latency Timer

This item controls how long each PCI device can hold the bus before another takes over. When set to higher values, every PCI device can conduct transactions for a longer time and thus improve the effective PCI bandwidth. For better PCI performance, you should set the item to higher values.

▶ PCI Slot 1/2 IRQ

These items specify the IRQ line for each PCI slot.

► **IRQ Resource Setup**

Press <Enter> to enter the sub-menu and the following screen appears.



► **IRQ 3/4/5/7/9/10/11/14/15**

These items specify the bus where the specified IRQ line is used.

The settings determine if AMIBIOS should remove an IRQ from the pool of available IRQs passed to devices that are configurable by the system BIOS. The available IRQ pool is determined by reading the ESCD NVRAM. If more IRQs must be removed from the IRQ pool, the end user can use these settings to reserve the IRQ by assigning an [Reserved] setting to it. Onboard I/O is configured by AMIBIOS. All IRQs used by onboard I/O are configured as [Available]. If all IRQs are set to [Reserved], and IRQ 14/15 are allocated to the onboard PCI IDE, IRQ 9 will still be available for PCI and PnP devices.



Important

IRQ (Interrupt Request) lines are system resources allocated to I/O devices. When an I/O device needs to gain attention of the operating system, it signals this by causing an IRQ to occur. After receiving the signal, when the operating system is ready, the system will interrupt itself and perform the service required by the I/O device.

H/W Monitor

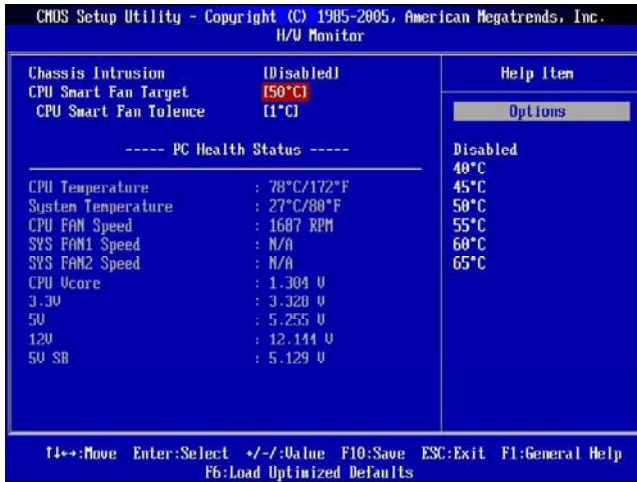

► Chassis Intrusion

The field enables or disables the feature of recording the chassis intrusion status and issuing a warning message if the chassis is once opened. To clear the warning message, set the field to [Reset]. The setting of the field will automatically return to [Enabled] later.

► CPU Smart FAN Target

The mainboard provides the Smart Fan function which can control the CPU fan speed automatically depending on the current temperature to keep it with in a specific range. You can select a fan target value here. If the current CPU fan temperature reaches to the target value, the smart fan function will be activated. It provides several sections to speed up for cooling down automatically.

► CPU Fan Tolerance Value

When a particular temperature setting is selected for the previous item, **CPU Smart Fan Target**, a temperature tolerance value between 1 to 5 can be adjusted here.

---- PC Health Status ----

► CPU/ System Temperature, CPU FAN/ SYS FAN1/ SYS FAN2 Speed, CPU Vcore, 3.3V, 5V, 12V, 5VSB

These items display the current status of all of the monitored hardware devices/ components such as CPU voltage, temperatures and all fans' speeds.

Frequency/Voltage Control

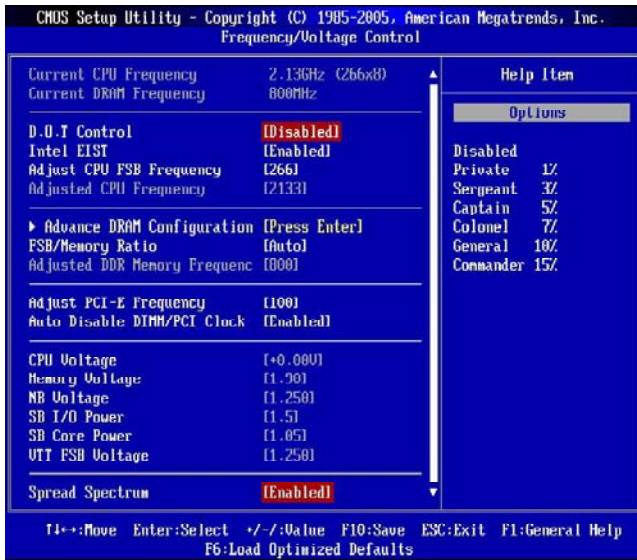

Important

Change these settings only if you are familiar with the chipset.

► Current CPU/ DRAM Frequency

These items show the current clocks of CPU and Memory speed. Read-only.

► D.O.T Control

D.O.T. (Dynamic Overclocking Technology) is the automatic overclocking function, included in the MSI™'s newly developed CoreCell™ Technology. It is designed to detect the load balance of CPU while running programs, and to adjust the best CPU frequency automatically. When the motherboard detects CPU is running programs, it will speed up CPU automatically to make the program run smoothly and faster. When the CPU is temporarily suspending or staying in the low load balance, it will restore the default settings instead. Usually the Dynamic Overclocking Technology will be powered only when users' PC need to run huge amount of data like 3D games or the video process, and the CPU frequency need to be boosted up to enhance the overall performance. Settings are:

- | | |
|------------|--|
| [Disabled] | Disable Dynamic Overclocking. |
| [Private] | 1st level of overclocking, increasing the frequency by 1%. |

[Sergeant]	2nd level of overclocking, increasing the frequency by 3%.
[Captain]	3rd level of overclocking, increasing the frequency by 5%.
[Colonel]	4th level of overclocking, increasing the frequency by 7%.
[General]	5th level of overclocking, increasing the frequency by 10%.
[Commander]	6th level of overclocking, increasing the frequency by 15%.



Important

Even though the Dynamic Overclocking Technology is more stable than manual overclocking, basically, it is still risky. We suggest user to make sure that your CPU can afford to overclocking regularly first. If you find the PC appears to be unstable or reboot incidentally, it's better to disable the Dynamic Overclocking or to lower the level of overclocking options. By the way, if you need to conduct overclocking manually, you also need to disable the Dynamic OverClocking first.

► Intel EIST

The Enhanced Intel SpeedStep technology allows you to set the performance level of the microprocessor whether the computer is running on battery or AC power. This field will appear after you installed the CPU which support speedstep technology.

► Adjust CPU FSB Frequency

This item allows you to select the CPU Front Side Bus clock frequency (in MHz).

► Advance DRAM Configuration

Press <Enter> to enter the sub-menu and the following screen appears.



► Configure DRAM Timing by SPD

Selects whether DRAM timing is controlled by the SPD (Serial Presence Detect) EEPROM on the DRAM module. Setting to [Auto By SPD] enables DRAM timings and the following related items to be determined by BIOS based on the configurations on the SPD. Selecting [Manual] allows users to configure the DRAM timings and the following related items manually.

► DRAM CAS# Latency

This controls the CAS latency, which determines the timing delay (in clock cycles) before SDRAM starts a read command after receiving it.

▶ DRAM RAS# to CAS# Delay

This field allows you to set the number of cycles for a timing delay between the CAS and RAS strobe signals, used when DRAM is written to, read from or refreshed. Fast speed offers faster performance while slow speed offers more stable performance.

▶ DRAM RAS# Precharge

This item controls the number of cycles for Row Address Strobe (RAS) to be allowed to precharge. If insufficient time is allowed for the RAS to accumulate its charge before DRAM refresh, refresh may be incomplete and DRAM may fail to retain data. This item applies only when synchronous DRAM is installed in the system.

▶ DRAM RAS# Activate to Prec

This item controls the number of cycles for Row Address Strobe (RAS) to be allowed to precharge. If insufficient time is allowed for the RAS to accumulate its charge before DRAM refresh, refreshing may be incomplete and DRAM may fail to retain data. This item applies only when synchronous DRAM is installed in the system.

▶ FSB/Memory Ratio

This setting control the ratio of CPU FSB / DRAM Clock Ratio to enable the CPU & DRAM to run at different frequency combinations. Please note that the setting options vary according to the CPU FSB Clock preset.

▶ Adjust PCI-E Frequency

This field allows you to select the PCIE frequency (in MHz).

▶ Auto Disable DIMM/PCI Ck

This item is used to auto disable the DIMM/PCI slots. When set to [Enabled], the system will remove (turn off) clocks from empty DIMM/PCI slots to minimize the electromagnetic interference (EMI).

▶ CPU Voltage

This item allows you to increase the CPU voltage.

▶ Memory Voltage (V)

Adjusting the memory voltage can increase the DDR speed.

▶ NB Voltage

Adjust the North Bridge chipset voltage.

▶ SB I/O Power

Adjust the South Bridge I/O voltage.

▶ SB Core Power

Adjust the South Bridge core voltage.

► **VTT FSB Voltage**

This item allows you to set the FSB VTT voltage.

► **Spread Spectrum Configuration CPU Spread Spectrum**

This setting is used to enable or disable the Spread Spectrum feature. When overclocking, always set it to [Disabled].



Important

1. *If you do not have any EMI problem, leave the setting at [Disabled] for optimal system stability and performance. But if you are plagued by EMI, select the value of Spread Spectrum for EMI reduction.*
2. *The greater the Spread Spectrum value is, the greater the EMI is reduced, and the system will become less stable. For the most suitable Spread Spectrum value, please consult your local EMI regulation.*
3. *Remember to disable Spread Spectrum if you are overclocking because even a slight jitter can introduce a temporary boost in clock speed which may just cause your overclocked processor to lock up.*

Load Fail-Safe/ Optimized Defaults

The two options on the main menu allow users to restore all of the BIOS settings to the default Fail-Safe or Optimized values. The Optimized Defaults are the default values set by the mainboard manufacturer specifically for optimal performance of the mainboard. The Fail-Safe Defaults are the default values set by the BIOS vendor for stable system performance.

When you select Load Fail-Safe Defaults, a message as below appears:

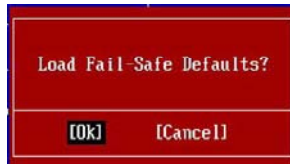

Selecting **Ok** and pressing **Enter** loads the BIOS default values for the most stable, minimal system performance.

When you select Load Optimized Defaults, a message as below appears:



Selecting **Ok** and pressing **Enter** loads the default factory settings for optimal system performance.

BIOS Setting Password

When you select this function, a message as below will appear on the screen:



Type the password, up to six characters in length, and press <Enter>. The password typed now will replace any previously set password from CMOS memory. You will be prompted to confirm the password. Retype the password and press <Enter>. You may also press <Esc> to abort the selection and not enter a password.

To clear a set password, just press <Enter> when you are prompted to enter the password. A message will show up confirming the password will be disabled. Once the password is disabled, the system will boot and you can enter Setup without entering any password.

When a password has been set, you will be prompted to enter it every time you try to enter Setup. This prevents an unauthorized person from changing any part of your system configuration.

Appendix A

Dual Core Center

Dual CoreCenter, the most useful and powerful utility that MSI has spent much research and efforts to develop, helps users to monitor or configure the hardware status of MSI Mainboard & MSI Graphics card in windows, such as CPU/GPU clock, voltage, fan speed and temperature.

Before you install the Dual CoreCenter, please make sure the system has meet the following requirements:

1. Intel Pentium4 / Celeron, AMD Athlon XP/ Sempron or compatible CPU with PCI Express slot.
2. 256MB system memory.
3. CD-ROM drive for software installation.
4. Operation system: Windows XP.
5. DotNet Frame Work 2.0

Activating Dual Core Center

Once you have your Dual Core Center installed (locate the setup source file in the setup CD accompanying with your mainboard, path: **Utility --> MSI Utility --> Dual Core Center**), it will have an icon  in the system tray, a short cut icon on the desktop, and a short cut path in your "Start-up" menu. You may double-click on each icon to enable Dual Core Center.



short-cut icon in the system tray

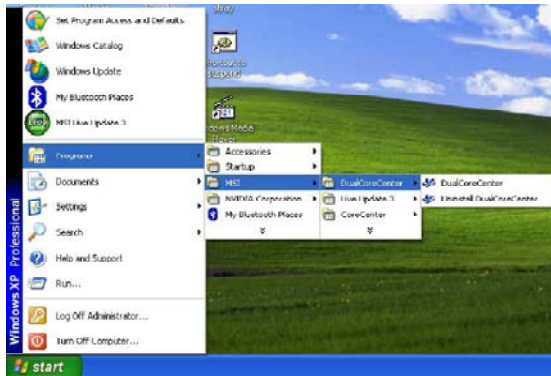

short-cut path in the start-up menu
(path: Start->Programs->MSI->DualCoreCenter->DualCoreCenter)

Main

Before using this utility, we have to remind you: **only when installing the MSI V044 (V044 has to install with the version 8.26 or newer driver)/ V046 or V060 graphics card can activate the full function of this utility.** If you install a graphics card of other brand, only hardware status of the MSI mainboard would be available.



Introduction:

Click each button appearing above to enter sub-menu to make further configuration or to execute the function.

MB

Click MB button to read current CPU temperature, FSB and CPU clock of mainboard will show below.

VGA

Click VGA button to read current GPU temperature, GPU clock and memory clock of graphics card will show below.

DOT

Click DOT button to enable or disable the Dynamic Overclocking Technology.

AV/ Game/ Office/ Silence/ Cool

MSI provides five common settings for different environments. The settings had been set to optimal values to reach better performance in each environment. Click the button you need.



Important

Before clicking the AV/ Game/ Office/ Silence or Cool button, select Smooth mode or Sharp mode to decide whether you want the system to reach the optimal values smoothly or quickly.

Sharp mode



Smooth mode

Clock



In this sub-menu, you can adjust and monitor the clocks of MB and graphics card.

Voltage



In this sub-menu, you can adjust and monitor the voltages of MB and graphics card.

FAN Speed



In this sub-menu, you can adjust and monitor the fan speeds of MB and graphics card.

Temperature



In this sub-menu, you can monitor the temperatures of MB and graphics card.

User Profile

In this sub-menu, you can set the values of clock, voltage and fan speed by your need and save them in a profile. You can save 3 profiles for further use.



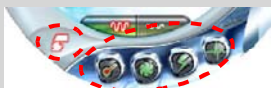

Important

Click on the icon  , the clock, voltage, fan, and temperature buttons will appear beside the icon.



DOT (Dynamic OverClocking)

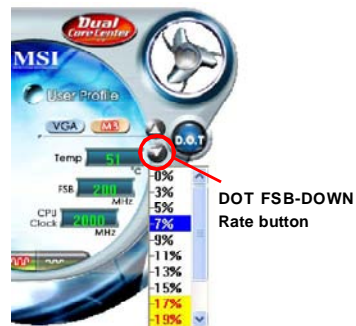
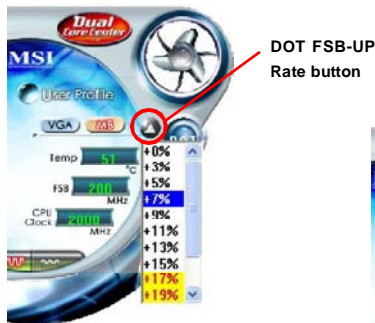

Dynamic Overclocking Technology is an automatic overclocking function, included in the MSI™'s newly developed Dual CoreCenter Technology. It is designed to detect the loading of CPU/ GPU while running programs, and to over-clock automatically. When the motherboard detects that the loading of CPU is exceed the default threshold for a time, it will speed up the CPU and fan automatically to make the system run smoother and faster. When the graphics card detects that the loading of GPU is exceed the default threshold for a time, it will speed up the GPU, memory, fan and voltage automatically to make the system run smoother and faster. When the CPU/ GPU is temporarily suspending or staying in low loading balance, it will restore the default settings instead. Usually the Dynamic Overclocking Technology will be powered only when users' PC runs huge amount of data, like 3D games or video process, and the motherboard/ graphicd card need to be boosted up to enhance the overall performance. There will be several selections when you click the DOT rate button (include increase rate  and decrease  rate buttons), to select the DOT level, then you have to click the DOT button  to apply the DOT function.



Important

Even though the Dynamic Overclocking Technology is more stable than manual overclocking, basically, it is still risky. We suggest user to overclock regularly first. If you find the PC appears to be unstable or reboot incidentally, it's better to lower the level of overclocking options. By the way, if you need to conduct overclocking manually, please do not to apply the DOT function.

Clock

In the **Clock** sub-menu, you can see clock status (including FSB/ CPU clock of mainboard and GPU/ memory clock of graphics card) of your system. And you can select desired value for overclocking. There will be several items for you to select for overclocking after you click  button. You can click the plus sign button  to increase the clock, or click the minus sign button  to decrease the clock. And finally, click the Apply button to apply the values adjusted. If you do not want to apply the adjustments, click the Cancel button to cancel. Or click the Default button to restore the default values.

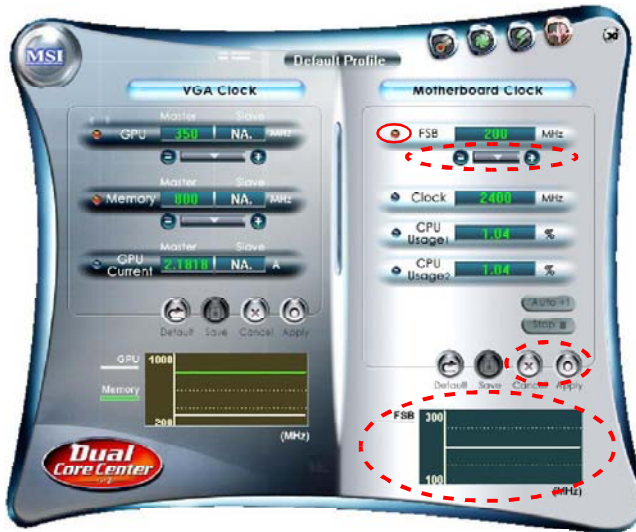



On the underside, it shows the graphs of the clocks. Only the curves of the item which the button is lit up with red color will be shown.



Important

*In the user profile, clicking the **Save** button can save the changes to it. In the default profile, the Save button is not available.*

Voltage

In the **Voltage** sub-menu, you can see voltage status (including Vcore, memory, GPU voltage... etc.) of your system, and you can select desired value for overclocking. It will show several items to select for overclocking after you click the  button. You can click the plus sign button  to increase the voltage, or click the minus sign button  to decrease. And finally, click the Apply button to apply the adjustments. If you do not want to apply the adjustments, click the Cancel button to cancel. Or click the Default button to restore the default values.





On the underside, it shows the graphs of the voltages. Only the curves of the item which the button is lit up with red color will be shown.



Important

*In the user profile, clicking the **Save** button can save the changes to it. In the default profile, the Save button is not available.*

FAN Speed

In the **FAN Speed** sub-menu, you can read fan status of your system. Select higher speed for better cooling effect. There are several sections for you to change the fan speed to a section after clicking  button. Click the plus sign button  to increase the fan speed to a section, or click the minus sign button  to decrease. Or click the Default button to restore the default values.



On the underside, it shows the graphs of the fan speed. Only the curves of the item which the button is lit up with red color will be shown.



Important

1. When you set the fan speed manually, please make sure to disabled the "CPU Smart FAN Target" item in the BIOS.
2. In the user profile, clicking the **Save** button can save the changes to it. In the default profile, the Save button is not available.

Temperature

In the **Temperature** sub-menu, you can see temperature status of your system.





On the underside, it shows the graphs of the temperatures. Only the curves of the item which the button is lit with red color will be shown.

User Profile

In the **User Profile** sub-menu, click the setting button that besides the user profile bar, and the next screen will appear.



Here you can define the clock/ fan speed/ voltage by your need, click the  button to choose a value quickly, or click the plus  / minus sign  button to increase/ decrease the value.



Dual Core Center

Use the draw bar to set the max system temperature. When the system temperature exceeds the threshold you defined, the system will pop up a warning message and shut down the system.

Use the draw bar to set the minimal fan speed. When the fan speed is lower than the threshold you defined, the system will pop up a warning message.



After setting all values you need, you can change the user profile name in the box then click the save button  to save all changes in a profile.

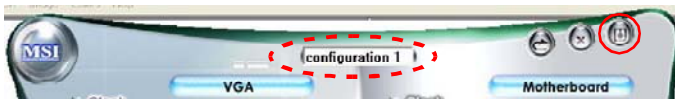

Finally, you can choose the user profile by click the button in the left side and click the Apply button to load the user profile.



Appendix B

Realtek ALC888 Audio

The Realtek ALC888 provides 10-channel DAC that simultaneously supports 7.1 sound playback and 2 channels of independent stereo sound output (multiple streaming) through the Front-Out-Left and Front-Out-Right channels.

Installing the Realtek HD Audio Driver

You need to install the driver for Realtek ALC888 codec to function properly before you can get access to 2-, 4-, 6-, 8- channel or 7.1+2 channel audio operations. Follow the procedures described below to install the drivers for different operating systems.

Installation for Windows 2000/XP

For Windows® 2000, you must install Windows® 2000 Service Pack4 or later before installing the driver. For Windows® XP, you must install Windows® XP Service Pack1 or later before installing the driver.

The following illustrations are based on Windows® XP environment and could look slightly different if you install the drivers in different operating systems.

1. Insert the application CD into the CD-ROM drive. The setup screen will automatically appear.
2. Click **Realtek HD Audio Driver**.



Click here



Important

The **HD Audio Configuration**  software utility is under continuous update to enhance audio applications. Hence, the program screens shown here in this section may be slightly different from the latest software utility and shall be held for reference only.

3. Click **Next** to install the Realtek High Definition Audio Driver.

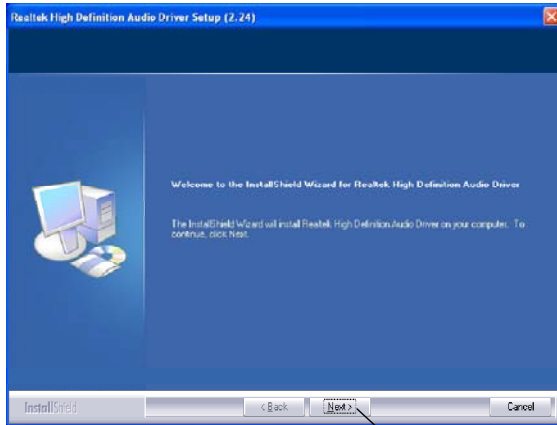

Click here

4. Click **Finish** to restart the system.

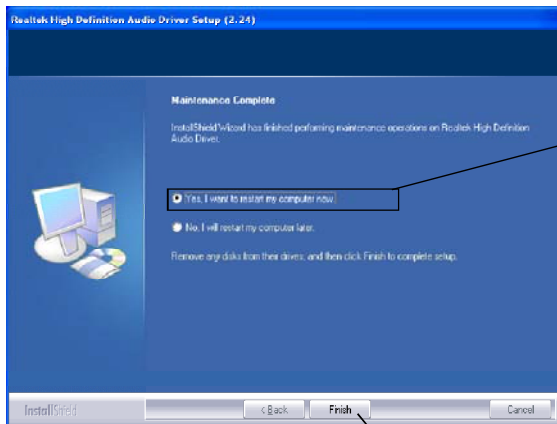

Select this option

Click here

Software Configuration

After installing the audio driver, you are able to use the 2-, 4-, 6- or 8- channel audio feature now. Click the audio icon  from the system tray at the lower-right corner of the screen to activate the **HD Audio Configuration**. It is also available to enable the audio driver by clicking the **Azalia HD Sound Effect Manager** from the **Control Panel**.

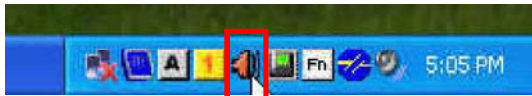

Double click

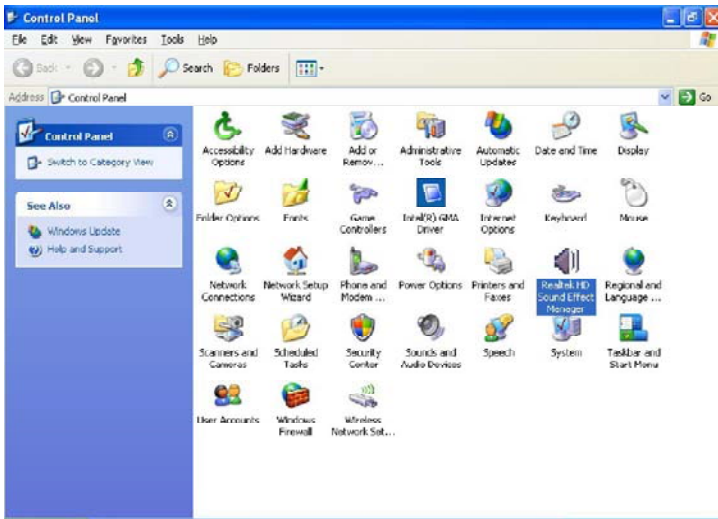

Sound Effect

Here you can select a sound effect you like from the **Environment** list.



Environment Simulation

You will be able to enjoy different sound experience by pulling down the arrow, totally 23 kinds of sound effect will be shown for selection. Realtek HD Audio Sound Manager also provides five popular settings “Stone Corridor”, “Bathroom”, “Sewer pipe”, “Arena” and “Audio Corridor” for quick enjoyment.

You may choose the provided sound effects, and the equalizer will adjust automatically. If you like, you may also load an equalizer setting or make an new equalizer setting to save as an new one by using the **“Load EQ Setting”** and **“Save Preset”** button, click **“Reset EQ Setting”** button to use the default value, or click **“Delete EQ Setting”** button to remove a preset EQ setting.

There are also other pre-set equalizer models for you to choose by clicking **“Others”** under the **Equalizer** part.

Equalizer Selection

Equalizer frees users from default settings; users may create their own preferred settings by utilizing this tool.

10 bands of equalizer, ranging from 100Hz to 16KHz.

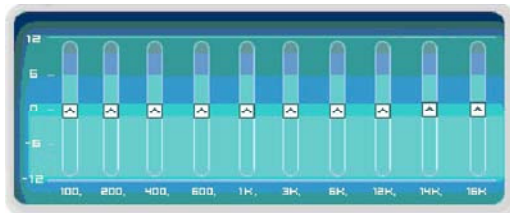

Save

The settings are saved permanently for future use

Reset

10 bands of equalizer would go back to the default setting

Enable / Disable

To disable, you can temporarily stop the sound effect without losing the settings

Load

Whenever you would like to use preload settings, simply click this, the whole list will be shown for your selection.

Delete

To delete the pre-saved settings which are created from previous steps.



Frequently Used Equalizer Setting

Realtek recognizes the needs that you might have. By leveraging our long experience at audio field, Realtek HD Audio Sound Manager provides you certain optimized equalizer settings that are frequently used for your quick enjoyment.

[How to Use It]

Other than the buttons “Pop” “Live” “Club” & “Rock” shown on the page, to pull down the arrow in “Others”, you will find more optimized settings available to you.

Karaoke Mode

Karaoke mode brings Karaoke fun back home. Simply using the music you usually play, Karaoke mode can help you eliminate the vocal of the song or adjust the key to accommodate your range.

- 1.Vocal Cancellation: Single click on “Voice Cancellation”, the vocal of the song would be eliminated, while the background music is still in place, and you can be that singer!
- 2.Key Adjustment: Using “Up / Down Arrow” to find a key which better fits your vocal range.

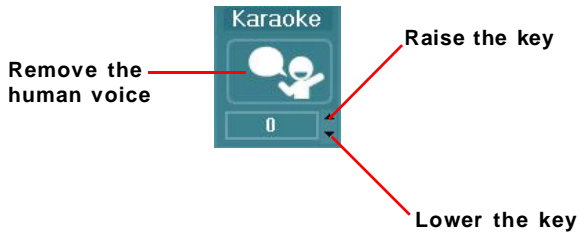

Mixer

In the **Mixer** part, you may adjust the volumes of the rear and front panels individually.

1. Adjust Volume

You can adjust the volume of the speakers that you plugged in front or rear panel.



Important

Before set up, please make sure the playback devices are well plugged in the jacks on the rear or front panel.

2. Multi-Stream Function

ALC888 supports an outstanding feature called Multi-Stream, which means you may play different audio sources simultaneously and let them output respectively from the indicated rear panel or front panel. This feature is very helpful when 2 people are using the same computer together for different purposes.

Click the  button and the Mixer **ToolBox** menu will appear. Then check the **Enable playback multi-streaming** and click **OK** to save the setup.



Important

You have to plug the device into the jacks on the rear and front panel first before enable the multi-stream function.

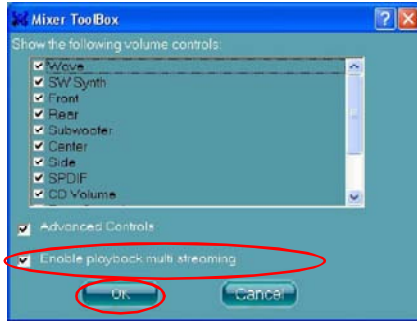

When you are playing the first audio source (for example: use Windows Media Player to play DVD/VCD), the output will be played from the rear panel, which is the default setting.

Then you **must** to select the **Realtek HD Audio 2nd output** from the scroll list **first**, and use a different program to play the second audio source (for example: use Winamp to play MP3 files). You will find that the second audio source (MP3 music) will come out from the Line-Out audio jack of Front Panel.



3. Playback control



Mute

You may choose to mute single or multiple volume controls or to completely mute sound output.

Tool

- Show the following volume controls

This is to let you freely decide which volume control items to be displayed.

- Advanced controls
- Enable playback multi-streaming

With this function, you will be able to have an audio chat with your friends via headphone (stream 1 from front panel) while still have music (stream 2 from back panel) in play. At any given period, you can have maximum 2 streams operating simultaneously.

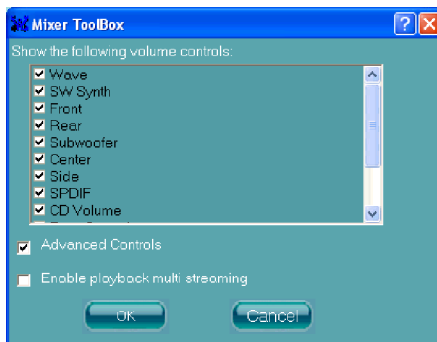

4. Recording control



Mute

You may choose to mute single or multiple volume controls or to completely mute sound input.

Tool

- Show the following volume controls

This is to let you freely decide which volume control items to be displayed.

- Enable recording multi-streaming



Important

ALC888 allows you to record the CD, Line, Mic and Stereo Mix channels simultaneously, frees you from mixing efforts. At any given period, you may choose 1 of the following 4 channels to record.

Audio I/O

In this tab, you can easily configure your multi-channel audio function and speakers. You can choose a desired multi-channel operation here.

- a. **Headphone** for the common headphone
- b. **2CH Speaker** for Stereo-Speaker Output
- c. **4CH Speaker** for 4-Speaker Output
- d. **6CH Speaker** for 5.1-Speaker Output
- e. **8CH Speaker** for 7.1-Speaker Output



Speaker Configuration:

1. Plug the speakers in the corresponding jack.
2. Dialogue “connected device” will pop up for your selection. Please select the device you have plugged in.
 - If the device is being plugged into the correct jack, you will be able to find the icon beside the jack changed to the one that is same as your device.
 - If not correct, Realtek HD Audio Manager will guide you to plug the device into the correct jack.

Connector Settings

Click  to access connector settings.



Disable front panel jack detection (option)

Jack detection function only works with HD audio front panel.

Mute rear panel output when front headphone plugged in.

Enable auto popup dialogue, when device has been plugged in

Once this item checked, the dialog "Connected device" would automatically pop up when device plugged in.

S/PDIF (optional, for HDMI graphics card only)

Short for Sony/Philips Digital Interface, a standard audio file transfer format. S/PDIF allows the transfer of digital audio signals from one device to another without having to be converted first to an analog format. Maintaining the viability of a digital signal prevents the quality of the signal from degrading when it is converted to analog.



Output Sampling Rate

44.1KHz: This is recommend while playing CD.

48KHz: This is recommended while playing DVD or Dolby.

96KHz: This is recommended while playing DVD-Audio.

192KHz: This is recommended while playing High quality Audio.

Output Source

No S/PDIF out: There will no S/PDIF out.

Output digital audio source: The digital audio format (such as .wav, .mp3, .midi etc) will come out through S/PDIF-Out.

Test Speakers

You can select the speaker by clicking it to test its functionality. The one you select will light up and make testing sound. If any speaker fails to make sound, then check whether the cable is inserted firmly to the connector or replace the bad speakers with good ones. Or you may click the **auto test**  button to test the sounds of each speaker automatically.

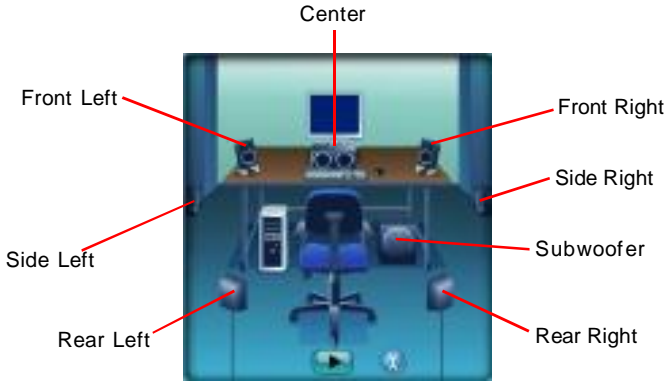

Microphone

In this tab you may set the function of the microphone. Select the **Noise Suppression** to remove the possible noise during recording, or select **Acoustic Echo Cancellation** to cancel the acoustic echo during recording.

Acoustic Echo Cancellation prevents playback sound from being recorded by microphone together with your sound. For example, you might have chance to use VOIP function through Internet with your friends. The voice of your friend will come out from speakers (playback). However, the voice of your friend might also be recorded into your microphone then go back to your friend through Internet. In that case, your friend will hear his/her own voice again. With AEC(Acoustic Echo Cancellation) enabled at your side, your friend can enjoy the benefit with less echo.



3D Audio Demo

In this tab you may adjust your 3D positional audio before playing 3D audio applications like gaming. You may also select different environment to choose the most suitable environment you like.



Information

In this tab it provides some information about this HD Audio Configuration utility, including Audio Driver Version, DirectX Version, Audio Controller & Audio Codec. You may also select the language of this utility by choosing from the **Language** list.

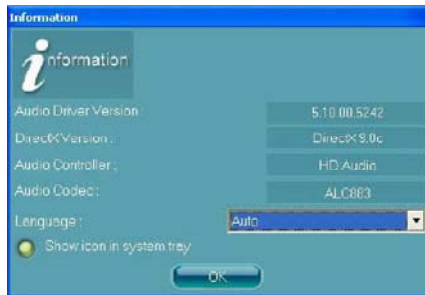

Also there is a selection **Show icon in system tray**. Switch it on and an icon  will show in the system tray. Right-click on the icon and the **Audio Accessories** dialogue box will appear which provides several multimedia features for you to take advantage of.



Hardware Setup

Connecting the Speakers

When you have set the Multi-Channel Audio Function mode properly in the software utility, connect your speakers to the correct phone jacks in accordance with the setting in software utility.

n 2-Channel Mode for Stereo-Speaker Output

Refer to the following diagram and caption for the function of each phone jack on the back panel when 2-Channel Mode is selected.

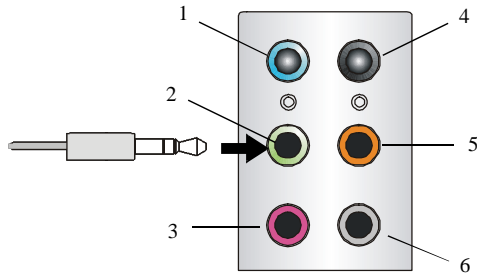

4-Channel Analog Audio Output

- 1 Line In
- 2 Line Out (*Front channels*)
- 3 MIC
- 4 No function
- 5 No function
- 6 No function

n 4-Channel Mode for 4-Speaker Output

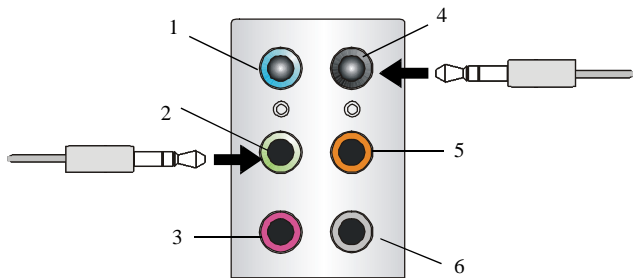

4-Channel Analog Audio Output

- 1 Line In
- 2 Line Out (*Front channels*)
- 3 MIC
- 4 Line Out (*Rear channels*)
- 5 No function
- 6 No function

n 6-Channel Mode for 6-Speaker Output

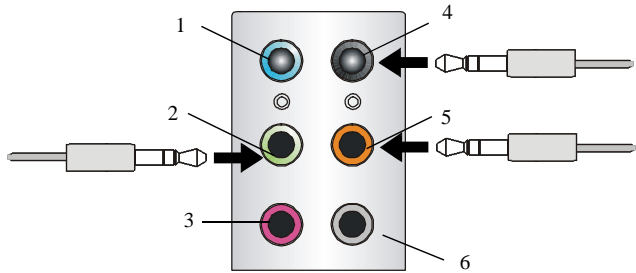

6-Channel Analog Audio Output

- 1 Line In
- 2 Line Out (*Front channels*)
- 3 MIC
- 4 Line Out (*Rear channels*)
- 5 Line Out (*Center and Subwoofer channel*)
- 6 No function

n 8-Channel Mode for 8-Speaker Output

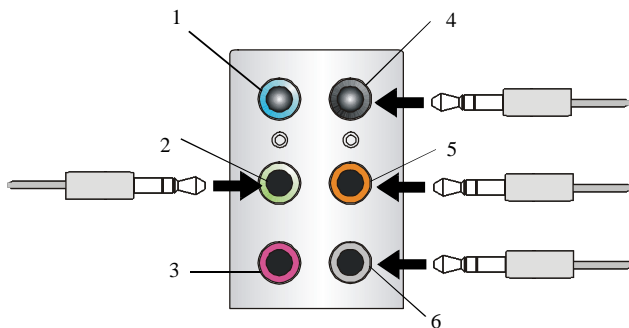

8-Channel Analog Audio Output

- 1 Line In
- 2 Line Out (*Front channels*)
- 3 MIC
- 4 Line Out (*Rear channels*)
- 5 Line Out (*Center and Subwoofer channel*)
- 6 Line Out (*Side channels*)

Free Manuals Download Website

<http://myh66.com>

<http://usermanuals.us>

<http://www.somanuals.com>

<http://www.4manuals.cc>

<http://www.manual-lib.com>

<http://www.404manual.com>

<http://www.luxmanual.com>

<http://aubethermostatmanual.com>

Golf course search by state

<http://golfingnear.com>

Email search by domain

<http://emailbydomain.com>

Auto manuals search

<http://auto.somanuals.com>

TV manuals search

<http://tv.somanuals.com>