



User's Manual

SP5050/SP5052/SP5054

IP Telephony Gateway, FXO Interface

Website: <http://www.micronet.info>

1. INTRODUCTION	3
1.1 FEATURES AND SPECIFICATION	3
1.2 APPEARANCE	4
2. SYSTEM OPERATING PROCEDURE	6
2.1 SYSTEM REQUIREMENT.....	7
2.2 TELEPHONE LINE REQUIREMENT	7
2.3 IP ENVIRONMENT SETTING	7
2.4 HYPER TERMINAL SETTING.....	7
3. INITIALIZING VOIP FXO GATEWAY SETTING.....	10
3.1 GATEKEEPER MODE	10
3.2 PEER-TO-PEER MODE.....	12
3.3 BEHIND IP-SHARING.....	13
4. DISCONNECT TONE CONFIGURATION	15
4.1 WHAT IS DISCONNECT TONE	15
4.2 HOW TO CONFIGURE DISCONNECT TONE ON VOIP FXO GATEWAY	15
4.3 ADJUST TONE TABLE PARAMETERS MANUALLY	16
4.4 ADJUST INPUT TONE LEVEL.....	17
5. COMMAND LISTS.....	18
5.1 [HELP] COMMAND	18
5.2 [QUIT] COMMAND.....	18
5.3 [DEBUG] COMMAND	18
5.4 [REBOOT] COMMAND.....	19
5.5 [FLASH] COMMAND	19
5.6 [COMMIT] COMMAND	20
5.7 [IFADDR] COMMAND.....	20
5.8 [TIME] COMMAND	21
5.9 [PING] COMMAND.....	21
5.10 [GREETRD] COMMAND.....	22
5.11 [PBOOK] COMMAND.....	24
5.12 [PPPOE]	26
5.13 [SYSCONF] COMMAND.....	26
5.14 [H323] COMMAND	30
5.15 [GK] COMMAND.....	32
5.16 [VOICE] COMMAND.....	33
5.17 [TOS] COMMAND	35
5.18 [TONE] COMMAND.....	36
5.19 [SUPPORT] COMMAND.....	36
5.20 [GROUP] COMMAND.....	37
5.21 [BUREAU] COMMAND	38
5.22 [PREFIX] COMMAND	40
5.23 [ROM] COMMAND	40
5.24 [PASSWD] COMMAND.....	42
6. UPGRADE THE VOIP FXO GATEWAY	43
TFTP/FTP SERVER.....	43
DOWNLOAD PROCEDURE.....	43
APPENDIX: WEB CONFIGURATION.....	45

1. Introduction

The Micronet SP5050 Series FXO gateway provides voice/fax service over IP network with H.323 v3 protocol. By connecting to your existing ADSL or cable modem service, which allows the use of a single, network for voice and fax services with consequent saving in network infrastructure and greatly reduced telephone charges. Ideal solution for providing low cost communications between headquarters and branch offices in the world, as well as for SOHO and office telephony applications.

Micronet SP5050 Series FXO Gateway provides analog lines to connect local PSTN/PTT interface (FXO), and converts voice/fax signal onto IP network. The management feature is via RS-232C COM port and TELNET.

1.1 Features and specification

General Features

- ITU-T H.323 v3 compliance
- Automatically Gatekeeper Discovery
- Peer-to-Peer mode (non-Gatekeeper)
- Support auto-attendant (2nddial Tone / Voice greeting)
- Line hunting
- 2(SP5052)/4(SP5054)/6(SP5050) RJ-11 FXO ports
- E.164 (Telephone Number Plan)
- DTMF dialing
- DTMF detection/generation
- TFTP software upgrade
- Remote configuration/reset via Telnet
- LED indication for system status
- LAN interface : One RJ-45 connector of 10Base-T
- Microsoft Netmeeting v3.0 compatible
- Support static IP and DHCP
- QoS by ToS (Type Of Service)
- SNTP (Simple Network Time Protocol)
- Security: Password setting

Audio feature

- Codec -- G.711 a/ μ law, G.723.1, G.729
- VAD (Voice Activity Detection), CNG (Comfort Noise Generate)
- G.168/165-compliant adaptive echo cancellation
- Dynamic Jitter Buffer
- Bad Frame Interpolation
- Call Transfer (H.450.2)
- Call Forward (H.450.3)
- Call Hold (H.450.4)
- Gain Settings
- Provide Call Progress Tone: Dial tone, busy tone, call-holding tone and ring-back tone

Management Features:

- Console port: RS-232C port
- TELNET
- HTTP Browser (e.g. Internet Explorer)

1.2 Appearance

Front panel: The LED light provides system message of Micronet SP5050 Series.

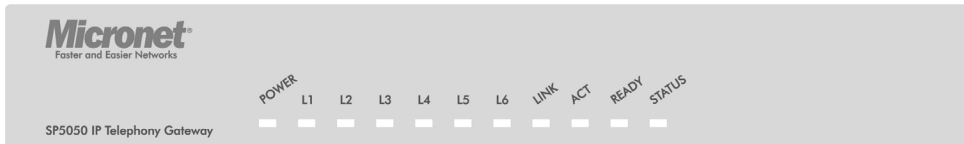

Front panel of SP5050

Power : Light on means Micronet SP5050 Series is power on.

L1-L6 : Light on means the line is in use.

Link : Light on means Micronet SP5050 Series is connected to the network correctly.

Act : LED should be light on and in flash display when data is transmitting.

Ready : 1. Light on and in slow flash means Micronet SP5050 Series is in operation mode.

Status : 1. Light on means Micronet SP5050 Series successfully registered to Gatekeeper when it is set as Gatekeeper Mode.

2. LED flash means Micronet SP5050 Series is not registered to Gatekeeper when it is set as Gatekeeper Mode.

3. Or when Micronet SP5050 Series is in downloading mode, LED should be flash as well.

4. Light off means Micronet SP5050 Series is in Peer-to-Peer Mode.

Back panel:

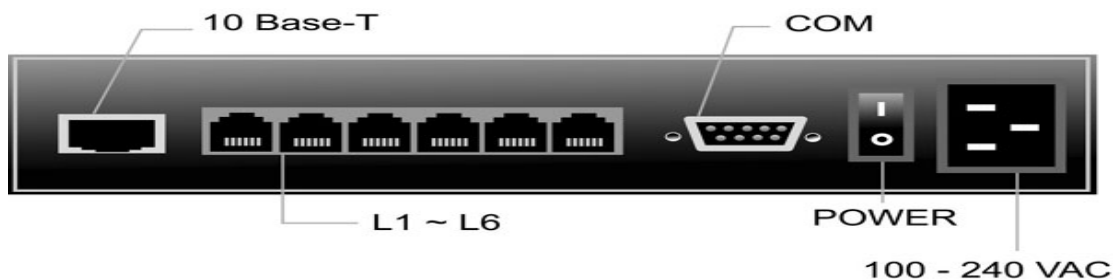

Back panel of SP5050

10 Base-T: RJ-45 Modular Jack Female connector with 10 Mbps Ethernet.

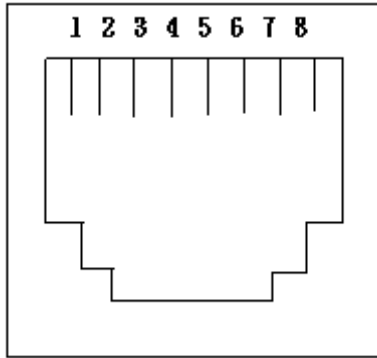

PIN 1, 2: Transmit
 PIN 3, 6: Receive

COM: RS232 console port (9-pin Male connector, as the same as the computer).

Male connector (as the same as the PC)



9 PIN D-SUB MALE at the VoIP FXO gateway

Pin	Name	Dir	Description
2	RXD	←	Receive Data
3	TXD	→	Transmit Data
5	GND	—	System Ground

L1 ~ L6: RJ-11 (PSTN or Extension Line of PBX)

On / Off: Power switch on/off.

100 - 240 VAC: AC Power supply.

2. System Operating Procedure

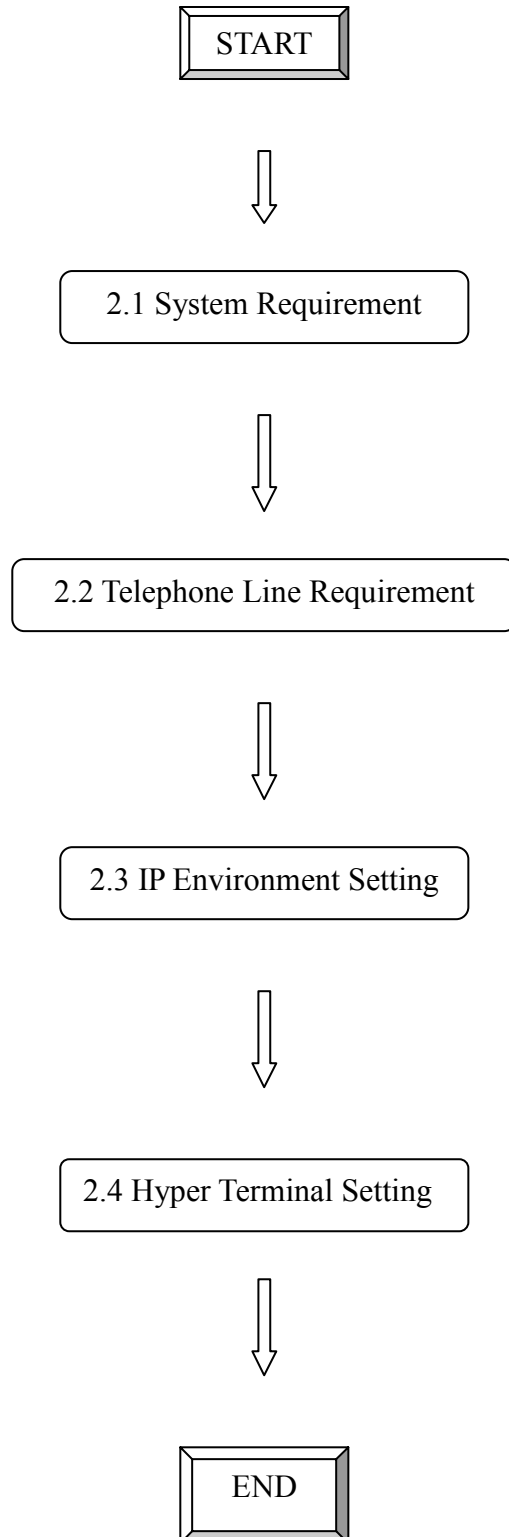

2.1 System Requirement

1. One PC (a) Pentium 100 or above, 64 MB DRAM, Windows 98 or above.
(b) Network card (RJ-45) & COM port
2. One standard RS-232 straight cable with **two female connectors** depended on the different model.
3. PSTN lines / PBX extension lines (up to 4 lines).
4. Software tools (a) Hyper terminal, telnet (Windows OS included) (b) Gatekeeper (optional)

2.2 Telephone Line Requirement

Two kinds of analog lines can be connected to RJ-11 of VoIP FXO Gateway.

1. PSTN (Public Switched Telephone Network, POTS) or
2. PABX (Private Automatic Branch Exchange) / PBX (Private Branch Exchange) extension line.

PSTN

1. It is necessary to provide PSTN/POTS telephone lines in order to plug into RJ-11 of VoIP FXO Gateway.
2. The maximum telephone lines are up to 6 which is dependent on different model.

PABX / PBX

1. PSTN lines can be replaced to the extension lines of PBX.

<p>Note: Since the Line function feature starts from L1, please plug telephone lines from L1.</p>
--

2.3 IP Environment Setting

User must prepare a valid IP address to be complied IP Network policy in order for VoIP FXO gateway operating correctly.

For example, if your company's IP address is 192.168.4.111, subnet mask is 255.255.0.0, default gateway is 192.168.1.254, you should prepare one IP for VoIP FXO gateway, such as IP address is 192.168.4.99, and same subnet mask and default gateway.

2.4 Hyper Terminal Setting

1. Execute the Hyper Terminal program. Following windows pop-up on the screen. (START – Program files – Accessories – Communication – Hyper Terminal)

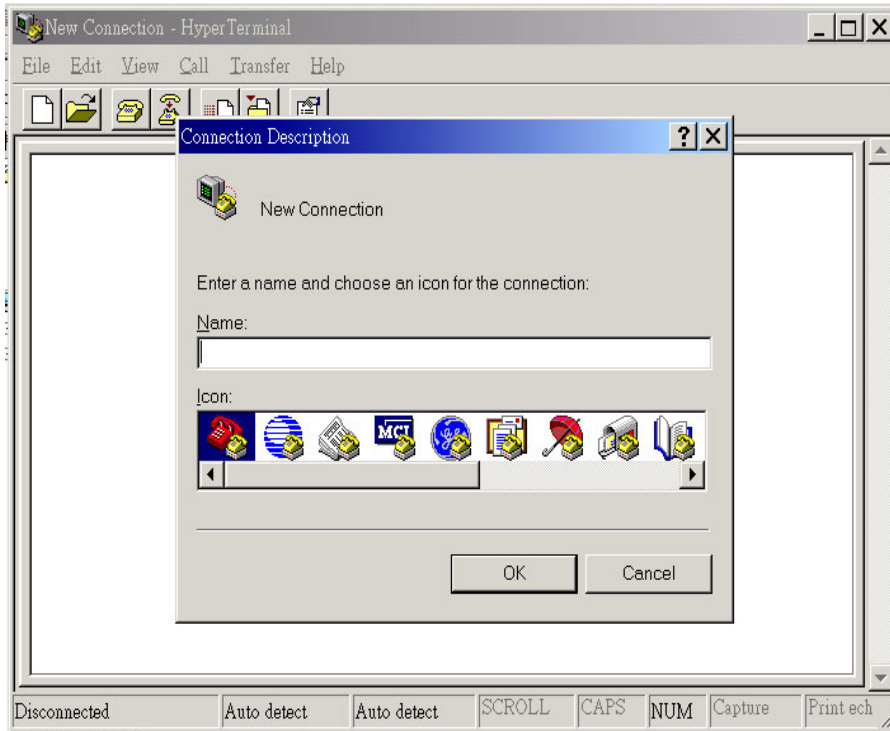

2. Define a name such as 'SP5050 Gateway' for this new connection.



3. After pressing OK button, the next window popping up is necessary to connect choose COM Port.



Note: Some connection failed is derived the PC COM Port. If user cannot open the com port, for example com 1, please try another com port, ex.com port 2.

4. Configure the COM Port Properties as following:
- (1) Bits per second : 9600
 - (2) Flow control : None

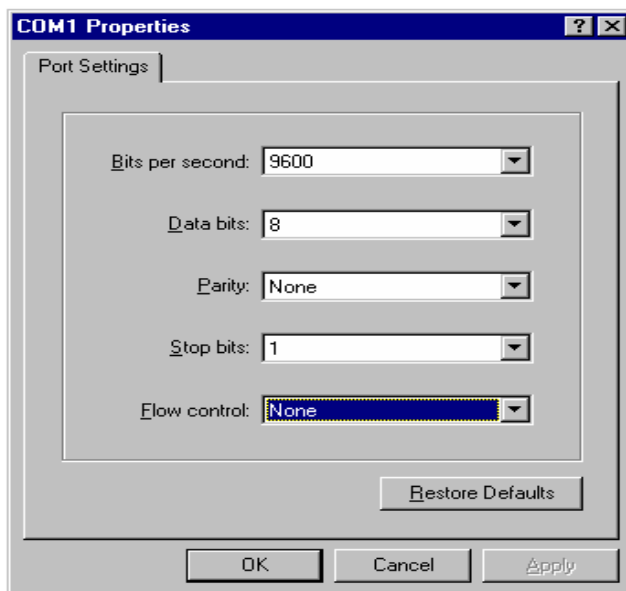

Press 'OK' button, and start to configure VoIP FXO gateway.

3. Initializing VoIP FXO Gateway Setting

3.1 Gatekeeper Mode

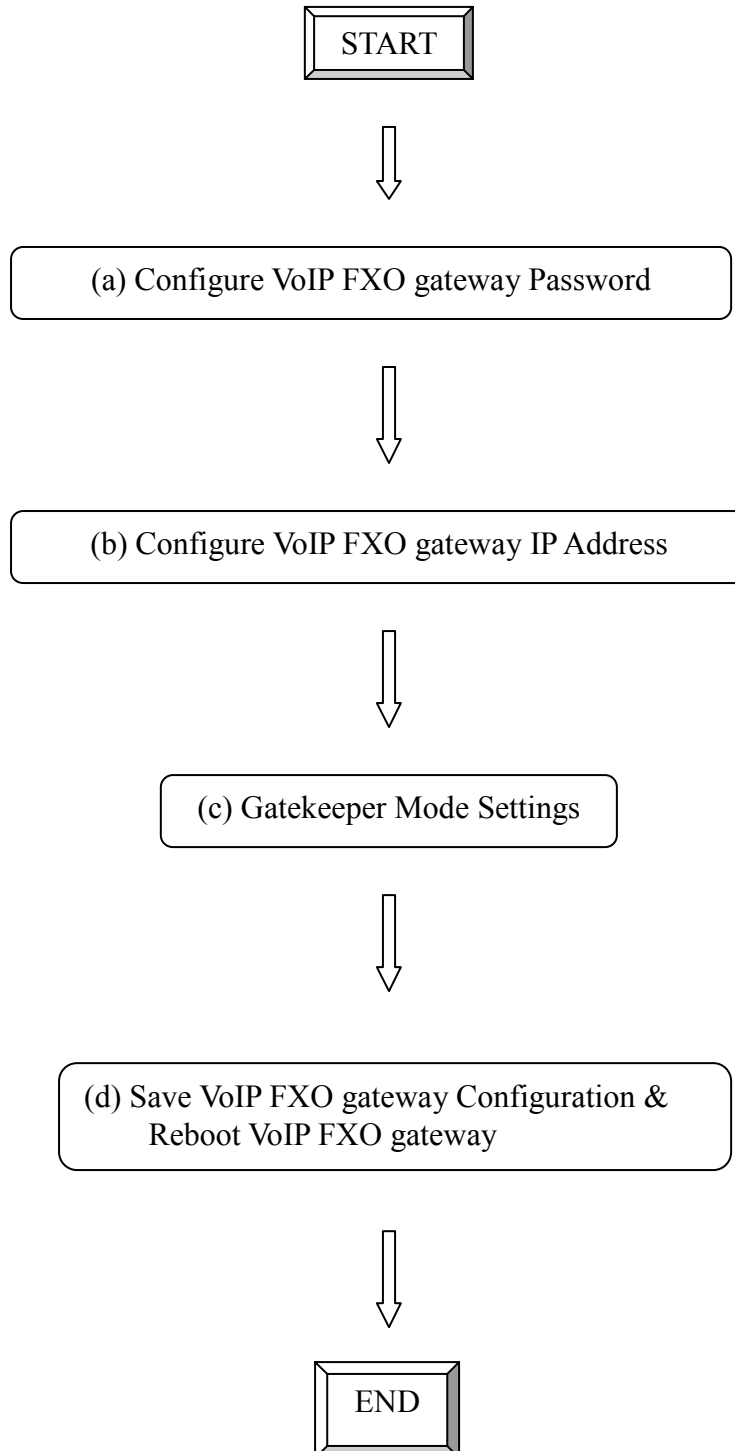

(a) Configure VoIP FXO gateway Password

It is important for the first time user to follow the operation procedure.

1. Power on the VoIP FXO gateway and the sentence "Please wait while system is initializing.....S" is displayed.

```
Attached TCP/IP interface to cpm unit 0  
Attaching interface lo0...done
```

```
Please wait while system is initializing ..... S
```

2. Wait around 40 seconds, the login name and password are requested.

```
Attached TCP/IP interface to cpm unit 0  
Attaching interface lo0...done  
AC4804[0] is OK  
AC4804[1] is OK  
AC4804[2] is OK  
Successful
```

```
Initialize OSS libraries...OK!  
open stack successful  
cmInitialize succeed!  
GK mode selected.
```

```
login:
```

3. Login: when VoIP FXO gateway is used for the first time, "root" is default login name without a password.
4. Password setting: type "passwd -set root ****" to define a password for "root" account. "****", in above description, stands for contents of the password. An example, to set **root**'s password as **good**, is demonstrated as following:

```
usr/config$ passwd -set root good
```

```
Setting  
login: root  
Password: good  
OK
```

(b) Configure VoIP FXO gateway IP Address

Use “**ifaddr**” command to set up VoIP FXO gateway’s IP address and related network information. An example is demonstrated below:

```
usr/config$ ifaddr -ip 10.1.1.1 -mask 255.255.255.0 -gate 10.1.1.254
```

Note:

this is to assign VoIP FXO gateway an IP address of “10.1.1.1”, subnet mask “255.255.255.0”, and default IP gateway “10.1.1.254”.

(c) Gatekeeper Mode Settings

To assign a gatekeeper address for VoIP FXO gateway, and define its own registered ID and phone number. For detail, please refer to *Chapter 5.14 [h323] command*.

Several H323 parameters are important setting gatekeeper mode: “**-gk**”, “**-e164**”, and “**-alias**”. An example is demonstrated below:

```
usr/config$ h323 -mode 0 -gk 10.2.2.2 -e164 -alias fxo
```

Note:

This is to set mode as gatekeeper mode, gatekeeper IP address as “10.2.2.2”, e.164 number as “1”, and alias name (h323ID) as “fxo” on the VoIP FXO gateway.

(d) Save VoIP FXO Gateway Configuration & Reboot VoIP FXO gateway

1. Confirming the values, type **commit** and press **enter** to save all the changes you have done.
2. Type **reboot** and press **enter** to reboot the VoIP FXO gateway.
3. Wait for VoIP FXO gateway initializing in gatekeeper mode.

3.2 Peer-to-Peer Mode

Peer-to-Peer Mode allows users to call other VoIP devices without using a gatekeeper. When in Peer-To-Peer mode, VoIP FXO gateway will send SETUP message directly to the destination IP address once the dial is finished. Users have 2 methods of dial. One is IP dialing, and the other is phone book dial, which we will describe later. When using IP address as destination phone number, press “*” as “.” in IP address expression, and press “#” when dial is finished. When using Phone book, users can dial predefined phone number, and press “#” (optional, to accelerate the dial) as end of dial.

To configure Peer-To-Peer Mode in VoIP FXO gateway, follow the steps below:

1. Set Peer-To-Peer Mode, using “h323” command

```
usr/config$ h323 -mode 1
```

Note: mode 1 is for Peer-To-Peer (non-gk) mode, while mode 0 is for GK mode.

2. Configure Phonebook, using “pbook” command.

Users can refer to chapter 5.11 [pbook] command for more information.

```
usr/config$ pbook -add name TEST1 ip 10.1.1.1 e164 10
```

Note:

The command is to add a record onto Phonebook. After the command completed, you can type “pbook -print” to see if the input record is correct. When adding a record to Phonebook, users do not have to reboot the machine, the record will be effective immediately.

3.3 Behind IP-Sharing

The function is for user whose network environment is behind IP Sharing device. It is said VoIP FXO gateway is connected to the IP Sharing device. An example such as ADSL network is in the following.

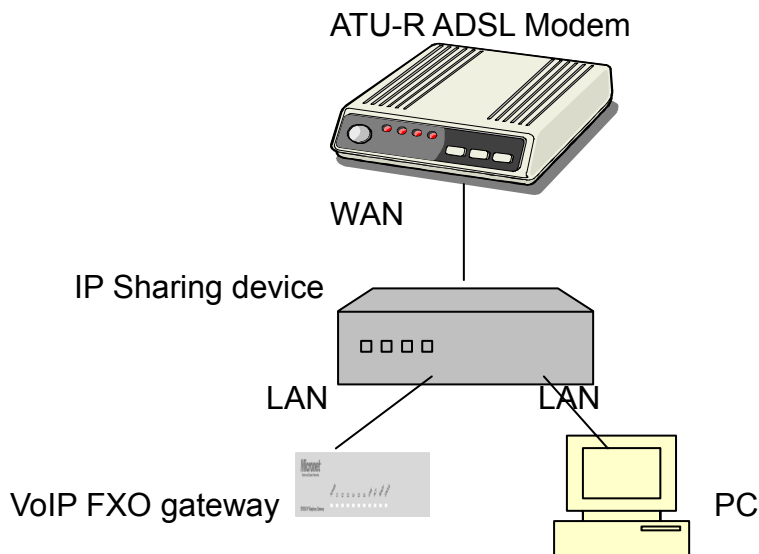

- The WAN IP address obtained from ADSL has two kinds of methods. One is fixed IP Address, while user applies for one or more fixed IP Addresses. Another is dynamic IP Address while user applies for dial-up connection way.
- The LAN IP address of user's PC can be set as DHCP client in order to gain a valid one.
- Another IP address for VoIP FXO gateway must be set as a fixed one in order for that IP sharing device pass forwarding the relevant information from WAN to LAN. Besides, a valid IP address which meets the IP sharing device (LAN site) is the element.
- VoIP FXO gateway must enable the IP sharing function for the fixed / dynamic WAN IP Address.

Fixed IP Address – `usr/config$ ifaddr -ipsharing 1 210.11.22.33`

Dynamic IP Address `–usr/config$ ifaddr –ipsharing 1`

Note:

With Dynamic WAN IP Address, a Gatekeeper with a valid IP address for VoIP FXO gateway is a must. *In other word, it is not workable in Peer-to-Peer mode while dynamic WAN IP Address.*

IP Sharing device must have a function to do IP/Port mapping. Some is named as DMZ, some is named as virtual server. The VoIP messages from WAN have to completely pass forward to the LAN. It is said if the VoIP FXO gateway is assigned a virtual fixed IP Address such as 192.168.1.5, IP sharing device must forward the VoIP messages to 192.168.1.5.

4. Disconnect Tone Configuration

This application note is going to describe the procedures of configuring the disconnect tone on VoIP FXO gateway in order to release LINE ports of VoIP FXO gateway after PSTN/PBX caller party is hung up.

4.1 What is Disconnect Tone

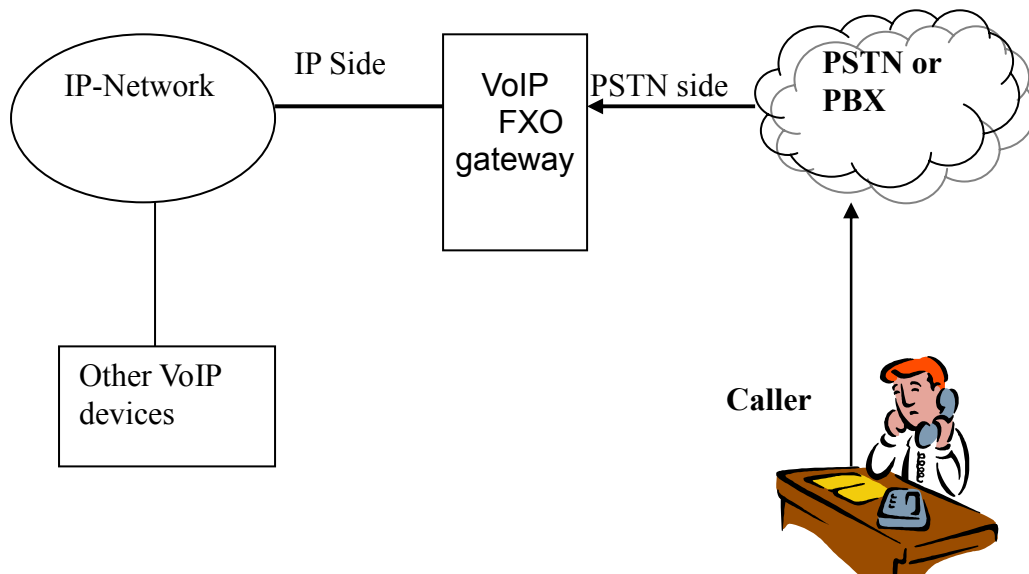

A caller make a telephone call to gateway from PSTN side, VoIP FXO gateway will answer the call automatically. If the IP side of other VoIP devices do not answer the call and the caller hang up the call, the PSTN/PBX will give gateway a disconnect tone automatically. Or, VoIP FXO gateways are installed on both siedad and connect to local PSTN. If both parties are in talking mode and one side hang up the call. the VoIP FXO gateway has to recognize the disconnect tone from local PSTN and release the line port with the pre-defined busy tone or reorder tone in VoIP FXO gateway tone table.

There are three parameters received from PSTN/PBX.

- High level frequency and Low level frequency
- Tone Cadence (ON/OFF intervals)
- Tone level

These parameters have to be properly configured in VoIP FXO gateway in order to recognize disconnect tone correctly. Each different PSTN/PBX have different parameters. So, VoIP FXO gateway has to configure tone table when line port connect to different PSTN/PBX.

4.2 How to configure disconnect tone on VoIP FXO gateway

VoIP FXO gateway has a default setting of disconnect tone (Busy tone 1, Busy tone 2, reorder tone 1 and reorder tone 2). If the disconnect tone was recognized correctly, the line port from PSTN/PBX will be released in seconds.

Otherwise it may be released after one minute or lock this LINE permanently. The tone table parameters are shown as follows.

LowFreq 480 : Low frequency is 480 HZ
HighFreq 620 : High frequency is 620 HZ
LowFreqLevel 8 : Low frequency level received range from PSTN/PBX
HighFreqLevel 8 : High frequency level received range from PSTN/PBX
TOn1 50 : Disconnect tone cadence ON time is 0.5 seconds
TOff1 50 : Disconnect tone cadence OFF time is 0.5 seconds
(If this is continuous tone, the Toff has to set to 1023)
TOn2 1023 : Disconnect tone second cycle cadence ON time is OFF
TOff2 1023 : Disconnect tone second cycle cadence OFF time is OFF
(If the tone cadence has only one cycle, the second cycle must set to 1023)

(1) Examples how to configure Tone table

a. 480/620 frequency with ON/OFF time is 0.5 seconds
tone -busy1 480 620 8 8 50 50 1023 1023

b. 480 HZ single frequency with continuous tone
tone -reorder2 480 0 8 0 50 1023 1023 1023

(2) There are two ways to analyze the disconnect tone.

a. The first one is using command "greetrd" from VoIP FXO gateway. Once you follow the instruction to analyze the disconnect tone, gateway will configure the tone table (Busy tone 1, Busy tone 2, reorder tone 1 and reorder tone 2) with proper frequency and default tone level and cadence (Ton1/Toff1) automatically. Or you may read the analysis tone frequency from command line and configure to one of tone table manually.

The default tone level is set to 8. And the tone cadence (Ton1/Toff1) is set to four different values on tone table. They are 0.1 second, 0.25 seconds, 0.5 seconds and 0.75 seconds with parameters 10/10, 25/25, 50/50 and 75/75.

If the PBX/PSTN cadence is not the value as default shown as above, you need to use the following instruction to analyze ON/OFF intervals.

b. You may use your PC (START → Program Files → Accessories → Multimedia → Recorder) with Headset or Microphone to record the disconnect tone via a telephone set from PSTN/PBX and save to a voice file. Then you can use "CoolEdit Pro" software to analyze the frequency and ON/OFF time. Please visit <http://www.cooledit.com> to download demo version for analysis. You can use this program to analyze ON/OFF time and fill in to tone table.

4.3 Adjust Tone Table parameters manually

If the gateway still cannot release the LINE port in two seconds, try to adjust the frequency by 1 hz on tone table. For example, your analysis value is

620/480, take the following procedures.

620/479
620/480
620/481
621/479
621/480
621/481
619/479
619/480
619/481

If the line port of gateway was locked, please use "hangup 0" command to release LINE 1, "hanhup 1" to release LINE 2...etc.

4.4 Adjust Input Tone Level

Sometimes the disconnect tone level is too low to be detected by VoIP FXO gateway. You can increase input gain from the following command.

```
voice -volume input xx  
commit  
reboot
```

xx is the input gain parameters. The maximum number is 35. if the number is over 35, the echo may be happened. Once you increase input gain, the voice volume from PSTN to IP side is increased too.

5. Command lists

5.1 [help] command

Type **help** or **man** or **?** to list all the available command.

```
usr/config$ ?
help      help/man/? [command]
quit      quit/exit/close
debug     show debug message
reboot    reboot local machine
flash     clean configuration from flash rom
commit    commit flash rom data
ifaddr    internet address manipulation
time      show current time
ping      test that a remote host is reachable
greetrd   Greeting voice and Disconnect tone Record mode
pbook     Phonebook information and configuration
sysconf   System information manipulation
h323      H.323 information manipulation
voice     Voice information manipulation
gk        H.323 gatekeeper manipulation
tos       IP Packet ToS (Type of Service)values
tone      Setup of call progress tones
support   Special Voice function support manipulation
group     Grouping setting information and configuration
bureau    Bureau line information manipulation
prefix    Prefix information manipulation
rom       ROM file update
passwd    Password setting information and configuration
```

usage: help [command]

5.2 [quit] command

Type quit will quit the VoIP FXO gateway configuration mode. And turn back to login prompt.

```
usr/config$ quit
Disconnecting...
login:
```

Note:

It is recommended that type the “quit” command before you leave the console. If so, VoIP FXO gateway will ask password again when next user connects to console port.

5.3 [debug] command

Open debug message will show up specific information while VoIP FXO gateway is in operation. After executing the debug command, it should execute command **debug -open** as well. One example is demonstrated below.

```
usr/config$ debug -add h323 vp
usr/config$ debug -open
```

Parameters Usage:

-status	Display the enabled debug flags.
-add	Add debug flag. -- h323 : h323 related information -- vp : voice related information
-delete	Remove specified debug flag.
-open	Start to show debug messages.
-close	Stop showing debug messages.

5.4 [reboot] command

After **commit** command, type **reboot** to reload VoIP FXO gateway in new configuration. The procedure is as below:

```
usr/config$ reboot
Attached TCP/IP interface to cpm unit 0
Attaching interface lo0...done
AC4804[0] is OK
AC4804[1] is OK
AC4804[2] is OK
Successful
```

```
Initialize OSS libraries...OK!
open stack successful
cmlInitialize succeed!
GK mode selected.
```

```
login:
```

5.5 [flash] command

This command will clean the configuration stored in the flash rom and reboot VoIP FXO gateway in factory default setting.

Parameter Usage:

-clean	clean all the user-defined value, and reboot VoIP FXO gateway in factory default mode.
--------	--

Note:

It is recommended that use "flash -clean" after application firmware id upgraded.

Warning: Once users execute **flash –clean**, all the configurations of VoIP FXO gateway will be cleaned. This can only be executed by user who log in with **root**

5.6 [commit] command

Save changes after configuring the VoIP FXO gateway.

```
usr/config$ commit
```

This may take a few seconds, please wait...

Commit to flash memory ok!

```
usr/config$
```

Note:

Users should use **commit** to save modified value, or they will not be activated after system reboot.

5.7 [ifaddr] command

Configure and display VoIP FXO gateway network information.

```
usr/config$ ifaddr
```

LAN information and configuration

Usage:

```
ifaddr [-print][-dhcp used][-sntp mode [server]]
```

```
ifaddr [-ipsharing used [deviceAddr]]
```

```
ifaddr [-ip ipaddress] [-mask subnetmask] [-gate defaultgateway]
```

<i>-print</i>	<i>Display LAN information and configuration.</i>
<i>-ip</i>	<i>Specify VoIP FXO gateway ip address.</i>
<i>-mask</i>	<i>Set Internet subnet mask.</i>
<i>-gate</i>	<i>Specify default gateway ip address</i>
<i>-dhcp</i>	<i>Set DHCP client service flag (On/Off).</i>
<i>-sntp</i>	<i>Set SNTP server mode and specify IP address.</i>
<i>-timezone</i>	<i>Set local timezone.</i>
<i>-cmcenter</i>	<i>Set Management Center IP Address.</i>
<i>-ipsharing</i>	<i>Specify usage of an IP sharing device and specify IP address.</i>

Note:

Range of ip address setting (0.0.0.0 ~ 255.255.255.255).

DHCP client setting value (On=1, Off=0). If DHCP set to 'On',

Obtain a set of Internet configuration from DHCP server assigned.

SNTP mode (0=no update, 1=specify server IP, 2=broadcast mode).

Example:

```
ifaddr -ip 210.59.163.202 -mask 255.255.255.0 -gate 210.59.163.254
```

```
ifaddr -dhcp 1
```

```
ifaddr -sntp 1 210.59.163.254
```

```
ifaddr -ipsharing 1 210.59.163.254
```

ifaddr -timezone 8

Parameters Usage:

- print print current IP setting
- ip assigned IP address for VoIP FXO gateway
- mask internet subnet mask
- gate IP default gateway
- dhcp Dynamic Host Configuration (1 = ON; 0 = OFF)
- sntp Simple Network Time Protocol (1 = ON; 0 = OFF) When SNTP function is activated, users have to specify a SNTP server as network time source. An example is demonstrated below:

```
usr/config$ ifaddr -sntp 1 10.1.1.1
```

while 10.1.1.1 stands for SNTP server's IP address.

- timezone Set timezone for VoIP FXO gateway. User can set different time zone according to the location VoIP FXO gateway. For example, in Taiwan the time zone should be set as 8, which means GMT+8.
- cmcenter Set management center IP address. IF user specifies management center IP address, VoIP FXO gateway will send information to management center, let user can easily configure via management center interface. (sysconf -cmcenter "IP address of management center")

Note:

Mmanagement center is optional software to help user can easily configure Micronet products, please contact your reseller to know more about it.

- ipsharing Specify usage of an IP sharing device and IP address. If VoIP FXO gateway is behind a IP-sharing , user can enable IP sharing function and specify public IP address of IP sharing device.

5.8 [time] command

When SNTP function of VoIP FXO gateway is enabled and SNTP server can be found as well, type time command to show current network time.

```
usr/config$ time  
Current time is THU JAN 01 05:29:23 1970
```

5.9 [ping] command

Use **ping** to test whether a specific IP is reachable or not. For example: if 192.168.1.2 is not existing while 210.63.15.32 exists. Users will have the following results:

```
usr/config$ ping 210.54.23.129  
PING 210.54.23.129: 56 data bytes
```

```

no answer from 210.54.23.129
usr/config$ ping 192.168.4.121
PING 192.168.4.121: 56 data bytes
64 bytes from 192.168.4.121: icmp_seq=0. time=5. ms
64 bytes from 192.168.4.121: icmp_seq=1. time=0. ms
64 bytes from 192.168.4.121: icmp_seq=2. time=0. ms
64 bytes from 192.168.4.121: icmp_seq=3. time=0. ms
----192.168.4.121 PING Statistics----
4 packets transmitted, 4 packets received, 0% packet loss
round-trip (ms)  min/avg/max = 0/1/5

```

5.10 [greetr] command

This command is for user to record their own greeting and analyze disconnect tone. If VoIP FXO gateway can't hang up call and release line correctly, please use this function to analyze disconnect tone of PSTN side.

Greeting Voice Record : please follow instructions on screen (Selection 1). First, call in line1 of VoIP FXO gateway from PSTN side(now can't hear greeting) and press "enter" to start record .After finishing recording, please press "enter" again to stop recording. Then choose "y/n" to replay and save or not.

```

usr/config$ greetr
=====
                Welcome to Voice Record/Analysis Mode
-----
1.Greeting Voice Record.
2.Disconnect Tone Analysis.
3.exit.
-----
Please input function(1~3): 1

1.Greeting Voice Record.

Please Dial-in "Line 1" and press "Enter" to start record!!!

Press "Enter" to stop record!!!
Starting record...

Stoped record!!!

                New Greeting Voice Infomation
-----

                File size    :    0 (K bytes)
                Totally time:    8 (seconds)

Do not Hang up the phone!!
Please wait for Writing...block 0

```

Please wait for Writing...block 1

Please wait for Writing...block 2

Replay New Greeting Voice?(y/n):

Disconnect Tone Analysis : please follow instructions on screen (Selection 2). First call in line1 of VoIP FXO gateway from PSTN side (now can't hear greeting), hang up the phone and press "enter" to start record disconnect tone. Finally, choose "y/n" to save data analyzed or not. Notice that system will save one set of frequency analyzed and 4 set different on/off time in "busytone1","busytone2" , "reordertone1" , "reordertone2" (Please refer to tone command) .

If VoIP FXO gateway still can't hang up call correctly, it could be tone cadence issue (on/off time). Please count on/off time and configure it into tone command.

usr/config\$ greetrd

=====

Welcome to Voice Record/Analysis Mode

- 1.Greeting Voice Record.*
- 2.Disconnect Tone Analysis.*
- 3.exit.*

Please input function(1~3): 2

2.Disconnect Tone Analysis.

*Please Dial-in "Line 1" and then Hang up the phone!!!
Press "Enter" to start record!!!*

*Waiting for Disconnect Tone from PSTN....
Disconnect Tone Detected....
Starting Record...*

Set parameters to flash? (Y/N)

exit : exit this command

usr/config\$ greetrd

=====

Welcome to Voice Record/Analysis Mode

- 1.Greeting Voice Record.*
- 2.Disconnect Tone Analysis.*

3.exit.

Please input function(1~3): 3

Are you sure to EXIT?!(y/n): y

usr/config\$

5.11 [pbook] command

Phone Book function allows users to define their own numbers, which mapping to real IP address. It is effective only in peer-to-peer mode. When adding a record to Phone Book, users do not have to reboot the machine, and the record will be effective immediately.

usr/config\$ pbook

Phonebook information and configuration

Usage:

pbook [-print [start_record] [end_record]]

pbook [-add [ip ipaddress] [name Alias] [e164 phonenumber]]

pbook [-search [ip ipaddress] [name Alias] [e164 phonenumber]]

pbook [-insert [index] [ip ipaddress] [name Alias] [e164 phonenumber]]

pbook [-delete index]

pbook [-modify [index] [ip ipaddress] [name Alias] [e164 phonenumber]]

-print Display Phonebook data.

-add Add an record to Phonebook.

-search Search an record in Phonebook.

-delete Delete an record from Phonebook.

-insert Insert an record to Phonebook in specified position.

-modify Modify an exist record.

Note:

If parameter 'end_record' is omitted, only record 'start_record' will be display.

If both parameters 'end_record' and 'start_record' are omitted, all records will be display.

Range of ip address setting (0.0.0.0 ~ 255.255.255.255).

Range of index setting value (1~100),

Example:

pbook -print 1 10

pbook -print 1

pbook -print

pbook -add name Test ip 210.59.163.202 e164 1001

pbook -insert 3 name Test ip 210.59.163.202 e164 1001

pbook -delete 3

pbook -search ip 192.168.4.99

pbook -modify 3 name Test ip 210.59.163.202 e164 1001

Parameter Usages:

-print print out current contents of Phone Book. Users can also add *index number*, from 1 to 100, to the parameter to show specific

phone number.

Note: *<index number> means the sequence number in phone book. If users do not request a specific index number in phone book, VoIP FXO gateway will give each record a automatic sequence number as index.*

- add add a new record to phone book. When adding a record, users have to specify **name**, **ip**, and **e164** number to complete the command.
- search search a record in phone book. The searching criteria can be **name**, **ip**, or **e164**.
- delete delete a specific record. "pbook -delete 3" means delete **index 3** record.
- insert add a new record and force to assign a specific index number for it.
- modify modify an existing record. When using this command, users have to specify the record's index number, and then make the change.

Phonebook Rules:

To meet the requirements of communicating with trunk gateway or other applications, Phonebook has following characteristics to be noticed.

When the destination side is a terminal, for ex: IP Phone or soft phone, e164 number stands for exact destination phone number.

When the destination side is a gateway, for ex: T1/E1 gateway, e164 phone number stands only for gateway prefix. That is, users have to continue to dial destination number, following the prefix number. An example is as below: A is a VoIP FXO gateway and B is a E1 Trunk gateway, which is connected to PSTN with E1 PRI. There's a record in A's phone book

<i>Index</i>	<i>Name</i>	<i>IP</i>	<i>E164</i>
<i>1</i>	<i>B_gateway</i>	<i>192.168.1.2</i>	<i>0</i>

If users want to make a call to PSTN number "82265699", they have to make a call to connect to VoIP FXO gateway A, and then dial "082265699". After receiving the complete dialed number, VoIP FXO gateway A will search for its Phone Book, find "0" as matched prefix, and then dial out to B's IP address directly with destination e.164 (phone number) "82265699". Pleased be noted that "0" is eliminated from VoIP FXO gateway itself.

Note:

Because of above characteristics, users have to take care of the number plan very well to avoid the numbering conflict. If users already defined "0" for specific trunk gateway, other terminal started with "0" shall be avoided, or the number will be routed to the trunk gateway defined "0".

5.12 [pppoe]

Display PPPoE related information.

PPPoE device information and configuration

Usage:

pppoe [-print][/-open][/-close]

pppoe [-dev on/off][-id username][-pwd password]

-print Display PPPoE device information.
-dev Enable(=1) or Disable(=0) device.
-open Open PPPoE connection.
-close Disconnect PPPoE connection.
-id Connection user name.
-pwd Connection password.
-reboot Reboot after remote host disconnection.

Parameter Usage:

-print print PPPoE status.
-dev Enable PPPoE Dial-up function
-open Open the connection
-close Close the connection
-id Input the User name ID provided by ISP
-pwd Input the User name password provided by ISP
-reboot Reboot the PPPoE connection.

5.13 [sysconf] command

This command displays the system information and configuration.

usr/config\$ sysconf

System information and configuration

Usage:

Sysconf [-service type] [-plan digits] [-2nddial flag]

[-keypad dtmf] [-ringdet method] [-callalive flag]

[-port s1 s2 s3 s4]

[-seizure mode] [-2nddial switch]

[-drule [in_filter str1] [in_drop str2] [in_insert str3]

[out_filter str4] [out_drop str5] [out_insert str6]]

[-askpin f] [-pincode [set1 pin1] [set2 pin2] [set3 pin3] [set4 pin4]]

sysconf -print

-print Display system overall information and configuration.
-service Specify gateway service type.
(0: Dial in service,2: HotLine/LineToLine service.)
-ringdet Specify gateway ring detect method. (0:For 1st hardware
version,
1:For 2st hardware version.
-plan Number of digits for dial plan. (any positive number.)
-port Enable/Disable individual port.

- idto The duration of two pressed digits in dial mode
- eod Digit type of end of dialing. (0:No end of dialing, 1:[*] button,
2:[#] button)
- seizure Choose line seizure mode (None/UCD).
- 2nddial Config GW to accept 2nd dtmf set. In this mode, device from IP side needs to dial GW's E164, wait for PSTN dialtone, and then dial out.
- drule Specify digits to be filtered/dropped/inserted before making an outgoing IP call or after receiving an incoming IP call.
- askpin PIN code prompt before greeting.
0:Disable 1:Per Unit 2:Per Channel.
- ring Ring number before answer.
0:Disable, other is number of ring (1 ~ 5).
- callalive Enable or disable auto-disconnection after 10 seconds
- keypad DTMF setting: 0=In-band, 1=H.245 Alphanumeric, 2=H.245 SignalType, 3=Q.931 UserInfo. , 4=RFC2833.
- pincode Specify 6 of PIN codes.
- sendxcode Send access code after connection.
0:Disable 1:Enable.
- access Specify access codes.

Note:

Use character 'x' to delete the drule parameter.

For line seizure 0: None, 1: UCD.

For askpin: f=0: No, f=1: Yes.

Direct in line feature should be used together with:

`$sysconf -2nddial 0 (2nddila off)`

`$h323 -mode 0 (Gatekeeper mode)`

`$bureau -print` for Direct in line table configuration

Hotline feature should be used together with:

`$sysconf -2nddial 0 (2nddial off)`

`$h323 -mode 1 (peer-to-peer mode)`

`$bureau -print` for Hotline/LineToLine table configuration.

LineToLine feature should be used together with:

`$sysconf -2nddial 1 (2nddial on)`

`$h323 -mode 1 (peer-to-peer mode)`

`$bureau -print` for Hotline/LineToLine table configuration.

Example:

`sysconf -service 0 -plan 4 -port 1 1 1 1 0 0`

`sysconf -callalive 0 -keypad 0`

`sysconf -2nddial 0 -drule out_filter 002 in_insert x in_drop 1`

`sysconf -askpin 1 -pincode set1 12345`

`sysconf -sendxcode 1 -access set1 12345#`

- service **0 (Dial In Service):** In Dial In Service, VoIP FXO gateway will pick up incoming calls from PSTN, play pre-recorded voice greeting or, and then have users to make a 2nd dial to destination.

1 (Direct In Line Service): This feature must be implemented in a pair of FXO products in Gatekeeper mode and set bureau –table command. In Direct In Line Service VoIP FXO gateway will connected via gatekeeper to pre-defined E.164 number. For example:

\$bureau –table 1 192.168.4.184 123

(please refer to 5.21 bureau command)

If L1 of VoIP FXO gateway is assigned to pre-defined E.164 number 123 in Direct in line mode. When users from PSTN make a call to L1 of VoIP FXO gateway, it will sent out the number 123 to GK, and GK will route this number to the endpoint which registered E.164 is 123 without 2nd dial.

Note: In Direct In Line service, must set VoIP FXO gateway sysconf –2nddial 0

2 (HotLine/ LineToLine Service): This feature must be implemented in a pair of FXO products in P2P mode and set bureau –table command

HotLine Service provides Hot Line function, which connects directly to pre-defined destination. For example, if L1 of VoIP FXO gateway is assigned to destination address 192.168.1.12 in Hot Line Mode. When users from PSTN make a call to L1 of VoIP FXO gateway, it will directly connect to 192.168.1.12 without a 2nd dial.

Note: In hotline service, must set VoIP FXO gateway sysconf –2nddial 0 .

LineToLine Service is like HotLine Service, but ask for a specific line number. For example, if L1 of VoIP FXO gateway is assigned to destination address 192.168.1.12 /Line4 in LineToLine Mode. When users from PSTN make a call to L1 of VoIP FXO gateway, it will directly connect to 192.168.1.12 and choose Line4 to call out to PSTN. This is mostly applied to ITSP, who provides international VoIP solution.

Note: In LineToLine service, must set VoIP FXO gateway sysconf –2nddial 1 .

- ringdet to define ring detection method. (0 is for old hardware version; 1 for new hardware version)
- plan It is for setting dial-numbering plan. While e164 number is three digits, the plan should be set as 3 or 0. The plan 0 is for any positive digits use.
- port This command can enable or disable individual port. The default

- idto value is set to enable all ports.
- eod: The duration of two pressed digits in dial mode
Digit type of end of dialing. (0:No end of dialing, 1:[*] button, 2:[#]button)
- seizure line seizure mode.
None (0): When calling from IP side, choose L1 every time if it is available.
UCD (1): When calls from IP side, choose L1 for the first time, and L2 for the 2nd time, (cyclic)

Note: Do not enable this function together with **group** (please refer to 5.18).

- 2nddial This command is necessary for setting one time dial method use. While user would like to skip 2nddial process, VoIP FXO gateway must close 2nddial and set as 0 (2nddial off). The default value is set as 1 (2nddial on).
- drule This command only works while 2nddial is off. When user would like to make an outgoing call or receive an incoming call shortly, it is necessary to set the following three commands belonged to drule.
 - drop: drop the dial digit.
 - insert: insert the dial digit
 - filter: filter the dial digit.

Note:

1. out: Through VoIP FXO gateway to dial out to another Gateway's e164 number. When making an outgoing call, it is necessary to set three commands in order, filter, insert then drop.
Example: sysconf -drule out_filter 002886 out_insert 0 out_drop 02
2. in: Through pass VoIP FXO gateway in order to connect with PSTN / PBX side. When making an incoming call from other Gateway, three commands is necessary to be set in order, drop, insert, then filter.
Example: sysconf -drule in_drop 002886 in_insert 0 in_filter 02
3. While the specified digit would like to be deleted, use the character x instead of any digits have configured.

- askpin 0:disables ASKPIN function
1: enables ASKPIN function, and apply to the whole unit. Every channel uses the same PINCODE.
2: enables ASKPIN function, and apply to each channel respectively. Every channel uses a different pincode.
- ring To set when dial in VoIP FXO gateway from PSTN side, VoIP FXO gateway will pick the call immediately or rings for specific times before picks up.
0: pick up immediately
1-5: times of ring before VoIP FXO gateway picks up.
- callalive Call Alive function (1 = ON; 0 = OFF). The function is used to check if the opposite party is alive when connection is established. When CallAlive is activated, VoIP FXO gateway will send H.245 RoundTripDelay message to other party, and wait

for response. If the other party cannot respond the message in 10 seconds, VoIP FXO gateway will regard the opposite party as IDLE state and disconnect the call. When CallAlive is deactivated, RoundTripDelay message will not be sent during connection.

- keypad keypad type when relay DTMF signal.
 - 0 : In-Band
 - 1 : h.245 alphanumeric
 - 2 : h.245 signal type
 - 3 : q.931 user info
- pincode To specify 2 sets of pincode.
- sendxcode send access code after connection (1 = ON; 0 = OFF)
- access specify access codes (per port basis).

Note:

1. This feature can only be implemented with LineToLine service. Please refer to –service above.
2. This function can help users to restrict callers to dial particular numbers from IP side to PSTN side. For example, if user set sysconf –access set1 1111, when callers call from IP side and enter VoIP FXO gateway port 1, if user dial 234 after hearing dial tone, VoIP will dial out 1111234.

```
usr/config$ sysconf –sendxcode 1 –access set1 1111
```

5.14 [h323] command

This command is to configure H.323 related parameters.

```
usr/config$ h323
```

H.323 stack information and configuration

Usage:

```
h323
```

```
h323 [-gk ipaddress] [-multicast used] [-e164 number] [-alias h323id]
```

```
[-rtp port] [-h245 port] [-ttl time] [-gkfind port] [-ras port]
```

```
[-range [start num1] [end num2]]
```

```
h323 -print
```

- print* Display H.323 stack information and configuration.
- mode* Configure as Gatekeeper mode or Peer-to-Peer mode.
- gk* Gatekeeper ip address. (0.0.0.0 ~ 255.255.255.255)
- gkname* Gatekeeper ID
- dfgw* Default Gateway ip address. (0.0.0.0 ~ 255.255.255.255)
- e164* IP side registered number (phone number).
- alias* IP side registered H.323 alias (account name).
- gkdis* Gatekeeper auto discovery (On=1, Off=0).
- rtp* RTP port number (1024~65532).
- h245* H.245 port number (N/A).
- ttl* RAS TTL time (0~3600 second).
- gkfind* Gatekeeper finding port (1024~65535).

-gwtype Register as Gateway (1) or Terminal (0) type
 -ras Gatekeeper RAS port (1024~65535).
 -range Dynamically allocated port range (1500~65535).
 -respto Max waiting time for 1st response to a new call (1~200).
 -connto Max waiting time for call establishment after receiving 1st
 response of a new call (1~20000).

Note:

H.245 port configuration is not available now.
 Options -gk -e164 -alias -multi -ttl -gkfind -ras are ignored when
 RAS mode is configured as Peer-to-Peer mode.

Example:

h323 -gk 210.59.163.171 -e164 0 -alias fxo
 h323 -mode 1

Parameters Usage:

- print print current h323 related settings
- mode alternatives for gatekeeper or peer-to-peer mode (0=gatekeeper mode; 1=peer-to-peer mode). If users select gatekeeper mode, an extra gatekeeper is needed when VoIP FXO gateway is in operation.
- gk to assign gatekeeper's IP address when VoIP FXO gateway is in gatekeeper mode.
- gkname to assign gatekeeper ID when VoIP FXO gateway is in gatekeeper mode.
- dfgw to set IP address of default gateway, this function is same as Microsoft NetMeeting. To implement this feature both endpoints must be under peer-to-peer mode.

If the other endpoint is FXO product, which has to be set as **sysconf -2nddial 0** to make one-stage dialing. Dial in VoIP FXO gateway from PSTN, when hearing greeting user can dial remote PSTN number, VoIP FXO gateway will automatically dial to default gateway, then default gateway will dial this number to PSTN side. For example, user wants to dial from VoIP FXO gateway A to ext.888 by VoIP FXO gateway B, user only has to dial 888 after hearing greeting of VoIP FXO gateway A.

If the other endpoint is FXS product, such as SP5002 or SP5004. Dial in VoIP FXO gateway from PSTN, when hearing greeting, user can dial line number of VoIP FXS gateway. For example, user wants to dial from VoIP FXO gateway to SP5004, the configuration of SP5004 is "h323 -line1 101 -line2 102". User can press 101 or 102 to line1 or line2 of SP5004 after hearing greeting of VoIP FXO gateway.

- e164 e164 number, which is registered as phone number in gatekeeper.
- alias h323 ID, a identification in h323 world for other parties' recognition. The field might be used as a key of authorization or accounting in some VoIP application. It is recommended to assign a special name, or it might conflict with other devices.
- gkdis Switch ON or OFF of gatekeeper discovery function (1 = ON; 0 = OFF). When it's ON, VoIP FXO gateway will send GRQ with GK ID to default gatekeeper. If the GK ID didn't matched, GW will send GRQ with GK ID in multicast.
- rtp to allocate RTP port range—NOT RECOMMENDED. This may be used when RTP port range conflicts with firewall policy.
- h245 to assign h.245 port number, NOT AVAILABLE for the moment.
- ttl to set timer for TTL(Time To Live). VoIP FXO gateway would send RRQ, with keepAlive, to gatekeeper periodically according to TTL timer.
- gkfind gatekeeper finding port. Port number, which VoIP FXO gateway uses it to discover a gatekeeper. Default value is 1718.
- gwtype to set VoIP FXO gateway register mode as terminal or gateway. 0 is for terminal and 1 is for gateway. If set VoIP FXO gateway as terminal mode, it must be set sysconf -2nddial 1(refer to 5.12).
- ras to set default gatekeeper RAS port number. Default value, 1719, is well-known port for RAS communication.
- range to allocate dynamic port range, which VoIP FXO gateway may use.
- respto response timeout. Max waiting time for 1st response to a new call (1~200).
- connto connection timeout. Max waiting time for call establishment after receiving 1st response of a new call (1~20000).

5.15 [gk] command

This command is to configure embedded simple gatekeeper parameters. If user doesn't have a gatekeeper or Micronet Call Manager, VoIP FXO gateway provides a simple embedded gatekeeper for up to 10 endpoints.

usr/config\$ gk

Gatekeeper information and configuration

Usage:

```
gk [-add type1 [[type2]...]] [-delete h323] [-ttl value]
    [-enable 0/1] [-security enable/disable]
```

```
-print          Display the enabled debug flags.
-enable        Enable simple gatekeeper
-ttl          Set TTL value
-add          Add dynamic endpoint
              (h323 ID, E164, IP, port, type)
-delete       Delete dynamic endpoint
-security enable Enable security check
-security disable Disable security check
-security add  Add security record
-security delete Delete security record
```

Example:

```
gk -add h323 256 192.168.1.1 1720 0
gk -delete h323
gk -security delete h323
gk -security add h323
```

Parameters Usage:

```
-print          print current embedded gatekeeper information and
                configurations.
-enable        to enable gatekeeper feature (0: disable, 1: enable).
-ttl          to set timer for TTL(Time To Live).In this period of time, if
                endpoint doesn't send RRQ to GK,GK will determine this
                endpoint as not exist anymore and delete it from registered list.
-add          To add an endpoint that doesn't send RRQ to GK. User can
                predefine an endpoint in GK, and GK will treat this endpoint has
                already registered to GK, though it doesn't send register request
                to GK. (gk -add "H.323 ID" "e164" "IP address" "signaling port"
                "gateway type,0=terminal,1=gateway", for example, gk -add test
                123 10.1.1.1 1720 0)
                Note: After you reboot the machine, the register information will
                disappear.
-delete       To delete dynamic endpoint which user added formerly.
                (gk -delete "H.323 ID")
-security enable To enable security check. If this function is enabled, GK
                will only accept registration request from endpoints, which
                are added with gk -security add command.
-security disable To disable security check.
-security add  To add endpoints to register to GK which enable security
                check.(gk -security add "H.323 ID")
-security delete To delete endpoints that added formerly in security check
                list.(gk -security delete "H.323 ID")
```

5.16 [voice] command

The voice command is associated with the audio setting information. There are four voice codecs (g.729a optional) supported by VoIP FXO gateway.

usr/config\$ voice

Voice codec setting information and configuration

Usage:

voice [-send [G723 ms] [G711A ms] [G711U ms] [G729A ms]]
[-volume [voice level] [input level] [dtmf level]] [-nscng G723 used]
[-echo used] [-mindelay t1] [-maxdelay t2] [-optfactor f]

voice -print

voice -priority [G723] [G711A] [G711U] [G729A]

-print Display voice codec information and configuration.

-send Specify sending packet size.

G.723 (30/60 ms)

G.711A (20/40/60 ms)

G.711U (20/40/60 ms)

G.729A (20/40/60 ms)

-priority Priority preference of installed codecs.

G.723

G.711A

G.711U

G.729A

-volume Specify the following levels:

voice volume (0~63, default: 28),

input gain (0~63, default: 28),

dtmf volume (0~31, default: 23),

-nscng No sound compression and CNG. (G.723.1 only, On=1, Off=0).

-echo Setting of echo canceller. (On=1, Off=0, per port basis).

-mindelay Setting of jitter buffer min delay. (0~150, default: 100).

-maxdelay Setting of jitter buffer max delay. (0~150, default: 150).

Example:

voice -send g723 60 g711a 60 g711u 60 g729a 60

voice -volume voice 20 input 32 dtmf 27

voice -echo 1 1

Parameters Usage:

-print print current voice information and configurations.

-send to define packet size for each codec. 20/40/60ms means to send a voice packet per 20/40/60 milliseconds. The smaller the packet size, the shorter the delay time. If network is in good condition, smaller packet size is recommended. In this parameter, 20/40/60ms is applicable to G.711u/a law, and G.729a codec, while 30/60ms is applicable to G.723.1 codec.

-priority codec priority while negotiating with other h323 device. This parameter determines the listed sequence in h.245 TCS message. The codec listed in left side has the highest priority when both parties determining final codec.

-volume There are three adjustable value. **Voice volume** stands for volume which can be heard from VoIP FXO gateway side. **Input gain** stands for volume which the opposite party hears. **Dtmf volume** stands for DTMF volume/level which sends to its own Line1 or Line2.

-nscng silence suppression and comfort noise generation setting (1 = ON; 0 = OFF). It is applicable to G.723 codec only. An example is demonstrated below:

```
usr/config$ voice -nscng g723 1
```

-mindelay the minimum jitter buffer size. (Default value= 90 ms)
-maxdelay the minimum jitter buffer size. (Default value= 150 ms)

```
usr/config$ voice -mindelay 90 -maxdelay 150 -optfactor 7
```

-echo activate each canceller (1 = ON; 0 = OFF).

Note:

Be sure to know well the application before you change **voice** parameters because this might cause incompatibility.

5.17 [tos] command

TOS service allows users to achieve QoS on IP network.

```
usr/config$ tos
```

IP Packet ToS(type of Service)information and configuration

Usage:

```
tos [-rtptype precedence]
```

```
    [-rtpdelay mode]
```

```
    [-rtpthruput mode]
```

```
    [-rtpreliab mode]
```

```
tos -print
```

```
    [-sigtype][[-rtptype]][[-rtcptype]]            0 routine.
```

 1 priority.

 2 immediate.

 3 flash.

 4 flash override.

 5 critic.

 6 internet control.

 7 network control.

```
    [-sigdelay][[-rtpdelay]][[-rtcpcdelay]]        0 normal delay.
```

 1 low delay.

```
    [-sigthruput][[-rtpthruput]][[-rtcpcthruput]]    0 normal throughput.
```

 1 high throughput.

```
    [-sigreliab][[-rtpreliab]][[-rtcpreliab]]        0 normal reliability.
```

 1 high reliability.

Example:

```
tos -rtptype 7 -rtpdelay 0 -rtpthruput 0 -rtpreliab 0
```

Parameter Usages:

-print display current TOS values configurations.

-sigtype configure TOS type of signaling packets from 0 to 7

-rtptype	configure TOS type of RTP packets from 0 to 7
-rtcptype	configure TOS type of RTCP packets from 0 to 7
-sigdelay	configure signaling packets as normal delay or low delay
-rtpdelay	configure RTP packets as normal delay or low delay
-rtcpdelay	configure RTCP packets as normal delay or low delay
-sigthruput	configure signaling packets as normal throughput or high throughput
-rtpthruput	configure RTP packets as normal throughput or high throughput
-rtcpthruput	configure RTCP packets as normal throughput or high throughput
-sigreliab	configure signaling packets as normal reliability or high reliability
-rtpreliab	configure RTP packets as normal reliability or high reliability
-rtcpreliab	configure RTCP packets as normal reliability or high reliability

Note:

Users should be aware that TOS is effective only when network devices (for ex: router, switch.. etc.) support TOS.

5.18 [tone] command

Tone of VoIP FXO gateway is configurable if the bureau line is connected to PABX or PSTN. Users can refer to “**greetr**” command for tone recording and analysis. Sometimes the frequencies might shift from standard level. In such a situation, users have to adjust the tone value manually using this command.

usr/config\$ tone

Setup of call progress tones

Usage:

tone -toneX LowFreq HighFreq LowFreqLevel HighFreqLevel TOn1 TOff1 TOn2 TOff2

tone -print

Note:

toneX has the following possibility:

busy1 busy2 reorder1 reorder2 ringtone1 ringtone2 dialtone

Example:

tone -busy1 400 0 8 0 50 50 0 0

tone -dialtone 400 0 19 0 25 25 0 0

5.19 [support] command

This command provides some extra functions that might be needed by users.

usr/config\$ support

Special Voice function support manipulation

Usage:

support[-tunnel enable]

support -print

-t38 T.38(FAX) enabled/disabled.
-fstart Fast start enabled/disabled.
-tunnel H245 Tunneling enabled/disabled.
-h245fs H245 separate channel after faststart.

Example:

support -fstart 1
support -tunnel 0
support -h245fs 1

Parameter Usages:

-print print current setting in **support** command.
-t38 to switch ON/OFF (1 = ON; 0 = OFF) T.38 function. T.38 function is for FAX. If user will use FAX machines, please switch on T.38 function.
-fstart to switch ON/OFF (1 = ON; 0 = OFF) FastStart function. Fast Start function can shorten the connection time if the opposite party also support FastStart.
-tunnel to switch ON/OFF (1 = ON; 0 = OFF) H.245 tunneling function. If the function is ON, VoIP FXO gateway will send H.245 (Call Control messages) via H.225's (Call Signal messages) link. The function is effective only when both side support h245 tunnel.
-h245fs to set if open H.245 separate channel after fast start or not. (1 = ON; 0 = OFF)

Note:

1. it is not recommended to change the value in this command, only if users do know well the application. This might cause incompatibility with other devices.
2. If user wants to use T.38 fax under fast start mode, please make sure "h245fs" function is enabled, or fax can't work normally.

5.20 [group] command

This command is for grouping ports of VoIP FXO gateway. If users need to register at least 2 numbers separately to gatekeeper, then this command is needed for such an application.

usr/config\$ group

PSTN side grouping information and configuration

Usage:

group -print | -enable | -disable |
-number group_number -pattern pattern_numbers -e164
e164_numbers |
-pattern pattern_numbers -e164 e164_numbers |
-e164 e164_numbers

Comment:

-print *Print current group configuration*

-enable *Enable PSTN Grouping*
-disable *Disable PSTN Grouping*
-number *Set number of divided groups*
-pattern *Set number of members in each group*
-e164 *Set E.164 number for each group*

Example:

group -print
group -enable
group -disable
group -number 2 -pattern 3 3 -e164 01 02
group -pattern 3 1 -e164 100 200
group -e164 11 22

Parameter Usages:

- print display current grouping information
- enable enable grouping function
- disable disable grouping function
- number set how many groups will be divided
- pattern set how many members in each group
- e164 set e164 of each group

For example, if users need to divide VoIP FXO gateway into L1 in the 1st group, and L2 in the 2nd group, and have them register to gatekeeper separately (e164=100 for 1st group; e164=200 for 2nd group), they have to use the following command:

usr/config\$ group -pattern 1 3 -e164 100 200

Note: GROUP function is effective only in gatekeeper mode.

5.21 [bureau] command

Type **bureau** to display the command usage.

usr/config\$ bureau

Bureau line setting information and configuration

Usage:

bureau [-pstn number] [-hold used] [-table [Port DestIP TELnum]]
bureau -print

-print *Display Bureau line information and configuration.*
-pstn *PSTN number (per port basis). This number is used to*
display *as a caller ID when the caller ID is not available.*
 The maximum digit length is 32.
-hold *Specify the hold tone generation (using PCM file). (On/Off)*
 Setting value (On=1, Off=0).

`-table` Set Hot line/Line To Line information. (Port range: 1~2)

Note:

Hotline feature should be used together with:

`$sysconf -service 2` (HotLine service)

`$sysconf -2nddial 0` (2nddial off)

`$h323 -mode 1` (peer-to-peer mode)

Line To Line feature should be used together with:

`$sysconf -service 2` (HotLine service/Line To Line)

`$sysconf -2nddial 1` (2nddial on)

`$h323 -mode 1` (peer-to-peer mode)

Example:

`bureau -pstn 2011 2012`

`bureau -table 1 192.168.4.69 628 2 192.168.4.200 9992`

Parameter Usages:

- print: display bureau line information and configuration.

`usr/config$ bureau -print`

Bureau line setting relate information

PSTN number : 2011 2012 2013 2014 2015 2016

Hold tone generation : On

Hot line / Line to Line table

```
=====
Port Destination Address Remote TEL/CHANNEL
-----
1          192.168.4.69      628
2          192.168.4.69      628
=====
```

- pstn PSTN number (per port basis). This number is used to display as a caller ID when the caller ID is not available. The maximum digit length is 32.
- hold while the terminals support H.450 hold function, the VoIP FXO gateway will play the hold tone to PSTN side.
- table Set Hot line/LineToLine destination IP and e164 numbers information.

Note:

1. HotLine and LineToLine functions are using the same table.
2. In HotLine service, user have to set line No. prepared to dial out; in LineToLine service ,user have to set port No. For example, if user set `bureau -table 1 192.168.4.69 628` in hotline service, after user dial in VoIP FXO gateway port 1, VoIP FXO gateway will direct dial to 192.168.4.69 and dial 628 to PSTN side, then Phone 628 will ring. User will hear ring back tone. If user set `bureau -table 1 192.168.4.69 1` in LineToLine service, after user dial in VoIP FXO gateway port 1 , VoIP FXO gateway will direct dial to 192.168.4.69 port 1,user will hear dial tone, then user can dial out No. to PSTN side.

5.22 [prefix] command

This function can do digits replacement of incoming call from IP side or PSTN side.

```
usr/config$ prefix
```

Prefix setting information and configuration

Usage:

```
prefix [-pstnrule index oldnumber newnumber (index = 1 ~ 6)]  
      [-iprule index oldnumber newnumber (index = 1 ~ 6)]  
prefix -print
```

-print *Display prefix information and configuration.*
-pstnrule *Set PSTN incoming prefix rule information.*
-iprule *Set IP incoming prefix rule information.*

Example:

```
prefix -pstnrule 1 2 8862 : prefix 2 will be replaced with 8862
```

Parameter Usages:

-print print current setting in **prefix** command.
-pstnrule to do digit replacement of incoming call from PSTN side. Ex, to set **prefix -pstnrule 1 123 456** , which means the first set of PSTN side rule is: IF user press 123888 after dialing in VoIP FXO gateway from PSTN side ,the real number dialed out will become 456888.
-iprule to do digit replacement of incoming call from IP side. Ex, to set **prefix -iprule 1 456 789** , which means the first set of IP side rule is: IF user press 456000 after dialing in VoIP FXO gateway from PSTN side ,the real number dialed out will become 789000.

5.23 [rom] command

ROM file information and firmware upgrade function.

```
usr/config$ rom
```

ROM files updating commands

Usage:

```
rom [-app] [-dsptest] [-dspcore] [-dspapp] [-rbpcm] [-htpcm]  
    [-greeting] -s TFTP/FTPserver ip -f filename  
rom [-method mode] [-ftp username password]  
rom -print
```

-print *show versions of rom files. (optional)*
-app *update main application code(optional)*
-boot *update main boot code(optional)*
-boot2m *update 2M code(optional)*
-dsptest *update DSP testing code(optional)*

-dspcore update DSP kernel code(optional)
 -dspapp update DSP application code(optional)
 -rbpcm update RingBack Tone PCM file(optional)
 -htpcm update Hold Tone PCM file(optional)
 -greeting update Greetings PCM file(optional)
 -askpin update AskPin file(optional)
 -s IP address of TFTP/FTP server (mandatory)
 -f file name(mandatory)
 -method download via TFTP/FTP (TFTP: mode=0, FTP: mode=1)
 -ftp specify username and password for FTP

Note:

This command can run select one option in 'app', 'dsptest', 'dspcore', 'dspapp', and 'rbpcm'.

Example:

```
rom -method 1
rom -ftp vwusr vwusr
rom -app -s 192.168.4.101 -f app.bin
```

Parameter Usages:

-print show versions of all rom files
 -app, boot, dsptest, dspcore, dspapp to update main Application program code, Boot code, DSP testing code, DSP kernel code, or DSP application code.
 -boot2m **boot2m** parameter let users to upgrade the whole system flash, including all the firmware that mentioned above. If 2M rom file update is executed, **users have to set again the MAC address of VoIP FXO gateway or it will cause conflict on Ethernet because the original MAC address is erased during 2M ROM file upgrading.**

Note:

To set MAC address please key in command setmac:(when key in MAC address ,press enter each time after key in two characters):

```
usr/config$ setmac
```

- enter mac address

00

01

a8

00

0x

xx

- the mac address is 00 01 a8 00 0x xx

- if mac address is correct, please press 'y' to setup configuration, else press 'n' to continue

-greeting The greeting file can be updated by users. The attributes of sound file should complied to: μ -law, 8000 Hz , 8 bit, Mono, 7 kb/s

-askpin update ASKPIN sound file. This is the greeting sound that when

- asking for pincode.
- s to specify TFTP server's IP address when upgrading ROM files.
- f to specify the target file name, which will replace the old one.
- method to decide using TFTP or FTP as file transfer server. "0" stands for TFTP, while "1" stands for FTP.
- ftp if users choose FTP in above item, it is necessary to specify pre-defined username and password when upgrading files.

5.24 [passwd] command

For security concern, users have to input the password before entering configuration mode.

usr/config\$ passwd

Password setting information and configuration

Usage:

passwd -set Loginname Password

Note:

Loginname can be only 'root' or 'administrator'

Example:

passwd -set root 2fxo

Parameter Usages:

-passwd <login name> <password>

Note:

<login name> can be "root" or "administrator" only. "root" and "administrator" have the same authorization, except 3 commands that can be executed by "root" only – "passwd –set root", "rom –boot", and "flash –clean"

6. Upgrade the VoIP FXO gateway

VoIP FXO gateway supports remote download via TFTP for updating the new ROM file. Regarding new version release, please contact local distributor for more information.

TFTP/FTP server

It is necessary to prepare the TFTP/FTP server program on the host PC as TFTP/FTP server. After TFTP/FTP program set up on one PC and connecting to network, VoIP FXO gateway is ready to be updated.

Download Procedure

Associated with Chapter 5.23 [rom] command:

- print show versions of all rom files
- app, boot, dsptest, dspcore, dspapp to update main Application program code, Boot code, DSP testing code, DSP kernel code, or DSP application code.
- boot2m **boot2m** parameter let users to upgrade the whole system flash, including all the firmware that mentioned above. If 2M rom file update is executed, **users have to set again the MAC address of VoIP FXO gateway or it will cause conflict on Ethernet because the original MAC address is erased during 2M ROM file upgrading.**

Note: To set mac address please key in command setmac:(when key in MAC address ,press enter each time after key in two characters):

```
usr/config$ setmac
```

```
- enter mac address
```

```
00
```

```
01
```

```
a8
```

```
00
```

```
0x
```

```
xx
```

```
- the mac address is 00 01 a8 00 0x xx
```

```
- if mac address is correct, please press 'y' to  
  setup configuration, else press 'n' to continue
```

- greeting The greeting file can be updated by users. The attributes of sound file should complied to: μ -law, 8000 Hz , 8 bit, Mono, 7 kb/s
- askpin update ASKPIN sound file. This is the greeting sound that when asking for pincode.
- s to specify TFTP server's IP address when upgrading ROM files.
- f to specify the target file name, which will replace the old one.

- method to decide using TFTP or FTP as file transfer server. "0" stands for TFTP, while "1" stands for FTP.
- ftp if users choose FTP in above item, it is necessary to specify pre-defined username and password when upgrading files.

Appendix: Web configuration

Web management simple user guide

The initial version for HTTPD web management interface provides user to configure easily rather than command operating method through RS-232 / TELNET.

The configuration function and step are similar with the way through command line. Please refer to the manual for more information. Below is simple user guide to configure via web interface.

Step 1. Browse the IP Address which has predefined via RS-232

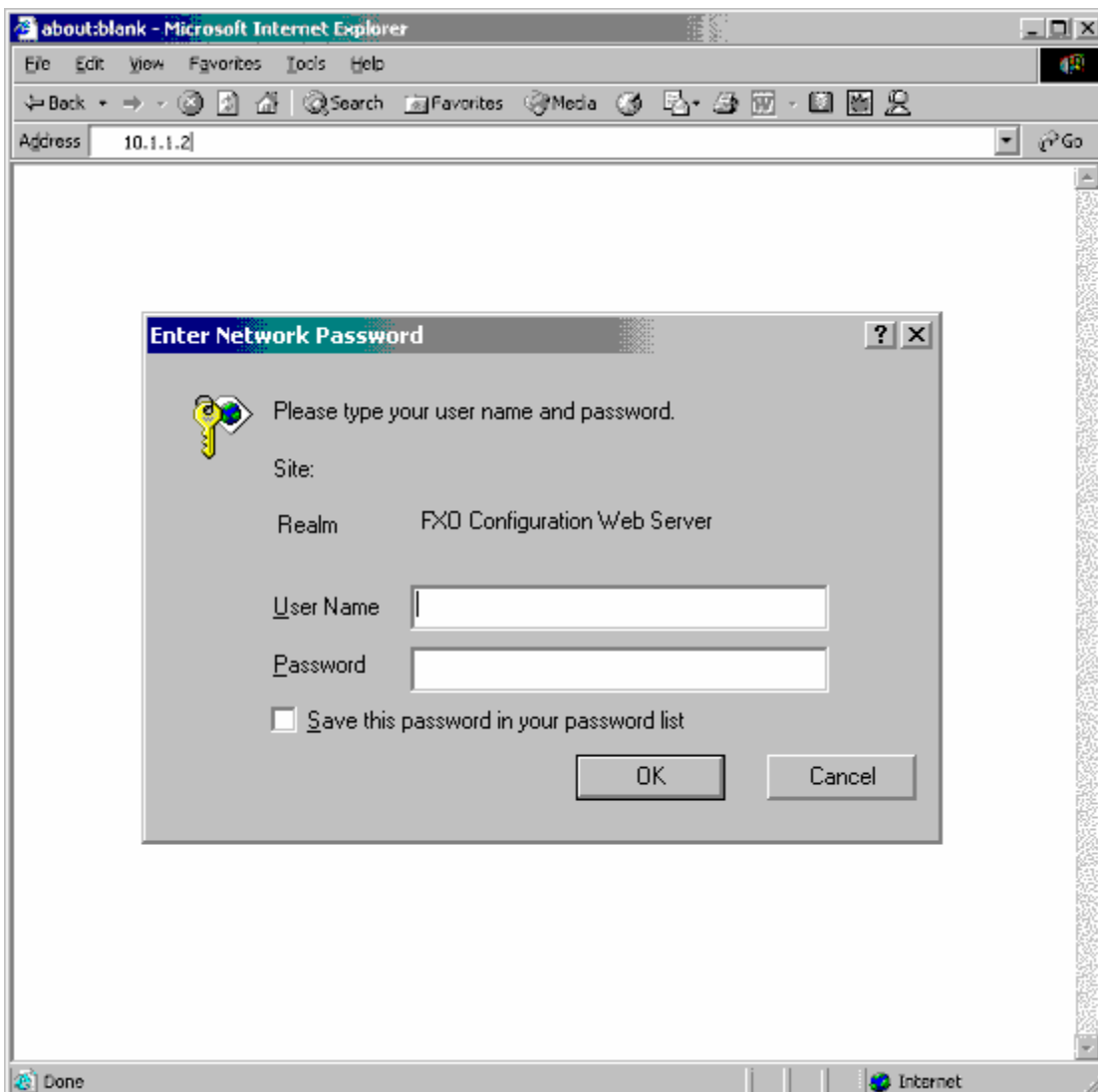

Step 2. Input the login name and password

- Login name: root / administrator
- Password: None (just press Enter in default value)

The web interface main screen

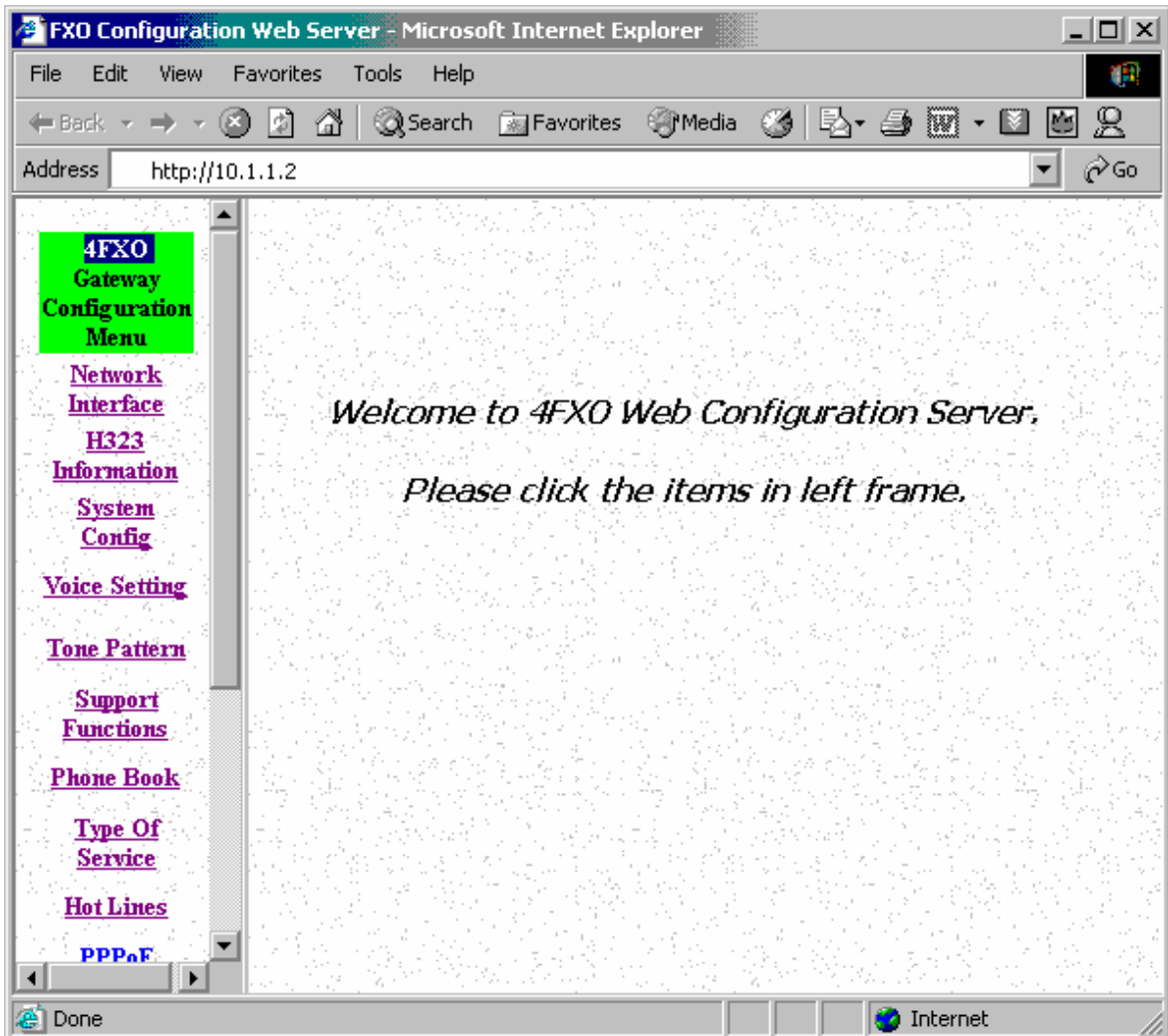

Step 3. Start configure

Most of all commands displayed in console / telnet are transfer to web interface. The most important commands are Network Interface, H323 Information, Commit Data and Reboot System. The method is as the same as command mode.

1.1 Network Interface

- IP Address: Set IP Address
- Subnet Mask: Set the Subnet Mask
- Default routing gateway: Set Default routing gateway
- DHCP: Enable / Disable to DHCP mode
- SNTP: Enable / Disable the Simple Network Time Protocol
- SNTP Server Address: Set SNTP Server Address
- GMT: Set time zone for SNTP Server time
- IP Sharing: Enable it if behind IP Sharing router
- IP Sharing Server Address: Set WAN IP Address of IP Sharing Server router if it is a fixed one.

Note:

If the WAN IP Address of IP Sharing Server router is not a fixed one, it is not necessary to input any values.

If it is behind the dynamic WAN IP Address situation please configure as GK mode and select Micronet Call Manager as proxy server.

The screenshot shows a web browser window titled "FXO Configuration Web Server - Microsoft Internet Explorer". The address bar shows "http://10.1.1.2". The main content area displays the "Network Interface" configuration page. On the left, there is a navigation menu with links: "4FXO Gateway Configuration Menu", "Network Interface", "H323 Information", "System Config", "Voice Setting", "Tone Pattern", "Support Functions", "Phone Book", "Type Of Service", "Hot Lines", "PPPoE Setting", and "Password". The "Network Interface" page has a blue header and contains the following configuration fields:

IP Address:	10 . 1 . 1 . 2
Subnet Mask:	255 . 255 . 255 . 0
Default routing gateway:	10 . 1 . 1 . 254
DHCP:	<input type="radio"/> enable <input checked="" type="radio"/> disable
SNTP:	<input type="radio"/> enable <input checked="" type="radio"/> disable
SNTP Server Address:	210 . 59 . 157 . 1
GMT:	8
IP Sharing:	<input type="radio"/> enable <input checked="" type="radio"/> disable
IP Sharing Server Address:	10 . 1 . 1 . 2

At the bottom of the configuration area, there is an "OK" button.

1.2 H323 Information

- Mode: Select GK mode or Peer-to-Peer mode
- Gatekeeper IP Address: Set Gatekeeper IP Address
- Gateway Type: Set Register Type to GK (Gateway / Terminal)
- Registered Prefix: Set Prefix Number as E.164 number
- Registered Alias: Set Registered Alias as H323 ID
- Gatekeeper Discovery, RTP Port, Time to Live (TTL), Gatekeeper finding port, RAS Port, Response Timeout, Connection Timeout: For Advanced User Only

H323 Configuration	
Mode:	<input type="radio"/> GK routed <input checked="" type="radio"/> Direct
Gatekeeper IP Address:	10 . 1 . 1 . 2
Gateway Type:	<input checked="" type="radio"/> Gateway <input type="radio"/> Terminal
Registered Prefix:	0
Registered Alias:	4FXO-001dc1
Gatekeeper Discovery:	<input type="radio"/> enable <input checked="" type="radio"/> disable
Gatekeeper ID:	GK
RTP Port:	16384
Time To Live (TTL):	60
Gatekeeper finding port:	1718

1.3 System Config

- Keypad Type: Select different DTMF Keypad Type (For Advanced User)
- Dial Plan: Set DTMF digit limitation (0 is for any digits)
- Inter Digit Time: Set the DTMF inter digit time (second)
- End of Dial: Digit type of end of dialing. (0:No end of dialing, 1:[*] button, 2:[#] button)
- 2nddial: This command is necessary for setting one time dial method use. While user would like to skip 2nddial process, VoIP SP5054 must close 2nddial and set as 0 (2nddial off). The default value is set as 1 (2nddial on).
- Call Alive: Enable the function to check connection (Both side must support)
- Line Seizure: Choose line seizure mode (None/UCD)
- Gateway Service: Specify gateway service type. (0: Dial in service,1: Direct in line service, 2: HotLine/LineToLine service.)

System Configuration

Keypad Type:	<input type="radio"/> In-Band <input type="radio"/> H.245(Alpha) <input checked="" type="radio"/> H.245(Sig) <input type="radio"/> Q.931 <input type="radio"/> RFC2833
Dial Plan:	<input type="text" value="0"/>
Inter Digit Time:	<input type="text" value="5"/>
End of Dial:	<input type="radio"/> No Eod <input type="radio"/> * <input checked="" type="radio"/> #
2nd Dial:	<input checked="" type="radio"/> ON <input type="radio"/> OFF
Call Alive:	<input type="radio"/> ON <input checked="" type="radio"/> OFF
Line Seizure:	<input type="radio"/> UCD <input checked="" type="radio"/> None
Gateway Service:	<input type="text" value="0"/>

OK

1.4 Voice Setting (For Advanced User)

- Frame Size: It got wrong order with “Codec Priority”. Select the Codec Priority. (For Advanced User)
- Codec Priority: It got wrong order with “Frame Size”. Select the packet size in sending process. (For Advanced User)
- G.723 Silence Suppression: Enable / Disable (For Advanced User)
- Volume: Adjust the volume in “Voice” (sending out); “Input” (receiving); “DTMF” (DTMF sending out) Please Noted the value is limited.
- Echo Cancel: Enable / Disable (suggested always Enable)
- Jitter Buffer: Min. Delay and Max. Delay (For Advanced User)
- Optimized Factor (Jitter): (For Advanced User)

The screenshot shows the 'Voice Configuration' page of the FXO Configuration Web Server. The browser window title is 'FXO Configuration Web Server - Microsoft Internet Explorer'. The address bar shows 'http://10.1.1.2'. The left navigation menu includes: 4FXO Gateway Configuration Menu, Network Interface, H323 Information, System Config, Voice Setting (highlighted), Tone Pattern, Support Functions, Phone Book, Type Of Service, Hot Lines, PPPoE Setting, Password, and ROM Upgrade. The main configuration area is titled 'Voice Configuration' and contains the following settings:

Frame Size	1st	2nd	3rd	4th
Codec Priority	G.723.1 30ms	G.729a 20ms	G.711mu 20ms	G.711A 20ms
G.723 Silence Suppression:	<input type="radio"/> enable <input checked="" type="radio"/> disable			
Volume:	voice 32	input 32	DTMF 23	
Echo Cancelor:	<input checked="" type="radio"/> enable <input type="radio"/> disable			
Jitter Buffer:	Min. Delay 90		Max. Delay 150	
Optimized Factor (Jitter):	9			

An 'OK' button is located at the bottom right of the configuration area.

1.5 Phone Pattern (For Advanced User)

The screenshot shows the 'Tone Configuration' page in a web browser. The browser title is 'FXO Configuration Web Server - Microsoft Internet Explorer' and the address bar shows 'http://10.1.1.2'. The page has a blue header with the title 'Tone Configuration'. On the left, there is a navigation menu with the following items: 4FXO Gateway Configuration Menu, Network Interface, H323 Information, System Config, Voice Setting, Tone Pattern, Support Functions, Phone Book, Type Of Service, Hot Lines, PPPoE Setting, Password, and ROM Upgrade. The main content area contains a table with 7 rows and 8 columns. The columns are labeled: High(freq), Low(freq), High(lev), Low(lev), On1, Off1, and On2. The rows are labeled: Busy Tone I, Busy Tone II, order: Tone I, order: Tone II, Ring Tone, and Dial Tone. Below the table is an 'OK' button.

	High(freq)	Low(freq)	High(lev)	Low(lev)	On1	Off1	On2
Busy Tone I:	620	400	8	8	50	50	50
Busy Tone II:	437	434	8	8	50	50	50
order: Tone I:	620	480	8	8	25	25	25
order: Tone II:	440	350	8	8	25	25	25
Ring Tone:	480	440	13	13	200	400	0
Dial Tone:	0	400	0	10	50	0	50

OK

1.6 Support Functions (Both side must support)

- T.38: Enable for T.38 FAX
- Fast Start: Enable to do Fast Start
- H.245 Tunneling: Enable to open H.245 Tunneling

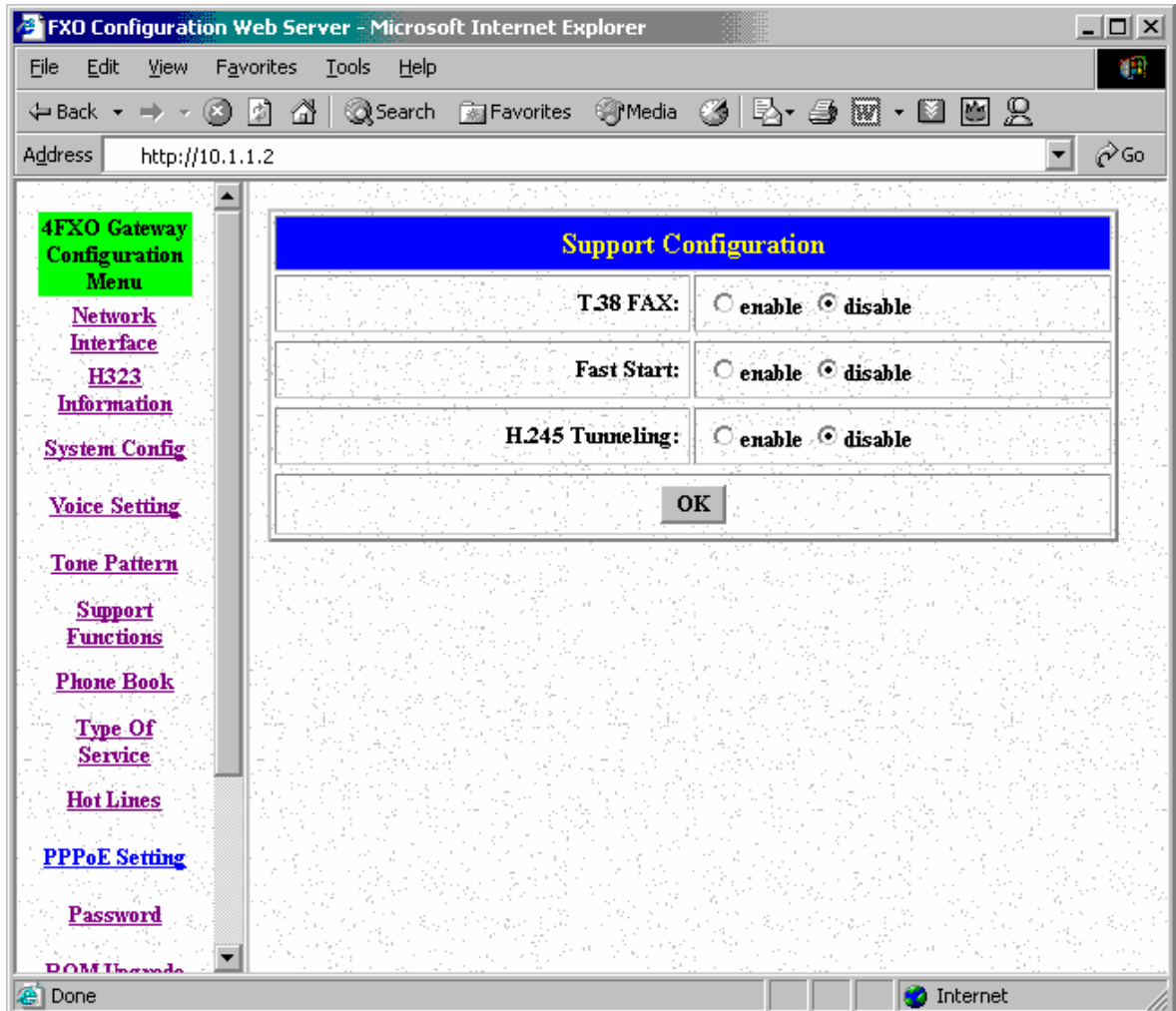

1.7 Phone Book (For Peer-to-Peer mode only)

Input the Name, IP Address and E.164 No. for the destination device.
Please Note: The E.164 No. will be carried together to the destination side.

4FXO Gateway Configuration Menu

- [Network Interface](#)
- [H323 Information](#)
- [System Config](#)
- [Voice Setting](#)
- [Tone Pattern](#)
- [Support Functions](#)
- [Phone Book](#)
- [Type Of Service](#)
- [Hot Lines](#)
- [PPPoE Setting](#)
- [Password](#)
- [ROM Upgrade](#)

Phone Book

Index	Name	IP_Address	e164

New Record

Index	Name	IP Address	E164 No.
<input type="text"/>	<input type="text"/>	<input type="text"/> . <input type="text"/> . <input type="text"/>	<input type="text"/>
		<input type="button" value="Add Data"/>	<input type="button" value="Delete Data"/>

1.8 Type Of Service

Adjust the parameter in IP Header for router identity purpose. If the version has PPPoE function, ToS is not available.

The screenshot shows a web browser window titled "4FXO Configuration Web Server - Microsoft Internet Explorer". The address bar shows "http://10.1.1.2". The main content area is titled "TOS Configuration" and contains a table with three rows of configuration options. Each row has three columns: "Precedence", "Delay", and "ThruPut". The first row is for "Sinaling TOS" with values "Flash Override(4)", "Normal(0)", and "Normal(0)". The second row is for "RTP TOS" with values "CRITIC/ECP(5)", "Normal(0)", and "Normal(0)". The third row is for "RTCP TOS" with values "Routine(0)", "Normal(0)", and "Normal(0)". An "OK" button is located below the table. On the left side, there is a navigation menu with links: "4FXO Gateway Configuration Menu", "Network Interface", "H323 Information", "System Config", "Voice Setting", "Tone Pattern", "Support Functions", "Phone Book", "Type Of Service", "Hot Lines", "PPPoE Setting", and "Password".

	Precedence	Delay	ThruPut
Sinaling TOS:	Flash Override(4)	Normal(0)	Normal(0)
RTP TOS:	CRITIC/ECP(5)	Normal(0)	Normal(0)
RTCP TOS:	Routine(0)	Normal(0)	Normal(0)

OK

1.9 Hot Lines

Select HOST Port and set Destination Address. The Remote Number is subject to the Destination's configuration.

4FXO Gateway Configuration Menu

- [Network Interface](#)
- [H323 Information](#)
- [System Config](#)
- [Voice Setting](#)
- [Tone Pattern](#)
- [Support Functions](#)
- [Phone Book](#)
- [Type Of Service](#)
- [Hot Lines](#)
- [PPPoE Setting](#)
- [Password](#)
- [POM Upgrade](#)

Bureau		
PORT	DESTINATION_ADDRESS	Remote_TEL(FXS)/Port_No(FXO)
1	192.168.4.69	628
2	192.168.4.69	628
3	192.168.4.69	628
4	192.168.4.69	628

New Record		
Port	Destination Address	Remote Number
<input type="text"/>	<input type="text"/> . <input type="text"/> . <input type="text"/>	<input type="text"/>
<input type="button" value="SET"/>		

1.10 PPPoE

FXO Configuration Web Server - Microsoft Internet Explorer

File Edit View Favorites Tools Help

Back Forward Stop Home Search Favorites Media Print Copy Paste

Address http://10.1.1.2 Go

4FXO Gateway Configuration Menu

- [Network Interface](#)
- [H323 Information](#)
- [System Config](#)
- [Voice Setting](#)
- [Tone Pattern](#)
- [Support Functions](#)
- [Phone Book](#)
- [Type Of Service](#)
- [Hot Lines](#)
- [PPPoE Setting](#)
- [Password](#)
- [ROM Upgrade](#)
- [Flash Clean](#)
- [Commit Data](#)

PPPoE Device Information and Configuration

Device:	<input type="radio"/> On <input checked="" type="radio"/> Off
User Name:	<input type="text" value="pppoe"/>
Password:	<input type="text" value="*****"/>
Reboot After Remote Host Disconnection:	<input type="radio"/> On <input checked="" type="radio"/> Off
IP:	<input type="text"/>
Destination Host:	<input type="text"/>
Domain Name Server:	<input type="text"/>
Subnet Mask:	<input type="text"/>
Authenticate:	<input type="text"/>
Protocol:	<input type="text"/>
Device:	<input type="text"/>

OK

Done Internet

1.11 Password

First select login name as root or administrator, then enter current password , new password and confirm new password again.

The screenshot shows a web browser window titled "4FXO Configuration Web Server - Microsoft Internet Explorer" with the address bar set to "http://10.1.1.2". The main content area is titled "Password Configuration" and contains a form with the following elements:

- A dropdown menu for user selection, currently showing "root".
- Three password input fields labeled "Current Password:", "New Password:", and "Confirm New Password:".
- Two buttons labeled "CHANGE" and "ABORT".

A left sidebar menu lists various configuration options:

- 4FXO Gateway Configuration Menu
- Network Interface
- H323 Information
- System Config
- Voice Setting
- Tone Pattern
- Support Functions
- Phone Book
- Type Of Service
- Hot Lines
- PPPoE Setting
- Password
- ROM Upgrade

1.12 ROM Upgrade

- TFTP Server IP Address: Set TFTP server IP address
- Target File name: Set file name prepared to upgrade
- Method: Select download method as TFTP or FTP
- FTP Server IP Address: Set FTP server IP address
- FTP Login: Set FTP login name and password
- Target File Type: Select which sector of Gateways to upgrade

FXO Configuration Web Server - Microsoft Internet Explorer

File Edit View Favorites Tools Help

Address Go

ROM Configuration

TFTP server IP Address: . . .

Target File name:

Method: TFTP

FTP server IP Address: . . .

FTP Login: name passwd

Target File Type: Application Image

OK

Done Internet

1.13 flash Clean

Press CLEAN will clean all configurations of Gateways and reset to factory default value. Once execute this function, user must re-configure all other commands except IP Address.

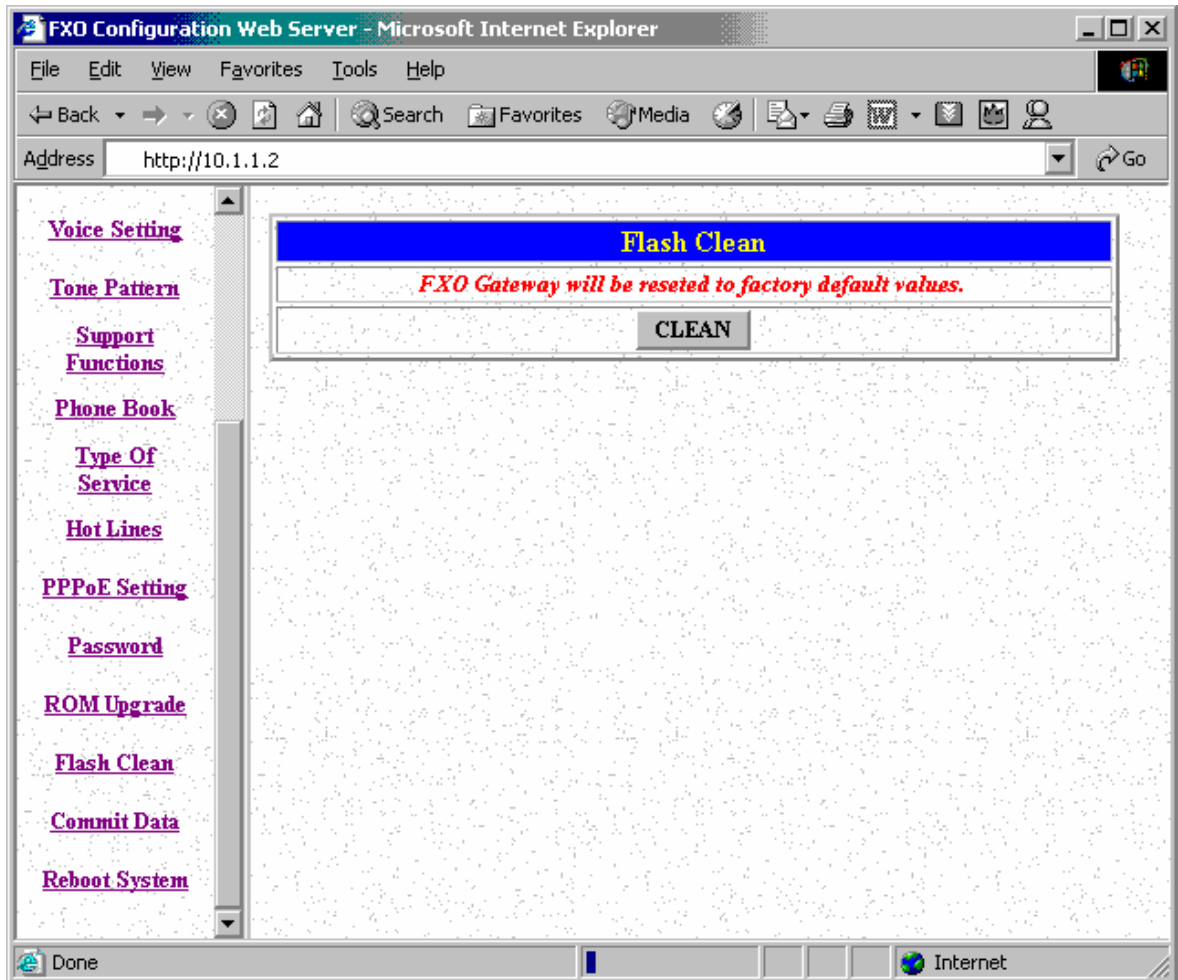

1.14 Commit Data

After configuration, user has to commit data then reboot machine. It is an important step after every configuration.

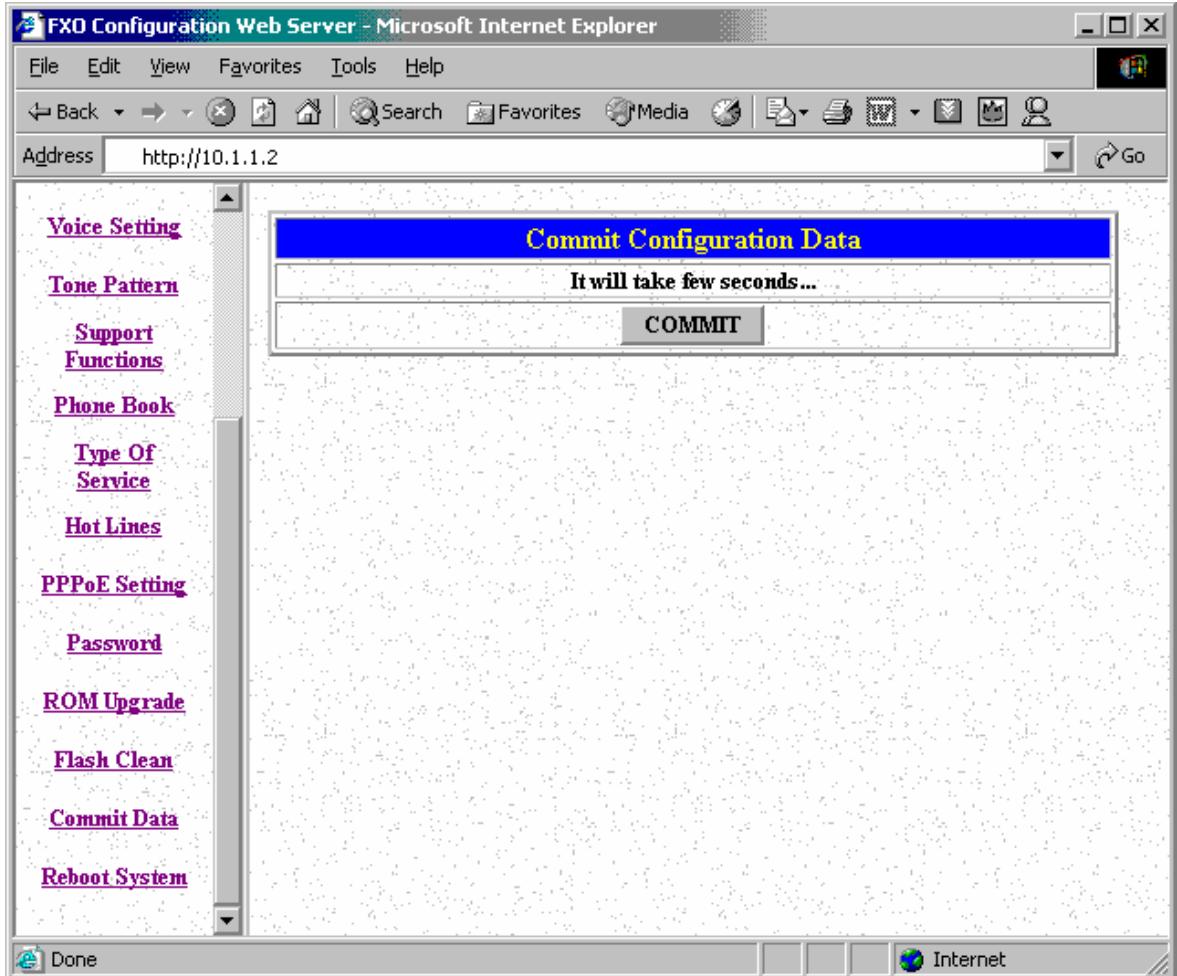

1.15 Reboot System

After commit configuration, user has to REBOOT device. It is an important step after every configuration.

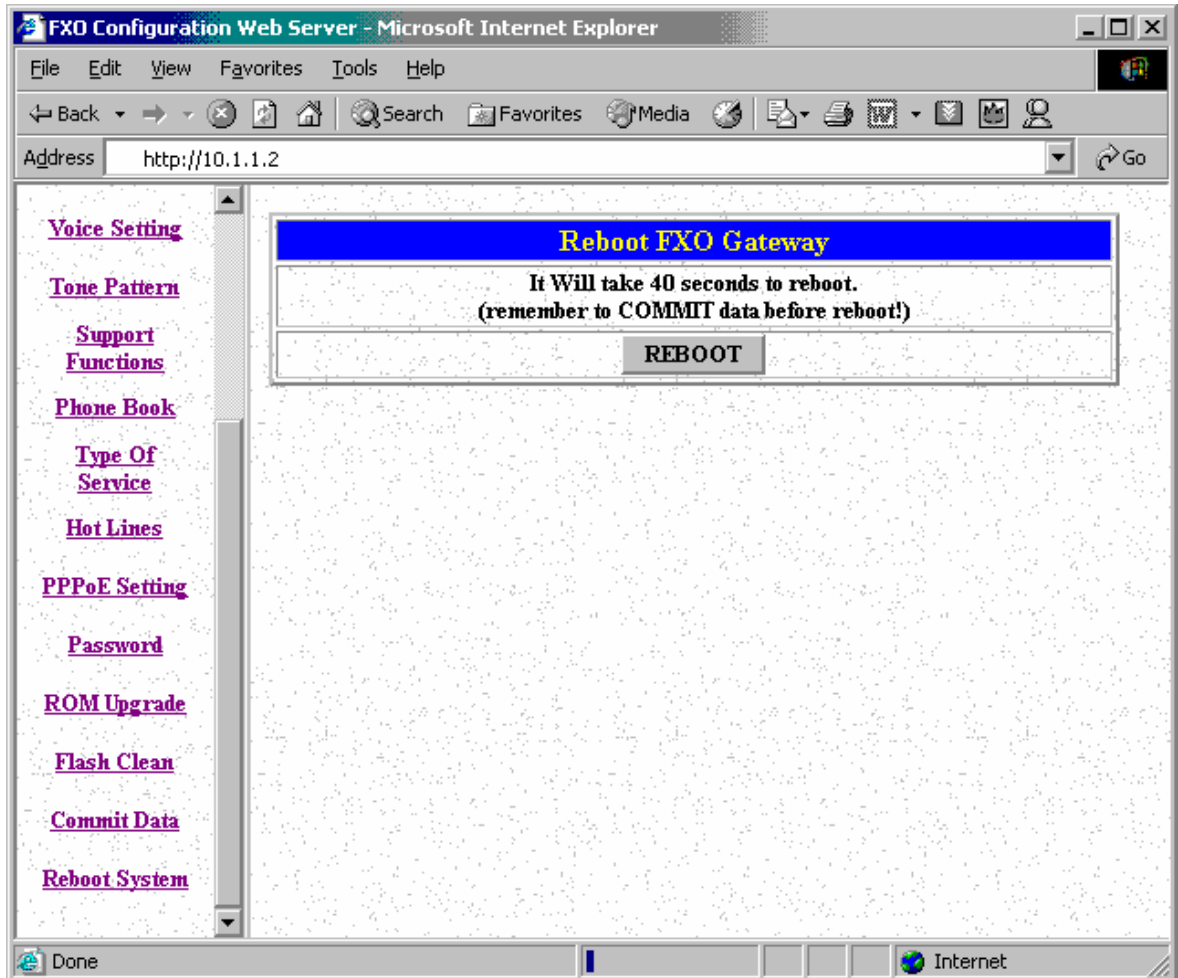

Free Manuals Download Website

<http://myh66.com>

<http://usermanuals.us>

<http://www.somanuals.com>

<http://www.4manuals.cc>

<http://www.manual-lib.com>

<http://www.404manual.com>

<http://www.luxmanual.com>

<http://aubethermostatmanual.com>

Golf course search by state

<http://golfingnear.com>

Email search by domain

<http://emailbydomain.com>

Auto manuals search

<http://auto.somanuals.com>

TV manuals search

<http://tv.somanuals.com>