

TransPort[®] LT User's Guide

Copyright Notice

The information in this document is subject to change without prior notice in order to improve reliability, design, and function and does not represent a commitment on the part of the manufacturer. In no event will the manufacturer be liable for direct, indirect, special, incidental, or consequential damages arising out of the use or inability to use the product or documentation, even if advised of the possibility of such damages. Except as stated in the applicable Micron Electronics limited warranty, Micron, by this manual, makes no other express warranties and all other warranties, including, without limitation, **THE IMPLIED WARRANTY OF MERCHANTABILITY AND THE IMPLIED WARRANTY OF FITNESS FOR A PARTICULAR PURPOSE ARE HEREBY DISCLAIMED.**

This document contains proprietary information that is protected by copyright. All rights are reserved. No part of this document may be photocopied, reproduced, or translated to another language without the prior written consent of:

Micron Electronics, Inc.
900 E. Karcher Road
Nampa, Idaho 83687

Phoenix is a trademark of Phoenix Technologies Ltd. CardSoft is a trademark of SystemSoft Corporation. AutoCAD and Autoshade are trademarks of Autodesk, Inc. IBM, OS/2, and VGA are trademarks of International Business Machines Corp. Lotus, 1-2-3, and Symphony are trademarks of Lotus Development Corp. Windows, Word, MS-DOS, and Microsoft are trademarks of Microsoft Corp. VESA is a trademark of Video Electronics Standards Association.

MS-DOS, Windows 3.1, 95/98/2000 and Windows NT are trademarks of Microsoft Corp. Pentium II and MMX are trademarks of Intel Corporation. Other product names mentioned herein are used for identification purposes only and may be trademarks and/or registered trademarks of their respective companies. While reasonable efforts have been made to ensure the accuracy of this manual, the manufacturer and distributor assume no liability resulting from errors or omissions in this manual, or from the use of the information contained herein.

**P/N MAS001602-00, TransPort LT,
BGJ, 01-20-2000**

Copyright 2000 Micron Electronics Inc. All Rights Reserved.

This page intentionally left blank.

Table of Contents

User's Guide	1	Using Special Function Keys	27
Copyright Notice.....	1	Using the Touchpad	28
Welcome	7	Reading the System Status Lights	29
Purpose	7	Connecting Peripheral Devices	31
Reader.....	7	Using the Flex-Bay	33
Further Reading	7	To Remove a Device from the Flex-Bay	34
Areas Covered	7	To Install a Device in the Flex-Bay.....	34
Manual Conventions	9	Using the SmartBay Utility	34
Manual Comments	9	Using the Floppy Drive	35
Getting Started	11	Using the CD-ROM Drive	37
Unpacking the TransPort LT	11	Using the Hard Drive	39
Personal Inventory	12	Removing the Hard Drive.....	40
System Information	12	Installing a Hard Drive.....	41
Heat, Cold, Humidity, and Glare	13	Using the Battery	41
Surge Suppressors	13	Charging the Battery	41
Work Location	13	Safely Using the Battery.....	42
Operating Environment	15	Removing the Battery.....	42
Introducing Your TransPort LT	17	Installing the Battery.....	43
TransPort LT Features	17	Monitoring the Battery Charge	43
Using Your Computer for the First Time	19	Using the Battery Gauge.....	44
Connecting the AC Adapter.....	19	Using PowerProfiler to Monitor the Battery	44
Turning on the TransPort LT	20	Battery Warnings.....	45
Understanding POST	21	Using the Modem	46
Adjusting the LCD Display	22	Precautions Before Use	46
Turning Off Your Computer	22	Description of 56K.....	47
APM Mode.....	22	Modem Specifications	48
Restarting Your Computer	22	Installing the Modem Driver in Windows 95/98	49
Tips for Using Your Computer	23	Modem Commands.....	49
Traveling with Your Computer	24	Using AT commands.....	50
Handling Spills	25	Basic AT Commands	51
Storing the Computer for Long Periods	25	Video Features and Configuration	53
Using the Keyboard	25	Resolution and Color Depth	53
Using the Embedded Numeric Keypad	27	Configuring Display Features.....	54
		Selecting a Monitor Type	54
		Changing Color Depth and Resolution.....	55
		Changing the Video Driver	56
		Working with PC Cards	58
		Maintaining PC Cards	59
		Using PC Cards	59

Table of Contents

Using Options	63	Maximum Power Saving Mode	93
AC Adapter	63	Standby Mode	93
Auto Adapter	63	Suspend Mode	94
Battery Pack	64	Suspend Mode Precautions	94
Memory Modules	64	Using PowerProfiler	95
Before You Install Memory	64	Creating a Save-To-Disk Partition	97
Installing a Memory Module.....	65	Software Utilities	99
CD-ROM Drive	67	MRestore CD-ROM	99
DVD-ROM Drive Module	67	MCRC (Micron Customer Resource Center)	99
Secondary Battery	67	PartitionMagic	99
Port Replicator	68	Drive Image 3.0	99
Features of the Port Replicator.....	68	Drive Image Professional	101
Installing a Port Replicator.....	69	Drive Image System Requirements.....	101
Removing a Port Replicator.....	70	Creating Image Files	101
Drivers and System Resources	71	Advanced Options	107
Drivers	71	Disable SmartSector Copying	107
IRQs	71	Verify Disk Writes	107
Service Pack 6A for Windows NT 4.0	72	ImageShield	108
Installing the LAN Driver in Windows 98	73	Split Image File Into Multiple Files.....	108
Using System Setup	75	Restoring Image Files	108
Starting System Setup	75	Resize Options	114
Main Menu	77	Advanced Options	114
Advanced Menu	81	Check for File System Errors	115
Security Menu	83	Skip Bad Sector Check	115
Power Menu	84	Verify Check Writes	115
Boot Menu	87	PartitionMagic	115
Exit Menu	88	Partition Information	116
Using System Security	89	Partition Map	116
System Passwords	89	Partition List.....	116
Creating a Password	89	PartitionMagic Help	117
Deleting a Password.....	90	ReadMe File	117
Requiring a Boot Password	90	Completing Tasks Manually	117
Locking the Hard Drive Boot Sector	90	Selecting a Hard Disk.....	117
Locking the Floppy Drive	90	Selecting a Partition	118
Locking the Keyboard.....	91	Applying Changes to Your System.....	118
Using Power Management Options	93	Changing PartitionMagic Preferences.....	119
		Ignore OS/2 EA Errors on FAT.....	119
		Skip Bad Sector Checks.....	120
		Set as Read-Only for PartitionMagic	120
		Creating Partitions.....	121

Table of Contents

Creating Bootable Partitions.....	121	Appendix A - Regulatory	149
To Create a Partition	122	FCC Notice	149
Scenarios	125	Federal Communications Commission (FCC) Part 68	
Deleting Partitions	125	Statement 149	
Changing Partition Labels	126	CTR21 Statement.....	151
Formatting Partitions	127	Canadian Radio Interference Regulations	151
Converting FAT to FAT32	128	CLASS 1 LASER PRODUCT	151
Converting FAT to NTFS.....	128	Power Cord Requirement	152
Drive Copy.....	130	Appendix B - Important Safety Instruction	155
Copying Entire Drives.....	130	Battery Disposal	157
PHDISK Utility	132	Appendix C - Abbreviations	159
Help Screen.....	132	Appendix D - Glossary	161
CREATE Option	132		
Automatic Memory Size Calculation.....	133		
User-specified Memory Size.....	133		
/Partition or /P.....	133		
/CREATE Option Syntax	133		
REFORMAT Option.....	133		
INFO Option	133		
PHDISK Sign-on Message	134		
Unrecognized Option.....	134		
PHDISK/CREATE Failed to Execute.....	134		
Fatal Error	134		
Save-To-Disk Partition Exits.....	134		
First Two Sectors Bad	134		
Restoring your Computer	137		
To (re)install your Operating System:.....	137		
Windows 98:.....	137		
Windows NT 4.0 Workstation:	138		
To (re)install your original applications and drivers:	138		
Troubleshooting.....	139		
Operating Problems	139		
Infrared Problems	140		
Modem Problems.....	141		
Specifications.....	143		
System Specifications	143		
Recording the Computer Hardware Configuration.....	145		

This page intentionally left blank.

Chapter 1 - Welcome

Thank you for buying a micronpc.com computer. This User's Guide is intended for both first-time and experienced computer users. Please review the following information to get the most out of this manual.

Purpose

This manual contains information to instruct and guide you on everything from setup and maintenance to configuring the system and creating disk partitions. The purpose of this manual is to help you enjoy all the features the TransPort LT offers and information to help you operate and setup the computer for optimal performance.

Reader

This manual is designed to assist all users—from beginner to advanced.

The first two chapters are intended for all users. The rest of the manual is targeted toward the reader who has a basic understanding of how computers work and how to use them.

If you are new to using computers, see the Glossary for explanations of general computing terms that are used in this manual. The Glossary also provides information about some of the differences between notebook computers and desktop computers.

Further Reading

Along with this manual you should consult and read all the manuals and documentation included with all software and hardware applications used with this computer.

Your computer shipped from the factory with several software programs installed. The software may include its own online or printed documentation. Refer to the documentation or the Help options in the software for more information.

Areas Covered

Getting Started: This section includes a description of the parts you received and general operating guidelines. This chapter contains important computer use and computer care considerations to help you get started.

Introducing Your TransPort LT: This section provides a description of the features of the TransPort LT along with basic operation.

Video Features and Configuration: This section describes the display capabilities of your computer and information on working with PC cards.

Using Options: This section provides an overview to numerous options with which you can increase the uses for your TransPort LT. If you have purchased accessories, refer to this chapter for instruction, if not, you may want to find out what kinds of options you have with your TransPort LT.

Drivers and System Resources: This section gives you basic information about drivers and system IRQs.

Using System Setup: This section describes how to operate the System Setup Utility that is provided in the computer's ROM BIOS. No changes should be made in Setup unless the result of the change is known and understood.

Using System Security: This section describes the security options provided with your computer.

Using Power Management Options: This section provides information on how to keep your TransPort LT supplied with power.

Creating a Save-To-Disk Partition: This section describes your computer's save-to-disk partition and provides instructions for adding memory modules to your computer.

Software Utilities: This section explains the MRestore CD, which includes Drive Image, Partition Magic and Drive Copy--three very powerful software tools--and the PHDISK (save-to-disk) utility.

Restoring your Computer: This section explains how to restore the Operating System or drivers.

Troubleshooting: This section provides a simple guide to common troubleshooting techniques.

Specifications: This section lists the specifications of your TransPort LT.

Recording the Computer Hardware Configuration: Use this section to record the System Setup program settings.

Manual Conventions

The following conventions are used throughout this manual:

**NOTE:**

Notes: Important information and useful tips concerning the operation of your computer.

**CAUTION:**

Caution: Failure to follow directions could result in loss of data or damage to equipment. Failure to heed these warnings could negate the user warranty.

**WARNING:**

Warning: Failure to follow directions will result in loss of data or damage to equipment, and/or could result in physical harm. Failure to heed these warnings could negate the user warranty.

Special Text

The text is formatted to set off unique information or instructions. Review the following examples of special text used throughout this manual:

- Screen (window) names, functions, or anything that appears on the screen is formatted in bold: Click **OK**, the **Standards** screen, the **Edit** menu.
- Keyboard functions are indicated by brackets: Press [Enter], use the [Alt] key. When keys should be held down simultaneously they are separated by the + sign: Press [Ctrl+Alt+Delete].
- Screen messages are indicated by quotes: the message "Enter your username and password" will appear.
- Anything that you need to type in should appear in italics: Enter the word *password*.

Manual Comments

We want to make this guide as useful as possible and welcome your comments. Please provide the page and the manual part number (MAS001602-00) when you send comments to: manuals@micronpc.com.

This page intentionally left blank.

Chapter 2 - Getting Started

Congratulations on the purchase of your Micron TransPort LT notebook computer. Whether you are new to using a notebook computer or are an experienced user, this user manual can help you get the most from your computer.

Unpacking the TransPort LT

The TransPort LT comes securely packaged in a sturdy shipping carton. Open the box and carefully remove the contents. If anything is missing or damaged, please contact Micron Electronics immediately. All systems should include the following items:

- The TransPort LT computer
- An AC adapter
- An AC power cord
- User's manual
- A CD or DVD-ROM Drive
- A 3.5-inch Floppy Drive



NOTE:

Items included may vary. Please check the packing slip included with your TransPort LT for the exact items you should have received.

Personal Inventory

This TransPort LT computer system is designed for years of productive and pleasurable computing. Use this section to keep notes about details of your purchase. Update this section when you add new options.

System Information

Please record your computer's operating information. If you should require technical support in the future, the following information will help the Micron Support Technician locate the specifications for your system and aid in returning it to normal operation.

Model and Serial Number Information	
Purchase Date	
Model Number	
Serial Number	
Order Number	
Customer Number	
Manual Number	MAS001602-00

Micron Technical Support: 1-888-FIX-MYPC (1-888-349-6972)

Technical Support File Library: <http://support.micronpc.com/library/>

Address:

Micron Electronics, Inc.
900 East Karcher Road
Nampa, Idaho 83687

Technical Support Internet Mail:

1. To send an email to Technical Support visit the Micron Electronics Website:
<http://support.micronpc.com/contact/support/>.
2. Click on the **Support Department** for your specific need.

Web site: www.micronpc.com

Type of LCD screen display:

- 12.1" Color TFT XGA LCD
- 13.1" Color TFT XGA LCD

CPU Type: _____

Hard Disk Capacity: _____

Memory Capacity: _____

**NOTE:**

If your system arrives in cold weather, do not apply power to the computer until it has reached room temperature.

Heat, Cold, Humidity, and Glare

Find a spot for your computer that's not too hot, too cold, too dark, or too bright. Glare can make it hard to read the screen. Overheating can destroy computer components, so allow plenty of room for air to circulate around the case. Do not place your TransPort LT in direct sunlight.

**WARNING:**

Do not expose the notebook to cold (frost) or heat, do not leave the notebook in a car, and do not drop it, spill fluids on it, or open the case. This can destroy the notebook and void the warranty. The system's Liquid Crystal Display (LCD) video display may be damaged by exposure to intense sunlight, which builds up excessive heat inside the display enclosure. Only exposure to indirect or subdued sunlight is recommended.

Surge Suppressors

Your computer has its own electrical filters, fuses, and protections, and even its own built-in surge suppressor. However we strongly recommend using a high-quality, external surge suppressor. An external surge suppressor looks like an extension cord with several grounded outlets. It will help shield your computer from lightning strikes, surges, shorts, and other electrical hazards.

Work Location

Your TransPort LT generally will run well in conditions you are comfortable in. But extremes of temperature and humidity can be challenging to your system's parts. There are, however, some things you can tolerate that the computer can't — things like static electricity, dust, water, steam, and oil.

This page intentionally left blank.

Operating Environment

You can use your computer under a wide range of environmental conditions. However, to ensure long use and continued high performance, consider the following factors when setting up your computer:

- Set the computer on a flat, stable surface. To prevent damage to the computer's hard disk drive avoid using the computer where it will be exposed to strong vibration.
- Place the computer away from electromagnetic or radio frequency interference (for example, television/stereo sets, copying machines, and air conditioners).
- Avoid using or storing the computer where it will be exposed to extreme temperatures. In particular, do not leave the computer in direct sunlight, over a radiator, or near a heat source for a long period of time. High temperature can damage the circuitry.
- Avoid exposing the computer to high or low humidity. Extreme humidity can contribute to disk drive failure.
- If you are using the computer with the AC adapter, do not allow anything to rest on the power cord. Do not place the computer where people can step on or trip over the cord.
- The openings on the computer are provided to protect the computer from overheating. To ensure reliable operation, leave about 10 cm (4 inches) around the computer for unobstructed air circulation. Avoid exposing the computer to dust or smoke.

This page intentionally left blank.

Chapter 3 - Introducing Your TransPort LT

Your computer is a lightweight portable computer that includes features to meet your computing needs at home or on the road.

TransPort LT Features

Figure 1, Figure 2, and Figure 3 illustrate the features of your computer.

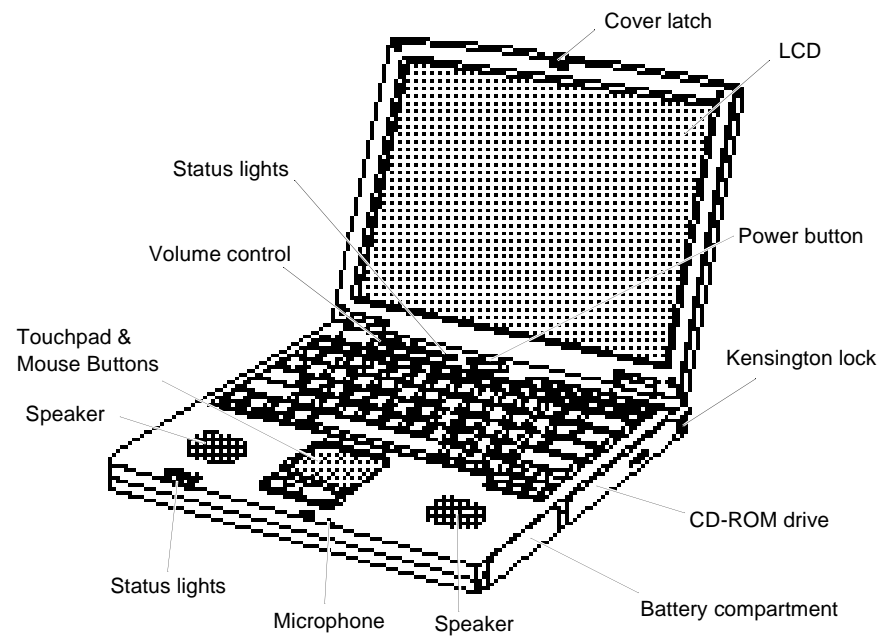

Figure 1. Front and Right view of Computer

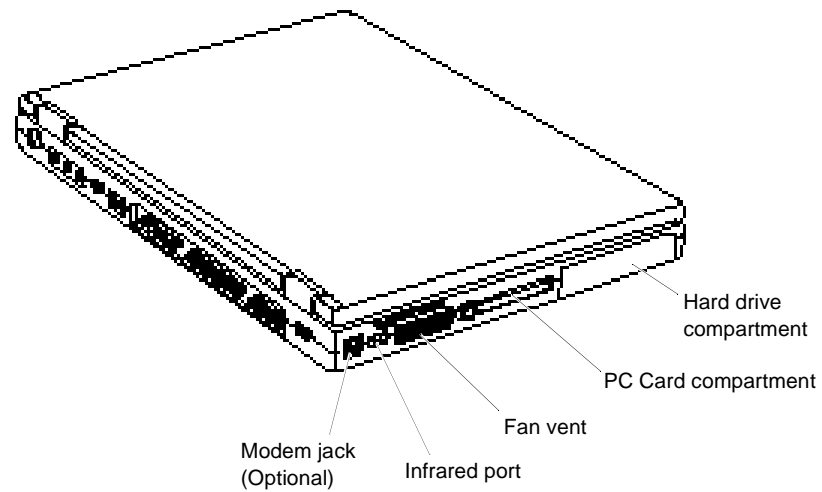

Figure 2. Bottom View of Computer

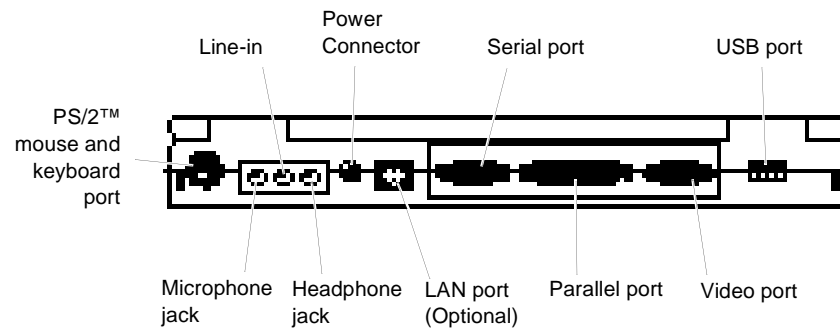

Figure 3. Back View of Computer

Using Your Computer for the First Time

This section gives you detailed information on using your computer for the first time.

Your computer runs on power from the battery in the computer or from an electrical outlet. The first time that you use your computer, fully charge the battery by attaching the power cord to the computer and to an electrical outlet.

Connecting the AC Adapter

To attach the power cord:

1. Plug the AC adapter into the power connector on the back side of the computer (Figure 4).
2. Connect the power cord to the AC adapter and then to an electrical outlet.

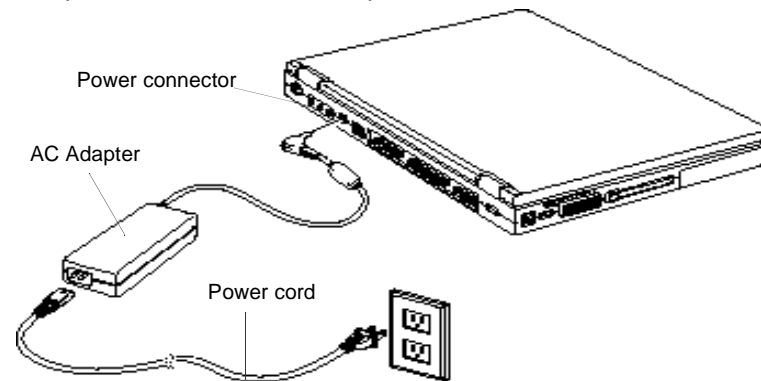

Figure 4. Connecting the AC Adapter

The battery starts charging as soon as you plug the power cord into an electrical outlet. The battery charges faster if the computer is off.

If the battery is fully depleted and the computer is turned off, the battery charges in about two and a half hours. If the computer is turned on, the battery charges in about four hours. When the battery is charging, the battery charge light is amber. When the battery is fully charged, the light turns green.

See "Using the Battery" on page 41 for more information on using your computer's battery.

**CAUTION:**

The best kind of AC power source to connect your TransPort LT to is a UPS (Uninterrupted Power Supply). If you do not have an UPS, use a power strip with a built-in surge protector. Do not use inferior extension cords as this may result in damage to your TransPort LT. The TransPort LT comes with its own AC adapter. Do not use a different adapter to power the computer, and do not use the AC adapter to power other electrical devices. Damage to the computer that is caused by using a different power source will not be covered under warranty.

Turning on the TransPort LT

To turn on the computer's power for the first time:

1. Push the cover latches on the front of the cover to the right and hold.
2. Lift up the cover.
3. Press and then release the power button (Figure 5).

The power light is green when the computer's power is on.

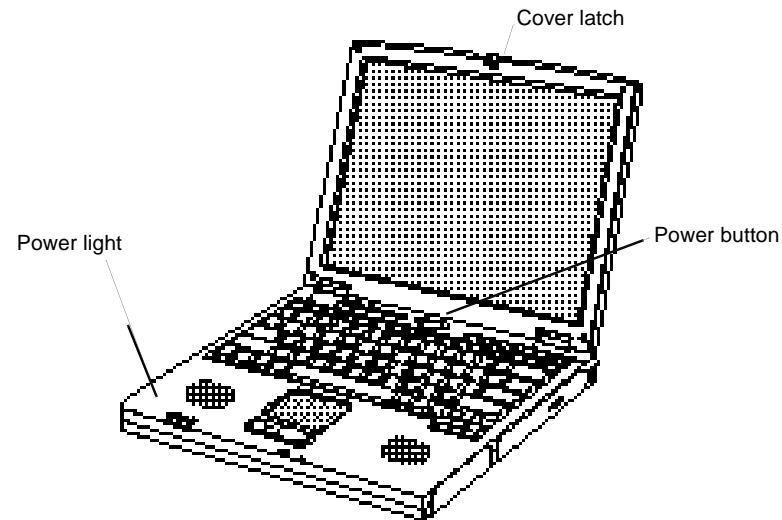

Figure 5. Turning On the Computer's Power

**CAUTION:**

Never turn off or reset your TransPort LT while the hard disk or floppy disk is in use and the FDD and/or HDD status icon is lit; doing so can result in loss or destruction of your data. Always wait at least five seconds after turning off your TransPort LT before turning it back on. Turning the power on and off in rapid succession can damage the TransPort LT's electrical circuitry.

Before you run your system for the first time on battery power, recharge the battery fully to prepare the battery pack for maximum service. When selecting a suitable working location, please consider the ventilation, temperature, dust and dirt, plus electromagnetic and RF interference. The selected location should provide a sturdy and reasonably level surface with at least four inches of open space around the computer cabinet for proper airflow. Your computer functions best at room temperature. Choose a location free from extreme heat or cold.

Except for PC cards, never connect or disconnect any equipment or components while the system power is on.

It is important not to operate the notebook on soft surfaces--such as a bed--as this will cover the ventilation holes of the notebook.

There is one fan on the left side of the notebook, which will turn on when the CPU temperature exceeds 60 degrees Celsius. The fan will turn off when the CPU temperature is below 50 degrees Celsius.

**WARNING:**

If the temperature continues to rise above the CPU allowable limit--either due to a defective fan, or the notebook being operated in an excessively hot environment, or a soft surface that covers the ventilation holes--then the notebook will shut down and all unsaved data will be lost.

Understanding POST

When you turn on your computer, a procedure called POST (Power-On Self-Test) automatically runs to test the computer components. Several messages appear on the screen during POST.

Screen messages are built into the computer to report both normal and abnormal system conditions. If an error message appears, take any action suggested in the message. If the message identifies the error condition but does not suggest any corrective action, write down the message and contact micronpc.com Technical

Support (1.888.FIXMYPC or 1.888.349.6972). (See "Troubleshooting" on page 139.)

Adjusting the LCD Display

You may wish to adjust the LCD (Liquid-Crystal Display) when you begin using your computer. A TFT (Thin-Film Transistor) LCD does not require adjustment for contrast because the contrast is set to remain at maximum.

To adjust the LCD:

- Press [Fn+Up Arrow] to increase the display brightness.
- Press [Fn+Down Arrow] to decrease the display brightness.



NOTE:

When the AC adapter is removed and the system is using battery power, the brightness level will decrease.

Turning Off Your Computer



NOTE:

If your computer has a Windows (98, NT 4.0, 2000) Operating System, turn off your computer by performing the shutdown procedure described in this section. Otherwise, you may lose data.

APM Mode

Advanced Power Management (APM)

To turn off the computer:

1. Click **Start** on the taskbar.
2. Click **Shut Down**.
3. Select the **Shut Down** option.
4. Click **OK**.
 - If the Operating System is Windows 98 or Windows 2000, the computer turns off.
 - If the Operating System is Windows NT, you will receive a shutdown message and you must press the power button to turn off the computer.

Restarting Your Computer

You may need to restart (reboot) your computer when installing hardware or software or if the computer does not respond to your input. A warm (or soft) boot

prompts you to save your files, turns off the computer, and then restarts the computer. A cold boot turns off the computer without saving your files.

To perform a warm (or soft) boot:

1. Click **Start** on the taskbar.
2. Click **Shut Down**.
3. Select the **Restart** option.
4. Click **OK** or **Yes**.
5. Save your files if prompted. Your computer will reboot.

**NOTE:**

Do not perform a cold boot unless your keyboard and touchpad have no effect and you cannot perform a warm boot. When you perform a cold boot, you will lose data unless it was saved to a storage medium.

You can also perform a soft boot by saving your files and pressing [Ctrl+Alt+Del]. You can perform a cold (or hard) boot by pressing the power button to turn the computer off, waiting ten seconds, and then pressing the power button to turn the computer on.

Tips for Using Your Computer

The following information will help you avoid potential problems as you use your Transport LT:

**CAUTION:**

Do not try to disassemble your computer. Opening the system chassis voids your warranty. Only an authorized manufacturer service center can replace or add any parts inside the chassis. For more information, contact micronpc.com Technical Support at 1-888-FIX-MYPC (1-888-349-6972).

- Follow all the instructions and cautions in your computer user documentation.
- The LCD has a polarized surface and can be damaged easily. To prevent damage, avoid touching the screen.
- Use only micronpc.com approved AC adapters, auto adapters, memory modules and other options.
- Because a notebook computer is small and has restricted air flow around components, it is more likely to overheat than a desktop computer. A fan inside your computer runs when needed to help eliminate some heat. Make

sure the fan vent on the right side of your computer is not blocked when you use the computer. (See Figure 1 on page 17 and Figure 2 on page 18 for the location of the vent.) Occasionally check the vents and remove any accumulated dust on the outside.

- Avoid using or storing the computer in extremely hot or cold areas, such as a car on a hot day. Keep the computer away from heaters and out of direct sunlight. Exposure to excessive heat may damage computer components.
- If you have left your computer in a hot place, let it cool down slowly to room temperature (with the LCD panel open) before using it.
- Do not remove the memory-module compartment door, or try to install a memory module when the computer is on. (See "Installing a Memory Module" on page 65 for the location of the door.) (For information on installing memory modules, see "Installing a Memory Module" on page 65.)
- Set up your computer work area to avoid physical strain. Sit with your back straight and supported by your chair. Adjust your chair or work table so that your arms and wrists can remain in a relaxed position, parallel with the floor. Avoid bending or twisting your wrists as you work. Your hands should "float" slightly above the keyboard. Refer to a book on office ergonomics for more information on setting up your work area.
- Take frequent breaks from working at the computer to rest your eyes and stretch your muscles.
- Remember to save your data files frequently and to make backup copies of your files.

Traveling with Your Computer

If you are traveling by airplane, follow these tips:

- Take the computer with you as carry-on luggage. Do not check the computer with your baggage.
- Allow the computer and disks to go through the X-ray security devices. Do not hand-carry disks through the walk-through metal detectors, this can cause data loss.
- Make sure that the battery is charged or the power cord is easily accessible. You may be required to turn on the computer for airport security personnel.
- Be prepared to turn off the computer during take off and landing.
- Contact your airline for information about using an optional airline adapter to power your computer while traveling by airplane.

Handling Spills

Do not spill anything on your computer. The best way to avoid spills is to avoid eating and drinking around your computer. If you do spill something on your computer, turn off your computer, unplug it immediately, and do the following:

- If you spill liquid on the keyboard, drain as much of the liquid from the keyboard as possible. Be careful not to let the liquid drip onto the LCD panel. Allow the system to dry for several days before trying to use it.
- If you spill liquid on an external keyboard or keypad, unplug it and drain as much of the liquid as possible. Allow the keyboard to sit at room temperature for a full day before trying to use it.



NOTE: *Sweet liquids leave a sticky residue that may jam the keyboard despite your efforts to dry it.*

- If you spill liquid on the LCD panel, clean it immediately with a soft cloth and denatured alcohol. Do not use water, acetone, aromatic solvent, or dry, rough towels to clean it.



NOTE: *Some liquids damage the polarized LCD screen. If your screen is damaged, contact your authorized manufacturer's service center for a replacement.*

Storing the Computer for Long Periods

If possible, leave the power cord connected to the computer and an electrical outlet when the computer is not in use. This extends the life of the battery and keeps the battery fully charged.

If you will not be using the computer for a long period of time (a month or more), you should charge the battery until it is completely full. After you have done so, remove the battery from the unit.

Using the Keyboard

Your computer has an 87 key keyboard (Figure 6). By pressing designated key combinations, you can have access to all the key functions of a full-sized keyboard.

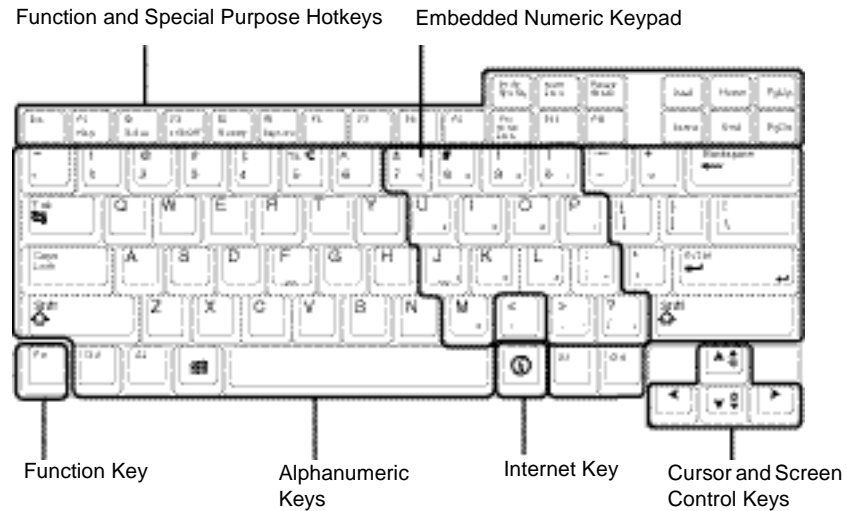

Figure 6. Keyboard

**NOTE:**

Although the layout of the keys on your computer's keyboard is different from that of a desktop computer's keyboard, the keyboard feels like a full-sized keyboard when you use it. The distance between the keys (the pitch) is the same as on a full-size keyboard (19 mm).

The keys on the keyboard can be grouped into the following categories:

- Full-sized Alphanumeric typewriter keys are arranged like a standard typewriter keyboard and are used for text entry. The Windows keys on the left side of the spacebar open the Windows **Start** menu and perform other special functions. The Internet key on the right side of the space bar is used to start your Internet browser.
- Function keys, when pressed together with the [Fn] key, enable special functions.
- Cursor and Screen control keys move the cursor. They may perform other functions, depending on your software.

Using the Embedded Numeric Keypad

Your keyboard includes a numeric keypad, which is a group of keys that you can set to type numbers and mathematical symbols, such as the plus sign (Figure 7). A number or symbol on the right corner of each keypad key shows its numeric function.

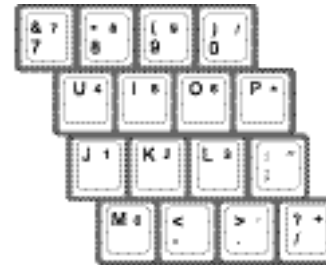

Figure 7. Numeric Keypad

Press [Num Lock] to turn on the embedded numeric keypad. The numeric functions of the keypad are enabled and the Num Lock light turns on. (See "System Status Lights" on page 29 for the location of the Num Lock light.)

While the numeric functions are enabled, you can temporarily return a key to its normal function by pressing [NumLock].

To turn the numeric keypad off, press [Num Lock] again. The Num Lock light turns off.

Using Special Function Keys

The [Fn] key activates special functions when it is pressed in combination with another key. Table 1 shows the special key combinations.

TABLE 1. Description of Special Function Keys

[Fn] Key Combination	Function
[Fn+F2]	<i>Status:</i> Displays the battery gauge in the upper-right corner of your screen. The gauge closes in a few seconds, or you can press [Esc] to close the gauge. (See "Using the Battery Gauge" on page 44 for more information on the battery gauge.)
[Fn+F3]	<i>LCD/CRT:</i> Switches the display between the LCD, the external monitor, and simultaneous display on both the LCD and the external monitor.

[Fn+F4]	<i>Standby:</i> Puts the computer into standby mode. To resume normal operation from standby, press the power button.
[Fn+F5]	<i>KeyLock:</i> Locks the keyboard and activates password protection. Type your password and press [Enter] to unlock the keyboard. The [Fn+F5] key combination has no effect unless a password is enabled and Password on boot is enabled in System Setup. The Num Lock, Caps Lock, and Scroll Lock lights blink when the keyboard is locked.
[[Fn+F10]	<i>Scroll Lock:</i> In some applications, sets the cursor-control keys to scroll the page up or down while the cursor position does not change. Pressing [Fn+F10] again turns off the scrolling function.
[Fn+up Arrow]	<i>Brightness up:</i> Increases the LCD brightness.
[Fn+down Arrow]	<i>Brightness down:</i> Decreases the LCD brightness.



NOTE: When you press a function key combination, the system sound may be temporarily muted or repeat.

Using the Touchpad

Your computer is equipped with a touchpad, which is an integrated-pointing device that is used to perform standard mouse functions (Figure 8). The touchpad is an advanced and reliable pointing device that works with the touch of your finger.

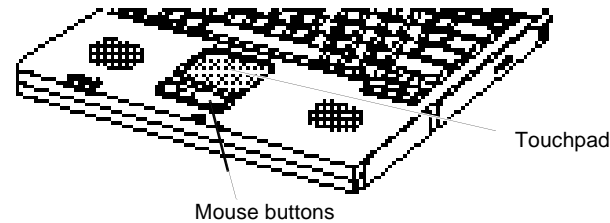

Figure 8. Using the Touchpad

Table 2 explains how to use the touchpad.



NOTE: Press on the touchpad gently. The touchpad responds to light pressure.

TABLE 2. Using the Touchpad

Mouse Action	How To
Move cursor	Place your finger on the touchpad and slide your finger in the direction you want the cursor to move. The faster you move your finger, the faster the cursor moves across the screen.
Click	Tap the touchpad once with your finger.
Double-click	Tap the touchpad twice with one finger.
Scroll up/down	Place your finger on the right hand side of the touchpad and slide it up or down to scroll the current window.
Scroll left/right	Place your finger on the bottom of the touchpad and slide it left or right to scroll the current window.

You can use the buttons below the touchpad in the same way you would use standard mouse buttons. For more information on these features and other features supported by your mouse driver such as button assignment, see the **Mouse** properties in the **Control Panel**.

For information on attaching and using another pointing device or keyboard with your TransPort LT, see “Connecting Peripheral Devices” on page 31.

Reading the System Status Lights







System Status lights show the status of computer functions. The lights appear on the left edge of the computer and left side of the power button (Figure 9).



Figure 9. System Status Lights

Table 3 describes the meaning of the lights.

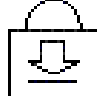
TABLE 3. System Status Lights

Icon	Function of Light
	<i>E-mail:</i> Light is on when e-mail arrives. To enable this function, you need to register your E-mail Account in the <i>Register E-mail Account</i> window. Select Start >Program > StartUp > Internet Launcher to register an E-mail account. This is currently only available in Windows 98.
	<i>Power light:</i> Light is green when the computer is on.
	<i>Battery charge light:</i> When the power cord is connected, the light indicates the battery's charge status. The light is amber when the battery is charging normally. The light is green when the battery is fully charged. (See "Charging the Battery" on page 41 for more information about charging the battery.)
	<i>Num Lock light:</i> The light is on when the embedded numeric keypad is activated. See "Using the Embedded Numeric Keypad" on page 27 for a description of the keypad.
	<i>Caps Lock light:</i> The light is on when the caps lock function is activated. When the function is activated, all alphabetic characters you type will be in upper case.
	<i>Scroll Lock light:</i> The light is on when the scroll lock function is activated. The scroll lock function affects cursor movement and text scrolling in some applications. This is a software specific function. Refer to the appropriate software manuals for a description of the [Scroll Lock] key.
	<i>Drive light:</i> The light is on when the hard drive or floppy drive is being accessed. Do not turn your computer off when this light is on. <u>When the light is amber, the floppy drive is being accessed. When the light is green, the hard drive is being accessed.</u> For a CD-ROM or DVD-ROM drive, check the light on the drive itself to see if the drive is being accessed.

Connecting Peripheral Devices

The connectors on your computer enable you to attach peripheral devices to the computer (Figure 10).



CAUTION:

Turn off your computer before you connect a peripheral device. Connecting a peripheral device with your computer turned on may seriously damage the device or your computer and may void the warranty.

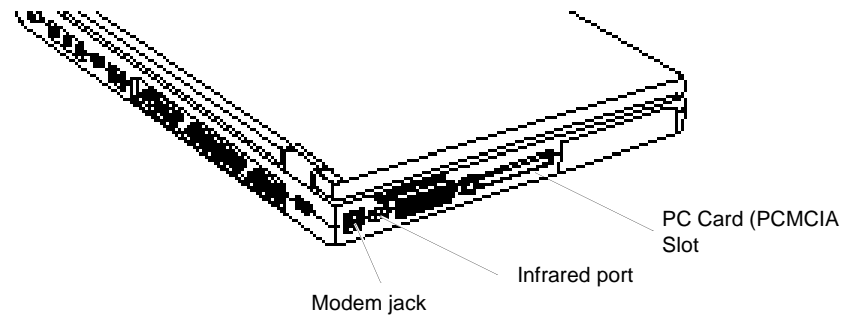
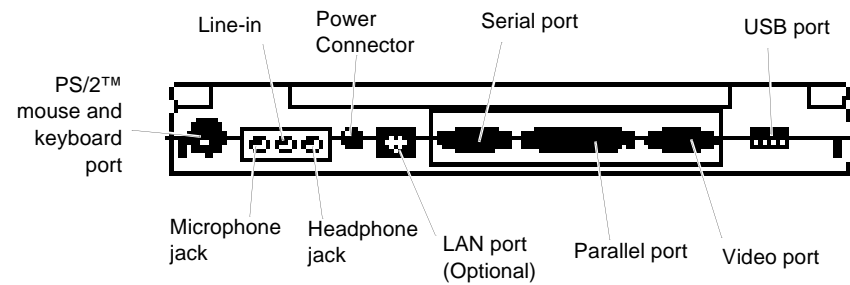
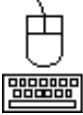



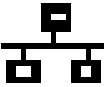



Figure 10. Peripheral Connectors

Table 4 shows the icons located near each connector and describes the devices that you can attach to the connectors.

TABLE 4. Connecting Peripheral Devices

Icon	Connector
	<p><i>PS/2 (Personal System/2) mouse and keyboard port:</i> Connect a PS/2-compatible mouse or external keyboard or keypad to this port. Make sure your computer is turned off when you attach peripherals to the port. You can use the computer's touchpad and a PS/2 keyboard at the same time, see PS/2 Mouse Configuration in the "Advanced Menu" on page 81 for more information</p>
	<p><i>Microphone jack:</i> Connect an external microphone to this jack. A microphone connected to this jack overrides the internal microphone.</p>
	<p><i>Line-in jack:</i> An input for external audio.</p>
	<p><i>Headphone jack:</i> Connect stereo headphones or speakers to this jack. Speakers connected to this jack override the internal speakers.</p>
	<p><i>Power connector:</i> Plug in the AC adapter to run the computer and charge the battery, see "Connecting the AC Adapter" on page 19.</p>
	<p><i>LAN (Local Area Network) port (Optional):</i> Connect LAN cable to this port.</p>
	<p><i>Serial port:</i> Plug a serial device, such as a serial mouse, into this 9-pin port. If the device has a 25-pin connector, you need a 25-to-9-pin serial adapter.</p>



Parallel port: Plug a parallel device, such as a parallel printer or network adapter, into this 25-pin port.



Video port: Plug the interface cable of an external monitor into this 15-pin connector and then plug the monitor power cord into a grounded outlet.



USB (universal serial bus) port: Connect USB devices to this port. USB input/output devices include keyboards, pointing devices, monitors and external FDD module.



Modem jack: Connect a telephone line to connect to the Internet or send/receive faxes, see "Using the Modem" on page 46 for more information.

Port Replicator: Connect a port replicator (Optional) to this connector. See "Port Replicator" on page 68 for more information.

If your computer's Operating System is Windows 98 or Windows 2000, you can use the USB port. The Windows NT 4.0 Operating System does not support USB.

Using the Flex-Bay

Your computer includes the Flex-Bay, a peripheral bay that can hold one of the following devices:

- Floppy disk drive
- CD-ROM drive: shipped with some computers and also available as an option.
- DVD-ROM: shipped with some computers and also available as an option.
- Optional secondary battery: available as an option for your computer.
- LS-120: available as an option.

**CAUTION:**

If your Operating System is Windows 98, you can use the SmartBay Utility to hot-swap the devices. If you do not use Windows 98, make sure that the computer's power is off before you remove or install any devices.

To Remove a Device from the Flex-Bay

1. Turn the computer's power off.
2. Close the LCD panel, and turn the computer over so that the bottom of the unit faces up.
3. Pull up on the Flex-Bay latch and pull the device from the bay (Figure 11).

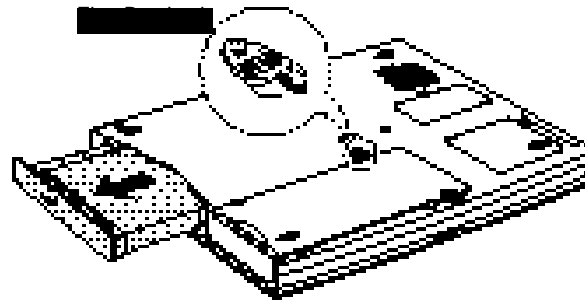

Figure 11. Removing a Device from the Flex-Bay

4. Remove the device out of the bay.

To Install a Device in the Flex-Bay

1. Turn the computer off.
2. Place the device into the bay.
3. Push the device in until it is flush with the chassis.
4. Push down on the Flex-Bay latch until the latch snaps into place.

Your computer's Operating System automatically recognizes the device in the Flex-Bay and configures your computer accordingly.

Using the SmartBay Utility

If your computer shipped with Windows 98, you can use the SmartBay utility to hot-swap your devices in the flex-bay. Currently SmartBay is not functional in Windows NT and Windows 2000.

To start the SmartBay utility:

1. Click the **Start** button on the Windows taskbar.
2. Select **SmartBay Hotswap Utility**.

To remove a device:

1. Open the **SmartBay Hotswap Utility**.
2. Select **Remove Device** and click **OK**.
3. Click **Yes** on the confirmation screen
4. Remove the device by either disconnecting the cable from the computer or from the device.
5. Click **OK**.

To insert a device:

1. Open the **SmartBay Hotswap Utility**.
2. Select **Insert Device** and click **OK**.
3. Connect the device to the computer using the device cable. Make sure all connectors are correctly attached.
4. Click **OK** to allow your computer to detect the device.

If the computer does not detect the device, remove the device and re-install it. Make sure to pay careful attention to the procedures to insure the device is installed correctly.

Using the Floppy Drive

Your computer comes with a 1.44 MB, 3.5-inch, high-density floppy drive, which can read, write to, and format the following disks:

- A high-density, 3.5-inch disk, which stores 1.44 MB (megabytes) of data.
- A double-density, 3.5-inch disk, which stores 720 KB (kilobytes) of data.

**NOTE:**

The floppy drive in your notebook computer is smaller, but more power-efficient, than a floppy drive in a desktop computer. To get the best performance from your floppy drive use high-quality floppy disks, such as those available at <http://www.e-additions.com>.

The computer is shipped from the factory with both a floppy drive and a CD-ROM or DVD-ROM drive included.



CAUTION: *The external USB FDD Drive is recognized as the last drive. For example, the drive letter will be E: in case the CD-ROM drive is installed into Flex Bay.*

To use the floppy drive and the CD-ROM at the same time, install the CD-ROM drive in the Flex-Bay. Then attach one end of the USB cable to the floppy drive compartment and the other to the external USB port on the computer. (Figure 12) The USB Floppy Drive is an optional item in Windows 98 and Windows 2000.

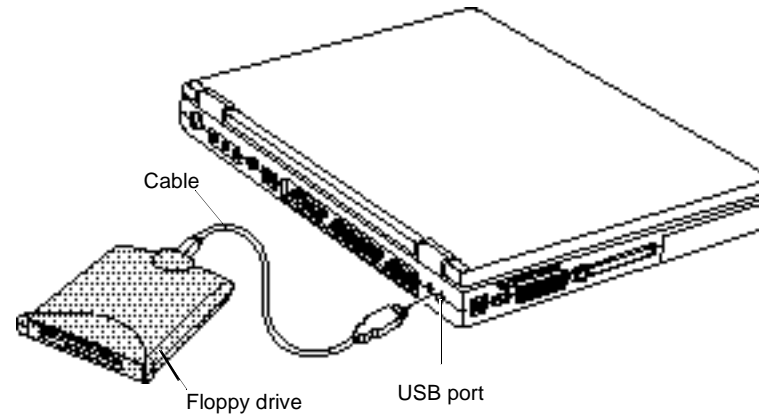

Figure 12. Inserting a Floppy Disk



NOTE: *If you want to use the floppy disk drive within the computer, then detach the floppy disk drive from the external FDD drive compartment and insert the floppy disk drive into the Flex-Bay. See "Using the Flex-Bay" on page 33.*

The floppy drive light is on when the computer writes to or reads from a floppy disk. Do not remove a disk when this light is on.

To protect the data on your floppy disks, follow these guidelines:

- Keep disks away from excessive heat, direct sunlight, and liquids.
- Keep magnets and any device that contains a magnet (like the telephone) away from your disks.



CAUTION: *Magnetic fields can destroy the information on a disk.*

- Do not write directly on a label on your disk; instead, write on a disk label first and then attach the label to the disk.
- Make copies of all your important disks.

Using the CD-ROM Drive

Compact Disc Drives are designed so that you can easily insert one into the computer when you need it, and then remove it. See "Using the Flex-Bay" on page 33 for information on installing the CD-ROM drive into the Flex-Bay type computer.

1. Press the button on the CD-ROM drive, and the tray slides out. (Do not lean on the tray; it does not support much weight.)



CAUTION:

If the tray fails to slide out it may be stuck, in which you can use the emergency eject button to open the CD-ROM. Turn the computer's power off. Straighten out a paper clip (or some other similar object), insert it into the small hole in the front of the CD-ROM to press the button. The CD-ROM should eject.

2. Insert a CD (compact disc), label side up (or remove a disc, if you have finished using it).
3. Push the tray in gently to close the drive tray (Figure 13).

A light on the drive tray is on when the computer is reading from a CD. Do not remove a disc when this light is on.

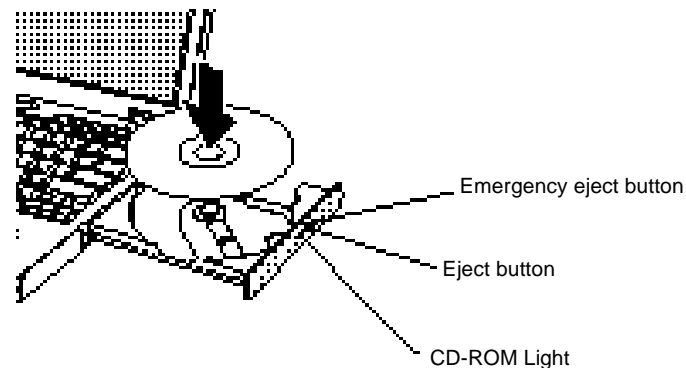

Figure 13. Using the CD-ROM Drive

Install and start a CD-based program in the same way you would run a program on a floppy disk. See your Operating System documentation for more information on running programs.

The name of the CD-ROM drive is the letter following the letter assigned to your last hard drive. For instance, if you have one hard drive with two hard drive partitions, the hard drives are drives C and D and the CD-ROM drive is drive E.

**NOTE:**

Your TransPort LT comes from the factory with the CD/DVD set as R:\.

**WARNING:**

Do not place reflective objects in the disc slot because of possible hazardous laser emissions. The laser beam used in this CD-ROM drive is harmful to the eyes. Do not attempt to disassemble the CD-ROM drive.

The on-board audio hardware and software of your computer enable the computer to play audio compact discs. If you wish to do so, you can attach external speakers to the Headphone jack.

To play an audio compact disc:

1. Insert a compact disc into your CD-ROM drive.
2. Press the button on the CD-ROM drive.
3. When the tray slides out, insert a CD, label side up.
4. Close the drive tray. The CD Player button appears on the task bar. The disc begins to play.

A light on the drive tray is on when the computer plays a CD. Do not remove a disc when this light is on.

To remove the CD:

1. Click the CD Player button on the Windows task bar to open the CD Player window (Figure 14).

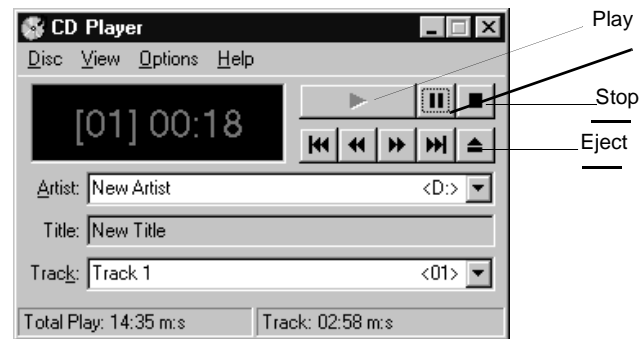

Figure 14. CD Player Window

2. Click the **Stop** button in the **CD Player** window.
3. Click the **Eject** button on the **CD Player** window or press the button on your CD-ROM drive. The drive tray opens and you can remove the disc from the CD-ROM drive. For more information on playing compact discs, see the **Help** menu in the **CD Player** window.

Using the Hard Drive

Your computer includes a removable IDE (integrated drive electronics) hard drive. The IDE hard drive can store the data and programs your computer uses. The drive plugs into a connector on the system board.

Although the storage capacity of hard drives vary according to the model, any hard drive holds much more than a floppy disk does. Also, the computer reads and works with a hard drive more rapidly than with a floppy disk.

Once information is saved on a hard drive, it remains there until it is overwritten. Hard drive heads park automatically when you turn off your computer.

**CAUTION:**

The hard drive that comes with your computer has already been formatted. Do not format the hard drive. Doing so destroys all data contained on the drive. If you need to format a new drive, or want to erase all data on your existing hard drive, refer to the manual for your Operating System.

Although Windows 98 can work with FAT-16 or FAT-32 (a 32-bit file allocation table), your computer has been supplied with FAT-32. Older software that you may have (16-bit software) may require FAT-16 to run. Similarly, Windows NT 4.0 can use FAT-16 or NTFS (the Windows NT file system). There are utilities included with Windows 98 and Windows 2000 to convert from FAT-16 to FAT-32 or NTFS (Windows NT 4.0 and Windows 2000), see the documentation included with your Operating System for more information.

The MRestore disk includes Partition Magic that also allows you to convert partitions. For more information, see "MRestore CD-ROM" on page 99.



CAUTION: *It is not possible to convert from FAT-32 or NTFS to FAT-16 without reformatting your hard drive.*

Removing the Hard Drive



CAUTION: *To prevent loss of data and damage to the disk, do not remove the hard drive while the computer's power is on and do not drop or jar the hard drive.*

To remove the hard drive from the computer:

1. If you are installing a new hard drive, backup the application and data files on the old hard drive before removing it from the computer.
2. Turn the computer off.
3. Close the LCD panel, and turn the computer over so that the bottom of the unit faces up.
4. Remove the screw that holds the hard drive in place (Figure 15).

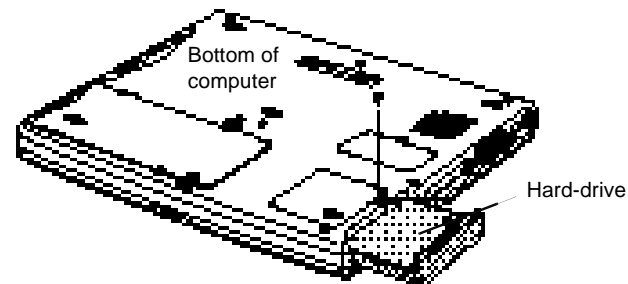

Figure 15. Removing the Hard Drive

5. Pull the hard drive out of the computer.



CAUTION: *Only install a hard drive that is thinner than 9.5 mm in this computer.*

Installing a Hard Drive

To install a hard drive:

1. Remove the old hard drive from the computer as described in the previous section.
2. Slide the new drive into the hard drive compartment. Make sure the drive is pushed back as far as it will go.
3. Install the screw that holds the hard drive in place.
4. If you intend to use save-to-disk mode, see "Creating a Save-To-Disk Partition" on page 97.
5. Format your drive and reinstall your files. See "MCRC (Micron Customer Resource Center)" on page 99 for instructions on re-installing the Operating System and drivers for your TransPort LT notebook computer.

Using the Battery

Your computer uses a smart rechargeable Lithium-ion (Li-ion) battery pack for power when the AC adapter is not attached to an electrical outlet. The smart battery gives an accurate measurement of the current battery capacity which helps extend operating time by enabling effective power management in Operating Systems that take advantage of the accurate information supplied by the battery.

Charging the Battery

Your computer's battery starts charging automatically when you connect the power to the computer and to an electrical outlet. If the computer is off, the battery charges faster than if the computer's power is on.

Approximate charging times for Li-Ion (Ni-MH) battery are:

- Two and a half (2.5) hours with the computer off.
- Four (4) hours with the computer on.

While the battery is charging normally, the battery charge light on the computer is amber (See "System Status Lights" on page 29 for the location of the battery charge light). When the battery is fully charged, the light changes to green.

When you use a new battery pack for the first time or use a battery after a long period of storage, the initial battery life is shorter than normal. Normal battery life resumes after a few discharge-recharge cycles.

Follow these rules for charging your battery:

- A battery normally discharges power when not used for long periods of time. Be sure to recharge the battery every two months when it is not in use.
- Make it a practice to discharge your battery fully before recharging the battery. This can help extend the life of the battery.
- Do not attempt to charge the battery in temperatures of under 41° F (5° C) or over 95° F (35° C.)



NOTE: *All batteries eventually wear out and lose the ability to hold a charge. You may need to replace your battery pack after a year of average usage.*

Safely Using the Battery

Follow these guidelines to safely use the battery:

- Turn off your computer and unplug it if you accidentally:
 - Expose the equipment to liquid.
 - Drop, jar, or damage the computer.
- Do not disassemble the battery, heat it above 212° F (100° C), or burn it. The battery used in this computer may cause a fire or chemical burn if mistreated.
- Your computer's rechargeable battery may be considered hazardous waste. If you replace your battery with a new one:
 - Keep the old battery out of the reach of children.
 - Dispose of the old battery promptly.
 - Make sure that you follow all local requirements when you dispose of the old battery.

Removing the Battery

Your computer comes with the battery pack inserted in the computer. To remove the battery from the computer:

1. Turn the computer off.

2. Close the LCD panel, and turn the computer over so that the bottom of the unit faces up.
3. Push down the battery latch and hold it, then pull the battery pack from the computer. (Figure 16)

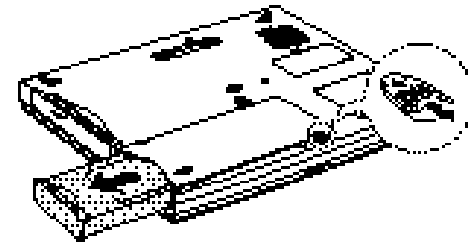

Figure 16. Removing the Battery Pack

Installing the Battery

To install the battery pack:

1. With the computer's power off, close the LCD panel and turn the computer over so the bottom of the unit faces up.
2. Slide the battery pack into the compartment. Make sure the battery is fully inserted into the compartment.

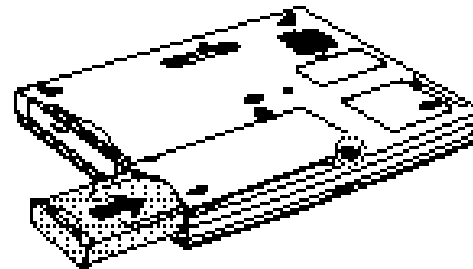

Figure 17. Installing the Battery



CAUTION:

Insert the battery into the battery compartment, ensuring the correct orientation so that the battery fits in its slot properly.

Monitoring the Battery Charge

Battery life is effected by factors such as the power-management settings in System Setup, the applications you use, and the brightness settings of the LCD. Under normal usage, the battery charge lasts approximately two and a half hours.



NOTE:

Battery life estimates are subject to variation. The actual life of your battery may be less than the estimates given in this manual.

You can monitor the charge of the battery pack installed in your computer through the battery gauge.

Using the Battery Gauge

Press [Fn+F2] to display the battery gauge on the LCD. You can display the battery gauge while you are in any program.

The gauge has four sections:

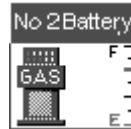

- The top/left section of the gauge indicates whether the secondary battery is used or not. If it is used, the two digit decimal number that represents the status of secondary battery charge remaining.



- The top/right section indicates the approximate amount of the primary battery charge remaining.

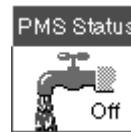

- The bottom/left section of the gauge shows you current PMS (Power management Setting) status which is set in the system setup. It shows *Off* when the AC adapter is plugged in.

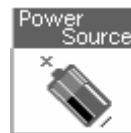

- The bottom/right section indicates whether the computer is being powered by the battery or by the AC adapter. An icon of a power cord plug indicates an internal AC adapter power source and a battery icon (shown) indicates a battery power source.

While the battery gauge is displayed, all keys except [Esc] are disabled. The battery gauge closes in a few seconds, or you can press [Esc] to close it.

Using PowerProfiler to Monitor the Battery

Use PowerProfiler to set power-management options for computers shipped with Windows NT installed. To use PowerProfiler to monitor the battery charge, place the cursor on the battery icon in the right corner of the task bar. PowerProfiler shows you the amount of battery charge remaining.

To set battery monitoring options in PowerProfiler:

1. Double-click the **PowerProfiler** battery icon to open the software.
2. Click the **Battery** tab.
3. Set options under **Battery Status and Alarm Settings**.

For more information on PowerProfiler, see the Help option in the PowerProfiler software.

Battery Warnings

Your computer gives you the following low-battery warnings (Table 5).

TABLE 5. Battery Warnings

Warnings	Condition	Action to Take
The computer beeps 5 times.	Battery low: The battery charge is about 10 percent. Approximately 5–10 minutes of battery charge is left.	Save your work. Use the power cord to power the computer or turn off the computer and install a fully charged battery.
The computer beeps 5 times, with a short time between beeps. After a short time, the computer automatically goes into rest mode.	Battery very low: The battery charge is about 5 percent.	Use the power cord to power the computer and charge the battery.

The above features are valid with Windows 95/98 APM compliant Operating Systems. In the case of a Windows 98 or any other ACPI compliant Operating System which is running on APM interface, you should adjust the battery alarm features by using the Operating Systems power management program (Control Panel > Power management in Windows 98).

Windows 98 and Windows 2000 can operate in APM or ACPI mode, in the APM mode you should select the Rest mode of the low battery situations (Power On Suspend/Save-to-Disk) in BIOS setup. See “Power Menu” on page 84.

If you cannot run your computer from the battery and the battery will not charge when you attach the power cord, the problem may be that:

- The battery temperature is below 41° F (5° C) or over 95° F (35° C). If you think the battery temperature is too hot or too cold, turn off the computer, remove the battery, and let the battery reach room temperature. Then try charging the battery again.
- The battery is defective. Replace the battery with a new battery.

Using the Modem

All TransPort LT notebooks ship with an internal modem installed. The combination Modem/NIC is optional.

Precautions Before Use

**NOTE:**

The TransPort LT Modem with a PCI interface does not support DOS mode. You can use DOS box in Windows 98 instead of pure DOS mode.

**WARNING:**

If you connect the modem to the digital key-phone line, the modem will be damaged.

*Using the modem on a PBX system
(Key-phone system)*

If you use a simple terminal program you should type *ATX3&W* or *ATX3* command as an initialization command.

If you use a **Windows Communication Program** follow the instructions below.

1. Click the **Start** button and then point to **Settings**.
2. Click **Control Panel**.
3. Double-click the **Modems** icon and the click **Properties** button at the **General** tab.
4. Check the **Wait for dial tone before dialing** check box at the **Connection** tab.

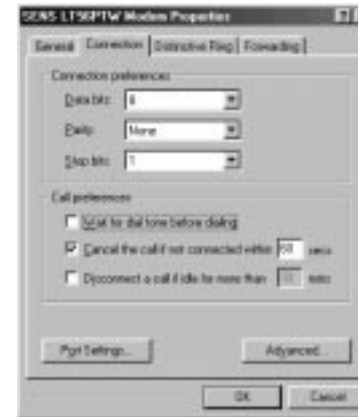

Figure 18. Modem Properties Dialog Box

5. Click **OK** to close the dialog box.
6. Click **OK** to close **Modem Properties** dialog box.

Description of 56K

There are different standards regarding 56K technology.

- K56Flex
Technology developed by Rockwell Semiconductor Systems and Lucent Technologies
- X2
Technology developed by USR (US Robotics, now 3Com)



NOTE: *K56Flex and X2 are not interoperable.*

- V.90 Standard.
In February 1998, The ITU-T (ITU Telecommunication Standardization Sector) agreed on the technical specifications for 56K modems (V.90) and has approved in mid-September, 1998. But, the modem driver can be updated to resolve fine points of operation between different vendor's modems and unusual telephone line conditions.

**NOTE:**

1. Due to FCC limitations, speeds of 53kbps are the maximum permissible transmit power levels during download transmissions. Actual data speeds will vary depending on line conditions.

2. In order to use the 56K feature, be sure to check if the standards supported by the on-line service provider and the modem are identical.

If you use a PBX phone system, you cannot connect using the 56K mode due to line loss.

Modem Specifications

- Data communications.
 - V.90, K56Flex, V.34+, V.34, V.32bis, V.32, V22bis, V.22, V.21, BELL212A, BELL103
- Data throughput speed
 - 56,000 bps ~ 28,000 bps (V.90, downstream only, step: about 1333 bps)
 - 56,000 bps ~ 32,000 bps (K56Flex, downstream only, step: 2000 bps)
 - 33,600 bps ~ 2,400 bps (step: 2400 bps)
 - 1,200 bps
 - 300 bps
- Fax mode support.
V.29, V.27ter, V.21ch2, V.17
- Fax throughput speed.
14400, 12000, 9600, 7200, 4800, 2400, 300
- Data compression feature.
V.42bis, MNP CLASS 5
- Data correction feature.
V.42 LAPM, MNP CLASS 2~4
- Fax capacity.
CLASS 1
- Plug and Play feature.
Microsoft Windows 95/98 Plug and Play Support
- PCI 2.1, PPMI 1.0 support

Installing the Modem Driver in Windows 95/98

You can install the modem drive as shown in the following instructions. Refer to the MRestore CD that comes with your Transport LT for Modem installation instructions for your Operating System.

Modem Commands

The Transport LT Modem includes the basic commands used by the Smart Modem of the Hayes Corporation. Additional commands are added to improve its capacity.

What are AT commands?

AT commands are the control commands of Fax modems developed by the Hayes Corporation. AT commands are the industry standard and are necessary for any fax modem. It is used with S-register to set the modem status.

Generally, AT commands are used by directly entering the command into any communications program, like Hyper terminal.

You can perform the following functions more easily by using AT commands.

- Calling up or hanging up the phone in order to communicate by computer modem.
- Choosing a modem in order to make the most efficient communication status.

Communication programs are becoming more efficient and more intelligent, and users do not need to know all the AT commands. Knowing a few basic commands is enough for computer communications.

Before Using AT Commands

To use AT commands, enter them into terminal-based communication programs directly. (Hyper terminal within Windows 98 and Windows NT, and third party communication programs like CrossTalk and Procomm.)

CompuServe and America On-line applications are not terminal-based communication programs, but they are communication programs based on Graphic environment. These programs, and those like them, can initiate the modem setting by entering an AT command in a menu with a modem initialization command.

Before using AT commands you have to know there are two kinds of modes when you use it.

Command Mode

If you turn on your computer and start communication by a communication program, you can see a prompt on the terminal screen. Under such conditions, you can use AT commands like calling, etc.

DATA Mode

In command mode, you can call by using AT commands and communicate with others by connecting to other modems. You can call this status Data mode or On-line mode. In data mode, you cannot use any AT commands except the +++ command, which has +++ at the head.

If you stop communication and disconnect the phone, the Fax modem will run in command mode again.

Using Command Mode during Communications

Sometimes, you have to use AT commands while you're communicating with others via modem. In this case, you can use +++ commands for AT commands without hanging up your telephone. Pressing '+' three times makes fax modem change to command mode. The telephone will not be disconnected. (Do not press the [Enter] key after input +++).

**CAUTION:**

If you want to return to Data Mode, the connection may be lost depending on the server.

If you want return to Data mode from command mode, you only have to input ATO and press the [Enter] key to start the communications again.

**CAUTION:**

The mode cannot be transferred from the command mode to the data mode depending on the server.

Using AT commands

AT commands can be used in the following way. There's no difference between capital letters and small letters, and all commands should include 'AT' as a prefix except ones which include 'A/' instead.

Also, Carriage Returns saved in the S3 register should be entered in order to signal the end of the command.

AT command - press the [Enter] key.

Example: ATDT 123-4567 - press [Enter] and the modem dials to 123-4567.

Display the result value

After entering AT commands, the result value is displayed on the screen.

The result value can be displayed during communication. Generally, the result will be OK. According to the ATV command, the result can be displayed as Words or numeral letters. (ATVO: Display as numeral letters, ATV1: Display as English words).

Basic AT Commands

A/	Repeats the previous command in the buffer
ATA	Responds manually to incoming RING signals
+++	Switches from on-line mode to command mode
ATO	Switches from command mode to on-line mode
ATEn	Echo control
E0	Disables echoing of the commands to the screen
E1	Enables echoing of the commands to the screen
ATDT phone number	Touch tone dial
ATDP phone number	Pulse dial
ATHn	Hook control
H0	On-Hook (same as hang-up)
H1	Off-Hook (same as hold-on)
ATLn	Modem speaker loudness control
L0~1	Low volume
L2	Medium volume
L3	High volume
ATMn	Modem speaker control
M0	Disables modem speaker
M1	Enables only when in connection procedure

M2 Enables always

M3 Enables until carrier has been detected after connection

ATS0=n Sets S0 register value (n range: 0~255). Sets the number of incoming ring signals before answering. The Modem responds after as many incoming rings as specified in n value. If the value of n is '0', ATA command should be entered for auto answer.

ATS0? Displays S0 register value on the terminal

ATX3 Dials after waiting for specified time

ATX4 Dials after dial tone is detected

ATZ Initializes modem

AT&F Loads the factory default configuration (profile)

AT&V Shows current configuration

AT&W Saves user profile

AT&Zn=x Stores the dial string in modem memory (n=0~3, x=phone number) e.g.)

AT&Z0=1235678

Automatically calls the stored phone number by using the following command.

ATDTS0 Recalls the stored phone number as AT&Z0 by tone dial

ATDPS0 Recalls the stored phone number as AT&Z0 by pulse dial

AT+MS=X Sets protocol for modem connection

(X=V90, V34)

AT+MS=V90 (default setting)

Try to connect with V90 (max 56 Kbps)

AT+MS=V34

Try to connect with V.34 (max 33.6 Kbps)

Chapter 4 - Video Features and Configuration

Resolution and Color Depth

Your computer includes a TFT LCD or active-matrix display. The capabilities of the screen plus the video drivers installed on the computer determine the quality of the image your LCD can display.

The following sections describe the display capabilities of your computer.

The resolution of the LCD is the sharpness of the image it can display. Resolution is measured by the number of pixels (individual dots) displayed on the entire screen. In general, the more pixels the LCD can display, the better the image.

Your LCD screen is 12.1 SVGA, with a maximum display of 800x600, about 800,000 pixels.

The number of colors the LCD can display is measured by how many bits the LCD uses to represent each pixel:

- 8-bit color can support 256 different colors.
- 16-bit color can support 64 K (65,536) colors.
- 24-bit color can support 16 M (16.8 million) colors.
- 32-bit color can support 16 M (16.8 million) colors.

24-bit color uses the RGB color model.

32-bit color uses the CMYK color model which gives better printed color matching.

Table 6 lists the basic video mode capabilities and maximum colors supported by your computer.

TABLE 6. Video Driver Capabilities

Software Drivers	Resolution Supported with 4MB(8MB) SGRAM	Number of Colors
Windows 98	640x480, 720x480, 800x600, 848x480, 1024x768, 1152x864, 1280x1024, 1600x1200	256
	640x480, 720x480, 800x600, 848x480, 1024x768, 1152x864, 1280x1024, 1600x1200	65,536
	640x480, 720x480, 800x600, 848x480, 1024x768, 1152x864, 1280x1024, (1600x1200)	16.8 million (24 bit)
	640x480, 720x480, 800x600, 848x480, 1024x768, 1152x864, (1280x1024)	16.8 million (32 bit)
Windows NT 4.0	640x480, 800x600, 1024x768, 1152x864, 1280x1024, 1600x1200	256
	640x480, 800x600, 1024x768, 1152x864, 1280x1024, 1600x1200	65,536
	640x480, 800x600, 1024x768, 1152x864, 1280x1024, (1600x1200)	16.8 million (24 bit)
	640x480, 800x600, 1024x768, 1152x864, (1280x1024)	16.8 million (32 bit)

All these video modes can be displayed on an external monitor. However, if you disconnect an external monitor that was attached to your computer and then start the computer, the LCD may revert to a different resolution than the one you chose for the external monitor.

Configuring Display Features

The following sections describe how to configure the display settings on your computer.

Selecting a Monitor Type

When you attach an external monitor to your computer, Windows 98 automatically selects display settings for it (this feature is not available in Windows NT). If you wish, you can adjust the display settings by selecting a monitor type:

1. Click the **Start** button on the Windows 98 task bar.
2. Select **Settings**.
3. Click **Control Panel**. The **Control Panel** window appears.

4. Double-click the **Display** icon. The **Display Properties** window appears.
5. Click the **Settings** tab. The **Settings** screen appears.
6. Click the **Advanced** button. The **Advanced Properties** screen appears.
7. Click the **Monitor** tab.
8. Click the **Change** button. The **Update Device Driver Wizard** screen appears.
9. Click the **Next** button.
10. Select the **Display a list of all the drivers in a specific location**, so you can select the driver you want radio button and click the **Next** button.
11. Select the **Show all hardware** radio button.
12. Select a manufacturer and model setting that matches your external monitor. Your computer has an intelligent video chip set that automatically matches your LCD panel resolution and frequency when an external monitor is not present.
13. Click the **Next** button.
14. The **Update Device Driver Wizard** screen appears showing the driver location of the device you have selected. Click the **Next** button.
15. Follow any prompts that appear on the screen.

Changing Color Depth and Resolution

To change the color depth and resolution of your LCD or external monitor:

1. Click the **Start** button on the **Windows** task bar.
2. Select **Settings**.
3. Click **Control Panel**. The **Control Panel** window appears.
4. Double-click the **Display** icon. The **Display Properties** window appears.

5. Click the **Settings** tab. The **Settings** screen appears.

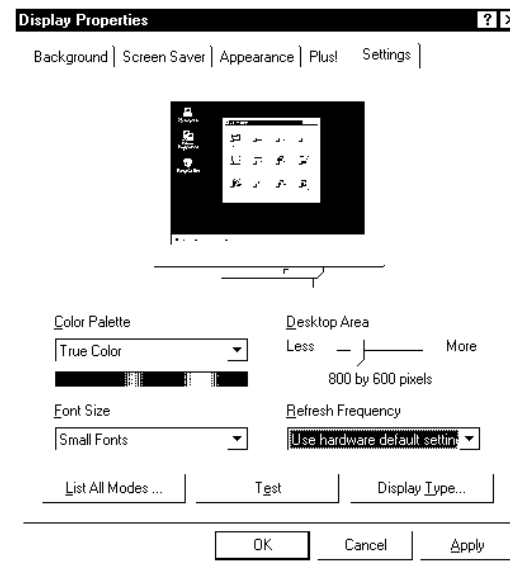

Figure 19. Display properties in Windows NT 4.0

6. To change the color depth, click the arrow next to **Color palette** and select the color depth you want.
7. To change the resolution, click and drag the knob under the **Screen** area until you select the resolution you want.
8. Click the **OK** button.
9. Follow the prompts that appear on the screen.

Changing the Video Driver

It is possible that you may want to update your video driver or that your installed video driver has become corrupt so that the display is unusable.

Windows 98:

1. Click on the **Start** button. The **Start Menu** will appear.
2. Select **Settings** and click on **Control Panel**, double click on **Display**. The **Display Properties** window appears.
3. Click the **Advanced** button. The properties screen for your currently installed video driver appears.
4. Select the **Adapter** menu.

5. Click the **Change** button. The **Update Device Driver Wizard** window appears.
6. Click the **Next** button.
7. Select **Display a list of all the drivers in a specific location**, so you can select the driver you want. Click the **Next** button.
8. Click the **Have disk** button. If the driver is on a floppy disk insert it into the floppy drive. Click the **Browse** button and locate the driver you want to install. Click the **OK** button.
9. Select the new driver in the **Select Device** screen and click the **OK** button.
10. Click the **Next** button to install the new driver and follow any directions on the screen to finish setting the display properties.

Windows NT 4.0:

1. Log on to the computer as supervisor. The **Invalid Display Settings** window may appear.
2. Click on the **Start** button and the **Start Menu** appears.
3. Select **Settings** and click on **Control Panel**, double click on **Display**. The **Display Properties** window appears.
4. Select the **Settings** menu.
5. Click the **Display Type** button. The **Display Type** window appears.
6. Click the **Change** button. The **Change Display** window appears.
7. Click the **Have disk** button. If the driver is on a floppy disk insert it into the floppy drive or if you want to use the original factory driver, insert the Restore CD-ROM into the CD-ROM drive. Enter the path to the directory where the drivers are located or click the **Browse** button and locate driver you want to install. Click the **OK** button.

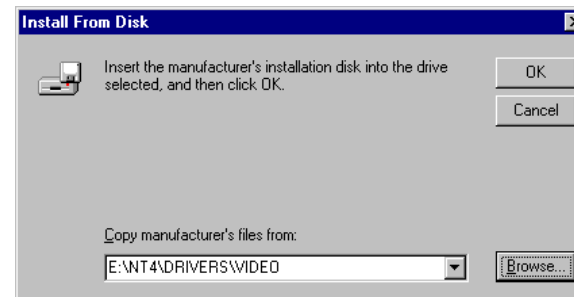

Figure 20. Enter location of the driver files

A line similar to the following line appears under the *Display* option: *ATI 3D RAGE Mobility*.

8. Click **OK**. The **Third-Party Drivers** warning window appears.
9. Click **Yes**. The driver is copied. A window appears informing you the driver has been successfully copied.
10. Click **OK**. Remove the disk from the floppy drive. Close the open windows on the screen.
11. Click **Yes** when prompted to restart the computer. As the computer restarts, select **Windows NT Workstation Version 4.00** as the Operating System and press [Enter].
12. Log on as supervisor. The **Invalid Display Settings** window will appear.
13. Click the **OK** button. Click the **Test** button at the **Display Properties** window and follow any directions on the screen to finish setting the display properties.

Working with PC Cards

By installing PC Cards, you can add functions to your notebook computer similar to those found on add-in boards for desktop computers. Available PC Cards include:

- Input/output, such as modem, network, pager, video capture, and SCSI cards.
- Storage, such as hard drive and flash (SRAM) cards.
- Combo cards, such as a combination modem and network card.

Your computer includes the following PC Card support:

- Two PC-Card slots: You can install Type I, II, or III cards in the slots. Type III cards are thicker than Types I and II. If you install a Type III card in the bottom slot, you cannot install a card in the top slot.
- CardBus hardware and software: CardBus enables the computer to use 32-bit PC Cards. Windows 98 supports 32-bit and 16-bit PC Cards. The SystemSoft® CardWizard™ for Windows NT program, provided with systems that ship from the factory with Windows NT installed, also supports both 16-bit and 32-bit cards.
- Zoomed video: Both PC Card slots and the video chip on your computer support zoomed video. When you install a zoom video PC Card in the upper or lower slot, data can be transferred directly from the PC Card to

video and audio systems without going through the microprocessor. Video conferencing and real-time multimedia devices, such as video cameras, are supported by zoomed video.



NOTE: *To use the CardBus and zoomed video technology with Windows NT, install the CardBus and zoomed video drivers provided with your PC Card. If no drivers were supplied with your card, contact the PC Card manufacturer. ATA (AT attachment) and modem PC Cards do not require extra drivers.*

Maintaining PC Cards

To maintain your PC Cards, follow these guidelines:

- Keep cards away from excessive heat, direct sunlight, and liquids.
- Do not drop, bend, flex, or crush cards when handling.
- Keep dust, magnets, and static electricity away from PC Cards.
- When a card is not in use, carry it in its protective carrying case.
- Some PC Cards include cables that extend from the back of the cards. Be careful not to bend or put excessive strain on these cables.

Using PC Cards

You can install PC Cards while the computer is on. To insert a PC Card into a slot:

1. Push the slot door in with the PC Card.
2. Align the card with a slot and insert the card into the slot until it locks in place (Figure 21).

To remove a PC Card:

1. Push the eject button once to pop it outward.
2. Push the eject button again, then the card will be ejected.

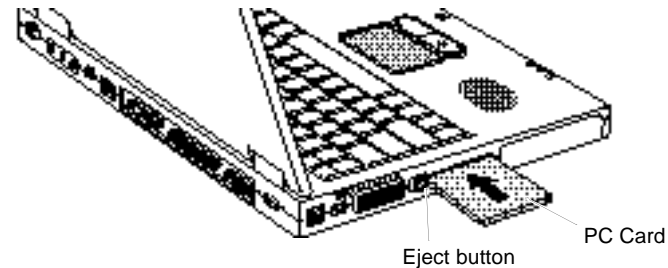

Figure 21. Inserting a PC Card

Windows 98

Windows 98 automatically assigns computer resources (such as communication ports and memory addresses) to a PC Card installed in your computer. For further information on configuring a PC Card in Windows 98, see the index entry *PC card* in the Windows Help. Windows 98 also handles power management for PC Cards.



NOTE: Use the following procedures to remove PC Cards, or you may lose data that is being stored to a card.

To remove a PC Card from your computer using Windows 98 Operating System:

1. Click the **PC Card** icon on the task bar.
2. Select the name of the card you want to remove, and then click the **Stop** button.
3. Push the card eject button on the side of the PC Card slot when prompted to do so and then pull the card out of the PC Card slot.

Windows NT

Systemsoft Card Wizard is shipped with notebook computers that use Windows NT as the Operating System. When you install a PC Card, CardWizard attempts to configure it automatically. If Card Wizard successfully assigns system resources to your card, the computer beeps twice.

If CardWizard cannot automatically configure your PC Card, the computer beeps once and a message appears telling you that the card has not been configured. Click the **Wizard** button on the CardWizard window. CardWizard then analyzes why the card was not configured and fixes the problem or gives you information to help fix the problem.

CardWizard works with the PowerProfiler program to manage PC Cards when the computer enters or resumes from rest mode. CardWizard gives you instructions to prevent loss of data before the computer enters rest mode or may stop the computer from entering rest mode. ATA and modem cards can enter rest mode.

Follow these guidelines when using PC Cards with CardWizard:

- Some LAN (local-area network) cards can be inserted while the computer is on but should be removed only when the system is turned off.
- SCSI cards should be inserted at startup to enable Windows NT to find the device attached to the SCSI card. SCSI cards can be removed when the computer is turned off. If you restart your computer without the SCSI card installed, a message may appear telling you that a service did not start. You can ignore this message.
- Modem and ATA cards can be inserted and removed while the computer is on.

**CAUTION:**

Before you remove a modem or ATA card from your computer, stop the card through the CardWizard program or you may lose data.

To stop and remove a PC Card from your computer:

1. In the **SystemSoft CardWizard** screen, click with the right mouse button on the name of the card you want to remove.
2. Click **Stop** in the **Actions** menu. A red stop sign appears on the main screen when the card is stopped. Click **OK**.
3. Push the card eject button on the side of the PC Card slot. Pull the card out of the slot compartment.
4. For more information on using the CardWizard program, see the CardWizard Help.

This page intentionally left blank.

Chapter 5 - Using Options

You can order the following options for your Notebook computer from your authorized reseller:

- An extra AC adapter.
- An auto adapter that enables you to charge the computer's battery and operate the computer in an automobile.
- An extra battery pack.
- 32, 64 and 128 MB SDRAM memory modules that enable you to upgrade your computer's memory to a maximum of 192 MB.
- A CD-ROM drive module.
- A DVD-ROM drive module.
- A Mini-PCI Software Modem module or a LAN/Modem combined module (Type 3A).
- A LS-120 Super Disk.
- A Port Replicator.
- A Secondary battery pack with internal charger.

The options that are available may change periodically. Contact micronpc.com for updated information on current and new options.

AC Adapter

The optional AC adapter operates in the same way as the adapter that came with your computer does. See "Using the Battery" on page 41 for information about the AC adapter.

Auto Adapter

The auto adapter enables you to power your computer and charge the computer battery in an automobile, through the +12 volt cigarette lighter socket.

To use the adapter:

1. Plug the adapter cable into the AC adapter connector on the computer.
2. Connect the adapter to the cigarette lighter socket.

The light on the adapter is green when the adapter is working properly. The light may be red for a few seconds when you first plug in the adapter or while you use the adapter. This is normal. If the light remains red, check to make sure the adapter is connected correctly.

If the adapter is plugged in and the adapter light does not turn on:

- Check the adapter connections.
- If you are in an automobile, turn on the automobile's ignition to supply power to the adapter. In some vehicles, power to the cigarette lighter socket is always on and you do not need to turn on the ignition.
- If the previous procedures do not activate the adapter, you may need to change the fuse in the adapter. To remove the fuse from the adapter, unscrew the adapter cap with a pair of pliers and remove the cap. Replace the fuse with an 8 amp fuse. In an automobile, you may need to replace the fuse in the cigarette lighter socket.

When you connect the adapter to the cigarette lighter, the battery starts charging immediately.



NOTE: *To prevent loss of data and possible damage to the computer, unplug the auto adapter when starting and stopping the automobile engine.*

Battery Pack

You can order a smart lithium-ion battery pack for your computer. See "Using the Battery" on page 41 for information on the battery.



NOTE: *When changing the battery, power the system down and replace the battery. If you try to replace the battery when the system is on, the system may become unresponsive.*

Memory Modules

You can increase system memory by installing optional memory modules. You can install 32, 64, or 128 MB modules.



CAUTION: *To avoid possible system problems, use only approved memory modules in your computer.*

Before You Install Memory



WARNING: *To prevent personal injury and damage to the equipment, follow the precautions listed here before installing a memory module.*

Take the following precautions when installing a memory module:

- Before you remove the memory module compartment door, turn off the computer, unplug the power cord, and remove the battery. Also, disconnect any peripheral devices.
- Before handling a memory module, discharge any static electricity by touching a grounded surface or using a grounding wrist strap.
- Do not insert objects with conductive material, such as metal screwdrivers or graphite pencils, into the memory-module compartment.
- Be careful in handling the metal plate of the memory door.

Installing a Memory Module



CAUTION: *Handle a memory module carefully. Hold them only by the edges.*

To install a memory module:

1. Turn the computer over so that the bottom faces up.
2. Using a screwdriver, remove the screw that holds the memory-module compartment door in place (Figure 22).

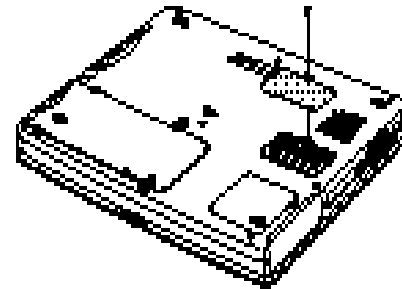

Figure 22. Removing the Memory Module Compartment Door

3. Grasp the edge of the door and pull the door off the chassis.
4. Remove installed modules if necessary.



CAUTION: *When removing modules, pull on the plastic portion of the connector slots tabs only. Do not pull on the metal part of the tabs, or you may damage the tabs.*

- a. Pull the tabs on the connector slot outward slightly, until the edge of the memory module pops up (Figure 23).



Figure 23. Removing a Memory Module

- b. Hold the memory module by the edges and pull it forward out of the compartment.
5. Align the connector on the memory module with the connector of the slot.
 6. Push the memory module into the slot at a slight angle until the connectors are fully engaged (Figure 24).
 7. Push down on the edge of the memory module until the module snaps into place.

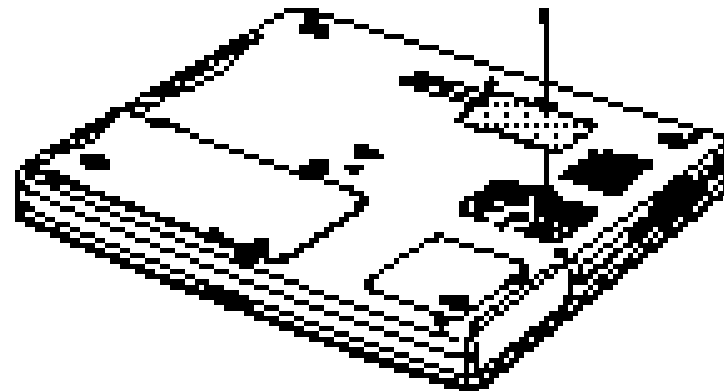

Figure 24. Installing a Memory Module

8. Align the memory module compartment door with the compartment and push the door down until it snaps into place.
9. Reinstall the screw you removed in step 2.
10. Turn the computer on and perform a complete POST to check the memory integrity.

CD-ROM Drive

If your system did not ship with a CD-ROM drive included, you can order a drive. See "Using the CD-ROM Drive" on page 37 for directions on installing the CD-ROM drive.

DVD-ROM Drive Module

If your system did not ship with a DVD-ROM drive included, you can order a drive. The DVD-ROM drive module can be inserted into your computer exactly as you would insert a CD-ROM. See "Using the CD-ROM Drive" on page 37 for directions on installing and using the CD-ROM drive. There is MPEG-2 software included with the drive that will enable you to play DVD movies from the DVD-ROM drive.

Secondary Battery

The secondary battery is available from micronpc.com.

The secondary battery has its own LED to show the battery charge remaining, and it can be directly connected to an AC adapter to charge.

Charging time:

- When the battery is connected to AC adapter directly: 3.2 ~ 3.8 hours.
- When the battery is installed in the Flex-bay: 4 ~ 5 hours.

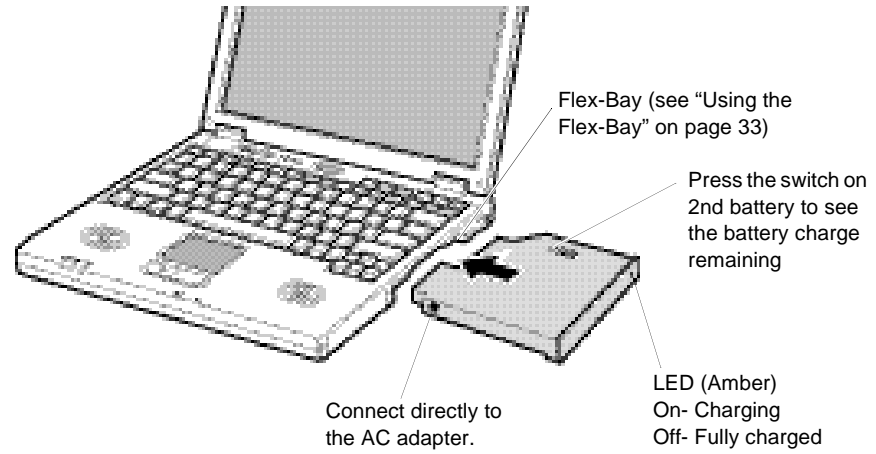

Figure 25. Secondary Battery

Port Replicator

Connecting the computer to peripheral devices on a regular basis has become quick and easy with the 100-pin Port Replicator.

Features of the Port Replicator

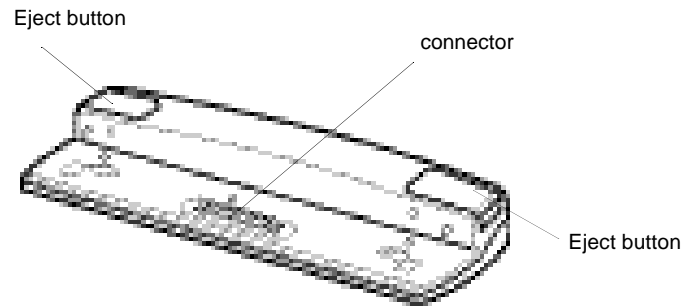

Figure 26. Front view of the port replicator

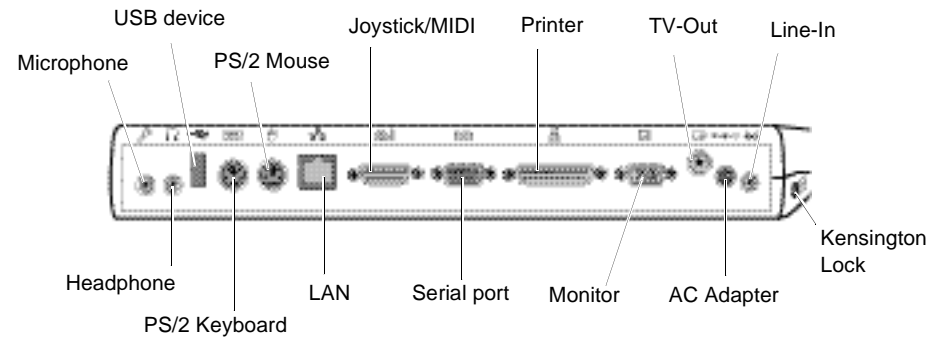

Figure 27. Back view of the port replicator

Installing a Port Replicator

1. Turn off your system and disconnect all the devices.
2. Adjust the connecting part of the system and the port replicator.

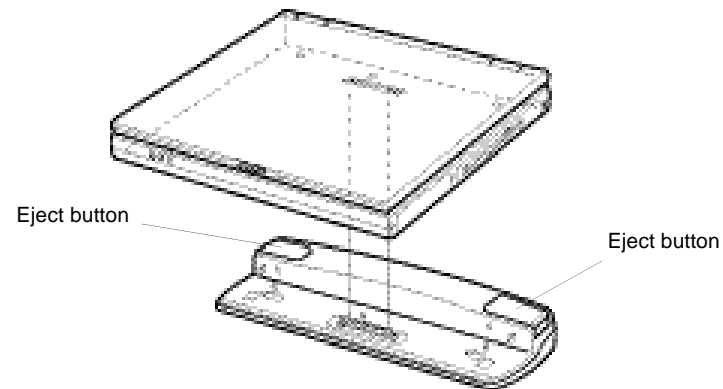

Figure 28. Connecting a Port Replicator

3. Push the system firmly to install a port replicator properly.
4. Connect an AC adapter to a power connector and cables from peripheral devices.



CAUTION: *The system power must be turned off before connection or disconnection of the port replicator from the system, or both devices could be damaged.*



CAUTION: *While the TV is ON, do not press [Fn+LCD/CRT] key. Pressing [Fn+LCD/CRT] key may cause malfunction on TV-Out.*

Removing a Port Replicator

1. Turn off the system.
2. Remove the AC adapter.
3. Push both eject buttons.
4. Remove the system.

Chapter 6 - Drivers and System Resources

This section provides basic information about drivers and system IRQs.

Drivers

A driver is a program that enables the Operating System to work with a hardware device. Your computer includes drivers for the audio, video, infrared, touchpad, keyboard, CD-ROM drive, hard drive, floppy drive, and PC Card controller. When you add a device to your computer, such as a printer, you install a driver for that device. Different drivers are used by different Operating Systems.

IRQs

Most of the devices in your computer are connected to your computer need their own IRQ (interrupt request line). The IRQ is a hardware line that a device can use to send signals to the microprocessor. When the device needs the microprocessor's service, the device sends an interrupt request signal to the microprocessor.

The number of IRQs available for any computer is limited by industry standards. Because it ships with numerous features, this computer uses most of the available IRQs. If you add another device to your computer, you may need to disable an existing device to free up an IRQ for the new device. IRQ resources are of particular concern when the computer is attached to a docking device.

The default IRQ settings that are used by your computer are listed in Table 7.

TABLE 7. IRQs

IRQ	Windows 98	Windows NT 4.0	Windows 2000
0	System timer	System timer	System timer
1	Keyboard	Keyboard	Keyboard
2	Internal Controller	Internal Controller	Internal Controller
3	IrDA Port	COM 2, COM 4	IrDA Port
4	COM 1, COM 3	COM 1, COM 3	COM 1, COM 3
5	Audio/USB	Audio/USB	Audio/USB
6	Floppy controller	Floppy controller	Floppy controller
7	LPT1 (parallel port)	LPT1 (parallel port)	LPT1 (parallel port)
8	CMOS/Clock	CMOS/Clock	CMOS/Clock
9	ACPI bus SCI IRQ	Reserved	ACPI bus SCI IRQ

IRQ	Windows 98	Windows NT 4.0	Windows 2000
10	Reserved	Reserved	Reserved
11	CardBus/Modem	CardBus/Modem	CardBus/Modem
12	Touchpad, PS/2 mouse	Touchpad, PS/2 mouse	Touchpad, PS/2 mouse
13	Numeric data processor	Numeric data processor	Numeric data processor
14	IDE 1 (hard drive)	IDE 1 (hard drive)	IDE 1 (hard drive)
15	IDE 2 (CD-ROM drive)	IDE 2 (CD-ROM drive)	IDE 2 (CD-ROM drive)

In Windows 98, you can configure a device so that the device is disabled when you connect your computer to a docking station but enabled when the computer is not connected to the docking station. With this configuration, an IRQ is available for a peripheral device that you connect to the docking station. See your Windows 98 manual for more information.

Service Pack 6A for Windows NT 4.0

Microsoft Service Pack 6A (SP6A) is included with computers shipped from the factory with Windows NT installed. Any time you change or add components to your Windows NT system, you need to reinstall SP6A.

The version of SP6A on your computer's hard drive includes the correct video driver for your system. If possible, always install this version on your computer.

To install SP6A:

1. Run the executable file. This file is located on your computer's hard drive at C:\SP6A\i386\update.
2. Follow the instructions on the screen with these exceptions:
 - a. When you are prompted to overwrite the uninstall directory, click the **Yes** button.
 - b. When a prompt identifies your pcmcia.sys file as an OEM-installed file and asks you to overwrite the version of the file on your system with the service pack version, click the **No** button.



WARNING:

If you install any service packs on your computer in the future, make sure that, when you are prompted, you do not overwrite the pcmcia.sys file, or you may be unable to use the PC card slot.

**Installing the LAN Driver in
Windows 98**

Refer to the MRestore CD that came with your Transport LT for LAN installation instructions specific to your Operating System.

This page intentionally left blank.

Chapter 7 - Using System Setup

The System Setup program enables you to configure your computer hardware and set security and power-savings options. The settings you choose are stored in the battery-maintained CMOS memory that saves the information even when the computer's power is turned off. When your computer is turned back on, it is configured with the values found in this memory.

Run System Setup if you get a message prompting you to run the program. You may also want to run System Setup, particularly the first time you use your computer, to set the time and date, use security or power-management features, or alter the settings of other features.



NOTE:

Your computer's version of System Setup may not include all the fields listed here or may include additional fields. Field names and order of appearance can vary according to the version of the BIOS (basic input/output system) on your computer.

Starting System Setup

To start System Setup, turn on your computer. When prompted press [F2]. The System Setup screen will appear.

The top of the System Setup screen has a menu bar with the selections listed in Table 8.

TABLE 8. System Setup Menus

Menu	Function
Main	Changes the basic system configuration.
Advanced	Configures advanced features on your computer.
Security	Enables security features, including passwords and backup and virus-check reminders.
Power	Configures power-management features.
Boot	Specifies the order of boot devices and configures boot features.
Exit	Specifies how to exit System Setup.

To open a menu, use the left or right arrow keys to select the menu name and press [Enter].

Table 9 lists the keys you can use to navigate through System Setup.

TABLE 9. System Setup Navigation Keys

Navigation Key	Alternate Key	Function
[F1]	[Alt+H]	Displays the General Help window.
[Esc]		Exits the current menu. Moves location up a level.
[Left Arrow] and [Right Arrow] keys	Keypad arrow keys	Select a different menu. Pressing [ESC] at the Main menu brings you to the Exit menu.
[Up Arrow] and [Down Arrow] keys	Keypad arrow keys	Move the cursor up and down between fields.
[Tab]		Moves the cursor forward through the cells for a highlighted field. This works only in System Time and System date.
[Tab+Shift]		Moves the cursor backward through the cells for a highlighted field. This works only in System Time and System date.
[Home]	[PgUp]	Moves the cursor to the field at the top of the window.
[End]	[PgDn]	Moves the cursor to the field at the bottom of the window.
[F5]	[-]	Scrolls backwards through the options for the highlighted field.
[F6]	[+] or [Space]	Scrolls forward through the options for the highlighted field.
[F9]		Loads factory installed Setup Default values.
[F10]		Saves current settings and exits setup.
[Enter]		Executes commands or opens a submenu.

A pointer symbol appearing to the left of a field indicates that you can open a submenu from this field. A submenu contains additional options for a field. To open a submenu, highlight the field and press [Enter]. Use the same keys to enter values and move from field to field within submenus as you use within menus.

When you highlight a field, information about the field appears on the right side of the screen. System Setup also provides a General Help screen that can be opened from any menu by pressing [F1] or [Alt+H]. The General Help screen lists the navigation keys with their corresponding alternates and functions.

When a scroll bar appears to the right of a help window, more information is available than can be displayed in the window. Use the [PgUp] and [PgDn] keys or the [Up Arrow] and [Down Arrow] keys to scroll through the entire help document. Press [Home] to display the first page, or press [End] to go to the last page. To exit the help window, press [Enter] or [Esc].

If your computer will not boot after you have changed settings in System Setup and exited the program, reboot and press [F2] to reenter System Setup. Once in System Setup, you can try to change the values that caused your computer boot to fail. If the problem persists, press [F9] to load the default values.

Main Menu

When you open System Setup, the Main menu appears. You can make changes to your computer's basic system configuration from this menu. The fields displayed in this menu are described below.

TABLE 10. Main Menu

Feature	Options	Description
System Time:	hh:mm:ss	Sets your computer to the time that you specify, usually the current time. Enter the hour, minute, and second in the format <i>hh:mm:ss</i> . Use a 24-hour clock. Use the [tab] key to move between the hour, minute, and second cells. Use the hyphen key [-] or [Space] bar to decrease or increase the numbers.
System Date:	mm:dd:yyyy	Sets your computer to the date that you specify, usually the current date. Enter the month, day, and year in the format <i>mm:dd:yyyy</i> . Use the [tab] key to move between the month, day, and year cells. Use the hyphen key [-] or [Space] bar to decrease or increase the numbers. This field supports year dates of 2000 and beyond.

TABLE 10. (Continued) Main Menu

Feature	Options	Description
Legacy Diskette A:	1.44 MB, 3 1/2 inch	Specifies a drive type for floppy drive A. <i>1.44 MB, 3 1/2 inch</i> (default) floppy disk can be used.
Primary Master and Secondary Master:	Primary Master Secondary Master	<p>Your computer can support two IDE drives. The Main menu contains two IDE adapter fields to configure these drives. <i>Primary Master</i> defines the hard drive installed in the computer. <i>Secondary Master</i> defines the CD-ROM and DVD-ROM drives or Removable drives.</p> <p>To configure a replacement or upgrade hard drive, move the cursor to select the <i>Primary Master</i> field in the System Setup Main menu, and then press the [Enter] key. The submenu appears.</p> <p>Normally, you can use the <i>Auto</i> option of the <i>Type</i> field in the submenu to automatically set the values for the other fields in the submenu. Manually set the other fields in this submenu only if the drive you have installed in your computer is not recognized by System Setup.</p>

**NOTE:**

Set the Auto option of the Type field in the Secondary Master submenu to enable the system to boot from Bootable CD-ROMS, you will also need to check the boot device priority field and Bootable CD check field.

After you make your selections from this submenu, press the [Esc] key to exit back to the Main menu.

**CAUTION:**

Before attempting to configure a hard drive, make sure you have the configuration information supplied by the manufacturer of the hard drive. Incorrect drive settings can cause your computer to malfunction.

The Primary and Secondary Master fields calls up a submenu. The following fields are found in the submenu:

TABLE 11. Primary and Secondary Master Fields Submenu

Feature	Option	Description
Type:	Auto User None	Configures the hard drive type. Normally, select Auto at this field to have your computer attempt to automatically detect the drive type and set the values for the remaining fields in this submenu manually, specify User . Manually enter the number of cylinders, heads, sectors per track, and write pre-compensation for your drive. Refer to your drive's user documentation or look on the drive to obtain this information. If no drive is installed or if you are removing a drive and not replacing it, select None .
Cylinders:		Configures the number of cylinders for the hard drive. Refer to your drive's user documentation or look on the drive to obtain this information. Before you can make changes to this field, the Type field must be set to User .
Heads:		Configures the number of read/write heads for the hard drive. Refer to your drive's user documentation or look on the drive to determine the correct value to enter for this field. Before you can make changes to this field, the Type field must be set to User .
Sectors:		Configures the number of sectors per track for the hard drive. Refer to your drive's user documentation or look on the drive to determine the correct value to enter for this field. Before you can make changes to this field, the Type field must be set to User .
Maximum Capacity:		Shows the maximum capacity of the drive. This field is for reference only.
Multi-Sector Transfers:	Disabled 2 Sectors 4 Sectors 8 Sectors 16 Sectors	Sets the number of sectors per block to the highest number supported by the drive.
LBA Mode Control:	Enabled Disabled	Enables or disables 28-bit addressing of the hard drive, without regard for cylinders, heads, and sectors. Enabling this field may decrease the access speed of the hard drive.

TABLE 11. (Continued) Primary and Secondary Master Fields Submenu

Feature	Option	Description
32 Bit I/O:	Enabled Disabled	Enables or disables 32-Bit I/O (input/output). When Enabled , your hard drive can work with applications with 32-bit input and output. If the field is Disabled (default), your computer works with 16-bit input and output and has lower performance.
Transfer Mode:	Standard Fast PIO 1 Fast PIO 2 Fast PIO 3 Fast PIO 4	Selects the method for transferring data between the hard drive and system memory. Refer to your drive's user documentation to specify the correct option for this field.
Smart Monitoring:	Enabled Disabled	Default setting is Enabled . Shows that the Smart Monitoring function is used. This field is for reference only.
Ultra DMA Mode:	Mode 0 Mode 1 Mode 2 Disabled	Enables the hard drive to use ultra DMA (direct memory access) transfer mode to transfer data between the drive and system memory.

TABLE 12. (continued) Main Menu

Feature	Option	Description
System Memory:		Displays the amount of conventional memory detected by your computer during startup. This field is for reference only.
Extended Memory:		Displays the amount of extended memory detected by your computer during startup. This field is for reference only.
BIOS Version / Micom Version:		Displays the BIOS version and Micom version.
CPU Type / CPU Speed:		Displays CPU type and speed.

Advanced Menu

Selecting **Advanced** from the menu bar displays the **Advanced** menu.

TABLE 13. Advanced Menu

Feature	Option	Description
Installed O/S:		Select the Operating System installed on your system which you will use most commonly. An incorrect setting can cause unexpected system behavior.
PS/2 Mouse Configuration:	Disabled Single Mouse Dual Mouse	Disabled prevents both the touchpad and external PS/2 port from functioning. Single mouse enables the external PS/2 port or the touchpad, and external PS/2 port has priority. Dual Mouse allows the use of both the touchpad and PS/2 port.
Screen Expansion:	Enabled Disabled	Enables or disables the Screen Expansion mode. If you set this field to Enabled , the system expands VGA mode (DOS mode or 640x480 Graphic mode) to use the full size of the LCD. If this field is Disabled VGA mode appears as a 640x480 box in the LCD.
TV Out Mode:	PAL NTSC	Select TV standard such as NTSC (default), PAL .
Display Configuration:	LCD CRT Both	Enables you to set the default display. Options are LCD , CRT and Both . Choose LCD to use the built-in display only, CRT to use an external monitor only, or BOTH to have both built-in and external displays used as the default. If you select CRT and no external monitor is attached you will not see a display until you attach the external monitor. The default is LCD .
I/O Device Configuration:	(Table 14)	Opens the I/O Device Configuration submenu if you press [Enter] when this field is highlighted. If you attempt to set two ports to the same settings, the fields will be marked with asterisks.
Local Bus IDE adapter:	Enabled Disabled	Enables the integrated IDE local bus adapters. Options are Enabled (default) and Disabled .
Large Disk Access Mode:	Dos Other	Enables your computer's Operating System to work with drives larger than 540 MB. Choose DOS (default) for Microsoft Operating Systems. Choose Other for any other Operating Systems.

The I/O Device Configuration submenu contains these fields:

TABLE 14. I/O Device Configuration Submenu

Feature	Option	Description
Serial port:	Enabled Disabled	Configures serial port. The options for this field are Enabled (default), and Disabled . If you set this field to Enabled , you can set the Base I/O Address field to 3F8 IRQ4 (default), 2F8 IRQ3 , 3E8 IRQ4 , or 2E8 IRQ3 . When the field is set to Enabled , the computer's Operating System uses the default configuration or the configuration you choose. If you select Disabled , you free up an IRQ for use by another device.
Infrared port:	Enabled Disabled	Configures the infrared port. The options for this field are Enabled , and Disabled (default). If you set this field to Enabled , you can set the Base I/O Address field and the Mode field. Settings for the Base I/O Address are 3F8 IRQ4 , 2F8 IRQ3 (default), 3E8 IRQ4 , or 2E8 IRQ3 . Mode FIR (fast infrared) enables you to set the DMA channel to 3 or 1. When the Infrared port field is set to Enabled , the computer's Operating System uses the default configuration or the configuration you choose. If you select Disabled , you free up an IRQ for use by another device.
Parallel port:	Enabled Disabled	Configures the parallel port. The options for this field are Enabled (default), and Disabled . If you set this field to Enabled , you can set the Mode field and the Base I/O Address field. Settings for the Base I/O Address are 378 IRQ7 (default), 378 IRQ5 , 278 IRQ7 , 278 IRO5 , 3RC IRQ7 , and 3RC IRQ5 . Settings for the Mode are Output only , Bi-directional , EPP (enhanced parallel port), and ECP (extended capabilities port). Selecting the ECP setting enables you to set the DMA Channel to 1, 2, or 3. When the Parallel port field is set to Enabled , the computer's Operating System uses the default configuration or the configuration you choose. If you select Disabled , you free up an IRQ for use by another device.
Floppy disk controller:	Enabled Disabled	Configures the floppy disk controller. The options for this field are Enabled (default), and Disabled . When the Floppy disk controller field is set to Enabled , the computer's Operating System uses the default configuration for the controller.

Security Menu

Selecting **Security** from the menu bar displays the **Security** menu. Your computer's advanced security system allows you to set two different passwords to prevent unauthorized access to system resources, data, and System Setup. From the **Security** menu, you can enable a boot password, disk access, a system backup reminder, and a virus check reminder.

Security fields marked with an asterisk (*) can only be changed if you start System Setup with a system supervisor password or if no passwords are in effect. You cannot access these fields with a user password.

TABLE 15. Security Menu

Feature	Option	Description
Supervisor Password Is and User Password Is:		Displays whether user or supervisor password is in use.
Set Supervisor Password:*		Enables you to set the supervisor password to control access to the System Setup utility. See "Creating a Password" on page 89 for instructions on setting a password.
Set User Password:		Enables you to set a user password to control access to the system at boot. See "Creating a Password" on page 89 for instructions on setting a password. The user password allows restricted access to the System Setup Security menu; the user has access only to changing his own password and to enable or disable Password on boot . A supervisor password must be set before a user password can be set
Diskette access:*	Supervisor User	Enables you to restrict the use of floppy drives. When set to Supervisor (default), the use of floppy drives is restricted to a user with the supervisor password. A supervisor password must be enabled before the Supervisor option can take effect. When set to User , users with either type of password have access to floppy drives. If the field is set to Supervisor and a user password is enabled, the user must enter the supervisor password in order to boot from the floppy drive.

TABLE 15. (Continued) Security Menu

Feature	Option	Description
Fixed disk boot sector:*	Normal Write Protect	Enables you to write-protect the hard drive boot sector to protect against viruses and alterations. Only a user with the supervisor password can access this field.
Password on boot: *	Enabled Disabled	Determines whether the computer prompts for a password when starting up. The options are Enabled and Disabled . A supervisor password must be set before you can enable this option. And the option should be enabled to use [Fn+Keylock] function during the operation.

Power Menu

The **Power** menu of System Setup allows you to enable and adjust your computer's sophisticated power-saving features. Enabling these features extends the life of the battery.



WARNING:

If your computer shipped with Windows 98 or Windows 2000 installed, the Power Management works with the settings in the Power Management option of Control Panel. But if your computer has Windows NT 4.0, the Power Management works with the settings in System Setup.

TABLE 16. Power Menu

Feature	Option	Description
Power Savings Mode:	Maximum Performance Maximum Power Saving	Enables and disables Maximum Performance mode. The options are <i>Maximum Performance</i> , <i>Maximum Power Saving</i> (default), Customized and Disabled . If you set this field to Maximum Performance , the microprocessor and hard drive run at full speed, unless affected by other power-savings settings. If you set this field to Maximum Power Saving , the microprocessor and the hard drive run at slow speed when there is no user input or device activity. Choose Customized to alter these settings and Disabled to turn off the Power management function.
Standby Timeout:	Off (Delay time of 1 to 16 minutes)	Sets the period of computer inactivity (no user input or device activity) that must pass before your computer automatically goes into standby mode. In standby mode some devices are turned off (including the LCD screen) and the microprocessor slows down. You can disable this option by selecting Off , or you can specify a Standby Timeout delay time of 1 to 16 minutes.
Auto Suspend Time out:		Sets the period of computer inactivity from standby that must pass before your computer automatically goes into rest mode. When the rest timeout expired, your computer goes to the rest mode according to Suspend Mode.

TABLE 16. (Continued) Power Menu

Feature	Option	Description
Suspend Mode:	Save To RAM Save To Disk	Specifies the type of rest mode your computer enters: <ul style="list-style-type: none"> • Save to RAM: Saves power by turning off the microprocessor and all devices except system memory and controller, and video memory and controller. • Save To Disk: Provides the greatest power-saving capabilities by essentially turning off your computer. In the save to disk mode, all system logic (except for your computer wakeup circuitry and battery charger) is turned off. During save to disk mode, the system and video memory are saved to the hard drive and are restored when your computer resumes from rest. • When the computer enters save to disk mode, it will not resume normal operation at a specified time no matter how the Resume On Time field is set.
Hard Disk Timeout:		Sets the amount of time the hard disk needs to be inactive before it is turned off.
Resume On Modem Ring:		Enables the computer to resume operation from rest mode in the event of modem communication. The computer will resume only if the Suspend Mode field is set to Save to RAM , not Save To Disk . The default setting is Off . To enable this feature, AC adapter should be plugged into the computer.
Resume On Time:		Enables the computer to resume operation from rest mode at a scheduled time. The computer will resume only if the Suspend Mode field is set to Save to RAM , not Save To Disk . If you set this field to On , you must set the Resume Time field as well. The default setting is Off . AC adapter should be plugged in to work this feature.

TABLE 16. (Continued) Power Menu

Feature	Option	Description
Resume Time:	hh:mm:ss	Specifies the time for your computer to automatically resume from rest mode. Enter two-digit numbers to indicate the hour, minutes, and seconds in the format <i>hh:mm:ss</i> . Use a 24-hour clock. Use the tab key to move between the hour, minute, and second cells. Use the hyphen key [-] or [Space] bar to decrease or increase the numbers. You must set this option if you enable Resume On Time .
Speedstep Mode:		Selects the mode of Intel Speedstep support to install in the user BIOS at runtime. If your CPU does not support Intel Speedstep, this field should be set to Disabled .

Boot Menu

The Boot menu enables you to select a boot device and set boot options.

TABLE 17. Boot Menu

Feature	Option	Description
Screen Logo Display:	Enabled Disabled	Enables or Disables the display of the boot time logo. If you select Disabled , the diagnostic POST screen is displayed during boot.
Summary screen:	Enabled Disabled	Displays the system configuration when the computer starts. The options are Enabled and Disabled (default).
Boot Device Priority:	Default: 1.Diskette Drive, 2.Removable Devices, 3.Hard Drive, 4.DVD/CD-ROM	Enables you to select the order in which the computer attempts to boot from different devices. The field has three options: Diskette Drive , Removable Devices , Hard Drive , and DVD-CD ROM . To choose a device as the first, second, or third boot device: <ol style="list-style-type: none"> 1. Press [Enter] at the Boot Device Priority field. 2. Press [Enter] at the plus(+) symbol to display sub menu. 3. Highlight the option with the [Up Arrow] or [Down Arrow] key. 4. Press the [Space] bar until the option moves up or down in the list of options 5. Press [Esc] to return to the Boot menu.



NOTE: *If you want to start the system using a bootable CD, change the ATAPI CD-ROM Drive to be the first priority and make sure the Auto is set in the Type field of the Secondary Master Submenu at Main page, and also make sure that Enabled is set in the Bootable CD check field at Boot page.*

Exit Menu

Select **Exit** or press [Esc] from the menu bar to display the **Exit** menu.



NOTE: *Pressing [Esc] does not exit this menu. You must select one of the options from this menu or a menu bar item to exit this menu.*

TABLE 18. Exit Menu

Feature	Option	Description
Exit Saving Changes:	Yes No	Enables you to exit System Setup and saves your changes. When you select this item and press [Enter], a message appears asking you if you want to save your changes and exit System Setup. Choose Yes and press [Enter] to save your changes and exit. Choose No and press [Enter] to remain in System Setup.
Exit Discarding Changes:	Yes No	Enables you to exit System Setup without saving your changes. When you select this item and press [Enter] a message appears asking you if you want to save changes before exiting. Choose No and press [Enter] to exit without saving changes. Choose Yes and press [Enter] to save changes and exit.
Load Setup Defaults:	Yes No	Loads the default values for all System Setup parameters. When you select this option and press [Enter], a message appears asking if you want to load the default configuration. Choose Yes and press [Enter] to load default settings and remain in System Setup. Choose No and press [Enter] to retain your changes and remain in System Setup.
Smart Battery Calibration:		Enables you to discharge the system battery completely for a more accurate battery level detection. This option only works with the smart battery if the AC Adapter is not plugged in.

Chapter 8 - Using System Security

This section describes the security options provided with your computer.

System Passwords

The computer provides two levels of password security: administrative-level (supervisor) and user-level (user). Either password prevents unauthorized access to the computer. The supervisor password enables full access to all System Setup fields. The user password enables full access to only the **Set User Password** and **Password on boot** security fields and read access to all other System Setup fields. (See "Security Menu" on page 83 for a complete list of System Setup security fields.)

If multiple users have access to the computer (such as in a network environment), a supervisor password can prevent unauthorized access to certain security options.

Choose the type of password security that is appropriate for your work. If you want to set a user password, you must set a supervisor password first.

Creating a Password

To create a password:

1. At startup, press [F2] to open **System Setup**.
2. Use the [Right Arrow] key to select the **Security** menu.
3. Use the [Down Arrow] key to select **Set Supervisor Password** or **Set User Password**. Press [Enter]. The **Set Password** dialog box will appear.
4. Type a password of up to seven characters. You can enter letters or numbers, but you cannot use the function keys, such as [Shift]. Your computer does not distinguish between capitalized and lowercase letters in your password. As you type the password, the cursor moves but your password does not appear on the screen.
5. Press [Enter] after you have typed your password. The computer prompts you to reenter your password for verification.
6. Type your password again and press [Enter]. A message appears telling you that the changes have been saved. Press [Enter] again to return to the **Security** menu.
7. Press [Esc] to go to the **Exit** menu.
8. Select **Exit Saving Changes**, press [Enter], and press [Enter] again to restart the computer.

Deleting a Password

To delete the password:

1. At startup, press [F2] to open **System Setup**.
2. When prompted type your password and press [Enter].
3. Use the [Right Arrow] key to select the **Security** menu.
4. Use the [Down Arrow] key to select **Set Supervisor Password** or **Set User Password**.
5. Press [Enter]. The computer prompts you to enter the current password.
6. Press [Enter]. The computer prompts you to enter a password. Do not type anything.
7. Press [Enter]. The computer prompts you to reenter the password. Do not type anything.
8. Press [Enter]. A message appears telling you that the changes have been saved. Press [Enter] again to return to the **Security** menu.
9. Press [Esc] to go to the **Exit** menu.
10. Select **Exit Saving Changes**, press [Enter], and press [Enter] again to restart the computer.

Requiring a Boot Password

After you create a supervisor or user password, you can enable the computer to prompt for a password each time it starts.

To enable the prompt, select the option **Enabled** in the **Password on boot** field in System Setup. For more information about the **Password on boot** field, see "Security Menu" on page 83.

Locking the Hard Drive Boot Sector

If you have a supervisor password, you can lock the hard drive boot sector to protect against viruses or alterations.

To lock the hard drive boot sector, select the option **Write protect** in the **Fixed disk boot sector** field in System Setup. For more information about the **Fixed disk boot sector** field, see "Security Menu" on page 83.

Locking the Floppy Drive

If you have a supervisor password, you can lock the floppy drive so that a user with only a user password cannot load personal software, which may introduce a virus into the computer.

To enable the floppy lock, select the option **Supervisor** in the *Lock Floppy* field in System Setup. For more information about the **Lock Floppy** field, see "Security Menu" on page 83.

Locking the Keyboard

The keyboard lock enables you to protect your system when you walk away from it for a time. To use the keyboard lock, you must first enable a password through System Setup. (See "Creating a Password" on page 89 for instructions. To lock your keyboard, press [Fn+F7]. To unlock your keyboard, type your password and press [Enter].

This page intentionally left blank.

Chapter 9 - Using Power Management Options

Your computer includes power-management options that can help the battery charge last longer and extend the life of the battery, LCD panel, and other components. Power-management options slow down or shut off system components when the components are not being used.

Power management may slow down system performance. Your computer runs fastest with the power cord attached, and when power management is disabled.

In Windows 98 and Windows 2000 Power management works according to the settings in the Power Management option on the Control Panel with the exception of rest mode.

If your computer shipped from the factory with Windows NT installed, PowerProfiler software was included to support power management.

Maximum Power Saving Mode

For maximum power saving mode, the microprocessor may run at slow speed to conserve power. To enable this mode, set the **Idle Mode** field in **System Setup** to **Enabled**.

Standby Mode

The **Standby Timeout** field in **System Setup** enables you to specify the time period that the computer can remain idle (no user input or disk activity) before the computer enters standby mode. You can disable this option by selecting **Off**, or you can specify a **Standby Timeout** delay time of 1 to 16 minutes.

In standby mode, the system and video memory and the video controller slow down. The LCD backlight, hard drive, floppy drive, PC Card controller, and some other devices turn off to save energy. DPMS (display power-management signaling), a form of monitor power management, to an external monitor is invoked.

To resume from standby, press the Power button or touch the touchpad. Do not press any keys on your keyboard. Windows 98 does not have a standby mode.

**NOTE:**

In Windows 98 and Windows 2000, the standby mode works the same as rest mode in system setup. Windows 98/2000 has a standby mode that operates separately from the standby mode in system setup.

If you enable both standby and rest modes, your computer enters standby when the delay time you chose for standby has elapsed, and then enters rest mode when the delay time you chose for rest mode has elapsed.

Suspend Mode

The **Auto Suspend Timeout** field in System Setup enables you to specify the time period the computer can remain idle (no user input or device activity) before the computer enters **Suspend** mode. You can disable this option by selecting **Off**, or you can specify an **Auto Suspend Timeout** delay time from 5 to 60 minutes.

The **Suspend Mode** field in **System Setup** defines what type of rest mode your computer enters:

- **Save to RAM:** This mode saves power by turning off the microprocessor and DMA clocks, video, and all controllable peripheral devices. The computer still uses some power while in this mode. If you leave your computer in **Save to RAM** for several days without the power cord attached, the computer's battery will discharge.
- **Save To Disk:** This mode provides the greatest power-saving capabilities by essentially turning off your computer. In this mode, all system logic (except for your computer wakeup circuitry and battery charger) is turned off. During save to disk mode, the DRAM and video memory are saved to the hard drive and are restored when your computer resumes operation.

You can press [Fn+F4] to manually place your computer into Suspend mode.



NOTE: *When you use the [Fn+F4] key combination, your computer may postpone entering Suspend mode during a critical operation, such as reading from or writing to the hard drive.*

To resume to full-power mode, press the power button.

Once all devices return to full-power mode, all active software applications and system states are restored to exactly how they were before your computer entered rest mode.

When your computer enters or resumes from save to disk mode, screens appear indicating system status. These status screens do not appear when the computer enters or resumes from power on Suspend Mode.

Suspend Mode Precautions

Observe the following precautions when using Suspend mode:

- Save all open files before you press [Fn+F4] to manually place your computer into Suspend mode.
- If you purchased a new hard drive, make sure that you create a save to disk partition equal to the amount of system memory plus the amount of video memory plus 2 MB, before you enable save to disk mode. See "Creating a Save-To-Disk Partition" on page 97 for more information.
- Do not try to resume to full-power mode using battery power if the battery charge is low. If the battery charge is too low, the system may not be able to resume fully. Plug in the power cord if your computer cannot resume normal operation because of a low battery charge.

**CAUTION:**

When your computer is in Save to RAM or Save to Disk mode, do not connect or remove any devices (including PC Cards or memory modules) because you may damage the computer or Resume To Full Power may fail. If a floppy disk is in the floppy drive, do not remove it or switch it with another disk. However, you can plug in the AC adapter if the Resume To Full Power fails because of a low battery charge. When the computer is in Save To Disk mode, you can remove and replace the battery.

Using PowerProfiler

PowerProfiler enables you to set power-management options for computers shipped with Windows NT installed. To open the PowerProfiler window, double-click the battery icon on the right corner of the Windows task bar or click on the PowerProfiler icon in the Program bar. If you click the icon with the right mouse button, a menu appears with an option to put the computer in Suspend mode.

Click the **Standard** tab in PowerProfiler to set timeouts for the LCD and the hard drive. You can also set power management to be enabled: **Always**, **Battery Only**, or **Never**. The **Advanced** screen in PowerProfiler enables resume from rest options, and the Battery screen enables options to conserve battery life.

Keep the following in mind when using PowerProfiler:

- If you disable power management in PowerProfiler, the setting overrides any power-management settings in System Setup.
- If you enable LCD and hard drive timeouts in PowerProfiler and the standby timeout in System Setup, the LCD and hard drive turn off when the shortest timeout period in either program passes.

- If you disable the **Resume on Time** field in System Setup, the same field in PowerProfiler is also automatically disabled. An easy way to work with these two fields is to set the resume time to 0 in System Setup and set the actual resume time that you desire in PowerProfiler.



NOTE:

PowerProfiler maintains the accuracy of the system clock when the computer resumes from rest mode. If PowerProfiler is closed or removed from your hard drive, your system clock may not be accurate when your computer resumes from rest mode.

For more information on PowerProfiler, see the Help option in the PowerProfiler software.

Chapter 10 - Creating a Save-To-Disk Partition

The hard drive shipped in your computer has a save-to-disk partition in which data from system and video memory is stored during save-to-disk mode. The partition is the maximum size needed for your computer and supports system memory of 256 MB. You can add memory modules to your computer without changing the size of the partition.



NOTE: *You do not need a Save-to-disk partition if you are running Windows 2000. Windows 2000 handles Save-to-disk as hibernation. See the Windows 2000 manual for more information.*

If you add a new hard drive to your computer, you need to create a save-to-disk partition on the new hard drive.



NOTE: *If you do not intend to use save-to-disk mode, you do not need to create a save-to-disk partition.*

You can use the Phoenix PHDISK utility, provided on the MRestore CD-ROM disk to create the save-to-disk partition.

If you want to put programs or files from your current hard drive onto the new hard drive, back up data files on your old hard drive before creating a save-to-disk partition on the new drive.



NOTE: *If you do not intend to use the save-to-disk mode, you can delete the save-to-disk partition on a hard drive using PHDISK /delete. Then you can repartition and reformat the save-to-disk partition for some other application. Back up your hard drive before deleting the partition if you feel unsure about how to do this.*

Before you use PHDISK to create a save-to-disk partition, do the following:

- Under the Boot menu in System Setup, set *Diskette Drive* as the first boot device (see “Using System Setup” on page 75 for information on setting options).
- Create a PHDISK disk.

To create a suspend partition:

1. Turn off the computer, remove your old hard drive, and insert the new one into your computer. (See "Using the Hard Drive" on page 39 for instructions.)
2. Insert the PHDISK disk into the floppy drive and start your computer.
3. At the A: prompt, type `phdisk /create 206784 /partition` and press [Enter]. PHDISK automatically creates a save-to-disk partition of the maximum size for your computer. When the save-to-disk partition has been created, the message "Save-to-disk partition created successfully" appears.
4. Remove the PHDISK floppy disk from the floppy drive.
5. Install your computer's Operating System and your original applications and drivers.
6. Reinstall any program and data files that you backed up.

Chapter 11 - Software Utilities

MRestore CD-ROM

Included with your notebook computer is a CD-ROM titled MRestore. This CD is only functional on Micron systems with an approved Micron BIOS.

Included on this CD-ROM are the following:

- The MCRC (Micron Customer Resource Center)
- Drivers (with instructions)
- A bootable option to access basic DOS functions, such as disk, format, etc.
- Drive Image / PartitionMagic / Drive Copy by PowerQuest
- Drive Image manual/user's guide (more comprehensive than space allows within this guide). These may or may not reflect the actual package that you have; other applications may or may not be referenced.

MCRC (Micron Customer Resource Center)

Use this CD to install drivers one at a time. It is a program that can only be used from within Windows. This CD is needed to load any drivers that are not shipped installed on the notebook as a default (such as DVD).

To use the MCRC, boot your system to its current operation system (such as Windows 95/98), insert the MCRC CD and follow all instructions.



NOTE:

All drivers are pre-installed and tested by Micron. You will not have to run this CD unless you are experiencing problems with your system or if you have recently reinstalled the operation system.

PartitionMagic

Partition magic software is provided so you will have a method of storing an image if no other means of storage are available. PartitionMagic can only be run from DOS level. The object of this software is to create partitions and move them to an appropriate size for your needs. It also converts them with different FAT tables. This software becomes very useful when there is no location for your storage. This is a brief overview of what is contained in the PDF located in the:\pqtools\userinfo directory on the CD.

Drive Image 3.0

Drive Image is for PC users who want a fast, complete solution for system backups and recovery. With Drive Image you can easily create and store a

compressible image of the entire hard drive or individual partition on a Jaz, Zip, secondary hard drive, or other removable media device. The image can then be restored from the source and used for complete Operating System application and data recovery.

**NOTE:**

Currently, Drive Image does not support creating image files directly on CD-ROM or tape drives. You must first save image files to a supported source (hard drive, Zip drive, etc.), then copy them to CD-ROM or tape. Drive Image can, however, directly restore image files from CD-ROM.

Furthermore, image files can only be saved to devices that have a valid drive letter. While Drive Image includes some device drivers (such as Zip), the user is primarily responsible for loading the necessary drivers for their data storage devices so that DOS can correctly assign drive letters (such as USB Zip or 2 GB JAZ).

Drive Image also includes other useful features such as the ability to resize partitions, disk to disk copying for upgrading to a larger hard drive, and file systems error and bad sector checking to prevent copying problems.

Drive Image supports the file systems of all versions of Windows 95/98, Windows NT, Windows 3.x, DOS. And OS/2 including FAT32, FAT32X, NTFS, and HPFS partition types. Because Drive Image understands the internal structure of these file systems, partition resizing and fast SmartSector copying can occur.

Drive Image provides limited support for NetWare, Linux, UNIX and other partition types. However, Drive Image copies such partitions sector by sector—and does not resize them on the destination drive—making the image file creation and restoration process for these file systems more time consuming. Additionally, internal disk location references are not modified on the destination drive. This may make these partitions unbootable or otherwise inaccessible.

Drive Image is a DOS-based program that can be run from the hard drive in DOS or MS-DOS mode or from a CD after booting DOS. Because multi-tasking Operating Systems like Windows 95/98 and Windows NT operate with open files on the hard drive, it is necessary to run Drive Image from DOS so that image files are an exact copy of your hard drive. By running DOS, the hard drive is completely inactive with no open files.

Drive Image Professional

If you want the absolute fastest way to clone workstations, a Drive Image Professional version is available for use on multiple PCs. For more information or for upgrades contact PowerQuest sales at 801-226-8977 or visit their web site at <http://www.powerquest.com>.



NOTE: *The complete manual for Drive Image is available on the MRestore CD, in the PQtools\userinfo folder.*

Drive Image System Requirements

TABLE 19. Drive Image System Requirements

Hardware/Software	Minimum	Recommended
Processor	Intel 386SX	Intel 486 above
RAM	8 MB (16MB required for FAT 32 or NTFS)	32 MB (48 MB for FAT 32 partitions larger than 6 GB)
3.5 inch diskette drive	None	None
CD-ROM	Any speed	Any speed
Hard drive free space	5 MB	5 MB
Operating System	Windows 3.x, 95/98, NT, DOS 5.0, OS/2*	Windows 3.x, 95/98, NT, DOS 5.0, OS/2*
Monitor	VGA	SVGA
Pointing Device	No pointing device is required to operate Drive Image	Microsoft mouse (or compatible pointing device)

* For Windows NT and OS/2 users, Drive Image must be run from a bootable floppy or CD.

Creating Image Files

If you create an image on one machine and you wish to restore the image on a machine with a different configuration (for example, a different motherboard or video card), the Operating System may not boot correctly. Therefore, we recommend imaging and restoring to identical hardware configurations.

Any discussion of hard-disk imaging assumes that the software, including the Operating System, is being copied in accordance with the license agreement with the software manufacturer.

1. Disable virus protection in the BIOS before creating an image file. If virus protection is enabled, Drive Image will hang after you click **Finish**.

2. Before running Drive Image, use a disk utility program such as ScanDisk or Norton's Disk Doctor to identify and repair any errors on your hard drive. NT users should run CHKDSK /F.
3. You may also choose to run a disk defragmenting utility to further optimize your hard drive.
4. At the **Drive Image** main screen, click **Create Image**.



5. If you have more than one hard drive, select the drive that contains the partitions you wish to include in the image file. A check appears to the left of the selected drive.



6. Click **Next**. At any point prior to actual image file creation, you can click **Back** to return to the previous step and change your settings.
7. Select the source drive partition you wish to include in the image file, or click **Select All** to automatically select all partitions. A check appears to the left of the selected partitions.

**NOTE:**

For best results in creating your image, you should include the Save-To-Disk partition as well as the other partitions you wish to back up. Save-To-Disk is necessary for Power Management features.

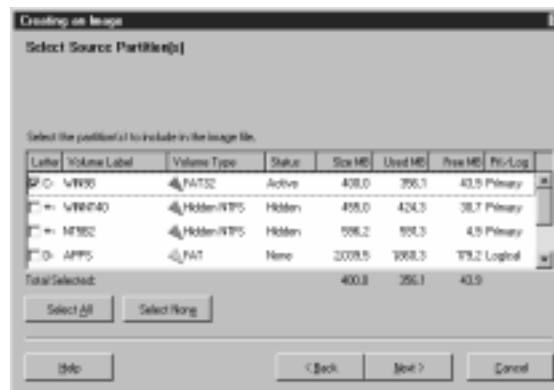

To deselect partitions, click again on a partition or click **Select None** to deselect all partitions at once. The **Total Selected** field displays the disk space for all selected partitions, as well as the total used and free space within the partitions.

8. Click **Next**. Type the desired path and image filename in the **Image File** field, for example: **D:\MYIMAGE.PQI**. Make sure there is no existing file with the same name, unless you want the existing file to be overwritten.
9. You must save your image file to a partition, or other location that you are not including in your image file. Drive Image uses .PQI as the default image filename extension. You can also click **Browse** to browse the directory tree for your desired path or filename. You can save your image file to any physical or logical drive which has a drive letter. That includes floppy drives, secondary

hard drives, network drives, and removable media storage devices such as Jaz, Zip, MO, and SyQuest drives. Network drives must be visible as a drive letter.

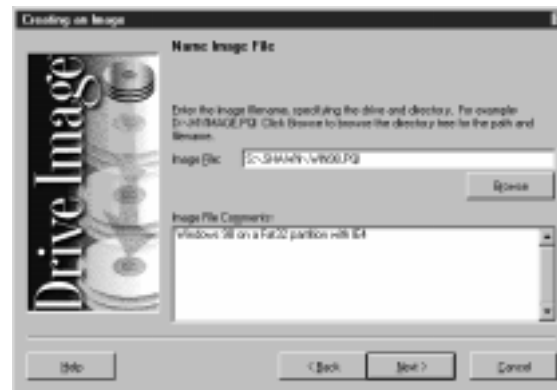

10.(Optional) Type brief comments about your image file in the **Image File Comments** field. Comments cannot exceed 300 characters.

11. Click **Next**. Select the desired compression level.

- **No Compression** is usually the fastest method for creating an image file and is useful if storage space is not an issue. However, if you are saving your image file to a busy network drive or to a relatively slow removable media device, high compression may be faster than no compression since there is less data to write to the file. Drive Image selects **No Compression** by default.
- **Low** compression offers a 40% average compression ratio.
- **High** compression offers a 50% average compression ratio.

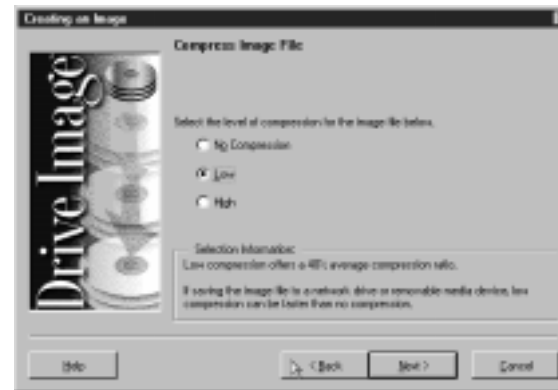

In general, compressed image files created with new versions of Drive Image are not compatible with earlier versions.

12. Click **Next**. Drive Image displays all the information you have entered to this point:

- Source Drive
- Source Partitions (partitions to be included in the image file are marked with an "X")
- Image Filename
- Compression Level



13. To modify any settings, click **Back**.

14. Click **Advanced Options** to set such options as disabling file system error-checking or password-protecting your image file.
15. Click **Finish** to begin creating the image file. If you entered a name of a current file, Drive Image displays a message that *<path and filename>* already exists. You can replace the existing file or choose a new filename. If Drive Image detects that you are saving your image file to removable media, it enables a media-spanning feature that spreads the image file over a series of disks. You must have at least 100K of available space on each disk in the series. If you use the media-spanning feature, be sure to number the media in order, since you must insert them in sequence when restoring the image file. The **Creating the Image** screen appears.

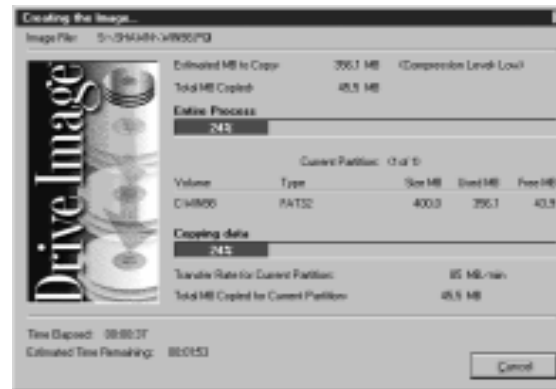

Upon completion, the following message appears: "Image was copied successfully to file: *<image filename>*".

16. Click **OK** to return to the **Drive Image** main screen.

Advanced Options

The **Create Image Advanced Options** dialog box appears when you click **Advanced Options** at the **Ready To Create Image File** screen.

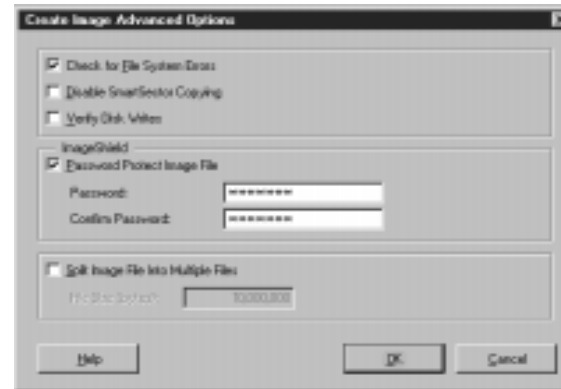

Clear the **Check for File System Errors** check box if you want to disable file system error checking.

If you have already used a disk utility program such as ScanDisk to check your hard drive for errors, it is not necessary to have Drive Image check for file system errors. Clearing the box **Check for File System Errors** saves time when creating the image file.

If you did not run a disk check utility program before loading Drive Image, leave the **Check for File System Errors** check box selected.

Disable SmartSector Copying

Drive Image's SmartSector technology speeds up the imaging process by only copying clusters and sectors which contain data. However, in some cases, such as high-security environments, it may be desirable to copy all clusters and sectors in their original layout, whether or not they contain data.

To copy both used and unused clusters and sectors, click **Disable SmartSector Copying**. Disabling SmartSector copying increases processing time and the size of the generated .PQI file.

Verify Disk Writes

Click **Verify Disk Writes** if you want to enable DOS disk write verification.

Disk write verification is not critical to safely create image files. Enabling disk write verification can slow the image file creation by as much as seven times.

ImageShield

To password-protect your image file, click **Password Protect Image File** and type a password in the **Password** field.

**NOTE:**

Record image file passwords and store them in a safe place. If you forget an image file's password, you cannot restore the file.

Split Image File Into Multiple Files

Sometimes it is useful to force Drive Image to split a large image file into smaller files. To do so, click **Split Image File Into Multiple Files** and enter the maximum byte size for each file in the **File Size** (bytes) field. If you wish to save the files to CDs, specify a file size of 650,000,000 bytes (650 MB) or less.

Restoring Image Files

- If you are restoring an image file to set up a new hard drive on a machine with a BIOS older than 1994, see "Using Drive Image with Drive Overlay Software" in the Drive Image manual on the MRestore CD, located at **PQtools\userinfo**.
- To restore selected files from a compressed or spanned image file, see "Restoring Files from Spanned or Compressed Images" in the Drive Image manual included on the MRestore CD.

To restore an image file to a different drive or partition:

1. Ensure that virus protection is disabled in the BIOS. If virus protection is enabled, Drive Image will hang when you click **Finish** at this end of this procedure.
2. Start Drive Image, then click **Restore Image**.

- In the **Image File** field, enter the path and filename of the image file you want to restore, or click **Browse** to select the path and image file.

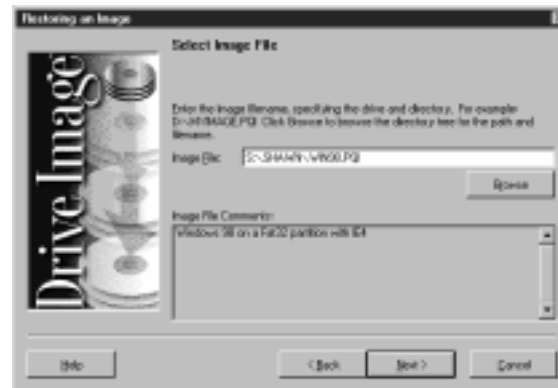

- Click **Next**. At any point prior to actual image file restore, you can click **Back** to return to the previous step and change your settings.
- If you have more than one partition, you can select the partitions you want to restore. Select the image file partitions, or click **Select All**. A check appears to the left of the selected partitions.

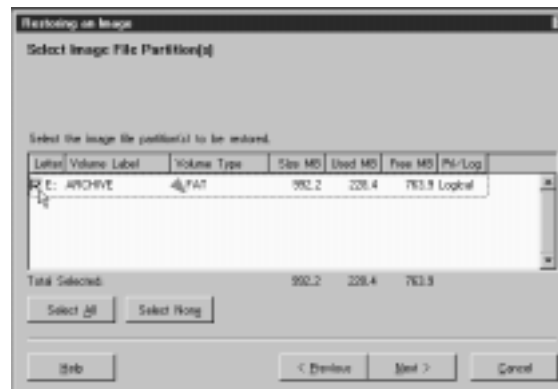

- To deselect partitions, click again on a partition or click **Select None**. The **Total Selected** field keeps a running total of the disk space for all selected partitions, including total used and free space.

7. Click **Next**. If you have more than one hard drive, select the drive where you want to restore the image file.

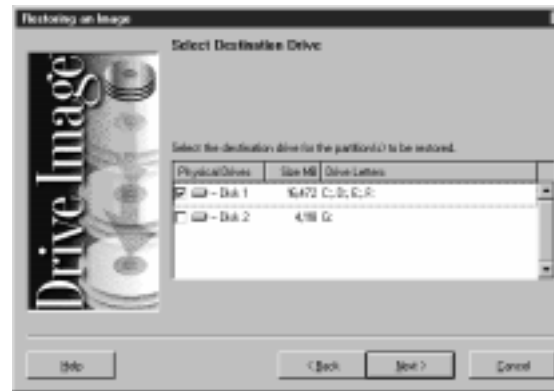

8. Click **Next**.
9. Select an existing partition or free space (non-partitioned disk space).

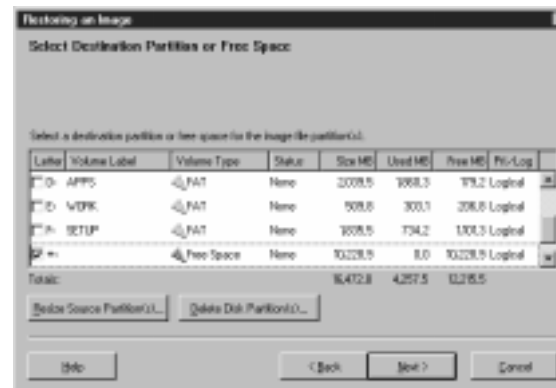

10. If the destination partition or free space is not large enough to accommodate the partitions you wish to restore, or if you are restoring the image file to a larger drive and want to set a specific size for partitions rather than use the proportional resize option, you may want to resize the partitions. If this does not apply to you, go to Step 17 on page 112.

11. Click **Resize Source Partitions**. The **Resize Partitions** window displays.



The **Selected Source Partitions** group box displays the partitions you selected to restore. The **Totals** field displays the disk space for the source partitions. A formula box below the **Totals** field displays:

- Destination Size
- Current Size of Selected Partition
- Remaining Space in Destination

12. Click **Resize**. The **Resize Partition** window appears. The **Maximum Size** field displays the largest possible size the source partitions can have and still fit in the destination space. The **Minimum Size** field shows the smallest possible size the source partitions can occupy.

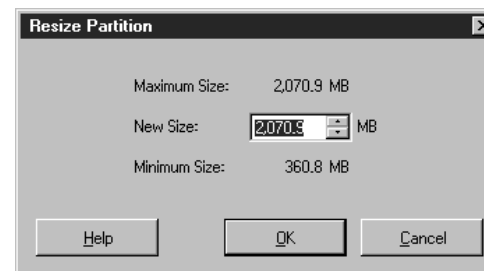

13. In the **New Size** field, enter a number that is less than the **Maximum Size** and greater than or equal to the **Minimum Size**.

14. Click **OK**. Since partitions must end on a cylinder boundary, Drive Image rounds the New Size up to the next cylinder boundary.
15. Click **Accept**. Later, when you restore the image file, Drive Image resizes the partition.
16. Click **Next**. If you selected an existing partition as the destination, the following message appears.

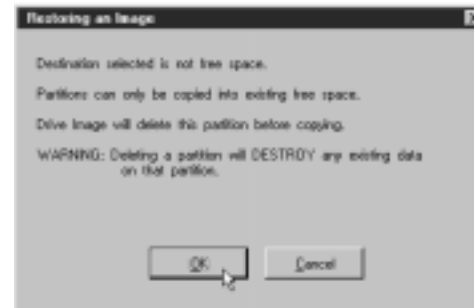

Drive Image does not delete the partition until you click **Finish** on the **Ready to Restore Image File** screen. If the free space on the destination drive is greater than the space required to restore the selected partitions, the **Resize Options** dialog appears. For more information, refer to the Drive Image manual, available on the MRestore CD. The **Select Disk Write Mode** dialog box appears.



17. Click the disk write mode you want.
 - **Fast** is the quickest way to restore an image.

- **Safe** checks for bad sectors and enables DOS disk write verification. You can also enable the safe options independently using the Advanced Options button in Step 19 page 113. For example, if you want to enable DOS disk write verification but not check for bad sectors, you can use Advanced Options instead of clicking **Safe** mode in this dialog box.
18. Drive Image displays all the information you have entered to this point. To modify any settings, click **Back**.

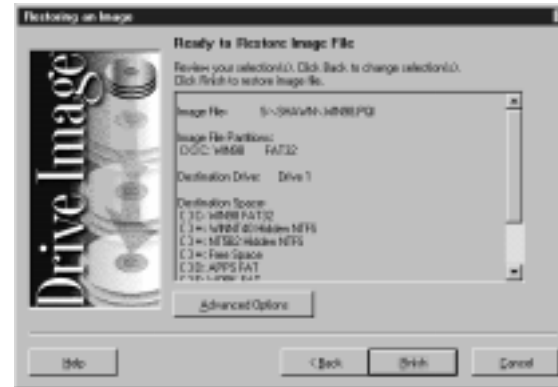

19. If you wish to enable bad-sector checking or turn on DOS disk write verification, click **Advanced Options**.



NOTE: *Restoring multiple logical partitions can cause the drive letters of subsequent partitions to change. This may make the computer unbootable or cause applications to fail.*

20. Click **Finish** to begin restoring the image file.
21. If you assigned a password to the image file when you created it, the **Get Image File Password** dialog box appears. You must enter the correct password in order to restore the image file.

The **Restoring the Image** dialog appears, tracking the following items:

- Image filename
- Estimated megabytes to restore
- Total megabytes copied
- Entire process progress bar

- Information about current partition (volume, type, size MB, used MB, free MB)
- Sub-process progress bar
- Transfer rate for current partition
- Total megabytes copied for current partition
- Time elapsed
- Estimated time remaining

Upon completion, the message "Image was restored successfully" appears.

22. Click **OK** to return to the **Drive Image** main screen.

Resize Options

The following options are available when restoring partitions if the free space on the destination drive is greater than the space required by the partitions.

- **Automatically resize partitions proportionally to fit.** Click this option to allow Drive Image to automatically expand the partitions in equal proportions to occupy the destination drive's remaining free space.
- **Leave remaining free space.** Click this option if you want to leave any remaining free space unused on the destination drive after the partitions are restored.
- **Resize partitions manually to fit.** Click this option to display the **Resize Partition** window where you can manually set the size of the partitions to fit in the destination drive's remaining free space.

Advanced Options

At the **Ready To Restore Image File** screen, click **Advanced Options** to access the following.

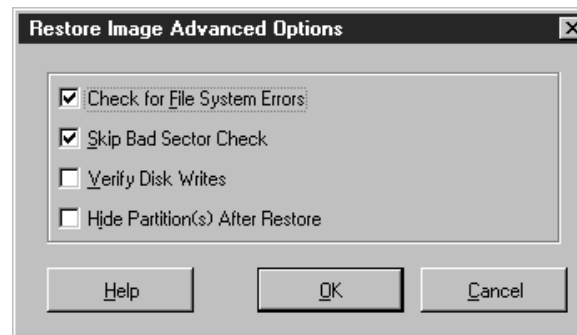

Check for File System Errors

Clear the **Check for File System Errors** check box to disable file system error checking. If you have already used a disk utility program such as ScanDisk to check your hard drive for errors, it is not necessary to have Drive Image check for file system errors. Clearing this option saves time in restoring images. Note that Drive Image cannot restore partitions with file system errors.

Skip Bad Sector Check

To save time in restoring the image file, set this option. Although most drives do not have bad sectors, the potential for problems increases during the lifetime of the hard drive. If you have an older hard drive, it is wise to enable bad-sector checking.

Verify Check Writes

Click **Verify Disk Writes** if you want to enable DOS disk write verification. Disk write verification is not critical to safely restore image files. Enabling disk write verification can slow the image restore process by as much as seven times.

PartitionMagic

Imagine how disorganized your office would be if you kept all your files in one drawer. Surprisingly, this is similar to the way many people organize the space on their hard disks. With PartitionMagic, you can quickly and easily create separate "file drawers," or partitions, on your hard disks for storing valuable information such as data files, applications, and Operating System. Storing information in separate partitions helps you organize and protect your data, safely run multiple Operating Systems, and reclaim wasted disk space.

PartitionMagic enables you to secure your data by physically separating it from other files. Separate partitions also make backups to networks and removable drives easy.

Because of limitations with the FAT file system which is used by many popular Operating Systems such as DOS and Windows 95, as much as 40 percent of your hard-disk space can be wasted. PartitionMagic reclaims wasted space quickly and safely by using more efficient partition sizes. It can also convert FAT partitions to FAT32 and vice versa. With Windows NT you are required to use the convert program provided by the operation system.

With PartitionMagic, partitioning your hard disk has never been easier.



NOTE: *We recommend creating an image file before installing or changing anything on your system.*

In the **PartitionMagic** main window, the menu bar and a toolbar appear at the top of the window. The menu bar gives you access to all of PartitionMagic's features, while the toolbar gives you quick access to commonly-used options.

Partition Information

The partition area displays information about the selected hard disk's partitions. It consists of two areas: the partition map, which displays information graphically; and the partition list, which displays partition information in text form.

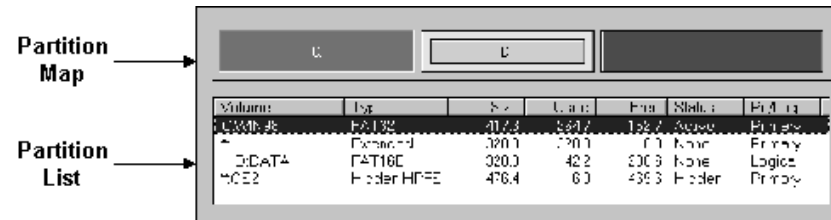

Partition Map

The partition map shows the partitions approximately to scale. Each partition is represented by a different color according to the file system it uses. If the selected hard disk contains logical partitions, the logical partitions are shown within an extended partition.

Partition List

The partition list displays the following information about each partition: drive letter, volume label, file system type, size, amount of used and free space, status, and whether the partition is a primary or logical partition.

Primary partition drive letters are flush left, followed by a colon and the volume name. Logical partition drive letters and volume labels are indented. An asterisk (*) appears in place of a drive letter for:

- Hidden partitions
- Extended partitions
- Partitions with file systems not supported by the active Operating System
- Free space

The partition size, used space, and free space values are displayed in megabytes.

A partition's status can be:

- Active: The partition the computer boots from.
- None: Partitions that are not active or hidden.

You can navigate PartitionMagic using the mouse or the keyboard.

The partition size, used space, and free space values are displayed in megabytes.

To navigate using a mouse, position the mouse pointer on the item you want to select and click the primary (usually the left) mouse button. This action is simply referred to as “clicking” or “click.” While you can make most of your selections using the mouse, a few options require you to type information.

By positioning the pointer on a partition in the partition map or on the partition list and clicking the secondary (usually the right) mouse button, you can display a context menu containing the Operations menu options. This action is simply referred to as “right-clicking” or “right-click.” To select an option on the context menu, click the option.

PartitionMagic Help

While using PartitionMagic, you can quickly get both comprehensive and context-sensitive help when you need it. PartitionMagic’s comprehensive online Help system provides in-depth information on PartitionMagic’s features as well as step-by-step instructions on performing specific tasks.

To access Help, click **Help > Contents** on the menu bar in the **PartitionMagic** main window. The **Help Contents** page organizes the Help system into books and pages.



NOTE: *Some help topic reference applications are not available with MRestore CD.*

ReadMe File

README.TXT is an invaluable resource for the most current information at the time the product shipped. It includes information that may have changed since this guide was printed, corrections to the manual or help system, and information specific to installation or configuration issues.

Completing Tasks Manually

To manually complete a task, follow this general four-step process:

1. Select a hard disk.
2. Select a partition.
3. Select an operation.
4. Apply changes to your system.

Selecting a Hard Disk

The **Disk** option on the toolbar displays the currently selected disk and its size in megabytes (MB).

To select a disk:

- On the toolbar, click the arrow button to the right of the currently selected disk to open a drop-down list of all the disks on your system, and then click the disk you want to select.

OR

- On the menu bar, click **Drives** and then select a disk.



NOTE: *Drives do not appear on the menu bar unless you have multiple hard disks.*

Selecting a Partition

The selected partition is highlighted in the partition list.

To select a partition:

1. Click the partition in the partition list or on the partition map.
2. When you manually complete a task, you most often use the Operations menu. After you have selected a disk and a partition, you can select an operation using the toolbar, the context menu, the menu bar, or the keyboard.



NOTE: *If an operation cannot be performed on the selected partition, the operation is unavailable.*

To select an operation,

- On the tool bar, click the operation's button. When you place the pointer on a tool bar button, a pop-up window appears describing the button's function.

OR

- In the partition map or partition list, right-click the partition you want to change, and then click the desired operation from the context menu.

OR

- On the menu bar, click **Operations** then choose the desired operation.

Applying Changes to Your System

As you complete tasks using the Operations menu, the partition map and partition list reflect the changes you have made. However, no changes physically take place on your system until you apply them.

You can tell when changes have been made but not yet applied to your system when: (1) the **Apply** option appears in the main window, and (2) the status box in the lower right corner of the main window indicates that operations are pending.

To apply changes to your system, click **Apply** or click on the toolbar. If you wish to discard the changes and start over, click on the toolbar.

You can also apply and discard changes using the **General** menu.

Changing PartitionMagic Preferences

From the **General** menu, you can change various program preferences. Each preference is a toggle and, like a light switch, is either on (enabled) or off (disabled). A check mark next to a preference indicates it is enabled.

System supports FAT32 indicates whether the current Operating System supports FAT32 partitions. Windows 95 OEM Service Release 2, Windows 98, and Windows NT 2000 support FAT32 partitions; other Operating Systems do not.

This preference lets you create FAT partitions with 64 KB clusters, which enables Windows NT to support large hard disks. Because DOS, Windows 3.x, Windows 95, and Windows 98 do not support cluster sizes larger than 32 KB, you should never access a 64 KB partition using these Operating Systems. You should only use 64 KB partitions with Windows NT.



NOTE:

If you are using multiple Operating Systems, we recommend not using 64 KB clusters.

To prevent you from inadvertently creating partitions with 64 KB clusters, this preference is disabled every time you exit PartitionMagic.

When enabled, the 64 KB cluster size is available in the **Resize/Move Partition** and **Resize Clusters** screens.

To enable or disable this preference:

1. In the main window, click **General > Preferences**.
2. Click **Allow 64K FAT** Clusters for Windows NT.
3. Click **OK**.

Ignore OS/2 EA Errors on FAT

This preference tells PartitionMagic whether or not to ignore OS/2 Extended Attribute errors when it checks a FAT partition.



WARNING: *If OS/2 is on your computer, do not enable this preference. Data loss could occur because problems might go undetected.*

To enable or disable this preference:

1. In the main window, click **General > Preferences**.
2. Click **Ignore OS/2 EA Errors on FAT**.
3. Click **OK**.

Skip Bad Sector Checks

When PartitionMagic modifies partitions, it performs extensive testing to detect bad sectors on your hard disk. Newer disk types (such as Enhanced IDE and SCSI) often handle bad sectors internally, making such testing superfluous. For this reason, PartitionMagic lets you bypass these tests with **Skip Bad Sector Checks**. When this preference is enabled, the Resize/Move, Create, Copy, and Format operations run faster.



WARNING: *If you skip bad sector checks and your hard disk has bad sectors, data loss can result.*

PartitionMagic lets you set this preference individually for each of your hard disks. If your system has an older disk and a newer one, you could check the older disk and skip the newer one. A check mark next to a disk means to skip bad sector checking for that disk.

To enable or disable this preference:

1. In the main window, click **General > Preferences**.
2. In the **Skip bad sector checks box**, click the box next to the disk(s) you want enabled or disabled.
3. Click **OK**.

Set as Read-Only for PartitionMagic

This preference lets you prevent PartitionMagic from making any changes to a hard disk. The only exception is if the disk contains the boot partition, some files may be changed, such as the Windows NT boot initialization file.

You can set this preference individually for each of your hard disks.

To enable or disable this preference:

1. In the main window, click **General > Preferences**.
2. In the **Set as Read-Only for PartitionMagic box**, click the box next to the disk(s) you want enabled or disabled.
3. Click **OK**.

Creating Partitions

The Create operation lets you create primary partitions, extended partitions, and logical partitions. On a single hard disk, you can have up to four primary partitions or three primary partitions and one extended partition. Within an extended partition, you can create unlimited additional subdivisions called logical partitions.

Generally, you should create primary partitions to install Operating Systems and logical partitions for all other purposes, such as storing data and applications. If you have multiple hard disks, you can improve speed by installing Operating Systems and applications on separate disks. If you do not know what type of partition you want to create, see "Understanding Partitions" in Basic Concepts in the PDF version of the complete manual, located on the MRestore CD at **PQtools\userinfo**.

To create a partition, free space must exist on the hard disk. If there is none, use Resize/Move to make partitions smaller and adjust their location until the free space is in the desired location.

Always make sure the bootable partition is at the far left.

Creating a new partition can make your drive letters change, causing applications not to run because application shortcuts, initialization files, and registry entries refer to incorrect drives.



NOTE:

If using NT you must use the current Operating System conversion method to convert to NTFS. This can be done from within in the OS in a DOS window (at the prompt, type Convert C:\FS:NTFS). Once you have gone to NTFS it is not possible to convert back to FAT or FAT32. Converting back to FAT or FAT32 requires reinstallation of the OS using a FAT table system.

Creating Bootable Partitions

Before creating a partition where you plan to install an Operating System (a bootable partition), you should understand the information outlined in the following table.

TABLE 20. Bootable Partitions

Operation System	Boots from Primary or Logical	Supported Partition Types	Boot Code Boundary	Space Required
DOS 6.22 and earlier	Primary	FAT	2 GB	8 MB
Windows 95	Primary	FAT or FAT32**	8 GB	90 MB
Windows 98	Primary	FAT or FAT32	8 GB	175 MB
Windows NT	Primary*	FAT or NTFS	2 GB	117 MB
Linux	Either	Linux Ext2	8 GB	250 MB
OS/2	Either	FAT or HPFS	4 GB	110 MB

* Windows NT must boot from a primary partition on the first drive. However, only a few NT files must reside on that partition; the remaining files can reside on a logical partition, which can be located on the first or a subsequent drive. The NT boot partition can be shared with another operation system. Additionally, NT must be installed on a FAT partition. During the installation, you can convert the partition to NTFS.

**WARNING:**

When you create, move, or resize a bootable partition, the partition must begin below the boot code boundary specified in Table 20 in order for the Operating System to boot. With the exception of DOS 6.22 (or earlier) and OS/2, partitions beyond 8 GB are visible to the current Operating System. For more information, see “Understanding the BIOS 1,024 Cylinder Limit” and “Understanding the 64K Boot Code Boundary” under Basic Concepts in Help.

PartitionMagic displays a warning if you attempt to create, move, or resize a bootable partition outside of the boot code boundary. If you continue with the operation, you may not be able to boot or to see the partition. In either case, you can resolve the problem by moving the partition back within the boot code boundary. In most cases this is not a problem. Always create an image before changing your configuration.

To Create a Partition

To create a partition:

1. From the **Disk** drop-down list (located on the toolbar), select the disk where you wish to create the new partition.

2. On the partition map or in the partition list, select a block of free space. If no free space exists, you must resize or delete an existing partition to create free space.
3. On the toolbar, click **C:**. The **Create Partition** screen appears.

**NOTE:**

*You can also click **Operations > Create** on the menu bar or right-click the free space and click **Create** on the **Context** menu.*

4. In the **Create as** box, click **Logical Partition** or **Primary Partition**. If you select **Logical Partition**, PartitionMagic automatically creates an extended partition to enclose the logical partition, or, if you already have an extended partition, resizes the extended partition larger to encompass the logical partition (the free space must be inside of or adjacent to the extended partition). If **Logical Partition** is unavailable, you may already have four primary partitions on the hard disk. Or, if you have an extended partition, you may not have selected a block of free space inside of or adjacent to the extended partition.
5. From the **Partition Type** drop-down list, select the desired file system type:
 - **FAT** is the most common file system type. It is used by DOS, Windows 3.x, Windows 95, Windows 98, Windows NT, and OS/2.
 - **FAT32** is used by Windows 95 OEM Service Release 2, Windows 98, and Windows NT 2000.
 - **HPFS** is used by OS/2 and Windows NT 3.51 (and earlier versions).
 - **NTFS** is used only by Windows NT.
 - **Linux Ext2** is used only by Linux.
 - **Linux Swap** is used only by Linux.
 - **Extended** creates an extended partition which can contain any number of logical partitions. **Extended** is not an option if the hard disk already contains an extended partition or four primary partitions.
 - **Unformatted** creates unformatted free space on your hard drive.
6. If you wish, enter a label (up to 11 alphanumeric characters) for the new partition. Descriptive labels help remind you what is stored in a partition (for example, DATA, APPS, WIN95, etc.).
7. In the **Size** box, enter the desired size for the partition. PartitionMagic automatically calculates a recommended size (based on the most efficient use of disk space), which you can accept or change. If the size you specified for

the new partition is smaller than the available free space, you can position the partition at the beginning or end of the free space. Generally, it is best to position the partition at the beginning of the free space. In the **Position** box, click **Beginning of free space** or **End of free space**.

8. In the **Drive Letter** field, note the drive letter that will be assigned to the new partition after reboot.

**NOTE:**

If you create a primary partition, because only one primary partition can be active at a time, the new primary partition is automatically given a hidden status and no drive letter assignment. An exception is Windows NT which can handle multiple primary active partitions.

OR

If you are running Windows NT, use the drive letter box to type or select the drive letter you wish to assign to the partition.

9. Click **OK**. In the lower right corner of the **PartitionMagic** main window, click **Apply**.
10. Click **Yes** to confirm that you want to apply the changes. What happens next depends on whether you have any open files on partitions being affected by the change.
 - a. If you have open files, a prompt appears indicating that the changes you have made require going to MS-DOS mode (if you are using Windows 95 or Windows 98) or rebooting (if you are using Windows NT). Click **OK** to make the changes. After the changes are made, the computer is rebooted. If you created a logical partition, the Operating System has assigned the new partition a drive letter.
 - b. If you do not have open files, the **Batch Progress** dialog box appears, tracking the following items:
 - Description of current operation.
 - Entire process progress bar.
 - Sub-process progress bars.

If you created a logical partition, after the changes are made, PartitionMagic displays a message indicating that Windows must restart.

Scenarios

Sample System Configuration

Disk 1 — One 4 GB disk containing:

- One active primary FAT32 partition (C:) running Windows 95.
- One extended partition enclosing one logical FAT partition (E:).

Disk 2 — One 2 GB hard disk containing:

- One 1 GB FAT32 primary partition (D:).
- 1 GB unpartitioned free space.

Procedure

1. Select Disk 2.
2. Create a logical partition in the 1 GB free space using the following information:
 - **Partition Type:** Select **FAT**.
 - **Label:** Type one, if desired.
 - **Size:** Accept the pre-calculated size.



NOTE:

The partition will be assigned drive F: after reboot. Additionally, an extended partition will automatically be created to enclose the logical partition.

3. Apply the changes to your system.

Deleting Partitions

The Delete operation deletes a partition and destroys all its data. To ensure that you do not accidentally delete a partition, you must first type the volume label. If you did not assign a volume label when you created the partition, you must type **NO NAME** to confirm the deletion.

To delete an extended partition, you must first delete all logical partitions within the extended partition.

Deleting a partition can make your drive letters change, causing applications not to run because application shortcuts, initialization files, and registry entries refer to incorrect drives.



WARNING:

Performing the following procedure will destroy all data on the selected partition and may change drive letter assignments. See "How the OS

Assigns Drive Letters” and “Problems Caused by Drive Letter Changes” in Basic Concepts in Help.

To delete a partition:

1. From the **Disk** drop-down list (located on the toolbar), select the disk with the partition you wish to delete.
2. On the partition map or in the partition list, select the partition you want to delete.
3. On the toolbar, click the **Delete** button (X). The **Delete Partition** dialog appears.
4. Type the volume label to confirm the deletion.

**NOTE:**

The Delete Partition dialog displays the current volume label. The volume shown above the label is DATA.

5. Click **OK**.
6. In the lower right corner of the **PartitionMagic** main window, click **Apply**. You can also click on the toolbar to apply the changes. If you do not wish to commit to the pending changes, click on the toolbar to discard the changes and start over.

You may perform other partition operations and then click **Apply** after completing all of them.

7. Click **Yes** to confirm that you want to apply the changes.

Changing Partition Labels

The **Label** operation lets you to change a partition's volume label. Giving your partitions meaningful names makes managing them easier. For example, by labeling a partition GAMES, you can tell at a glance what that partition contains.

Labels can be up to 11 alphanumeric characters. Labels follow the same rules as DOS names, with two exceptions: spaces are allowed, and no period is required between the first eight characters and the last three.

To change a partition label:

1. From the **Disk** drop-down list (located on the toolbar), select the disk with the partition whose label you wish to change.
2. On the partition map or in the partition list, select the partition with the label you want to change.

3. On the toolbar, click the **Label** icon. The **Label Partition** dialog appears:
4. In the **New Label** box, type the new label. Labels cannot contain these special characters: [*?:<>|+=;\'",].
5. Click **OK**. In the lower right corner of the **PartitionMagic** main window, click **Apply**.
6. Click **Yes** to confirm that you want to apply the changes.

Formatting Partitions

The **Format** operation formats a partition, destroying all its data in the process. Formatting enables you to put a different file system on a partition. To ensure that you do not accidentally format a partition, you must first type the volume label. If you did not assign a volume label when you created the partition, you must type **NO NAME** to confirm deletion.



NOTE: *PartitionMagic has several conversion options that let you convert from one file system to another without destroying existing files in a partition.*

To format a partition:

1. From the **Disk** drop-down list (located on the toolbar), select the disk with the partition you wish to format.
2. On the partition map or in the partition list, select the partition you want to format. On the toolbar, click the **Format** icon. The **Format Verification** screen appears:



NOTE: *You can also click **Operations > Format** on the menu bar or right-click the partition and click **Format** on the **Context** menu.*

3. Type the current volume label.
4. Click **Continue** to verify your intent to format the partition. The **Format Partition** screen appears:
5. From the **Partition Type** drop-down list, select the desired file system type.
6. If the partition is too small or too large, some partition types may not be available. If you wish, type a label for the partition.
7. Click **OK**. In the lower right corner of the **PartitionMagic** main window, click **Apply**.
8. Click **Yes** to confirm that you want to apply the changes.

Converting FAT to FAT32

The **Convert FAT to FAT32** operation converts a FAT partition to FAT32. FAT32 partitions have less wasted disk space than FAT partitions. However, you should be aware of these issues:

- You must have Windows 95 OEM Service Release 2, Windows 98, or Windows NT 2000 to access files on a FAT32 partition. (NT 4.0 is **NOT** compatible with a FAT 32 partition.)
- If you are using multiple Operating Systems, FAT32 partitions are inaccessible when the other Operating Systems are running.
- Save-to-disk partitions cannot be resized or converted to any file system; they can only be deleted.

The minimum size for a FAT32 partition is 256 MB.

To convert from FAT to FAT32:

1. From the **Disk** drop-down list (located on the toolbar), select the disk containing the partition you wish to convert.
2. On the partition map or in the partition list, right-click the FAT partition you want to convert to FAT32 and click **Convert > Convert FAT to FAT32** on the context menu.



NOTE: *You can also select the partition and click **Operations > Convert > Convert FAT to FAT32** on the menu bar.*

3. To continue with the conversion, click **OK**.
4. In the lower right corner of the **PartitionMagic** main window, click **Apply**.
5. Click **Yes** to confirm that you want to apply the changes.

Converting FAT to NTFS

The **Convert FAT to NTFS** operation launches the Microsoft Convert utility to convert a FAT partition to NTFS. You must be running Windows NT to complete this conversion. At a Command Prompt window, type **Convert C:\FS\NTFS**.

If you boot multiple OSs you must be very careful converting FAT to NTFS. NTFS is only accessible with Windows NT; therefore, the data in this partition will not be accessible if you boot DOS or Windows 95/98. This is a one-way conversion; to revert back to FAT you must back up all your files, reformat the partition, and restore the files.

If NTFS is the full size of your drive and no DOS partition is available, you must copy the psmagic files to a bootable floppy and at the command line type **Psmagic/PQB=a:Pqbatch.pqb**. Because NTFS is not accessible from DOS it is unable to copy the batchfile process to the hard drive. By typing the **Psmagic/PQB=a:Pqbatch.pqb** command, it is able to write to the floppy. PartitionMagic can now complete the tasks specified.

The **Convert FAT32 to FAT** operation converts a FAT32 partition to FAT. To complete this conversion, the partition must have at least 300-400 MB free space because of how the FAT file system allocates disk space for file storage.

To convert a FAT32 partition to FAT:

1. From the **Disk** drop-down list (located on the toolbar), select the disk containing the partition you want to convert.
2. On the partition map or in the partition list, right-click the partition you want to convert and click **Convert > Convert FAT32 to FAT** on the context menu.

**NOTE:**

*You can also select the partition and click **Operations > Convert > Convert FAT32 to FAT** on the menu bar. At this point, PartitionMagic may report too many root directory entries (the maximum number of entries in a FAT partition's root directory is limited, unlike a FAT32 partition's root directory). In this case, move or copy some of the files in the root directory to another location and then start the conversion again.*

3. To continue with the conversion, click **OK**.
4. In the lower right corner of the **PartitionMagic** main window, click **Apply**.
5. Click **Yes** to confirm that you want to apply the changes.
 - Description of current operation.
 - Entire process progress bar.
 - Sub-process progress bars.

When all operations are complete, click **OK** to close the **Batch Progress** dialog and return to the **PartitionMagic** main window. The partition is converted.



NOTE: *NTFS does NOT convert to anything. You must stay with this partition format or reinstall the Operating System.*



WARNING: *Because of the above example, we recommend that you create an image of your hard drive before modifying or installing anything. (Create an image of hard drive while using the FAT file system.)*

Drive Copy

DriveCopy is an easy-to-use utility for copying the contents of one hard drive to another. It is not used for creating backups; it is only used for hard drive to hard drive transfers. DriveCopy copies everything on your drive in a few simple steps without losing a single preference, setting, or byte of data. With DriveCopy, you can move your Operating System, applications, and data to a larger or smaller hard drive. DriveCopy copies FAT, FAT32, FAT32X, NTFS, and HPFS partition types in all versions of Windows 95 and Windows 98, Windows NT, Windows 3.x, DOS, and OS/2. By copying, partitions are copied and then expanded to occupy the same proportion of the new hard drive as they occupied on the original hard drive.

Copying Entire Drives

This utility may be accessed on the MRestore CD included with your computer.

To copy the contents of one hard drive to another, perform the following:

1. At the **DriveCopy** main screen, click **Entire Disk to Disk Copy**.
2. From the **Source Drive** group box, select the source drive. A check mark appears to the left of the selected drive.



NOTE: *Please be aware that it is NOT necessary to format or partition your destination drive. DriveCopy automatically performs both these functions.*

3. From the **Destination Drive** group box, select the destination drive. A check mark appears to the left of the selected drive.
4. Click **Next**. DriveCopy displays all the information you have entered to this point.
 - Source drive
 - Source partitions
 - Destination drive

5. If you wish to alter any settings, click **Previous** to backtrack and make changes.
6. If you wish to set options such as disabling file system error-checking or hiding partitions after copy, click **Advanced Options**.

Copying multiple logical partitions can cause the drive letters of subsequent partitions to change. This may make the computer unbootable or cause applications to fail.

7. Click **Finish** to begin copying. The Copying **Disk To Disk** screen appears, tracking the following items:
 - Estimated megabytes to copy.
 - Total megabytes copied.
 - Entire process progress bar.
 - Information about partition (volume, type, size MB, used MB, free MB).
 - Sub-process progress bar.
 - Transfer rate for current partition.
 - Total megabytes copied for current partition.
 - Time elapsed.
 - Estimated time remaining.
8. Upon completion, the following message appears: "Selected partition(s) copied successfully. Would you like to view results? Yes/No". Click **Yes** to view information about the copied partition(s) such as volume type, status, size, used MB, free MB, and primary or logical format.
9. If no active partition exists on destination drive, the following message appears: "No active (bootable) partition exists on destination drive. Would you like to set an active partition now? Yes/No." Select **Yes** to set an active partition.
10. If the destination drive will be designated as the Master drive, you must set the partition active that contains your Operating System. To set the Operating System partition active, perform the following:
 - a. Click **Yes**.
 - b. Select the partition containing your Operating System.
 - c. Click **Set Active**.
 - d. Click **Close**.
11. From the **DriveCopy** main screen, click **Exit**.

PHDISK Utility

PHDISK.EXE is the utility program you use to prepare your hard disk for the Suspend to Disk function. It can be used to prepare a dedicated partition prior to storing system configuration data, and system and video memory. Do not remove this partition, labeled "non-DOS" from your hard drive using FDISK. This would disable the TransPort LT's ability from saving to disk.

The following table lists the PHDISK command line options and additional parameters. The PHDISK options can be called by using only the first letter of each option and parameter. For instance, either PHDISK /REFORMAT or PHDISK /R will invoke the reformat option.

TABLE 21. Command Line Options

Option	Parameters	Description
None		Displays the PHDISK opening screen.
/CREATE	/PARTITION	Formats the save-to-disk partition
/DELETE	/PARTITION	Deletes the save-to-disk partition
/INFO	/PARTITION	Displays data about the save-to-disk portion or file
/REFORMAT	/PARTITION	Reforms the save-to-disk portion after an error is detected

Following is an example of the kind of information that is displayed when PHDISK is called without a command line option. This example displays Save-To-Disk PARTITION INFORMATION headers. This header is displayed only when a Save-To-Disk partition exists.

The USAGE and OPTIONS headers are displayed in several screens displayed by PHDISK.

Help Screen

The HELP screen is displayed when PHDISK is called without any command-line options.

CREATE Option

The CREATE option measures the amount of on-board memory, and partitions a segment of the hard disk drive large enough to store all data present in the segment. The CREATE option formats the Save-To-Disk partition or file, marking bad spots on the hard disk drive as they are found.

Automatic Memory Size Calculation

PHDISK automatically measures all system and video memory and calculates the exact amount of hard disk space required to store the maximum amount of data present in memory.

Micron has already placed a partition on your hard drive that will handle all the way up to a fully populated 256 MB system.

User-specified Memory Size

The user may specify a certain amount of memory to be allocated for the Save-To-Disk function. However, the amount of space required to store all system and video memory is calculated automatically, whenever the CREATE option is used, even if the user specifies an amount.

If the amount specified by the user is equal to or greater than the calculated amount, then the user-specified amount is allocated. If the user-specified amount is less than the calculated amount, then no space is allocated, and an error message is displayed. If you wish to allocate a specific amount of disk space for this function, enter the amount in kilobytes, as a simple decimal number, *without* any notation such as **K** or **KB**.

/Partition or /P

PARTITION creates a hard disk partition where only Save-To-Disk data can be stored.

/CREATE Option Syntax

The syntax of the PHDISK /CREATE option is: **PHDISK /CREATE [/PARTITION]**

REFORMAT Option

The /REFORMAT option resets the pointers in a Save-To-Disk partition. This option should be used after a Save-To-Disk operation is terminated by a read or write error.

TABLE 22. Reformat Option

Command	Description
PHDISK/ REFORMAT PARTITION PH/DISK/R/P	Reformats the Save-To-Disk partition.

INFO Option

The /INFO option displays data about the Save-To-Disk partition or file.

Following is an example of the output of the /INFO option when a Save-To-Disk partition exists on the system.

TABLE 23. INFO Option

Command	Description
PHDISK/INFO/PARTITION PH/DISK/I/P	Displays the size (in kilobytes) and location of the Save-To-Disk partition

PHDISK Sign-on Message

A PHDISK sign-on message will appear.

Unrecognized Option

The following text is displayed when an invalid option or parameter is entered on the command line. "Error: (User option) is an unrecognized command line option. For a command line summary, invoke PHDISK without any parameters."

PHDISK/CREATE Failed to Execute

The following text is displayed when no Save-To-Disk partition exists, or the partition table on head 0, cylinder 0, sector 1 is corrupted. "Error: The Phoenix NoteBIOS™ Save-To-Disk partition doesn't exist or the hard disk partition table on head 0, cylinder 0, sector 1 is corrupted. Invoke PHDISK/CREATE to create the Save-To-Disk partition."

Execute PHDISK/PARTITION/REFORMAT to reset the GSM flags.

Fatal Error

The following text is displayed when the amount of unused disk space available is less than the amount required to create the Save-To-Disk partition. "Error: Not enough free disk space exists to create the suspend to disk partition. Refer to the user manual for possible suggestions on increasing the amount of free disk space for the suspend to disk partition."

Delete unused files, backup the DOS partition, reformat the disk, then run PHDISK /PARTITION /CREATE to create a larger partition.

Save-To-Disk Partition Exits

The following text is displayed when a PHDISK /CREATE /PARTITION operation is attempted while a Save-To-Disk partition exists. "Error: Phoenix NoteBIOS Save-To-Disk partition already exists. To resize the partition, delete the existing partition with PHDISK/DELETE and create the partition with PHDISK/CREATE."

Re-allocate the Save-To-Disk partition, if needed; or do nothing.

First Two Sectors Bad

The following text is displayed when the Save-To-Disk partition cannot be used. "Error: The first two sectors in the Save-To-Disk partition are both unusable. This disk is unsuitable for the Phoenix NoteBIOS Save-To-Disk feature."

Execute PHDISK /PARTITION /DELETE, and PHDISK /PARTITION /REFORMAT.

The following text is displayed when a hard disk error is detected during any Save-To-Disk operation. (The word *fatal* simply means that the program was terminated, not that your hard disk is damaged.) Error-A fatal hard disk error has occurred. Check your hardware configuration and re-execute.”

Run a hard disk utility program to determine the source of the error, then run PHDISK again.

This page intentionally left blank.

Chapter 12 - Restoring your Computer

Notebook computers that ship from the factory include one Microsoft Windows 98, Windows 2000, or Windows NT 4.0 CD-ROM and System utility CD-ROM, which contains a copy of the applications and drivers needed for a computer's Operating System.

In the unlikely event that programs on the computer hard drive become corrupted or are erased, you can use the Microsoft Operating System CD-ROM to reinstall your Operating System and then the System utility CD-ROM to reinstall your original applications and drivers.



NOTE: *Under the Boot menu in System Setup, set Diskette Drive as the first boot device and CD-ROM Drive as the second. (See "Using System Setup" on page 75. for information on setting options.)*



NOTE: *See the documentation that accompanied your Operating System for detailed information on installation and setup.*

To (re)install your Operating System:

Windows 98:

1. Turn off the computer and insert your CD-ROM drive into your computer. (See "Using the CD-ROM Drive" on page 37 for instructions.)
2. Insert your Microsoft Operating System CD-ROM into the CD-ROM drive and start your computer.
3. Choose **Boot from CD-ROM** at the **Microsoft Windows 98 CD-ROM startup menu**.
4. If you do not need to partition or format your hard drive proceed to step 11.
5. Choose **Start computer with CD-ROM support** at the **Microsoft Windows 98 startup menu**.
6. If you do not need to partition your hard drive proceed to step 9.

7. Type *FDISK* at the prompt and partition your hard drive.
8. Restart your computer to allow it to recognize the new partitions.
9. Type *FORMAT C:/S* at the prompt to format the C: drive, repeat this for any other drives that you may have.
10. Restart your computer.
11. Choose **Start Windows 98 Setup**.
12. Follow the prompts to install your Operating System.

Windows NT 4.0 Workstation:

1. Turn off the computer and insert your CD-ROM drive into your computer. (See "Using the CD-ROM Drive" on page 37 for instructions.)
2. Insert your Microsoft Operating System CD-ROM into the CD-ROM drive and start your computer.
3. Follow the prompts. The installation program will partition and format your hard drive as necessary, see the documentation that accompanied your Operating System for more information on installation and setup.

To (re)install your original applications and drivers:

1. Start your computer and wait for the Operating System to finish loading.
2. Insert your System utility CD-ROM into the CD-ROM drive.
3. Select the first application or driver to begin its installation.
4. Repeat step 3 for each application and driver, reboot if necessary.

Chapter 13 - Troubleshooting

If you ever have difficulty running your computer, consult the following sections for advice on how to handle system problems.

If this section does not help you resolve the problem, contact micronpc.com Technical Support at 1-888-FIX-MYPC (1-888-349-6972).

Operating Problems

The computer does nothing when you turn it on.

Check the battery charge - it may be low. Connect the power cord to get power and recharge the battery. Try turning on the computer again.

Nothing appears on the LCD panel when you turn on the computer.

Adjust the brightness on a TFT LCD. If you are using an external monitor press [Fn+F5] to return to the LCD panel.

Nothing appears on the external monitor when you switch the display to it.

Check all monitor connections to verify it is connected properly. Check the monitor's power cord to insure it is connected to an AC wall outlet. Check the brightness and contrast controls on the monitor. If the program appear on the LCD panel instead of the external monitor, press [Fn+F5] to switch to the monitor. Try turning the monitor off and on again.

The external monitor displays flashes or waves.

Check the cables between the monitor and the computer to make sure they are properly installed and connected.

Some of the letter keys type numbers instead of the indicated letters.

The numeric keypad on the keyboard may be active. Check to see if the NumLock light is on. To return the keypad keys to typing letters, press [NumLock].

Battery power seems to run out faster than expected.

If you are running the computer from the battery rather than the power cord, make sure that you set the **Idle Mode** field in System Setup to **On**. This setting enables the microprocessor and the hard drive to slow down when the computer is not busy.

You can also enable other power-saving options through System Setup. Set the timeout times in the **Standby Timeout** and **Rest Timeout** fields to the shortest times to ensure maximum power savings.

Certain software programs “hang” during operations when there is no interaction with the keyboard or peripheral devices.

Your computer may be in standby or rest mode. Tap the touchpad to resume from standby or press the power button to resume from rest.

A serial or parallel device attached to a serial or parallel port on the rear panel of the system unit does not work properly.

Make sure the attached device is turned on. Verify that the cable is properly installed between the device and the port. Make sure that the **Installed OS** section in the **Advanced** menu in **Setup** is set to the Operating System you are running on your TransPort LT.

A PC Card does not work correctly.

Make sure that the PC Card is inserted left side up in the PC Card slot. Check that the card is inserted fully into the slot. If you are using a PC Card modem, check the modem cable connections. Make sure that the **Installed OS** section in the **Advanced** menu in **Setup** is set to the Operating System you are running on your TransPort LT. Make sure that you are using the correct driver for your PC card.

The System Setup settings are not retained when you turn off the computer.

The CMOS battery inside the computer may need to be replaced. The CMOS battery provides power to save the system BIOS information when the computer is turned off. Normally, the CMOS battery lasts for several years. Do not attempt to open the chassis and replace this battery yourself or your warranty is void. Have an authorized the manufacturer's service center replace the CMOS battery.

Infrared Problems

If your computer's Operating System is Windows 98 or Windows 2000, you can enable and use the infrared port. The Windows NT 4.0 Operating System does not support infrared.

If you are unable to transfer files with the infrared port, check the following:

- Make sure the setting of **Serial port B** is set to the **Windows\System\Properties\Network\IrDA** driver.
- The sending and receiving devices need to be on the same level vertically. Place the infrared ports on the sending and receiving devices so they face each other, with no more than a 30 degree angle between the two infrared ports.
- To use Infrared port, you have to set **Infrared Port** in BIOS setup to **Enabled**, and the "Use Infrared port field in Control Panel" from **Infrared** to **Enabled**.

Even if all the setting is done, the Infrared driver may not support 4Mbps or the file does not transferred in ACPI Windows 98. This is the Windows 98's known problem. Use the Direct Cable Connection or hyper terminal for faster speed in transferring the file, see Windows help to get information on its setting method. You may hear the audio noise while using the infrared port, set **Use Infrared port** field in **Control Panel, Infrared** to **Disabled** to prevent noise.

Modem Problems

My modem doesn't connect to services or disconnects during communication.

If your modem has difficulty connecting to on-line services and sustaining communications, check the quality of the phone line first. Interference from certain devices or poor line power conditions may degrade the quality of your connection. Under these conditions gradually reduce the communication speed of your modem until a reliable connection is achieved.

Check with your on-line service provider. Service may be halted.

When using a PBX phone system I cannot dial on my modem.

If you use a PBX phone system you may need to press a number e.g. '9' to connect to an external line, you should enter the following command before trying the connection and check modem initialization.

ATX3&W

And add 9, as the external line prefix (in our example) of the phone number when using the dial command "*ATDT9, 123-4567*".

Screen displays random or garbage characters during communications.

After your modem has connected to the on-line service, your screen may display garbage characters or after-images in screen transitions. This problem is caused by a mismatch of the terminal modes between communications service and communications programs. You need to match the terminal modes to each other.

Refer the user's guide of the communications program you're using.

Reports error message that insufficient Hard Disk space is available.

Delete the unnecessary messages or data you received by Modem or Fax every one to three months as required.

If you're using WWW of the internet, many picture and data files can get downloaded to your HARD DISK every time you visit a home page, which will consume a large amount of your HARD DISK space. Delete the unnecessary messages or data you received by Modem or Fax every one to three months as required. For more detailed information about the method of deleting, refer to the Web browser's help program.



NOTE:

Depending on telephone line status, location, or types of Fax being connected to, The modem may not connect, or disconnection may occur during data transfer, and some types of application software may not work correctly.

Chapter 14 - Specifications

System Specifications

TABLE 24. Hardware Specifications

Dimension	
	LCD viewing area
LCD viewing area (12.1 TFT)	9.7 x 7.2 in (246 x 184.5 mm)
LCD viewing area (13.3 TFT)	10.6 x 8.0 in (270.3 x 202.8 mm)
Width	11.89 in (30.2 cm)
Height	1.18 in (2.99 cm)
Depth	9.53 in (24.2 cm)
Weight (12.1" with floppy drive)	4.80 lb. (2200 g)
Weight (13.3" with floppy drive)	4.90 lb. (2280 g)
Environment	
Ambient temperature, operating	50°–90° F (10°–32°C)
Ambient temperature, storage	23°–104° F (-5°–40° C)
Relative humidity (noncondensing), operating	20–80%
Relative humidity (noncondensing), storage	5–90%
Altitude, operating	0 to 8,000 ft. (0 to 2,348 m)
Altitude, storage	0 to 40,000 ft. (0 to 12,192 m)
Shock, operating	10 G for 11 ms half sine
Shock, non-operating	60 G for 11 ms half sine
Lithium-Ion Smart Battery	
Normal Weight	0.83 lb. (380g)
Nominal open circuit voltage	10.8 VDC

Capacity, typical	3200 mAh
Charging time, approximate, with computer turned off, typical	2.5 hr.
Charging time, approximate, with computer turned on, typical	4.0 hr.
Average battery life, with no power management enabled	2.5 hr.

External AC Adapter

Operating voltage	100-240 VAC
Line frequency	50/60 Hz
Input current	1.5 -0.8 A
Output current	3.15 A
Output voltage	19.0 VDC

Chapter 15 - Recording the Computer Hardware Configuration

In the spaces provided, write the System Setup program settings. If your computer ever loses configuration information, you can enter the information from this section into System Setup to restore it.

MAIN MENU

Diskette A: LS-120 1.44/1.25 MB 3 1/2" Disabled

IDE ADAPTER SUBMENU

Primary Master:

Type: _____ Cylinders: _____

Heads: _____ Sectors: _____

Multi-Sector Transfers: _____

LBA Mode Control: Enabled Disabled

32 Bit I/O: Enabled Disabled

Transfer Mode: Standard Fast PIO 1

Fast PIO 2 Fast PIO 3

Fast PIO 4

Ultra DMA Transfer Mode: Mode 0 Mode 1

Mode 2 Disabled

Secondary Master:

Type: _____ Cylinders: _____

Heads: _____ Sectors : _____

Multi-Sector Transfers: _____

LBA Mode Control: Enabled Disabled

32 Bit I/O: Enabled Disabled

Transfer Mode: Standard Fast PIO 1

Fast PIO 2 Fast PIO 3

Fast PIO 4

Ultra DMA Transfer Mode: Mode 0 Mode 1

Mode 2 Disabled

ADVANCED MENU

Installed O/S: Other/WinNT4.0 Win95 APM
 Win98/Win2000

PS/2 Mouse Configuration: Disabled Single Mouse
 Dual Mouse

Screen Expansion: Enabled Disabled

TV Standard: NTSC PAL

Dual Display: LCD CRT Both

I/O DEVICE CONFIGURATION SUBMENU

Serial port A: Enabled Auto Disabled

 Base I/O Address 3F8, IRQ 4 2F8, IRQ 3
 3E8, IRQ 4 2E8, IRQ 3

Serial port B: Enabled Auto Disabled

 Base I/O Address 3F8, IRQ 4 2F8, IRQ 3
 3E8, IRQ 4 2E8, IRQ 3

 Mode FIR

 DMA Channel DMA 3 DMA 1

Parallel port: Enabled Auto Disabled

 Mode Output only Bi-directional
 EPP ECP

 Base I/O Address 378, IRQ 378, IRQ 5 278, IRQ 7
 278, IRQ 5 3BC, IRQ 7 3BC, IRQ 5

 DMA Channel DMA 1 DMA 2 DMA 3

Floppy disk controller: Enabled Auto Disabled

Local Bus IDE adapter: Both Disabled Primary
 Secondary

Large Disk Access Mode: DOS Other

SECURITY MENU

Set password

Password on boot: Enabled Disabled

Fixed disk boot sector: Normal Write Protect

Diskette access: Supervisor User

Virus check reminder: Daily Weekly

Monthly Disabled

System backup reminder: Daily Weekly

Monthly Disabled

POWER MENU

Idle Mode: Off On

Standby Timeout: Off Time _____

Rest Mode:
Disk Power On Suspend Save To

Rest Timeout: Off Time _____

Hard disk Timeout: Off Time _____

Resume On Modem Ring: On Off

Resume On Time: On Off

Resume Time: _____

BOOT MENU

QuietBoot Mode: Enabled Disabled

QuickBoot Mode: Enabled Disabled

Floppy check: Enabled Disabled

Bootable CD Check: Enabled Disabled

Summary screen: Enabled Disabled

Wake On Lan: Enabled Disabled

Boot Device Priority:

Boot option 1: _____

Boot option 2: _____

Boot option 3: _____

Appendix A - Regulatory

FCC Notice

This device complies with Part 15 of the FCC Rules. Operation is subject to the following two conditions:(1) this device may not cause harmful interference, and (2) this device must accept any interference received, including interference that may cause undesired operation.

This equipment has been tested and found to comply with the limits for a Class B digital device pursuant to Part 15 of the FCC Rules. These limits are designed to provide reasonable protection against harmful interference in a residential installation. This equipment generates radio frequency energy and if not installed and used in accordance with the instructions, may cause harmful interference. If this equipment does cause harmful interference to radio or television reception, which can be determined by turning the equipment off and on, the user is encouraged to try to correct the interference by one or more of the following measures:

- Reorient or relocate the receiving antenna.
- Increase the separation between the equipment and receiver.
- Connect the equipment into an outlet on a circuit different from that to which the receiver is connected.
- Consult the dealer or an experienced radio/TV technician for help.

If necessary, the user should consult the dealer or an experienced radio/television technician for additional suggestions. The user may find the following booklet helpful: "Something About Interference." This is available at FCC local regional offices. Our company is not responsible for any radio or television interference caused by unauthorized modifications of this equipment or the substitution or attachment of connecting cables and equipment other than those specified by our company. The correction will be the responsibility of the user. Use only shielded data cables with this system.

Federal Communications Commission (FCC) Part 68 Statement

This equipment complies with part of the FCC rules. On the back of this equipment is a label that contains, the FCC registration number and the ringer equivalence number (REN) for this equipment. If requested, this information must be provided to the telephone company.

This equipment uses the following USOC jacks: RJ11C

A FCC compliant telephone cord and modular plug is provided with this equipment. This equipment is designed to be connected to the telephone network or promises wiring using a compatible modular jack which is Part 68 compliant.

The REN is used to determine the quantity of devices which may be connected to telephone line. Excessive RENs on the telephone line may result in the devices not ringing in response to an incoming call. In most, but not all areas, the sum of RENs should not exceed five (5.0). To be certain of the number of devices that may be connected to a line, as determined by total RENs, contact the local telephone company to determine the maximum REN for the calling area.

If the terminal equipment causes harm to the telephone network, the Telephone Company will notify you in advance that temporary discontinuance of service may be required. But if advance notice is not practical, the telephone company will notify the customer as soon as possible. Also, you will be advised of your right to file a complaint with the FCC if you believe it is necessary.

The telephone company may make changes in its facilities, equipment, operations, or procedures that could affect the operation of the equipment. If this happens, the telephone company will provide advanced notice in order for you to make necessary modifications to maintain uninterrupted service.

If trouble is experienced with this equipment (SENS Modem), please contact your local distributor. If the equipment is causing harm to the telephone network, the telephone company may request that you disconnect the equipment until the problem is resolved.

The user must use the accessories and cables supplied by the manufacturer to get optimum performance from the product.

No repairs may be done by the customer.

This equipment cannot be used on public coin phone service provided by the telephone company. Connection to party line service is subject to state tariffs.

The Telephone Consumer Protection Act of 1991 makes it unlawful for any person to use a computer or other electronic device, including fax machines, to send any message unless such message clearly contains in a margin at the top or bottom of each transmitted page or on the first page of the transmission, the date and time it is sent and an identification of the business or other entity, or other individual sending the message and the telephone number of the sending machine or such business, other entity, or individual. (The telephone number provided may not be

any number for which charges exceed local or long-distance transmission charges.)

In order to program this information into your fax machine, refer to your communications software user manual.

CTR21 Statement

The equipment has been approved in accordance with Council Decision 98/482/EC for pan-European single terminal connection to the public switched telephone network (PSTN). However, due to differences between the individual PSTNs provided in different countries, the approval does not, of itself, give an unconditional assurance of successful operation on every PSTN network termination point.

In the event of problems, you should contact your equipment supplier in the first instance.

Canadian Radio Interference Regulations

This apparatus does not exceed the class B limits for radio noise emissions set out in the radio interference regulations of the Canadian Department of Communications.

Le présent appareil n'émet pas de bruits radioélectriques dépassant les limites applicable aux appareils de la classe B prescrites par le règlement de brouillage radioélectrique dicté par le Ministère des Communications du Canada.

CLASS 1 LASER PRODUCT



CAUTION

The laser beam used by this CD-ROM drive unit can be harmful to the eyes. Do not attempt to open the unit. All service procedures should be performed by an authorized dealer or distributor.



WARNING

Never use any optical instruments in conjunction with this unit. To do so will greatly increase the hazard to your eyes.



ADVARSEL

USYNLIG LASERSTRÅLING VED ÅBNING, NÅR SIKKERHEDSAFBRYDERE ER UDE AF FUNKTION.

SE IKKE IND I STRÅLEN - HELLER IKKE MED OPTISKE INSTRUMENTER.

**ADVARSEL**

USYNLIG LASERSTRÅLING NÅR DEKSEL ÅPNES OG SIKKERHEDSLÅS BRYTES.

STIRR IKKE INN I STRÅLEN ELLER SE DIREKTE MED OPTISKE INSTRUMENTER.

LUOKAN 1 LASERLAITE

**VAROITUS!**

LAITTEEN KÄYTTÄMINEN MUULLA KUIN TÄSSÄ KÄYTTÖOHJEESSA MAINITULLA TAVALLA SAATTAÄ ALTISTAA KÄYTTÄJÄN TURVALLISUUSLUOKAN 1 YLITTÄVÄLLE NÄKYMÄTTÖMÄLLE LASERSÄTEILYLLE.

KLASS 1 LASERAPPARAT

**VARNING**

OM APPARATEN ANVÄNDS PÅ ANNAT SÄTT ÄN I DENNA BRUKSANVISNING SPECIFICERATS, KAN ANVÄNDAREN UTSÄTTAS FÖR OSYNLIG LASER-STRÅLNING, SOM ÖVERSKRIDER GRÄNSEN FÖR LASERKLASS 1.

Labels appearing on the drives:

CAUTION - INVISIBLE LASER RADIATION WHEN OPEN. AVOID EXPOSURE TO BEAM.

VORSICHT! UNSICHTBARE LASERSTRAHLUNG TRITT AUS, WENN DECKEL GEÖFFNET. NICHT DEM STRAHL AUSSETZEN!

VARNING - OSYNLIG LASERSTRÅLNING NÅR DENNA DEL ÄR ÖPPNAD. STRÅLEN ÄR FARLIG.

ADVARSEL - USYNLIG LASERSTRÅLING VED ÅBNING. UNDGÅ UDS/ETTELSE FOR STRÅLING.

CLASS 1 LASER PRODUCT LASERSCHUTZKLASSE 1 PRODUKT

Power Cord Requirement

The power cord set (appliance coupler, flexible cord, and wall plug) you received with your computer meets the requirements for use in the country where you purchased your equipment.

Power cord sets for use in other countries must meet the requirements of the country where you use the computer. For more information on power cord set requirements, contact your authorized dealer, reseller, or service provider.

General Requirements

The requirements listed below are applicable to all countries:

- The length of the power cord set must be at least 6.00 feet (1.8m) and a maximum of 9.75 feet (3.0m).
- All power cord sets must be approved by an acceptable accredited agency responsible for evaluation in the country where the power cord set will be used.
- The power cord set must have a minimum current capacity of 7 A and a nominal voltage rating of 125 or 250 volts AC, as required by each country's power system.
- The appliance coupler must meet the mechanical configuration of an EN 60 320/IEC 320 Standard Sheet C13 connector, for mating with appliance inlet on the computer.

TABLE 25. Country-Specific Power cord Set Requirements

Country	Accredited Agency	Applicable Note Numbers
Australia	EANSW	*
Austria	OVE	*
Belgium	CEBC	*
Canada	CSA	**
Denmark	DEMKO	*
Finland	FIMKO	*
France	UTE	*
Germany	VDE	*
Italy	IMQ	*
Japan	JIS	***
The Netherlands	KEMA	*
Norway	NEMKO	*

Sweden	SEMKO	*
Switzerland	SEV	*
United kingdom	BSI	*
United States	UL	**

Notes:

* Flexible cord must be <HAR> Type HO5VV-F, 3-conductor, 1.0 mm² conductor size. Power cord set fittings (appliance coupler and wall plug) must bear the certification mark of the agency responsible for evaluation in the country where it will be used.

** Flexible cord must be Type SVT or equivalent, No.18 AWG. Wall plug must be a two-pole grounding type.

*** Appliance coupler, flexible cord, and wall plug must bear a "T" mark and registration number in accordance with the Japanese Dentori Law. Flexible cord must be Type VCT or VCTF, 3-conductor, 0.75 mm² conductor size. Wall plug must be a two-pole grounding type with a Japanese Industrial Standard C8303 (15 A, 125V) configuration.

Appendix B - Important Safety Instruction

Read all of these instructions, and save these instructions for later use.

- Follow all warnings and instructions marked on the product.
- Unplug this product from the wall outlet before cleaning. Do not use liquid cleaners or aerosol cleaners. Use a damp cloth for cleaning.
- Do not use this product near water. Never spill liquid of any kind on the product.
- Do not place this product on an unstable cart, stand, or table.
- Slots and openings in the cabinet are provided for ventilation. To ensure reliable operation of the product on a bed, sofa, rug, or other similar surface. This product should never be placed near or over a radiator or heat register. This product should not be placed in a built-in installation unless proper ventilation is provided.
- Before connecting this product to a power source, check that the required voltage and frequency match the available power source.
- This computer is powered by an internal battery pack or by an external AC power source, which is supplied with the computer. Use of another battery pack or AC power source may present risk of fire or explosion and may void the warranty.
- This product is equipped with a 2-wire type plug. If you are unable to insert the plug into the outlet, contact your electrician to replace your obsolete outlet.
- Do not allow anything to rest on the power cord.
- Do not place this product in a location where someone may trip over the cord.
- If an extension cord is used with this product, make sure that the total of the ampere ratings on the products plugged into the extension cord do not exceed the extension cord ampere rating. Also, make sure that the total of all products plugged into the wall outlet does not exceed 15 amperes.
- Never push objects of any kind into this product through the cabinet slots, as they may touch dangerous voltage points or short out parts; that could result in a risk of fire or electric shock.

- Except as explained elsewhere in this manual, do not attempt to service this product yourself.
- Handle batteries, CD-ROM, hard drives and any drives with care. If dropped, they may be damaged.
- Do not allow the battery to be exposed to direct sunlight for extended periods of time.
- Do not attempt to disassemble the battery. If the battery is disassembled and the electrodes are exposed, the battery may generate heat and smoke by chemical reaction.
- Do not expose the battery to moisture or chemicals.
- Charge the battery only as described in this document.
- Do not short circuit the battery terminals as the resulting high currents can damage the battery.
- The battery should not be used to power other products.
- Do not dispose of a used battery in a fire or incinerator, as an explosion may result.
- The battery should be recycled.
- Do not subject the battery to temperatures less than -20 degrees Centigrade or greater than 50 degrees Centigrade.
- Unplug this product from the wall outlet and refer problems to the service representative under the following conditions:
 - When the power cord or plug is damaged or frayed.
 - If liquid has been spilled into product.
 - If the product has been exposed to rain or water.
 - If the product does not operate normally when the operating instructions are followed, adjust only those controls that are covered by the operating instructions. Improper adjustment of other controls may result in damage.
 - If the product exhibits a distinct change in performance.
- Failure to observe any of these precautions may void your warranty.

Battery Disposal



WARNING: *Do not put rechargeable batteries or products powered by non-removable rechargeable batteries in the garbage.*

Contact your customer service representative for information on how to dispose of batteries that you cannot use or recharge any longer. Follow all local regulations when disposing of old batteries.

This page intentionally left blank.

Appendix C - Abbreviations

Your computer's documentation uses the following abbreviations:

A	Amperes	F	Fahrenheit
AC	Alternating Current	FIR	Fast Infrared
ACPI	Advanced Configuration and Power management Interface	ft	Feet
APM	Advanced Power Management	g	gram
ATA	AT attachment (refers to the hard-drive interface in an AT-compatible computer)	G	Gravity
ATAPI	AT Attachment Packet Interface	GB	Gigabytes
BBS	Bulletin Board System	hr	hour
BIOS	Basic Input/Output System	Hz	Hertz
C	Centigrade	IDE	Integrated Drive Electronics
CD	Compact Disc	in	Inches
CD-ROM	Compact Disc Read-Only Memory	I/O	Input/Output
cm	Centimeters	IrDA	Infrared Data Association
COM	Communication (as in communication port)	IRQ	Interrupt Request line
CMOS	Complementary Metal-Oxide Semiconductor	ISA	Industry Standard Architecture
DC	Direct Current	KB	Kilobytes
DMA	Direct Memory Access	kg	Kilograms
DPMS	Display Power-Management Signaling	LAN	Local-Area Network
DRAM	Dynamic Random Access Memory	lb	Pounds
DSTN	Double layer Super Twist Nematic	LBA	Logical Block Addressing
ECP	Extended Capabilities Port	LCD	Liquid-Crystal Display
EPP	Enhanced Parallel Port	m	Meters
		mA	Milliampere
		mAhr	Milliampere hour
		MB	Megabyte
		mm	millimeter
		MPEG	Motion Picture Experts Group

Appendix C - Abbreviations

MPU	Microprocessor Unit
ms	Millisecond
PDF	Portable Document Format
PC	Personal Computer
PCI	Peripheral Component Interconnect
PCMCIA	Personal Computer Memory Card International Association
POST	Power-On Self-Test
PNP	Plug and Play
PS/2	Personal System/2
RAM	Random-Access Memory
ROM	Read-Only Memory
SVGA	Super Video Graphics Array
S-VHS	Super VHS
TFT	Thin-Film Transistor
USB	Universal Serial Bus
V	Volt
VAC	Voltage Alternating Current
VCC	Voltage Collector Current
VDC	Voltage Direct Current
whr	Watt hour

Appendix D - Glossary

AC Adapter

The AC (or alternating current) adapter regulates current coming into your computer from the wall outlet. The current at the wall outlet is alternating current and needs to be changed by the adapter to DC (direct current) before your computer can use it for power.

ACPI (Advanced Configuration and Power Interface)

A method for describing hardware interfaces in terms abstract enough to allow flexible and innovative hardware implementations and concrete enough to allow shrink-wrap OS code to use such hardware interfaces.

BIOS (Basic Input/Output System)

The BIOS is software (often called firmware) that is independent of any operating system. It enables the computer to communicate with the screen, keyboard, and other peripheral devices without using programs on the hard disk.

The BIOS on your computer is flash BIOS, which means that it has been recorded on a flash memory chip that can be updated if needed.

Boot

To start your computer. A cold boot resets the entire computer and runs through all computer self-tests. A warm boot clears out computer memory only.

Boot disk

A disk containing operating system programs required to start your computer. A boot disk can be a floppy disk, hard drive, or compact disc.

Byte

The basic unit of measure for computer memory. A character—such as a letter of the alphabet—uses one byte of memory. Computer memory is often measured in kilobytes (1,024 bytes) or megabytes (1,048,576 bytes).

Each byte is made up of eight bits. For more information on bytes and bits, see an introductory book on computers.

Cache memory

Cache is very fast, zero-wait-state memory located between the microprocessor and main memory. Cache reduces the average time required by the microprocessor to get the data it needs from the main memory by storing recently accessed data in the cache.

CardBus

CardBus technology enables the computer to use 32-bit PC Cards. Hardware in the computer and the Windows 98 operating system provide support for the 32-bit cards. The voltage of 32-bit cards (3.3 volts) is lower than that of 16-bit cards (5 volts). The 32-bit cards can transmit more data at a time than the 16-bit cards, thus increasing their speed.

CMOS memory (Complementary Metal Oxide Semiconductor)

Memory that is powered by the CMOS battery. The System Setup settings and other parameters are maintained in CMOS memory. Even when you turn your computer off, the information in CMOS memory is saved.

COM port

COM stands for communication. COM ports are the serial ports in your computer.

Compact Disc

A compact disc (CD).

Appendix D - Glossary

Conventional memory

The first 640 KB of system memory. Operating systems and application programs can directly access this memory without using memory-management software.

Disk

The device used by the computer to store and retrieve information. *Disk* can refer to a floppy disk, hard disk, or CD-ROM disk.

Disk cache

A software device that accumulates copies of recently used disk sectors in RAM. The application program can then read these copies without accessing the disk. This, in turn, speeds up the performance of the application.

A cache is a buffer for transferring disk sectors in and out of RAM. Data stored in a disk cache is a copy of data already stored on the physical disk.

DMA (Direct Memory Access)

A method of transferring data from a device to memory without having the data pass through the microprocessor. Using DMA can speed up system performance.

DPMS

Display Power Management Signalling. Displays or monitors that comply with this can be managed by the Power Management features found in the system setup.

Floppy disk

A removable disk, also called *floppy* or *diskette*.

Hard drive

Also called *fixed* disk. A hard drive is connected to the computer and can be installed or removed. Data written to a hard drive remains until it is overwritten or corrupted.

The 2.5-inch hard drive in your computer was designed for use in a notebook computer. Because hard drives in notebook computers are smaller than those in desktop computers, their maximum storage capacity may be less than that of desktop hard drives. However, because of their smaller size, the drives handle shock and vibration better than larger drives, which is important for a notebook computer.

I/O (Input/output)

Refers to peripheral devices, such as printers, that are addressed through an I/O address.

I/O address

I/O stands for input/output. Peripheral devices, such as printers, are addressed through the I/O port address.

IRQ (Interrupt Request Line)

The IRQ is a hardware line that a device uses to signal the microprocessor when the device needs the microprocessor's services. The number of IRQs is limited by industry standards.

LCD (Liquid-Crystal Display)

The LCD screen on your computer differs from the display screen of a desktop monitor. Most desktop monitors use CRT (cathode-ray tube) displays, which work by moving an electron beam across phosphor dots on the back of the screen. The phosphor dots light up to show the image. LCDs use a liquid-crystal solution between two sheets of polarizing material. Electric current passing through the liquid aligns the crystals so that light can or cannot pass through them, creating an image.

Appendix D - Glossary

MB (megabyte)

1,024 kilobytes.

Megabit

1,048,576 bits or about 128 kilobytes.

Operating system

A program that supervises the computer's operation, including handling I/O. Application programs and users can request operating-system services. A user might request operation-system services to copy files or format a disk. An application program might use the operating system to obtain keyboard input, write data to a file, or write data to a screen.

PC Card (Personal Computer Card)

The Personal Computer Memory Card International Association (PCMCIA) defines the standards used to develop all PC Cards. PC Card types include: modems, Ethernet adapters, SCSI adapters, ATA cards, and memory cards.

PC slot

The PC slot is the hardware slot in the computer where the PC Card is placed.

Pixel

A pixel is an individual dot in a graphic displayed on your computer. The pixels are so close together that they look as though they are connected. An LCD screen displays thousands or millions of pixels.

Plug and Play

A plug and play operating system automatically configures computer components to work with your system. With this type of operating system, you normally do not need to set jumpers on devices or set memory addresses or IRQs.

POST (Power On Self Test)

POST is a test performed by the computer whenever you turn on the power. POST checks system integrity.

RAM (Random Access Memory)

The computer's system memory, including conventional and extended memory. You can write to and read from RAM. Information stored in RAM is temporary, and is erased when the system is turned off.

Refresh rate

The refresh rate is the rate at which the image on the LCD screen is rewritten to the screen. A fast refresh rate helps keep the image from flickering.

Resolution

The resolution is the sharpness or clarity of the image on your LCD screen. Resolution is measured by the number of pixels the computer's screen can display. For example, a resolution of 800x600 means that the screen can display 800 pixels in row and can display 600 rows. The more pixels displayed, the higher the resolution and the better the image.

ROM (Read-Only Memory)

Permanent computer memory dedicated to a particular function. For example, the instructions for starting the computer when you first turn on power are contained in ROM. You cannot write to ROM. (ROM is not the same as RAM).

Sector

Also known as *disk sector*. The portion of a track that is numbered and can hold a specified number of characters (usually 512 KB).

Shadow RAM

A write-protected area of RAM that contains a copy of the BIOS. As the computer boots, the BIOS is copied from its permanent location in ROM to RAM. The BIOS can be

Appendix D - Glossary

executed much faster in RAM than in ROM. The BIOS remains in shadow RAM until you turn off the computer.

TFT (Thin Film Transistor) LCD

A TFT LCD uses a separate transistor circuit to control each pixel. This technology provides the best resolution for an LCD screen. A TFT LCD is also sometimes called an active matrix LCD.

Zoomed video

Zoomed video technology enables zoom video PC Cards to transfer data directly from the card to video and audio systems without going through the microprocessor. This process improves video performance. Video conferencing and real-time multimedia devices, such as video cameras, are supported by zoom video.

Index

Numerics

32 Bit I/O field 80
56K 47

A

Abbreviations used in documentation 159
AC adapter 11, 15, 20, 161
 optional 63
Active Matrix Display 161
Adjusting
 brightness 22, 28
 display 22
Advanced menu, System Setup 81
Application and Driver Restore CD-ROM 137
Apply Changes 118
asterisk (*) in partition list, explained 116
Auto/airline adapter 63

B

Backing up software 137
Battery
 charge light 30
 charging 19
 CMOS (complementary metal-oxide semiconductor) 140
 conserving power 84, 139
 disposing of 42
 installing 43
 Main Battery Lights 44
 monitoring charge 44
 optional 64
 removing 42
 safety 42
 warnings 45
Battery charge light 30
Battery gauge 44
BIOS (basic input/output system) 161
Boot 161
 cold 23
 warm 23

boot code boundary 122
Boot Device Priority field 87
Boot disk 161
Boot sector
 locking 90
Brightness
 adjustment keys 22, 28
Byte 161

C

Cache memory 161
Caps Lock light 30
CardBus 58, 161
CardWizard 58, 61
CD-ROM drive
 configuring 78
 optional 67
 using 37
changes, applying 118
CMOS (complementary metal-oxide semiconductor)
 battery 140
 memory 161
Color
 8-bit 53
 16-bit 53
 24-bit 53
 32-bit 53
 depth 55
COM (communication) port 161
Commands 49
Compact discs, playing 38
compressing
 image files 104
compression
 level 104
Configuring
 computer 75
 video features 53
Connecting peripheral devices 31
Conventional memory 162
Convert 129
 FAT32 to FAT 129

Index

CPU 13
 Central Processing Unit 13
Create 121
 partition, free space required 121
Creating
 save to disk partition 97
Cursor control keys 26
Cylinders field 79

D
data
 loss, causes of 120
 protection 115
Delete 125
Deleting
 save to disk partition 98
Disassembly warning 23
Disc 161
Disk 162
disk 13
Disk cache 162
Disk sector 163
disk, physical
 selecting 117
Diskette A field 78
Diskette access field 83
Display
 adjusting 22
 TFT (thin-film transistor) 22
Disposing of battery packs 42
DMA (direct memory access) 162
Docking options 70
DOS 1, 134
drive letters
 changes to caused by using Create 121
 in partition list 116
Drivers 71
DVD-ROM drive
 configuring 78
 optional 67

E
Exit Discarding Changes field 88

Exit menu, System Setup 88
Exit Saving Changes field 88
Extended Attribute
 Ignore OS/2 EA Errors on FAT 119
Extended Memory field 80
extended partition
 deletion of 125
External monitor 54, 139

F
FAT file system
 Convert from FAT32 129
FAT32 file system 129
FDD 21
Fixed disk boot sector field 84
Flex-Bay
 CD-ROM drive 37
 hot swapping 34
 installing devices 34
 using 33
Floppy disk 162
Floppy disk controller field 82
Floppy drive
 preventing use of 90
 using 35
Format 127
free space
 displayed 116
 required to create a partition 121
Function keys 26
 Fn+F2 27
 Fn+F7 28
 Fn+F12 28
 Fn+Left Arrow 28
 Fn+Right Arrow 28

G
Glossary 161

H
hard disk
 Format 127
Hard drive 162

Index

- configuring 78
- installing 41
- locking the boot sector 90
- removing 40
- using 39

Hardware specifications 143

HDD 21

- hard disk drive 132

Heads field 79

Hot swapping 34

I

I/O (input/output) 162

I/O Device Configuration field 81

Icons

- port 32

Ignore OS/2 EA Errors on FAT 119

image files

- compressing 104
- spanning media 106

Infrared port field 82

Installed O/S field 81

Installing

- Flex-bay devices 34
- hard drive 41
- peripheral devices 31

interface

- navigating 117

IRQ (interrupt request line) 71, 162

K

Key lock key 28

Keyboard

- locking 28, 91
- using 25, 26

L

Label 126

Large Disk Access Mode field 81

LBA Mode Control field 79

LCD 12

LCD (liquid-crystal display) 162

Liquids, precautions 25

- Load Setup Defaults field 88
- Local Bus IDE adapter field 81

Locking

- floppy drive 90
- hard drive boot sector 90
- keyboard 91

M

Main menu, System Setup 77

Maximum Capacity field 79

Megabit 163

Megabyte 163

Memory

- cache 161
- CMOS (complementary metal-oxide semiconductor) 161
- conventional 162

Memory modules

- installing 65
- precautions 24
- removing 65
- sizes 64

Menus, System Setup 76

Modem 47, 49

- precautions 46
- setting resume time 87

Monitor

- external 139
- selecting type 54

mouse, selecting items with 117

Multi-Sector Transfers field 79

N

naming a partition 126

navigate interface 117

network drives, simplifying backups to 115

Num Lock light 30

Numeric keypad 27, 139

O

Operating system 163

operations

- Create 121
- Delete 125

Index

- Format 127
- Label 126
 - selecting 118
- Options 63
- OS/2 1
 - Ignore OS/2 EA Errors on FAT 119

P

- Parallel port field 82
- partition
 - applying changes to 118
 - creating 121
 - deleting 125
 - extended, deletion of 125
 - formatting 127
 - list 116
 - map 116
 - naming 126
 - selecting 118
 - status 116
 - using 64KB FAT clusters on 119
- partition list
 - drive letters in 116
 - information in 116
 - status in 116
- partition map
 - defined 116
- partitionaste
 - asterisk (*) in, explained 116
- partitions
 - resizing 110
- Password on boot field 84
- Passwords
 - for floppy drive 90
 - on boot 90
 - overview 89
- PC Card
 - 16-bit 58
 - 32-bit 58
 - CardBus 58, 161
 - CardWizard 61
 - definition 163

- installing 59
- maintaining 59
- removing 60
- rest mode 61
- slot 163
- stopping in CardWizard 61
- types 58
- using 58
- Windows 98 60
- Windows NT 60
- zoomed video 164
- Peripheral devices, connecting 31
- PHDISK 97
- physical disk 117
- Pixel 53, 163
- Playing compact discs 38
- Plug and play 163
- Port icons 32
- POST (power-on self-test) 21, 163
- Power button 20
- Power light 30
- Power Management
 - Suspend 132
- Power management
 - features 93
 - rest mode 94
 - standby mode 93
 - System Setup fields 84
- Power menu, System Setup 84
- Power on suspend mode 94
- Power Saving Mode field 85
- PowerProfiler
 - monitoring the battery 44
 - power-management features 95
- Precautions
 - operating 23
 - rest mode 94
- Preferences, PartitionMagic
 - Skip Bad Sector Checks 120
- Primary Master field 78
- Product Support Hot-line 139
- PS/2 mouse and keyboard 32

Index

PS/2 Mouse Configuration Menu 81

Q

QuietBoot Mode field 87

R

RAM (random access memory) 163

Rebooting the computer 23

Refresh rate 163

removable drives 115

Removing

 hard drive 40

resizing partitions 110

Resolution 53, 55, 163

Rest mode 94

 precautions 94

 requiring a password for resume 90

Rest Mode field 86

Rest Timeout field 85

Restarting the computer 23

restoring image files

 resizing partitions 110

Resume on Modem Ring field 86

Resume On Time field 86, 87

Resuming from rest mode 94

ROM (read-only memory) 163

S

Save to disk mode 94, 97

Save to disk partition 97

Scroll Lock key 28

Scroll Lock light 30

Secondary Master field 78

Sector 163

Sectors field 79

Security features 89

Security Menu, System Setup 83

selecting

 items with a mouse 117

 operations 118

 partitions 118

 physical disks 117

Serial port field 82

Service Pack 4 72

Set Supervisor Password field 83

Set User Password field 83

Shadow RAM (random access memory) 164

Shutting down the computer 22

Skip Bad Sector Checks 120

Smart Battery Calibration field 88

Smart Monitoring field 80

SmartBay Hotswap Utility 34

Software

 backing up 137

 hanging 140

spanning

 media-spanning feature 106

Spills, handling 25

Standby mode 93

 setting timeout for 85

 using 94

Standby Timeout field 85

Starting System Setup 75

Storing the computer 25

Summary screen field 87

Suspend 132

Suspend to disk mode 86

System Date field 77

System Memory field 80, 81

System request key 27

System resources 71

System Setup

 Advanced menu 81

 Exit menu 88

 help 77

 losing settings 140

 Main menu 77

 menus, overview 76

 overview 75

 Power menu 84

 recording settings 8, 145

 Security menu 83

 starting 75

 submenus 77

 using 77

Index

System Time field 77

T

TFT (thin film transistor) LCD (liquid crystal display) 53, 164

Tips for using the computer 23

Touchpad 29, 32

Transfer Mode field 80

Traveling with the computer 24

Troubleshooting

external monitor 139

getting help 139

LCD (liquid-crystal display) 139

numeric keypad 139

parallel device 140

serial device 140

troubleshooting

Drive Image hangs when creating an image file 101

Turning on the computer 20

TV Standard field 81

Type field 79

U

Ultra DMA Transfer Mode field 80

UPS 20

Uninterruptible Power Supply 20

V

VGA 1

Video

color depth 53

configuring 53

configuring display 54

driver capabilities 53

refresh rate 163

resolution 53, 163

Video driver

changing 56

virus turn

turn off before creating an image 101

volume 126

label 126

W

Windows 1

Windows 98

changing the video driver 56

creating a suspend partition 97

hot swapping Flex-Bay modules 34

Install 137

keys 26

PC Card 60

Windows NT 72

64KB FAT clusters 119

CardWizard 58

changing the video driver 57

creating a suspend partition 97

Install 137

PC Card 60, 61

PowerProfiler 95

X

XGA 12

Extended Graphics Array 12

Z

Zoomed video 164

Free Manuals Download Website

<http://myh66.com>

<http://usermanuals.us>

<http://www.somanuals.com>

<http://www.4manuals.cc>

<http://www.manual-lib.com>

<http://www.404manual.com>

<http://www.luxmanual.com>

<http://aubethermostatmanual.com>

Golf course search by state

<http://golfingnear.com>

Email search by domain

<http://emailbydomain.com>

Auto manuals search

<http://auto.somanuals.com>

TV manuals search

<http://tv.somanuals.com>