

Instruction Manual

HDD Digital Audio Player



HDP3202BS

FC

FCC INFORMATION

FC

This equipment has been tested and found to comply with the limits for a Class B digital device, pursuant to Part 15 of the FCC Rules. These limits are designed to provide reasonable protection against harmful interference in a residential installation. This equipment generates, uses and can radiate radio frequency energy and, if not installed and used in accordance with the instructions, may cause harmful interference to radio communications. However, there is no guarantee that interference will not occur in a particular installation. If this equipment does cause harmful interference to radio or television reception, which can be determined by turning the equipment off and on, the user is encouraged to try to correct the interference by one or more of the following measures:

- Reorient or relocate the receiving antenna.
- Increase the separation between the equipment and receiver.
- Connect the equipment into an outlet that is on a circuit different from the one the receiver is connected.
- Consult the dealer or an experienced radio / TV technician for help.

You are cautioned that any changes or modifications not expressly approved in this manual could void your authority to operate this equipment.

SAFETY PRECAUTIONS

1. The apparatus shall not be exposed to dripping or splashing and that no objects filled with liquids, such as vases, shall be placed on apparatus.
2. Mains plug is used as the disconnect device. It shall remain readily operable and should not be obstructed during intended use. To be completely disconnected the apparatus from supply mains, the mains plug of the apparatus shall be disconnected from the mains socket outlet completely.

What You Need to Know About Safety Instructions

Warning and Important Safety Instructions appearing in this manual are not meant to cover all possible conditions and situations that may occur. Common sense, caution and care must be exercised when operating, mounting, or cleaning this unit.

Always contact your dealer, distributor, service agent or manufacturer about problems or conditions you do not understand.



This is the safety alert symbol. It is used to alert you to potential personal injury hazards. Obey all safety messages that follow this symbol to avoid possible injury or death.



DANGER indicates an imminently/potentially hazardous situation which, if not avoided, will result in death or serious injury.



WARNING indicates a potentially hazardous situation which, if not avoided, may result in moderate injury or product/property damage.



CAUTION used without the safety alert symbol indicates a potentially hazardous situation which, if not avoided, may result in minor damage.

SAFETY PRECAUTIONS

DANGER

Serious injury or death can result if not handled as directed.

- Connect the AC adapter only to rated power outlet as described in the user manual.
- Do not touch the AC adapter with wet hands. If the inside or outside of the adapter gets wet, and electric shock may result.
- Do not repair, disassemble, or modify the product. Refer servicing to qualified personnel only.
- Promptly disconnect the AC adapter from the power outlet if the product produces smoke, smells, or makes unusual sounds.
- Do not use earphones or headphones while driving a vehicle, motorcycle, or riding a bicycle.

WARNING

Moderate injury or product/property damage can result if not handled as directed.

- Promptly turn the power off and disconnect the AC adapter from the power outlet during electrical storms, to avoid product damage due to excessive current surges.
- Do not place the product near sources of strong magnetism such as magnets, TVs, monitors, or speakers.
- The product should not be used near water-for example, near a bathtub, washbowl, or kitchen sink, etc.

CAUTION

Minor damage can result if not handled as directed.

- Clean by lightly wiping with a dry soft cloth. Do not use volatile chemicals on this product.
- Do not expose the product to direct sunlight or any source of heat for a long period.
- Do not place heavy objects on top of the product, to avoid product malfunction.

TABLE OF CONTENTS

FCC INFORMATION.....	1
SAFETY PRECAUTIONS.....	2
TABLE OF CONTENTS.....	4
NAMES OF EACH PART.....	5
CONNECTING THE POWER.....	8
INSTALLING THE USB DRIVER	10
USING IN PC.....	12
Using your MP3 Player without Windows Media Player 10.....	12
Using your MP3 Player with Windows Media Player 10.....	13
Synchronize tracks to the MP3 Player.....	14
Disconnecting the Player from your Computer.....	17
GETTING STARTED.....	18
PLAYING MUSIC FILES.....	19
RECORDING.....	20
SEARCHING MUSIC.....	22
PLAYLIST OPERATION.....	23
SETTING PLAY MODE.....	25
SETUP FUNCTION.....	27
Music	28
Record	29
USB	30
Back Light	31
Sleep Timer	31
Factory Reset.....	32
Format.....	32
INFORMATION.....	33
LICENSE.....	33
TROUBLESHOOTING.....	34
SPECIFICATION.....	35

NAMES OF EACH PART

Front Overview

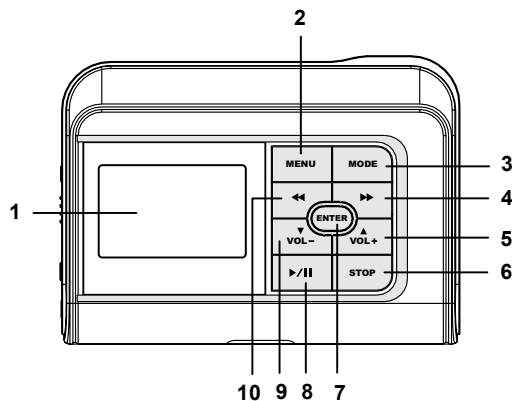

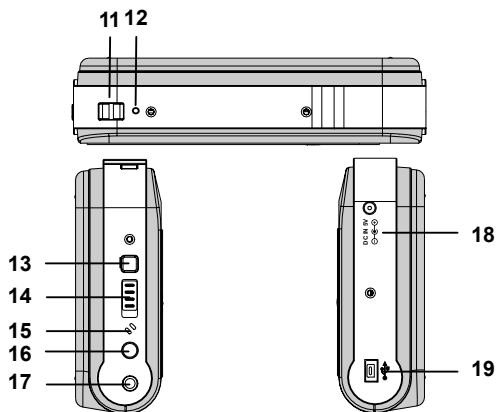

Side Overview



Function of Controls

- 1 LCD Display**
To display current status.
- 2 MENU Button**
In Music/Record display mode or during playback, press this button to go into main menu.
- 3 MODE Button**
During playback, press this button to set play mode. Or press and hold this button to set the EQ mode.
- 4 » F.F Button**
Press “»” lightly/repeatedly:
To locate the beginning of the next tracks.
Keep “»” depressed:
To go ahead at high speed.
- 5 VOLUME+/**▲**UP Button**
Increases volume or select options upward.
- 6 STOP Button**
To stop playback.
To stop current recording.
- 7 ENTER Button**
To confirm your selection or enter sub-menu.
- 8 ▶/|| PLAY/PAUSE Button**
Press this button to start playing.
Press this button to pause during playback, press it again to resume.
- 9 VOLUME-/**▼**DOWN Button**
Decreases volume or select options downward.
- 10 « R.W Button**
Press “«” lightly/repeatedly:
To locate the beginning of the current track or previous tracks.
Keep “«” depressed:
To go back at high speed.

- 
- 
- 11 STRAP MOUNT**
For buckling the strap (not included).
- 12 RESET HOLE**
For resetting the unit.
- 13 POWER Button**
Press this button to turn on/off the device.
- 14 HOLD Knob**
Slide this button to lock/unlock the buttons.
- 15 Microphone**
For voice recording.
- 16 RECORD Button**
In record mode, press this button to record some songs or others.
- 17 EARPHONE/LINE IN Jack**
For connecting the earphone to enjoy your music.
For connecting the Line-in cord to record.
- 18 Main Socket**
DC IN 5V. For connecting the AC adapter.
- 19 Min USB Port**
For connecting to your PC with supplied USB cable.

CONNECTING THE POWER

AC adapter Safety

- The uninsulated parts inside the adapter could cause electric shock. For your safety, do not open the case of the adapter.
- Read this Instruction Manual to prevent any problems that may occur while using the adapter.

WARNING

- Use the AC adapter away from water sources to avoid fire or electric shock.
- To avoid electric shock, use the adapter only with a 120V power outlet.
- Make sure that the adapter's plug is inserted all the way into the outlet.

Charging the Battery

1. Connect the supplied AC adapter plug to a power socket. AC adapter for this product is 100~240V, 50~60Hz.
2. Connect the AC adapter to 5.0V DC connector of the product.
3. When charging the battery, you may press the ►/|| PLAY/PAUSE button to play and enjoy musics.

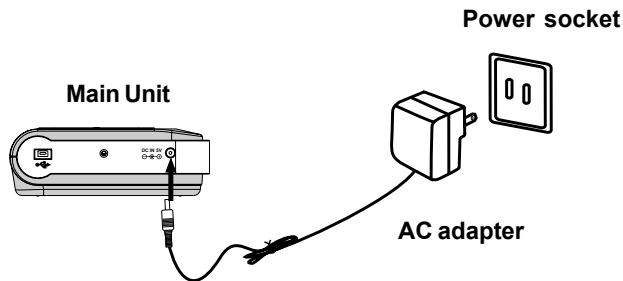

CONNECTING THE POWER

Notes:

- When the battery voltage level is low, “” will flash, and the player will power off automatically if the “Battery Low!” message appears. Please charge it.
- If a power source is connected, the product is being charged and the “Charging...” notice appears.
- If the built-in battery is fully charged, the charging process will automatically terminate and the “Battery Full” will appear.
- Battery recharge time in normal operation is approximately 3.5 hours. (It needs more than 12 hours when the battery is indicated full for the first time.)
- To prolong the life of the built-in battery, use the fully charged battery until it is completely discharged, and then fully charge it again before use. If you charge the battery that is not completely drained, the battery operating time will decrease. In this case, fully cycle (fully charge and then fully discharged) the battery several times.
- The playback time expected from one full charge is approximately 10-12 hours.

CAUTION

- To avoid the risk of fire, do not charge longer than 12 hours.
- Do not plug several devices into the same outlet.
- Overcharging will reduce the battery life.
- Do not let metallic objects, such as necklaces or coins, come into contact with the terminals (metallic parts) of the adapter.
- Do not touch the adapter with wet hands.
- Turn off the unit before unplugging the AC adapter from the product so as to avoid the product being damaged.
- When the unit is not going to be used for a long time, disconnect the AC power supply cord from the AC outlet.

INSTALLING THE USB DRIVER

Windows 98 Only

When connecting the unit to your PC (Windows 98) for the first time, the USB mass storage function will not be activated without driver installation. Please use installation CD to install the driver and follow the processes below.

1. Insert the supplied installation CD into the CD-ROM drive and connect the unit to your PC (USB port).
2. If the player is recognized by your PC, the “Add New Hardware Wizard” is activated, and click “Next”.



3. Select “Search for the best driver for your device (Recommended)”. Click “Next”.



4. Select "CD-ROM Drive" and click "Next".

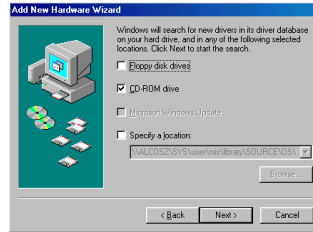

5. USB driver file is found. Click "Next".

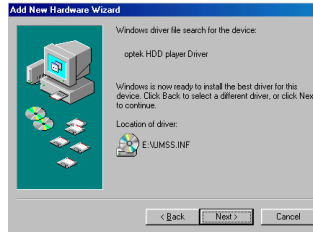

6. USB driver installation is completed, click "Finish" and restart your computer.

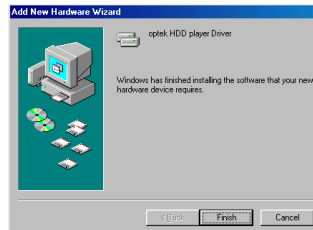

USING IN PC

No Driver is required for Windows Me/2000/XP Operating System. They will detect the Audio Player automatically after the connection with the USB port is established.

This player supports two USB modes: USB Disc & DRM Music. Please see page 30 for setting USB mode.

Mass Storage Class (USB Disc) devices can act as removable hard drives for storage of important files and information.

Media Transfer Protocol (DRM Music) is REQUIRED with the player if you want to purchase music content in Windows XP (above version SP1) from your favorite music provider. It is used to validate the licenses of existing music files as well as new music files you may have purchased from online sources.

Using your MP3 Player without Windows Media Player 10

It is unnecessary to set USB mode if you are running the Windows 98/Me/2000 operating system. After connecting the player to PC, the player will be recognized as the USB Mass Storage Device (USB Disc mode). For Windows XP without Windows Media Player 10, please set the USB mode to **USB Disc**.

1. Use the supplied USB cable to connect the unit to your PC (in USB Disc mode).
2. Open Windows Explorer and an additional drive will be listed as "Removable Disk". (In Windows Me/2000/XP, the  icon appears on the bottom of the desktop.)



Note: It might take several seconds for the device to be detected, especially in Windows2000/XP. Click Refresh in *My Computer* to make sure the device has been detected.

3. Transferring Files to the MP3 Player (in USB Disc mode)

- From Windows Explorer, highlight all files or folders you want to transfer and copy to the “Removable Disk” drive.
- Once all files/folders appear on the “Removable Disk” drive, the transferring is complete.

Note: The device is capable of transferring files at hi-speed mode of USB 2.0. If USB 2.0 port is available on your computer, use it to connect to your device. The device is still compatible with the older USB 1.1 ports. However, you will not be able to take full advantage of the potential speed increase.

Using your MP3 Player with Windows Media Player 10

This player supports for Digital Rights Management (DRM) to enable networked devices to access content acquired from a host of online music services. Windows Media Player 10 and Windows XP (above version SP1) PC are required for the device to properly function when in the DRM Music mode.

- You can download Windows Media Player 10 from Microsoft by going to www.microsoft.com/windows/windowsmedia/download/default.asp.
1. Set the USB mode to **DRM Music**.
 - If you set the USB mode to **USB Disc**, it will act as removable hard drives for storage of the files.
 2. Use the supplied USB cable to connect the player to your PC.
 3. Open Windows Explorer and an additional drive will be listed as “Portable Media Player”.
 4. Open the drive and the “Data” & “Media” folders will appear.



Note: Do not transfer media files to the **Data** folder, as the unit can not recognize the media files of the **Data** folder.

Do You Want to buy Musics from an Online Service?

You may download musics from an online service (such as, Napster, MusicNow). It is necessary to sign in to your account to perform certain functions in the online service you selected.

You may visit <http://windows/windowsmedia/mp10/onlinestores.aspx> for details. Below is an example for your reference.

1. Login to the online service (example, Napster).
2. Search for music on the online service.
3. Select the tracks you would like to download and click the “**download**” button in the track list or right click and choose **download track(s)**.
4. The track(s) will begin downloading to your PC.

Synchronize tracks to the MP3 Player

1. Open Windows Media Player10.
 - a) Click the **Library** tab from the menu bar on the top of the Windows Media Player screen.
 - b) All songs purchased from online services should be listed in Windows Media Library.

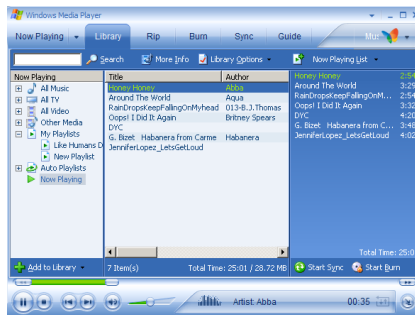

5. Locate a song in the Library and Right-Click on it. Select “Add to -> Sync List”, then the song will be added to “Sync List”. Repeat and add other songs.

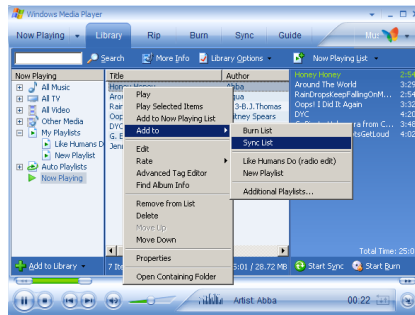

6. Click **Sync** and the “Sync List” pane appears. Select the “Portable Media Player” from the dropdown list on the right side of this screen.

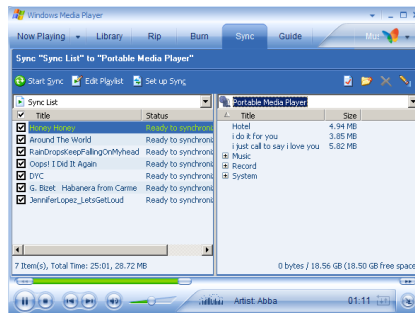

7. Click “Start Sync” to transfer the songs. A progress indicator will show each file transferring.

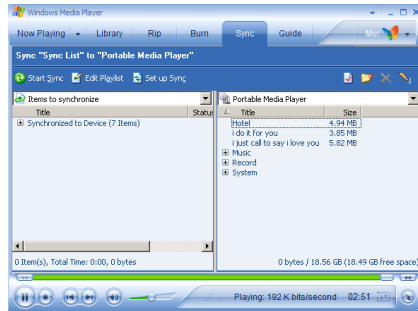

After transferring, the notice message “Synchronized to Device (7 items)” appears on the left side of the screen. Total 7 songs are synchronized to player.

Disconnecting the Player from your Computer

◆ Windows 98:

- 1) After use, you can directly unplug the device.
- 2) The "Removable Disk" disappears on the screen of your computer.

◆ Windows XP (in DRM Music mode)

- 1) After use, you can directly unplug the device.
- 2) The "Portable Media Player" disappears on the screen of your computer.

◆ Windows Me/2000/XP(Such as Windows 2000):

- 1) Move the mouse to the  icon on the bottom of the desktop, and the "Unplug or Eject Hardware" message appears on the display as below:

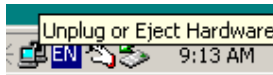

- 2) Click the  icon and the "Stop USB Mass Storage Device" message is shown as below:



- 3) Click the "Stop USB Mass Storage Device" message and pops up the notice message as below:

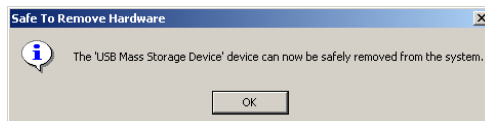

- 4) Click "OK", and then you can unplug the unit safely.

GETTING STARTED

Power On

1. Press the **POWER** button to power on the player.

Note: If the onscreen message says "Key Locked !" and then shuts off, you need to locate the HOLD knob on the side of the device (see HOLD function below for details).

3. The startup screen will appear briefly.
4. After a few seconds, the main menu is displayed.

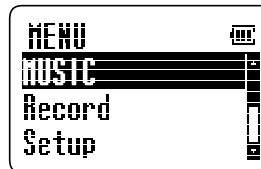
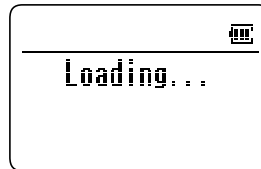

Power Off

1. Press the **POWER** button to power off the player. Or
2. Press and hold the **STOP** button to power off the player.

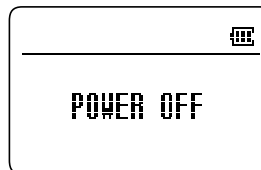

Hold Function

HOLD function is used for preventing wrong operation during playback.

Locking Buttons

- To lock all function buttons by sliding the **HOLD** knob to right, and the "Key Locked" dialog box appears briefly. Then all function buttons are disabled.

Note: After locking, the notice message "Switch [HOLD] to Unlock" will appear on the display if any button (except the **POWER** button) is pressed.

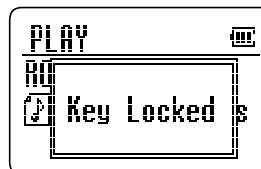

Unlock Buttons

- To release all function buttons by sliding the **HOLD** knob to left, and the "Cancel Lock" dialog box appears briefly.

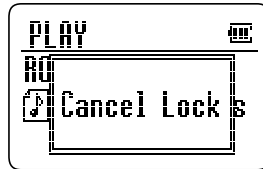

PLAYING MUSIC FILES

1. Connect the earphone to the player.

2. Press the **POWER** button to power on the player.

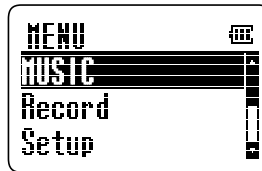

3. Press the "**▼**" or "**▲**" button to select and highlight the **MUSIC** item in the main menu, then press **ENTER** button.

4. Press the "**▼**" or "**▲**" button to select and highlight the **PLAY/RESUME** item.

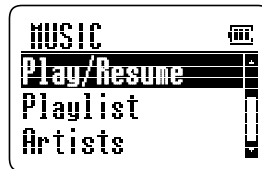

5. Press **▶/||** **PLAY/PAUSE** button to start playing. If the **ENTER** or "**▶**" button is pressed, it will also start playing.



Volume Control

- Press the "**▼**" or "**▲**" button to adjust volume.

To Skip a Track

- During playback, you can skip a track by pressing the “◀” or “▶” button. Each press skips one track. The first press on the skip backward “◀” button goes to the beginning of the current track.
- It will start playing automatically after a desired track is searched.

Fast Forward / Backward

- Press and hold the “▶▶” button will go fast forward during playback.
- Press and hold the “◀◀” button will go fast backward during playback.

To Pause Playback

- Press the “▶||” button to pause.
- Press the “▶||” button again to resume play.

To Stop Playback

- Press the STOP button to stop playback.

RECORDING

Before recording, you should set the record mode (Microphone & Line In). Please see page 29 for details.

Recording via Microphone

1. Set the record mode to **Microphone**, then go back to the main menu.
2. Press the “▼” or “▲” button to select the **Record** item in the main menu, then press the **ENTER** button.
3. Press the **REC** button to start recording.
4. Press the **STOP** button to stop recording, then the record file appears in the record folder.

Note: If there is not any recording files in the unit, the **Record** folder will not appear in the record menu.

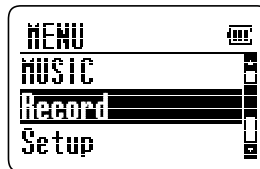

Recording via Line In

1. Set the record mode to **Line In**, then go back to the main menu.
2. Connect the Line-Out or earphone jack of the external device to the earphone jack of the unit with the **Line-In** cord (not included).
3. Press the “**vol-**” or “**vol+**” button to select the **Record** item in the main menu, then press the **ENTER** button.
4. Press the **REC** button to start recording.
5. Press the **STOP** button to stop the recording, then the record file appears in the record folder.

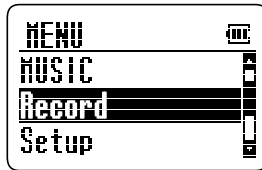

Playing the Recorded Files

1. Connect the earphone to the player.
2. Press the “**vol-**” or “**vol+**” button to select the **Record** item in main menu and press the **ENTER** button.
3. Open the **Record** folder by pressing the **ENTER** button. (If there is not any recording files in the unit, the **Record** folder will not be shown.)
4. Press the “**vol-**” or “**vol+**” button to select the recorded files.
5. Press the **▶/|| PLAY/PAUSE** button to start playing.

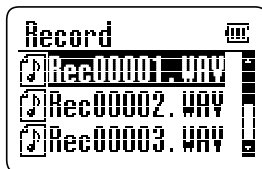

SEARCHING MUSIC

After downloading some musics, the system will categorize all songs automatically.

1. Press the “**▼** VOL-” or “**▲** VOL+” button to select and highlight the **MUSIC** item in the main menu, then press the **ENTER** button.
2. Press the “**▼** VOL-” or “**▲** VOL+” button to select the desired search method. **Playlist, Artists, Titles, Albums, Genres, and Folder/Files** are supported as options.
3. Press the **ENTER** or “**▶**” button to confirm (For example, select the **Artists** item), and the artist names will display in the **Artists**.
4. Select an artist name by pressing the “**▼** VOL-” or “**▲** VOL+” button.
5. Press the **▶/|| PLAY/PAUSE** button to start playing. Or go into the sub artists folder by pressing the **ENTER** button.
 - If there are no further sub folders for selection, the track selected will be stored into playlist after the **ENTER** button is pressed.
 - For more playlist operation details, please refer to page 23.

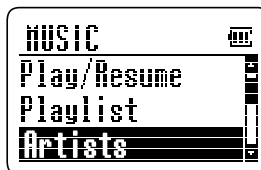

Note: Press the “**◀**” button in a sub menu to go back to the previous menu.

PLAYLIST OPERATION

User can select favorite music and add to playlist or delete music from playlist.

Add Files to Playlist

1. First, search your favorite musics.
(Please refer to page 22 details about how to search the music files.)
2. Select a favorite track and press the **ENTER** button, then "Added to Playlist" appears on the display.
 - This track is stored into the playlist.
3. Press the **ENTER** button again and this track will be deleted from the playlist.

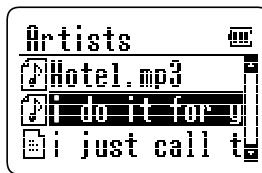



Delete Files from Playlist

1. Go into the playlist folder and select a track.
2. Press the **ENTER** button, then "Delete? Y: ENTER" appears on the display.
3. Press the **ENTER** button again to confirm, and this track is deleted from the playlist.

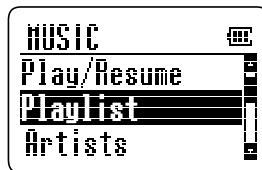



Or,



1. Go into the other music folder (except playlist folder) and the “” icon indicates that this track is added to the playlist.
2. Select a track marked the “” icon and press the **ENTER** button, then “Deleted from Playlist” appears on the display.
3. This track is deleted from the playlist.



Playing Your Favorite Music (Playlist Files)

1. Go into the **Playlist**, select a desired track by pressing the “” or “” button.
 2. Press the **▶/|| PLAY/PAUSE** button to start playing.
- Or,
1. Go into the other music folder (except playlist folder) and the “” icon indicates that this track is added to the playlist.
 2. Press the “” or “” button to select a track added to the playlist.
 3. Press the **▶/|| PLAY/PAUSE** button to start playing.

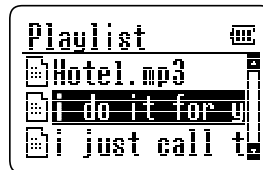
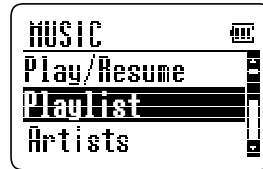

SETTING PLAY MODE

The device supports a variety of play modes. During playback, you may directly set your desired play mode.

1. During playback, press the **MODE** button and it pops up the *Mode* menu.
2. Press the “**VOL-**” or “**VOL+**” button to select your desired mode.
3. Press the **ENTER** or “**▶▶**” button once to confirm.

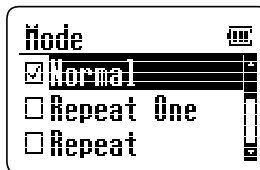

Note: It's not available to set play mode via pressing the **MODE** button while playing recorded files.

The modes are changed in the following cycle: Normal -> Repeat One -> Repeat -> Repeat All -> Shuffle -> Shuffle All

Normal

1. In the *Mode* menu, press the “**VOL-**” or “**VOL+**” button to select and highlight *Normal* item.
2. Press the **ENTER** button to confirm.
 - All tracks will be played from beginning to end.
 - Default is the normal mode.

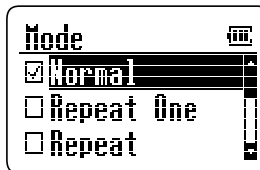

Repeat One

1. In the *Mode* menu, press the “**VOL-**” or “**VOL+**” button to select and highlight *Repeat One* item.
2. Press the **ENTER** button to confirm.
 - The “**⏮**” and “**⏭**” icons will appear on the display.
 - The current track will be played repeatedly.
 - To select a desired track to be played repeatedly by pressing the “**⏮**” or “**⏭**” button.

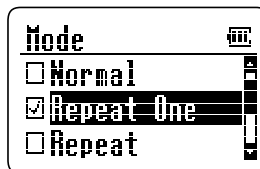

Repeat- *Playing repeatedly all tracks of the current folder*

1. In the **Mode** menu, press the “**▼VOL-**” or “**▲VOL+**” button to select and highlight **Repeat** item.
2. Press the **ENTER** button once to confirm.
 - The “**🔁**” icon appears on the display.
 - All tracks of the current folder will be played repeatedly.

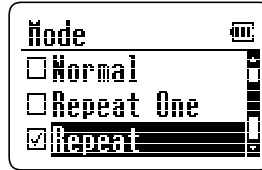

Repeat All- *Playing repeatedly all tracks of all folders*

1. In the **Mode** menu, press the “**▼VOL-**” or “**▲VOL+**” button to select and highlight **Repeat All** item.
2. Press the **ENTER** button once to confirm.
 - The “**🔁**” and “**@**” icons appear on the display.
 - All tracks will be played repeatedly.

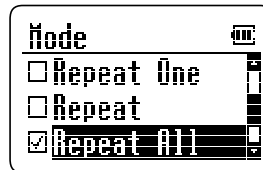

Shuffle- *Playing all tracks of the current folder in random order*

1. In the **Mode** menu, press the “**▼VOL-**” or “**▲VOL+**” button to select and highlight **Shuffle** item.
2. Press the **ENTER** button once to confirm.
 - The “**🎲**” icon appears on the display.
 - All tracks of the current folder will be played without sequence.
 - To locate another track: press the “**⏮**” or “**⏭**” button. The first press on the skip backward “**⏮**” button goes to the beginning of the current track.

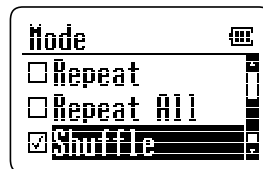

Shuffle All - Playing all tracks of all folders in random order

1. In the **Mode** menu, press the “**▼ VOL-**” or “**▲ VOL+**” button to select and highlight the **Shuffle All** item.
2. Press the **ENTER** button once to confirm.
 - The “**◆**” and “**⊗**” icons appear on the display.
 - All tracks of all folders will be played without sequence.
 - To locate another track: press the “**◀**” or “**▶**” button. The first press on the skip backward the “**◀**” button goes to the beginning of the current track.

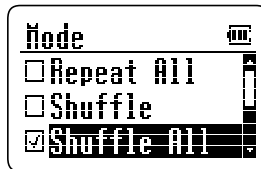

SETTING EQ MODE

The player supports a wide variety of equalizer and sound effect. During playback, you may directly select your desired EQ mode.

1. During playback, press and hold the **MODE** button until the **EQ** menu appears.
2. Press the “**▼ VOL-**” or “**▲ VOL+**” button to select your desired mode.
3. Press the **ENTER** or “**▶**” button to confirm.
 - The EQ modes are changed in the following cycle: Normal->Bass->Classic->Rock->Jazz->Pop

Note: It's not available to set EQ mode via pressing and holding the **MODE** button while playing recorded files.

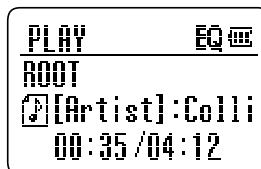
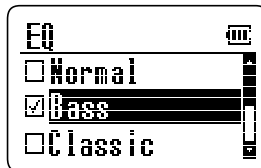

SETUP OPERATION

The setup includes: Music, Record, USB, Back Light, Sleep Timer, Factory RST and Format. Use the **Setup** features to set detailed options for each function.

1. Press the **POWER** button to power on the player.
2. Press the “**vol-**” or “**vol+**” button to select and highlight the **Setup** item in the main menu.
3. Press the **ENTER** or “**▶▶**” button.



The menu diagram of the setup shows as below:

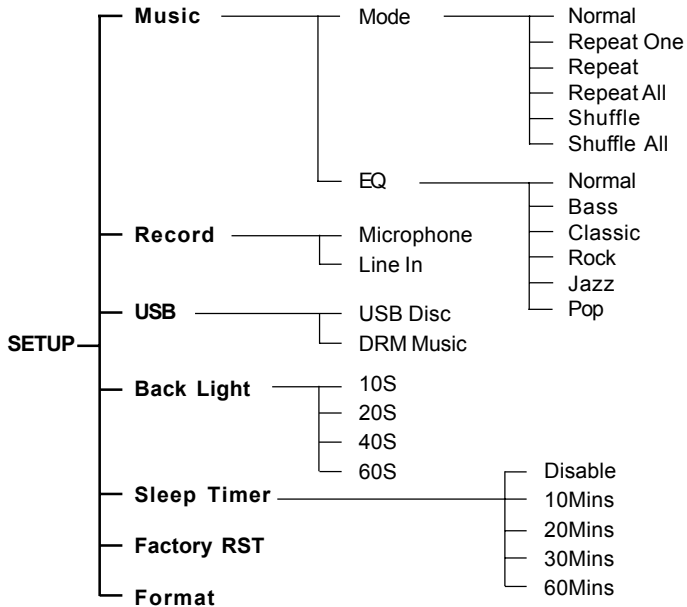

MUSIC SETUP

1. In the setup menu, press the “VOL-” or “VOL+” button to select and highlight the **Music** item.
2. Press the **ENTER** or “▶” button.
 - It includes: Mode & EQ.

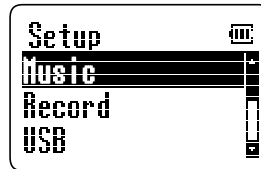

Mode (Play Mode)

1. Press the “VOL-” or “VOL+” button to select and highlight the **Mode** item.
2. Press the **ENTER** or “▶” button.
 - Please refer to page 25 for details.

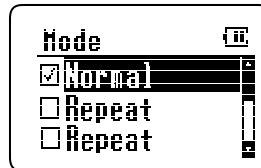
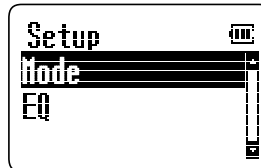

EQ (EQ Setup)

1. Press the “VOL-” or “VOL+” button to select and highlight **EQ** item.
2. Press the **ENTER** or “▶” button.
3. Press the “VOL-” or “VOL+” button to select your desired EQ mode.
4. Press the **ENTER** or “▶” button to confirm.
5. Press the “◀” button to return.
 - The EQ modes are changed in the following cycle: Normal->Bass->Classic->Rock->Jazz->Pop

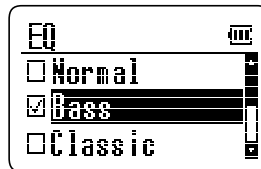
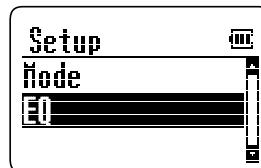

RECORD SETUP

1. In the setup menu, press the “**▼**” or “**▲**” button to select and highlight the **Record** item.
2. Press the **ENTER** or “**▶**” button.
3. Press the “**▼**” or “**▲**” button to select **Microphone** or **Line In**.
4. Press the **ENTER** or “**▶**” button to confirm.

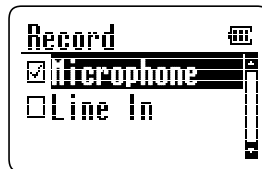
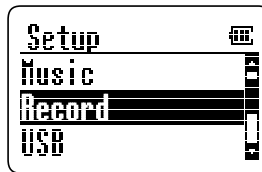

USB SETUP

1. In the setup menu, press the “**▼**” or “**▲**” button to select and highlight the **USB** item.
 2. Press the **ENTER** or “**▶**” button.
 3. Press the “**▼**” or “**▲**” button to select **USB Disc** or **DRM Music**.
 4. Press the **ENTER** or “**▶**” button to confirm.
- USB Disk mode stands for Mass Storage Class.
 - DRM Music mode stands for Digital Rights Management (Media Transfer Protocol).
 - Refer to page 12 for details.

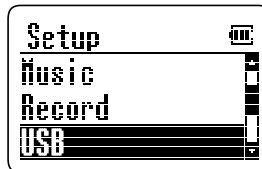

BACKLIGHT SETUP

1. In the setup menu, press the “**▼**” or “**▲**” button to select and highlight the **Back Light** item.
2. Press the **ENTER** or “**▶**” button.
3. Press the “**▼**” or “**▲**” button to select the time of the backlight.
4. Press the **ENTER** or “**▶**” button to confirm.
 - It includes four options: 10S, 20S, 40S and 60S.
 - The LCD backlight will remain on for 10, 20, 40 or 60 seconds as your setting.

Note: Excessive use of the backlight will cause the battery to discharge more quickly.

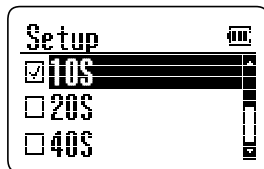
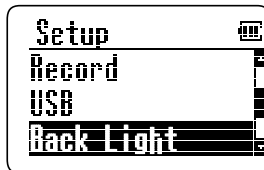

SLEEP TIMER SETUP

1. In the setup menu, press the “**▼**” or “**▲**” button select and highlight the **Sleep Timer** item. Then press the **ENTER** or “**▶**” button.
2. Press the “**▼**” or “**▲**” button to select the sleep time.
3. Press the **ENTER** or “**▶**” button to confirm.
 - It includes five options: Disable, 10Mins, 20Mins, 30Mins and 60Mins.
 - After setting the sleep time, it will automatically power off when the sleep time reaches.
 - To clear the sleep time by setting it to **Disable**.

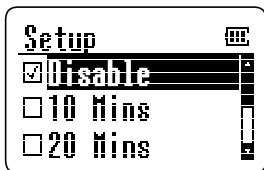

FACTORY RESET

To restore the unit to the factory default settings.

1. In the setup menu, press the “**vol-**” or “**vol+**” button to select and highlight the **Factory RST** item.
2. Press the **ENTER** or “**▶▶**” button to confirm.



Note: The data of the unit will still remain after this function is performed.

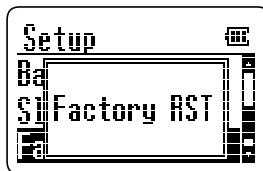

FORMAT

1. In the setup menu, press the “**vol-**” or “**vol+**” button select and highlight the **Format** item.
2. Press the **ENTER** or “**▶▶**” button and the notice message “Format Y: Enter” appears on the display.
3. Press the **ENTER** button to start the format. Or press other buttons (except the **ENTER** button) to cancel the format.

Notes:

- After formatting, all contents of the player will be erased.
- Don't format the player in your computer.

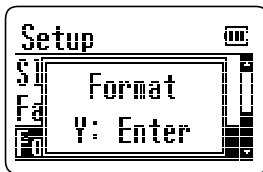

INFORMATION

1. Press the **POWER** button to turn the power on.
2. Press the “**▼VOL-**” or “**▲VOL+**” button to select and highlight the **Information** item in the main menu.
3. Press the **ENTER** button and the memory information will appear on the display.
 - Press the “**◀**” button to go back to main menu.

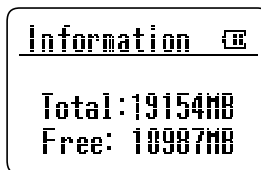

LICENSE

When you download (purchase) the musics online, the License (or ID) of the musics will be stored into the unit and it will take some space of the unit. If you remove the musics from your unit, the License of the musics will still remain. So you should use the License function to delete them.

1. Press the “**▼VOL-**” or “**▲VOL+**” button to select and highlight the **MUSICS** item in the main menu and press the **ENTER** button.
2. Press the “**▼VOL-**” or “**▲VOL+**” button to select and highlight **LICENSE** and press **ENTER** button, then **Maintain** appears.
3. Press **ENTER** button and the notice message “Y: Enter N: Other” appears.
 - Press the **ENTER** button to confirm.
 - Press other buttons (except **ENTER** button) to exit.

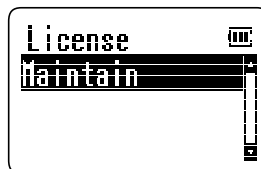
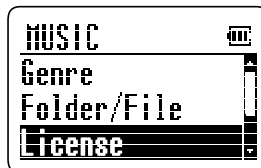

Note: Press the “**◀**” button to return to the previous menu.

TROUBLESHOOTING

Should any problem persists after you have made the following checks, please consult your nearest service facility.

The device can not power on.

- Check if the built-in battery is discharged.
Connect the AC adapter to recharge.

No sound

- Check if the volume level is 0. Adjust the volume control.
- The headphones/earphones plug is not firmly connected to the "Phone" jack.

The player does not work.

- Make sure the Hold knob is in the off position.
- Reset the Player.

The files cannot be played normally.

- Check if there are MP3 or WMA files on the player.
- Check if the audio files are corrupted.

The device can not appear on the computer as a drive.

- Check if the USB cable is correctly connected.
- Check the USB control in BIOS and ensure it is enabled.

Heavy noise

- Check if plug of the earphone is clean. Dirty plug may cause the noise.
- Check the music file. If the file data is damaged, heavy noise or skipping may result. Try another music file to confirm.

The unit appears locked up after unplugging the USB cable:

- If your unit has stored a large number of music files, it can take up to 5 minutes to complete it's processes after unplugging the USB cable. This can be avoided by switching the unit OFF before unplugging the cable.

SPECIFICATION

Type	Item	Specification
HDD	Capacity	20GB
PC	Operating System	Windows 98/ME/2000/XP
	Interface	USB 2.0
Audio	Frequency	20Hz~20KHz
	Headphone Output	15mW (32Ω)
	Signal to Noise ratio	90dB
Files	File format	MP3, WMA, WMA-DRM
Power Supply	AC adapter	DC 5.0V
	Built-in Rechargeable Battery Capacity	1100mAh
General	Dimension	Approx. 122mmx89mmx30mm (W x D x H)
	Weight	Approx. 260g

Design and specifications are subject to change without notice!

Please check and identify the supplied accessories.

- AC Adapter** x 1
- USB Cord** x 1
- Earphones** x 1
- Installation CD** x 1



811-340291-010

Free Manuals Download Website

<http://myh66.com>

<http://usermanuals.us>

<http://www.somanuals.com>

<http://www.4manuals.cc>

<http://www.manual-lib.com>

<http://www.404manual.com>

<http://www.luxmanual.com>

<http://aubethermostatmanual.com>

Golf course search by state

<http://golfingnear.com>

Email search by domain

<http://emailbydomain.com>

Auto manuals search

<http://auto.somanuals.com>

TV manuals search

<http://tv.somanuals.com>