

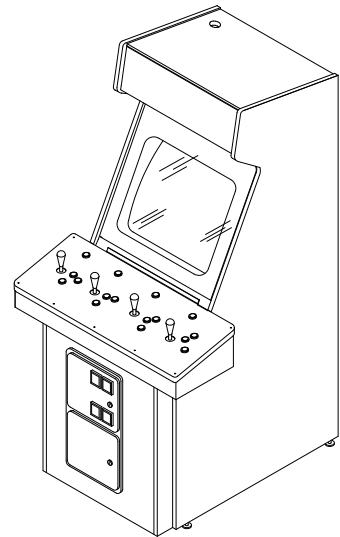

<http://www.midway.com>

**4-PLAYER, 25"  
DEDICATED  
VIDEO GAME**



TM



***Operation  
Manual***

● Installing ● Operating ● Testing ● Parts ● Wiring Diagrams ● Troubleshooting

---

MIDWAY GAMES INC., 3401 North California Avenue, Chicago, Illinois 60618-5899 USA



# SPORTSTATION™

## CHAPTER ONE

### SAFETY, SPECIFICATIONS, INSPECTION & INSTALLATION



**NOTICE:** This manual is subject to change without notice. MIDWAY reserves the right to make improvements in equipment function, design, or components as progress in engineering or manufacturing methods may warrant.

Fill out and mail in the Game Information Card. Include the game serial number from the label on the rear of the cabinet. For your records, write the game serial number in the manual.

SERIAL NUMBER \_\_\_\_\_

# SAFETY INSTRUCTIONS

The following safety instructions apply to operators and service personnel. Read these instructions before preparing your game for play. Other safety instructions appear throughout this manual.





## DEFINITIONS OF SAFETY TERMS





**DANGER** indicates an imminent hazard. If you fail to avoid this hazard, it **WILL** cause death or serious injury.

**WARNING** indicates a potential hazard. If you fail to avoid this hazard, it **COULD** cause death or serious injury.

**CAUTION** indicates a potential hazard. If you fail to avoid this hazard, it **MAY** cause minor or moderate injury. **CAUTION** also alerts you about unsafe practices.

**NOTICE** indicates information of special importance.

	<p><b>WARNING: TRANSPORTING GAMES.</b> This game contains glass and fragile electronic devices. Use appropriate care when transporting this game. Avoid rough handling when moving the cabinet. Don't move this game with the power on.</p>
	<p><b>WARNING: DISCONNECT POWER.</b> Always turn the power OFF and unplug the game before attempting service or adjustments. Installing or repairing PC boards with power ON can damage components and void the warranty. Be sure that you securely install ground wires.</p>
	<p><b>WARNING: GROUND GAMES.</b> Avoid electrical shocks! Don't plug in a game until you have inspected and properly grounded it. Only plug this game into a grounded, three-wire outlet. Don't use a "cheater" plug, or cut off the ground pin on the line cord.</p>
	<p><b>WARNING: HAZARD TO EPILEPTICS.</b> A small portion of the population has a condition which may cause epileptic seizures or momentary loss of consciousness when viewing certain kinds of flashing lights or patterns that are present in our daily environment. These persons may experience seizures while watching some kinds of television pictures or playing certain video games. People who have not had seizures may nonetheless have an undetected epileptic condition.</p> <p>If you or anyone in your family has experienced symptoms linked to an epileptic condition (e.g., seizures or loss of awareness), consult your physician before using video games.</p> <p>We recommend that parents observe their children while they play video games. If you or your child experience the following symptoms: dizziness, altered vision, eye or muscle twitching, involuntary movements, loss of awareness, disorientation, or convulsions, <i>discontinue use immediately</i> and consult your physician.</p>
	<p><b>WARNING: AVOID ELECTRICAL SHOCKS.</b> This video game system does not utilize an isolation transformer. Internal, cabinet AC isn't isolated from the external, AC line.</p>

	<p><b>WARNING: HANDLE FLUORESCENT TUBE AND CRT WITH CARE.</b> If you drop a fluorescent tube or CRT and it breaks, it will implode! Shattered glass can fly eight feet or more from the implosion.</p>
	<p><b>CAUTION: CHECK POWER SELECTOR, LAMP.</b> Set the 110/220VAC selector on the power supply for the correct line voltage. Check the selector setting before switching on the game. Verify that the fluorescent lamp assembly is correct for the local line voltage.</p>
	<p><b>CAUTION: USE PROPER FUSE.</b> Avoid electrical shock! Replacement fuses must be of the same type as those they replace. Fuse voltage and current ratings must match ratings on the original fuse.</p>
	<p><b>CAUTION: ATTACH CONNECTORS PROPERLY.</b> Be sure that printed circuit board (PCB) connectors mate properly. If connectors don't slip on easily, don't force them. A reversed connector may damage your game and void the warranty. Connector keys only allow a connector to fit one set of pins on a board.</p>
	<p><b>CAUTION: TAKE CARE WHEN SHIPPING HARD DISKS.</b> The hard disk drive must be packed in an anti-static bag. When shipping the drive for repair or replacement, pack it in an approved container (P/N 08-8068). Never stack or drop hard disk drives.</p>

## PRODUCT SPECIFICATIONS

### Operating Requirements

<u>Location</u>	<u>Electrical Power</u>	<u>Temperature</u>	<u>Humidity</u>
Domestic	120VAC @ 60Hz 3.0 Amps	32°F to 100°F	Not to exceed 95% relative
Foreign	230VAC @ 50Hz 2.0 Amps	(0°C to 38°C)	
Japan	100VAC @ 50Hz 3.0 Amps		

### Cabinet Statistics

<u>Shipping Dimensions (One Piece)</u>		<u>Shipping Weight</u>	<u>Design Type</u>
Carton	Main Cabinet    Player Control Panel	Approx. 385 Lbs. (175 kg.)	Dedicated Video Game with 49-Way, Optodetector Joysticks
Width	29" (73.7 cm)    37" (94.0 cm)		
Depth	43" (109.2 cm)    13" (33.0 cm)		
Height	75" (190.5 cm)    7" (17.8 cm)		

### Equipment Characteristics

<u>Video Display Monitor</u>	<u>Audio System</u>	<u>Currency Acceptors</u>
Medium Resolution RGB 25" (63.5 cm) CRT	Digital Stereo Sound 5" (12.7 cm) Coaxial, Full-Range Speakers	2 Coin Mechanisms Dollar Bill Validator Ready Electronic Coin Acceptor Ready

### Game Characteristics

<u>Player Variables</u>	<u>Operator Variables</u>	<u>Diagnostics</u>
1 to 4 players per game High Score Recognition	Coinage, Play Mode, Difficulty, Volume, Audits, Statistics	Automatic Power-Up Self-Test Manual, Multi-Level Menu System

---

---

## INSTALLATION & INSPECTION

### INSTALL THE CONTROL PANEL



**WARNING:** The cabinet is top heavy. Use the two handles when moving the cabinet.

1. Remove all items from the shipping containers and set them aside. Inspect the exterior of the cabinet, and control panel for damage. Pay special attention to cabinet edges, seams, and corners.
2. Remove and save the screws at the top and sides of the rear door. Unlock the rear door, then lift it off the cabinet. Set the rear door aside. Inspect the cabinet interior for signs of damage. Check all major assemblies to assure that they mount securely. Check the joysticks for signs of damage.
3. The coin door keys are on a key hook inside the cabinet. Unlock and open the coin door. Cash box door and rear door keys are on a key hook attached to the rear of the coin door. Unlock and open the cash box door. Remove the spare parts stored in the cash box.
4. Find the leg levelers and nuts in the spare parts bag. Install one nut onto each leg leveler. Hand-turn the nut against the base of the leg leveler. Install one leveler with its nut into the threaded hole in each corner of the cabinet. Turn the levelers all the way into the holes, but don't tighten the levelers.
5. Unpack the player control panel. Place the player panel on the cabinet above the coin door. Open the player panel. Align panel-mounting holes with holes in the cabinet. Install bolts with washers (two in back; two on the bottom). Connect wiring harnesses to P1, P2, and P8 on the I-40 Joystick Interface Board. Close the player panel. Reach up through the open coin door and lock both latches.

6. Refer to the Cabinet Wiring Diagram (Chapter 5). Check to see that cable connectors are correctly secured. *Don't force connectors. They're keyed to fit in only one location.* Bent pins and reversed connections may damage your game and void the warranty.
7. You can install an extra padlock to secure the rear door. You'll find a hasp in the spare parts bag. Remove the two lock bracket nuts from inside the cabinet, above the rear door opening. Slide the hasp onto the bolts so that it protrudes from the hole in back of the cabinet. Reinstall nuts and tighten.
8. Modify the lock plate at the top of the rear door. Remove the bolts and nuts from the lock plate. Rotate the plate so that the slot will be above the door. Reinstall the bolts and nuts and tighten firmly.

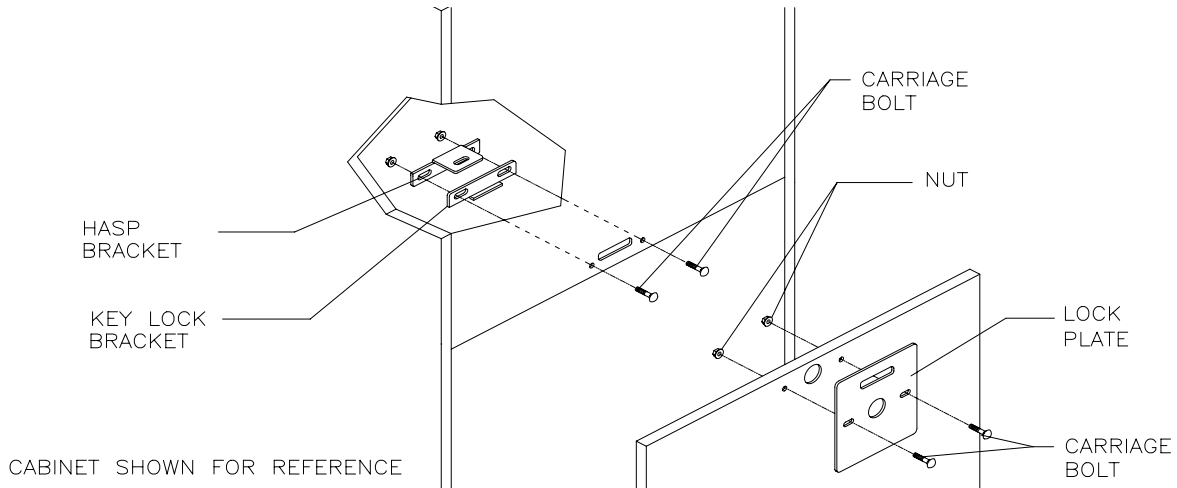

### INSTALL THE DOOR LOCK AND SECURITY BRACKETS

9. The power cord is with the spare parts. Remove and save four screws from the line cord cover plate at the rear of the cabinet. Match the holes on the IEC plug with the prongs in the receptacle. Push the plug firmly to seat it. Route the cord away from cabinet wheels and foot traffic areas. Hang excess cord on the plastic clip near the vent.

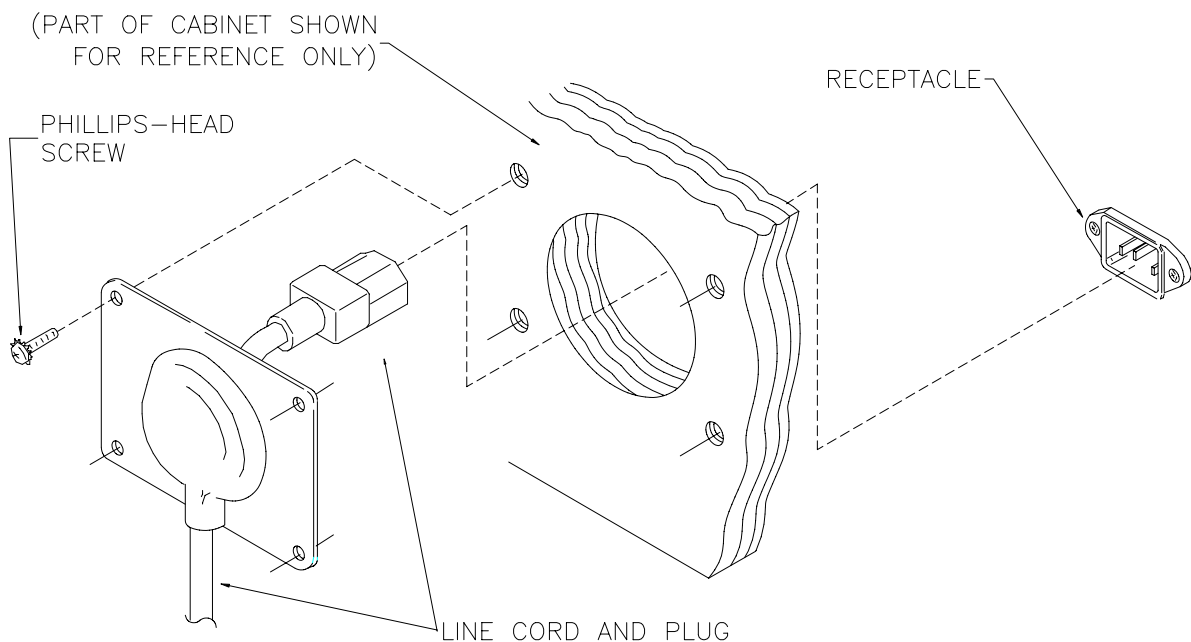

## INSTALL THE LINE CORD



**CAUTION: CHECK POWER SUPPLY LINE VOLTAGE SELECTOR SWITCH.** Set the 110/220 VAC selector on the power supply for the correct local line voltage. Check the selector setting before switching on the game.

10. Reinstall the rear door and close it. Lock the rear door and remove the key. If required, install the extra padlock through the hasp. Install the screws at the top and sides of the rear door. Tighten the screws snugly. Close and lock the cash box and coin doors.



**NOTICE:** Tamper-resistant screws and a matching wrench are provided with this game for additional security. Four tamper-resistant screws and four wrenches are located in the spare parts bag. If desired, replace the original screws with the tamper-resistant screws. Tighten the screws firmly with the wrench.

11. Move the game to its play location. Lower each leg leveler until the cabinet is stable and level. Adjust the levelers as required to raise wheels and distribute weight equally on each corner. Tighten the nuts.
12. Plug the game into a grounded (3-terminal) AC wall outlet. Switch on the game, using the on/off switch at the top-left rear of the cabinet. The game will power up and begin self-diagnostics. If diagnostics find no errors, the game enters its Attract Mode of operation. Unlock and open the coin door. Locate the control switches. Press TEST MODE to enter the Menu System.
13. Select "MONITOR SETUP" at the Diagnostics Menu. Confirm proper video display operation and adjust the monitor as necessary.
14. Select "DISK TESTS" at the Diagnostics Menu. Run all the tests in order to verify correct drive operation.
15. Select "SWITCH TESTS" at the Diagnostics Menu. Check to be sure that all control switches work.
16. Select "DIP-SWITCH TESTS" at the Diagnostics Menu. Verify that all switches are set to optimum positions for this game.
17. Select "SPEAKER TEST" at the Diagnostics Menu. Verify operation of audio system components.
18. Select "EXIT" at the Main Menu. The system should enter Game-Over Mode. Open the coin door and press the SERVICE CREDITS button to allow game play. Choose a joystick and press the START button to begin play. Listen to the audio while playing the game. Note sound irregularities (phase problems, no low frequencies, mono audio from stereo speakers, etc.). If necessary, check the wiring harness for internal shorts or strapped connections.



# *SPORTSTATION*<sup>TM</sup>

## CHAPTER TWO

---

### **OPERATION, FEATURES, MAINTENANCE & SERVICING**

# GAME OPERATION

## STARTING UP

Whenever you turn on the machine or restore power, the system executes boot ROM code. The boot ROM contains self-diagnostic tests that automatically verify and report the condition of the disk drive and other hardware. The screen is blank during these tests. If the hardware fails a test, the system displays an error message. The message appears for 30 seconds or until someone presses a button.

- If nobody presses a button, the system quickly completes tests, and then loads game software.
- To skip boot ROM tests and activate the Menu System, press and hold the TEST MODE button. You'll find this button behind the coin door.

Having passed power-up tests, the system enters Attract Mode. Attract Mode consists of typical game scenes and sounds, alternating with high scores. Attract Mode continues until game play commences.

Players insert currency or tokens to start the game. Pressing a START determines which player receives the credit. The game computer asks whether players want to play *NBA Showtime* or *NFL Blitz 2000 Gold Edition*. Players request one or the other via player panel controls. Then players select a team. The game computer associates one team with the Player-1 and Player-2 joysticks. The Player-3 and Player-4 joysticks assume control of the opposing team. Play begins after a countdown period. Play progresses like a real-life football or basketball game. At Game Over Mode, players may choose to begin again. If players choose not to continue, then the system returns to Attract Mode.

## NFL BLITZ 2000 GOLD EDITION GAME RULES

### INSTRUCTIONS

Play instructions appear on the information panel over and under the video monitor.

### ONE TO FOUR PLAYERS

Players may enter their names for future reference. Then they select teams and run the first play. Players may choose an offensive or defensive play. Additional game information appears on the screen as needed. Team statistics appear at the end of each quarter.

### CONTROLLING CHARACTERS

The joystick and action buttons control characters on the field. The joysticks respond to different amounts of deflection as well as direction.

### GAME ACTION

Standard league football rules apply, with two exceptions: First downs require 30 yards, and teams only have seven active players. Game adjustment settings determine game length and speed.

The player view of the action changes automatically whenever a better camera angle becomes available. The game sounds include announcer comments and crowd noises.

### SCORING

Touchdowns and field goals score points, just as in real football games.

## NFL BLITZ 2000 GOLD EDITION PLAY SELECTION

### STANDARD PLAYS

The player may select any of the offensive or defensive plays in the game. Players can choose from pages of standard plays loaded into the game. Use the indicated pushbuttons to view and select any play.

### CUSTOM PLAYS

Players may choose to create their own offensive plays rather than depend on the standard plays in the game. Players can design and name their plays using the CREATE PLAY feature, then store these plays for future use. These custom plays become available on an additional page of game plays.

## **NFL BLITZ 2000 GOLD EDITION PLAYER CONTROLS**

The player controls are used to maneuver the team members and attack or defend against adversaries.

- **START (orange).** This button allows players to begin or continue play. Use PLAYER 1 START and PLAYER 2 START to begin a two-player game. START has no game action or service function.
- **JUMP / TACKLE.** This button lifts the offensive team member up or causes the defensive player to tackle opponents. Use this same button to create plays or select menu items during service.
- **PASS / CHANGE PLAYER.** This button activates offensive throws. The defense move switches active control to another teammate. Use this same button to create plays or select menu items during service.
- **TURBO (white).** The TURBO button gives any active character an extra burst of power or speed. Use this same button to create plays or select menu items during service.
- **JOYSTICK.** Each player has a joystick to control the movements of one on-screen character at a time. Use the joystick to create plays or select menu items during service.

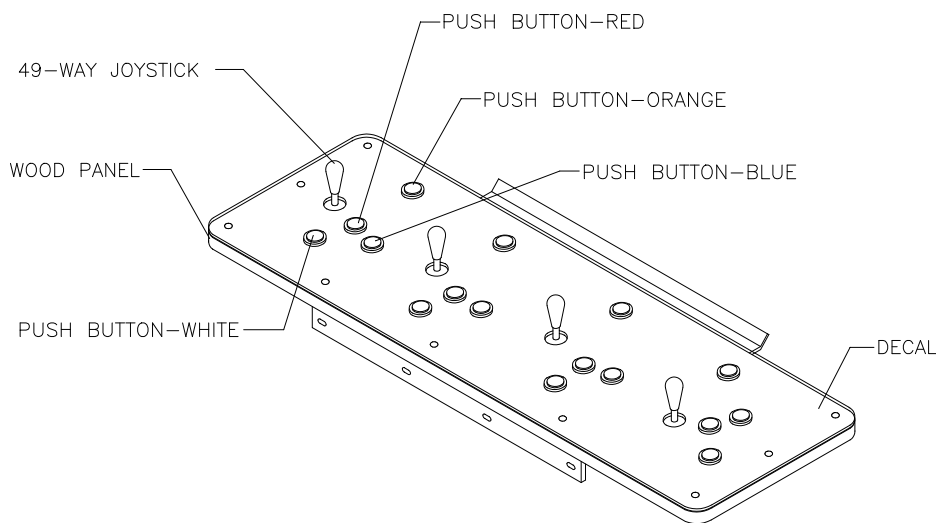

### **RECOMMENDED PLAYER CONTROL LOCATIONS**

## **NBA SHOWTIME GAME RULES**

### **INSTRUCTIONS**

Play instructions appear on the information panel over and under the video monitor.

### **ONE TO FOUR PLAYERS**

The player or players insert currency to start the game. Each player chooses a joystick and presses the nearest START button. Players select a team and two characters. In four-player games, each player controls one character. In games with fewer players, each player controls one character. The game computer controls remaining characters. The game displays team scores and statistics at the end of each quarter. Additional game information appears on screen as needed.

## **CONTROLLING CHARACTERS**

The joystick and action buttons control characters on the basketball court. The joysticks respond to different amounts of deflection as well as direction.

## GAME ACTION

Standard NBA basketball rules apply, except that the game only includes four active characters. Game settings determine game length and speed. The player view of the action changes automatically whenever a better camera angle becomes available. Game sounds include announcer comments and crowd noises.

## SCORING

The game awards points for baskets, just as in real basketball games.

## NBA SHOWTIME PLAYER CONTROLS

- **JOYSTICK.** Each player's joystick controls the position of that player's characters on the game screen.
- **PASS/STEAL (the blue button)** controls character actions on the game screen. Press PASS/STEAL to attempt to pass or steal the ball.
- **SHOOT/BLOCK (the red button)** controls character actions on the game screen. Press SHOOT/BLOCK to shoot or attempt to block the ball.
- **START (orange buttons).** Each START button allows the corresponding player to begin or continue play.
- **TURBO (The white button)** controls character actions on the game screen. Press TURBO to speed up the pace of a play.

## OPERATOR CONTROLS

### CABINET CONTROLS

- ◆ **The DIP Switches** set some system variables. You can set other variables with diagnostic control switches.
- ◆ **The Monitor Remote Control Board** allows you to adjust the video display for optimum viewing.
- ◆ **The POWER Switch** turns off the game, but does not reset game variables.

### DIAGNOSTIC CONTROL SWITCHES

- ◆ **The SERVICE CREDITS Button** allots credits without changing the game's bookkeeping total. SERVICE CREDITS has no function in the menu system.
- ◆ **The TEST MODE Button** causes the game to enter the service menu system. Press the TEST MODE button briefly to run automatic tests. To make game adjustments, press and hold TEST MODE until the Main Menu appears. Within the menu system, TEST MODE assumes another function. There, it selects a menu line item and calls up the item's submenu. The screen displays this submenu.
- ◆ **VOLUME DOWN and VOLUME UP Buttons** set game sound levels. To make minor volume changes, press either button briefly. To make major changes, press and hold a button. In the menu system, VOLUME UP moves the item highlight bar up the menu. VOLUME DOWN moves the item highlight bar downward.

<p><b>NOTICE:</b> You must adjust Attract Mode volume independently of Game Mode volume. For greater profits, increase volume levels to draw attention to this game.</p>
--

## PLAYER CONTROLS

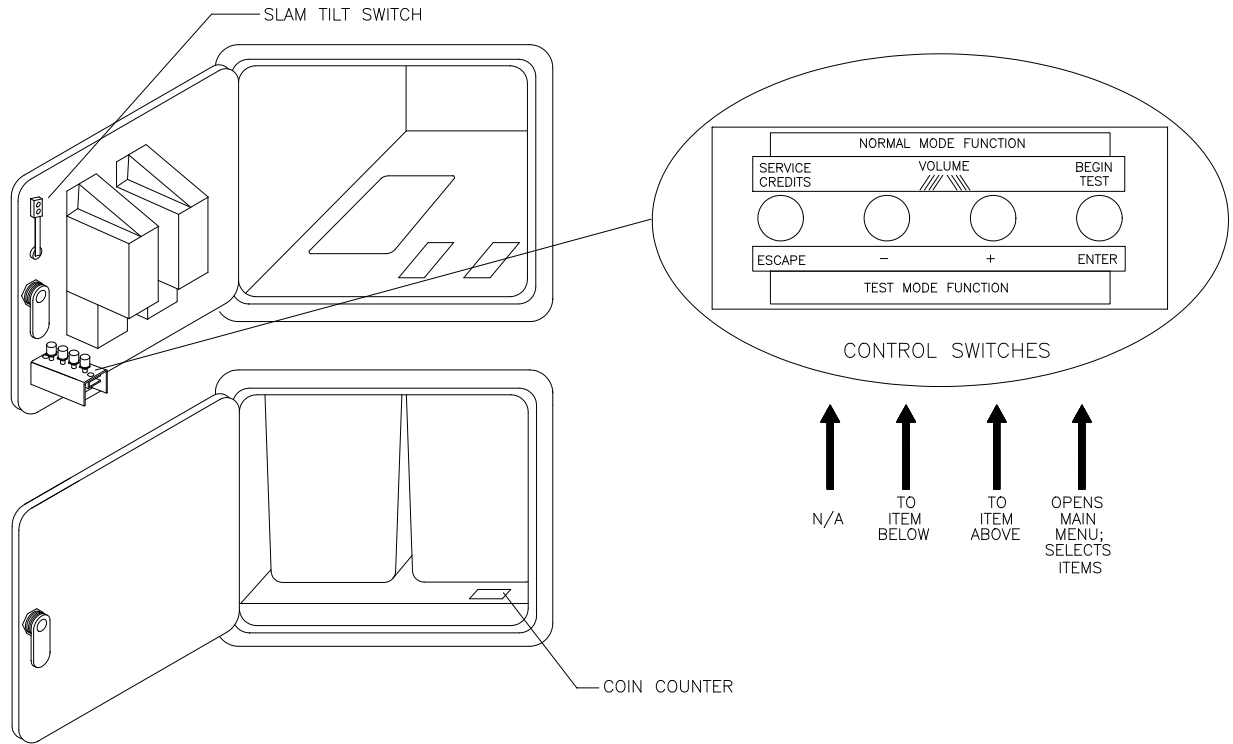

### DIAGNOSTIC CONTROL SWITCH LOCATIONS

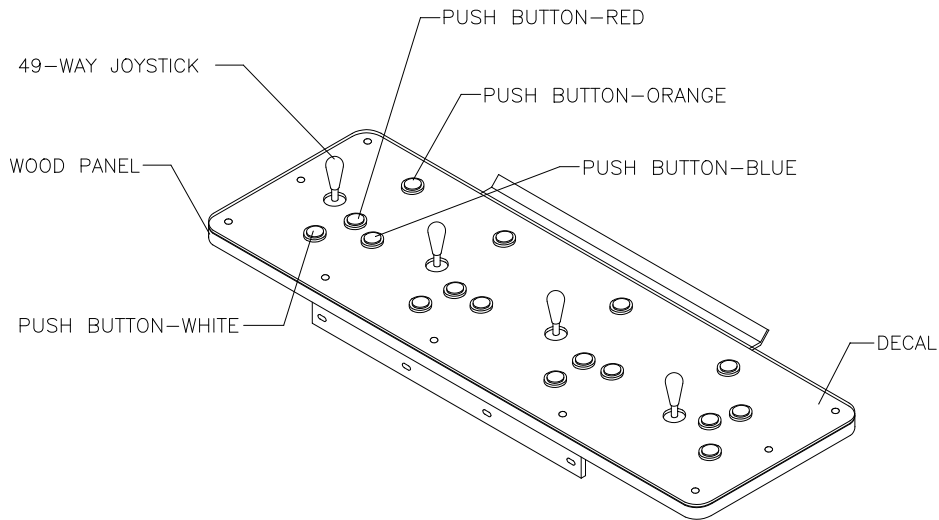

### PLAYER CONTROL LOCATIONS

---

---

## MAINTENANCE

### ◆ Cabinet

Use only non-abrasive cleaners to avoid damaging game graphics. Apply cleaner to a clean cloth or sponge. Wipe the screen clean with this cloth or sponge. *Do not apply cleaner directly on the cabinet!*

### ◆ Control Panel

Dirt or debris on the joysticks or buttons can affect earnings. Apply the cleaner to a clean cloth. Use the cloth to wipe the controls. *Don't apply the cleaner directly to the controls!*

### ◆ Viewing Glass

To clean the glass, you don't need to switch off power to the game. Apply a mild glass cleaner to a clean cloth or sponge. Use this to wipe the viewing glass. *Do not apply the cleaner directly on the glass!* Liquid could drip down into switch or motor circuits and cause erratic game operation.

---



---

## SERVICING

Only qualified service personnel should perform maintenance and repairs. The following product guidelines apply to all game operators and service personnel. Notes, cautions and warnings appear throughout this manual where they apply. Read the SAFETY pages thoroughly before beginning service.

### ◆ Circuit Board Set

The SportStation game computer uses a set of three circuit boards. The three boards include the CPU Board, I/O Board and Video Board. Switch off power to the game. Open the rear door. To expose the circuit boards, remove their perforated metal cover. Carefully note the orientation of the JAMMA connector and other cables. Extract the harness and hard disk drive ribbon cable from the board connectors. Remove circuit board mounting screws. Lift the circuit boards out of the cabinet and set them in a safe place. Use anti-static packaging from new parts to store boards that you won't reinstall.

	<b>CAUTION:</b> Circuit board edge connectors are fragile. Take care when separating boards in the board set. Never jam the board connectors together. Never plug them together on an extreme angle. If necessary, carefully straighten bent pins with a small, grounded flat blade screwdriver. Also, don't touch exposed foil on printed circuit boards. Skin oils are corrosive.
	<b>NOTICE:</b> Avoid damage to game electronics! Turn off game power before servicing circuit boards or any electronic assembly. Never "hot plug" circuit boards.

### ◆ Coin Mechanism

Switch off power to the game. Unlock the coin door and swing it open. To clean or replace a coin mechanism, unlatch and remove it. After reinstallation, ensure that the mechanism seats fully its bracket. Close and lock the release latch, and then close the door. Turn on the game and change the mechanism setup. Test known good and bad coins to verify operation.

### ◆ Coin Meter

Switch off power to the game. Unlock the cash door and swing it open. The coin meter mounts to a metal plate at the bottom the cash vault. Record the meter count before testing or replacement. Remove the plate's four mounting screws, and then remove the plate.



Disconnect the meter wiring harness at the connectors. Remove front screws and slide the meter out. Assure that a protective diode connects across the replacement meter's terminals. The diode prevents driver circuit damage.

## REINSTALLING CIRCUIT BOARD ASSEMBLIES

### ◆ **Hard Disk Drive**

Switch off power to the game. Unlock and remove the rear cabinet door. Remove the perforated metal cover over the game electronics. Disconnect the DC power cable from the hard disk drive. Unplug the ribbon cable from the hard drive. Don't disconnect the cables from the CPU Board. Loosen the drive mounting screws and lift the drive out of its mounting bracket. Remove the screws. Save them for reuse in future hard drive installations. When returning a hard drive to your distributor, pack it in an anti-static bag. Box the drive in approved shipping container 08-8068.





**NOTICE:** Hard disk drives are very fragile! Handle them with care. Do not stack or drop hard disk drives. Keep disk drives away from magnets, heat and vibration.

### ◆ **Joysticks**

Switch off power to the game. Open the player control panel. Mark and disconnect the wiring harness from a joystick. To separate the joystick from the player panel, first remove the joystick shaft. An E-ring secures the shaft. Disengage this E-ring with a small, flatblade screwdriver. Grasp the joystick knob. Extract the stick from the assembly. Then remove 8-32 tamper-resistant (KEPS®) nuts from the corners of the joystick base. Retain fasteners for reassembly.

## ◆ Memory

	<b>CAUTION:</b> Static electricity builds up on your body. This static can damage or destroy sensitive the game circuits. <b>BEFORE</b> touching or handling electronic assemblies, discharge static electricity by touching the electronics mounting plate.
	<b>NOTICE:</b> CPU Board and SI/O Board chips don't face same direction. When mounting chips on either board, refer only to chips on the same board for reference. Never use the chips on another board for reference.

ROM (Read Only Memory) circuits contain computer operating instructions for this game. Switch off power to the game. Unlock and remove the rear door. Remove the perforated metal cover. Note the ROM chip position. Remove the device with a chip extraction tool. To reinstall a ROM chip, orient the device over its socket. Press the chip firmly to seat pins. *Don't force the chip into the socket.*

## CABINET FRONT VIEW

## EXTERNAL COMPONENTS

## GAME ELECTRONICS

### INTERNAL COMPONENTS

#### ◆ **Monitor Bezel**

Switch off power to the game. Open the control panel. Remove the viewing glass. Lift the bezel up and off the monitor. Set the bezel aside. Clean the labels. Orient the labels right side up, so that players can read them. Reinstall the bezel.

#### ◆ **Viewing Glass**

Switch off power to the game. Open the control panel. Loosen three mounting screws. Slide the black metal strip from the bottom of the glass. Carefully slide the glass from the side grooves. Then lift it clear of the cabinet. Set the glass in a safe place. Clean the glass before reinstalling it.

#### ◆ **Monitor**



**CAUTION:** The video monitor is heavy, with most of the weight toward the front of the assembly. Support the monitor as you remove it from the cabinet.



**WARNING:** The monitor doesn't require isolation from AC line voltage during normal game operation. When operating the monitor outside the cabinet, use *an isolation transformer*. Connect the transformer between the monitor and line.

Switch off power to the game. Open the control panel. Remove the viewing glass and monitor bezel. Unlock and remove the rear door. Disconnect the monitor from the wiring harness, remote adjustment board, and ground wires. Remove the fasteners that secure the monitor frame to its mounting panel. Carefully pull the monitor from the cabinet. Set the monitor in a safe place. Remove the remote adjustment board from the cabinet and reconnect it to the monitor before servicing or replacement. Clean the face of the monitor before reinstalling the monitor bezel.

### ◆ Power Supply

Switch off power to the game. Unlock and remove the rear door. Remove the electronics rack and set it aside. Unplug the IEC AC connector from the rear of the supply. Unplug the power wiring harnesses from the back of the supply. Remove two front and two rear screws from the supply. Lift the supply off the power chassis. Slide the supply out of the cabinet.

**Reinstallation.** Verify the line voltage switch setting before reinstalling the power supply. Set the voltage switch to the correct value. Place the supply on the power chassis. Align the chassis mounting holes. Install the four screws and two power connectors. Connect the IEC AC connector to the rear of the supply. Replace the electronics rack. Plug the power wiring harnesses into the back of the supply. Replace and lock the rear door. Switch on power to the game.

### ◆ Speakers

Switch off power to the game. The full-range speakers are mounted behind grilles at the top of the player panel. Grilles and speakers come out from the front. Remove the screws and set the grilles aside. To avoid damaging a speaker, remove upper mounting screws first, and replace them last.



Remove the speakers from the enclosure just enough to expose the terminals. Label and disconnect the wires. Refer to the Wiring Diagram (Chapter Five) for speaker wiring information. *Don't use excess force when removing or tightening screws threaded into plastic or particle board.*

# SPORTSTATION™

## CHAPTER THREE

---

### DIAGNOSTIC, AUDIT & ADJUSTMENT MENU SYSTEM FOR *NFL BLITZ 2000 GOLD EDITION* GAMES

	<p><b>NOTICE:</b> Information in this manual is subject to change without notice. Midway reserves the right to make improvements in equipment as progress in engineering warrants.</p>
	<p><b>NOTICE: GAME-SELECTION SWITCH.</b> Select <i>NBA Showtime</i> or <i>NFL Blitz</i> by flipping switch 8 at DIP bank U13. Then power down and up again. The Attract Mode for the game you select will appear. <i>The player can still play either game.</i></p>

## MENU SYSTEM

### WHAT IS THE MENU SYSTEM?

The game's Menu System is a series of auditing, game adjustment and diagnostic screens. You can easily access and apply these screens to optimize game performance. For instance...

- Use game audits screens to assess game performance.
- Use adjustment screens to help you to customize game performance. For instance, you can restore factory default game settings. You can also calibrate player controls for accuracy.
- Use diagnostic screens to verify proper equipment operation.

### ACTIVATING THE MENU SYSTEM

Open the coin door. Find the TEST MODE switch inside. Press TEST MODE to invoke the Menu System. The game system responds by exiting Game Mode and entering Diagnostic Mode.

### AUTOMATIC TESTS

In Diagnostic Mode, the Power-On Self-Test (POST) activates. This routine runs automatically. It can detect faults that cause game or Menu System malfunctions. POST usually takes less than a minute. The test doesn't display anything. Instead, the system boot loader indicates the software revision number and serial numbers. The system boot loader also displays a sound-loading message and other useful information.

At the end of POST, the system displays the Control Functions Menu.

### CONTROL FUNCTIONS MENU

The Control Functions Menu is purely informational. It appears for five seconds. Then the Menu System automatically displays the Dual Game Adjustment Menu.

The Control Functions Menu introduces the menu navigation controls. The key point is that you can use either player or diagnostic controls to navigate menus. Diagnostic control switches are particularly helpful when you must troubleshoot player switches. This manual discusses the controls in more detail in this chapter's *Main Menu* section. Also see the page on the menu that interests you.

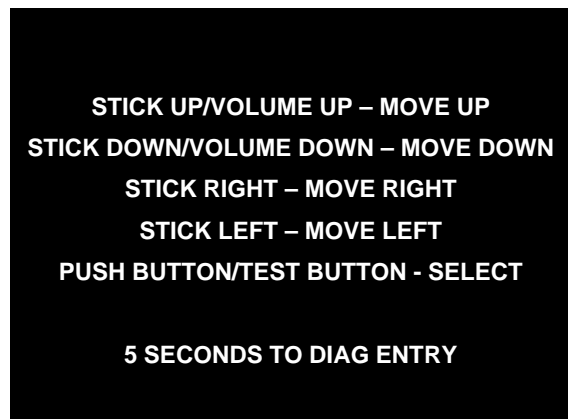

### CONTROL FUNCTIONS MENU



## DUAL GAME ADJUSTMENT MENU

The Dual Game Adjustment Menu is another informational, read-only menu. It appears until you choose to exit. This menu reminds you that some *NFL* settings also affect *NBA* game play. Press any button to exit to the Main Menu.

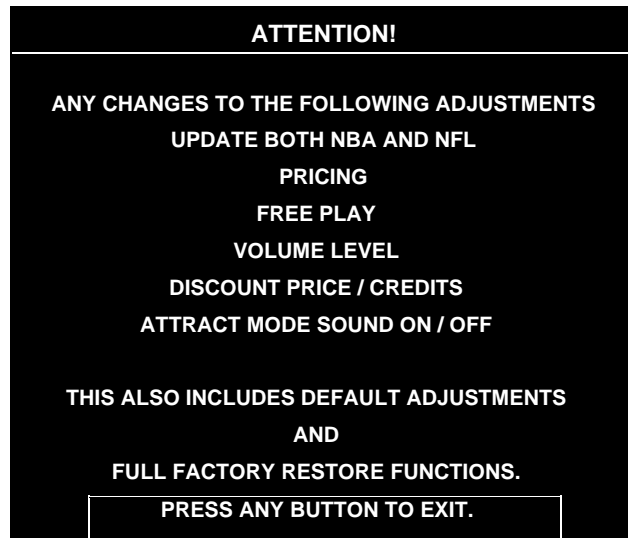

DUAL GAME ADJUSTMENT MENU

## MAIN MENU

The Main Menu offers you access to the game machine's test, bookkeeping and programmable features. Game audits, adjustments and diagnostics are line items on the Main Menu. Selecting an item opens its submenu. Every submenu presents various options that you may act upon.



MAIN MENU

## MENU LAYOUT

Menus differ, but related information tends to occupy the same screen locations.

- The block at the top, center of each screen displays the current menu title.
- Data (menu items, video signals, statistics, reports, etc.) appears in the center of the screen.
- Messages (explanations, control functions, revision levels) display at the bottom of the screen.

## MENU NAVIGATION CONTROLS

Use any player panel joystick to highlight a desired menu item. *You can only select one highlighted item at a time.* To select a highlighted item, press any player panel button. Operator control buttons inside the coin door serve as backup menu navigation controls. Press VOLUME UP or VOLUME DOWN buttons to highlight a menu item. Press TEST MODE to select a highlighted item.

## EXIT OPTIONS

To exit the NFL menus and simultaneously enter the NBA menus, choose NBA MAIN MENU. To return the game to play, highlight either EXIT TO NFL or EXIT TO NBA. Your choice determines the game that will boot. Next, press any button.

## **DIAGNOSTICS**

Select **DIAGNOSTICS** at the Main Menu. Diagnostic tests allow you to verify the condition of the electrical and electronic hardware in the game.

Highlight a test with any player panel joystick. Select the option with any player panel button.

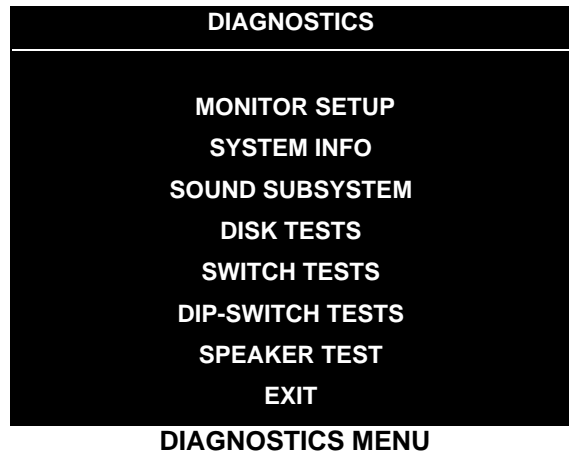

Diagnostic tests assist you in checking and adjusting the game's major systems. By running diagnostics, you can gain an insight into both system hardware and game software. Periodically running diagnostics is a crucial part of maintaining game performance and player satisfaction. Sometimes you can improve game performance by running a diagnostic test and making appropriate adjustments.

<b>Main Menu (continued)</b>
<b>Diagnostics Menu (continued)</b>
<b>Monitor Setup Menu</b>

**MONITOR SETUP**

Select MONITOR SETUP at the Diagnostics Menu. The Monitor Patterns routine provides test screens to verify monitor performance or make adjustments.

Highlight an option with any player panel joystick. Select the option with any player panel button.

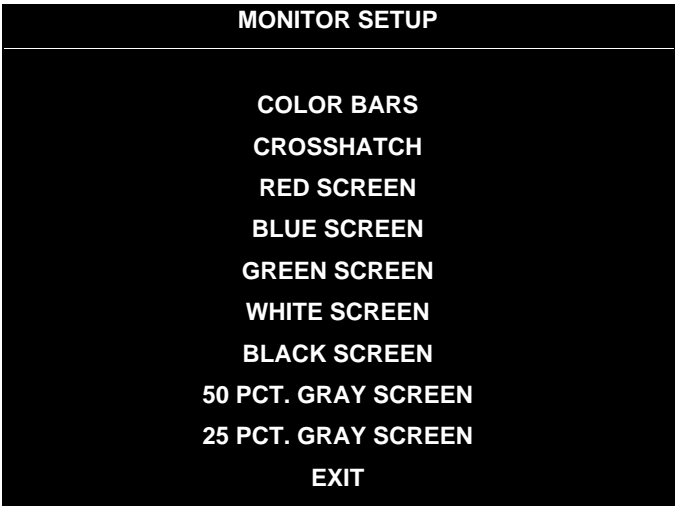

**MONITOR SETUP MENU**

**Color Bars** fills the screen with colored stripes. Use the color bars to help you to check or adjust monitor brightness and contrast. The color bars also expose defects in horizontal linearity. Each color bar consists of 32 intensity levels. On a properly adjusted monitor, the top 31 of these levels are visible. Each bar should appear sharp, clear and distinct from bars on either side. Incorrect adjustment can cause missing detail at the top or bottom of a bar. Bent bars indicate horizontal linearity flaws, such as pie crust, pincushion or barrel distortion. *(Correct color bar colors, left to right: Red, Green, Blue, Black, White, Cyan, Yellow, Violet.)* Set controls as follows: 1. Adjust BRIGHTNESS and CONTRAST to minimum. 2. Turn up BRIGHTNESS until the pixels in the black stripe begin to glow (turn dark gray). 3. Bring up the CONTRAST control until you can see 31 bars.

**Crosshatch Patterns** fill the screen with a grid and a series of dots. Crosshatch Patterns help you to check or adjust several monitor parameters: These include convergence, linearity, active viewing area and dynamic focus. The grid and the dots should be all white in color, with no fringes or parallel images. The lines should be straight and the dots round. For more detail on these adjustments, consult service literature from the monitor manufacturer.

**Color Screen** tests fill the screen with 100% of the chosen color at normal intensity. The Color Screen tests help you to check or adjust monitor intensity, black level, blanking and color purity. Each screen should be absolutely uniform from top to bottom and side to side. No retrace lines or noise should be visible. Color Screens may not hold their uniformity if the monitor degaussing circuit is defective.

**White, Gray and Black Screens** fill the screen with black, gray or white at various intensities. These monochrome screens help you to check or adjust monitor convergence, purity, contrast and intensity. These screens also simplify black level and color gun control settings. The screens should be uniform with no color tints or distortion. No retrace lines or noise should be visible.

If tests indicate a need for adjustment, use controls on the Monitor Remote Adjustment Board.

<b>Main Menu (continued)</b>
<b>Diagnostics Menu (continued)</b>
<b>System Information Menu</b>

**SYSTEM INFORMATION**

Select SYSTEM INFO at the Diagnostics Menu. The System Information Menu provides the current version numbers of this game's hardware and software. Use these numbers to describe the system during parts replacement, service calls, etc.

Highlight an option with any player panel joystick. Select the option with any player panel button.



The System Information screen reports information, but doesn't permit you to make changes. The Title line identifies the manufacturer of this game and the electronic board set used in this product. The Serial Number, Game and Date of Manufacture identify the game name and production run.

**Main Menu (continued)**

**Diagnostics Menu (continued)**

**Sound Subsystem Menu**

### **SOUND SUBSYSTEM TEST**

Select SOUND SUBSYSTEM at the Diagnostics Menu. Sound Subsystem Tests verify that audio components are connected and operate properly.

Highlight an option with any player panel joystick. Select the option with any player panel button.

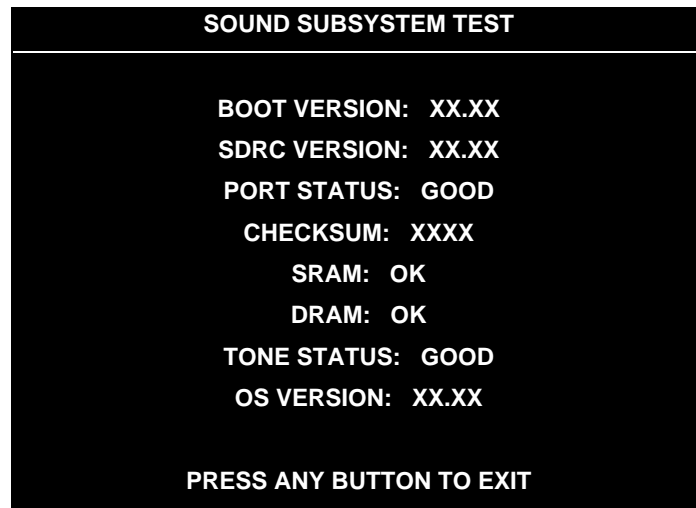

### **SOUND SUBSYSTEM MENU**

**Version, Status, Checksum and RAM Reports** are diagnostic routines. These routines analyze the digital sound circuits and can detect sound memory problems. Test results appear as numbers or messages. Sounds may also accompany some tests. Reports other than GOOD or OK indicate a problem.

<b>Main Menu (continued)</b>
<b>Diagnostics Menu (continued)</b>
<b>Disk Tests Menu</b>

**DISK TESTS**

Select DISK TESTS at the Diagnostics Menu. Disk Tests allow you to verify proper operation of the hard disk drive assembly.

Highlight an option with any player panel joystick. Select the option with any player panel button.

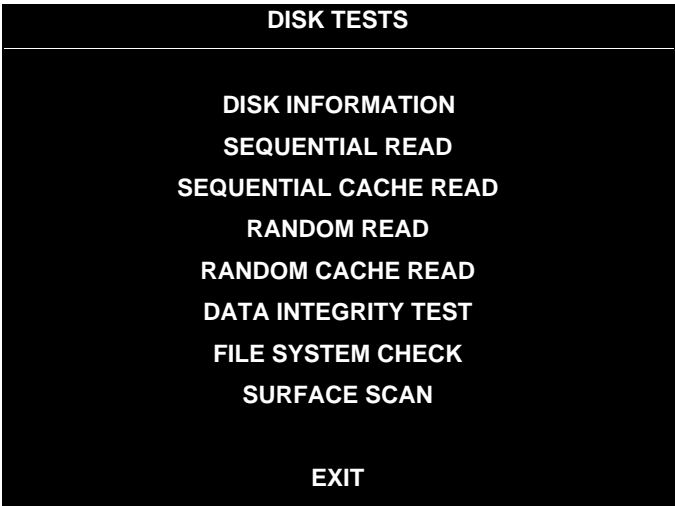

**DISK TESTS MENU**

**Disk Information.** The Disk Information routine verifies the interface between the CPU Board Assembly and hard disk drive. The processor requests disk information. Data cannot be retrieved successfully if there is a problem.

**Sequential Disk Read.** This routine tries to access every bit of data in the order it is stored directly on the disk. The hard disk drive media may be defective if this routine cannot be completed successfully.

**Sequential Cache Read.** This routine tries to access every bit of data in the order it is stored in the temporary disk memory cache. If this test is not successful, the memory circuits may be faulty.

**Random Disk Read.** This routine tries to access every bit of data in no particular order directly from the disk. This test may detect problems with ability to position the drive heads accurately over the requested data.

**Random Cache Read.** This routine tries to access every bit of data in no particular order from the temporary disk memory cache. If the cache fails this test, memory circuits may contain a fault.

**Data Integrity Test.** This test analyzes the data on the disk drive. The test determines if corrupted data is on the disk. Bad data can cause the program to falter even though the hard disk operates correctly.

**File System Check.** This routine performs a file-by-file check of the data stored on the hard disk.

**Surface Scan.** The magnetic material on the disk can become damaged, causing data to be unreadable. This routine locates unusable areas on the disk and marks them for future reference.

<b>Main Menu (continued)</b>
<b>Diagnostics Menu (continued)</b>
<b>Switch Tests Menu</b>

**SWITCH TESTS**

Select SWITCH TESTS at the Diagnostics Menu. Switch Tests verify proper operation of the game's switches, including buttons and joystick switches.

Activate each switch, and the indicator on the screen changes state. Release the switch and the indicator returns to its previous, normally open or closed condition. You can test any combination of switches together. To exit the test, simultaneously press the middle two control buttons inside the coin door. The Switch Test Screen refers to these buttons as "volume buttons."

**PLAYER SWITCH INPUTS TEST**

P1 UP	■	P3 UP	■	LEFT COIN	■
P1 DOWN	■	P3 DOWN	■	RIGHT COIN	■
P1 LEFT	■	P3 LEFT	■	P1 START	■
P1 RIGHT	■	P3 RIGHT	■	SLAM/TILT	■
P1 JUMP	■	P3 JUMP	■	TEST	■
P1 PASS	■	P3 PASS	■	P2 START	■
P1 TURBO	■	P3 TURBO	■	SERVICE CREDIT	■
P2 UP	■	P4 UP	■	CENTER COIN	■
P2 DOWN	■	P4 DOWN	■	EXTRA COIN	■
P2 LEFT	■	P4 LEFT	■	P3 START	■
P2 RIGHT	■	P4 RIGHT	■	P4 START	■
P2 JUMP	■	P4 JUMP	■	VOLUME DOWN	■
P2 PASS	■	P4 PASS	■	VOLUME UP	■
P2 TURBO	■	P4 TURBO	■	BILL VALID.	■

P1 49 WAY	P2 49 WAY	P3 49 WAY	P4 49 WAY
24	24	24	24

**PRESS BOTH PLAYER 1 AND PLAYER 2 START BUTTONS TO EXIT**

**SWITCH TEST SCREEN**

**Switches** appear on the screen as colored boxes. Red boxes indicate an open state. Green indicates closed. Any other color indicates a fault condition. A single indication on the menu screen should exactly duplicate a button or joystick change. You'll notice a unique number for a switch recognized by game electronics.

Use Switch Tests to locate crossed wires, intermittent conditions and stuck switches.

	<p><b>NOTICE:</b> Some switches may not be used with this game. If you can't find one of the listed switches, check the wiring diagram.</p>
---	---

<b>Main Menu (continued)</b>
<b>Diagnostics Menu (continued)</b>
<b>DIP Switch Tests Menu</b>

**DIP-SWITCH TESTS**

Select DIP-SWITCH TESTS at the Diagnostics Menu. Two 8-position DIP switch banks reside on the SIO Board. DIP-Switch Tests allow you to check the position of the 16 switches in these banks. You can change the setting of any DIP switch without removing the circuit board cage.

The screen displays an illustration of each switch block and the current settings. You can change DIP-switch positions with power on. Set any switch, and then check the screen to verify that the new setting is enabled.

Refer to the charts for assistance in choosing switch positions. (\* indicates factory defaults.) To exit the DIP-switch Test, press the left control button (inside the coin door).

**Game-Selection Switch.** Select *NBA Showtime* or *NFL Blitz* by flipping switch 8 at DIP bank U13. Then power down and up again. After you change the game play, you must change game artwork.

<b>DIP Switch 1 (U13)</b>		SW1	SW2	SW3	SW4	SW5	SW6	SW7	SW8
Coinage Control	DIP Switch CMOS	Off On*							
USA1 Ger1 Fr ECA1 UK1			Off*	Off*	Off*				
USA2 Ger2 Fr ECA2 UK2			On	Off	Off				
USA3 Ger3 Fr ECA3 UK3			Off	On	Off				
USA4 Ger4 Fr ECA4 UK4			On	On	Off				
USA5 Ger5 Fr ECA5 UK5			Off	Off	On				
USA9 Ger9 Fr ECA9 UK9			On	Off	On				
USA10 Ger10 Fr ECA10 UK ECA			Off	On	On				
USA ECA / Ger ECA / Fr ECA8			On	On	On				
Free Play (All Countries)			On	On	On				
Country	USA France Germany UK**					Off* On Off On	Off* Off On On		
Unused	-- --							Off* On	
Game	NBA on NBC NFL Blitz								Off* On

\*\*Except Free Play, which is "on" for SW2 through SW6.

<b>DIP Switch 2 (U12)</b>		SW1	SW2	SW3	SW4	SW5	SW6	SW7	SW8
Joystick Type	8-Way 49-Way	Off On*							
Monitor Resolution	Medium Res Low Res		Off* On						
Unused	-- --			Off* On					
Unused	-- --				Off* On				
Unused	-- --					Off* On			
Player Panel Type	2-Player 4-Player						Off On*		
Power Up Test	Active Inactive							Off On*	
Operating Mode	Game Mode Test Mode								Off* On



<b>Main Menu (continued)</b>
<b>Diagnostics Menu (continued)</b>
<b>Speaker Test Menu</b>

**SPEAKER TEST**

Select SPEAKER TEST at the Diagnostics Menu. The Speaker Test provides audio signals to test the loudspeakers.

Use tests on the Speaker Test menu to verify operation of audio system components. Highlight an option with any player panel joystick. Select the option with any player panel button.

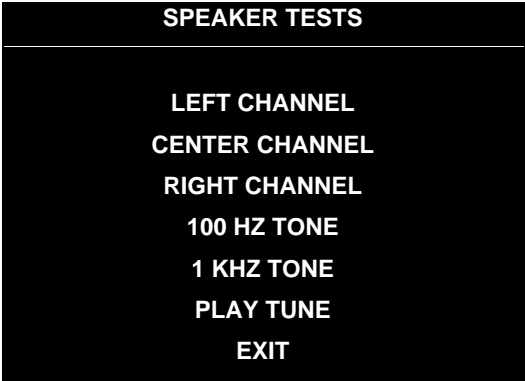

**SPEAKER TEST MENU**

**Channel and Tone Tests.** The channel subtests employ voice announcements to verify speaker locations. Use the 100 Hz tone to check the speakers' bass response. Small speakers with weak magnets or poor baffles may cause poor bass response.

**Play Tune** repeats a series of game sounds. Use PLAY TUNE to check speaker operation and fidelity. If your game has stereo speakers, run PLAY TUNE and test speaker phasing. Muddy, weak or distorted sound during this test may indicate crossed wires or out-of-phase speaker connections. Missing sounds may indicate audio cabling errors.

	<p><b>NOTICE:</b> Check the volume setting before testing. To test the speakers thoroughly, increase the volume level. Before returning to Game-Over Mode, reset the volume level to its original setting.</p>
--	--

## Main Menu (continued)

### Audits Menu

## AUDITS

Select AUDITS at the Main Menu. The Audits menus permit you to review game play statistics. Additional menus give detailed reports for each player position on game starts, ends, cabinet abuse, fault conditions, etc.

Highlight an option with any player panel joystick. Select the option with any player panel button. The screen displays a list of the statistics available to you. Select an item to view the detailed report.



### AUDITS MENU

Data in the Audits menus helps you to keep records of the game's popularity and earning potential. Use the highlight bar to select the desired subject on the Audits Menu. Each entry on the Audits Menu is the subject for an entire screen of bookkeeping information. On these screens, you can track favorite teams, frequently used offensive and defensive plays, etc.

Some audits menus also include histograms. Histogram screens allow graphical analysis of statistics. This permits visual comparisons between games. Histograms have no bar graphs until the system acquires enough data to plot.

Examine and record all game audit values before performing game service or repairs.



**NOTICE:** Be careful when clearing audit information. Once you clear data, you cannot restore it.

<b>Main Menu (continued)</b>
<b>Audits Menu (continued)</b>
<b>Coin Audits Menu</b>

**COIN AUDITS**

Select COIN AUDITS at the Audits Menu. The Coin Audits menu permits you to assess the currency collection. This report screen presents revenue quantities and other important game statistics. Coin Audits is a read-only screen.

To exit, press any player panel button.

<b>COIN AUDITS – PAGE: 1</b>	
<b>LEFT SLOT COINS</b>	<b>XXXXXXXX</b>
<b>RIGHT SLOT COINS</b>	<b>XXXXXXXX</b>
<b>BILLS</b>	<b>XXXXXXXX</b>
<b>CENTER SLOT COINS</b>	<b>XXXXXXXX</b>
<b>EXTRA SLOT COINS</b>	<b>XXXXXXXX</b>
<b>GAME STARTS</b>	<b>XXXXXXXX</b>
<b>MID-GAME STARTS</b>	<b>XXXXXXXX</b>
<b>CONTINUES</b>	<b>XXXXXXXX</b>
<b>FREE QUARTERS</b>	<b>XXXXXXXX</b>
<b>AWARDED</b>	<b>XXXXXXXX</b>
<b>SERVICE CREDITS</b>	<b>XXXXXXXX</b>
<b>TOTAL PLAYS</b>	<b>XXXXXXXX</b>
<b>UP - NEXT / BUTTON - EXIT</b>	

**COIN AUDITS MENU, PAGE 1**

The Coin Audits menu reports total quantities of coins, bills or credits collected by each active device. The menu doesn't calculate the value of the collected currency.

This screen reports information, but doesn't permit you to make changes. To reset the coin, bill and credit counters to zero, use the Clear Audits menu.

We recommend that you examine and record audit information before you make changes. Once you've cleared the counters, you can't retrieve the previous data from the system.

<b>COIN AUDITS – PAGE: 2</b>	
<b>TOTAL PAID CREDITS</b>	<b>XXXXXXXX</b>
<b>TOTAL</b>	<b>XXXXXXXX</b>
<b>DOWN - PREV / BUTTON - EXIT</b>	

**COIN AUDITS MENU, PAGE 2**

<b>Main Menu (continued)</b>
<b>Audits Menu (continued)</b>
<b>Credits Audits Menu</b>

**CREDITS AUDITS**

Select CREDITS AUDITS at the Audits Menu. The Credits Audits menu permits you to assess the currency collection. This report screen presents revenue quantities and other important game statistics. Credits Audits is a read-only screen.

To exit, press any player panel button.

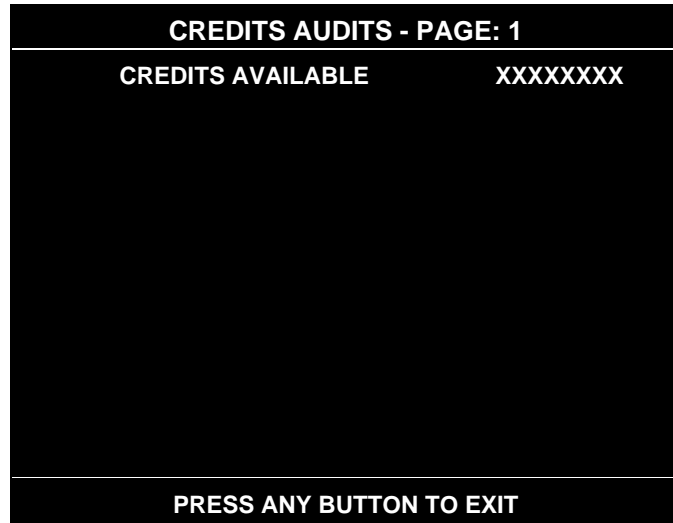

**CREDITS AUDITS MENU**

<b>Main Menu (continued)</b>
<b>Audits Menu (continued)</b>
<b>Game Audits Menu</b>

### GAME AUDITS

Select GAME AUDITS at the Audits Menu. The Game Audits menus permit you to review the game play statistics. Game Audits is a read-only screen.

To exit, press any player panel button.

GAME AUDITS - PAGE: 1			
TOTAL UPTIME	XX	2 QUARTER GAMES	XX
TOTAL PLAY TIME	XX	3 QUARTER GAMES	XX
GAME STARTED	XX	4 QUARTER GAMES	XX
INITIALS ENTERED	XX	WENT INTO OVERTIME 1	XX
<FG> PURCHASED AT START	XX	WENT INTO OVERTIME 2	XX
CREATE PLAY SESSIONS	XX	WENT INTO OVERTIME 3	XX
1 PLAYER	XX	1 PLAYER FINISHES	XX
2 PLAYER	XX	2 PLAYER FINISHES	XX
3 PLAYER	XX	3 PLAYER FINISHES	XX
4 PLAYER	XX	4 PLAYER FINISHES	XX
2P V CPU	XX	2P V CPU FINISHES	XX
1 QUARTER GAMES	XX	H VS H LSW'S	XX
		CPU WINS (FG)	XX
		AVG H VS H TOTAL SCORE (FG)	XX
		AVG H VS CPU TOTAL SCORE (FG)	XX
		AVG H VS H WIN SCORE (FG)	XX
UP – NEXT / BUTTON - EXIT			

### GAME AUDITS MENU, PAGE 1

The Game Audits menu reports information, but doesn't permit you to make changes. Examine and record information at GAME AUDITS before deleting data at the Clear Audits Menu. Once you've cleared the counters, you can't retrieve the previous data from the system.

### GAME AUDIT MENU TERMS

SCREEN TERM	DEFINITION	SCREEN TERM	DEFINITION
<b>AVG</b>	Average	<b>LSW</b>	Your game computer's internal record-keeping counters
<b>CPU</b>	Central Processing Unit: The game computer	<b>Machine Power-On</b>	Number of power cycles (game turn-ons)
<b>&lt;FG&gt;, (FG)</b>	Full Game	<b>OT</b>	Overtime
<b>H VS CPU</b>	Human versus CPU: Competition that pits players against the game computer	<b>P V</b>	Player versus...
<b>H VS H</b>	Human versus human: Competition between human players	<b>Total Uptime</b>	Overall on-time for the game computer
		<b>2PV</b>	Two players versus...

**GAME AUDITS - PAGE: 2**

AVG H VS H LOSS SCORE	XX
(FG)	XX
BIGGEST CPU WIN MARGIN	XX
(fg)	XX
BIGGEST CPU LOSS	XX
MARGIN (fg)	XX
TLF'S	XX
SBLF'S	XX

**DOWN – PREV / BUTTON - EXIT**

**GAME AUDITS MENU, PAGE 2**

<b>Main Menu (continued)</b>
<b>Audits Menu (continued)</b>
<b>Team Stats Menu</b>

**TEAM STATS**

Select TEAM STATS at the Audits Menu. Team Stats details the number of games played by each team in the league. Team Stats is a read-only screen.

To exit, press any player panel button.

<b>TEAM STATS – PAGE: 1</b>			
<b>ARIZONA CARDINALS</b>	<b>0</b>	<b>MINNESOTA VIKINGS</b>	<b>0</b>
<b>ATLANTA FALCONS</b>	<b>0</b>	<b>NEW ENGLAND PATRIOTS</b>	<b>0</b>
<b>BALTIMORE RAVENS</b>	<b>0</b>	<b>NEW ORLEANS SAINTS</b>	<b>0</b>
<b>BUFFALO BILLS</b>	<b>0</b>	<b>NEW YORK GIANTS</b>	<b>0</b>
<b>CAROLINA PANTHERS</b>	<b>0</b>	<b>NEW YORK JETS</b>	<b>0</b>
<b>CHICAGO BEARS</b>	<b>0</b>	<b>OAKLAND RAIDERS</b>	<b>0</b>
<b>CINCINNATI BENGALS</b>	<b>0</b>	<b>PHILADELPHIA EAGLES</b>	<b>0</b>
<b>CLEVELAND BROWNS</b>	<b>0</b>	<b>PITTSBURCH STEELERS</b>	<b>0</b>
<b>DALLAS COWBOYS</b>	<b>0</b>	<b>SAN DIEGO CHARGERS</b>	<b>0</b>
<b>DENVER BRONCOS</b>	<b>0</b>	<b>SAN FRANCISCO</b>	<b>0</b>
<b>DETROIT LIONS</b>	<b>0</b>	<b>SEATTLE SEAHAWKS</b>	<b>0</b>
<b>GREEN BAY PACKERS</b>	<b>0</b>	<b>ST. LOUIS RAMS</b>	<b>0</b>
<b>INDIANAPOLIS COLTS</b>	<b>0</b>	<b>TAMPA BAY BUCS</b>	<b>0</b>
<b>JACKSONVILLE JAGUARS</b>	<b>0</b>	<b>TENNESSEE TITANS</b>	<b>0</b>
<b>KANSAS CITY CHIEFS</b>	<b>0</b>	<b>WASHINGTON REDSKINS</b>	<b>0</b>
<b>MIAMI DOLPHINS</b>	<b>0</b>		

**PRESS ANY BUTTON TO EXIT**

**TEAM STATS MENU**

<b>Main Menu (continued)</b>
<b>Audits Menu (continued)</b>
<b>Offensive Plays Menu</b>

**OFFENSIVE PLAYS**

Select OFFENSIVE PLAYS at the Audits Menu. Offensive Plays accounts for each play type as a percentage of all offensive plays. Offensive Plays is a read-only menu.

To exit, press any player panel button.

<b>OFFENSIVE PLAYS – PAGE: 1</b>			
<b>UPPER CUT</b>	<b>0%</b>	<b>REVERSE ZIP</b>	<b>0%</b>
<b>BLIZZARD</b>	<b>0%</b>	<b>SWEEP R/L</b>	<b>0%</b>
<b>HAIL MARY</b>	<b>0%</b>	<b>MIDDLE PICK</b>	<b>0%</b>
<b>TURMOIL</b>	<b>0%</b>	<b>DA BOMB</b>	<b>0%</b>
<b>BACK SPLIT</b>	<b>0%</b>	<b>UTB DEEP</b>	<b>0%</b>
<b>CRISS CROSS</b>	<b>0%</b>	<b>SUB ZERO</b>	<b>0%</b>
<b>DAWG HOOK</b>	<b>0%</b>	<b>SUPER FLY</b>	<b>0%</b>
<b>UP THE GUT</b>	<b>0%</b>		
<b>SCREEN</b>	<b>0%</b>		
<b>FIELD GOAL</b>	<b>0%</b>		
<b>FAKE FG</b>	<b>0%</b>		
<b>EXTRA POINT</b>	<b>0%</b>		
<b>PUNT</b>	<b>0%</b>		
<b>FAKE PUNT</b>	<b>0%</b>		
<b>HB BLOCK</b>	<b>0%</b>		
<b>SLANT R/L</b>	<b>0%</b>		
<b>PRESS ANY BUTTON TO EXIT</b>			

**OFFENSIVE PLAYS MENU**



<b>Main Menu (continued)</b>
<b>Audits Menu (continued)</b>
<b>Defensive Plays Menu</b>

**DEFENSIVE PLAYS**

Select DEFENSIVE PLAYS at the Audits Menu. Defensive Plays accounts for each play type as a percentage of all defensive plays. Defensive Plays is a read-only menu.

To exit, press any player panel button.

<b>DEFENSIVE PLAYS – PAGE: 1</b>	
<b>SAFE COVER</b>	<b>0%</b>
<b>GOAL LINE</b>	<b>0%</b>
<b>2 MAN BLITZ</b>	<b>0%</b>
<b>MEDIUM ZONE</b>	<b>0%</b>
<b>SUICIDE BLITZ</b>	<b>0%</b>
<b>DEEP ZONE</b>	<b>0%</b>
<b>1 MAN BLITZ</b>	<b>0%</b>
<b>NEAR ZONE</b>	<b>0%</b>
<b>ZONE BLITZ</b>	<b>0%</b>
<b>BLOCK FG</b>	<b>0%</b>
<b>BLOCK PUNT</b>	<b>0%</b>
<b>PUNT RETURN</b>	<b>0%</b>

**PRESS ANY BUTTON TO EXIT**

**DEFENSIVE PLAYS MENU**

<b>Main Menu (continued)</b>
<b>Audits Menu (continued)</b>
<b>Exception Dump Menu</b>

**EXCEPTION DUMP**

Select EXCEPTION DUMP at the Audits Menu. Game programmers use the Exception Dump Menu to view register contents during program development. This menu has no field purpose. Exception Dump is a read-only menu.

To exit, press any player panel button.

<b>Main Menu (continued)</b>
<b>Audits Menu (continued)</b>
<b>Clear Audits Menu</b>

**CLEAR AUDITS**

Select CLEAR AUDITS at the Audits Menu. The Clear Audits menu allows you to clear individual memory counters or to reset them all at once.

Highlight an option with any player panel joystick. Select the option with any player panel button.



You can reset any audit screen from the Clear Audits Menu. Choose an item and zero its counter. CLEAR ALL simultaneously changes all audit categories to factory default values. After you've selected an item, the system gives you the opportunity to escape this change. For example:

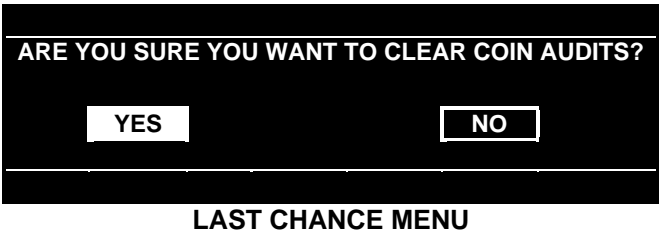

After you've selected and verified a clear function, the values reset. The system can't restore the previous values. Examine and record utility values before you make changes.

<b>Main Menu (continued)</b>
------------------------------

<b>Adjustments Menu</b>
-------------------------

## ADJUSTMENTS

Select ADJUSTMENTS at the Main Menu. The Adjustments menus permit you to change game characteristics. Use these screens to optimize game performance and earnings.

Highlight an option with any player panel joystick. Select the option with any player panel button.



<b>Main Menu (continued)</b>
------------------------------

<b>Adjustments Menu (continued)</b>
-------------------------------------

<b>Pricing Menu</b>
---------------------

## PRICING

Select PRICING at the Adjustments Menu. The Pricing menus allow you to view current settings or change the cost of games. Custom pricing allows you to select the number of coins or credits required for each game. The game restores factory default values if you exchange the CPU Board or if the backup battery fails.

Highlight an option with any player panel joystick. Select the option with any player panel button.

You may reset options to factory defaults or change an option after viewing it. We recommend examining and recording pricing options before making changes.

You may save several custom prices and then choose between them as needed. On-screen instructions guide you through the process of creating custom price settings.

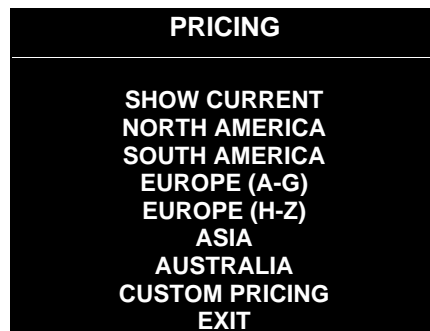

## PRICING MENU

An additional box appears on screen to explain the available functions as you select each item.

## STANDARD PRICING TABLE

NAME	START	CONTINUE	CREDITS/COIN	COIN 1	COIN 2	COIN 3	COIN4	BILL
ANTILLES	2	2	1/25¢, 4/1G	.25¢	1G			
AUSTRALIA 1	2	2	1/3X20¢, 2/\$1.00	.20¢	\$1.00			
AUSTRALIA 2	2	2	1/5X20¢, 1/\$1.00	.20¢	\$1.00			
AUSTRIA 1	2	2	1/5Sch, 2/10Sch	5 Sch	10 Sch			
AUSTRIA 2	2	2	1/2X5Sch, 3/2X10Sch	5 Sch	10 Sch			
BELGIUM 1	2	2	1/20BF	20BF	20BF			
BELGIUM 2	2	2	3/20BF	20BF	20BF			
BELGIUM 3	2	2	2/20BF	20BF	20BF			
BELGIUM ECA	2	2	1/20BF	50BF	20BF	5BF		
CANADA 1	2	2	1 / 2 x 25¢, 3 / \$1	25¢	25¢			
CANADA 2	2	2	1 / 2 x 25¢, 3 / \$1	25¢	\$1.00			
CANADA 3	2	2	3 / \$1.00, 6 / \$2.00	\$1.00	\$2.00			
CANADA ECA	2	2	1 / 2 x 25¢, 3 / \$1	25¢		\$1.00	\$2.00	
DENMARK	2	2	3/5DKr, 7/10DKr	5DKr	10DKr			
FINLAND	2	2	1/1Fmk	1Fmk	5Fmk			
FRANCE 1	2	2	2/5Fr, 5/10Fr	5Fr	10Fr			
FRANCE 2	2	1	2/5Fr, 4/10Fr	5Fr	10Fr			
FRANCE 3	2	1	1/5Fr, 3/10Fr	5Fr	10Fr			
FRANCE 4	2	1	1/5Fr, 2/10Fr	5Fr	10Fr			
FRANCE 5	2	1	2/5Fr, 5/10Fr, 11/2 X 10Fr	5Fr	10Fr			
FRANCE 6	2	1	2/5Fr, 4/10Fr, 9/2 X 10Fr	5Fr	10Fr			
FRANCE 7	2	1	1/5Fr, 3/10Fr, 7/2 X 10Fr	5Fr	10Fr			
FRANCE 8	2	1	1/5Fr, 2/10Fr, 5/2 X 10Fr	5Fr	10Fr			
FRANCE 9	2	1	1/3 X 1Fr, 2/5Fr	1Fr	5Fr			
FRANCE 10	2	1	1/2 X 1Fr, 3/5Fr	1Fr	5Fr			
FRANCE 11	2	1	1/3 X 1Fr, 2/5Fr, 5/2 X 5Fr	1Fr	5Fr			
FRANCE 12	2	1	1/2 X 1Fr, 3/5Fr, 7/2 X 5Fr	1Fr	5Fr			
FRANCE ECA 1	1	1	2/5Fr, 5/10Fr	1Fr	5Fr	10Fr	20Fr	
FRANCE ECA 2	1	1	2/5Fr, 4/10Fr	1Fr	5Fr	10Fr	20Fr	
FRANCE ECA 3	1	1	1/5Fr, 3/10Fr	1Fr	5Fr	10Fr	20Fr	
FRANCE ECA 4	1	1	1/5Fr, 2/10Fr	1Fr	5Fr	10Fr	20Fr	
FRANCE ECA 5	1	1	2/5Fr, 5/10Fr, 11/2 X 10Fr	1Fr	5Fr	10Fr	20Fr	
FRANCE ECA 6	1	1	2/5Fr, 4/10Fr, 9/2 X 10Fr	1Fr	5Fr	10Fr	20Fr	
FRANCE ECA 7	1	1	1/5Fr, 3/10Fr, 7/2 X 10Fr	1Fr	5Fr	10Fr	20Fr	
FRANCE ECA 8	1	1	1/5Fr, 2/10Fr, 5/2 X 10Fr	1Fr	5Fr	10Fr	20Fr	
FRANCE ECA 9	1	1	1/3 X 1Fr, 2/5Fr	1Fr	5Fr	10Fr	20Fr	
FRANCE ECA 10	1	1	1/2 X 1Fr, 3/5Fr	1Fr	5Fr	10Fr	20Fr	
FRANCE ECA 11	1	1	1/3 X 1Fr, 2/5Fr, 5/10Fr	1Fr	5Fr	10Fr	20Fr	
FRANCE ECA 12	1	1	1/2 X 1Fr, 3/5Fr, 7/10Fr	1Fr	5Fr	10Fr	20Fr	
FRANCE ECA 13	1	1	1/10Fr, 2/20Fr, 4/30Fr	1Fr	5Fr	10Fr	20Fr	
FREE PLAY	--	--	--	None	None	None	None	None
GERMANY 1	2	2	1/1DM, 6/5DM	1DM	5DM			
GERMANY 2	2	1	1/1DM, 7/5DM	1DM	5DM			
GERMANY 3	2	1	1/1DM, 8/5DM	1DM	5DM			
GERMANY 4	2	1	1/1DM, 5/5DM	1DM	5DM			
GERMANY 5	2	1	1/1DM, 6/5DM	1DM	5DM			
GERMANY ECA 1	2	2	1/1DM, 2/2DM, 6/5DM	1DM	2DM	5DM		
GERMANY ECA 2	2	1	1/1DM, 2/2DM, 6/5DM	1DM	2DM	5DM		
GERMANY ECA 3	1	1	1/1DM, 2/2DM, 6/5DM	1DM	2DM	5DM		
HUNGARY	2	2	1/2X10Ft, 3/2X20Ft	10Ft	20Ft			
ITALY	2	2	1/500Lit	500Lit	500Lit			
JAPAN 1	2	2	1/100Yen	100	100			
JAPAN 2	2	2	2/100Yen	100	100			
NETHERLANDS	2	2	1/1HFI, 3/2.5HFI	1HFI	2.5HFI			
NEW ZEALAND 1	1	1	1/\$1	\$1	\$2			
NEW ZEALAND 2	1	1	2/\$1	\$1	\$2			
NORWAY	2	2	3/5NKr, 6/10NKr	5NKr	10NKr			
SPAIN 1	2	2	1/100Pta, 6/500Pta	100Pta	500Pta			
SPAIN 2	2	2	1/100Pta, 5/500Pta	100Pta	500Pta			
SWEDEN	2	2	1/3X1SKr, 2/5SKr	1SKr	5SKr			
SWITZERLAND 1	2	2	1/1SFr, 6/5SFr	1SFr	5SFr			
SWITZERLAND 2	2	2	1/1SFr, 7/5SFr	1SFr	5SFr			
SWITZERLAND 3	2	2	1/1SFr, 8/5SFr	1SFr	5SFr			

(Table continues on next page)

**STANDARD PRICING TABLE, *continued***

NAME	START	CONTINUE	CREDITS/COIN	COIN 1	COIN 2	COIN 3	COIN4	BILL
UK ECA 1	1	1	1/50p, 3/£1.00	£1.00	50p	20p	10p	£2.00
UK ECA 2	1	1	1/50p, 2/£1.00	£1.00	50p	20p	10p	£2.00
UK ECA 3	1	1	1/30p, 2/50p, 5/£1.00	£1.00	50p	20p	10p	£2.00
UK 4	1	1	1/50p, 3/£1.00	£1.00	50p			
UK 5	1	1	1/50p, 2/£1.00	£1.00	50p			
UK ECA 6	1	1	1/30p, 2/50p, 4/£1.00	£1.00	50p	20p	10p	£2.00
UK ECA 7	1	1	3/£1.00	£1.00	50p	20p	10p	£2.00
UK ECA 8	1	1	1/50p, 2/£1.00, 4/£2.00	£1.00	50p	20p	10p	£2.00
USA1	2	2	1/25¢	25¢	25¢			\$1.00
USA2	2	1	1/25¢	25¢	25¢			\$1.00
USA3	1	1	1/25¢	25¢	25¢			\$1.00
USA4	1	1	1/50¢, 3/\$1.00	25¢	25¢			\$1.00
USA5	2	1	1/50¢, 4/\$1.00	25¢	25¢			\$1.00
USA6	1	1	1/50¢	25¢	25¢			\$1.00
USA7	1	1	1/50¢, 3/\$1.00	25¢	25¢			\$1.00
USA8	2	2	1/50¢, 4/\$1.00	25¢	25¢			\$1.00
USA9	3	2	1/25¢, 4/\$1.00	25¢	25¢			\$1.00
USA10	3	3	1/25¢, 4/\$1.00	25¢	25¢			\$1.00
USA11	4	2	1/25¢, 4/\$1.00	25¢	25¢			\$1.00
USA12	4	3	1/25¢, 4/\$1.00	25¢	25¢			\$1.00
USA13	4	4	1/25¢, 4/\$1.00	25¢	25¢			\$1.00
USA ECA	3	3	1/25¢, 4/\$1.00	\$1.00	25¢	10¢	05¢	\$1.00

<b>Main Menu (<i>continued</i>)</b>
<b>Adjustments Menu (<i>continued</i>)</b>
<b>Pricing Menu (<i>continued</i>)</b>
<b>Current Pricing Menu</b>

**Current Pricing**

Select SHOW CURRENT at the Pricing Menu. The Current Pricing Menu is a read-only screen. Use it to check pricing parameters for the pricing table your game is using. To select a new pricing table, return to the Pricing Menu. To invent your own pricing table, select Custom Pricing on the Pricing Menu.

Press any START button to exit from the menu.

<b>CURRENT PRICING</b>	
LEFT SLOT UNITS	XX
RIGHT SLOT UNITS	XX
CENTER SLOT UNITS	XX
EXTRA SLOT UNITS	XX
BILL VALIDATOR UNITS	XX
UNITS PER CREDIT	XX
UNITS PER BONUS	XX
MINIMUM UNITS	XX
CREDITS TO START	XX
CREDITS TO CONTINUE	XX
MAX CREDITS	XX
COINS PER BILL	XX
<b>PRESS ANY BUTTON TO EXIT</b>	

**CURRENT PRICING MENU**

The following table clarifies Pricing Menu terms:

SCREEN TERM	DISCUSSION
<b>Slot Units; Bill Validator (DBV) Units</b>	Cyber-currency. This adjustment assigns a number of "units" to each coin mechanism or bill acceptor. For instance, if a quarter buys 1 unit, then \$1 buys 4 units. ( <i>See Coins per Bill.</i> ) You insert a coin into a 1-unit coin acceptor. The system, due to its programming, knows that your coin is worth one unit.
<b>Units per Credit</b>	How many units equal one credit. (Units buy credit, the price of one game.)
<b>Units per Bonus</b>	Units awarded when a player earns a bonus.
<b>Minimum Units</b>	Until this many units accumulate, the system awards no credits.
<b>Credits to Start</b>	Number of games a player must purchase to begin play.
<b>Credits to Continue</b>	Number of games a player must purchase to resume play.
<b>Max Credits</b>	Limits the number of credits that the game will accept.
<b>Coins per Bill</b>	How many coins one bill is worth.

<b>Main Menu (continued)</b>
<b>Adjustments Menu (continued)</b>
<b>Pricing Menu (continued)</b>
<b>Custom Pricing Menu</b>

### Custom Pricing

Select CUSTOM PRICING at the Pricing Menu. The Custom Pricing Menu permits you to program and use your own pricing table. You can save several pricing schemes and chose between them as desired.

Highlight an option with any player panel joystick. Change the option with any player panel button. Press any START button to save your pricing table and exit from the menu.

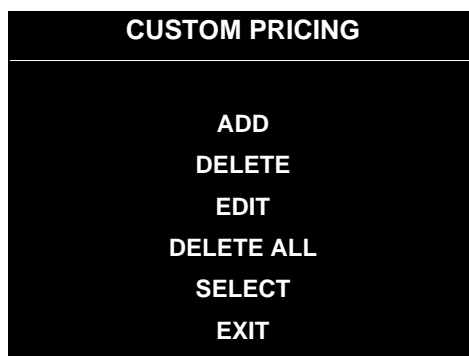

**CUSTOM PRICING OPENING MENU**

**Add** allows you to write a new custom pricing scheme. If you choose ADD, the system directs you to...

- [ ] 1. Name your scheme.
- [ ] 2. Program pricing information.
- [ ] 3. Select the coin denomination for your scheme.
- [ ] 4. Compose a pricing screen message.

**Delete** permits you to eliminate a single custom pricing scheme.

**Edit** lets you modify a stored custom pricing scheme.

**Delete**, when enabled, clears all custom pricing schemes.

**Select** enables you to choose which custom pricing scheme is the active one.

<b>Main Menu (continued)</b>
<b>Adjustments Menu (continued)</b>
<b>Pricing Menu (continued)</b>
<b>Custom Pricing Menu (continued)</b>
<b>Creating Pricing Scheme Menu</b>

### Creating Pricing Scheme

After you name your custom pricing scheme, you encounter the Creating Pricing Scheme Menu. This menu is where you program the pricing scheme. You can save several pricing schemes and chose between them as desired.

Highlight an option with any player panel joystick. Select Change Mode with with any player panel button. Use a joystick to change the option. Save your setting by pressing any player panel button. Press any START button to save your pricing table and exit from the menu.

<b>CREATING XXXX</b>			
<b>LEFT UNITS</b>	<b>XX</b>	<b>RIGHT UNITS</b>	<b>XX</b>
<b>CENTER UNITS</b>	<b>XX</b>	<b>EXTRA UNITS</b>	<b>XX</b>
<b>DBV UNITS</b>	<b>XX</b>	<b>UNITS PER CREDIT</b>	<b>XX</b>
<b>UNITS / BONUS</b>	<b>XX</b>	<b>MINIMUM UNITS</b>	<b>XX</b>
<b>CREDITS TO START</b>	<b>XX</b>	<b>CREDITS TO CONT.</b>	<b>XX</b>
<b>MAX CREDITS</b>	<b>XX</b>	<b>COINS / BILL</b>	<b>XX</b>
<b>SHOW FRACTIONS</b>	<b>XX</b>	<b>LEFT COUNT</b>	<b>XX</b>
<b>RIGHT COUNT</b>	<b>XX</b>	<b>CENTER COUNT</b>	<b>XX</b>
<b>EXTRA COUNT</b>	<b>XX</b>	<b>DBV COUNT</b>	<b>XX</b>
<b>USE STICK TO SELECT AN ITEM TO MODIFY</b>			
<b>PRESS ANY BUTTON TO MODIFY THE ITEM</b>			
<b>PRESS ANY START BUTTON TO SAVE AND EXIT</b>			
<b>CUSTOM PRICING MENU</b>			

The Custom Pricing Menu employs the same terms that appear on the Current Pricing Table. See the table below for definitions of these terms.

### PRICING MENU TERMS

<b>SCREEN TERM</b>	<b>DISCUSSION</b>
<b>Slot Units; Bill Validator (DBV) Units</b>	Cyber-currency. This adjustment assigns a number of "units" to each coin mechanism or bill acceptor. For instance, if a quarter buys 1 unit, then \$1 buys 4 units. ( <i>See Coins per Bill.</i> ) You insert a coin into a 1-unit coin acceptor. The system, due to its programming, knows that your coin is worth one unit.
<b>Units per Credit</b>	How many units equal one credit. (Units buy credit, the price of one game.)
<b>Units per Bonus</b>	Units awarded when a player earns a bonus.
<b>Minimum Units</b>	Until this many units accumulate, the system awards no credits.
<b>Credits to Start</b>	Number of games a player must purchase to begin play.
<b>Credits to Continue</b>	Number of games a player must purchase to resume play.
<b>Max Credits</b>	Limits the number of credits that the game will accept.
<b>Coins per Bill</b>	How many coins one bill is worth.

**BASIC CUSTOM PRICING.** Custom pricing creates an imaginary currency exchange. In this currency exchange, the coins of the realm are “units.” Think of units as a type of cyber-currency, useful only within the game software. By inserting coins, you purchase units.

Since units are only negotiable within game software, the system stores your units for you. When the system receives enough units, it buys a game for you. The price of a game is one “credit.” You can think of credits as a second form of cyber-currency.

Even though you’ve now bought one game, you may not be able to begin playing. In many pricing schemes, you must buy two or more credits to begin play. The idea here is something like a minimum order of goods at a store. That is, the operator can “shrink-wrap” two or more games in a package. You can’t play unless you buy the entire package.

•**1 / 25¢ COIN; 1 CREDIT TO START.** In a simple, quarter pricing scheme, the player inserts one coin to buy one unit. The system exchanges that unit for one credit. If CREDITS TO START contains the value one, then play commences. A dollar bill buys four units.

Left Slot Units	Validator Units	Units / Credit	Credits to Start	Coins / Bill
1	4	1	1	4

•**1 / 3 X 25¢; 2 CREDITS TO START.** Again, assuming quarter slots, here’s one way to implement 75¢ pricing... In this scheme, each coin that the player inserts buys one unit. The system exchanges three units for one credit. CREDITS TO START contains the value two. To play, the player must pay for two credits. In this scheme, a dollar buys four units.

Left Slot Units	Validator Units	Units / Credit	Credits to Start	Coins / Bill
1	4	3	2	4

•**2 / 1 COIN; 6 CREDITS TO START.** Now let’s consider a more unusual pricing scheme. Here, the player can buy two units with one coin. The system exchanges each of these units for one credit. Notice that CREDITS TO START contains the value six. To play, the player must insert two more coins to pay for six credits. Also notice that if the player pays with a bill, the system throws in an extra unit.

Left Slot Units	Validator Units	Units / Credit	Credits to Start	Coins / Bill
2	9	1	6	4



<b>Main Menu (continued)</b>
<b>Adjustments Menu (continued)</b>
<b>Pricing Menu (continued)</b>
<b>Custom Pricing Menu (continued)</b>
<b>Screen Message Menu</b>

### Screen Message

Towards the end of the Custom Pricing Menus, you encounter the Screen Message Menu. The Screen Message Menu allows you to enter a brief pricing or advertising message. The video game machine displays your message during the Attract Mode.

You may enter one or two lines of text. Each line may include up to 32 alphanumeric characters. Here's an example of a typical message...

1 CREDIT / 2 COINS  
EAT AT JOE'S

Highlight a letter with any player panel joystick. Select the letter with any player panel button. Delete the rightmost character of the default message by selecting the on-screen asterisk (\*). Watch the bottom of the screen to see your message line develop. Save the entire line and proceed to the second line by selecting the arrow (>).

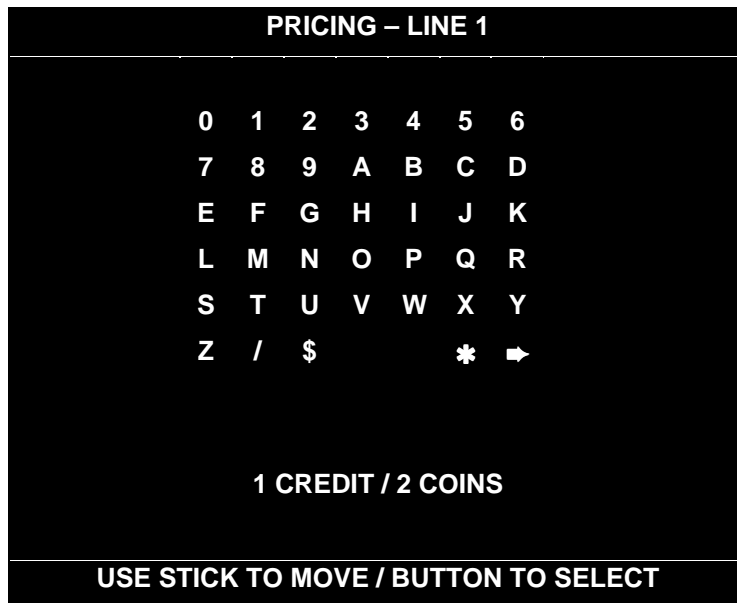

### SCREEN MESSAGE MENU

After you complete your message, you may edit it by reentering the Screen Message Menu. To reenter the menu, choose EDIT from the Custom Pricing Menu.

<b>Main Menu (continued)</b>
<b>Adjustments Menu (continued)</b>
<b>Free Play Menu</b>

**Free Play**

Select FREE PLAY at the Adjustments Menu. Free play is a useful feature for promotions and long-term testing under play conditions. Enable free play to allow players to play the game without inserting currency. Disable free play to sell games.

Highlight an option with any player panel joystick. Select the option with any player panel button.

<b>Main Menu (continued)</b>
<b>Adjustments Menu (continued)</b>
<b>Attract Sound Menu</b>

**Attract Sound**

Select ATTRACT SOUND at the Adjustments Menu. The Attract Mode operates between games. It attempts to lure prospective players into trying your game. Attract Mode sound may not be appropriate for some locations. The Attract Sound Menu allows you to enable or disable the Attract Mode sound feature. You can turn Attract Mode sound on or off without changing the game volume level.

Highlight an option with any player panel joystick. Select the option with any player panel button.

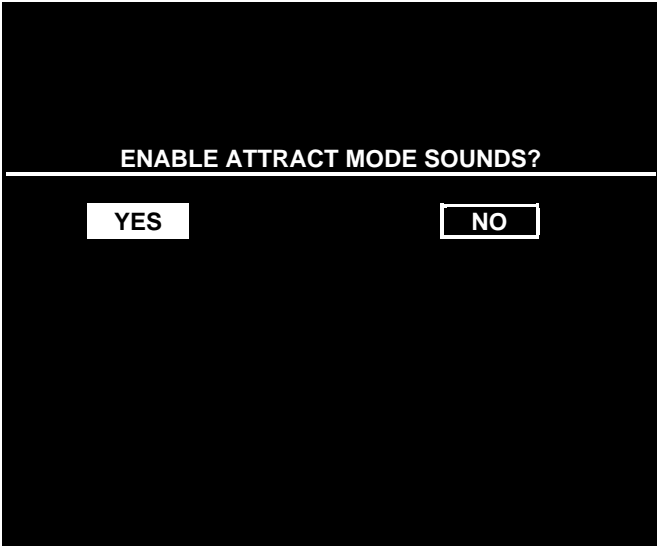

<b>Main Menu (continued)</b>
<b>Adjustments Menu (continued)</b>
<b>Additional Adjustments Menu</b>

**ADDITIONAL ADJUSTMENTS**

Select ADDITIONAL ADJUSTMENTS at the Adjustments Menu. Additional Adjustments menu items allow you to set the game to match player requirements. These adjustments affect speed, challenge, rewards, etc. that determine player enjoyment.

Highlight an option with any player panel joystick. Select the option with any player panel button.



**ADDITIONAL ADJUSTMENTS MENU**

**Game Difficulty** allows you to alter the challenge that a game poses to players. Choose the level that most closely matches the players' skills.

**Discount Price / Credits** adjusts the quantity of buy-in points to encourage multiple game purchases.

**Clock Speed** alters how much game time that a player can purchase for one credit. Choose one of these settings: Extra slow, slow, medium, fast or extra fast.

**Operator Message.** Enter your own, custom message at this menu. Program the message to turn on at the appropriate day and time.

**Free Games and Free Quarters.** Use these features to provide incentives to good players.

**Violence.** You can remove violence from the game without affecting other game play characteristics.

**Bad Language.** You can remove rough language without affecting other game play characteristics.

**Clear Player Records** allows you to delete stored game play data.

**Tournament Mode,** when enabled, adapts your game's scoring for tournament-style play.

**Attract Movie Sound**, when enabled, allows Attract Mode movie sound with Attract Mode sound off. The Attract Mode movie is only one component of the Attract Mode graphics.

<b>Main Menu (continued)</b>
<b>Adjustments Menu (continued)</b>
<b>Full Factory Restore Menu</b>

### FULL FACTORY RESTORE

Select FULL FACTORY RESTORE at the Adjustments Menu. The Full Factory Restore menu allows you to clear all memory counters at once.

Highlight an option with any player panel joystick. Select the option with any player panel button.



**FULL FACTORY RESTORE MENU**

	<p><b>NOTICE:</b> Examine and record audit information before you make changes. Once you've cleared the counters, you can't retrieve previous data from the system.</p>
---	---

Examine and record utility values before you make changes. If you choose YES, the system restores all adjustments and audits to factory default values. This change isn't reversible. The system can't restore the previous values. With the settings restored, the system displays the Reset Complete Menu.

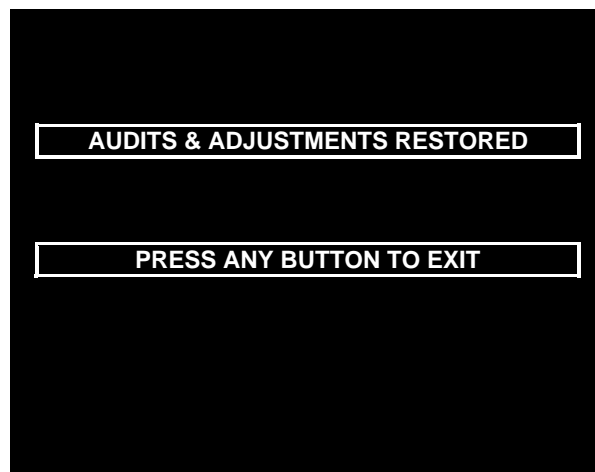

**RESET COMPLETED MENU**

**Main Menu (continued)**

**Volume Level Menu**

**VOLUME LEVEL**

Select VOLUME LEVEL at the Main Menu. Music plays continuously with the Volume Level screen.

Raise or lower the game's sound level with any player panel joystick. (You can also use the volume up/down buttons on the diagnostic switch bracket.) Save your change and return to the Main Menu by pressing any player panel button.

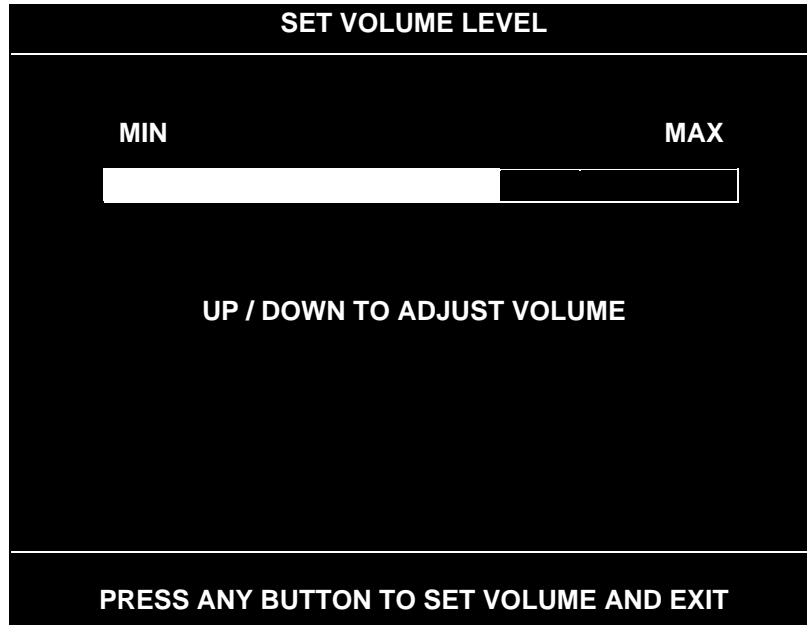

**VOLUME LEVEL SCREEN**

Loud games attract more player interest than games with low-level sound. The Attract Mode sound level is lower than the game play sound level.

You can turn Attract Mode sound on or off without changing the game volume level (see Adjustments).



**NOTICE:** These adjustments affect the volume of tests as well as of game play. If you set volume levels to minimum (zero), the speakers are silent during audio tests. We recommend setting volume levels to a moderately high value whenever you perform sound tests. After you complete tests, you may return sound levels to previous settings.

**Main Menu (continued)**

**Utilities Menu**

**UTILITIES**

Select UTILITIES at the Main Menu. Utilities Menu items allow you to clear bookkeeping totals. From the Utilities Menu, you can also restore game adjustments to factory settings.

Highlight an option with any player panel joystick. Select the option with any player panel button.



**UTILITIES SCREEN**

**Dump Audits** allows you to send data to the game computer's serial port. You can connect a serial printer to make a paper record of your audit data.

**Clear Credits** opens a menu that allows you to zero the game's credit data. Examine and record audit information before you make changes.

**Clear Audits** opens a menu that allows you to zero the game's audit data.

**Reset High Scores** permits you to delete player names and scores that appear in the Attract Mode. This feature may be useful if players insert inappropriate language into the high score table.

**Default Adjustments** opens a menu that allows you to reset game adjustments to factory settings.

**Full Factory Restore** allows you to reset game adjustments and audits to factory settings.





**NOTICE:** Be careful when clearing audit information. Once you clear data, you can't restore it.

# ***SPORTSTATION™***

## CHAPTER FOUR

---

### **DIAGNOSTIC, AUDIT & ADJUSTMENT MENU SYSTEM FOR *NBA SHOWTIME 2000* GAMES**

	<p><b>NOTICE:</b> Information in this manual is subject to change without notice. Midway reserves the right to make improvements in equipment as progress in engineering warrants.</p>
	<p><b>NOTICE: GAME-SELECTION SWITCH.</b> Select <i>NBA Showtime</i> or <i>NFL Blitz</i> by flipping switch 8 at DIP bank U13. Then power down and up again. The Attract Mode for the game you select will appear. <i>The player can still play either game.</i></p>

## MENU SYSTEM

### WHAT IS THE MENU SYSTEM?

The game's Menu System is a series of auditing, game adjustment and diagnostic screens. You can easily access and apply these screens to optimize game performance. For instance...

- Use game audits screens to assess game performance.
- Use adjustment screens to help you to customize game performance. For instance, you can restore factory default game settings. You can also calibrate player controls for accuracy.
- Use diagnostic screens to verify proper equipment operation.

### ACTIVATING THE MENU SYSTEM

Open the coin door. Find the TEST MODE switch inside. Press TEST MODE to invoke the Menu System. The game system responds by exiting Game Mode and entering Diagnostic Mode.

### AUTOMATIC TESTS

In Diagnostic Mode, the Power-On Self-Test (POST) activates. This routine runs automatically. It can detect faults that cause game or Menu System malfunctions. POST usually takes less than a minute. The test doesn't display anything. Instead, the system boot loader indicates the software revision number and serial numbers. The system boot loader also displays a sound-loading message and other useful information.

At the end of POST, the system displays the Control Functions Menu.

### CONTROL FUNCTIONS

The Control Functions Menu is purely informational. It appears for five seconds. Then the Menu System automatically displays the Dual Game Adjustment Menu.

The Control Functions Menu introduces the menu navigation controls. The key point is that you can use either player or diagnostic controls to navigate menus. Diagnostic control switches are particularly helpful when you must troubleshoot player switches. This manual discusses the controls in more detail in this chapter's *Main Menu* section. Also see the page on the menu that interests you.

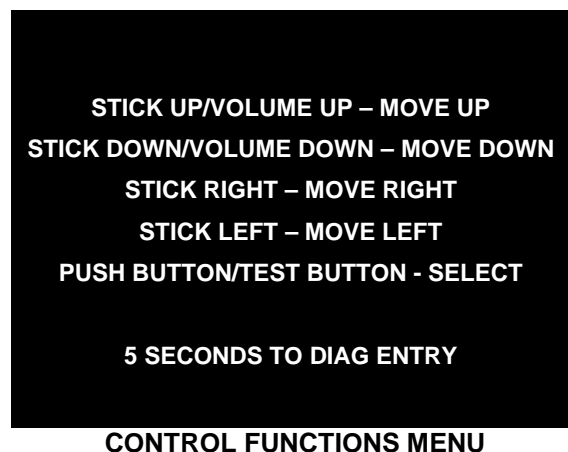



## DUAL GAME ADJUSTMENT MENU

The Dual Game Adjustment Menu is another informational, read-only menu. It appears until you choose to exit. This menu reminds you that some *NFL* settings also affect *NBA* game play. Press any button to exit to the Main Menu.

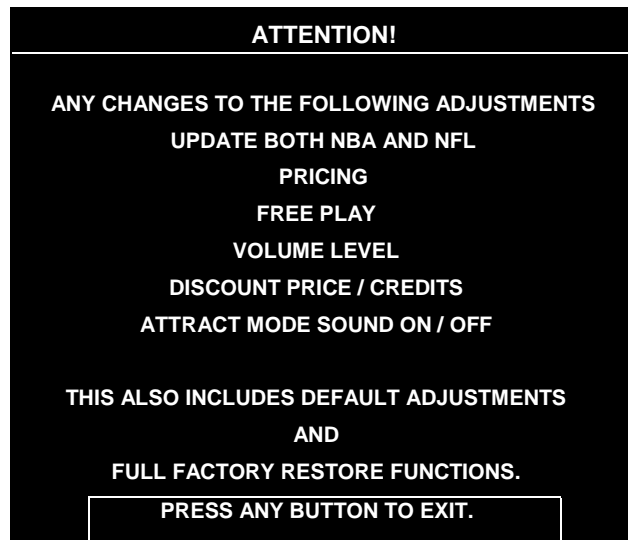

DUAL GAME ADJUSTMENT MENU

## MAIN MENU

The Main Menu offers you access to the game machine's test, bookkeeping and programmable features. Game audits, adjustments and diagnostics are line items on the Main Menu. Selecting an item opens its submenu. Every submenu presents various options that you may act upon.

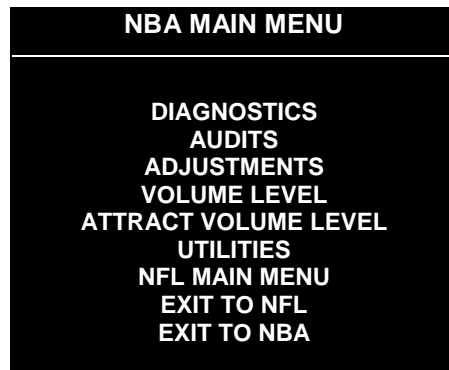

MAIN MENU

## MENU LAYOUT

Menus differ, but related information tends to occupy the same screen locations.

- The block at the top, center of each screen displays the current menu title.
- Data (menu items, video signals, statistics, reports, etc.) appears in the center of the screen.
- Messages (explanations, control functions, revision levels) display at the bottom of the screen.

## MENU NAVIGATION CONTROLS

Use any player panel joystick to highlight a desired menu item. *You can only select one highlighted item at a time.* To select a highlighted item, press any player panel button. Operator control buttons inside the coin door serve as backup menu navigation controls. Press VOLUME UP or VOLUME DOWN buttons to highlight a menu item. Press TEST MODE to select a highlighted item.

## EXIT OPTIONS

To exit the NBA menus and simultaneously enter the NFL menus, choose NFL MAIN MENU. To return the game to play, highlight either EXIT TO NFL or EXIT TO NBA. Your choice determines the game that will boot. Next, press any button.

## **DIAGNOSTICS**

Select **DIAGNOSTICS** at the Main Menu. Diagnostic tests allow you to verify the condition of the electrical and electronic hardware in the game.

Highlight a test with any player panel joystick. Select the option with any player panel button.

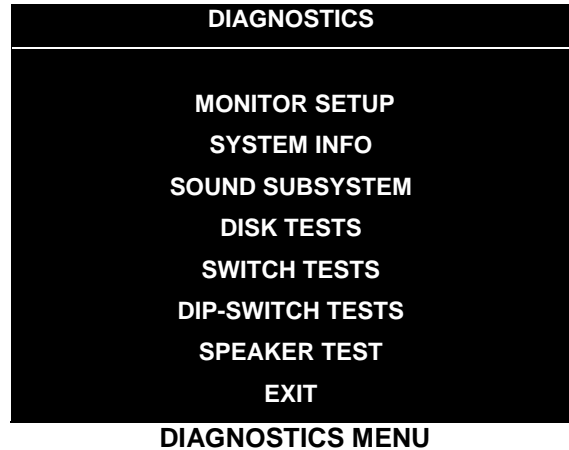

Diagnostic tests assist you in checking and adjusting the game's major systems. By running diagnostics, you can gain an insight into both system hardware and game software. Periodically running diagnostics is a crucial part of maintaining game performance and player satisfaction. Sometimes you can improve game performance by running a diagnostic test and making appropriate adjustments.

<b>Main Menu <i>(continued)</i></b>
<b>Diagnostics Menu <i>(continued)</i></b>
<b>Monitor Setup Menu</b>

**MONITOR SETUP**

Select MONITOR SETUP at the Diagnostics Menu. The Monitor Patterns routine provides test screens to verify monitor performance or make adjustments.

Highlight an option with any player panel joystick. Select the option with any player panel button.

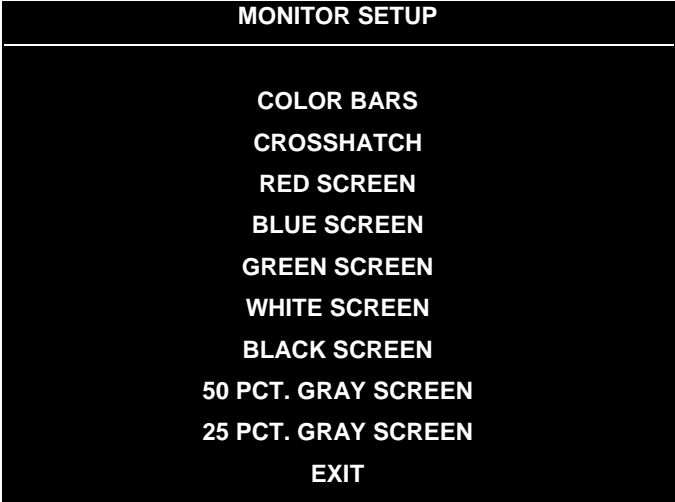

**MONITOR SETUP MENU**

**Color Bars** fills the screen with colored stripes. Use the color bars to help you to check or adjust monitor brightness and contrast. The color bars also expose defects in horizontal linearity. Each color bar consists of 32 intensity levels. On a properly adjusted monitor, the top 31 of these levels are visible. Each bar should appear sharp, clear and distinct from bars on either side. Incorrect adjustment can cause missing detail at the top or bottom of a bar. Bent bars indicate horizontal linearity flaws, such as pie crust, pincushion or barrel distortion. *(Correct color bar colors, left to right: Red, Green, Blue, Black, White, Cyan, Yellow, Violet.)* Set controls as follows: 1. Adjust BRIGHTNESS and CONTRAST to minimum. 2. Turn up BRIGHTNESS until the pixels in the black stripe begin to glow (turn dark gray). 3. Bring up the CONTRAST control until you can see 31 bars.

**Crosshatch Patterns** fill the screen with a grid and a series of dots. Crosshatch Patterns help you to check or adjust several monitor parameters: These include convergence, linearity, active viewing area and dynamic focus. The grid and the dots should be all white in color, with no fringes or parallel images. The lines should be straight and the dots round. For more detail on these adjustments, consult service literature from the monitor manufacturer.

**Color Screen** tests fill the screen with 100% of the chosen color at normal intensity. The Color Screen tests help you to check or adjust monitor intensity, black level, blanking and color purity. Each screen should be absolutely uniform from top to bottom and side to side. No retrace lines or noise should be visible. Color Screens may not hold their uniformity if the monitor degaussing circuit is defective.

**White, Gray and Black Screens** fill the screen with black, gray or white at various intensities. These monochrome screens help you to check or adjust monitor convergence, purity, contrast and intensity. These screens also simplify black level and color gun control settings. The screens should be uniform with no color tints or distortion. No retrace lines or noise should be visible.

If tests indicate a need for adjustment, use controls on the Monitor Remote Adjustment Board.

<b>Main Menu (continued)</b>
<b>Diagnostics Menu (continued)</b>
<b>System Information Menu</b>

**SYSTEM INFORMATION**

Select SYSTEM INFO at the Diagnostics Menu. The System Information Menu provides the current version numbers of this game’s hardware and software. Use these numbers to describe the system during parts replacement, service calls, etc.

Highlight an option with any player panel joystick. Select the option with any player panel button.



The System Information screen reports information, but doesn’t permit you to make changes. The Title line identifies the manufacturer of this game and the electronic board set used in this product. The Serial Number, Game and Date of Manufacture identify the game name and production run.

**Main Menu (continued)**

**Diagnostics Menu (continued)**

**Sound Subsystem Menu**

### **SOUND SUBSYSTEM TEST**

Select SOUND SUBSYSTEM at the Diagnostics Menu. Sound Subsystem Tests verify that audio components are connected and operate properly.

Highlight an option with any player panel joystick. Select the option with any player panel button.

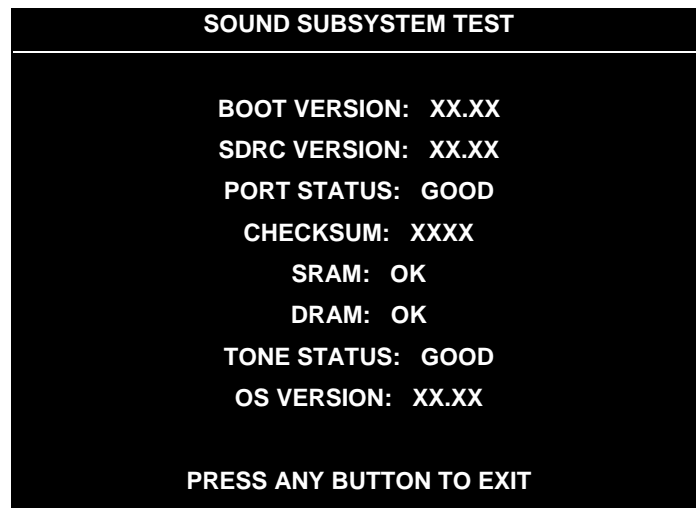

### **SOUND SUBSYSTEM MENU**

**Version, Status, Checksum and RAM Reports** are diagnostic routines. These routines analyze the digital sound circuits and can detect sound memory problems. Test results appear as numbers or messages. Sounds may also accompany some tests. Reports other than GOOD or OK indicate a problem.

<b>Main Menu (continued)</b>
<b>Diagnostics Menu (continued)</b>
<b>Disk Tests Menu</b>

**DISK TESTS**

Select DISK TESTS at the Diagnostics Menu. Disk Tests allow you to verify proper operation of the hard disk drive assembly.

Highlight an option with any player panel joystick. Select the option with any player panel button.

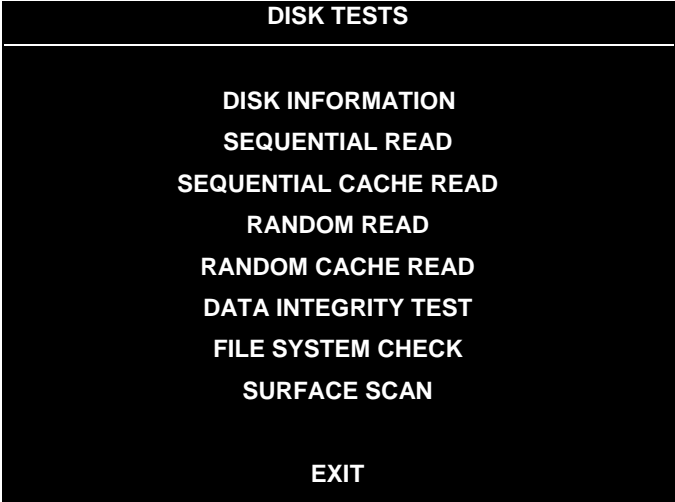

**DISK TESTS MENU**

**Disk Information.** The Disk Information routine verifies the interface between the CPU Board Assembly and hard disk drive. The processor requests disk information. Data cannot be retrieved successfully if there is a problem.

**Sequential Read.** This routine tries to access every bit of data in the order it is stored directly on the disk. The hard disk drive media may be defective if this routine cannot be completed successfully.

**Sequential Cache Read.** This routine tries to access every bit of data in the order it is stored in the temporary disk memory cache. If this test is not successful, the memory circuits may be faulty.

**Random Read.** This routine tries to access every bit of data in no particular order directly from the disk. This test may detect problems with ability to position the drive heads accurately over the requested data.

**Random Cache Read.** This routine tries to access every bit of data in no particular order from the temporary disk memory cache. If the cache fails this test, memory circuits may contain a fault.

**Data Integrity Test.** This test analyzes the data on the disk drive. The test determines if corrupted data is on the disk. Bad data can cause the program to falter even though the hard disk operates correctly.

**File System Check.** This routine performs a file-by-file check of the data stored on the hard disk.

**Surface Scan.** The magnetic material on the disk can become damaged, causing data to be unreadable. This routine locates unusable areas on the disk and marks them for future reference.

<b>Main Menu (continued)</b>
<b>Diagnostics Menu (continued)</b>
<b>Switch Tests Menu</b>

**SWITCH TESTS**

Select SWITCH TESTS at the Diagnostics Menu. Switch Tests verify proper operation of the game's switches, including buttons and joystick switches.

Activate each switch, and the indicator on the screen changes state. Release the switch and the indicator returns to its previous, normally open or closed condition. You can test any combination of switches together. To exit the test, simultaneously press the middle two control buttons inside the coin door. The Switch Test Screen refers to these buttons as "volume buttons."

**PLAYER SWITCH INPUTS TEST**

P1 UP	■	P3 UP	■	LEFT COIN	■
P1 DOWN	■	P3 DOWN	■	RIGHT COIN	■
P1 LEFT	■	P3 LEFT	■	P1 START	■
P1 RIGHT	■	P3 RIGHT	■	SLAM/TILT	■
P1 SHOOT	■	P3 SHOOT	■	TEST	■
P1 PASS	■	P3 PASS	■	P2 START	■
P1 TURBO	■	P3 TURBO	■	SERVICE CREDIT	■
P2 UP	■	P4 UP	■	CENTER COIN	■
P2 DOWN	■	P4 DOWN	■	EXTRA COIN	■
P2 LEFT	■	P4 LEFT	■	P3 START	■
P2 RIGHT	■	P4 RIGHT	■	P4 START	■
P2 SHOOT	■	P4 SHOOT	■	VOLUME DOWN	■
P2 PASS	■	P4 PASS	■	VOLUME UP	■
P2 TURBO	■	P4 TURBO	■	BILL VALID.	■

P1 49 WAY	P2 49 WAY	P3 49 WAY	P4 49 WAY
24	24	24	24

**PRESS BOTH PLAYER 1 AND PLAYER 2 START BUTTONS TO EXIT**

**SWITCH TEST SCREEN**

**Switches** appear on the screen as colored boxes. Red boxes indicate an open state. Green indicates closed. Any other color indicates a fault condition. A single indication on the menu screen should exactly duplicate a button or joystick change. You'll notice a unique number for a switch recognized by game electronics.

Use Switch Tests to locate crossed wires, intermittent conditions and stuck switches.

	<p><b>NOTICE:</b> Some switches may not be used with this game. If you can't find one of the listed switches, check the wiring diagram.</p>
---	---

<b>Main Menu (continued)</b>
<b>Diagnostics Menu (continued)</b>
<b>DIP Switch Tests Menu</b>

### DIP-SWITCH TESTS

Select DIP-SWITCH TESTS at the Diagnostics Menu. Two 8-position DIP switch banks reside on the SIO Board. DIP-Switch Tests allow you to check the position of the 16 switches in these banks. You can change the setting of any DIP switch without removing the circuit board cage.

The screen displays an illustration of each switch block and the current settings. You can change DIP-switch positions with power on. Set any switch, and then check the screen to verify that the new setting is enabled.

Refer to the charts for assistance in choosing switch positions. (\* indicates factory defaults.) To exit the DIP-switch Test, press the left control button (inside the coin door).

**Game-Selection Switch.** Select *NBA Showtime* or *NFL Blitz* by flipping switch 8 at DIP bank U13. Then power down and up again. After you change the game play, you must change game artwork.

<b>DIP Switch 1 (U13)</b>		SW1	SW2	SW3	SW4	SW5	SW6	SW7	SW8
Coinage Control	DIP Switch CMOS	Off On*							
USA1	Ger1 Fr ECA1 UK1		Off*	Off*	Off*				
USA2	Ger2 Fr ECA2 UK2		On	Off	Off				
USA3	Ger3 Fr ECA3 UK3		Off	On	Off				
USA4	Ger4 Fr ECA4 UK4		On	On	Off				
USA5	Ger5 Fr ECA5 UK5		Off	Off	On				
USA6	Ger6 Fr ECA6 UK6		On	Off	On				
USA7	Ger7 Fr ECA7 UK ECA		Off	On	On				
USA	ECA / Ger ECA / Fr ECA8		On	On	On				
Free Play	(All Countries)		On	On	On				
Country	USA France Germany UK**					Off* On Off On	Off* Off On On		
Unused	-- --							Off* On	
Game	NBA on NBC NFL Blitz								Off* On

\*\*Except Free Play, which is "on" for SW2 through SW6.

<b>DIP Switch 2 (U12)</b>		SW1	SW2	SW3	SW4	SW5	SW6	SW7	SW8
Joystick Type	8-Way 49-Way	Off On*							
Monitor Resolution	Medium Res Low Res		Off* On						
Unused	-- --			Off* On					
Unused	-- --				Off* On				
Unused	-- --					Off* On			
Player Panel Type	2-Player 4-Player						Off On*		
Power Up Test	Active Inactive							Off On*	
Operating Mode	Game Mode Test Mode								Off* On



<b>Main Menu (continued)</b>
<b>Diagnostics Menu (continued)</b>
<b>Speaker Test Menu</b>

**SPEAKER TEST**

Select SPEAKER TEST at the Diagnostics Menu. The Speaker Test provides audio signals to test the loudspeakers.

Use tests on the Speaker Test menu to verify operation of audio system components. Highlight an option with any player panel joystick. Select the option with any player panel button.



**SPEAKER TEST MENU**

**Channel and Tone Tests.** The channel subtests employ voice announcements to verify speaker locations. Use the 100 Hz tone to check the speakers’ bass response. Small speakers with weak magnets or poor baffles may cause poor bass response.

**Play Tune** repeats a series of game sounds. Use PLAY TUNE to check speaker operation and fidelity. If your game has stereo speakers, run PLAY TUNE and test speaker phasing. Muddy, weak or distorted sound during this test may indicate crossed wires or out-of-phase speaker connections. Missing sounds may indicate audio cabling errors.

	<p><b>NOTICE:</b> Check the volume setting before testing. To test the speakers thoroughly, increase the volume level. Before returning to Game-Over Mode, reset the volume level to its original setting.</p>
--	--

**Main Menu (continued)**

**Audits Menu**

**AUDITS**

Select AUDITS at the Main Menu. The Audits menus permit you to review game play statistics. Additional menus give detailed reports for each player position on game starts, ends, cabinet abuse, fault conditions, etc.

Highlight an option with any player panel joystick. Select the option with any player panel button. The screen displays a list of the statistics available to you. Select an item to view the detailed report.



**AUDITS MENU**

Data in the Audits menus helps you to keep records of the game's popularity and earning potential. Use the highlight bar to select the desired subject on the Audits Menu. Each entry on the Audits Menu is the subject for an entire screen of bookkeeping information. On these screens, you can track favorite teams, frequently used offensive and defensive plays, etc.

Some audits menus also include histograms. Histogram screens allow graphical analysis of statistics. This permits visual comparisons between games. Histograms have no bar graphs until the system acquires enough data to plot.

Examine and record all game audit values before performing game service or repairs.



**NOTICE:** Be careful when clearing audit information. Once you clear data, you cannot restore it.

<b>Main Menu (continued)</b>
<b>Audits Menu (continued)</b>
<b>Coin Audits Menu</b>

### COIN AUDITS

Select COIN AUDITS at the Audits Menu. The Coin Audits menu permits you to assess the currency collection. This report screen presents revenue quantities and other important game statistics. Coin Audits is a read-only screen.

To exit, press any player panel button.

<b>COIN AUDITS - PAGE: 1</b>	
<b>LEFT SLOT COINS</b>	<b>XXXXXXXX</b>
<b>RIGHT SLOT COINS</b>	<b>XXXXXXXX</b>
<b>BILLS</b>	<b>XXXXXXXX</b>
<b>CENTER SLOT COINS</b>	<b>XXXXXXXX</b>
<b>EXTRA SLOT COINS</b>	<b>XXXXXXXX</b>
<b>GAME STARTS</b>	<b>XXXXXXXX</b>
<b>MID-GAME STARTS</b>	<b>XXXXXXXX</b>
<b>CONTINUES</b>	<b>XXXXXXXX</b>
<b>CHALLENGER ACCEPTED</b>	<b>XXXXXXXX</b>
<b>FREE QUARTERS AWARDED</b>	<b>XXXXXXXX</b>
<b>FREE GAMES AWARDED</b>	<b>XXXXXXXX</b>
<b>SERVICE CREDITS</b>	<b>XXXXXXXX</b>
<b>UP – NEXT / BUTTON - EXIT</b>	
<b>COIN AUDITS MENU</b>	

The Coin Audits menu reports total quantities of coins, bills or credits collected by each active device. The menu doesn't calculate the value of the collected currency.

This screen reports information, but doesn't permit you to make changes. To reset the coin, bill and credit counters to zero, use the Clear Audits menu.

We recommend that you examine and record audit information before you make changes. Once you've cleared the counters, you can't retrieve the previous data from the system.

<b>COIN AUDITS – PAGE: 2</b>	
<b>TOTAL PLAYS</b>	<b>XXXXXXXX</b>
<b>TOTAL PAID CREDITS</b>	<b>XXXXXXXX</b>
<b>TOTAL</b>	<b>XXXXXXXX</b>
<b>DOWN - PREV / BUTTON - EXIT</b>	
<b>COIN AUDITS MENU, PAGE 2</b>	

<b>Main Menu (continued)</b>
<b>Audits Menu (continued)</b>
<b>Credits Audits Menu</b>

**CREDITS AUDITS**

Select CREDITS AUDITS at the Audits Menu. The Credits Audits menu permits you to assess the currency collection. This report screen presents revenue quantities and other important game statistics. Credits Audits is a read-only screen.

To exit, press any player panel button.

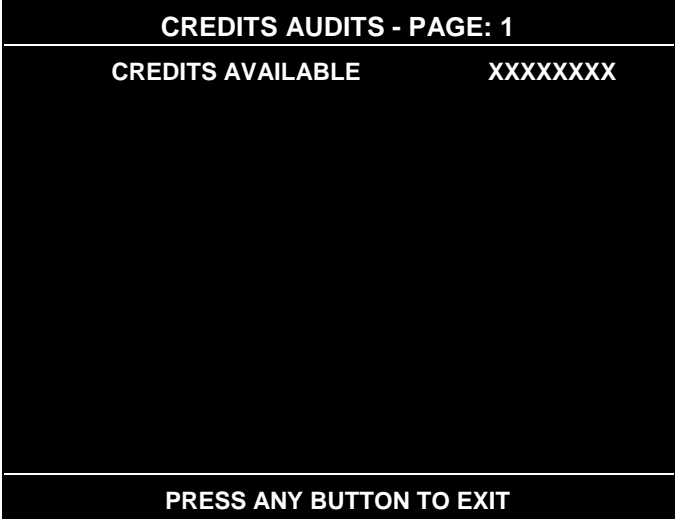

**CREDITS AUDITS MENU**

<b>Main Menu (continued)</b>
<b>Audits Menu (continued)</b>
<b>Game Audits Menu</b>

### GAME AUDITS

Select GAME AUDITS at the Audits Menu. The Game Audits menus permit you to review the game play statistics. Game Audits is a read-only screen.

To exit, press any player panel button.

GAME AUDITS - PAGE: 1			
MACHINE POWER-ON	XX	WENT INTO OVERTIME 1	XX
TOTAL UPTIME	XX	WENT INTO OVERTIME 2	XX
TOTAL PLAYTIME	XX	WENT INTO OT 3	XX
GAMES STARTED	XX	1 PLAYER FINISHES	XX
INITIALS ENTERED	XX	2 PLAYER FINISHES	XX
<FG> PURCHASED AT START	XX	3 PLAYER FINISHES	XX
CREATE PLAYER SESSIONS	XX	4 PLAYER FINISHES	XX
1 PLAYER	XX	2P V CPU FINISHES	XX
2 PLAYER	XX	H VS H LSW'S	XX
3 PLAYER	XX	CPU WINS (FG)	XX
4 PLAYER	XX	AVG H VS H TOTAL SCORE (FG)	XX
2PV CPU	XX	AVG H VS CPU TOTAL SCORE (FG) AVG	XX
1 QUARTER GAMES	XX	AVG H VS H WIN SCORE (FG)	XX
2 QUARTER GAMES	XX	AVG H VS H LOSS SCORE (FG)	XX
3 QUARTER GAMES	XX	BIGGEST CPU WIN MARGIN (FG)	XX
4 QUARTER GAMES	XX	BIGGEST CPU LOSS MARGIN (FG)	XX
	XX		
	XX		
	XX		
	XX		
	XX		
	XX		

### GAME AUDITS MENU

The Game Audits menu reports information, but doesn't permit you to make changes. Examine and record information at GAME AUDITS before deleting data at the Clear Audits Menu. Once you've cleared the counters, you can't retrieve the previous data from the system.

### GAME AUDIT MENU TERMS

SCREEN TERM	DEFINITION	SCREEN TERM	DEFINITION
<b>AVG</b>	Average	<b>LSW</b>	Your game computer's internal record-keeping counters
<b>CPU</b>	Central Processing Unit: The game computer	<b>Machine Power-On</b>	Number of power cycles (game turn-ons)
<b>&lt;FG&gt;, (FG)</b>	Full Game	<b>OT</b>	Overtime
<b>H VS CPU</b>	Human versus CPU: Competition that pits players against the game computer	<b>PV</b>	Player versus...
<b>H VS H</b>	Human versus human: Competition between human players	<b>Total Uptime</b>	Overall on-time for the game computer
		<b>2PV</b>	Two players versus...

<b>Main Menu (continued)</b>
<b>Audits Menu (continued)</b>
<b>Team Stats Menu</b>

**TEAM STATS**

Select TEAM STATS at the Audits Menu. The Team Stats Menu details the number of games played by each team in the league. Team Stats is a read-only screen.

To exit, press any player panel button.

<b>TEAM STATS – PAGE: 1</b>			
<b>ATLANTA HAWKS</b>	<b>0%</b>	<b>NEW JERSEY NETS</b>	<b>0%</b>
<b>BOSTON CELTICS</b>	<b>0%</b>	<b>NEW YORK NICKS</b>	<b>0%</b>
<b>CHARLOTTE HORNETS</b>	<b>0%</b>	<b>ORLANDO MAGIC</b>	<b>0%</b>
<b>CHICAGO BULLS</b>	<b>0%</b>	<b>PHILADELPHIA 76ERS</b>	<b>0%</b>
<b>CLEVELAND CAVALIERS</b>	<b>0%</b>	<b>PHOENIX SUNS</b>	<b>0%</b>
<b>DALLAS MAVERICKS</b>	<b>0%</b>	<b>PORTLAND TRAILBLAZERS</b>	<b>0%</b>
<b>DENVER NUGGETS</b>	<b>0%</b>	<b>SACRAMENTO KINGS</b>	<b>0%</b>
<b>DETROIT PISTONS</b>	<b>0%</b>	<b>SAN ANTONIO SPURS</b>	<b>0%</b>
<b>GOLDEN STATE WARRIORS</b>	<b>0%</b>	<b>SEATTLE SUPERSONICS</b>	<b>0%</b>
<b>HOUSTON ROCKETS</b>	<b>0%</b>	<b>TORONTO RAPTORS</b>	<b>0%</b>
<b>INDIANAPOLIS PACERS</b>	<b>0%</b>	<b>UTAH JAZZ</b>	<b>0%</b>
<b>LOS ANGELES CLIPPERS</b>	<b>0%</b>	<b>VANCOUVER GRIZZLIES</b>	<b>0%</b>
<b>LOS ANGELES LAKERS</b>	<b>0%</b>	<b>WASHINGTON WIZARDS</b>	<b>0%</b>
<b>MIAMI HEAT</b>	<b>0%</b>		
<b>MILWAUKEE BUCKS</b>	<b>0%</b>		
<b>MINNESOTA TIMBERWOLVES</b>	<b>0%</b>		

**PRESS ANY BUTTON TO EXIT**

**TEAM STATS MENU**

<b>Main Menu (continued)</b>
<b>Audits Menu (continued)</b>
<b>Game Features Menu</b>

**GAME FEATURES**

Select GAME FEATURES at the Audits Menu. Game Features tracks play statistics that relate characters in the game and game play. Game Features is a read-only screen.

To exit, press any player panel button.

<b>GAME FEATURES – PAGE: 1</b>			
<b>NUMBER OF PLAYER RECORDS</b>	<b>0</b>	<b>CREATP CUSTOM UNIFORM</b>	<b>0</b>
<b>NUMBER OF LRU RECORDS</b>	<b>0</b>	<b>CREATP TEAM UNIFORM</b>	<b>0</b>
<b>RECORDS FROM CREATE PLAYER</b>	<b>0</b>	<b>CREATP NICKNAME</b>	<b>0</b>
<b>NUMBER OF PLAYER FIRE</b>	<b>0</b>	<b>CREATP AVG HEIGHT PTS</b>	<b>0</b>
<b>AVG PTS PLAYER FIRE</b>	<b>0</b>	<b>CREATP AVG WEIGHT PTS</b>	<b>0</b>
<b>NUMBER OF TEAM FIRE</b>	<b>0</b>	<b>CREATP AVG PWR PTS</b>	<b>0</b>
<b>AVG PTS TEAM FIRE</b>	<b>0</b>	<b>CREATP AVG SPEED PTS</b>	<b>0</b>
<b>NUMBER OF ALLEY OOPS</b>	<b>0</b>	<b>CREATP AVG TWOPTS PTS</b>	<b>0</b>
<b>NUMBER OF DOUBLE DUNKS</b>	<b>0</b>	<b>CREATP AVG STEAL PTS</b>	<b>0</b>
<b>CREATP MASCOT HEADS</b>	<b>0</b>	<b>CREATP AVG BLOCK PTS</b>	<b>0</b>
<b>CREATP NBA HEADS</b>	<b>0</b>	<b>CREATP AVG DUNK PTS</b>	<b>0</b>
<b>CREATP FEMALE HEADS</b>	<b>0</b>	<b>PRIV1</b>	<b>0</b>
<b>CREATP UM HEADS</b>	<b>0</b>	<b>PRIV2</b>	<b>0</b>
<b>CREATP MID HEADS</b>	<b>0</b>	<b>PRIV3</b>	<b>0</b>
<b>CREATP OTHER HEADS</b>	<b>0</b>		
<b>CREATP DEFAULT UNIFORM</b>	<b>0</b>		

UP – NEXT / BUTTON - EXIT

**GAME FEATURES MENU, PAGE 1**

**Number Of Player Records.** Number of player initial sets entered in CMOS RAM.

**Number Of LRU Records.** Number of record slots (space for player data) left in CMOS RAM.

**Records From Create Player.** Number of player records produced in Create Player Mode.

**Number Of Player Fire.** Number of times a player has started on fire.

**Avg Pts Player Fire.** Average number of points that player scored while player was on fire.

**Number Of Team Fire.** Number of times that the team has started on fire.

**Avg Pts Team Fire.** Average number of points that the team scored while it was on fire.

**Number Of Alley Oops.** Total number of alley oops performed.

**Number Of Double Dunks.** Total number of double dunks performed.

**Creatp Mascot Heads.** Number of player-created characters with mascot heads.

**Creatp NBA Heads.** Number of player-created characters with NBA-personality heads.

**Creatp Female Heads.** Number of player-created characters with female heads.

**Creatp UM Heads.** Number of player-created characters with Universal Studios® monster heads.

**Creatp Mid Heads.** Number of player-created characters with Midway Games® heads.

**Creatp Other Heads.** Number of player-created characters with custom heads.

**Creatp Default Uniform.** Number of player-created characters with the selected team's uniforms.

**Creatp Custom Uniform.** Number of player-created characters with custom uniforms.

**Creatp Team Uniform.** Number of player-created characters with specific team uniforms.

**Creatp Nickname.** Number of player-created characters with nicknames.

**Creatp Avg Height Pts.** Average height attribute setting.

**Creatp Avg Weight Pts.** Average weight attribute setting.

**Creatp Avg Pwr Pts.** Average power attribute setting.

**Creatp Avg Speed Pts.** Average speed attribute setting.

**Creatp Avg TwoPts Pts.** Average two-point shot attribute setting.

**Creatp Avg Steal Pts.** Average stealing attribute setting.

**Creatp Avg Block Pts.** Average blocking attribute setting.

**Creatp Avg Dunk Pts.** Average dunking attribute setting.

**Priv1.** Number of times player-created characters include privilege 1 (a player selection).

**Priv2.** Number of times player-created characters include privilege 2 (a player selection).

**Priv3.** Number of times player-created characters include privilege 3 (a player selection).

**Priv4.** Number of times player-created characters include privilege 4 (a player selection).

**Priv5.** Number of times player-created characters include privilege 5 (a player selection).

**Priv6.** Number of times player-created characters include privilege 6 (a player selection).

**Priv7.** Number of times player-created characters include privilege 7 (a player selection).

**Priv8.** Number of times player-created characters include privilege 8 (a player selection).

**Game With Creatp.** Number of games played with player-created characters.

**Win V CPU With Creatp.** Number of player-won games with player-created characters.

**Win V Human With Creatp.** Number of computer-won games with player-created characters.

**Tournament Games.** Number of games played in Tournament-Scoring Mode.

**Timer Level.** Speed at which game machine produces time-released and created characters.

**TLF's.** A counter employed by designers (has no purpose in the field).

**SBLF's.** A counter employed by designers (has no purpose in the field).

Highlight an option with any player panel joystick. Select the option with any player panel button.



**GAME FEATURES – PAGE: 2**

PRIV4	0
PRIV5	0
PRIV6	0
PRIV7	0
PRIV8	0
GAME WITH CREATP	0
WIN V CPU WITH CREATP	0
WIN V HUMAN WITH CREATP	0
TOURNAMENT GAMES	0
TIMER LEVEL	0
TLF'S	0
SBLF'S	0

**DOWN – PREV / BUTTON - EXIT**

**GAME FEATURES MENU, PAGE 2**

<b>Main Menu (continued)</b>
<b>Audits Menu (continued)</b>
<b>Exception Dump Menu</b>

**EXCEPTION DUMP**

Select EXCEPTION DUMP at the Audits Menu. Game programmers use the Exception Dump Menu to view register contents during program development. This menu has no field purpose. Exception Dump is a read-only menu.

To exit, press any player panel button.

<b>Main Menu (continued)</b>
<b>Audits Menu (continued)</b>
<b>Clear Audits Menu</b>

**CLEAR AUDITS**

Select CLEAR AUDITS at the Audits Menu. The Clear Audits menu allows you to clear individual memory counters or to reset them all at once.

Highlight an option with any player panel joystick. Select the option with any player panel button.



**CLEAR AUDITS MENU**

You can reset any audit screen from the Clear Audits Menu. Choose an item and zero its counter. CLEAR ALL simultaneously changes all audit categories to factory default values. After you've selected an item, the system gives you the opportunity to escape this change. For example:



**LAST CHANCE MENU**

After you've selected and verified a clear function, the values reset. The system can't restore the previous values. Examine and record utility values before you make changes.

**Main Menu (continued)**

**Adjustments Menu**

## **ADJUSTMENTS**

Select **ADJUSTMENTS** at the Main Menu. The Adjustments menus permit you to change game characteristics. Use these screens to optimize game performance and earnings.

Highlight an option with any player panel joystick. Select the option with any player panel button.



**Main Menu (continued)**

**Adjustments Menu (continued)**

**Pricing Menu**

## **PRICING**

Select **PRICING** at the Adjustments Menu. The Pricing menus allow you to view current settings or change the cost of games. Custom pricing allows you to select the number of coins or credits required for each game. The game restores factory default values if you exchange the CPU Board or if the backup battery fails.

Highlight an option with any player panel joystick. Select the option with any player panel button.

You may reset options to factory defaults or change an option after viewing it. We recommend examining and recording pricing options before making changes.

You may save several custom prices and then choose between them as needed. On-screen instructions guide you through the process of creating custom price settings.

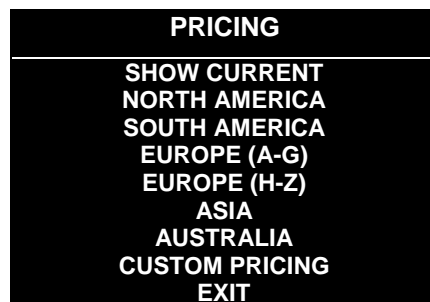

An additional box appears on screen to explain the available functions as you select each item.

## STANDARD PRICING TABLE

NAME	START	CONTINUE	CREDITS/COIN	COIN 1	COIN 2	COIN 3	COIN4	BILL
ANTILLIES	2	2	1/25¢, 4/1G	.25¢	1G			
AUSTRALIA 1	2	2	1/3X20¢, 2/\$1.00	.20¢	\$1.00			
AUSTRALIA 2	2	2	1/5X20¢, 1/\$1.00	.20¢	\$1.00			
AUSTRIA 1	2	2	1/5Sch, 2/10Sch	5 Sch	10 Sch			
AUSTRIA 2	2	2	1/2X5Sch, 3/2X10Sch	5 Sch	10 Sch			
BELGIUM 1	2	2	1/20BF	20BF	20BF			
BELGIUM 2	2	2	3/20BF	20BF	20BF			
BELGIUM 3	2	2	2/20BF	20BF	20BF			
BELGIUM ECA	2	2	1/20BF	50BF	20BF	5BF		
CANADA 1	2	2	1 / 2 x 25¢, 3 / \$1	25¢	25¢			
CANADA 2	2	2	1 / 2 x 25¢, 3 / \$1	25¢	\$1.00			
CANADA 3	2	2	3 / \$1.00, 6 / \$2.00	\$1.00	\$2.00			
CANADA ECA	2	2	1 / 2 x 25¢, 3 / \$1	25¢		\$1.00	\$2.00	
DENMARK	2	2	3/5DKr, 7/10DKr	5DKr	10DKr			
FINLAND	2	2	1/1Fmk	1Fmk	5Fmk			
FRANCE 1	2	2	2/5Fr, 5/10Fr	5Fr	10Fr			
FRANCE 2	2	1	2/5Fr, 4/10Fr	5Fr	10Fr			
FRANCE 3	2	1	1/5Fr, 3/10Fr	5Fr	10Fr			
FRANCE 4	2	1	1/5Fr, 2/10Fr	5Fr	10Fr			
FRANCE 5	2	1	2/5Fr, 5/10Fr, 11/2 X 10Fr	5Fr	10Fr			
FRANCE 6	2	1	2/5Fr, 4/10Fr, 9/2 X 10Fr	5Fr	10Fr			
FRANCE 7	2	1	1/5Fr, 3/10Fr, 7/2 X 10Fr	5Fr	10Fr			
FRANCE 8	2	1	1/5Fr, 2/10Fr, 5/2 X 10Fr	5Fr	10Fr			
FRANCE 9	2	1	1/3 X 1Fr, 2/5Fr	1Fr	5Fr			
FRANCE 10	2	1	1/2 X 1Fr, 3/5Fr	1Fr	5Fr			
FRANCE 11	2	1	1/3 X 1Fr, 2/5Fr, 5/2 X 5Fr	1Fr	5Fr			
FRANCE 12	2	1	1/2 X 1Fr, 3/5Fr, 7/2 X 5Fr	1Fr	5Fr			
FRANCE ECA 1	1	1	2/5Fr, 5/10Fr	1Fr	5Fr	10Fr	20Fr	
FRANCE ECA 2	1	1	2/5Fr, 4/10Fr	1Fr	5Fr	10Fr	20Fr	
FRANCE ECA 3	1	1	1/5Fr, 3/10Fr	1Fr	5Fr	10Fr	20Fr	
FRANCE ECA 4	1	1	1/5Fr, 2/10Fr	1Fr	5Fr	10Fr	20Fr	
FRANCE ECA 5	1	1	2/5Fr, 5/10Fr, 11/2 X 10Fr	1Fr	5Fr	10Fr	20Fr	
FRANCE ECA 6	1	1	2/5Fr, 4/10Fr, 9/2 X 10Fr	1Fr	5Fr	10Fr	20Fr	
FRANCE ECA 7	1	1	1/5Fr, 3/10Fr, 7/2 X 10Fr	1Fr	5Fr	10Fr	20Fr	
FRANCE ECA 8	1	1	1/5Fr, 2/10Fr, 5/2 X 10Fr	1Fr	5Fr	10Fr	20Fr	
FRANCE ECA 9	1	1	1/3 X 1Fr, 2/5Fr	1Fr	5Fr	10Fr	20Fr	
FRANCE ECA 10	1	1	1/2 X 1Fr, 3/5Fr	1Fr	5Fr	10Fr	20Fr	
FRANCE ECA 11	1	1	1/3 X 1Fr, 2/5Fr, 5/10Fr	1Fr	5Fr	10Fr	20Fr	
FRANCE ECA 12	1	1	1/2 X 1Fr, 3/5Fr, 7/10Fr	1Fr	5Fr	10Fr	20Fr	
FRANCE ECA 13	1	1	1/10Fr, 2/20Fr, 4/30Fr	1Fr	5Fr	10Fr	20Fr	
FREE PLAY	--	--	--	None	None	None	None	None
GERMANY 1	2	2	1/1DM, 6/5DM	1DM	5DM			
GERMANY 2	2	1	1/1DM, 7/5DM	1DM	5DM			
GERMANY 3	2	1	1/1DM, 8/5DM	1DM	5DM			
GERMANY 4	2	1	1/1DM, 5/5DM	1DM	5DM			
GERMANY 5	2	1	1/1DM, 6/5DM	1DM	5DM			
GERMANY ECA 1	2	2	1/1DM, 2/2DM, 6/5DM	5DM	2DM	1DM		
GERMANY ECA 2	2	1	1/1DM, 2/2DM, 6/5DM	5DM	2DM	1DM		
GERMANY ECA 3	1	1	1/1DM, 2/2DM, 6/5DM	5DM	2DM	1DM		
HUNGARY	2	2	1/2X10Ft, 3/2X20Ft	10Ft	20Ft			
ITALY	2	2	1/500Lit	500Lit	500Lit			
JAPAN 1	2	2	1/100Yen	100	100			
JAPAN 2	2	2	2/100Yen	100	100			
NETHERLANDS	2	2	1/1HFI, 3/2.5HFI	1HFI	2.5HFI			
NEW ZEALAND 1	1	1	1/\$1	\$1	\$2			
NEW ZEALAND 2	1	1	2/\$1	\$1	\$2			
NORWAY	2	2	3/5NKr, 6/10NKr	5NKr	10NKr			
SPAIN 1	2	2	1/100Pta, 6/500Pta	100Pta	500Pta			
SPAIN 2	2	2	1/100Pta, 5/500Pta	100Pta	500Pta			
SWEDEN	2	2	1/3X1SKr, 2/5SKr	1SKr	5SKr			
SWITZERLAND 1	2	2	1/1SFr, 6/5SFr	1SFr	5SFr			
SWITZERLAND 2	2	2	1/1SFr, 7/5SFr	1SFr	5SFr			
SWITZERLAND 3	2	2	1/1SFr, 8/5SFr	1SFr	5SFr			

(Table continues on next page)

**STANDARD PRICING TABLE, *continued***

NAME	START	CONTINUE	CREDITS/COIN	COIN 1	COIN 2	COIN 3	COIN4	BILL
UK ECA 1	1	1	1/50p, 3/£1.00	£1.00	50p	20p	10p	£2.00
UK ECA 2	1	1	1/50p, 2/£1.00	£1.00	50p	20p	10p	£2.00
UK ECA 3	1	1	1/30p, 2/50p, 5/£1.00	£1.00	50p	20p	10p	£2.00
UK 4	1	1	1/50p, 3/£1.00	£1.00	50p			
UK 5	1	1	1/50p, 2/£1.00	£1.00	50p			
UK ECA 6	1	1	1/30p, 2/50p, 4/£1.00	£1.00	50p	20p	10p	£2.00
UK ECA 7	1	1	3/£1.00	£1.00	50p	20p	10p	£2.00
UK ECA 8	1	1	1/50p, 2/£1.00, 4/£2.00	£1.00	50p	20p	10p	£2.00
USA1	2	2	1/25¢	25¢	25¢			\$1.00
USA2	2	1	1/25¢	25¢	25¢			\$1.00
USA3	1	1	1/25¢	25¢	25¢			\$1.00
USA4	1	1	1/50¢, 3/\$1.00	25¢	25¢			\$1.00
USA5	2	1	1/50¢, 4/\$1.00	25¢	25¢			\$1.00
USA6	1	1	1/50¢	25¢	25¢			\$1.00
USA7	1	1	1/50¢, 3/\$1.00	25¢	25¢			\$1.00
USA8	2	2	1/50¢, 4/\$1.00	25¢	25¢			\$1.00
USA9	3	2	1/25¢, 4/\$1.00	25¢	25¢			\$1.00
USA10	3	3	1/25¢, 4/\$1.00	25¢	25¢			\$1.00
USA11	4	2	1/25¢, 4/\$1.00	25¢	25¢			\$1.00
USA12	4	3	1/25¢, 4/\$1.00	25¢	25¢			\$1.00
USA13	4	4	1/25¢, 4/\$1.00	25¢	25¢			\$1.00
USA ECA	3	3	1/25¢, 4/\$1.00	\$1.00	25¢	10¢	05¢	\$1.00

<b>Main Menu (continued)</b>
<b>Adjustments Menu (continued)</b>
<b>Pricing Menu (continued)</b>
<b>Current Pricing Menu</b>

### Current Pricing

Select SHOW CURRENT at the Pricing Menu. The Current Pricing Menu is a read-only screen. Use it to check pricing parameters for the pricing table your game is using. To select a new pricing table, return to the Pricing Menu. To invent your own pricing table, select Custom Pricing on the Pricing Menu.

Press any START button to exit from the menu.

<b>CURRENT PRICING</b>	
<b>LEFT SLOT UNITS</b>	<b>XX</b>
<b>RIGHT SLOT UNITS</b>	<b>XX</b>
<b>CENTER SLOT UNITS</b>	<b>XX</b>
<b>EXTRA SLOT UNITS</b>	<b>XX</b>
<b>BILL VALIDATOR UNITS</b>	<b>XX</b>
<b>UNITS PER CREDIT</b>	<b>XX</b>
<b>UNITS PER BONUS</b>	<b>XX</b>
<b>MINIMUM UNITS</b>	<b>XX</b>
<b>CREDITS TO START</b>	<b>XX</b>
<b>CREDITS TO CONTINUE</b>	<b>XX</b>
<b>MAX CREDITS</b>	<b>XX</b>
<b>COINS PER BILL</b>	<b>XX</b>

### CURRENT PRICING MENU

The following table clarifies Pricing Menu terms:

<b>SCREEN TERM</b>	<b>DISCUSSION</b>
<b>Slot Units; Bill Validator (DBV) Units</b>	Cyber-currency. This adjustment assigns a number of "units" to each coin mechanism or bill acceptor. For instance, if a quarter buys 1 unit, then \$1 buys 4 units. ( <i>See Coins per Bill.</i> ) You insert a coin into a 1-unit coin acceptor. The system, due to its programming, knows that your coin is worth one unit.
<b>Units per Credit</b>	How many units equal one credit. (Units buy credit, the price of one game.)
<b>Units per Bonus</b>	Units awarded when a player earns a bonus.
<b>Minimum Units</b>	Until this many units accumulate, the system awards no credits.
<b>Credits to Start</b>	Number of games a player must purchase to begin play.
<b>Credits to Continue</b>	Number of games a player must purchase to resume play.
<b>Max Credits</b>	Limits the number of credits that the game will accept.
<b>Coins per Bill</b>	How many coins one bill is worth.

<b>Main Menu (continued)</b>
<b>Adjustments Menu (continued)</b>
<b>Pricing Menu (continued)</b>
<b>Custom Pricing Menu</b>

### Custom Pricing

Select CUSTOM PRICING at the Pricing Menu. The Custom Pricing Menu permits you to program and use your own pricing table. The menu heading CREATING XXXX allows you to input a descriptive name for your new pricing table. You can save several pricing schemes and chose between them as desired.

Highlight an option with any player panel joystick. Change the option with any player panel button. Press any START button to save your pricing table and exit from the menu.

<b>CREATING XXXX</b>			
<b>LEFT UNITS</b>	<b>XX</b>	<b>RIGHT UNITS</b>	<b>XX</b>
<b>CENTER UNITS</b>	<b>XX</b>	<b>EXTRA UNITS</b>	<b>XX</b>
<b>DBV UNITS</b>	<b>XX</b>	<b>UNITS PER CREDIT</b>	<b>XX</b>
<b>UNITS / BONUS</b>	<b>XX</b>	<b>MINIMUM UNITS</b>	<b>XX</b>
<b>CREDITS TO START</b>	<b>XX</b>	<b>CREDITS TO CONT.</b>	<b>XX</b>
<b>MAX CREDITS</b>	<b>XX</b>	<b>COINS / BILL</b>	<b>XX</b>
<b>SHOW FRACTIONS</b>	<b>XX</b>	<b>LEFT COUNT</b>	<b>XX</b>
<b>RIGHT COUNT</b>	<b>XX</b>	<b>CENTER COUNT</b>	<b>XX</b>
<b>EXTRA COUNT</b>	<b>XX</b>	<b>DBV COUNT</b>	<b>XX</b>
<b>USE STICK TO SELECT AN ITEM TO MODIFY</b> <b>PRESS ANY BUTTON TO MODIFY THE ITEM</b> <b>PRESS ANY START BUTTON TO SAVE AND EXIT</b>			

### CUSTOM PRICING MENU

The Custom Pricing Menu employs the same terms that appear on the Current Pricing Table. See the table below for definitions of these terms.

### PRICING MENU TERMS

<b>SCREEN TERM</b>	<b>DISCUSSION</b>
<b>Slot Units; Bill Validator (DBV) Units</b>	Cyber-currency. This adjustment assigns a number of "units" to each coin mechanism or bill acceptor. For instance, if a quarter buys 1 unit, then \$1 buys 4 units. ( <i>See Coins per Bill.</i> ) You insert a coin into a 1-unit coin acceptor. The system, due to its programming, knows that your coin is worth one unit.
<b>Units per Credit</b>	How many units equal one credit. (Units buy credit, the price of one game.)
<b>Units per Bonus</b>	Units awarded when a player earns a bonus.
<b>Minimum Units</b>	Until this many units accumulate, the system awards no credits.
<b>Credits to Start</b>	Number of games a player must purchase to begin play.
<b>Credits to Continue</b>	Number of games a player must purchase to resume play.
<b>Max Credits</b>	Limits the number of credits that the game will accept.
<b>Coins per Bill</b>	How many coins one bill is worth.

**BASIC CUSTOM PRICING.** Custom pricing creates an imaginary currency exchange. In this currency exchange, the coins of the realm are “units.” Think of units as a type of cyber-currency, useful only within the game software. By inserting coins, you purchase units.

Since units are only negotiable within game software, the system stores your units for you. When the system receives enough units, it buys a game for you. The price of a game is one “credit.” You can think of credits as a second form of cyber-currency.

Even though you’ve now bought one game, you may not be able to begin playing. In many pricing schemes, you must buy two or more credits to begin play. The idea here is something like a minimum order of goods at a store. That is, the operator can “shrink-wrap” two or more games in a package. You can’t play unless you buy the entire package.

•**1 / 25¢ COIN; 1 CREDIT TO START.** In a simple, quarter pricing scheme, the player inserts one coin to buy one unit. The system exchanges that unit for one credit. If CREDITS TO START contains the value one, then play commences. A dollar bill buys four units.

Left Slot Units	Validator Units	Units / Credit	Credits to Start	Coins / Bill
1	4	1	1	4

•**1 / 3 X 25¢; 2 CREDITS TO START.** Again, assuming quarter slots, here’s one way to implement 75¢ pricing... In this scheme, each coin that the player inserts buys one unit. The system exchanges three units for one credit. CREDITS TO START contains the value two. To play, the player must pay for two credits. In this scheme, a dollar buys four units.

Left Slot Units	Validator Units	Units / Credit	Credits to Start	Coins / Bill
1	4	3	2	4

•**2 / 1 COIN; 6 CREDITS TO START.** Now let’s consider a more unusual pricing scheme. Here, the player can buy two units with one coin. The system exchanges each of these units for one credit. Notice that CREDITS TO START contains the value six. To play, the player must insert two more coins to pay for six credits. Also notice that if the player pays with a bill, the system throws in an extra unit.

Left Slot Units	Validator Units	Units / Credit	Credits to Start	Coins / Bill
2	9	1	6	4



<b>Main Menu (continued)</b>
<b>Adjustments Menu (continued)</b>
<b>Free Play Menu</b>

### Free Play

Select FREE PLAY at the Adjustments Menu. Free Play is a useful feature for promotions and long-term testing under play conditions. Enable Free Play to allow players to play the game without inserting currency. Disable Free Play to sell games.

Highlight an option with any player panel joystick. Select the option with any player panel button.

<b>Main Menu (continued)</b>
<b>Adjustments Menu (continued)</b>
<b>Attract Sound Menu</b>

### Attract Sound

Select ATTRACT SOUND at the Adjustments Menu. The Attract Mode operates between games. It attempts to lure prospective players into trying your game. Attract Mode sound may not be appropriate for some locations. The Attract Sound Menu allows you to enable or disable the Attract Mode sound feature. You can turn Attract Mode sound on or off without changing the game volume level.

Highlight an option with any player panel joystick. Select the option with any player panel button.

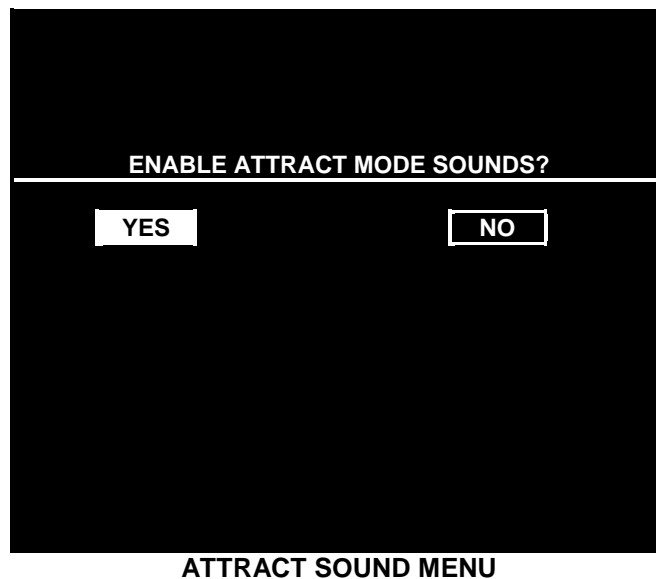

<b>Main Menu (continued)</b>
<b>Adjustments Menu (continued)</b>
<b>Additional Adjustments Menu</b>

**ADDITIONAL ADJUSTMENTS**

Select ADDITIONAL ADJUSTMENTS at the Adjustments Menu. Additional Adjustments menu items allow you to set the game to match player requirements. These adjustments affect speed, challenge, rewards, etc. that determine player enjoyment.

Highlight an option with any player panel joystick. Select the option with any player panel button.



**Game Difficulty** allows you to alter the challenge that a game poses to players. Choose the level that most closely matches the players' skills.

**Discount Price / Credits** adjusts the quantity of buy-in points to encourage multiple game purchases.

**Clock Speed** alters how much game time that a player can purchase for one credit. Choose one of these settings: Extra slow, slow, medium, fast or extra fast.

**Free Game**, when enabled, allows the program to award a free game. The free game may be a four-player or a one-on-one game. The free game may also involve competition against the game computer.

**Free Quarter**. The program divides games into quarters, as in NBA rules. The Free Quarter feature, when enabled, allows the program to award a free game quarter. The free quarter may be a four-player or a one-on-one quarter. The free quarter may also involve competition against the game computer.

**Clear Player Records** allows you to zero out game play data. Examine and record this information before you clear it. Once you've cleared player records, you can't retrieve the previous data.

**Clear World Records** allows you to zero out world record data. Examine and record this information before you clear it. Once you've cleared player records, you can't retrieve the previous data.

**Player Head Size** allows you to alter the head size of on-screen characters. This feature determines whether the characters appear more lifelike, or more like caricatures. Choose "normal" or "big."

**Tournament Mode**, when enabled, adapts your game's scoring for tournament-style play.

**Computer Assistance**, when enabled, permits the game computer to aid players in play action.

**Attract Movie Sound**, when enabled, allows Attract Mode movie sound with Attract Mode sound off. The Attract Mode movie is only one component of the Attract Mode graphics.

**Main Menu (continued)**

**Volume Level Menu**

**VOLUME LEVEL**

Select VOLUME LEVEL at the Main Menu. When you display the Volume Level Menu, music plays continuously.

Raise or lower the game's sound level with any player panel joystick. (You can also use the volume up/down buttons on the diagnostic switch bracket.) Save your change and return to the Main Menu by pressing any player panel button.

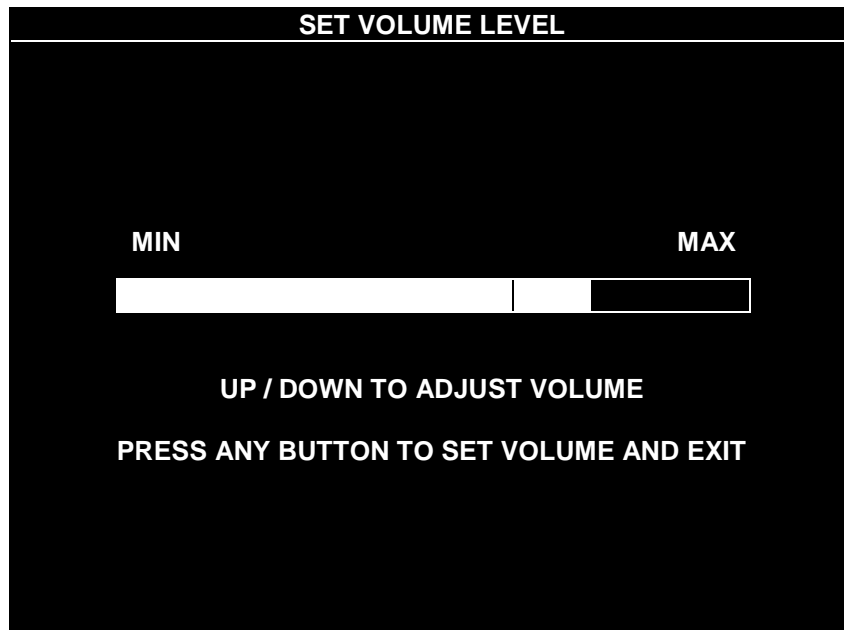

**VOLUME LEVEL MENU**

Loud games attract more player interest than games with low-level sound. The Attract Mode sound level is always lower than the game play sound level.



**NOTICE:** These adjustments affect the volume of tests as well as of game play. If you set volume levels to minimum (zero), the speakers are silent during audio tests. We recommend setting volume levels to a moderately high value whenever you perform sound tests. After you complete tests, you may return sound levels to previous settings.

<b>Main Menu (continued)</b>
<b>Adjustments Menu (continued)</b>
<b>Full Factory Restore Menu</b>

**FULL FACTORY RESTORE**

Select FULL FACTORY RESTORE at the Adjustments Menu. The Full Factory Restore menu allows you to clear all memory counters at once.

Highlight an option with any player panel joystick. Select the option with any player panel button.

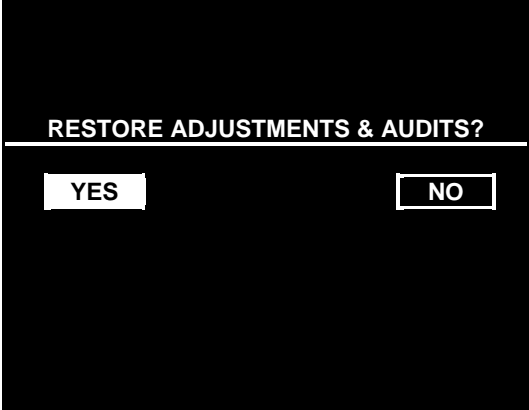

**FULL FACTORY RESTORE MENU**

	<p><b>NOTICE:</b> Examine and record audit information before you make changes. Once you've cleared the counters, you can't retrieve previous data from the system.</p>
---	---

Examine and record utility values before you make changes. If you choose YES, the system restores all adjustments and audits to factory default values. This change isn't reversible. The system can't restore the previous values. With the settings restored, the system displays the Reset Complete Menu.



**RESET COMPLETED MENU**

**Main Menu (continued)**

**Attract Mode Volume Level Menu**

**VOLUME LEVEL**

Select ATTRACT VOLUME LEVEL at the Main Menu. When you display the Attract Mode Volume Level Menu, music plays continuously.

Raise or lower the game's Attract Mode sound level with any player panel joystick. (You can also use the volume up/down buttons on the diagnostic switch bracket.) Save your change and return to the Main Menu by pressing any player panel button. Your setting won't affect the game play sound level.

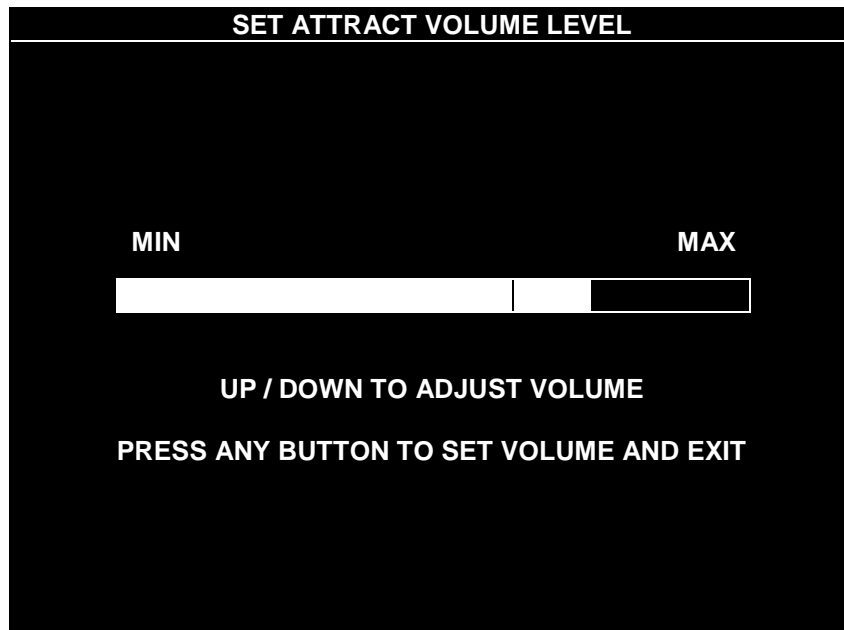

**ATTRACT MODE VOLUME LEVEL MENU**

Increase the Attract Mode sound level to generate player interest. The game play sound-level setting determines the maximum level for Attract Mode sound. Regardless of your setting, the Attract Mode level remains lower than the game play level.

**Main Menu (continued)**

**Utilities Menu**

**UTILITIES**

Select UTILITIES at the Main Menu. Utilities Menu items allow you to clear bookkeeping totals. From the Utilities Menu, you can also restore game adjustments to factory settings.

Highlight an option with any player panel joystick. Select the option with any player panel button.



**UTILITIES SCREEN**

**Dump Audits** allows you to send data to the game computer's serial port. You can connect a serial printer to make a paper record of your audit data.

**Clear Credits** opens a menu that allows you to zero the game's credit data. Examine and record audit information before you make changes.

**Clear Audits** opens a menu that allows you to zero the game's audit data.

**Reset High Scores** permits you to delete player names and scores that appear in the Attract Mode. This feature may be useful if players insert inappropriate language into the high score table.

**Default Adjustments** opens a menu that allows you to reset game adjustments to factory settings.

**Full Factory Restore** allows you to reset game adjustments and audits to factory settings.

**Discount Price / Credits** permits you to enter special game pricing or award extra credits. You can use this feature for advertising or promotional purposes.



**NOTICE:** Be careful when clearing audit information. Once you clear data, you can't restore it.

# *SPORTSTATION*<sup>TM</sup>

---

## CHAPTER FIVE

---

# PARTS



**WARNING:** Use of non-Midway parts or circuit modifications may cause serious injury or equipment damage! Use only Midway authorized parts.

For safety and reliability, don't substitute parts or modify MIDWAY products. Substitute parts or modifications may void the game's EMC directive or FCC type acceptance.

## CABINET FRONT VIEW



## MONITOR AND LAMP FIXTURE MOUNTING

## CABINET REAR VIEW

# CONTROL PANEL INSTALLATION

# CONTROL PANEL & HOUSING ASSEMBLY A-23467

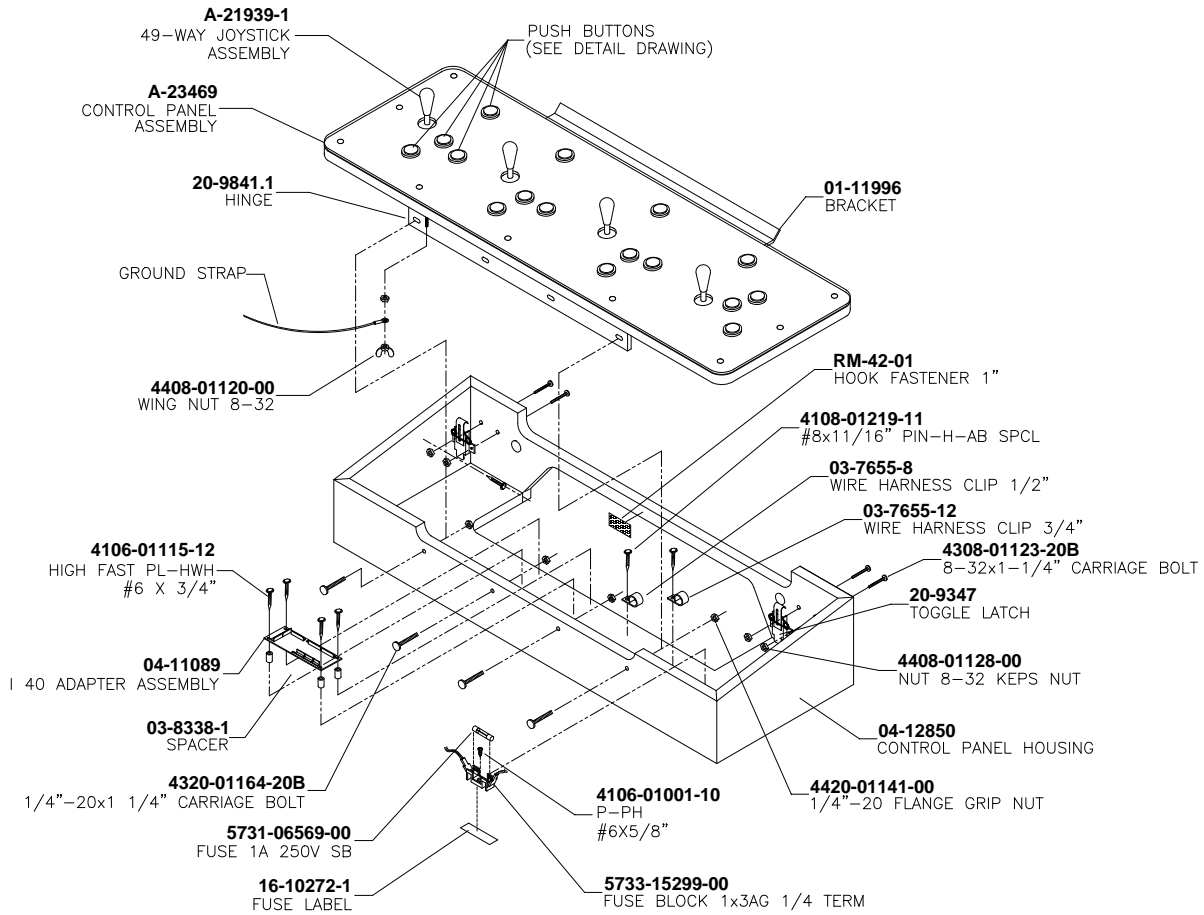

ASSOCIATED PARTS NOT SHOWN:

- |                   |                            |
|-------------------|----------------------------|
| <b>01-11955</b>   | SECURITY LATCH BRACKET (2) |
| <b>03-9796.1</b>  | CLEAR OVERLAY              |
| <b>04-12403.1</b> | CONTROL PANEL PLATE        |
| <b>31-1768</b>    | NBA HOLOGRAM DECAL         |
| <b>31-3478.1</b>  | SCREENED OVERLAY           |
| <b>31-3479-1</b>  | HOUSING DECAL DECAL, LEFT  |
| <b>31-3479-2</b>  | HOUSING DECAL DECAL, RIGHT |
| <b>31-3479-3</b>  | HOUSING DECAL DECAL, FRONT |

# PLAYER PANEL ASSEMBLY A-23469

# PLAYER PANEL EXPLODED VIEW

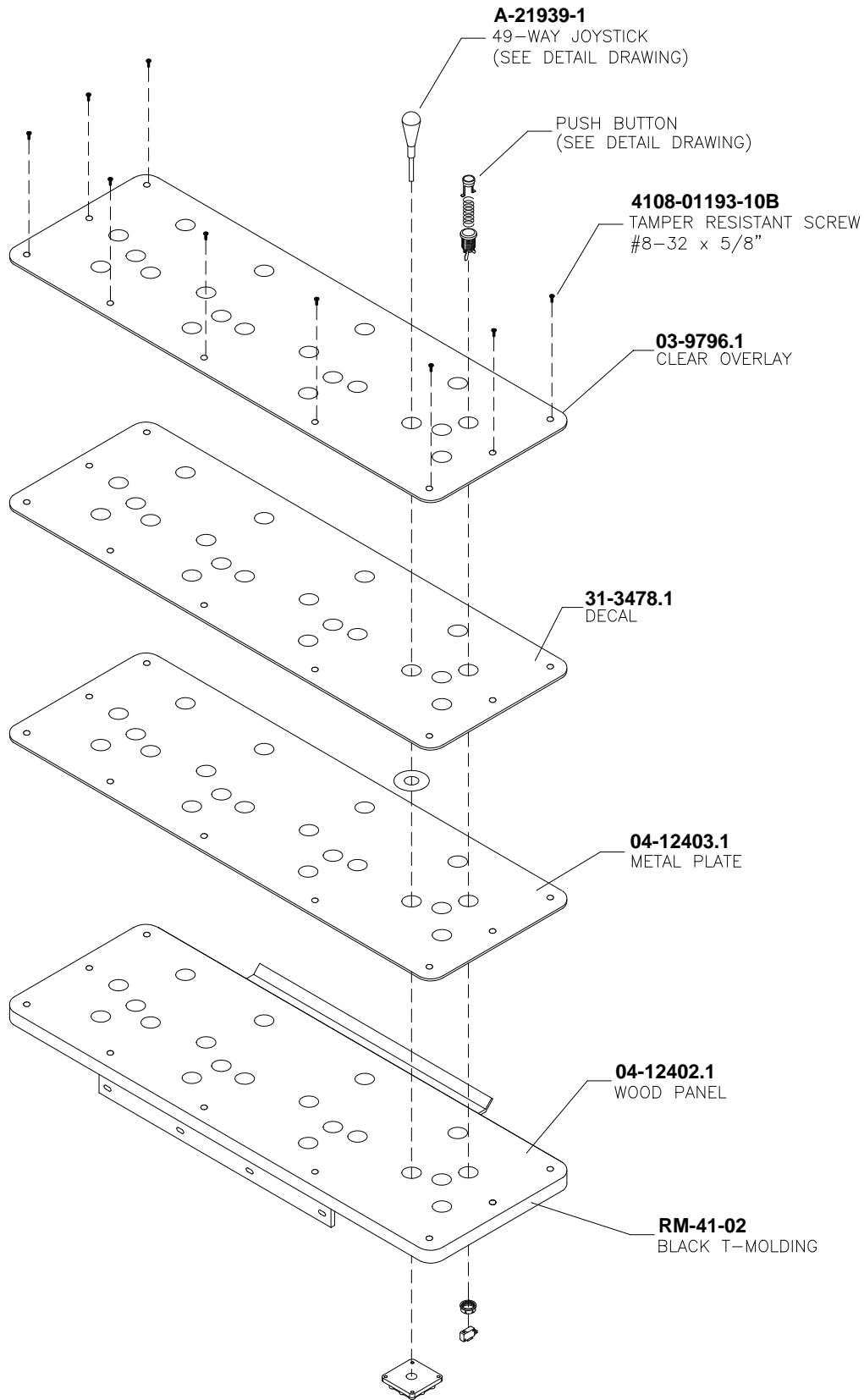

## COIN DOOR ASSEMBLY

## CASH DOOR ASSEMBLY

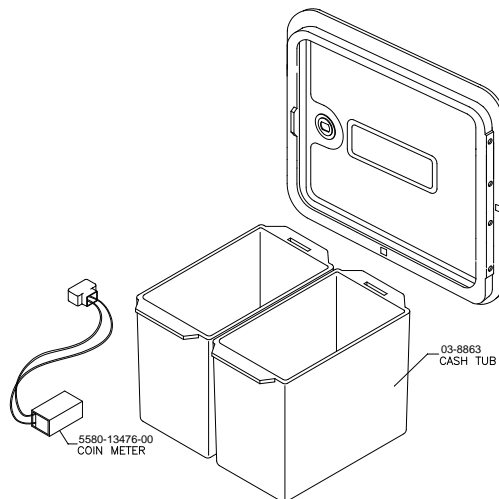

**49-WAY JOYSTICK ASSEMBLY A-21939-1  
AND BUTTON ASSEMBLY 20-10209-X**



# ELECTRONICS ASSEMBLY A-23483

## POWER SUPPLY 20-10167

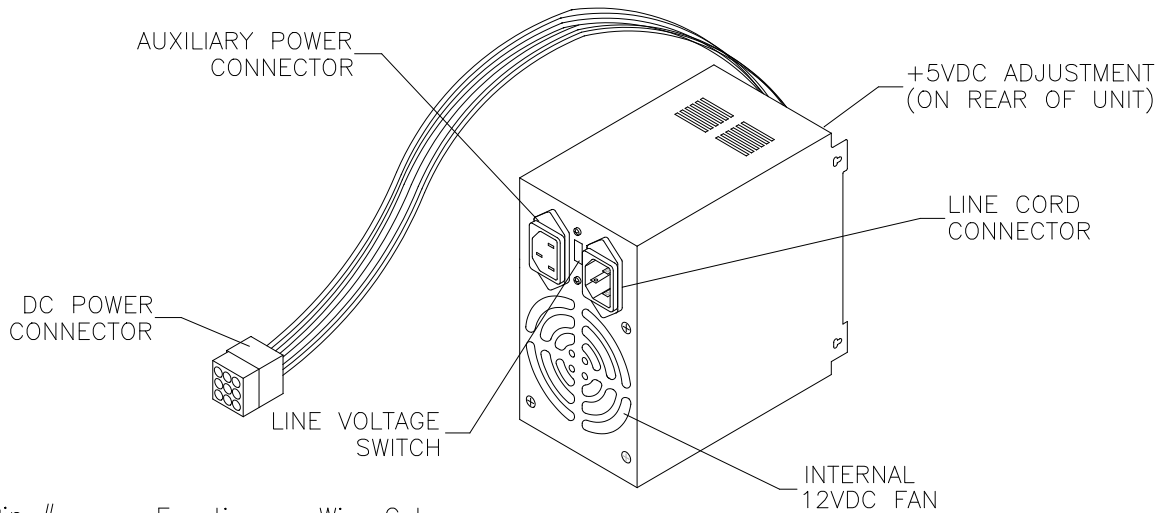

Pin #	Function	Wire Color
1, 2, 3	+5VDC	Red
4, 5, 6	Ground	Black
7	-5VDC	Yellow*
8	+12VDC	Orange*
9	-12VDC	Blue*

**\*Note:** Many computer grade power supplies use yellow for +12V, blue for -5V, and white for -12V. This is acceptable as long as the pinout is correct.

## SOUND I/O CARD A-23431

### Field Replaceable Parts

Description	Location	Part Number
Amplifier, 20W, TDA 7204A	U19, U20	5370-14146-00
Capacitor, 2200 $\mu$ F, 16V	C310	5040-15904-00
Capacitor, 2200 $\mu$ F, 25V	C254	5040-14630-00
Crystal, 4 MHz, Type HC49U	Y2	5520-14602-00
Crystal, 16 MHz, Type HC49U	Y3	5520-14595-00
Crystal, 20 MHz, 3-Lead Type	Y1	5520-15159-00
Heatsink, TO-220, Type 5298b	U19, U20	5705-12638-00
IC, TDA7240V, 20W Amplifier	U19, U20	5370-14146-00
Oscillator, 33 MHz, TTL, Tri-State	U3	5521-13806-06
ROM, Sound Boot	U44	A-5343-45994-2
Shunt, 0.025" Square Pins	Any Jumper	5882-13046-00

## CPU BOARD ASSEMBLY A-23429

### Field Replaceable Parts

Description	Location	Part Number
Capacitor, 2200 $\mu$ F, 16V, Radial	C24, C115, C209, C229, C294	<b>5040-15904-00</b>
Heatsink, TO-220, Small	U5	<b>5705-14562-00</b>
Heatsink, TO-220, Type 5298b	U15	<b>5705-12638-00</b>
PLD, CPU Configuration	U22	<b>A-22912</b>
Regulator, CS5203a	U5	<b>5250-16015-00</b>
ROM, Boot	U27	<b>A-5343-45994-1</b>
ROM, Expansion	U28	<b>For Future Use</b>

## **BANSHEE VIDEO CARD 20-10516**

**No Field-Replaceable Parts**

## AUXILIARY ADAPTER CARD ASSEMBLY 04-12652

**No Field-Replaceable Parts**

## I-40 BOARD ASSEMBLY 04-11089

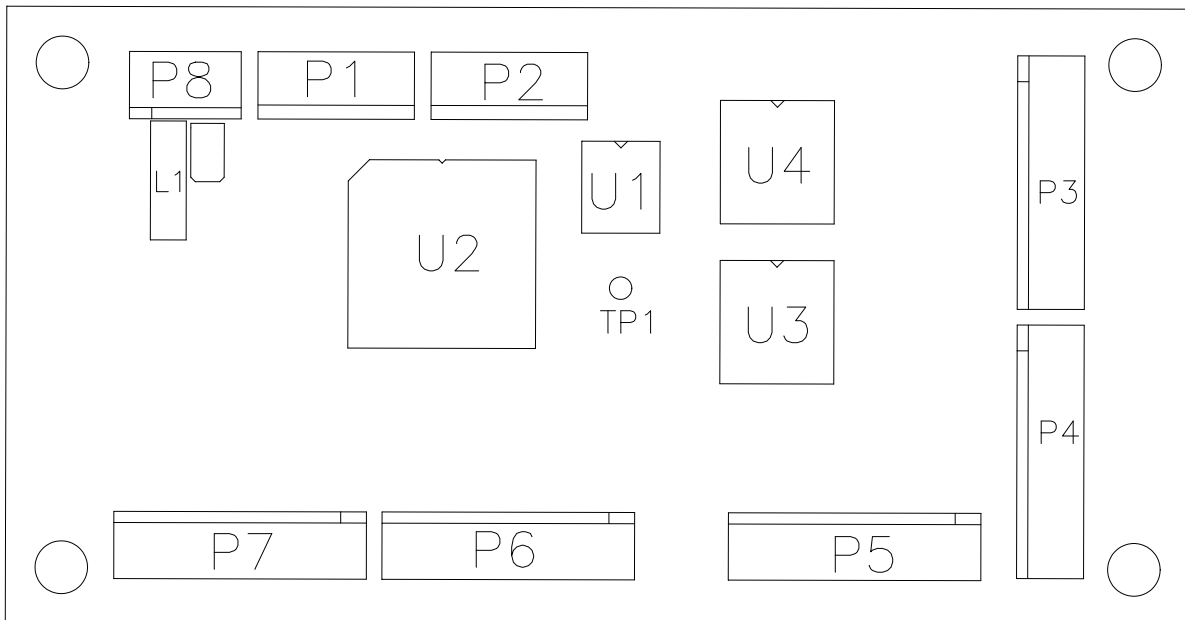

**No Field-Replaceable Parts**

## OTHER PARTS

### Bulbs, Filters and Fuses

Ballast, 15W.....	20-10481.1
Bulb, #555 6.3V, 0.25A, Wedge-Based Light.....	24-8768
Fuse, 1ASB, 250V.....	5731-06569-00
Fuse, 3ASB, 250V, 3AG.....	5731-10356-00
Holder, 1 x 3AG, ¼" Terminal Fuse.....	5733-15299-00
Tube, Fluorescent, 15W, 18".....	24-8809

### Cables

Braid, Ground with ¼" Terminal.....	H-22327-86
Cable, Coin Meter Extension.....	H-22786
Cable, Disk Drive Fan.....	H-22900.2
Cable, IDC AC.....	H-20353
Cable, Main Harness (JAMMA).....	H-22824.1
Cable, Ribbon, 40-Pin.....	5795-15344-07
Cable, Ribbon, 20-Pin.....	5795-10937-09
Cable, Shielded Video.....	20-10493
Cable, Stereo Speaker.....	H-22758
Cable, Fluorescent Lamp and Electronic Ballast.....	H-22507
Harness, Cabinet AC.....	A-22693

### Documents

Card, Game Information.....	16-10650
Manual, SportStation, 25".....	16-40094-101

### Kit, Spare Parts

Kit, Spare Parts.....	A-22561
Leveler, Leg Adjustment, 3".....	08-7377
Wrench, T-20, Long Arm Tamper-Resistant (Torx®).....	20-9620

### Meter, Coin

Meter, 5V, 2W Coin (with Diode).....	5580-13476-00
--------------------------------------	---------------

**LINE CORD APPLICATION TABLE**

<b>Part Number</b> <b>Country</b>	5850-13275-00	5850-13271-00	5850-13272-00	5850-13273-00	5850-13276-00	5850-13277-00	5850-13278-00
USA		■					
UK				■			
Italy	■						
Japan							■
New Zealand						■	
Germany			■				
Spain			■				
Denmark			■				
Finland			■				
Holland			■				
Norway			■				
Switzerland					■		
Hungary			■				
Canada		■					
Austria			■				
France			■				
Australia						■	
Belgium			■				

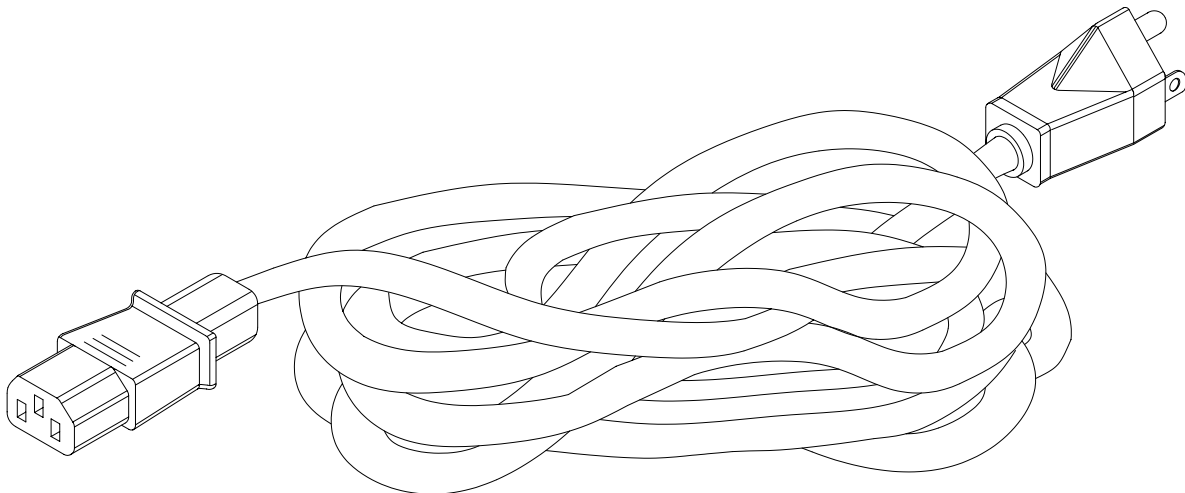

**TYPICAL I.E.C. LINE CORD WITH INLINE FEMALE PLUG**



**COIN DOOR APPLICATION TABLE**

<b>Part Number</b> <b>Country</b>	09-96017-15	09-96017-17	09-96017-33	09-96000.1
Australia				■
Austria				■
Belgium				■
Canada			■	
Denmark				■
Finland				■
France				■
Germany				■
Holland				■
Hungary				■
Italy				■
Japan	■			
New Zealand		■		
Norway				■
Spain				■
Switzerland				■
UK				■
<b>USA</b>			■	



# *SPORTSTATION*<sup>TM</sup>

---

## CHAPTER SIX

---

### WIRING



**WARNING:** Failure to reconnect ground wires or replace metal shields and covers with mounting hardware installed and properly tightened may result in radio frequency interference.

## JAMMA Chart

Function	Wire Color	Pin	Function	Wire Color	Pin
Ground	Black	A	Ground	Black	1
Ground	Black	B	Ground	Black	2
+5VDC	Red	C	+5VDC	Red	3
+5VDC	Red	D	+5VDC	Red	4
-5VDC	Yellow	E	-5VDC	Yellow	5
+12VDC	Orange	F	+12VDC	Orange	6
Key	N/C	H	Key	N/C	7
Coin Counter 2	Brown-Red	J	Coin Counter 1	Brown	8
Not Used	N/C	K	Not Used	N/C	9
Speaker -, Left	Brown-Gray	L	Speaker +, Left	Red-Gray	10
Speaker -, Right	Brown-White	M	Speaker +, Right	Red-White	11
Video Green	Yellow-Green	N	Video Red	Yellow-Red	12
Video Sync	Yellow-White	P	Video Blue	Yellow-Blue	13
Service Credits	White-Gray	R	Video Ground	Yellow-Black	14
Slam Tilt	Black-Green	S	Test	Black-Blue	15
Coin 2	Black-Red	T	Coin 1	Black-Brown	16
2 Start	Violet-White	U	1 Start	White	17
2 Up	Violet-Black	V	1 Up	White-Black	18
2 Down	Violet-Brown	W	1 Down	White-Brown	19
2 Left	Violet-Red	X	1 Left	White-Red	20
2 Right	Violet-Orange	Y	1 Right	White-Orange	21
2 Jump	Violet-Yellow	Z	1 Jump	White-Yellow	22
2 Pass	Violet-Green	a	1 Pass	White-Green	23
2 Turbo	Violet-Blue	b	1 Turbo	White-Blue	24
Not Used	Violet	c	Not Used	White-Violet	25
Not Used	N/C	d	Not Used	N/C	26
Ground	Black	e	-5V Ground	Yellow-Brown	27
Ground	Black	f	Ground	Black	28
<b>Solder Side of Circuit Board</b>			<b>Component Side of Circuit Board</b>		

### Control Panel Wires That Aren't Part of Main JAMMA Harness

Function	Wire Color	P14-	Function	Wire Color	P7-
4 Digital Ground	Black	1	3 Digital Ground	Black	1
+5 Volts	Red	2	Unused	Not Connected	2
Unused	Not Connected	3/4/15	Unused	Not Connected	3/4/15
4 Start	Gray-White	5	3 Start	Blue-White	6
4 Stick Up, Bit 0	Gray-Black	6	3 Stick Up, Bit 0	Blue-Black	7
4 Stick Down, Bit 1	Gray-Brown	7	3 Stick Down, Bit 1	Blue-Brown	8
4 Stick Left, Bit 2	Gray-Red	8	3 Stick Left, Bit 2	Blue-Red	9
4 Stick Right, Bit 3	Gray-Orange	9	3 Stick Right, Bit 3	Blue-Orange	10
4 Button A, Jump	Gray-Yellow	10	3 Button A, Jump	Blue-Yellow	11
4 Button B, Pass	Gray-Green	11	3 Button B, Pass	Blue-Green	12
4 Button C, Turbo	Gray-Blue	12	3 Button C, Turbo	Blue	13
4 Button D (N/U)	Gray-Violet	13	3 Button D (N/U)	Blue-Violet	14

### D.C. Power Source Voltage Limits

Function	Range Limits	ID	Function	Range Limits	ID
Digital Circuits	+4.90V to +5.10V	+5V	Audio, Lights	-4.75V to -5.25V	-5V
Audio, DBV	+11.5V to +12.5V	+12V	NOTE: +5V is adjustable at the Power Supply		





## CABINET WIRING DIAGRAM





## CONTROL WIRING DIAGRAM (49-WAY JOYSTICK)

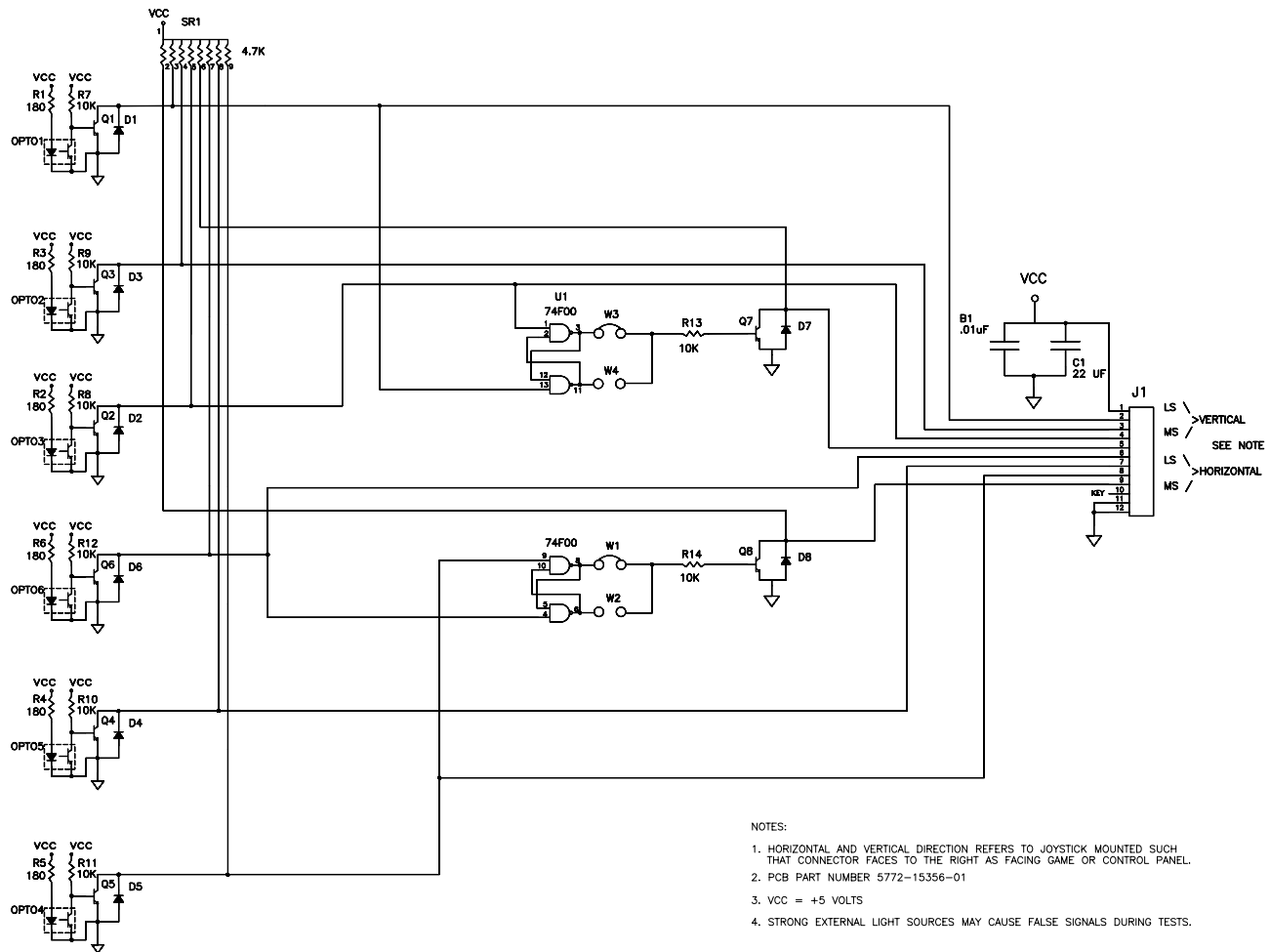

## POSITION LOGIC TABLE

DIRECTION	FULLY LEFT	MODERATELY LEFT	SLIGHTLY LEFT	DEAD CENTER	SLIGHTLY RIGHT	MODERATELY RIGHT	FULLY RIGHT
FULLY UP	01110111 (00)	01110011 (01)	01110001 (02)	01110000 (03)	01111100 (04)	01111110 (05)	01111111 (06)
MODERATELY UP	00110111 (07)	00110011 (08)	00110001 (09)	00110000 (10)	00111100 (11)	00111110 (12)	00111111 (13)
SLIGHTLY UP	00010111 (14)	00010011 (15)	00010001 (24)	00010000 (24)	00011100 (24)	00011110 (19)	00011111 (20)
DEAD CENTER	00000111 (21)	00000011 (22)	00000001 (24)	00000000 (24)	00001100 (24)	00001110 (26)	00001111 (27)
SLIGHTLY DOWN	11000111 (28)	11000011 (29)	11000001 (24)	11000000 (24)	11001100 (24)	11001110 (33)	11001111 (34)
MODERATELY DOWN	11100111 (35)	11100011 (36)	11100001 (37)	11100000 (38)	11101100 (39)	11101110 (40)	11101111 (41)
FULLY DOWN	11110111 (42)	11110011 (43)	11110001 (44)	11110000 (45)	11111100 (46)	11111110 (47)	11111111 (48)

NOTE: 1. Connector pin sequence for the above data is as follows: 9 8 7 6 5 4 3 2 referred to ground at pin 12.  
2. Numbers in parentheses are found in the Switch Test. Program does not use the "slightly" positions.

**SOUND I/O BOARD ASSEMBLY A-23431**

**SOUND I/O BOARD JUMPER POSITION TABLE \***

<b>Jumper</b>	<b>Location</b>	<b>Function</b>	<b>Meaning</b>	<b>Position</b>	<b>State</b>
J1 (Note 1)	Near U9 & Crystal Y3	I/O Connector P2	Input Mode	Pins 1 & 2	■
			Output Mode	Pins 2 & 3	
J2	Between U35 & U10	Video Sync	Positive Sync	Jumper Not Installed	■
			Negative Sync	Pins 1 & 2	
J3 (Note 2)	Near U15	I/O Connector P4	Input Mode	Pins 1 & 2	■
			Output Mode	Pins 2 & 3	
J4	None	None	Not Used	None	---
J5 (Note 2)	Between U15 & Connector P2	I/O Connector P4	Input Mode	Pins 1 & 2	■
			Output Mode	Pins 2 & 3	
J6	None	None	Not Used	None	---
J7	None	None	Not Used	None	---
J8 (Note 1)	Between U9 & Connector P4	I/O Connector P2	Input Mode	Pins 1 & 2	■
			Output Mode	Pins 2 & 3	

**Notes**

1. Configure I/O port P2 by setting both jumpers J1 and J8 to input or output mode.
2. Configure I/O port P4 by setting both jumpers J3 and J5 to input or output mode.

## SOUND I/O BOARD LED INDICATOR STATUS TABLE

LED	Location	Function	Color	State	Meaning
LED1 (Note 1)	Near U11	Not Used (Remains Off)	Green	Off	--
				On	--
				Blinking	--
LED2 (Note 2)	Near U34 & Crystal Y1	Linking Connector Status	Green	Off	Not in Use (No Game Linking)
				On	Link Continuity Good
LED3 (Note 2)	Near the JAMMA Connector	-5V Power Indicator	Red	Off*	No Power
				On*	Normal Operation
LED4 (Note 2)	Near U35 & Connector P14	+12V Power Indicator	Red	Off	No Power
				On	Normal Operation
LED5 (Note 2)	Near Connector P23	+5V Power Indicator	Red	Off	No Power
				On	Normal Operation
LED6 (Note 2)	Near U34 & Crystal Y1	CPU Linking Activity	Red	Off	Not in Use
				On	CPU Communicating with Ethernet Controller
LED7 (Note 2)	Near U34 & Crystal Y1	Linking Transmitting Data	Red	Off	Not in Use (No Game Linking)
				On	Sending Data
				Blinking	Normal Operation
LED8 (Note 1)	Near U14 & Crystal Y1	Audio Activity	Yellow	Off	No Sound Boot ROM
				On	Locked Up
				Blinking	Normal Operation
LED9 (Note 2)	Near U34 & Crystal Y1	Linking Receiving Data	Yellow	Off	Not in Use (No Game Linking)
				On	Receiving Data
LED10 (Note 1)	Near U44 & Crystal Y2	Not Used (Remains On)	Green	Off	--
				On	--
				Blinking	--
LED11 (Note 1)	Near U44 & Crystal Y2	Not Used (Remains On)	Red	Off	--
				On	--
				Blinking	--
LED12 (Note 1)	Near U44 & Crystal Y2	Not Used (Remains On)	Yellow	Off	--
				On	--
				Blinking	--
LED13 (Note 1)	Near U44 & Crystal Y2	Not Used (Remains On)	Yellow	Off	--
				On	--
				Blinking	--

### Notes

- Software controls this LED. Indications are game and revision-specific. Changing the EPROMs on this board may alter the function of this LED. Firmware damage may also cause new or different LED behavior.
- Hardware controls this LED. Indications depend on hard-wired circuitry. A change in normal LED behavior may indicate a circuit fault. Changing the EPROMs on this board shouldn't alter the function of this LED.

## CPU BOARD INDICATOR AND SWITCH LOCATIONS

### CPU BOARD SWITCH

Switch	Location	Function	Positions	State	Meaning
S1*	Edge Near U10 and U12	Resets and Restarts Game	2	Off	Normal Operation
				On	Forced Reset

**\*Notes**

This switch resets the CPU Board without shutting off power at the power supply.

## CPU BOARD JUMPER LOCATION TABLE

Jumper	J1	J2	J3	J4	J5	J6
Located Near...	U28 & Connector P5					U22 & U27

## CPU BOARD JUMPER POSITION TABLE

ROM Type	Default	Options*	J1	J2	J3	J4	J5	J6
<b>Boot (U27)</b>		27C080, 1M X 8, EPROM	1-2	2-3	1-2	1-2	--	--
	■	27C040, 512K x 8, EPROM	1-2	1-2	1-2	1-2	--	--
		27C010, 128K x 8, EPROM	1-2	1-2	1-2	2-3	--	--
		29F040, 512K x 8, Flash	2-3	1-2	2-3	1-2	--	--
		29F020, 256K x 8, Flash	1-2	1-2	2-3	1-2	--	--
		29F010, 128K x 8, Flash	1-2	1-2	2-3	1-2	--	--
<b>Expansion (U28)</b>		27C080, 1M x 8, EPROM	--	--	--	--	2-3	--
	■	27C040, 512K x 8, EPROM	--	--	--	--	1-2	--
		27C010, 128K x 8, EPROM	--	--	--	--	1-2	--
<b>External Boot</b>	■	Boot from CPU ROM	--	--	--	--	--	1-2
		Boot from SIO ROM	--	--	--	--	--	Re-moved

### \*Notes

1. -- = Not Applicable

2. Memory type numbers shown are for blank parts. Your game requires programmed parts.

## CPU BOARD LED INDICATOR STATUS TABLE

Device	Location	Function	Color	State	Meaning
LED1	Near U6, U7 & U16	3.3V CPU Power Indicator	Red	Off	Insufficient Power
				On	Power OK
				Blinking	Power Supply Fault
LED2	Near U28 & Connector P5	Hard Disk Drive Activity	Green	Off	Disk Not in Use
				On	Locked Up Disk
				Blinking	Normal Disk Activity
RP63	Near U22 & U26	Indicator	Red	Off*	See Note 3, Below.
				On*	
				Blinking* Sequentially	

### Notes

- LED1 monitors CPU power (+3.3 volts). If his LED is off or blinking, investigate processor circuits. If other LEDs are off or blinking at the same time, check +5-volt circuits or the game power supply.
- LED2 flashes when the hard disk is operating during game play. LED2 may light continuously during startup. If this LED remains lighted, the hard drive may be locked up or faulty.
- Software controls RP63. In this game, RP63 initially indicates program startup stages. This LED is a seven-segment, alphanumeric display device. Normally, RP63 displays a lowercase "b," or an "O" pattern with sequentially blinking segments. During Self-Test screens, RP63 displays a "bouncing bar" that resembles a hyphen ("-").

## VIDEO BOARD INDICATOR AND SWITCH LOCATIONS

**Note**

This video board has no jumpers or LEDs.







# SPORTSTATION™

## CHAPTER SEVEN

### TROUBLESHOOTING

	<b>NOTICE:</b> The term VGM refers to the video game machine.
	<b>CAUTION:</b> This VGM uses complex electronic components that are <i>very sensitive to static electricity</i> . Observe the following precautions before handling VGM electronics. Failure to do so may void your warranty and could damage electronic assemblies.

- Before servicing electronics, turn off AC power to the VGM. Wait for capacitors to discharge.
- Before touching or handling electronic assemblies, discharge static electricity on your body. To discharge this static, begin by connecting the line cord to a grounded outlet. Don't turn on the VGM! Next, touch the safety ground stud of the power supply chassis.
- Store electronic assemblies in an anti-static area. Use anti-static bags to store or transport VGM circuit boards. Transport the hard drive in its shipping container.
- Don't remove or connect electronic assemblies when cabinet power is on. Otherwise, you'll damage electronic assemblies and void the VGM warranty.
- After you complete maintenance or service, replace ground wires, shields, safety covers, etc. Install and tighten ground and mounting screws.

# Coin Mechanism and Pricing Troubleshooting Table

SYMPTOM	CAUSE	REQUIRED ACTION
<ul style="list-style-type: none"> <li>VGM (<i>video game machine</i>) accepts currency or tokens, but number of credits per coin or bill is incorrect.</li> </ul>	Improper settings at Pricing Menu	From Coin Options Menu, choose PRICING OPTIONS MENU. Verify that units and credits are set correctly.
	Incorrect pulse width on bill validators	<ol style="list-style-type: none"> <li>Consult bill validator manufacturer's literature. Adjust pulse width on validator to long setting.</li> <li>Retest validator operation.</li> </ol>
	Faulty wiring	<ol style="list-style-type: none"> <li>Check that cabinet wiring is correct for this VGM.</li> <li>Assure that coin meter and coin switches connect properly to control input wires.</li> </ol>
	Faulty coin mechanism	<ol style="list-style-type: none"> <li>Verify that coin mechanism works correctly by testing it in working VGM.</li> <li>If mechanism is bad, replace it.</li> </ol>
<ul style="list-style-type: none"> <li>VGM won't accept currency or tokens.</li> <li>VGM won't start.</li> <li>Audio and video are present.</li> </ul>	Improper currency	<ol style="list-style-type: none"> <li>Unlock and open cash door. Empty cash box. Inspect revenue for counterfeit currency.</li> <li>Check vault. Remove any items that block path from mechanism.</li> </ol>
	Faulty coin mechanism	<ol style="list-style-type: none"> <li>Unlock and open coin door. Check each mechanism for proper mounting.</li> <li>Remove mechanism.</li> <li>Clear currency path.</li> <li>Reinstall mechanism and latch it.</li> <li>Enter Menu System by pressing and holding TEST MODE switch inside coin door. From Main Menu, choose CONTROLS TEST. Use tests to confirm operation of coin switches.</li> </ol>
	Tilted coin mechanism or VGM	<ol style="list-style-type: none"> <li>Verify that mechanism is level after doors close.</li> <li>Repair or replace coin door if it is bent or damaged.</li> <li>If necessary, adjust cabinet leg levelers to keep mechanisms vertical.</li> </ol>
<ul style="list-style-type: none"> <li>Coin indicators don't light</li> </ul>	Burned-out bulb	<ol style="list-style-type: none"> <li>Burned-out bulbs may appear white or darkened. Check continuity with DVM.</li> <li>Replace burned-out bulb with same type.</li> </ol>
	Open fuse circuit	<ol style="list-style-type: none"> <li>Check fuse continuity with DVM.</li> <li>If fuse is blown, replace fuse with same type.</li> <li>If fuse isn't blown, check wiring.</li> </ol>



**CAUTION:** Don't remove or install any connector when power is turned on. Installation under power will damage the circuit boards or hard disk drive and void the warranty.

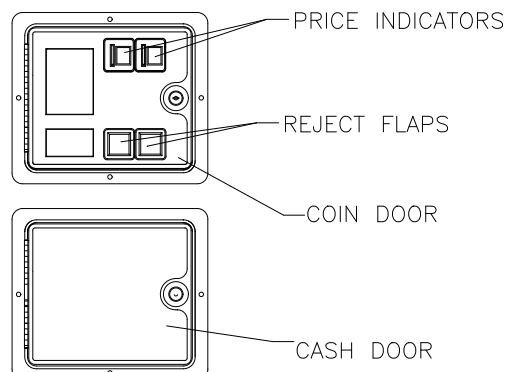

**Typical Coin Mechanism Mounting**

# VGM Startup Troubleshooting Table

SYMPTOM	CAUSE	REQUIRED ACTION
<ul style="list-style-type: none"> <li>VGM (video game machine) doesn't start.</li> <li>VGM appears completely non-functional.</li> <li>No audio</li> <li>No illumination</li> <li>No video display</li> </ul>	Power problem	<ol style="list-style-type: none"> <li>Check that VGM power switch is on.</li> <li>Inspect electronics to see if fans are turning. <i>If not:</i> Is power supply connected to its power cable? Is power supply turned on?</li> <li>Plug VGM into AC power outlet. Verify presence of AC line voltage.</li> </ol>
	Improper line voltage switch setting	Turn off VGM power. Unplug AC line cord. Check line voltage switch. If necessary, set it to agree with local AC line voltage. Retest VGM.
	Open fuse	<ol style="list-style-type: none"> <li>Turn off VGM power. Examine AC fuse on power supply.</li> <li>Examine DC fuses inside coin door vault.</li> <li>Replace faulty fuses with identically rated parts.</li> <li>Turn on VGM power. If fuse opens again, check DC wiring harness and connectors.</li> </ol>
	Faulty wiring	<ol style="list-style-type: none"> <li>Remove line cord. Test line cord, power plug, and IEC connector for breaks or damage. Verify continuity of each wire in cord. Install cord at power chassis. Press connector firmly to seat it.</li> <li>Check other cables in same manner.</li> <li>Assure that cabinet wiring harness connectors fully seat in corresponding power supply and board connectors.</li> <li>Inspect wiring for breaks or damage.</li> </ol>
	Faulty circuit boards	Turn off power for one minute and turn VGM on again. Power On Self-Test checks electronics.

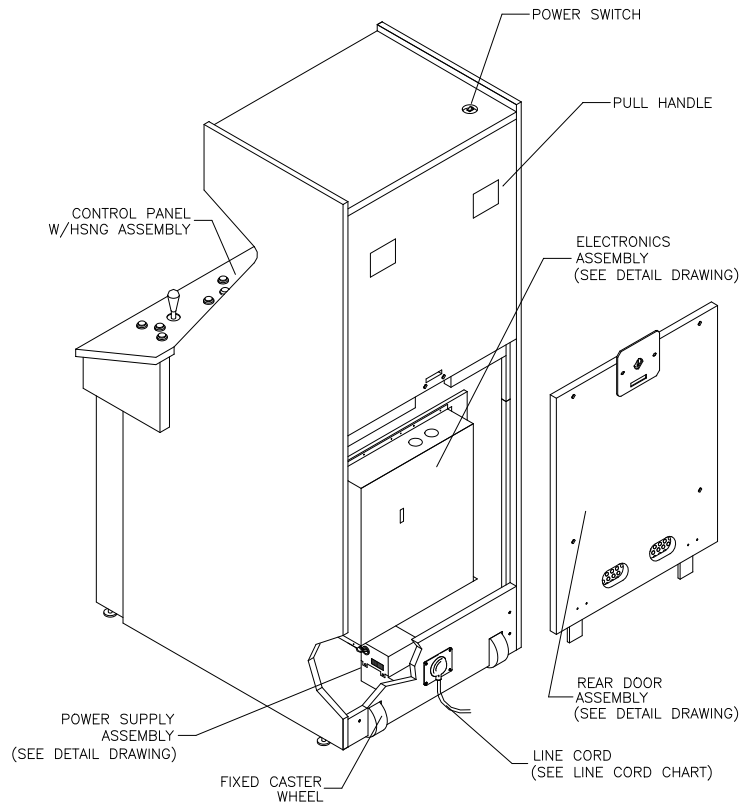

**Typical Location of Power Supply and Line Cord**

# VGM Startup Troubleshooting Table, *continued*

SYMPTOM	CAUSE	REQUIRED ACTION
<ul style="list-style-type: none"> <li>VGM (<i>video game machine</i>) appears non-functional.</li> <li>Currency acceptor price indicator is illuminated.</li> </ul>	Power problem	<ol style="list-style-type: none"> <li>Inspect circuit boards under low-light conditions. LEDs glow if processor circuits receive voltage. Fan should be turning. These indications prove presence of DC from power supply. Still, voltages or signals may not be normal.</li> <li>Turn on VGM power. Using 20-volt DC setting on digital voltmeter, measure DC voltages at power connector pins.</li> <li>Using 2-volt AC setting on digital voltmeter, measure same DC voltages as above. Any reading indicates ripple or noise. In that case, service power supply.</li> </ol>
	Faulty wiring	Turn off VGM power. Assure that wiring harness connectors attach and fully seat onto mating board connectors.
	Improper jumper or DIP switch settings	Verify that circuit board jumpers are set as intended. Check DIP switch settings.
	Faulty circuit boards	Run power-up self-test sequence. Note errors or failures during tests. Compare LEDs with LED indicator status charts. Note discrepancies.



**CAUTION:** Don't remove or install any connector while power is turned on. Doing so will damage circuit boards or hard disk drive, and void warranty.

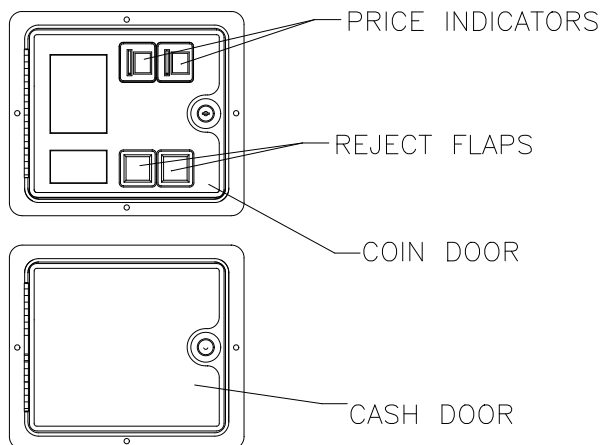

**Front View Of Coin Door**

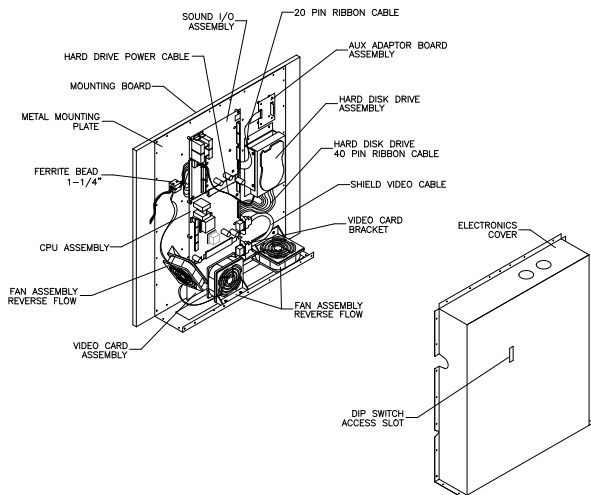

**Interior View Of Electronics**

# VGM Startup Troubleshooting Table, *continued*

SYMPTOM	CAUSE	REQUIRED ACTION
<ul style="list-style-type: none"> <li>VGM (<i>video game machine</i>) doesn't start.</li> <li>VGM accepts currency or tokens.</li> <li>Audio and video are present.</li> </ul>	Faulty coin mechanism	<ol style="list-style-type: none"> <li>Unlock and open coin door. Check each currency acceptor to assure proper mounting. Verify that each release latch is closed and locked. Does mechanism accept and reject currency correctly? Test mechanism with good and bad coins.</li> <li>Inspect to see if external acceptor indicators (Pricing, Flashing Arrows, etc.) are lit.</li> <li>Verify that each acceptor operates properly by placing it in working VGM. Replace bad parts.</li> </ol>
	Faulty switches	<ol style="list-style-type: none"> <li>Enter Menu System by pressing and holding TEST MODE switch inside coin door. From Main Menu, choose CONTROLS TEST. Use tests to confirm operation of each switch.</li> <li>Assure that no loose parts or wires are caught in switch contacts.</li> <li>Check for continuity in each suspect switch connection (Common to Normally Open or Common to Normally Closed).</li> <li>Replace faulty switches (bent levers, broken actuators, etc.).</li> </ol>
	Faulty wiring	<ol style="list-style-type: none"> <li>Assure that no wires are caught in hinges, latches or switch contacts.</li> <li>Check wiring continuity from circuit board connectors to acceptors.</li> </ol>

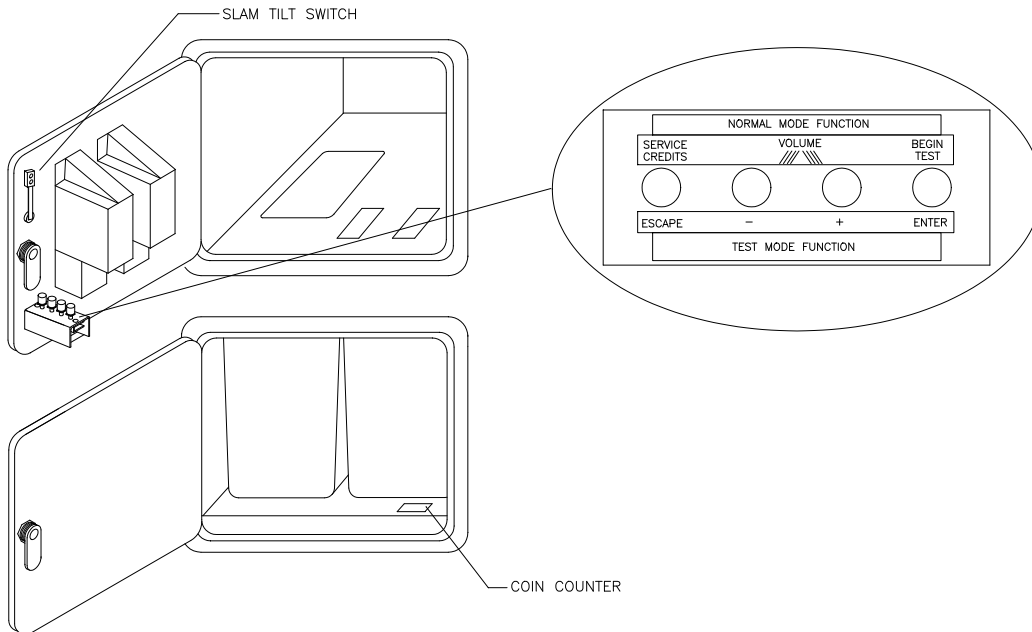

***Interior View of Coin Door and Cash Door***

## Audio Troubleshooting Table

SYMPTOM	CAUSE	REQUIRED ACTION
<ul style="list-style-type: none"> <li>No audio</li> <li>Video is present</li> <li>VGM (<i>video game machine</i>) appears to operate normally</li> </ul>	Improper volume setting	<ol style="list-style-type: none"> <li>From Main Menu, choose VOLUME LEVEL. Check that Attract Music is on (enabled). Verify that all volume levels are set well above zero.</li> <li>If necessary, change levels to make VGM audible.</li> </ol>
	Faulty SIO Board	<ol style="list-style-type: none"> <li>From Main Menu, enter Diagnostics Menu. Select SOUND SUBSYSTEM TEST. Test checks entire sound system.</li> <li>Run power-up self-test sequence. Note errors that VGM finds during tests. Compare Sound I/O Board (SIO) LEDs with LED indicator status charts. Note discrepancies.</li> <li>Verify proper operation of SIO Board by placing it in working VGM.</li> <li>If board is faulty, replace it.</li> </ol>
<ul style="list-style-type: none"> <li>Constant low hum from all speakers.</li> </ul>	Faulty wiring	<ol style="list-style-type: none"> <li>Check that cabinet wiring is correct for this VGM.</li> <li>Verify that cabinet wiring provides separate wires (not common return) for each speaker.</li> <li>Check connection of all cabinet ground wires.</li> </ol>
	Faulty power supply	Using 2 Volt AC setting on digital voltmeter, measure voltages at speaker terminals. Any reading indicates ripple or noise. In that case, service power supply.
<ul style="list-style-type: none"> <li>Audio is distorted, muffled or has missing frequencies.</li> </ul>	Faulty or improper speaker	<ol style="list-style-type: none"> <li>Turn off VGM power. Remove grilles and check speakers. Assure that speakers are full range (100 to 10,000 Hz response) and rated for at least 20 watts. Woofers must be rated for at least 40 watts.</li> <li>Verify proper speaker operation by connecting speaker in question to working VGM.</li> <li>If speaker is faulty, replace it.</li> </ol>
	Faulty wiring	Multiple-speaker installations: Check for reversed wires at one speaker. Weak low frequencies and thin or hollow sound quality is symptom of incorrectly phased speakers. Sound tests may not detect this condition, but you can hear it during VGM operation.
<ul style="list-style-type: none"> <li>Dead sound channel</li> </ul>	Faulty speaker	<ol style="list-style-type: none"> <li>From Main Menu, choose SOUND TEST. Recheck speakers with audio signals provided by test.</li> <li>Verify proper speaker operation by connecting speaker in question to working VGM.</li> <li>If speaker is faulty, replace it.</li> </ol>
	Faulty circuit board	<ol style="list-style-type: none"> <li>From Main Menu, enter Diagnostics Menu. Select SOUND SUBSYSTEM TEST. Test checks entire sound system.</li> <li>Run power-up self-test sequence. Note errors that VGM finds during tests. Compare circuit board LEDs with LED indicator status charts. Note discrepancies.</li> <li>Verify SIO Board operation by connecting board to working VGM.</li> <li>If board is faulty, replace it.</li> </ol>
	Faulty wiring	Verify that cabinet wiring is correct. Assure that all speakers connect to audio wires. Check for broken or shorted wires.

# Joystick Troubleshooting Table

SYMPTOM	CAUSE	REQUIRED ACTION
<ul style="list-style-type: none"> <li>Players complain that joystick operates erratically or unreliably</li> <li>Game starts normally</li> </ul>	Faulty switch	Enter game Menu System by pressing and holding TEST MODE switch inside coin door. From Diagnostics Menu, choose SWITCH TEST. Operate joystick in question. Check for proper readings of up, down, left and right.
	Faulty switch wiring	<ol style="list-style-type: none"> <li>Check for wires caught in door hinges, latches or switch contacts.</li> <li>Verify that harness connectors are attached and fully seated.</li> <li>Assure that joystick switches connector properly to control input wires.</li> <li>Check joystick cable ground connections.</li> <li>Check that cabinet wiring is correct for this VGM (<i>video game machine</i>).</li> </ol>
	Faulty mechanical parts	<ol style="list-style-type: none"> <li>Inspect joystick for: Missing, loose or damaged parts, torn rubber T-band, etc.</li> <li>Replace bad parts.</li> </ol>
	Dirty optos	Clean dust out of optos with swab and cleaner. <i>Don't apply cleaner directly into opto. Never use solvents!</i>
	Faulty joystick fuse	Check fuses on I-40 Joystick Interface Board inside player control panel. Each joystick has its own fuse.
	Faulty joystick electronics	<ol style="list-style-type: none"> <li>If joystick fuses are okay, install joystick in working VGM (<i>video game machine</i>) and retest it.</li> <li>If joystick still doesn't work, replace it.</li> </ol>
	Faulty I-40 Joystick Interface Board	<ol style="list-style-type: none"> <li>If joystick works in second VGM, I-40 Joystick Interface Board may be bad.</li> <li>Replace board and retest joystick.</li> </ol>

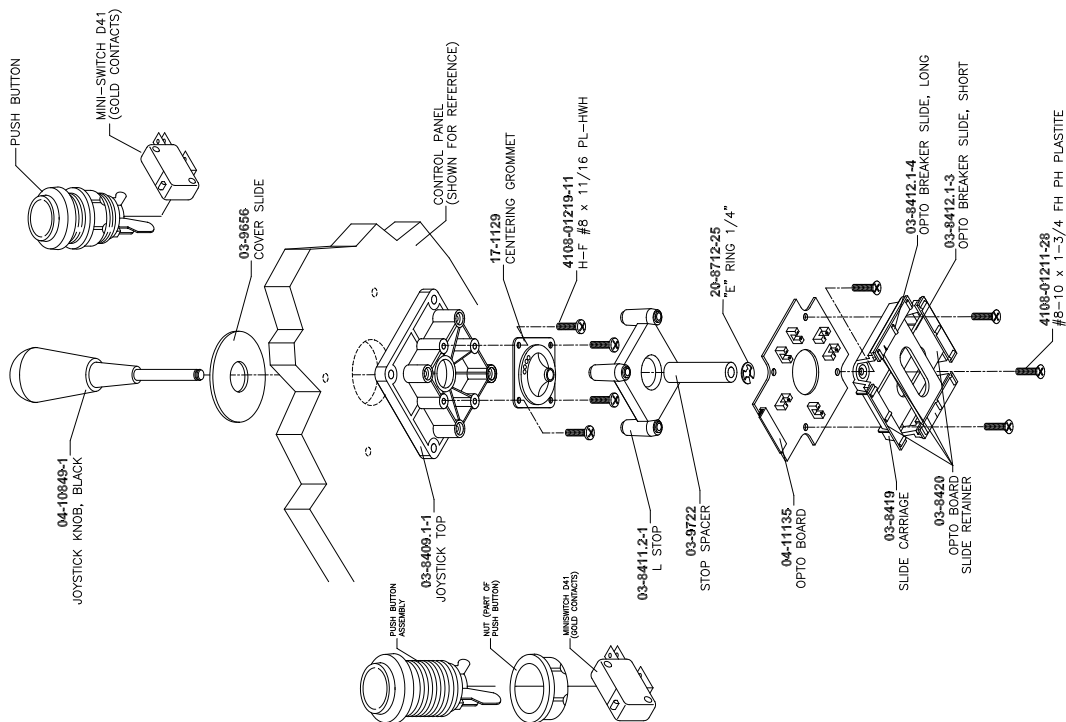



## Joystick Parts



# Video Troubleshooting Table

SYMPTOM	CAUSE	REQUIRED ACTION
<ul style="list-style-type: none"> <li>• Monitor appears non-functional</li> <li>• Audio is present</li> <li>• VGM (<i>video game machine</i>) controls operate normally</li> </ul>	Power problem	Verify connection of AC Power to video monitor. Inspect CRT neck in dim light. Glowing filament near CRT base proves that some monitor circuits receive power. Still, voltages or signals may not be normal.
	Faulty wiring	<ol style="list-style-type: none"> <li>1. Turn off VGM power. Verify that video signal and Remote Adjustment Board connectors seat properly on Video Monitor Board.</li> <li>2. Assure that video cables connect to circuit boards.</li> <li>3. Assure that no wires are caught on chassis or mounting brackets.</li> </ol>
	Improper monitor adjustments	Check that BRIGHTNESS (intensity) and CONTRAST are set above their minimum levels.
	Faulty monitor circuitry	<ol style="list-style-type: none"> <li>1. Examine AC line fuse on Video Monitor Board. If fuse is faulty, replace it with identical fuse.</li> <li>2. If fuse is good: Verify that video monitor operates correctly by placing it in working VGM.</li> <li>3. If monitor is bad: Check monitor power supply.</li> <li>4. If power supply is good: Check monitor horizontal output transistor and related circuitry.</li> </ol>

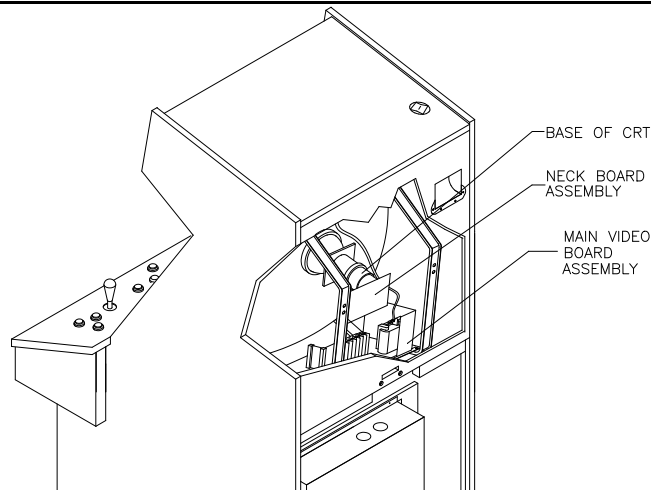

	<p><b>WARNING: HIGH VOLTAGE.</b> VGM monitors generate and store potentially lethal high voltages. Avoid touching any part of the monitor until power has been off for some time. A picture tube can maintain a hazardous charge for up to several days. Only qualified technicians should service monitors. Turn off the power, unplug the VGM and discharge the CRT before attempting service. Even properly discharged tubes can revert to a highly charged state, <i>without reapplication of power.</i></p>
	<p><b>WARNING:</b> In normal operation, the monitor doesn't require isolation from AC line voltage. During bench servicing, you may need to operate the monitor outside the cabinet. If you do, <i>isolate the monitor from line voltage with an isolation transformer.</i></p>
	<p><b>CAUTION:</b> Don't operate the monitor without the Remote Adjustment Board.</p>



**Typical Cutaway Rear View**

## Video Troubleshooting Table, *continued*

SYMPTOM	CAUSE	REQUIRED ACTION
<ul style="list-style-type: none"> <li>• Game screens don't appear</li> <li>• No audio</li> <li>• Power-up self-test runs</li> </ul>	Improper components	<ol style="list-style-type: none"> <li>1. Verify that hard disk drive is correct for this VGM (<i>video game machine</i>). Label on drive records manufacturer name, assembly number and program version.</li> <li>2. Verify that circuit boards are correct for this VGM. Label on each board records manufacturer name, assembly number and hardware version.</li> <li>3. Verify that ROM instruction set is correct for this VGM. VGM set only has one ROM. Label on ROM records assembly number and software version.</li> </ol>
	Hard drive problems	<ol style="list-style-type: none"> <li>1. Turn VGM on. Immediately look <i>under</i> hard drive. Hard Drive Activity LED flashes if drive is operating properly.</li> <li>2. Allow VGM to load normally. Note and record any error messages that occur during self-test.</li> <li>3. Remove hard drive and install it in working VGM. If symptom recurs there, hard drive is faulty. Replace it.</li> </ol>
<ul style="list-style-type: none"> <li>• Blotches of color appear on screen</li> </ul>	Picture tube aperture mask is magnetized	Remove diskettes from room. Demagnetize monitor with external degaussing coil. Take care not to magnetize neighboring VGMs. Monitor may be on or off for this procedure.
<ul style="list-style-type: none"> <li>• White areas in center of screen appear tinged with color</li> <li>• Object edges have fringe of one or more colors</li> </ul>	Picture tube purity or static convergence is out of alignment	<ol style="list-style-type: none"> <li>1. Turn on VGM (<i>video game machine</i>).</li> <li>2. Press and hold TEST MODE to enter Menu System. At Main Menu, select Monitor Tests Menu. Run through Crosshatch, Red, Green and Blue screens to find clearest display of problem.</li> <li>3. Display screen with greatest problem.</li> <li>4. Display Crosshatch Screen. Locate purity and static convergence ring magnets on back of monitor neck. Watch screen in mirror. Adjust magnets to minimize problem. Follow instructions from monitor manufacturer.</li> <li>5. Display Crosshatch Screen. Touch up adjustments while watching screen in mirror.</li> </ol>
<ul style="list-style-type: none"> <li>• Background of Attract Mode screens seems out of sync</li> <li>• Words on screen read OK</li> </ul>	Someone set DIP switch for resolution lower than VGA	<ol style="list-style-type: none"> <li>1. VGM only outputs VGA video. Press and hold TEST MODE to enter Menu System. At Main Menu, select DIP Switch Test Menu.</li> <li>2. Locate DIP switch bank U12 on the Sound I/O Board.</li> <li>3. Turn off switch 2.</li> <li>4. Reenter Attract Mode and check screens.</li> </ol>

	<p><b>CAUTION:</b> Don't operate the monitor without its Remote Adjustment Board.</p>
	<p><b>WARNING: HANDLE FLUORESCENT TUBE AND CRT WITH CARE.</b> If you drop a fluorescent tube or CRT and it breaks, it will implode! Shattered glass can fly eight feet or more from the implosion.</p>

## Video Troubleshooting Table, *continued*

SYMPTOM	CAUSE	REQUIRED ACTION
<ul style="list-style-type: none"> <li>White areas at screen edges appear tinged with color</li> <li>Dots at screen edges appear oval or cylindrical</li> </ul>	Picture tube dynamic convergence is out of alignment	Have service bureau dynamically reconverge monitor. This procedure requires removing and repositioning yoke. Service bureau must follow instructions from monitor manufacturer.
<ul style="list-style-type: none"> <li>Video tears or rolls, or has black bar down middle of screen</li> </ul>	Faulty wiring	<ol style="list-style-type: none"> <li>Check connectors and cables for wiring continuity. Video cables connect graphics card to circuit boards, and then to video monitor.</li> <li>Assure connection of all cabinet ground wires, especially at video monitor chassis.</li> </ol>
	Faulty monitor circuitry	<ol style="list-style-type: none"> <li>Check video monitor operation by connecting it to working VGM (<i>video game machine</i>).</li> <li>Assure that video monitor is correct type for this VGM. Video monitors with wrong resolution can't lock sync.</li> </ol>
	Improper sync signals	<ol style="list-style-type: none"> <li>Check to see if Video Board puts out type of sync that your monitor requires.</li> <li>Verify that jumpers are set correctly for monitor.</li> <li>If necessary, add or remove video sync jumper at Sound I/O Board jumper block J10. With no pins connected (or pins 2 and 3 connected), board outputs positive sync. With pins 1 and 2 connected, board outputs negative sync.</li> </ol>
	Electromagnetic fields	Move cabinet far away from machines, appliances, or competitors' VGMs.
<ul style="list-style-type: none"> <li>Missing colors</li> </ul>	Faulty wiring	Check connectors and cables for wiring continuity from circuit boards to video monitor.
	Faulty monitor color drive circuitry	Verify that video monitor operates correctly by connecting it to working VGM.
<ul style="list-style-type: none"> <li>One color is dimmer or brighter than others</li> <li>Whites appear tinted everywhere on screen</li> </ul>	Maladjusted color bias pots	<ol style="list-style-type: none"> <li>Turn on VGM (<i>video game machine</i>).</li> <li>Enter Monitor Tests Menu.</li> <li>Watch Color Bars screen in mirror.</li> <li>Adjust three bias pots for best colors. (Most monitor neck boards include these pots.)</li> <li>Also check White Screen. Touch up controls.</li> <li>If whites still seem tinted, have service bureau rejuvenate picture tube.</li> </ol>
<ul style="list-style-type: none"> <li>Picture is dim or faded</li> </ul>	Maladjusted BRIGHTNESS pot or subnormal picture tube emission	<ol style="list-style-type: none"> <li>Watch Color Bars screen. Adjust BRIGHTNESS and CONTRAST pots for greatest number of grays. You'll find these pots on Monitor Remote Control Board, behind coin door.</li> <li>If pots have no effect, have service bureau rejuvenate picture tube.</li> </ol>
<ul style="list-style-type: none"> <li>Picture is too narrow</li> </ul>	Maladjusted WIDTH pot	Enter Monitor Tests Menu. Watch Crosshatch Screen while adjusting WIDTH pot for best picture. You'll find this pot on Monitor Remote Control Board, behind coin door.
<ul style="list-style-type: none"> <li>Picture is too short</li> </ul>	Maladjusted HEIGHT pot or damaged vertical circuit	<ol style="list-style-type: none"> <li>Enter Monitor Tests Menu. Watch Crosshatch Screen while adjusting HEIGHT pot for best picture. You'll find this pot on Monitor Remote Control Board, behind coin door.</li> <li>If pot has no effect, service vertical output circuit.</li> </ol>
<ul style="list-style-type: none"> <li>Picture seems shifted to one side</li> </ul>	Maladjusted HORIZONTAL POSITION pot	Enter Monitor Tests Menu. Watch Crosshatch Screen while adjusting HORIZONTAL POSITION pot for best picture. You'll find this pot on Monitor Remote Control Board, behind coin door.
<ul style="list-style-type: none"> <li>Keystone-shaped picture</li> </ul>	Shorted turns in yoke	<ol style="list-style-type: none"> <li>Substitute working yoke.</li> <li>Have service bureau converge monitor.</li> <li>Retest monitor.</li> </ol>

# Software Update Troubleshooting Table

SYMPTOM	CAUSE	REQUIRED ACTION
<ul style="list-style-type: none"> <li>Update didn't work</li> <li>After update procedure, screen reports lower than latest version</li> </ul>	You skipped steps or performed them out of sequence.	Return update components to kit, reinstall original parts in cabinet, and try process again.
	Installation error may have damaged device.	<ol style="list-style-type: none"> <li>Inspect for bent or broken pins.</li> <li>If you have another kit, try it.</li> <li>Ask your distributor to check your floppy disk.</li> </ol>
<ul style="list-style-type: none"> <li>No Attract Mode screens</li> <li>Board indicators illuminate, but screen is completely blank</li> </ul>	Mismatched boot update version and hard drive.	Once you've updated disk drive, CPU instructions must be at correct version to make use of new data stored on disk. Be certain that boot ROM device resides in proper socket.
	You may have installed devices in wrong sockets.	<ol style="list-style-type: none"> <li>Install disk ROM. Only use upgrade socket for hard disk drive updates. During game play, upgrade socket must be empty.</li> <li>Load ROM contents onto drive.</li> <li>Remove ROM from game.</li> </ol>



**NOTICE:** Someday, software updates for your VGM (video game machine) might become available. These upgrades may improve your VGM's performance or add new VGM features. Such upgrades tend to appear sometime after factory first releases VGM. Contact your distributor for information about updates.

# Miscellaneous Problem Troubleshooting Table

SYMPTOM	CAUSE	REQUIRED ACTION
<ul style="list-style-type: none"> <li>Marquee lamp is intermittent or non-functional</li> <li>VGM (<i>video game machine</i>) starts and plays normally</li> </ul>	Faulty fluorescent tube	<ol style="list-style-type: none"> <li>Remove fluorescent tube from its sockets. If you find cracks or darkened ends, install new lamp. Clean tube.</li> <li>Check continuity of both fluorescent tube filaments.</li> <li>Verify that fluorescent tube operates by placing it in working VGM.</li> </ol>
	Faulty lamp fixture	<ol style="list-style-type: none"> <li>Verify that lamp pins make good connection with socket contacts.</li> <li>Check ballast for continuity.</li> </ol>
	Faulty wiring	<ol style="list-style-type: none"> <li>Measure fluorescent lamp AC voltages. Check wiring and connector continuity from AC power chassis to lamp assembly.</li> <li>If you find faulty wiring, repair or replace it.</li> </ol>
<ul style="list-style-type: none"> <li>VGM operates normally</li> <li>Cabinet becomes warm after several hours of use</li> </ul>	Obstructed fan	<ol style="list-style-type: none"> <li>Check bottom and rear of cabinet for blocked airflow.</li> <li>Move VGM away from sources of heat.</li> <li>Turn off VGM power. Remove dust from vent holes with high-power vacuum cleaner.</li> </ol>
	Faulty wiring	<ol style="list-style-type: none"> <li>Check fan wiring and connectors.</li> <li>If you find faulty wiring, repair or replace it.</li> </ol>
	Faulty fan	<ol style="list-style-type: none"> <li>Check operation of all fans, including power supply fan.</li> <li>If fan is faulty, replace it.</li> </ol>
<ul style="list-style-type: none"> <li>Error messages appear on screen</li> </ul>	Faulty hardware	<ol style="list-style-type: none"> <li>Check any assembly (RAM, ROM, Battery, etc.) identified in error messages.</li> <li>Call your authorized distributor for help with unresolved screen messages.</li> </ol>

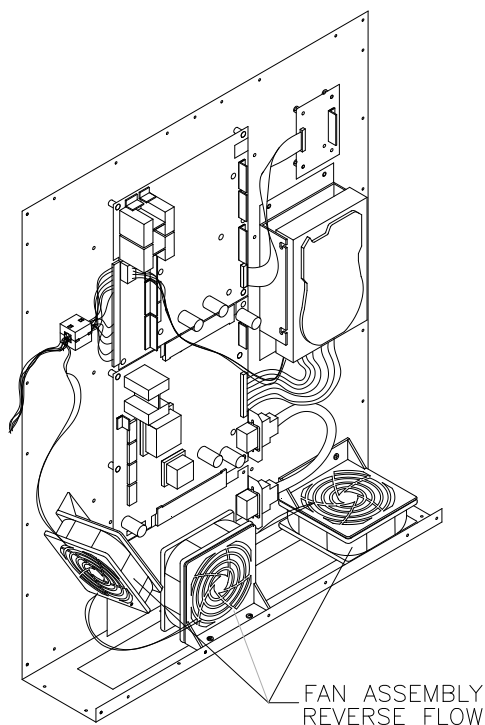

**Fan Location and Mounting**



## WARNINGS & NOTICES

### WARNING

- Use of non-Midway parts or circuit modifications may cause serious injury or equipment damage!
- Use only Midway authorized components and parts. Failure to do so will void your warranty and may result in incorrect or unsafe operation. Substitute parts or modifications may void the EMC directive or FCC type acceptance.
- Federal copyright, trademark and patent laws protect this game. Unauthorized modifications may be illegal under Federal law. The modification ban also applies to Midway Games Inc. game logos, designs, publications and assemblies. Moreover, facsimiles of Midway equipment (or any feature thereof) may be illegal under federal law, regardless of whether or not such facsimiles are manufactured with Midway Games Inc. components.

### WARNING

Prevent shock hazard and assure proper game operation. Plug this game into a properly grounded outlet. Do not use a cheater plug to defeat the power cord's grounding pin. Do not cut off the ground pin.

### WARNING

A small portion of the population has a condition which may cause epileptic seizures or momentary loss of consciousness when viewing certain kinds of flashing lights or patterns that are present in our daily environment. These persons may experience seizures while watching some kinds of television pictures or playing certain video games. People who have not had seizures may nonetheless have an undetected epileptic condition.

If you or anyone in your family has experienced symptoms linked to an epileptic condition (e.g. seizures or loss of awareness), consult your physician before using video games.

We recommend that parents observe their children while they play video games. If you or your child experience the following symptoms: dizziness, altered vision, eye or muscle twitching, involuntary movements, loss of awareness, disorientation, or convulsions, *discontinue use immediately* and consult your physician.

### NOTICE

This video game machine has been tested. It complies with limits for a Class A digital device, under FCC Rules, Part 15. These limits provide reasonable protection against harmful interference when the equipment operates in a commercial environment. This equipment generates, uses and can radiate radio frequency energy. If not installed and used according to the instruction manual, this equipment may cause harmful interference to radio communications. Operation of this equipment in a residential area is likely to cause harmful interference. If interference occurs, the user must correct it at his own expense.

### NOTICE

When Midway Games Inc. ships a game, it complies with FCC regulations. Your FCC label is proof of compliance. Legal repercussions to the owner or distributor may result if the label is missing or damaged. If your game does not contain an FCC compliance label, call Midway Games Inc. immediately.

### NOTICE

You may not reproduce any part of this publication by mechanical, photographic, or electronic means. You may not prepare phonograph recordings of this document. You may not transmit this publication or otherwise copy it for public or private use, without permission from the publisher.

### COPYRIGHT & TRADEMARK NOTICE

Entire contents of this manual copyright © 1999 Midway Games Inc. All rights reserved. The following are trademarks of Midway Games Inc.: *Midway®*, *SportStation™*, *NBA Showtime™*, *NFL Blitz 2000 Gold Edition™*. ©1999 NBA. ©1999 NFLP. Team names and logos are trademarks of indicated teams. The NBA logo is a trademark of the National Basketball Association. Officially Licensed Product of the National Basketball Association. The NFL shield, Super Bowl and Pro Bowl are trademarks of the National Football League Players. The *Players Inc.* logo is a registered trademark of the NFL Players.

### FOR SERVICE

Call your Authorized Midway Games Inc. Distributor.

**MIDWAY GAMES INC., 3401 N. CALIFORNIA AVE., CHICAGO, ILLINOIS 60618-5899 USA**

## Free Manuals Download Website

<http://myh66.com>

<http://usermanuals.us>

<http://www.somanuals.com>

<http://www.4manuals.cc>

<http://www.manual-lib.com>

<http://www.404manual.com>

<http://www.luxmanual.com>

<http://aubethermostatmanual.com>

Golf course search by state

<http://golfingnear.com>

Email search by domain

<http://emailbydomain.com>

Auto manuals search

<http://auto.somanuals.com>

TV manuals search

<http://tv.somanuals.com>