

Fast Track Learning™

Pattern Block
PATTERNS
& SHAPES

Skill-building
Activities & Games

Olga Gonzalez-Granat

 **WARNING:**
CHOKING HAZARD - Small parts.
Not for children under 3 years.

Dear Grown-Ups,

The Fast Track Learning™ series is a collection of books aimed at introducing children to mathematics. The goal of this series is to engage children in lively math activities that are fun, interesting, and challenging, but most of all allow kids to feel successful. This series has been developed keeping the most current research in mathematics education in mind. The National Council of Teachers of Mathematics recommends the use of hands-on materials to teach math in the early years.

About This Book

In *Fast Track Learning™ — Pattern Blocks Patterns and Shapes*, children develop thinking and reasoning skills through the use of pattern blocks.

Pattern blocks are a set of 6 shapes. Each shape has a different color. Pattern blocks are used to create patterns and figures in art, and to study mathematics, in classrooms throughout the world.

In this book, children use pattern blocks to solve puzzles by creating space objects from the pieces, as well as play games.

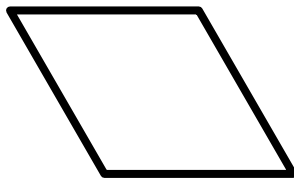

Blue Rhombus

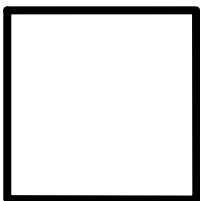

Orange Square



Red Trapezoid

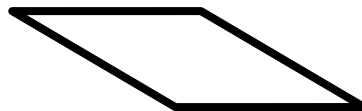

Tan Rhombus

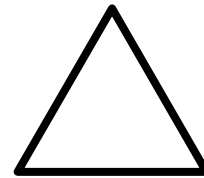

Green Triangle

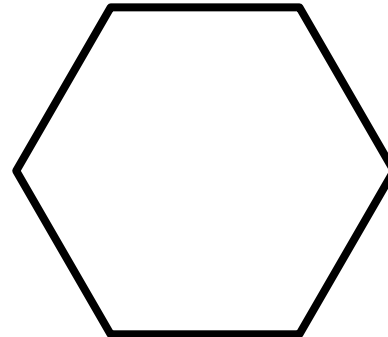

Yellow Hexagon

How to Use This Book:

To get started, you will need to pop out the clear plastic case with the pattern blocks from the book cover. The book then will lie flat so children can work directly on the activity pages. When pattern block play is finished, the pieces can be returned to the case and snapped back into the book for safe storage.

The activities in this book are coded by level of difficulty. Look for the stars in the corners of the pages.

Level 1 ★ *The first 5 activities* include the outlines of each pattern block shape and can be solved easily even by a beginner. Children must slide, turn, and flip pieces in order for them to fit. Even very young learners can feel successful with the first part of the book.

Level 2 ★ *The next 7 activities* include partial outlines to make the activities more challenging, while still giving a hint. Encourage beginners to try their best, and to look at the whole puzzle for hints. Each of these pages includes a hint as to how many pieces kids must use to solve the puzzle. Ask children to find other solutions to each puzzle. There is often more than one way to solve many of these problems.

Level 3 ★ *The next 6 activities* incorporate the idea of symmetry. If children have a hard time grasping the concept, hold a hand mirror down on the line of symmetry so they can see what the completed shape will look like. For young children, have them complete one side while you complete the other.

Level 4 ★ *The final 3 activities* do not include any interior lines and are the most challenging. Encourage children to approach the puzzles systematically. Remember, there are often multiple solutions.



At the end of this book, on pages 29 and 30, you'll find *Rainy Day Extensions*. These ideas for additional fun will help you extend your pattern block activities.

Possible solutions for selected puzzles are found on pages 31 and 32.

Things You Can Do

Work alongside your children as they solve the puzzles. Children love to work with an adult on activities such as these.

Encourage and praise. Kids love to feel successful at whatever they do.

Use this book as a coloring book. With crayons, colored pencils, or markers, children can add color to the pattern block pages as they complete them.

Give hints. If you see your child is struggling with some of the more challenging puzzles, take a peek in the back and give him/her hints. You can also draw in lines for younger children.

Most important of all—have fun!





Cover the asteroids using your pattern blocks.

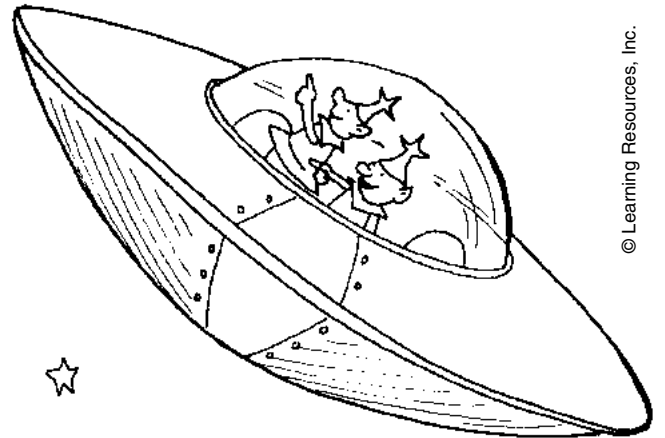
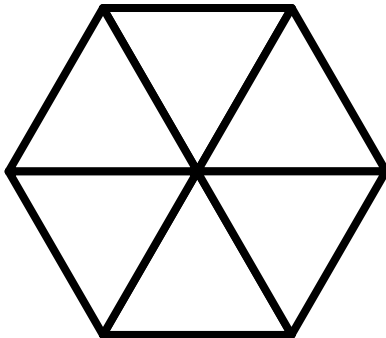
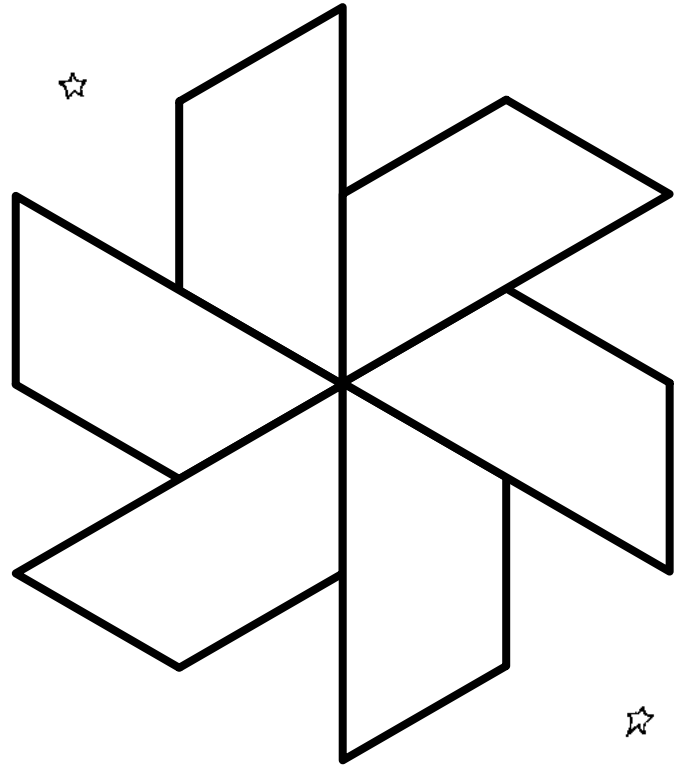
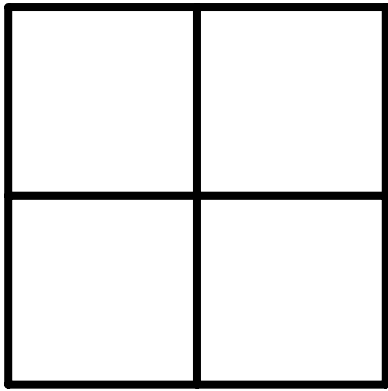

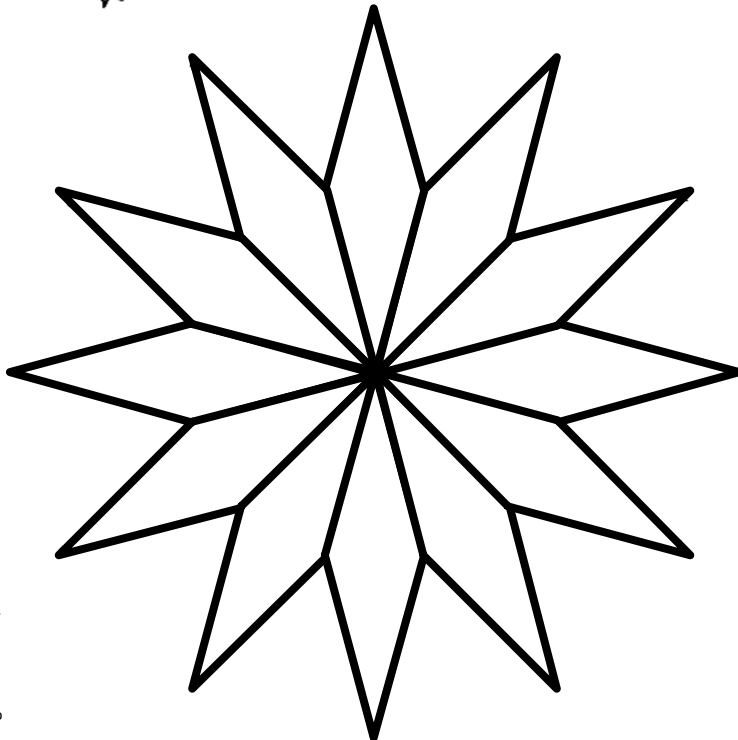
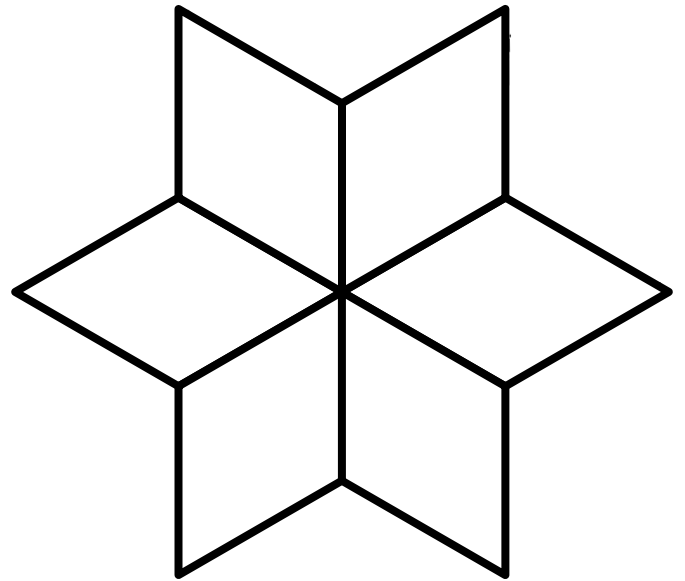
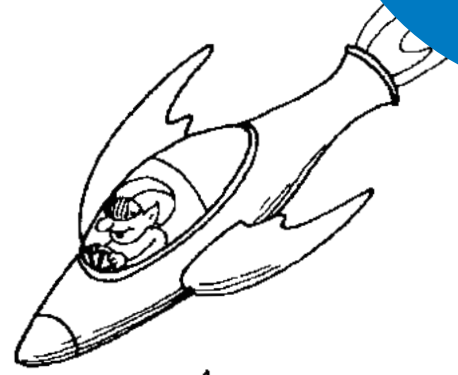
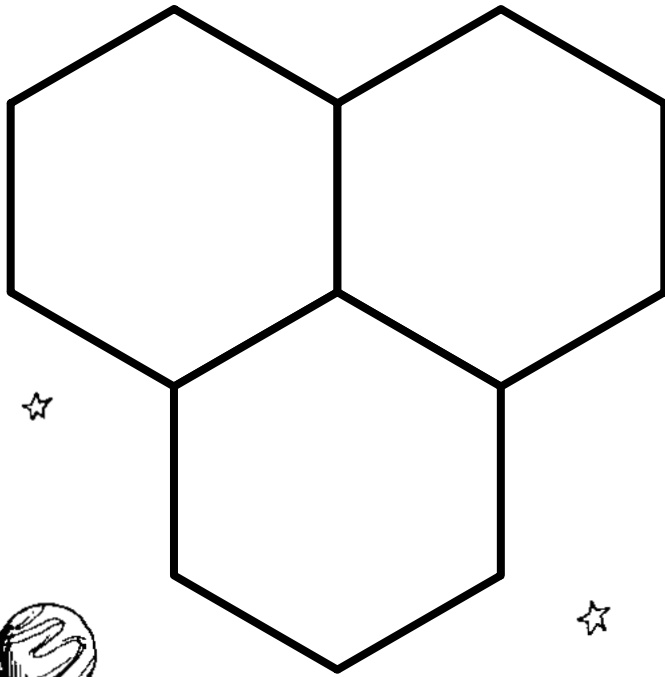



Make the Space Creature using your pattern blocks.

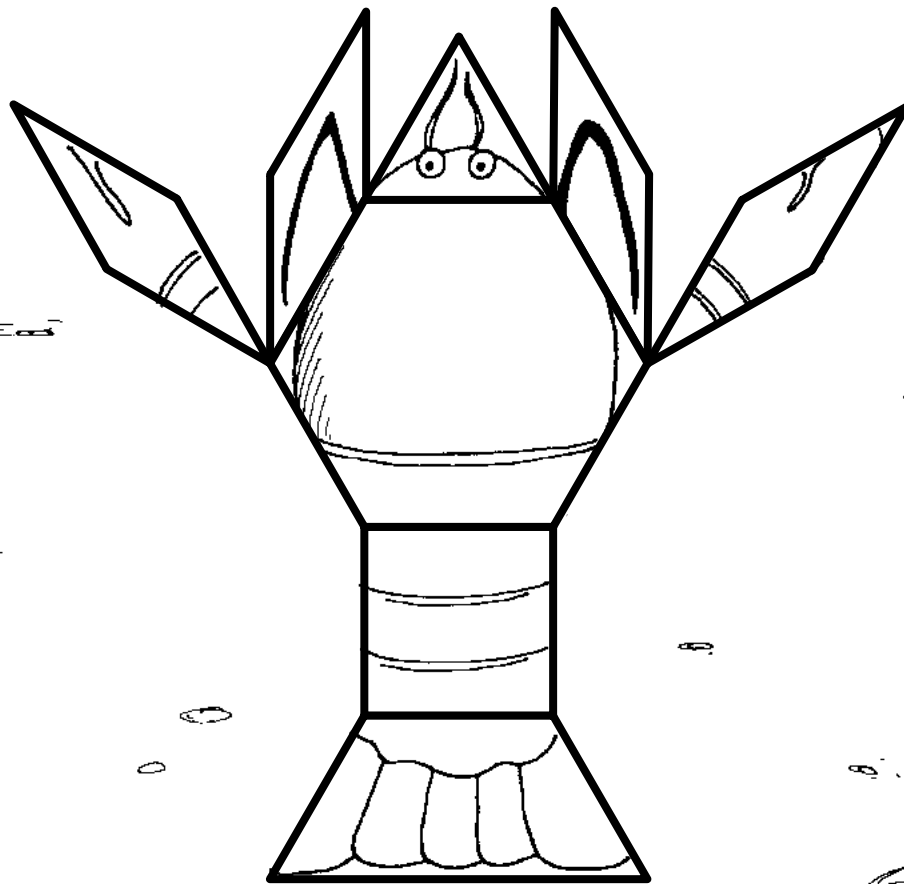
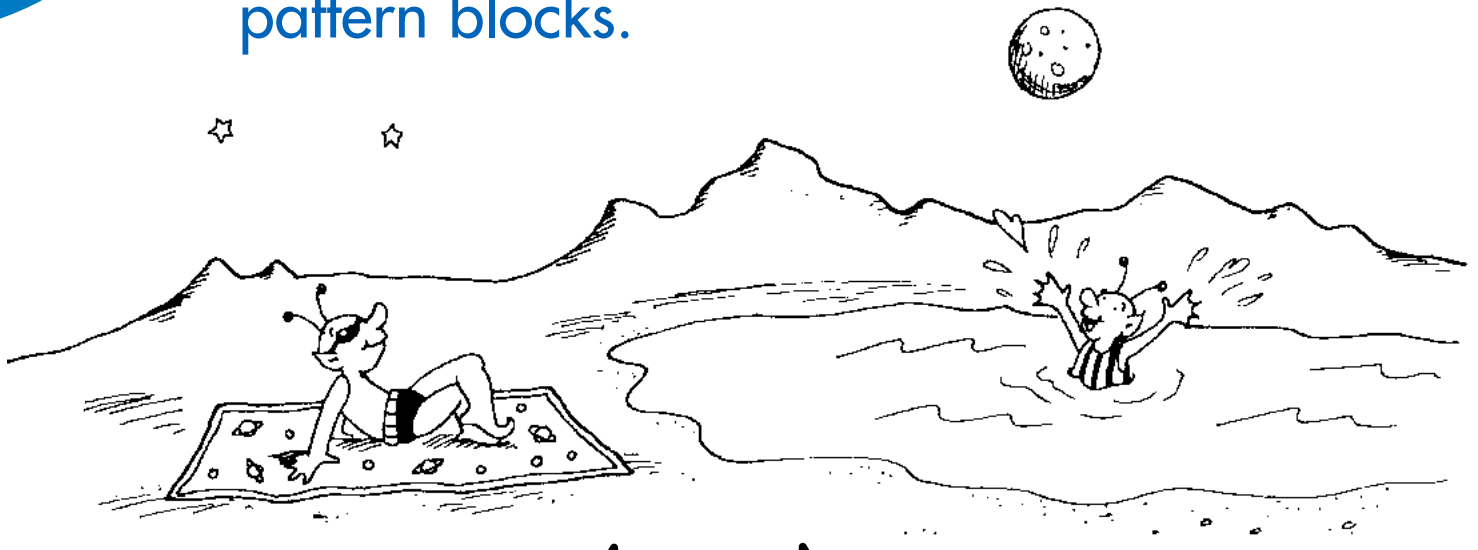

Build the Space Capsule.

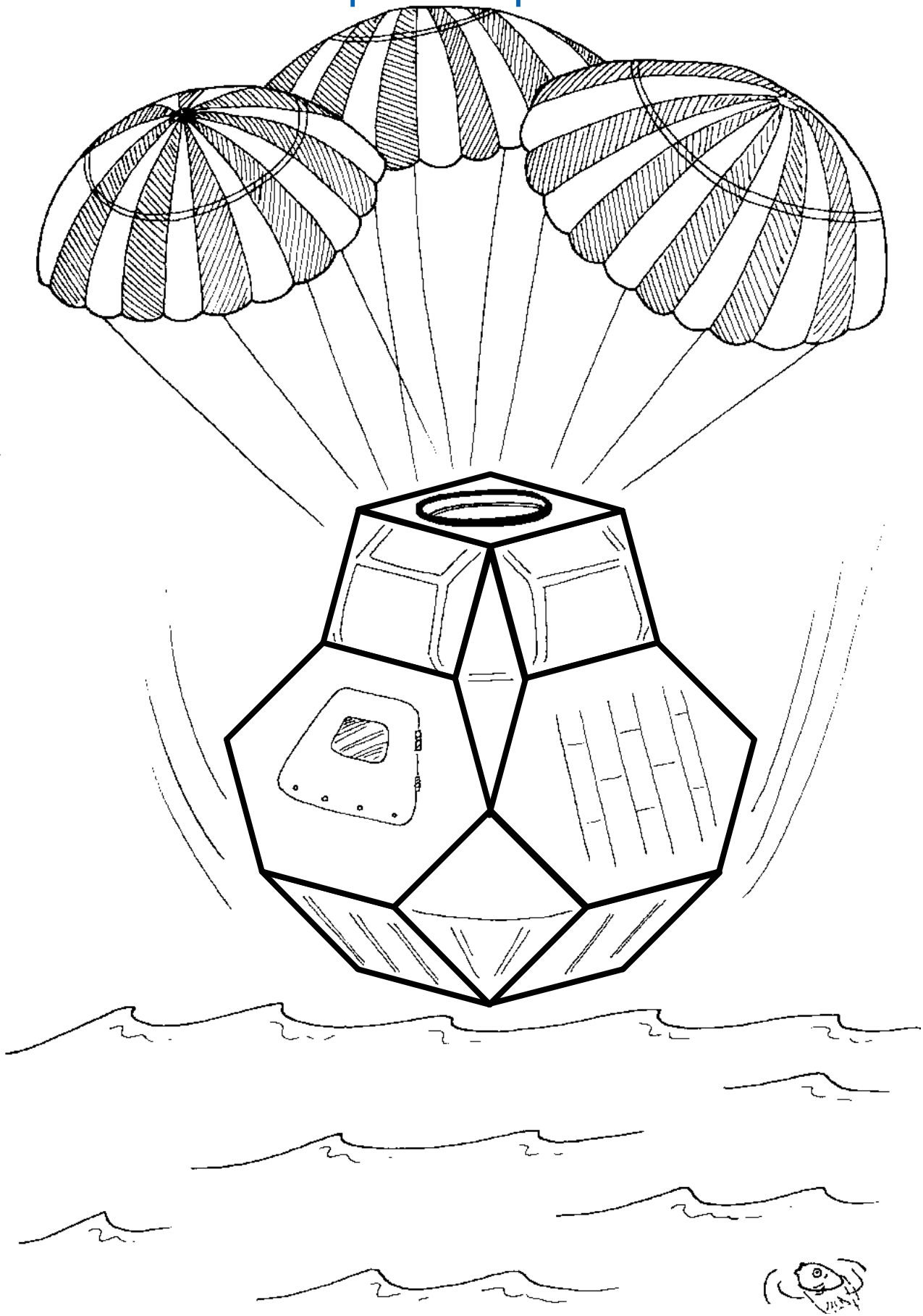



Make the Space Ship.

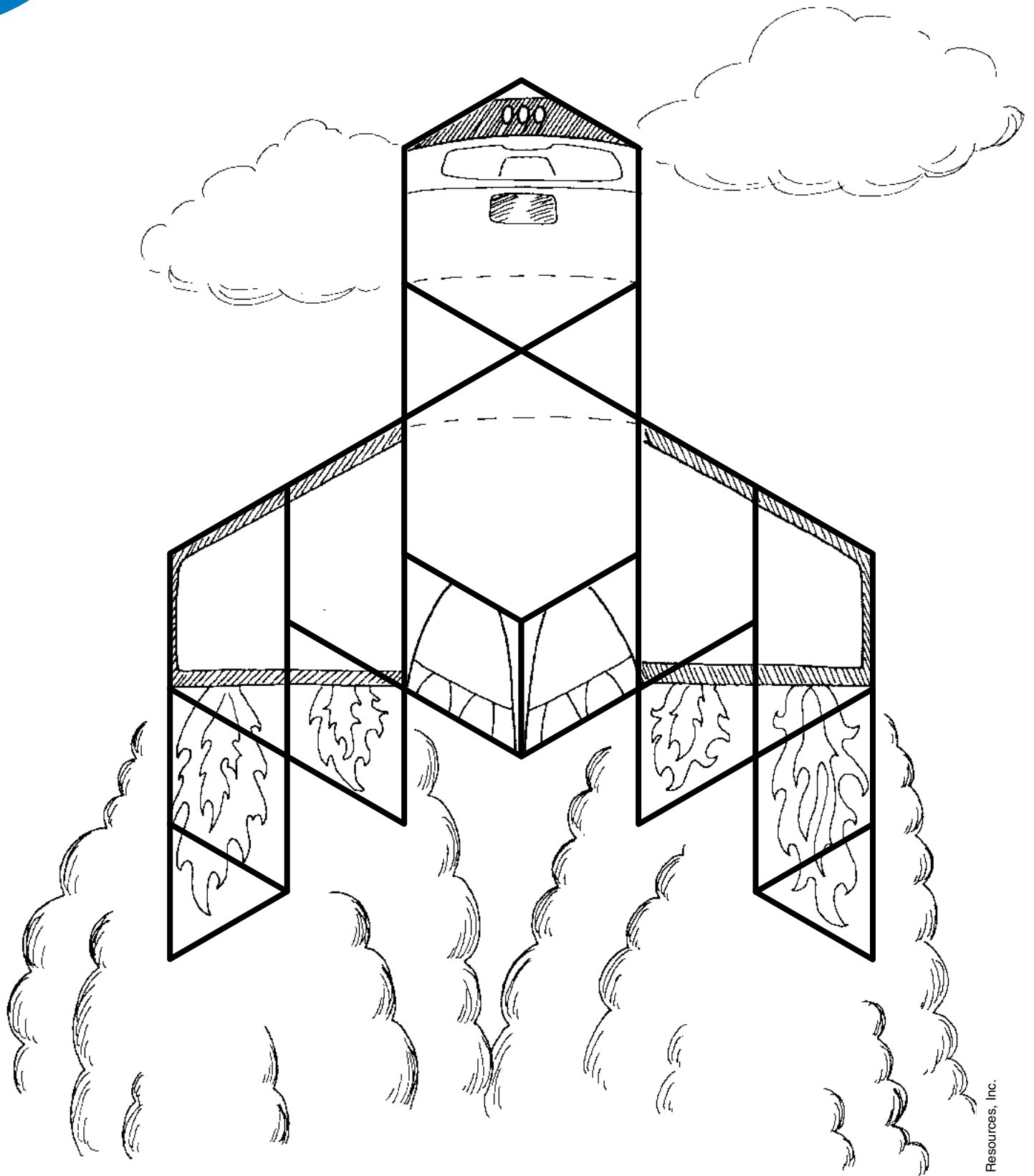



Create the Space Bug using 11 pattern block pieces.

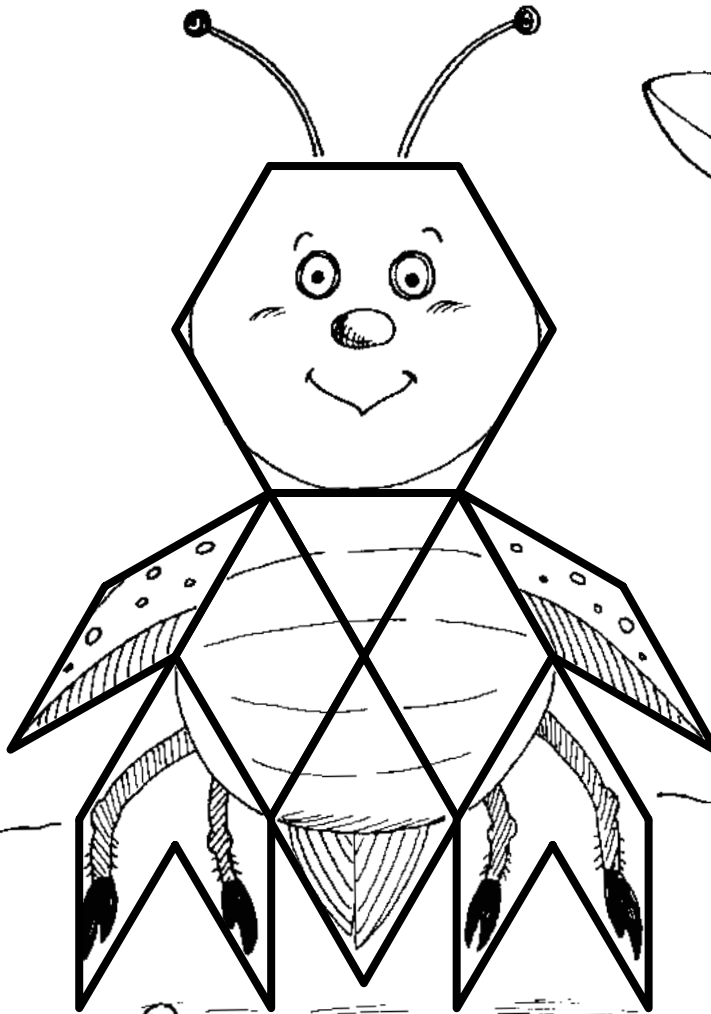
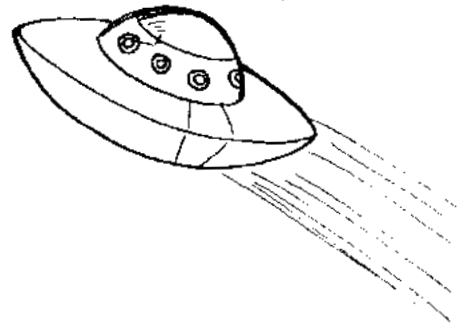



Build the U.F.O. using 14 pieces.

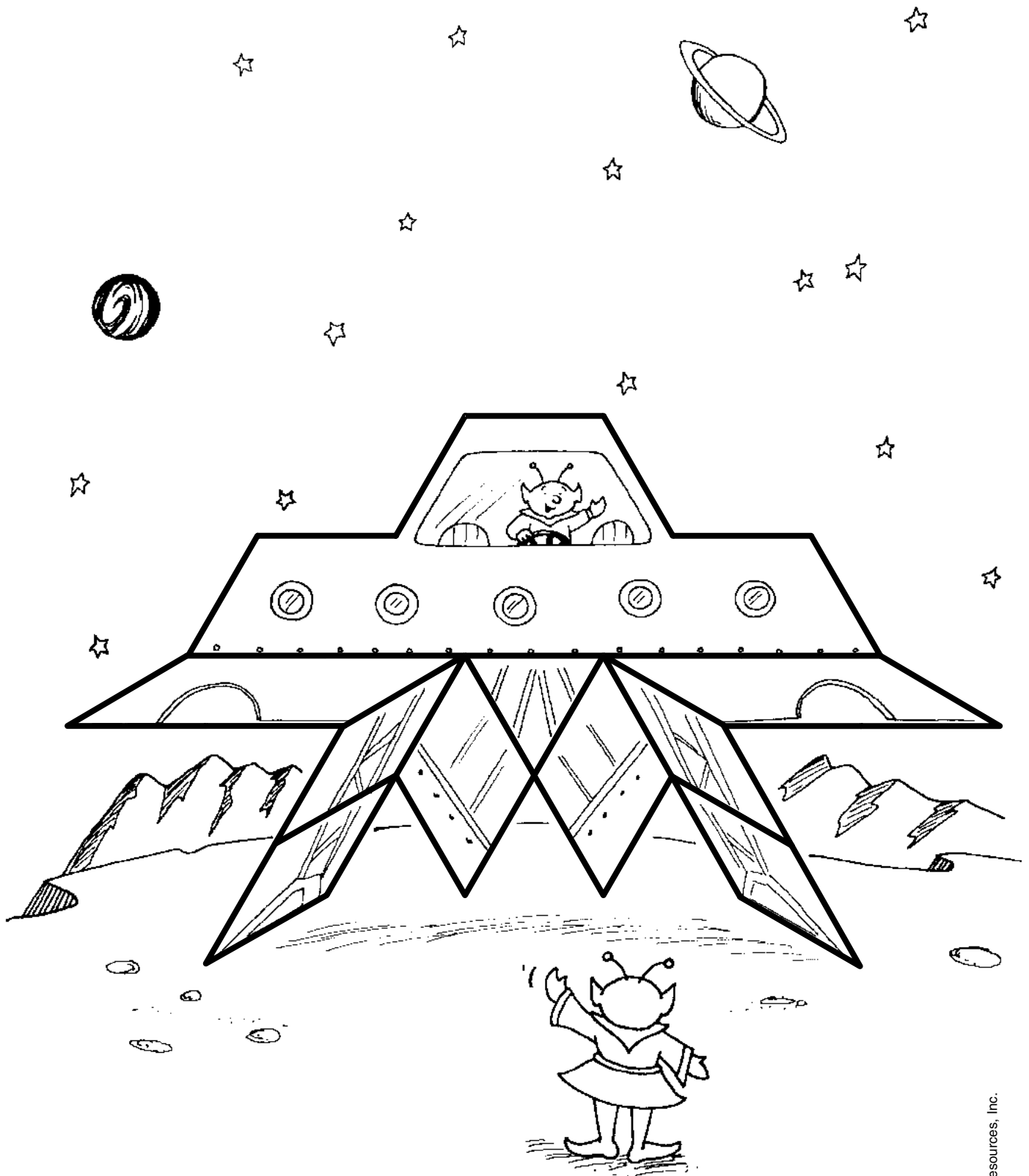



Use 13 pieces to create this Martian Pet.





Make the Loading Craft using 14 pieces.

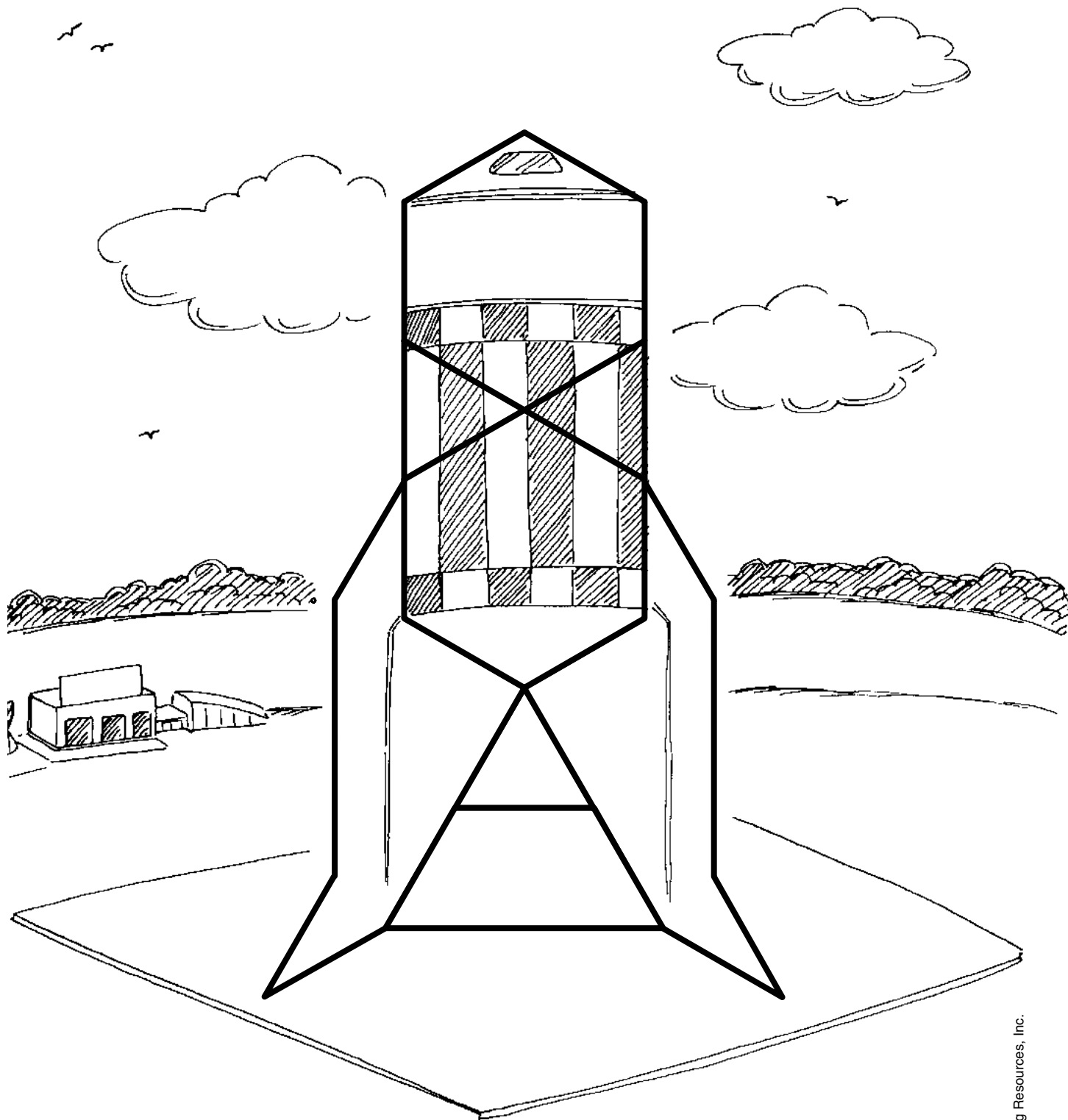



Create the Space Bunny using 16 pieces.

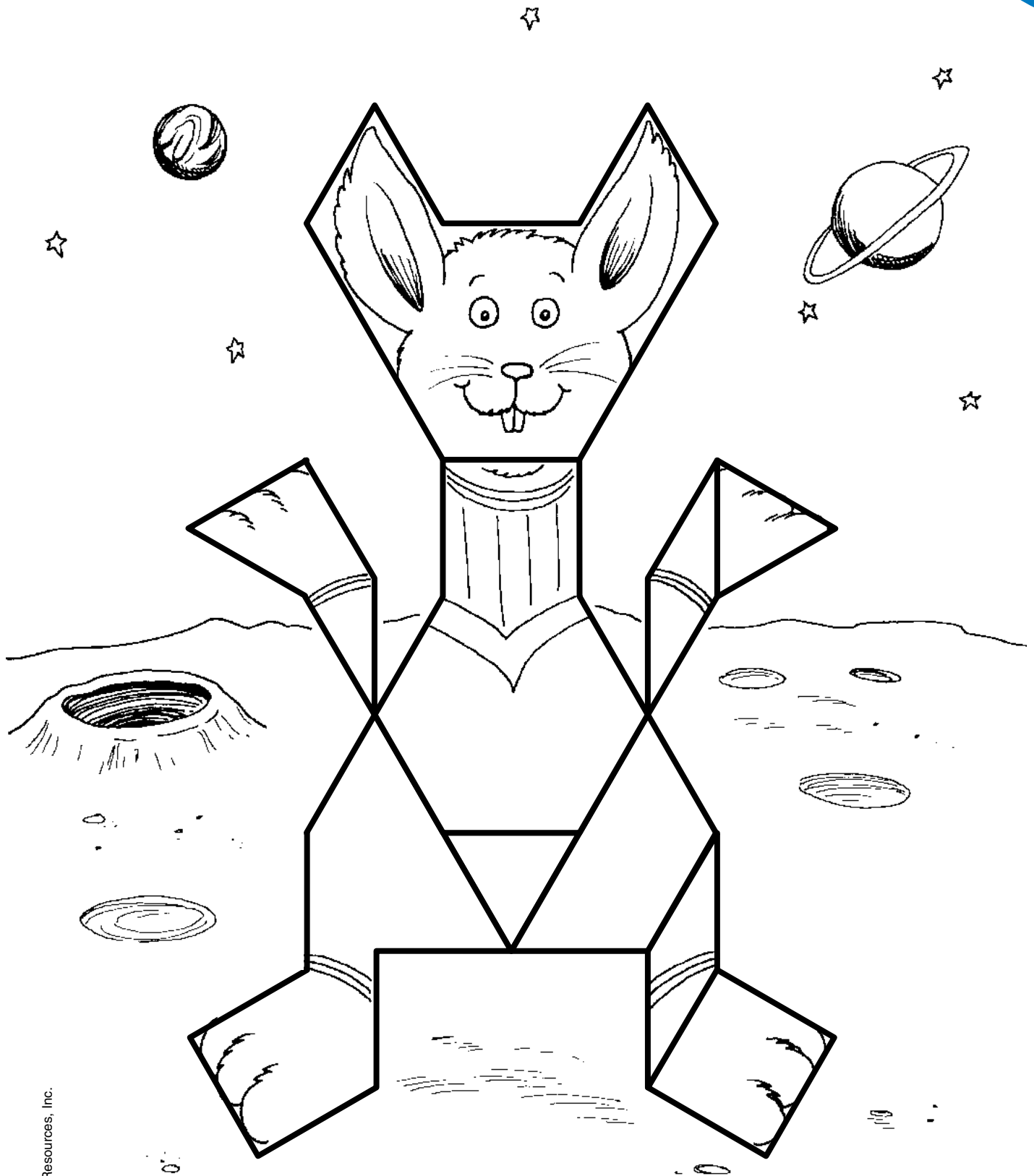



Use 17 pieces to build the Star Ship.

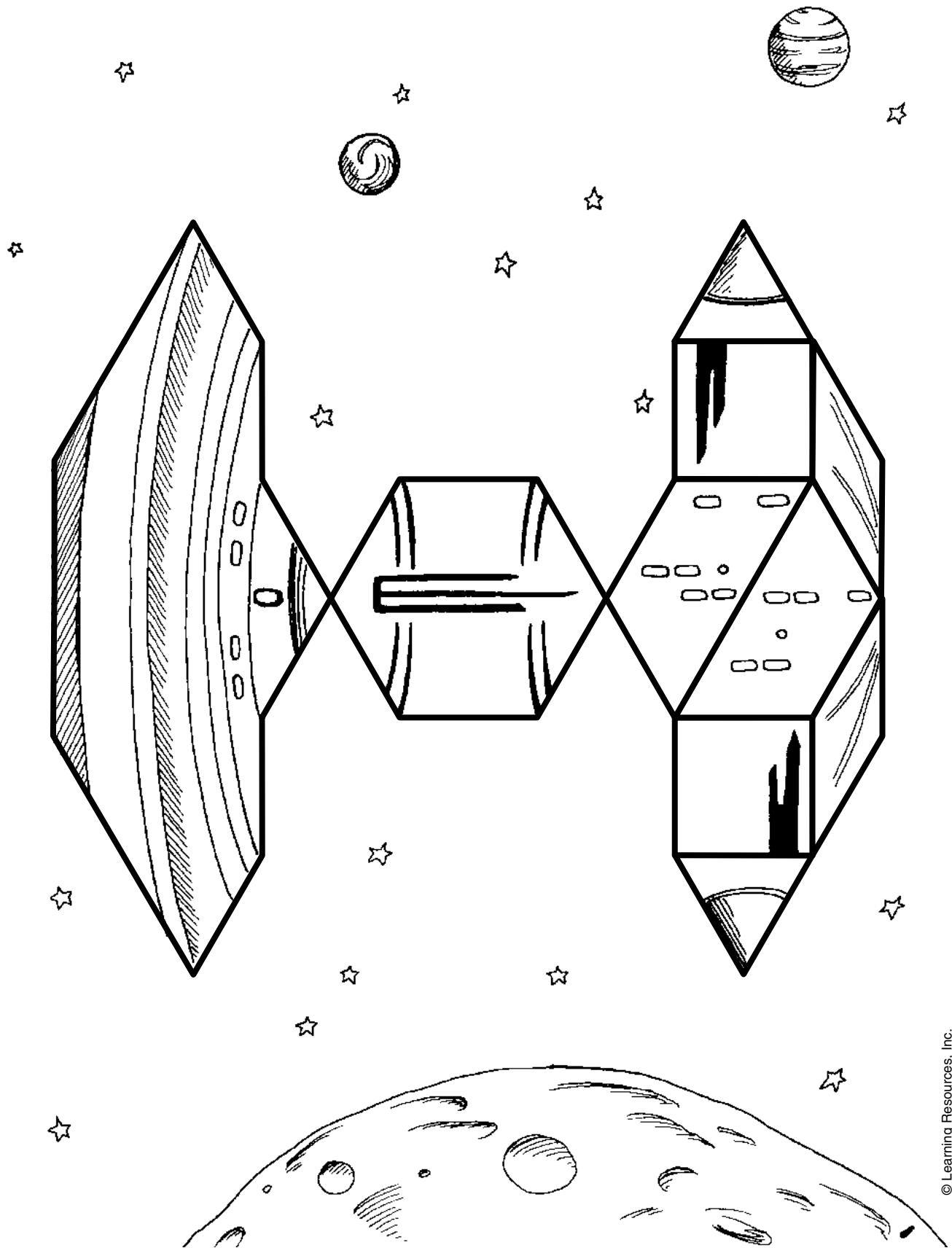

Build the Moon Rocket using 19 pieces.

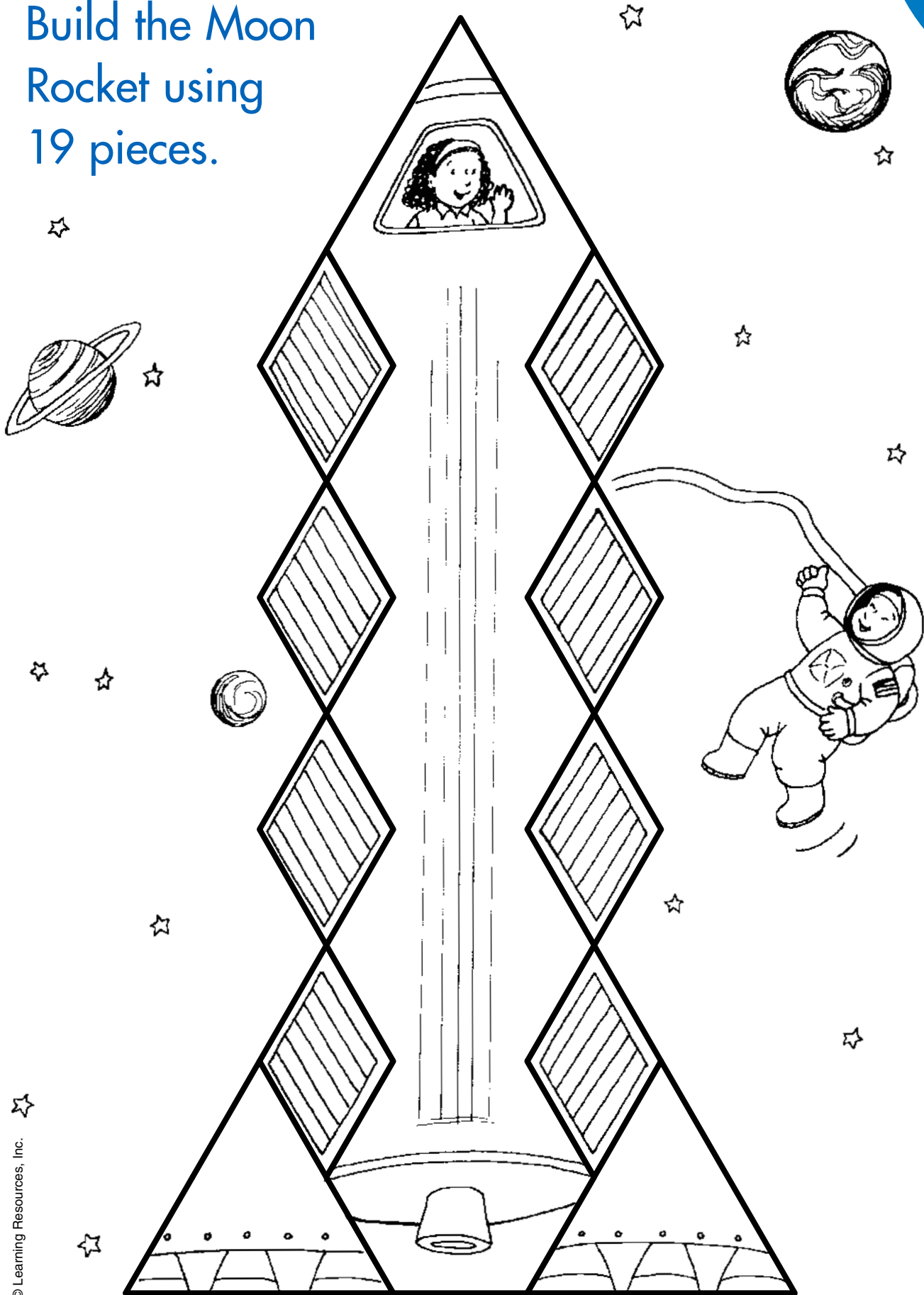

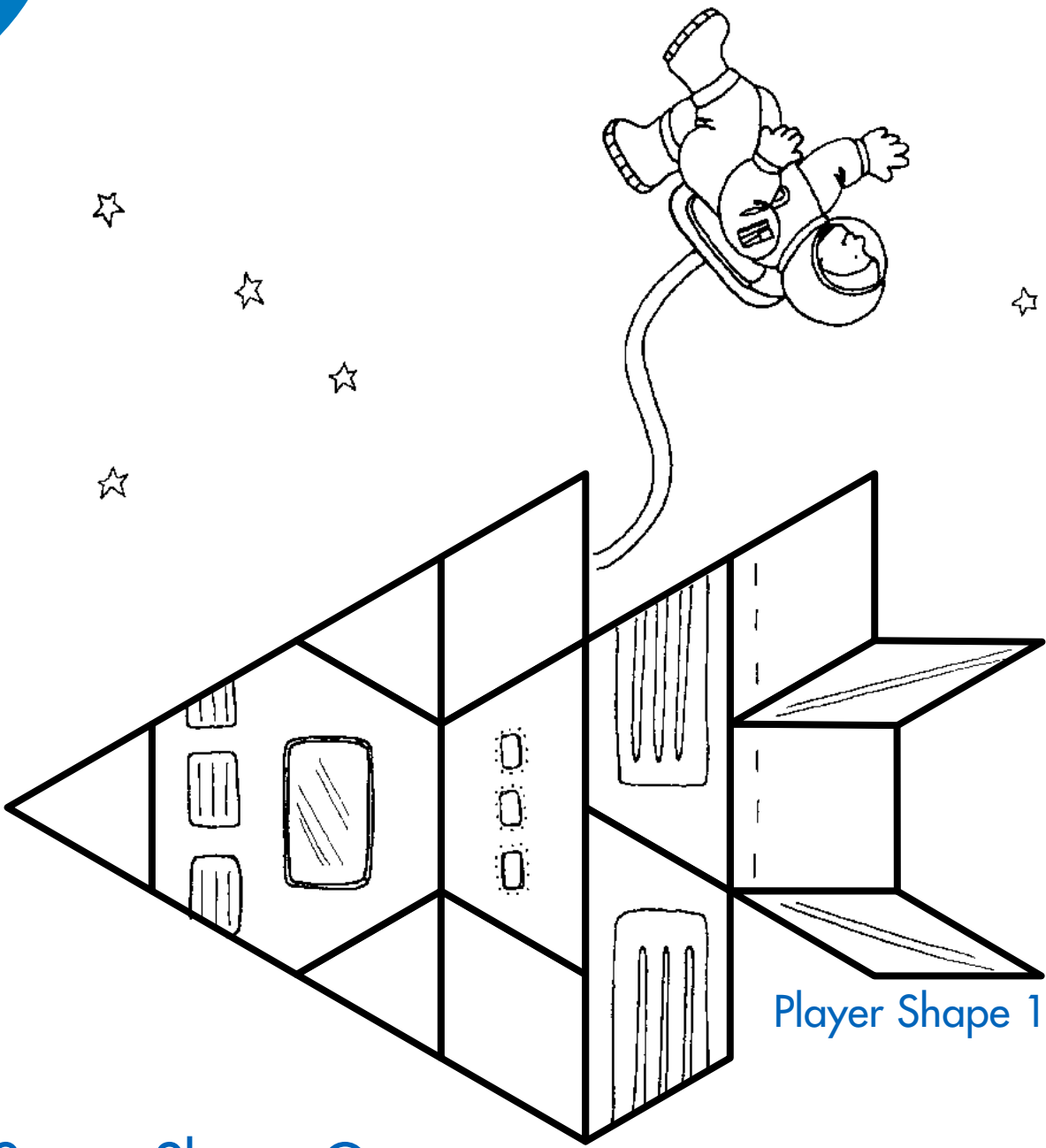

Space Shape Game

Players: 2

Object: To be the first player to complete a Space Shape.

Rules:

- 1) Follow the directions to make the spinner. Players take turns spinning. The first player whose spin points to the hexagon gets to go first.
- 2) Players take turns spinning for a pattern block piece and placing the piece on the Space Shape. If a piece cannot be placed on the shape, it must be returned to the draw pile.
- 3) Play continues until one person's Space Shape is completed.



To make a spinner:

- 1) Arrange a pencil, a paper clip, and the spinner circle (found on the inside front cover of this book) as shown.
- 2) Spin the paper clip around the pencil. The free end of the paper clip will point to a pattern block shape.



Player Shape 2

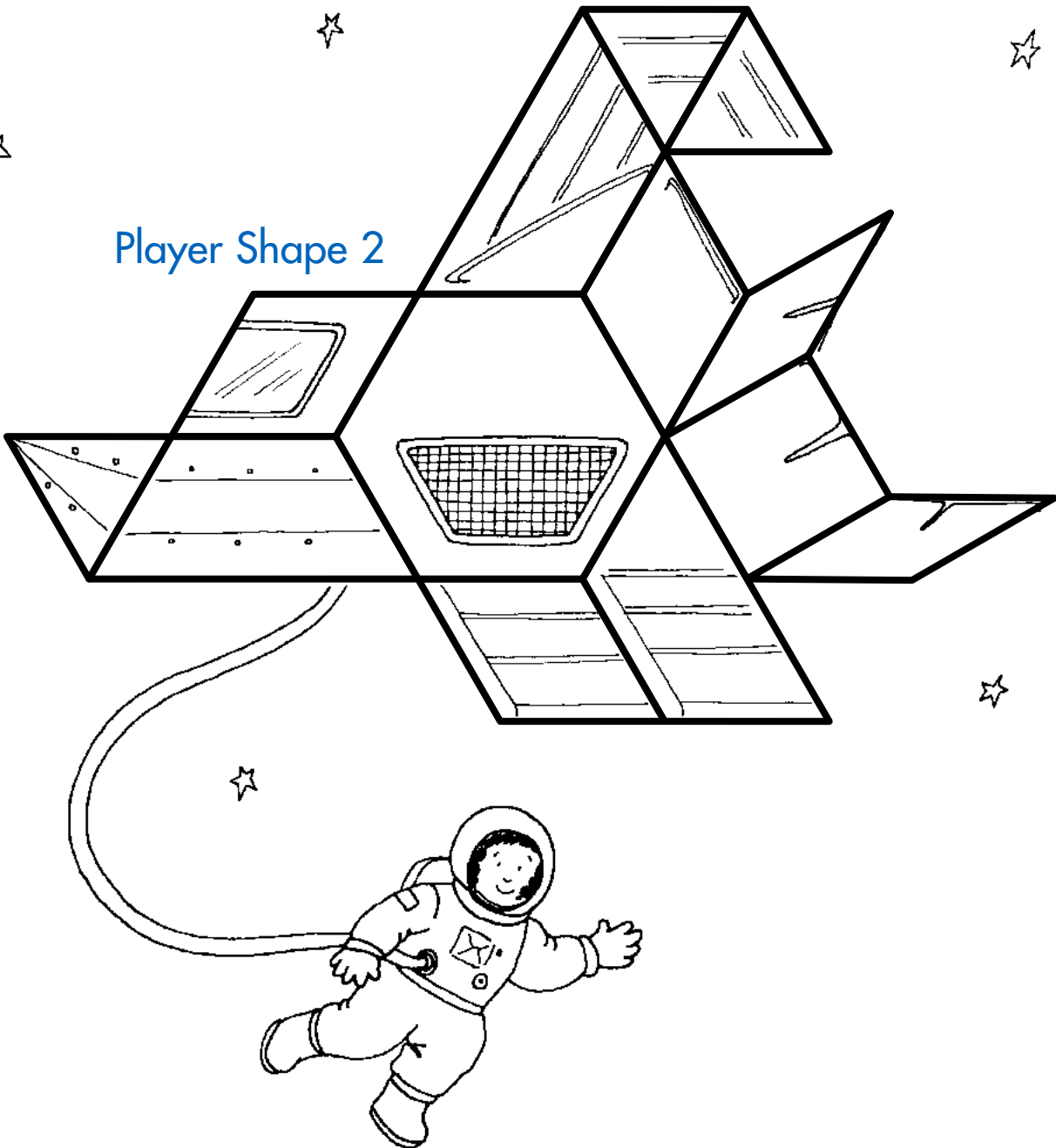



Complete the Moon Crawler. Use the dotted line as a mirror. It is called the line of symmetry.

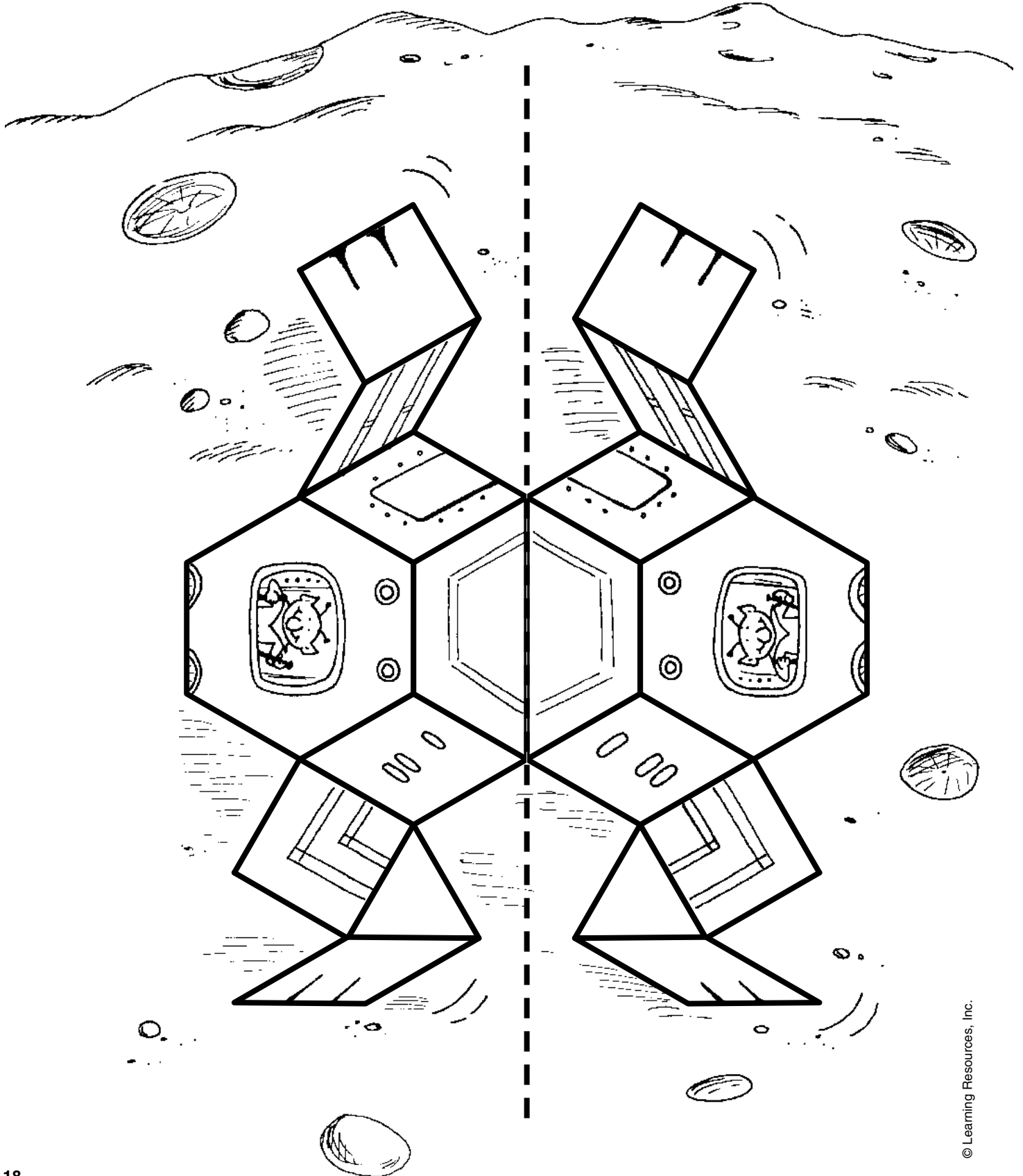



Complete the Rocket.
The dotted line is the
line of symmetry.

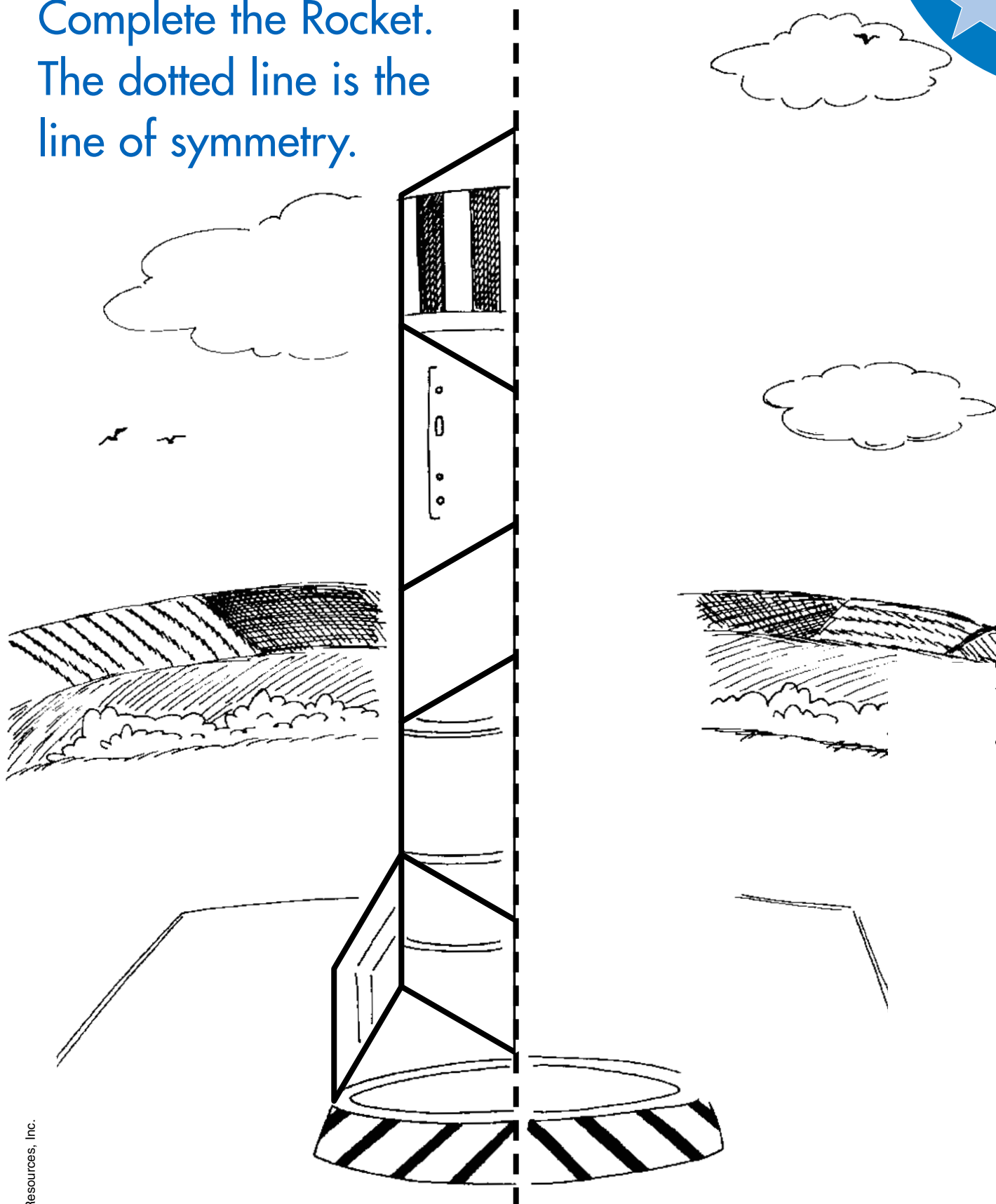

Finish the Comet.

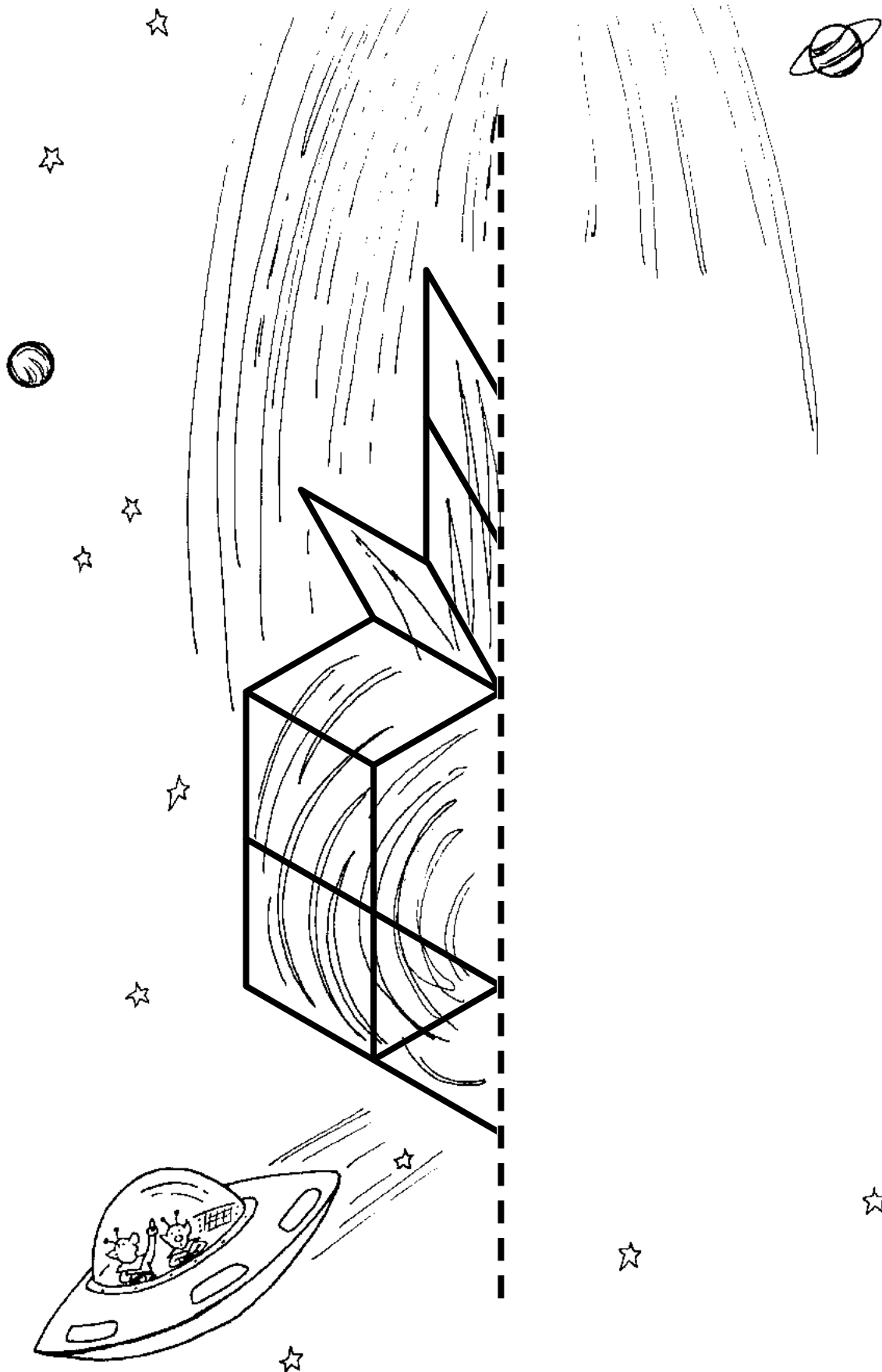

Complete the 2-headed Space Monster.

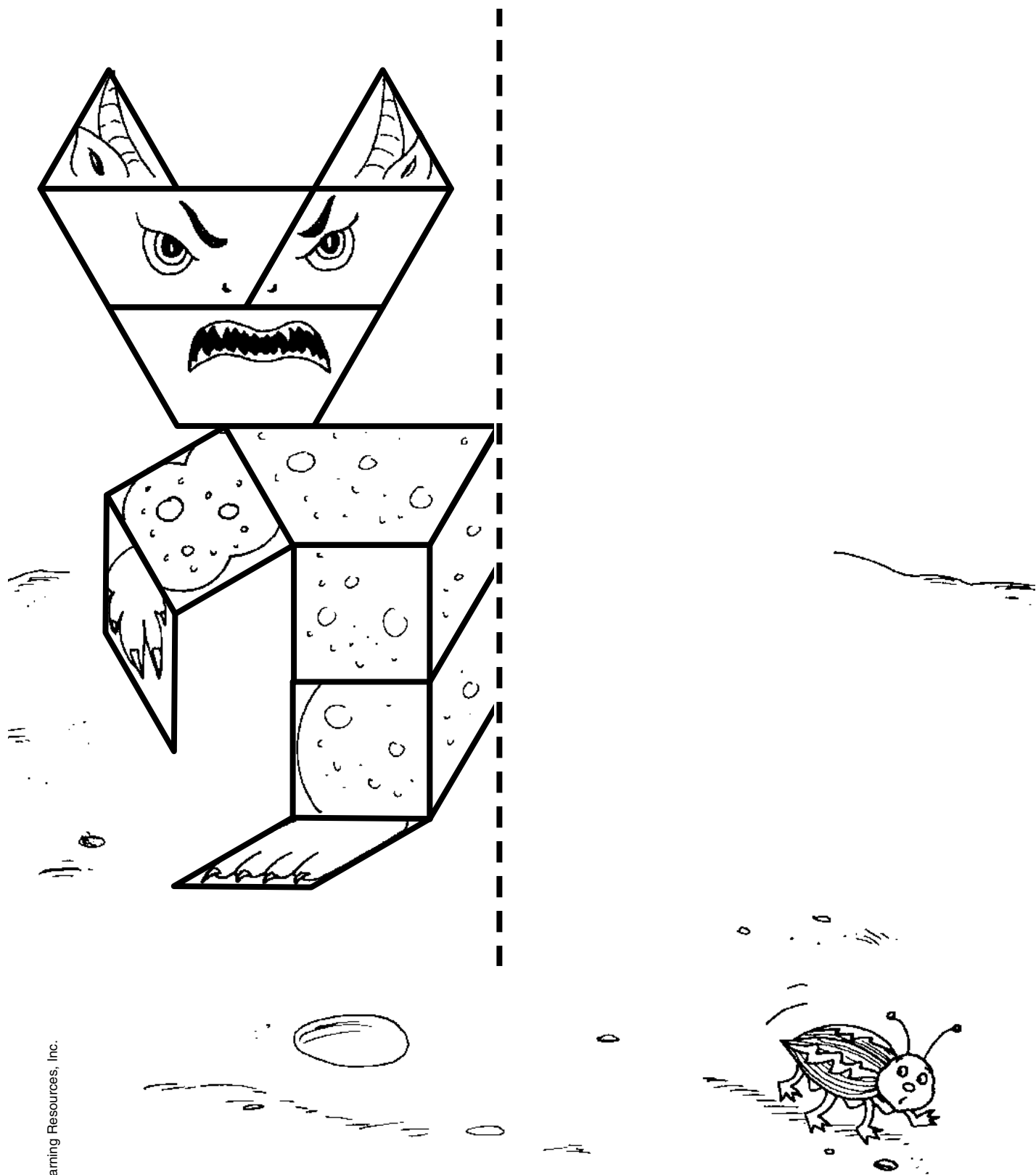



Finish the Space Vehicle.

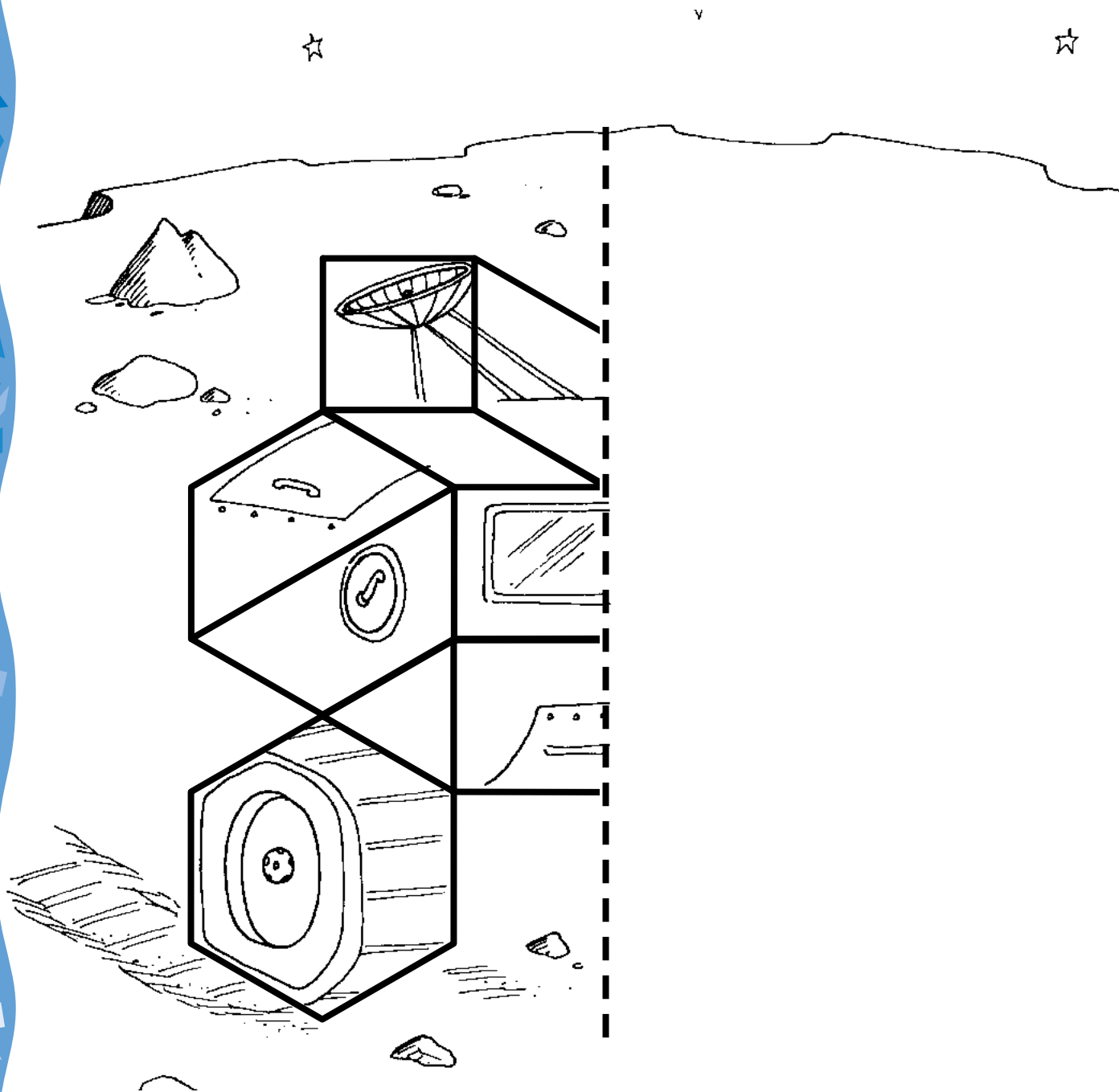

Complete the Space Star.

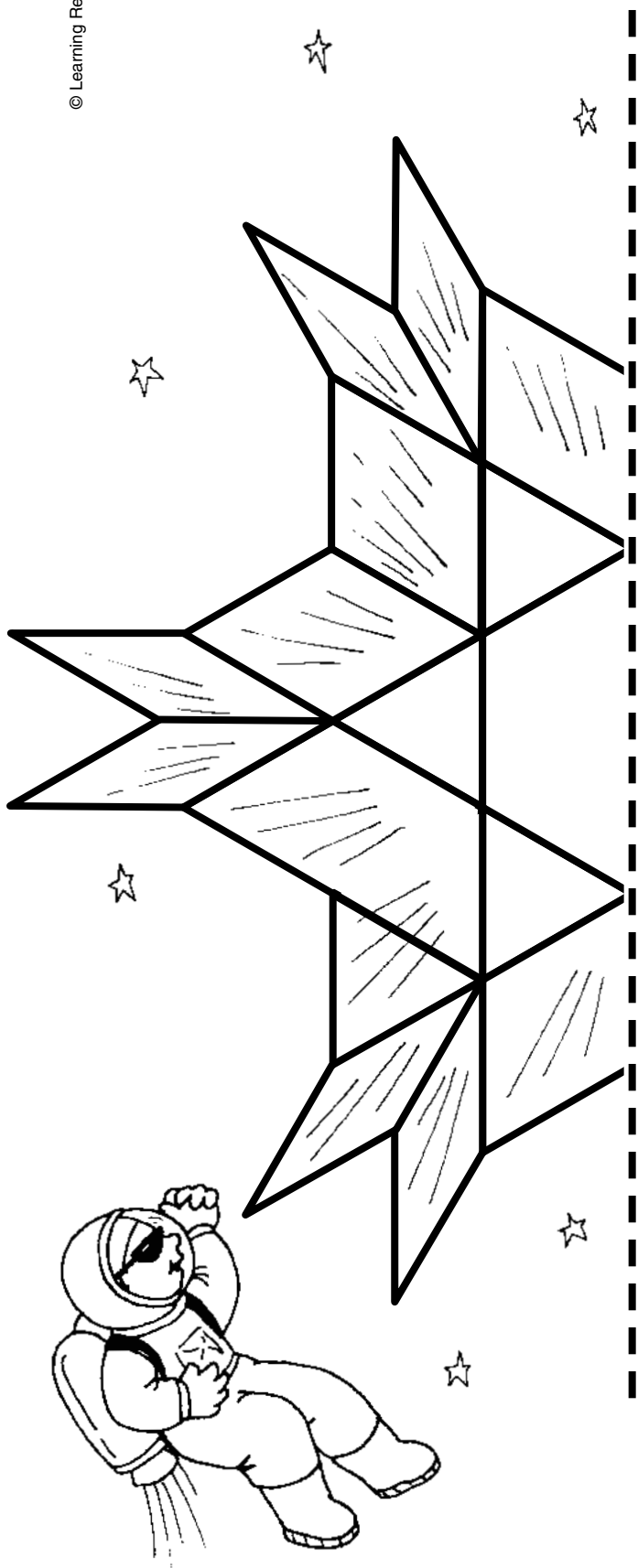

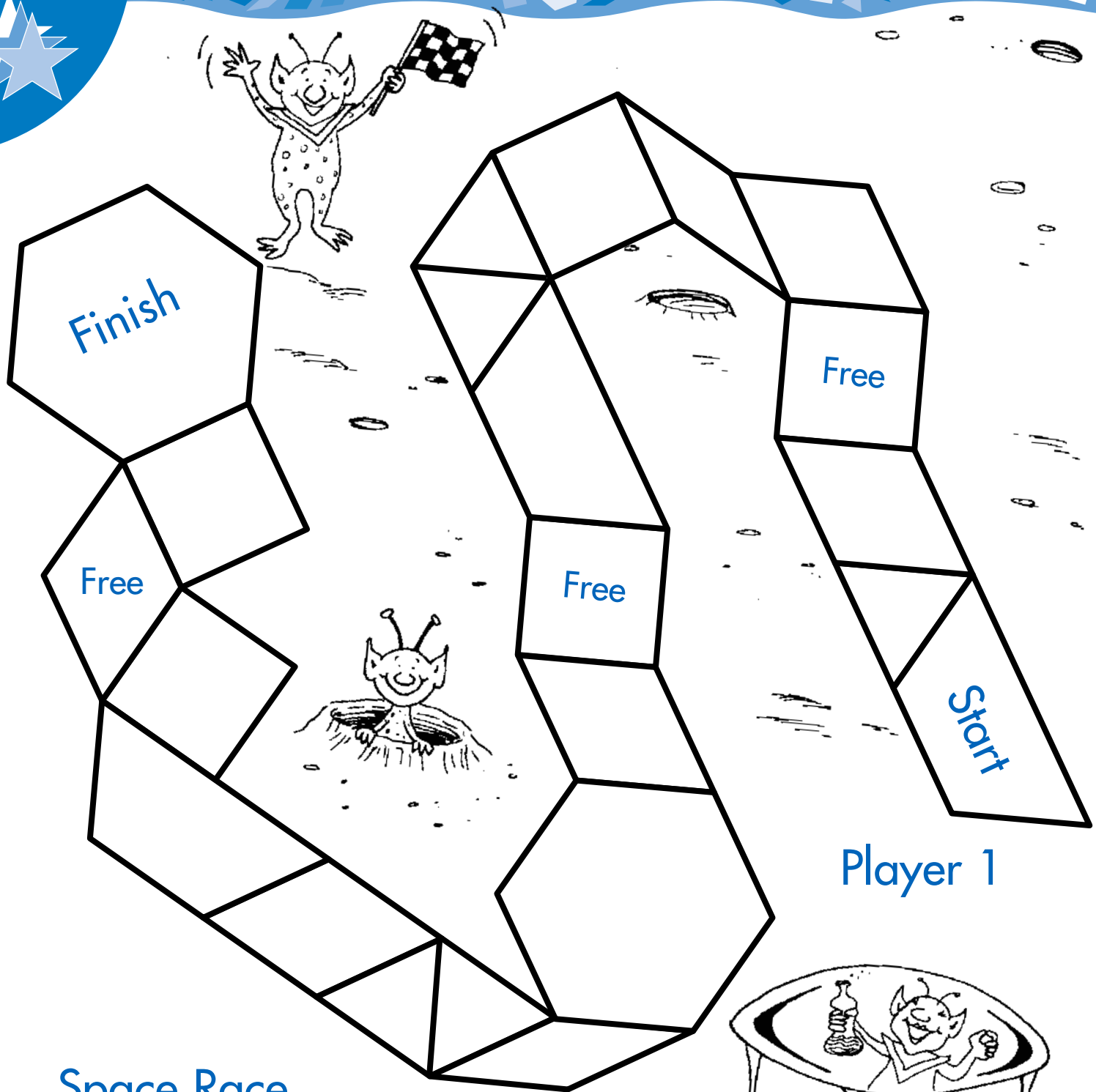

Player 1

Space Race

Players: 2

Object: To be the first player to reach the "Finish" space.

Rules:

- 1) Players begin on the "Start" spaces and continue, in order, along their roads.
- 2) Players take turns drawing pieces from a paper bag. If the piece matches the next shape on the road, the player places it on the road. If not, the piece is returned to the bag. No pieces are placed on "Free" spaces.
- 3) The game ends when one player reaches the "Finish" space.



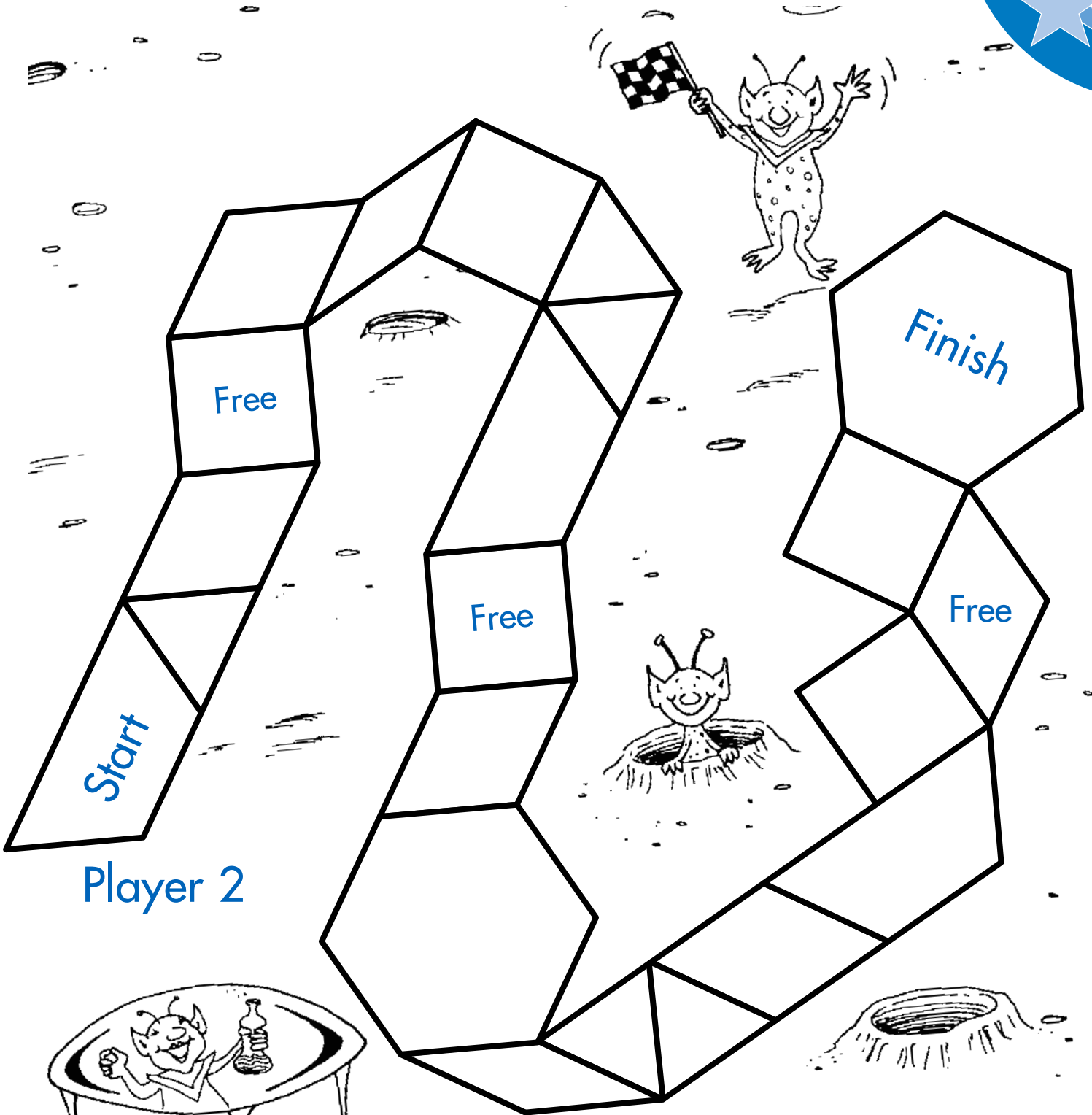

Player 2



© Learning Resources, Inc.



☆ Use pattern blocks to make the Space Ships.

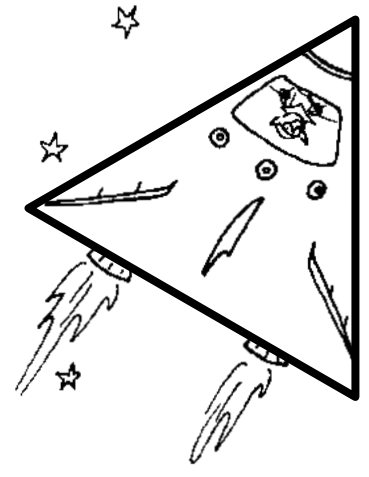
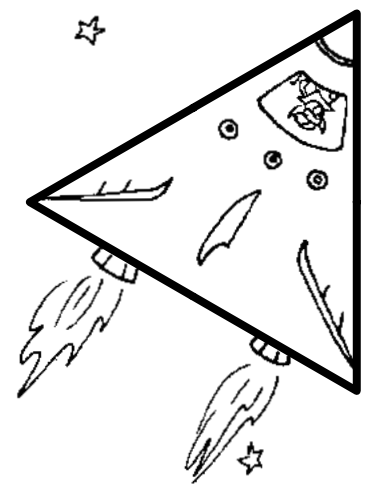
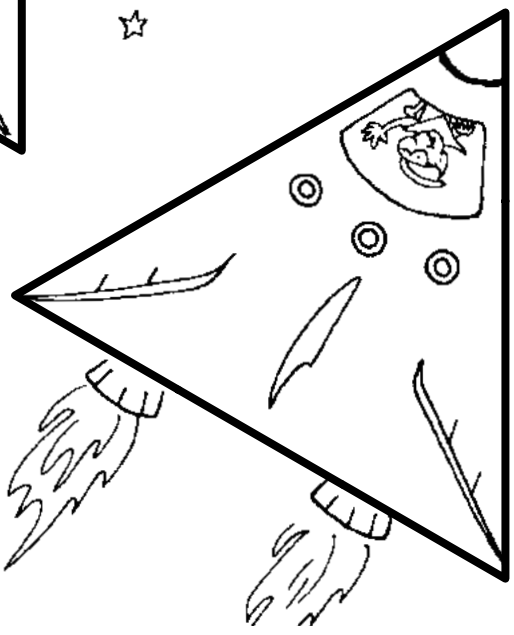
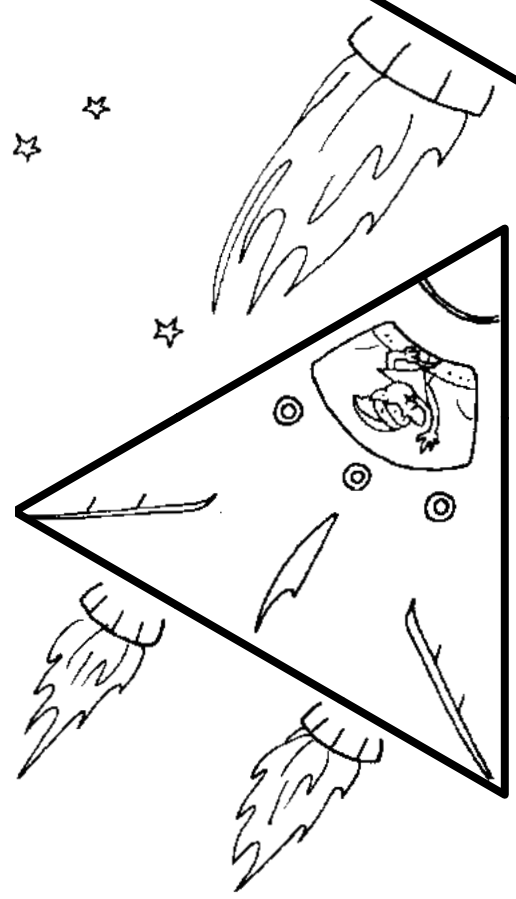
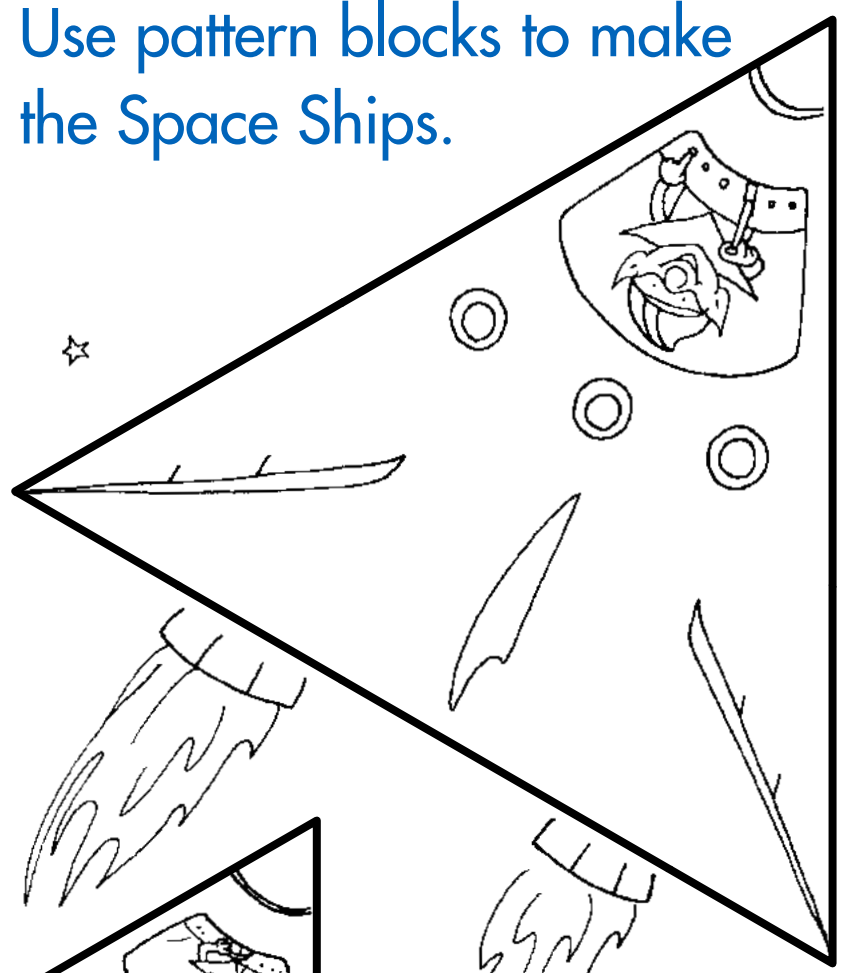

© Learning Resources, Inc.





Make the Asteroid using pattern blocks.

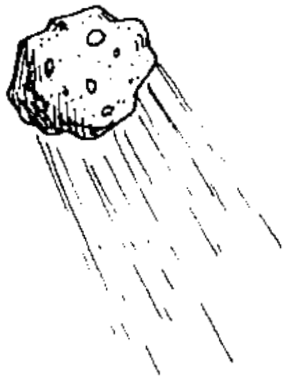



Create the Spiral Galaxy.

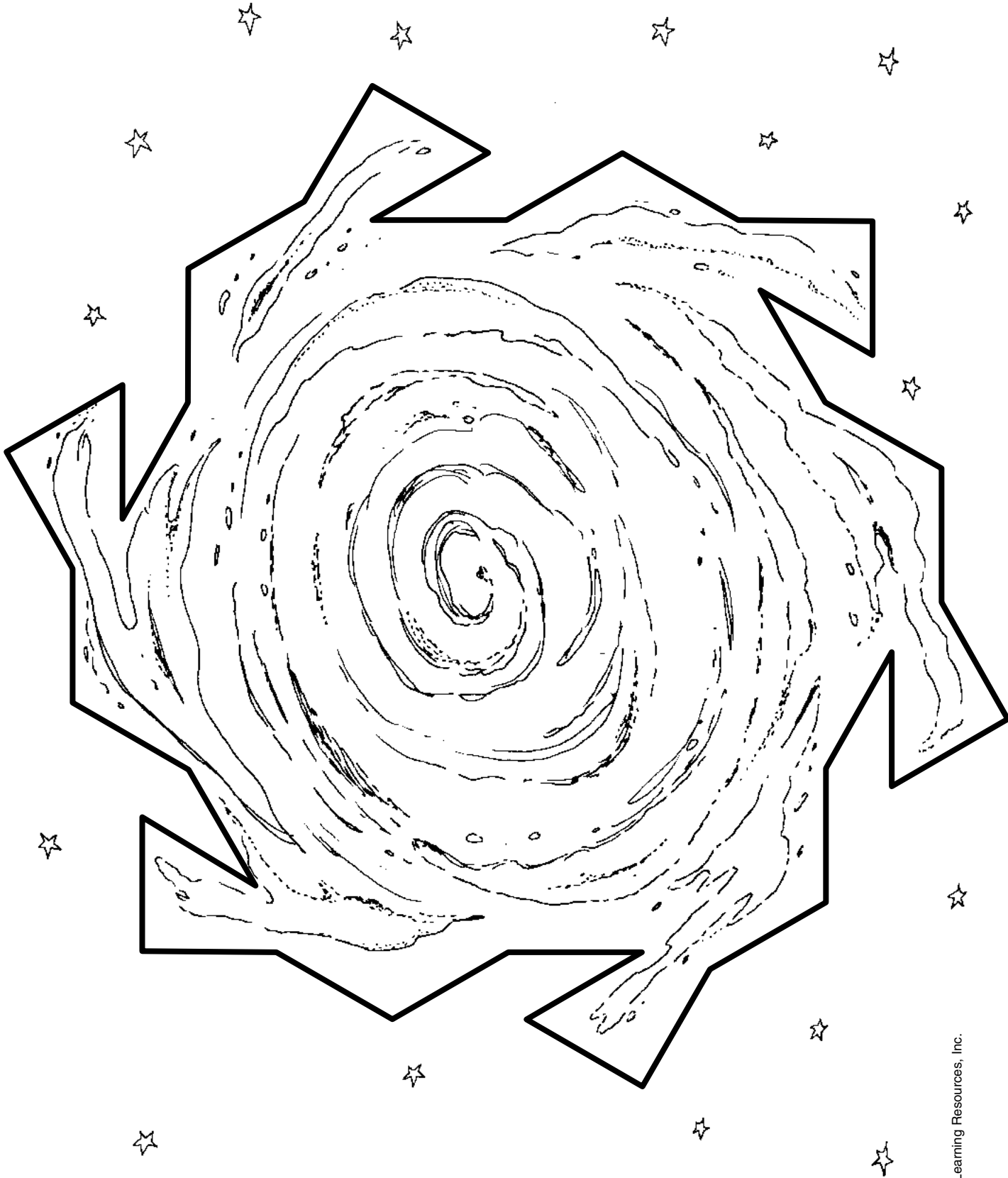

Rainy Day Extensions

1) *Ask your child to make up his or her own space asteroid belt.* Build asteroids with pattern blocks similar to those found on pages 4 and 5.

2) *Create the same shapes using different pattern block pieces.* After your child has completed pages 6, 7, and 8, explore which pieces can be substituted for others.

For example, ask your child, “How many red pieces make up a yellow piece? (2) How many green pieces make up a red piece? (3) Can you combine green and red pieces to make a yellow piece? (Yes)”

3) *Have your child build different shapes for each object on pages 9 through 15.*

4) *Create more symmetric shapes.* Ask your child to show you the line of symmetry.



5) *Take turns with your child creating "half-symmetric" shapes.* Challenge each other to complete the missing halves.

6) *Ask your child to make up a story using pattern blocks to create shapes.* Your child can trace and color the shape on a piece of paper. Write the story below the shape. Hang the picture story in a special place.

7) *Play a pattern block word game.* Modify the rules of the game Hang-Man. Instead of drawing a limb whenever a player guesses a letter incorrectly, place a pattern block piece on the outline of a figure in this book. Players try to guess the word before the figure is complete.

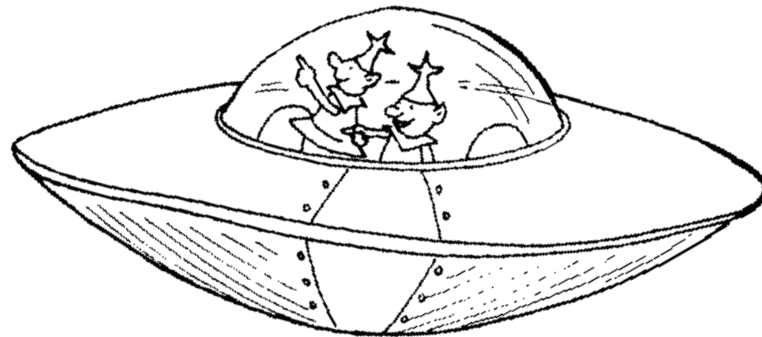

9

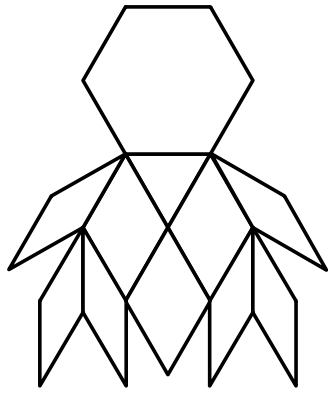

13

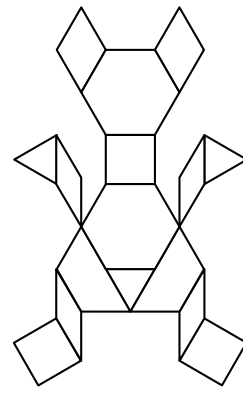

10

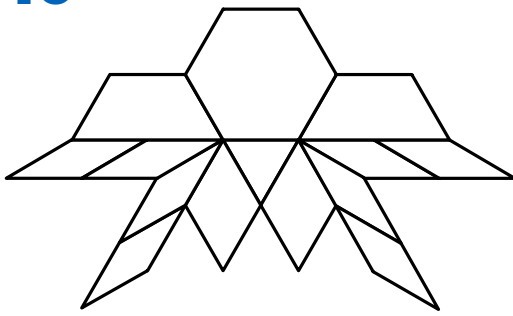

14

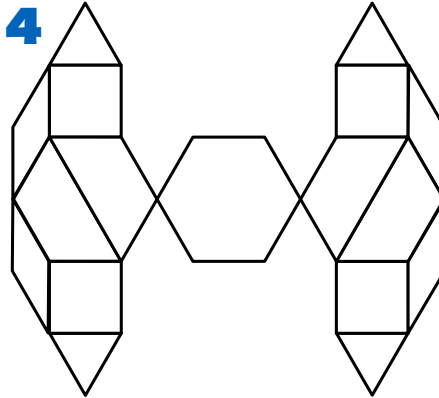

11

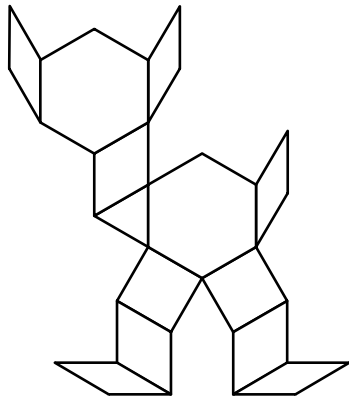

15

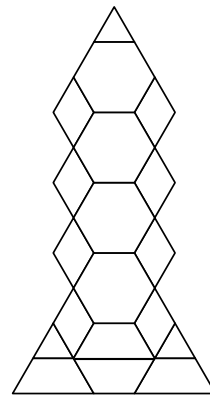

12

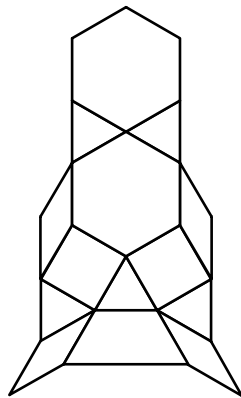

19

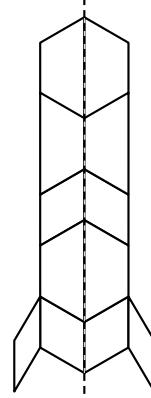

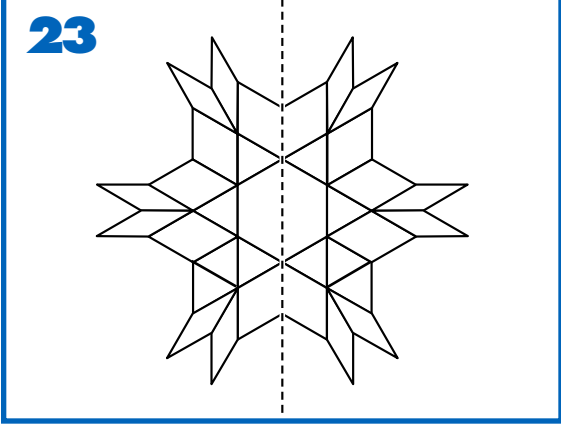
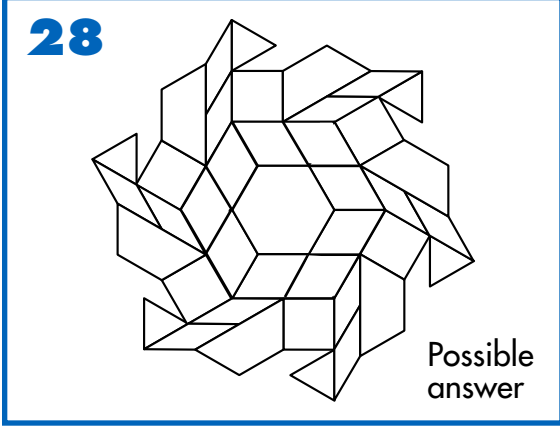
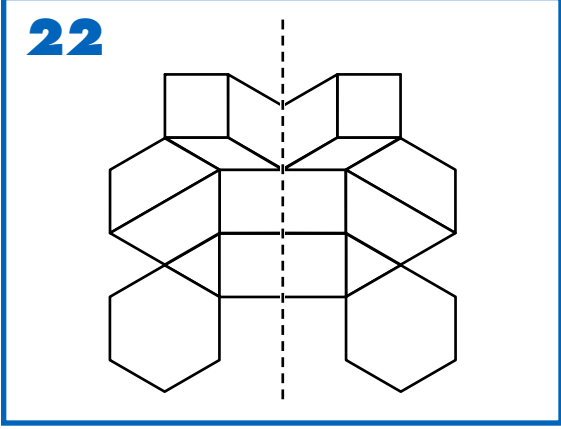
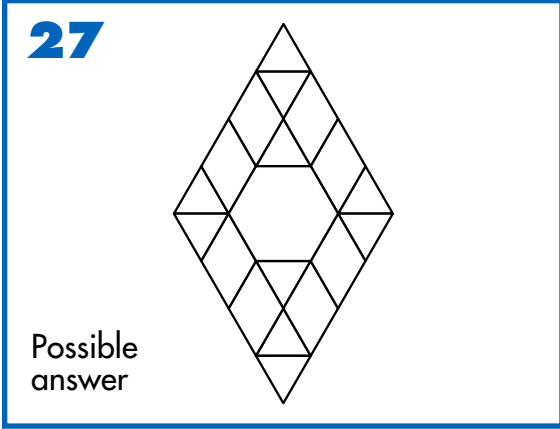
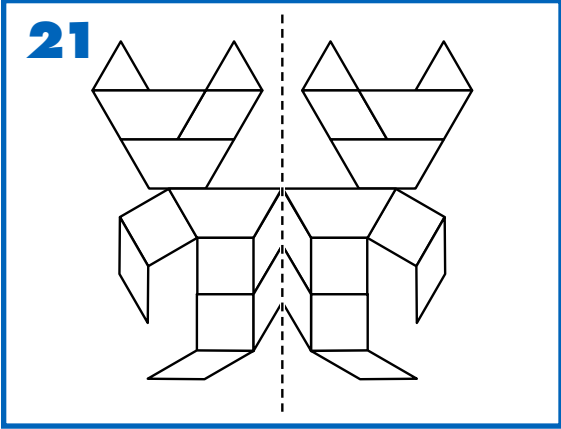
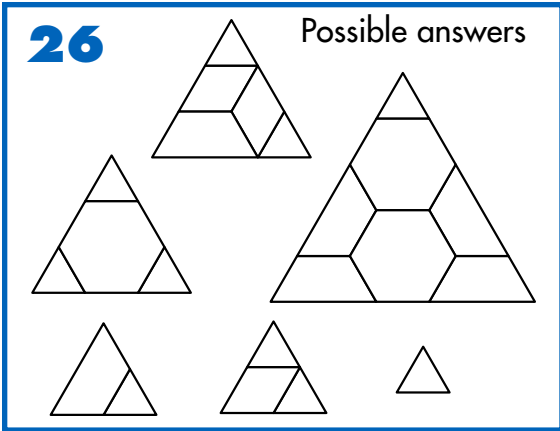
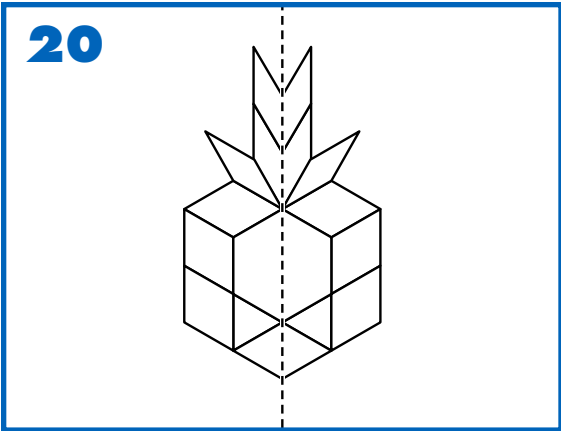

Free Manuals Download Website

<http://myh66.com>

<http://usermanuals.us>

<http://www.somanuals.com>

<http://www.4manuals.cc>

<http://www.manual-lib.com>

<http://www.404manual.com>

<http://www.luxmanual.com>

<http://aubethermostatmanual.com>

Golf course search by state

<http://golfingnear.com>

Email search by domain

<http://emailbydomain.com>

Auto manuals search

<http://auto.somanuals.com>

TV manuals search

<http://tv.somanuals.com>