

TROUBLE SHOOTING

Before going through the check list, check wiring connection. If any of the problems persist after check list has been made, consult your nearest service dealer.

Symptom	Cause	Solution
No power.	The car ignition switch is not on.	If the power supply is properly connected to the car accessory terminal, switch the ignition key to "ACC"
	The fuse is blown.	Replace the fuse.
Disc cannot be loaded or ejected.	Presence of disc inside the player.	Remove the disc in the player, Then put a new one
	Inserting the disc in reverse direction.	Insert the compact disc with the label facing upward.
	The disc is extremely dirty or defective.	Clean the disc or try to play a new one.
	Temperature inside the car is too high.	Cool off or until the ambient temperature return to normal.
	Condensation.	Leave the player off for an hour then try again.
No sound.	Volume is in minimum.	Adjust volume to a desired level.
	Wiring is not properly connected.	Check wiring connection.
Sound skips.	The installation angle is more than 30 degrees.	Adjust the installation angle less than 30 degrees.
	The disc is extremely dirty or defective disc.	Clean the compact disc, then try to play a new one.
The operation keys do not work.	The built-in microcomputer is not operating properly due to noise.	Press the RESET button. Front panel is not properly fixed into its place.
The radio does not work.	The antenna cable is not connected.	Insert the antenna cable firmly.
	The signals are too weak.	Select a station manually.

WWW.Legacycaraudio.com

LEGACY®

LCD87DFX

OWNER'S MANUAL

Mobile Video System

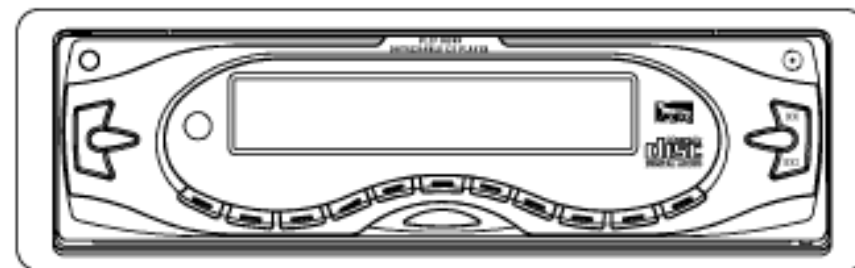

ANTI-THEFT FLIP DOWN DETACHABLE PANEL
 AUTO-LOADING COMPACT DISC PLAYER
 AM/FM/LW(OPTIONAL)-STEREO DIGITAL PLL TUNING RADIO
 WITH INFRARED REMOTE CONTROLLER

CUSTOMER NOTICE

SPECIFICATIONS

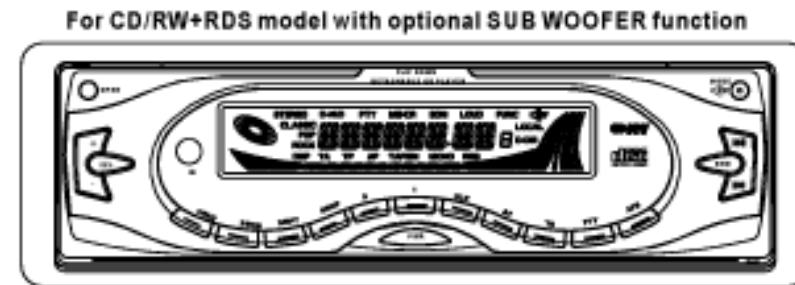
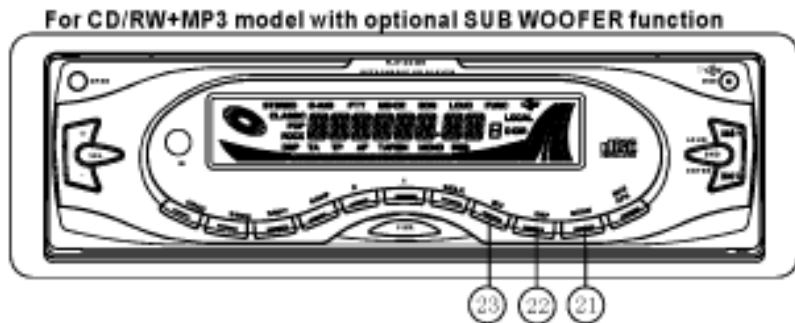
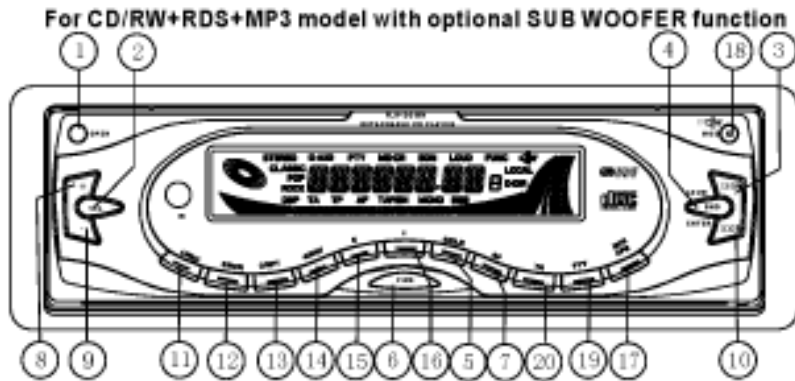

GENERAL

Power requirement.....DC 12V

Current consumption.....5A

POWER OUTPUT..... 4X7W

FM SECTION

	For 3 Bands (Europe)	For 2 Bands (Europe)	For 2 Bands (U.S.A.)
Frequency range	87.5 to 108 MHz	87.5 to 108 MHz	87.5 to 107.9 Mhz

Usable sensitivity.....3uV

I.F Frequency.....10.7MHz.

AM SECTION

	For 3 Bands (Europe)	For 2 Bands (Europe)	For 2 Bands (U.S.A.)
Frequency range	522 to 1620 KHz	522 to 1620 KHz	530 to 1710 Khz

LW SECTION

	For 3 Bands (Europe)	For 2 Bands (Europe)	For 2 Bands (U.S.A.)
Frequency range	144 to 288 KHz		

LINE - OUT [OPTION].

Output.....500mV @ FM 10% THD POWER.

CD PLAYER

System.....compact disc audio system

Usable disc.....compact disc

Signal format.....sampling frequency 44.1KHz
No of quantization bits 1bit

Frequency characteristics.....5-40Hz -5dB 1 0K-20KHz - 5dB

Signal to noise ratio.....70dB [1KHz][IEC-A net work]

Number of channels.....2 STEREO

Chassis dimensions.....184[W] X 54[H] X 170[D]

NOTES

DISC PLAY:

Cleaning discs

Before playing, clean the disc with a clean, lint-free.

Flip the disc in the direction of the arrow.

NOTE:

.Do not use so solvents such as benzene, thinners. Commercially available cleaners or anti static spray damage the unit.

Insert a disc with the label surface down. Doing so may damage the unit.

NOTE:

. Do not try to insert another disc when one has been already inserted.

Doing so may damage the unit.

Handle the disc by its edge. And to keep the disc clean, do not touch the surface.

.Do not stick paper or tape on the disc.

.Do not expose the disc to direct sunlight or heat sources such as hot air ducts. Or leave it in a car parked in direct sunlight where there can be a considerable rise in temperature.



Preparing the Remote Control

Inserting the Batteries

1.Open the battery compartment cover.

2.Insert the new batteries. Make sure that the positive and negative terminals of the batteries are oriented indicated.

3.Close the cover

Using the Remote Control

Face the remote control towards the player front face IR mark (remote control signal receiver).

Operation angle: About ± 30 degree in each the direction of the front of the IR mark.

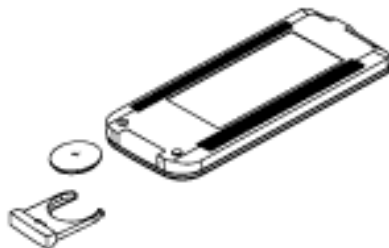

BASIC OPERATION

For CD model with optional SUB WOOFER function

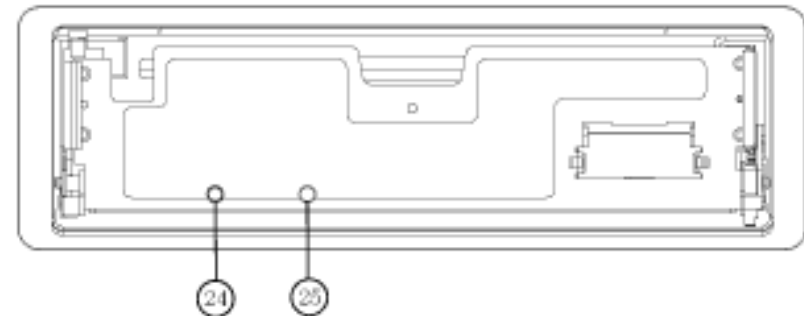

CDC CONNECTOR OR AUX CABLE

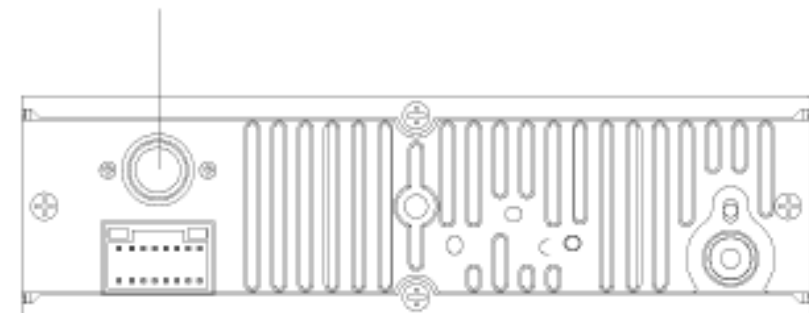

BASIC OPERATION

1. OPEN BUTTON

Press it to flip down the front panel then you can insert the cd disc into the cd compartment
EJ button on the back of the front panel, press it to eject the disc.

2.8.9 SEL(AUDIO MODE SELECT)/ +/- BUTTONS

Press SEL button to change the mode in the sequence of



A. The volume level can be adjusted at any time by pressing the audio level+ or - button as select mode has been initially defaulted at volume mode.

The volume level is also obtained by stepping through the SEL button until the function VOL is displayed and then press + or - button to adjust the sound level.

B. Press sel button to select the BAS, TRE, BAL, FAD then press +/- button to adjust them.

C. Press SEL button hold for more than 2 seconds and select + or - button can have a beep sound.

3.10. TRACK UP/DOWN BUTTONS

A. During CD mode, press button allow you to track forwards.

Hold the button allow you to skip forwards.

B. During Mp3 mode, press button allow you to track forwards.

Hold the button allow you to skip forwards.

For Mp3 playing(MP3 model only), these two buttons act as the digit 8 & 9 key.

C. During RADIO mode, press and hold or for more than 2 seconds you can manual search channel. Then press or , you can have auto search channel.

4. BAND BUTTON

Press it to select your desired radio band and the band which is selected will be displayed on LCD.

Press it hold for more than 2 seconds can have LOUD mode.

LOUD MODE:

When reduce the volume to half level, press it to enhance the bass effect.

For Mp3 playing(MP3 model only), this button can act as the **ENTER** key.

5. CLOCK BUTTON

Press it to display time on LCD for few seconds. Press it hold and then press or button to adjust hour or minute.

6. POWER BUTTON

Press it to turn on or off the unit.

7. AF BUTTON(for RDS model only)

AF [ALTERNATIVE FREQUENCIES](For RDS only)

When pressed short, AF switching mode is selected and the state of AF switching mode is displayed by AF segment in display

Segment off: AF switching mode off.

Segment on: AF switching mode on, and has RDS information.

Segment flashing: AF switching mode is selected, but RDS information is not received yet.

When AF switching mode is selected, the radio checks the signal strength of AF all the time.

The interval of checking time of each AFs depends on the signal strength of current station, from a few minute for strong station to a few seconds for weak station. Everytime that new AF is stronger than current station, it switches over to that frequency for very short time, and NEW FREQUENCY is displayed for 1-2 second. Because the mute time of AF switching or checking time is very short, it is almost inaudible in case of normal program.

When pressed long, it is activated of regional mode on /off .

Regional mode ON

AF switching or PI SEEK is implemented to the station which have all PI codes are the same as current station.

REG of individual segment is turned on also together with displaying REG ON numeric

INSTALLATION

CAUTION: Do not install the detachable panel before connecting the wire.

1. The unit is designed for negative terminal of the battery which is connected to the vehicle metal. Please confirm it before installation.
2. If the car interior is extremely hot, as after being parked in the sun, do not use the player until the car has been driven for a while to cool off the interior.
3. Press the OPEN button to flip down the front panel (see fig.1), then take away the front panel (see fig.2) and put it in the protective case (see fig.3) safe keeping.
4. Install the front panel back into its bracket and then push it back to the position for playing (see fig.4).

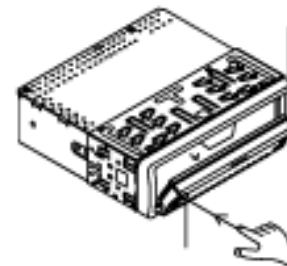

OPEN BUTTON

(FIG. 1)

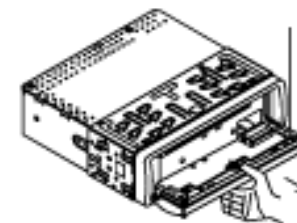

(FIG. 2)

PROTECTIVE CASE

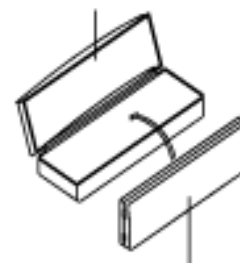

(FIG. 3)

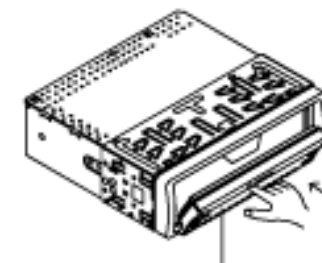

FRONT PANEL

(FIG. 4)

INSTALLATION

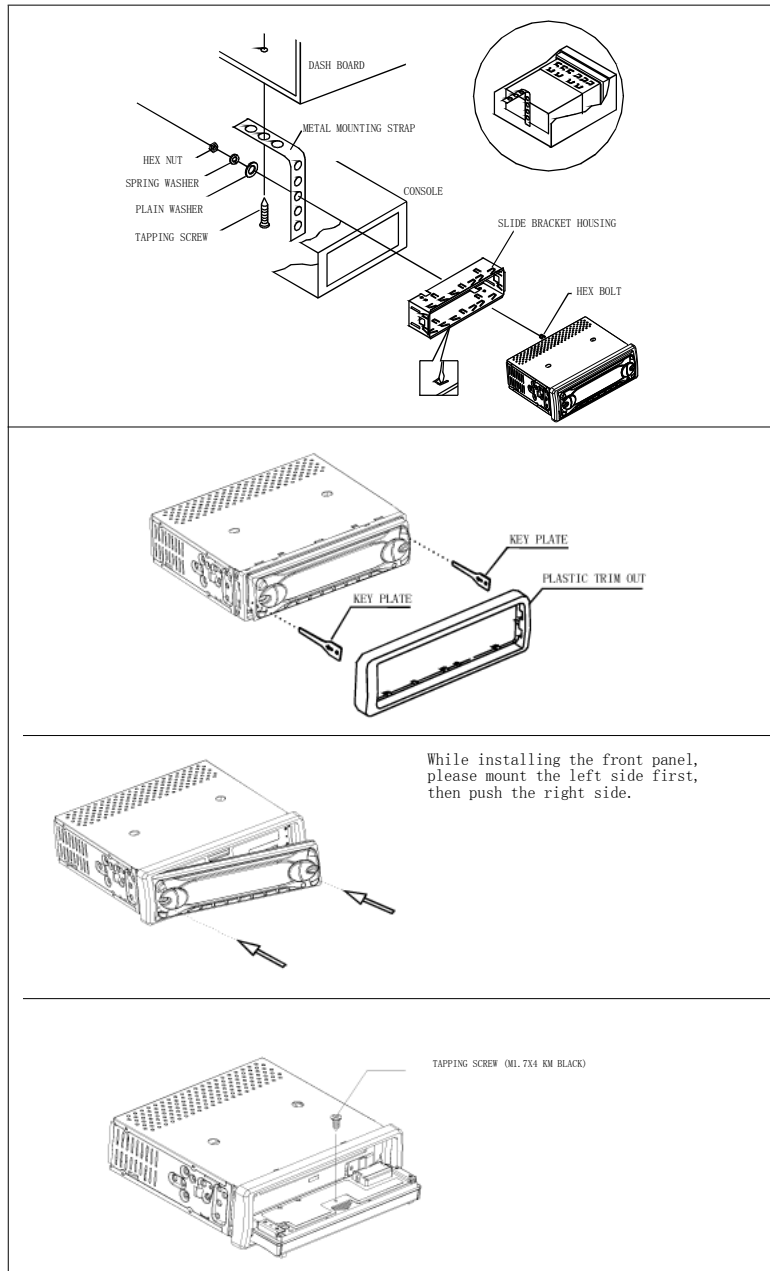

BASIC OPERATION

display for a few seconds.

Regional mode OFF

The regional code in the format of PI code is ignored when AF switching or PI SEEK is implemented.

REG of individual seg. is turned off together with displaying

REG OFF on numeric display for a few seconds.

11-12-13-14-15-16. PRESET MEMORY BUTTONS

A). To memorize the current frequency, press any one of the six preset Buttons hold for more than 2 seconds.

B). To recall the preset memory, press one of the preset buttons [0-6].

C) RADIO MODE

When pressed short, these keys select a preset station directly, When pressed longer than one seconds,

current station is stored in preset memory bank. When PTY mode is selected, the preset memory buttons is shared as follows:

PTY music group - - PTY speech group - - OFF MUSIC SPEECH

- | | |
|----------------------|-------------------------------|
| 1. POP M, ROCK M | 1. NEWS, AFFAIRS, INFO |
| 2. EASY M, LIGHT M | 2. SPORT, EDUCATE, DRAMA |
| 3. CLASSICS, OTHER M | 3. CULTURE, SCIENCE, VARIED |
| 4. JAZZ, COUNTRY | 4. WEATHER, FINANCE, CHILDREN |
| 5. MATION M, OLDIES | 5. SOCIAL, RELIGION, PHONEIN |
| 6. FOLK M | 6. TRAVEL, LEISURE, DOCUMENT |

D). In CDP mode, press 1PAU button to pause CDP playing, press it again to resume CDP playing.

E). In CDP mode, press 2SCN button to play the first 10 seconds part of each song, press it again to stop scanning and retain playing the song currently selected.

F). In CDP mode, press 3RPT button to play the current track repeatedly. Press it again to cancel this mode.

G). In CDP mode, press 4SHF button to play the track in random order. Press it again to cancel this mode.

H). In CDC mode M5/M6: It moves to up or down the DISC, then play.

17.APS/MP3 BUTTON

In radio mode:

When short pressing, the radio searches for each preset station.

When the field strength level is more than the threshold level of stop level, the radio is holding at that preset number for few secretary with releasing mute, and than searches again. In FM band, FM 1, FM 2 and FM 3 is checked one at a time. When long pressing (more than 1 second), Zhe radio searches from the current frequency and checks the signal strength level until 1 cycle search is finished. And then 6 strongest stations are preset to the corresponding preset number. The AS operation is implemented in the each band of selected band.

When the AS operation is finished, the radio executes the preset scan.

In MP3 mode, press 0-9 and ENTER button to play the track in 1-108 number.

18.MODE BUTTON

Press it repeatedly to select CDP, AUX and RADIO mode in sequence and circulation.

For **SUB WOOFER** function(optional), press and hold for more than 2 seconds can have WOOFER Mode.

For Mp3 playing(MP3 model only), this button can act as the digit 7 key.

19.PTY(PROGRAM TYPE) BUTTON

This key is operated as follows:

PTY MUSIC group- - PTY SPEECH group- - PTY OFF

While selecting PTY TYPE, its selection is implemented by preset buttons as described in preset key.

BASIC OPERATION

When PTY is selected, the radio starts to search corresponding PTY information, and stops if the corresponding PTY information is detected.

If corresponding PTY information is not existed any more, PTY type is automatically exit to normal mode.

20.TA BUTTON (for RDS model only)

TA function [TRAFFIC ANNOUNCEMENT] BUTTON (For RDS only)

When pressed short, it is activated as TA mode on or off.

When TA mode is on and traffic announcement is transmitted:

- 1). When the unit is in CD mode, it will switch to radio mode temporarily.
- 2). Temporary switch over to an EON linked station when EON detects a traffic announcement on that other program.
- 3). If the volume level was under the threshold point, it will be raised to the threshold point. But the user changed the volume level which was more than the threshold point (min. TA volume level), it will be set to the last level.

When pressed long, it is selected **EONTA LOCAL / EONTA DISTANCE** mode.

The purpose of this key is to reduce unwanted EON TA switching, which EON TA information was received from current station and the radio switched to that EON linked station, but no information could not be received because the EON linked station is located too far from that area.

So the radio is switched back to current station again.

In above operation, a customer listen to a wrong program or mute sound for a while.

- EONTA LOCAL mode

When the filed strength level of EON linked is less than the threshold level, the radio does not switch that station, and a customer can hardly listen to any disturbances.

When EONTA LOACL mode is selected, EONTA LO on numeric display is indicated for a few seconds.

- EONTA DISTANCE mode

EON TA switching is try to implemented by the information of current station .

When EONTA DISTANCE mode is selected, EONTA DX on numeric display is indicated for a few seconds.

21.SCAN BUTTON

Press it to scan up by one channel step with station detection. If a valid signal has detected, the current frequency is blinked with in 5 seconds, then press it again to stop scan and remain the current frequency; otherwise, the unit continue to scan up by one channel step with station detection 5 seconds later.

22.DSP BUTTON

Press it to switch between 4 preset equalizer curves:FLAT,CLAS,POP M,ROCK M,The sound quality will be changed.

23.MUTE BUTTON

Press it to eliminate the sound immediately.

24.FLASHING LED

If the front panel is not on the main unit, LED will be flashing.

25.RESET

RESET button is placed on the housing and must be activated with either a ballpoint pen or thin metal object. The RESET button is to be activated for the following reasons:

- Initial installation of the unit when all wiring is completed.
- All the function buttons do not operate.
- Error symbol on the display.

Note: If press RESET button, the unit can't work yet, please use a cotton swab soaked in isopropyl alcohol to clean the socket on the back of the front panel.

ELECTRIC CONNECTION

FOR 4X40W

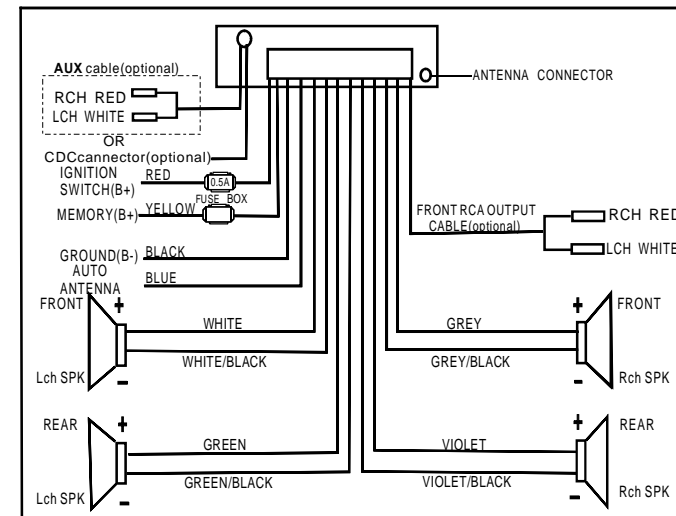

FOR WOOFER(4X40W)

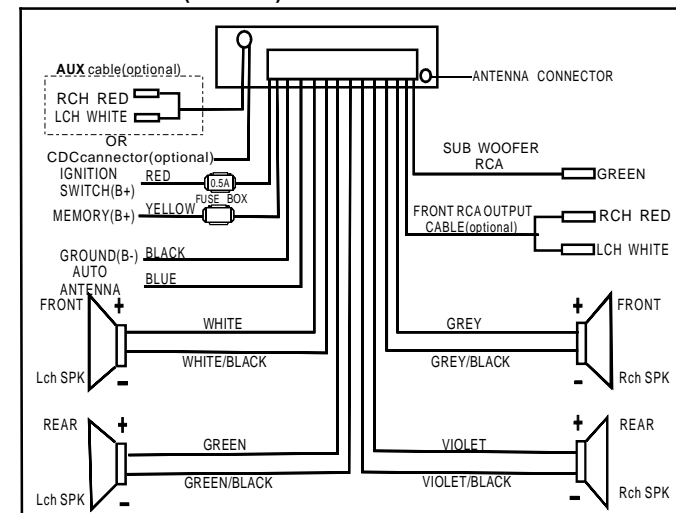

NOTE:

In spite of having any kinds of speaker system, must use 4 ohms impedance of speaker to reduce the distortion during high volume level.

Free Manuals Download Website

<http://myh66.com>

<http://usermanuals.us>

<http://www.somanuals.com>

<http://www.4manuals.cc>

<http://www.manual-lib.com>

<http://www.404manual.com>

<http://www.luxmanual.com>

<http://aubethermostatmanual.com>

Golf course search by state

<http://golfingnear.com>

Email search by domain

<http://emailbydomain.com>

Auto manuals search

<http://auto.somanuals.com>

TV manuals search

<http://tv.somanuals.com>