

LEGACY®

LDVD 84

OWNER'S MANUAL Mobile Video System

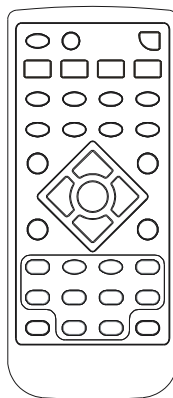
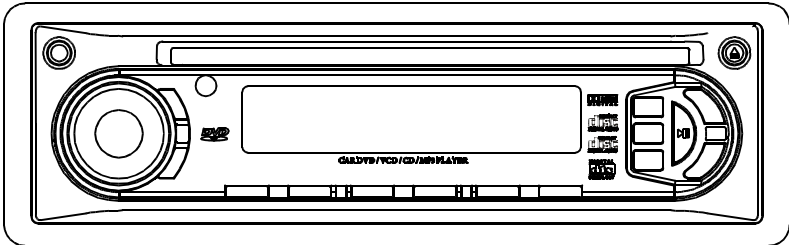

**DVD/VCD/CD/MP3 PLAYER WITH
MANUALLY TUNED SYNTHESIZER STEREO RADIO**

CONTENTS

Safety Information	3
Disc Notes	4
Installation	5
Electric Connection	8
Remote Control	9
Preparing the Remote Control	10
Basic Operation	11
On-Screen Display Function	15
Multi-audio Language Function	16
Menu Function.....	16
Title Menu Function (For DVD only)	16
Multi-subtitle Language Function (For DVD only)	16
Multi-angle Function (For DVD only).....	17
MP3 Disc Play	17
Setup	18
Initial Setup	18
General Setup	18
Speaker Setup	20
Audio Setup	20
Preferences Setup.....	21
Defaults Table.....	23
Specifications	24
Trouble Shooting	25

SAFETY INFORMATION

CAUTION:

THIS DVD PLAYER IS A CLASS I LASER PRODUCT. HOWEVER THIS DVD PLAYER USES A VISIBLE/INVISIBLE LASER BEAM WHICH COULD CAUSE HAZARDOUS RADIATION EXPOSURE IF DIRECTED. BE SURE TO OPERATE THE DVD PLAYER CORRECTLY AS INSTRUCTED.

USE OF CONTROLS OR ADJUSTMENTS OR PERFORMANCE OF PROCEDURES OTHER THAN THOSE SPECIFIED HEREIN MAY RESULT IN HAZARDOUS RADIATION EXPOSURE. DO NOT OPEN COVERS AND - DO NOT REPAIR YOURSELF. REFER SERVICING TO QUALIFIED PERSONNEL.

WARNING:

- TO REDUCE THE RISK OF FIRE OR ELECTRIC SHOCK, DO NOT EXPOSE THIS EQUIPMENT TO RAIN OR MOISTURE.
- TO REDUCE THE RISK OF FIRE OR ELECTRIC SHOCK, AND ANNOYING INTERFERENCE, USE ONLY THE RECOMMENDED ACCESSORIES.
- THIS DEVICE IS INTENDED FOR CONTINUOUS OPERATION.

This product incorporates copyright protection technology that is protected by method claims of certain U.S. patents and other intellectual property rights owned by Macrovision Corporation and other rights owners. Use of this copyright protection technology must be authorized by Macrovision Corporation, and is intended for home and other limited viewing uses only unless otherwise authorized by Macrovision Corporation. Reverse engineering or disassembly is prohibited.

Region Management Information

Region Management Information:

This DVD Player is designed and manufactured to respond to the Region Management Information that is recorded on a DVD disc. If the Region number described on the DVD disc does not correspond to the Region number of this DVD Player, this DVD Player cannot play this disc.

DISC NOTES

Disc formats supported by this player



DVD
12 cm disc
(Single-sided disc only)



Video CD
12 cm disc



CD
12 cm disc



MP3
12 cm disc

Discs which cannot be played with this player

- DVD-ROM
- DVD-R/DVD-RAM
- CDV
- CD-G

Handling and Cleaning

- Dirt, dust, scratches and warping disc will cause misoperation.
- Do not place stickers or make scratches on discs.
- Do not warp discs.
- A disc should always be kept in its case when not in use to prevent from damaging.
- Do not place discs in the following places:
 1. Direct sunlight
 2. Dirty, dusty and damp areas
 3. Near car heaters
 4. On the seats or dashboard

Disc Cleaning

Use a dry soft cloth to wipe the surface. If the disc is quite dirty, use a soft cloth slightly moistured with isopropyl (rubbing) alcohol. Never use solvents such as benzine, thinner or conventional record cleaners as they may mar the surface of the disc.

Note:

A disc may become somewhat scratched (although not enough to make it unusable) depending on your handle it and conditions in the usage environment.

Note these scratches are not an indication of any problem with the player.

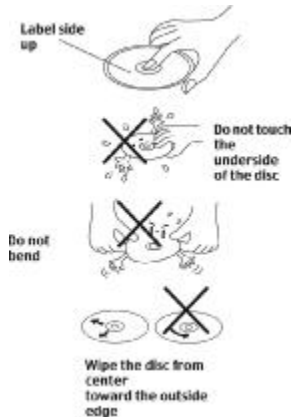

Preparing New Discs with Rough Spots

A new disc may have rough edges on its inside and outside edges. If a disc with rough edges is used, the proper setting will not be performed and the player will not play the disc. Therefore, remove the rough edges in advance by using a ball point pen or pencil as shown on the right. To remove the rough edges, press the side of the pen or pencil against the inside and outside edges of the disc.

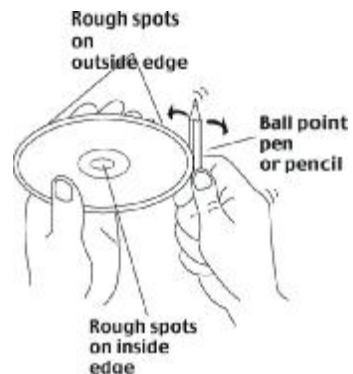

INSTALLATION

Notes:

Choose the mounting location where the unit will not interfere with the normal driving function of the driver.

Before finally installing the unit, connect the wiring temporarily and make sure it is all connected up properly and the unit and the system work properly.

Use only the parts included with the unit to ensure proper installation. The use of unauthorized parts can cause malfunctions.

Consult with your nearest dealer if installation requires the drilling of holes or other modifications of the vehicle.

Install the unit where it does not get in the driver's way and cannot injure the passenger if there is a sudden stop, like an emergency stop.

If installation angle exceeds 30 from horizontal, the unit might not give its optimum performance.

Avoid installing the unit where it would be subject to high temperature, such as from direct sunlight, or from hot air, from the heater, or where it would be subject to dust, dirt or excessive vibration.

DIN FRONT/REAR-MOUNT

This unit can be properly installed either from "Front"(conventional DIN Front-mount) or "Rear"(DIN Rear-mount installation, utilizing threaded screw holes at the sides of the unit chassis). For details, refer to the following illustrated installation methods.

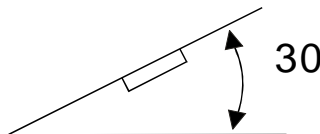

INSTALLATION

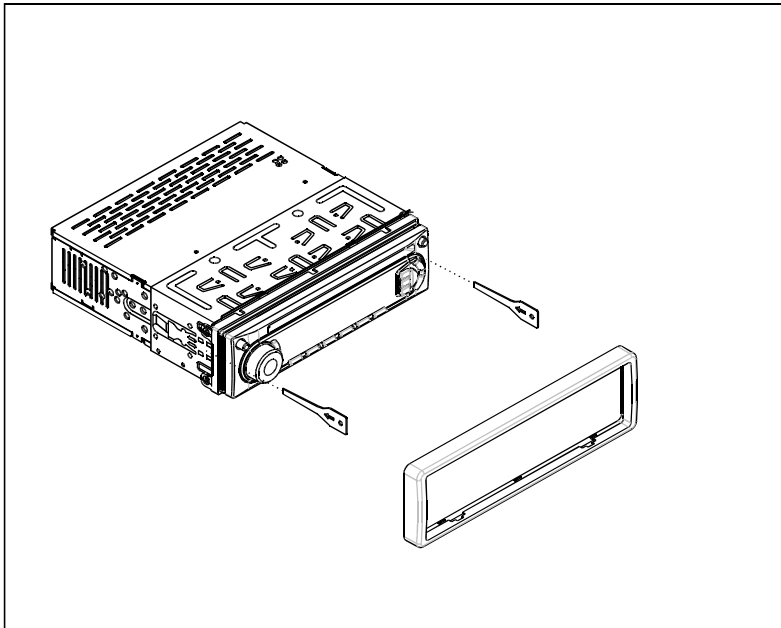
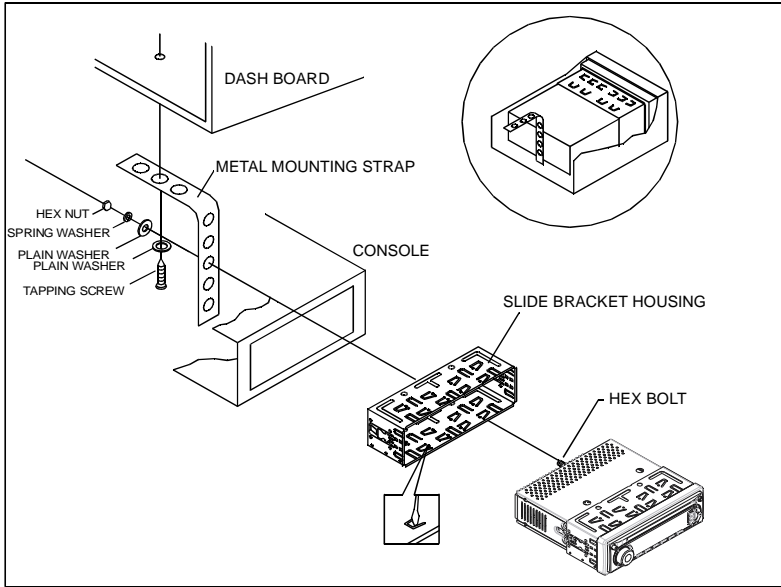

INSTALLATION

HOW TO REMOVE AND INSTALL THE FRONT PANEL

1. Press the release button and pull-off the front panel.

Keep front panel into the case.

2. To install the front panel, insert the panel into the housing and make sure the panel is properly installed, otherwise, abnormalities occurs on the display or some keys will not function properly.

REMOVING THE FRONT PANEL

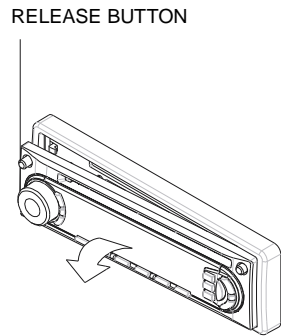
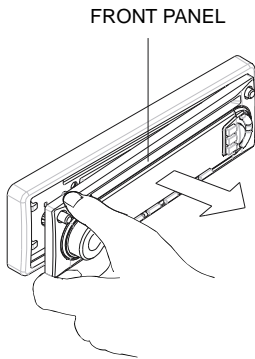

INSTALLING THE FRONT PANEL

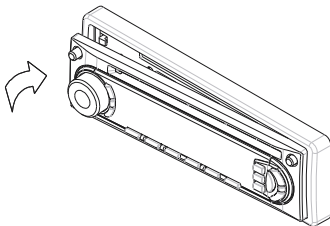

ELECTRIC CONNECTION

WIRING CONNECTION

FOR 4x7W SYSTEM

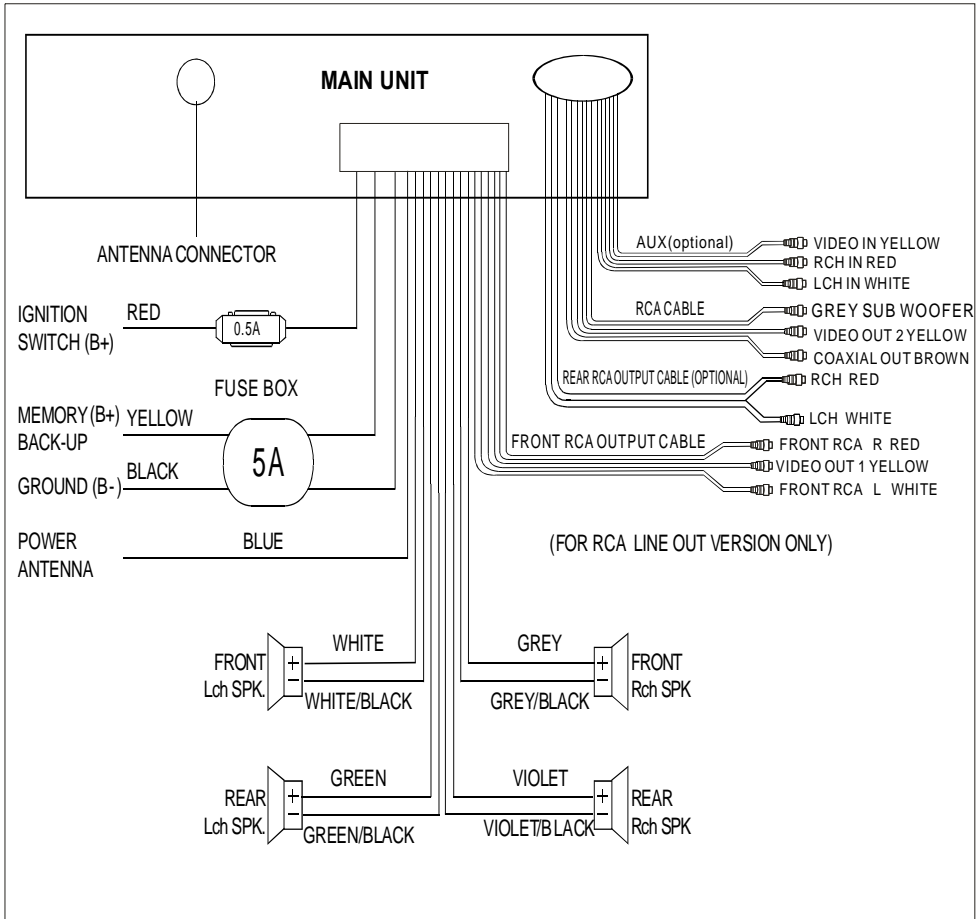

REMOTE CONTROL

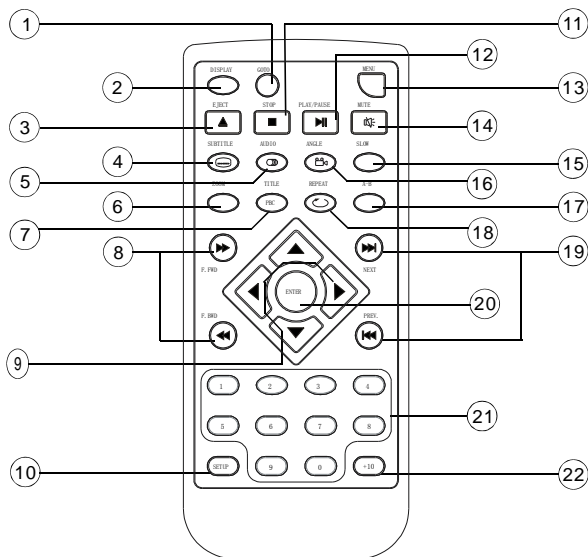

- | | |
|------------------|--|
| 1. GOTO | Disc search button, cooperatively used with numeric buttons |
| 2. DISPLAY | Display statistical disc information during playback |
| 3. EJECT | Press it to eject the disc. (EJECT is enabled in DISC MODE only) |
| 4. SUBTITLE | Changing of the SUBTITLE language on multi-subtitle language DVD disc |
| 5. AUDIO | Changing of the AUDIO soundtrack on multi-audio soundtrack DVD disc. Changing of the sound mode of the VCD/CD disc |
| 6. ZOOM | Press it to zoom the picture in scale x1.5,x2.0,x3.0 |
| 7. TITLE | Display the TITLE menu that is stored in DVD disc changing between PBC ON and PBC OFF on the VCD disc |
| 8. ◀▶ | Press ▶▶ to start forward rapidly & ◀◀ to reverse rapidly |
| 9. ▲ / ▼ / ▶ / ◀ | Cursor buttons in MENU mode. |
| 10. SETUP | Display the SETUP menu |
| 11. ■ | Press it to stop playback |
| 12. ⏸ | Press once to pause a play, press again to resume playback. |
| 13. MENU | Press MENU to display the root menu of the DVD disc. |
| 14. MUTE | Press it to eliminate the sound immediately |
| 15. SLOW | Changing for slow forward/reverse playback motion |
| 16. ANGLE | Changing of the view angle on multi-angle DVD disc |
| 17. A-B | Press it to repeat between two selected spots on DVD or VCD disc |
| 18. REPEAT | Switch the Repeat mode of DVD/VCD/CD disc |
| 19. ◀▶ | Press ▶▶ to skip to the next track & press ◀◀ to skip back one track |
| 20. ENTER | Confirm the Track/Chapter selected with the number key or selected with the cursor buttons on TV screen |
| 21. 0 - 9 | Numeric buttons |
| 22. +10 | Press it to select 10th digits |

REMOTE CONTROL

Preparing the Remote Control

Inserting the Batteries

1. Open the battery compartment cover.
2. Insert the new batteries. Make sure that the positive and negative terminals of the batteries are oriented indicated.
3. Close the cover

Using the Remote Control

Face the remote control towards the player front face IR mark (remote control signal receiver).

Operation angle: About ± 30 degree in each the direction of the front of the IR mark.

To prevent damage to the unit, be sure to follow the connection diagram (page 8).

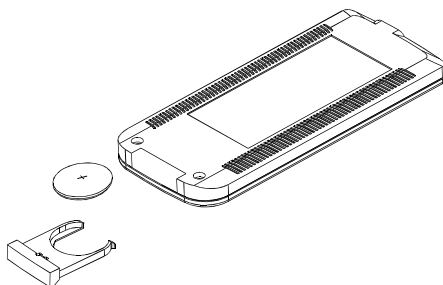

BASIC OPERATION

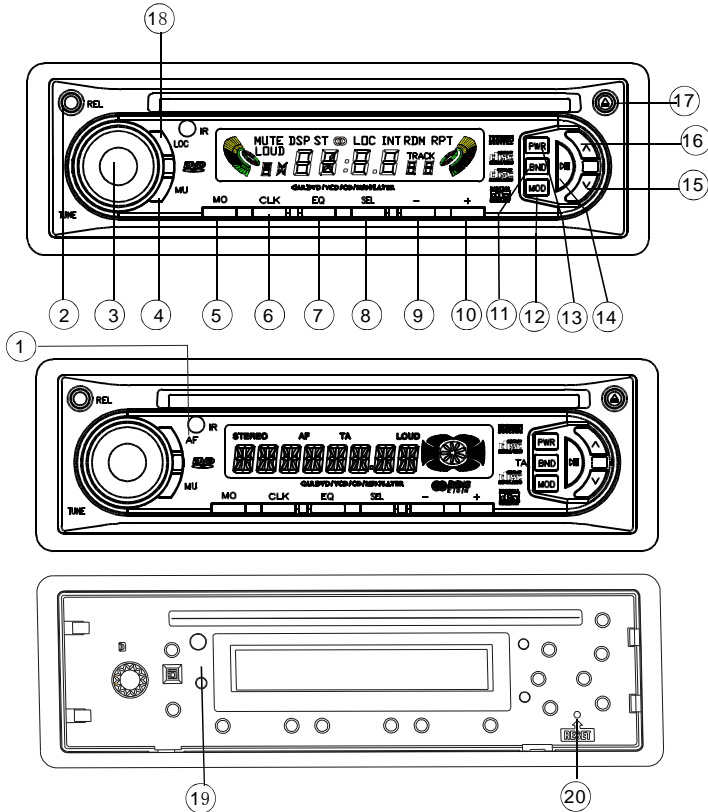

ON/OFF

Press POWER button (13) to turn on the unit. Press it again to turn off.

FACEPLATE RELEASE

Press REL button (2) to detach the removable faceplate.

SET THE CLOCK

Press CLK button (6) to change the display to clock display. Press it again to return to previous display. In clock display, press and hold the CLK button (6) for several seconds until the clock display flashes. Press VOL - (9) to change minutes or VOL+ (10) to change hours.

SELECT MODE

Press SEL button (8) to change audio mode through volume, bass, treble, balance, and fader modes. Use VOL + (10) and VOL - (9) buttons to adjust the selected mode

When mode has not been adjusted for several seconds, display returns to normal radio or CD display.

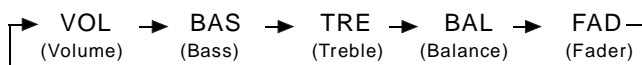

BASIC OPERATION

Volume

Adjust volume level by using VOL+ (10) and VOL- (9) buttons.

Note: The unit is initially set to volume mode.

Bass

Press SEL button (8) one time. Adjust bass level by using VOL+(10) and VOL-(9) buttons.

Treble

Press SEL button (8) two times. Adjust treble level by using VOL+(10) and VOL-(9) buttons.

Balance

Press SEL button (8) three times. Adjust sound balance between left and right speakers by using VOL+(10) and VOL-(9) buttons.

Fader

Press SEL button (8) four times. Adjust sound balance between front and rear speakers by using VOL+(10) and VOL-(9) buttons.

MUTE

Press MU button (4) to mute down sound. Press it again to release this mode and recover previous volume level.

SELECT MODE

Press MOD button (12) to change between radio or disc mode.

EQUALIZATION

Press EQ button (7) to turn to equalization function and to select desired audio mode.

There are four kinds of mode as below:

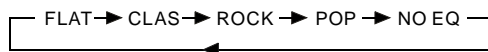

LIQUID CRYSTAL DISPLAY

The LCD can show the current state of the unit

SKIP TRACKS

Press \wedge button(16) or \vee button(15)to the previous track or the following track . Track number shows on the display.

BASIC OPERATION

FLASHING LED

If the front panel is not on the main unit, LED (19) will be flashing.

RESET BUTTON FUNCTION

RESET button (20) is placed on the housing and must be activated with either a ballpoint pen or thin metal object. The RESET button is to be activated for the following reasons:

- Initial installation of the unit when all wiring is completed.
- All the function buttons do not operate.
- Error symbol on the display.

Note: If press RESET button, the unit can't work yet, please use a cotton swab soaked in isopropyl alcohol to clean the socket on the back of the front panel.

RADIO OPERATION

BAND

Press BND button (11) to change bands as below:

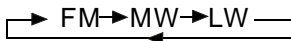

For 3 Bands (Europe)



For 2 Bands (Europe)



For 2 Bands (USA)

SELECT STATION

Rotate TUNING knob (3) clockwise or anticlockwise to adjust the frequency upward or downward.

AF

AF button (1)[ALTERNATIVE FREQUENCIES](FOR RDS ONLY)

1. By pushing short.

1) RADIO mode

changed the mode to CDP mode.

2). CDP mode

changed the PLAY mode to PAUSE mode and vice versa.

2. By pushing long.

It is engaging whether "AF SEARCH" mode ON or OFF.

If "AF SEARCH" mode is turned on, the 1'st AF is displayed on the LCD. All the AF list can be shown by pressing "DISPLAY" key during "AF SEARCH ON" mode.

When AF is shown, the display mode changes to the frequency if the user changes the frequency. RDS signal is NOT received during AF search mode.

This mode is released after few seconds. But, this mode is NOT released during changing the tuned frequency to search AF.

LOCAL/DISTANT

Press the LOC button (18) to select between local setting for reception of strong station and distant setting for reception of weak stations when tuning.

MONO/STEREO

In FM band, press MON button (5) to select mono or stereo reception for radio stations. You can sometimes improve reception of distant stations by selecting mono operation.

TA

TA function [TRAFFIC ANNOUNCEMENT] BUTTON(FOR RDS ONLY)

When pressed short

1). RADIO mode

Depending on the installed option diode matrix,

LW/MW/FM band is toggled cyclically through the tuning bands.

-> FM -> MW -> LW (for 3 bands Europe) or

BASIC OPERATION

-> FM -> MW -> (for 2 bands Europe) or
-> FM -> AM -> (for 2 bands USA) or

Refer to the explanation of diode matrix.

2). CDP mode

changed the mode to Radio mode.

When pressed long, it is engaging whether TA mode on or off.

When TA mode is on and a traffic announcement is transmitted:

TA(INFO) - When the unit was in CDP mode, it will switch temporarily to radio mode.

- If the volume level was under the threshold point it will be raised to the threshold point.

But the user changed the volume level which was more than the threshold point (min .TA volume level), it will be set to the last level.

When TA mode is on,TA of individual segment is turned on.

- When a TP station is received,TP of individual segment is turned on.

The current traffic announcement is canceled by pressing this key.But the TA mode will not be off.

DISC OPERATION

Most of the disc operations are controlled by the remote controller.

Ejecting a Disc

Press (EJECT) \blacktriangle button (17) on the front panel or ON the remote control to eject the disc.

Stopping Play

-Brief press the \blacksquare (Stop) button to stop the unit playback, when press the $\blacktriangleright\blacksquare$ (14) button it can continuous normal playback.

-Press \blacksquare (Stop) button twice, it will stop the playback and go back to initial Track/Chapter.

Rapid Forward/Rapid Reverse

Press $\blacktriangleright\blacktriangleright$ F.FWD& $\blacktriangleleft\blacktriangleleft$ F.BWD during play.

Each time the button is pressed, the speed of rapid forward/reverse changes according to the disc as follow.

DVD:

VCD/CD:

Mp3:

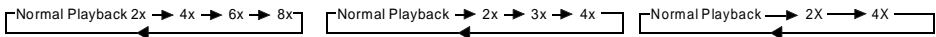

Skipping Track

Press $\blacktriangleleft\blacktriangleleft$ / $\blacktriangleright\blacktriangleright$ on the remote handset or \blackwedge / \blacktriangledown on the front panel during playback to skip to next track or back one track.

Note: For some VCD 2.0 discs(PBC-playback control), $\blacktriangleleft\blacktriangleleft$ and $\blacktriangleright\blacktriangleright$ buttons may be unavailable.

Slow Motion Play

Press slow button during playback.Each time the button is pressed, the slow modes are changes according to the disc as follow.

DVD:

VCD:

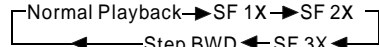
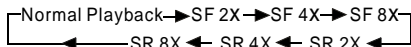

Note: For VCD, in any slow mode, press ENTER button to return to normal playback.

BASIC OPERATION

Pause (still picture)

Pressing **▶||** during playback will stop play temporary. Return to normal playback, press **▶||** once again.

Repeat

Press the REPEAT button to select repeat mode as follow.

DVD:

Press the REPEAT button to select repeat mode as follow.

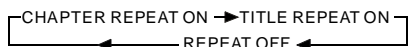

VCD/CD:

Press the REPEAT button to select repeat mode as follow.

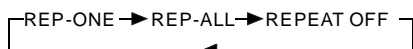

1.Continuously repeat at the current chapter/track, when selected REP-ONE mode.

2.Select REP-ALL mode to continuously repeat all chapter/track on the current disc.

3.When the player finish playback the current discc last chapter/track, it will stop display the elapsed time.

When selected REPEAT OFF mode (REP-ONE & REP-ALL disappear at the screen display).

4.REPEAT feature does not support VCD2.0 (with PBC ON).

Remote Sensor (IR)

Point the remote handset to the remote sensor. Receive the signal from remote handset.

On-Screen Display Function

Press the DISPLAY button during playback to display the contents of the current disc on the screen.

Example:

DVD:

(1) Press DISPLAY for the first time:

```
TITLE 01/03 CHAPTER 002/025 P: 00:00:25
TITLE ELAPSED
```

Title Number, Total Title Number, Chapter Number, Total Chapter Number of this Title of the disc currently being played will be shown on the screen, along with the elapsed time.

(2) Press DISPLAY for the second time:

```
TITLE 01/03 CHAPTER 002/025 P: 00:00:25
TITLE REMAIN
```

(3) Press DISPLAY for the third time:

```
TITLE 01/03 CHAPTER 002/025 P: 00:00:25
CHAPTER ELAPSED
```

(4) Press DISPLAY for the fourth time:

```
TITLE 01/03 CHAPTER 002/025 P: 00:00:25
CHAPTER REMAIN
```

(5) Press DISPLAY for the fifth time:
The message on the screen will be cleared.

Video CD/SVCD/CD:

(1) Press DISPLAY for the first time:

```
T:01/18 P: 00:00:25 LR DISC
SINGLE ELAPSED
```

BASIC OPERATION

(2) Press DISPLAY for the second time:

T:01/18 P: 00:00:25 LR DISC
SINGLE REMAIN

(3) Press DISPLAY for the third time:

T:01/18 P: 00:00:25 LR DISC
TOTAL ELAPSED

(4) Press DISPLAY for the fourth time:

T:01/18 P: 00:00:25 LR DISC
TOTAL REMAIN

(5) Press DISPLAY for the fifth time:

The message on the screen will be cleared for SVCD and VCD. Note: For CD and Mp3, the message will always display on the screen.

MP3:

Each time DISPLAY is pressed, the message displayed on screen changes as follows:

SINGLE ELAPSED → SIGGLE REMAIN

Multi-audio Language Function

DVD:

Press AUDIO during playback.

Each time the button is pressed, number of the audio soundtrack language changes on sequential order.

Notes:

- The language number is different according to the disc.
- Some disc only contain one language soundtrack.
- When no different language soundtrack are recorded, will be display at screen left top corner.

VCD:

Press AUDIO during playback.

It is possible to switch the sound between monaural and stereo sound.

LEFT VOCAL → RIGHT VOCAL → MONO LEFT
← STEREO ← MONO RIGHT ←

CD:

Press AUDIO during playback.

It is possible to switch the sound between monaural and stereo sound.

MONO LEFT → MONO RIGHT → STEREO
←

TITLE Menu Function

DVD:

If the DVD has multiple titles recorded on the disc. It can select preferred title from the title menu to start playback.

1. Press TITLE during playback.

The title menu is display.

2. Press the cursor button shown in TV screen, select preferred title by the cursor button and confirmed by ENTER key.

VCD:

Press MENU button while the disc is playing, you can switch between "PBC on" and "PBC off" mode.

Multi-subtitle Language Function

(For DVD only)

Press SUBTITLE during playback.

Each time the button is pressed, number of the subtitle language changes in sequential order.

Notes:

- The language number is different according to the disc.
- Some discs only contain one subtitle language.
- When no different subtitle language are recorded, will be displayed at screen left top corner.

BASIC OPERATION

Multi-angle Function

(For DVD only)

Press ANGLE during playback.

Each time the button is pressed, number of the angle changes in sequential order.

Notes:

-The angle number is different according to the disc.

-The function only work for discs having scenes recorded at different angles.

-When no different angle are recorded,

 will be displayed at screen left top corner.

MP3 Disc Play

MP3 disc is playing as the format of FOLDER by FOLDER.

For example:

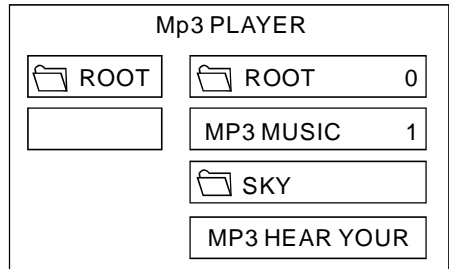

Use ▲/▼/▶/◀ to select the item or folder, then press ENTER button.

Pressing REPEAT button repeatedly can select three kinds of repeat play mode.

REP-ONE:

Play the same song over and over again.

FOLDER REPEAT:

Play all songs in the current directory in sequence, over and over again.

DISC REPEAT:

Play all songs in the disc over and over again.

In the playback, use ◀◀ or ▶▶ to skip an item ahead or back.

◀◀: Rapid reverse, ▶▶: Rapid advance

Note: The FOLDER cannot be selected during playing. It can be selected after

■ (Stop) button pressed.

SETUP

INITIAL SETUP

SETUP MENU --- MAIN PAGE---

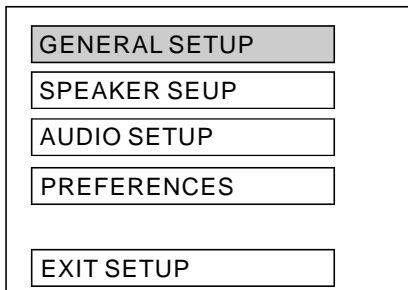

1. Press SETUP in the stop mode.
(Press the stop button twice to ensure the player under STOP mode.)

2. The initial SETUP menu is displayed.

3. Select the preferred item by using the ▲/▼ buttons.

4. Press ENTER buttons.

a. GENERAL SETUP

This setup page includes all the item of TV display & audio output feature. The detail please refer to GENERAL SETUP MENU.

b. SPEAKER SETUP

This is to activate the audio output from DOLBY AC3 5.1 DOWNMIX to 2 channel mode. Please refer to SPEAKER SETUP MENU.

c. AUDIO SETUP

This setup page includes all the items for AUDIO. Please refer to AUDIO SETUP MENU.

d. PREFERENCE SETUP

This setup page includes all the configuration of support feature. The detail please refer to PREFERENCES SETUP MENU.

GENERAL SETUP

--- GENERAL PAGE ---

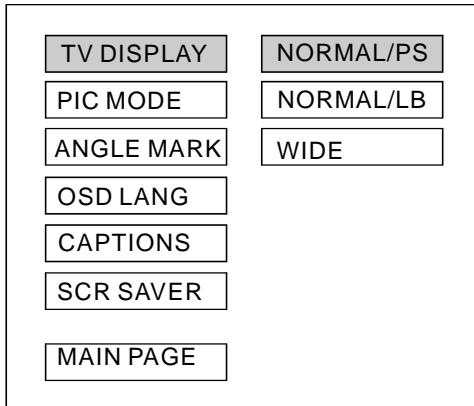

Video Material	TV Screen			
	Normal	Pan Scan	Letter-box	Wide(16:9)
4:3				

TV display setup

This is to select the appropriate TV aspect (4:3 or 16:9) according to the connected TV set.

Normal/PS (For 4:3 TV)

Played back in the PAN & SCAN style.
(If connected to wide-screen TV, the left and right edges are cut off.)

Normal/LB (For 4:3 TV)

Played back in letterbox style.
(If connected to wide-screen TV, black bands appear at top and bottom of the screen.)

Wide (For 16:9 TV)

Select when a wide-screen TV set is connected.

SETUP

--- GENERAL PAGE ---

TV DISPLAY	
PIC MODE	AUTO
ANGLE MARK	HI-RES
OSD LANG	N-FLICKER
CAPTIONS	
SCR SAVER	
MAIN PAGE	

PIC mode setup

Select AUTO, the player PIC mode will depend on DVD disc.

Select HI-RES format for best image resolution.

Select N-FLICKER format on format on image or picture under noise affect.

--- GENERAL PAGE ---

TV DISPLAY	
PIC MODE	
ANGLE MARK	
OSD LANG	ENGLISH
CAPTIONS	
SCR SAVER	
MAIN PAGE	

OSD LANG type setup

Select the preferred OSD language by using the ▲/▼ buttons.

--- GENERAL PAGE ---

TV DISPLAY	
PIC MODE	
ANGLE MARK	ON
OSD LANG	OFF
CAPTIONS	
SCR SAVER	
MAIN PAGE	

ANGLE MARK display setup

If it is set to ON, when the multi-angle DVD disc is playing, 𐄀 (the angle mark) will appear on the screen; if is set to OFF, the mark will not appear.

--- GENERAL PAGE

TV DISPLAY	
PIC MODE	
ANGLE MARK	
OSD LANG	
CAPTIONS	ON
SCR SAVER	OFF
MAIN PAGE	

CAPTIONS setup

Activate the CAPTIONS feature by selecting ON. And release this feature by selecting OFF.

SETUP

--- GENERAL PAGE ---

TV DISPLAY	
PIC MODE	
ANGLE MARK	
OSD LANG	
CAPTIONS	
SCR SAVER	ON
	OFF
MAIN PAGE	

SCR SAVER setup

Select the SCR SAVER output ON/OFF.

SPEAKER SETUP

--- SPEAKER SETUP PAGE ---

DOWNMIX	LT/RT
	STEREO
MAIN PAGE	

This is to activate the audio output from DOLBY AC3 5.1 DOWNMIX to 2 channel mode. Select the preferred SPEAKER connection by using the cursor buttons. Select the LT/RT to activate the Dolby surround compatible output. Select the STEREO to activate simple stereo mode.

AUDIO SETUP

--- AUDIO SETUP ---

AUDIO OUT	ANALOG
OP MODE	SPDIF/RAW
LPCM OUTPUT	SPDIF/PCM
DYNAMIC	
MAIN PAGE	

AUDIO OUT

This is to activate the audio output from ANALOG mode to SPDIF/RAW mode to SPDIF/PCM mode.

--- AUDIO SETUP ---

AUDIO OUT	
OP MODE	LINE MODE
LPCM OUTPUT	RF REMOD
DYNAMIC	
MAIN PAGE	

OP MODE

There are two operating modes for the Dolby Digital decoder: LINE OUT and RF REMOD.

SETUP

--- AUDIO SETUP ---

AUDIO OUT	
OP MODE	
LPCM OUTPUT	LPCM 48K
DYNAMIC	LPCM 96K
MAIN PAGE	

LPCM OUTPUT

Select the LPCM OUTPUT between LPCM 48K and LPCM 96K.

--- AUDIO SETUP ---

AUDIO OUT	
OP MODE	
LPCM OUTPUT	
DYNAMIC	
MAIN PAGE	

FULL
6/8
4/8
2/8
OFF

Dynamic Range Control

Select DRC and adjust the dynamic range of a Dobby Digital encoded program. There are 8 steps between full compression and off compression.

PREFERENCES SETUP

--- PREFERENCES PAGE ---

TV TYPE	MULTI
AUDIO	NTSC
SUBTITLE	PAL
DISC MENU	
PARENTAL	
PASSWORD	
DEFAULTS	
MP3 PLAY	
MAIN PAGE	

TV type setup

This player can play discs recorded in either PAL or NTSC format.

Select NTSC format, when you connected to NTSC TV.

Select PAL format, when you connected to PAL TV.

Select AUTO format, the player TV output format will according to the DVD disc format.

--- PREFERENCES PAGE ---

TV TYPE	
AUDIO	ENGLISH
SUBTITLE	FRENCH
DISC MENU	SPANISH
PARENTAL	CHINESE
PASSWORD	JAPANESE
DEFAULTS	
MP3 PLAY	
MAIN PAGE	

AUDIO language setup

Select the preferred AUDIO soundtrack by using the cursor buttons.

SETUP

--- PREFERENCES PAGE ---

TV TYPE	
AUDIO	
SUBTITLE	ENGLISH
DISC MENU	FRENCH
PARENTAL	SPANISH
PASSWORD	CHINESE
DEFAULTS	JAPANESE
MP3 PLAY	OFF
MAIN PAGE	

SUBTITLE language setup

Select the preferred SUBTITLE language by using the cursor buttons.

--- PREFERENCES PAGE ---

TV TYPE	1G
AUDIO	2
SUBTITLE	3PG
DISC MENU	4PG13
PARENTAL	5
PASSWORD	6PG-R
DEFAULTS	7NC-17
MP3 PLAY	8 ADULT
MAIN PAGE	NO PARENTAL

PARENTAL

Select suitable parental guidance by the cursor buttons and conformed by pressing ENTER button.

--- PREFERENCES PAGE---

TV TYPE	
AUDIO	
SUBTITLE	
DISC MENU	ENGLISH
PARENTAL	FRENCH
PASSWORD	SPANISH
DEFAULTS	CHINESE
MP3 PLAY	JAPANESE
MAIN PAGE	

DISC MENU language setup

Select the preferred DISC MENU language by using the cursor buttons.

--- PREFERENCES PAGE ---

TV TYPE	
AUDIO	
SUBTITLE	
DISC MENU	
PARENTAL	
PASSWORD	CHANGE
DEFAULTS	
MP3 PLAY	
MAIN PAGE	

PASSWORD

Select the change and press ENTER button. Type the old password (The initial factory code is **3308**) and key in 4 characters password now you want to use, and retype again to confirm key in correctly.

SETUP

--- PREFERENCES PAGE ---

TV TYPE	
AUDIO	
SUBTITLE	
DISC MENU	
PARENTAL	
PASSWORD	
DEFAULTS	RESET
MP3 PLAY	
MAIN PAGE	

DEFAULTS

Select reset to become factory initial setting.

--- PREFERENCES PAGE ---

TV TYPE	
AUDIO	
SUBTITLE	
DISC MENU	
PARENTAL	
PASSWORD	
DEFAULTS	
MP3 PLAY	NO MENU
MAIN PAGE	WITH MENU

Mp3 PLAY

In this item, you can select NO MENU mode or WITH MENU mode.

DEFAULTS TABLE

General Setup	TV Display	Normal/PS
	PIC Mode	AUTO
	Angle Mark	ON
	OSD Language	English
	Captions	OFF
	SCR Saver	OFF
Speaker Setup	Downmix	Stereo
Audio Setup	Audio Out	Analog
	OP Mode	Line Out
	Dynamic	
	LPCM Out	LPCM 96K
Preferences	TV Type	AUTO
	Audio	English
	Subtitle	English
	DISC Menu	English
	Parental	NO PARENTAL
	Password	3308
	Smart NAV	With Menu

SPECIFICATIONS

Supply Voltage: 12V DC (11V-15V), test voltage 14.4V, negative ground
 Current Consumption: Less than 7 A
 Signal System: Compositive video 1.0Vp-p 75Ω
 Discs Played: (1)DVD-VIDEO Disc
 5"(12 cm) single-sided, single-layer
 5"(12 cm) single-sided, double-layer
 (2)Compact Disc (CD-DA, VIDEO CD)
 5"(12cm) disc
 Audio Output Level: 600Ω (2 ch 2.0 Vrms)

Characteristics: (1)Frequency Response 20 Hz - 20 KHz
 (2)S/N Ratio 90 dB (JIS)
 (3)Wow and Flutter Below measurable limits

	For 3 Bands (Europe)	For 2 Bands (Europe)	For 2 Bands (U.S.A.)
	FM	FM	FM
Frequency Coverage:	88 to 108 MHz	88 to 108 Mhz	88 to 108 MHz
IF:	10.7 MHz	10.7 MHz	10.7 MHz
Sensitivity (S/N = 30 dB):	15 dBu	15 dBu	15dBu

	MW	MW	AM
Frequency Coverage:	540 to 1600 KHz	540 to 1600 KHz	530 to 1710 KHz
IF:	455 KHz	455 KHz	455 KHz
Sensitivity (S/N = 20 dB):	40 dBu	40 dBu	40 dBu

	LW
Frequency Coverage:	150 to 280 KHz
IF:	455 KHz
Sensitivity (S/N = 20 dB):	45 dBu

Note:

Specifications and design are subject to modification, without notice, due to improvements in technology.

TROUBLE SHOOTING

Before going through the check list, check wiring connection. If any of the problems persist after check list has been made, consult your nearest service dealer.

Symptom	Cause	Solution
No power.	The car ignition switch is not on.	If the power supply is properly connected to the car accessory terminal, switch the ignition key to "ACC"
	The fuse is blown.	Replace the fuse.
Disc cannot be loaded or ejected.	Presence of disc inside the player.	Remove the disc in the player, Then put a new one
	Inserting the disc in reverse direction.	Insert the compact disc with the label facing upward.
	The disc is extremely dirty or defective.	Clean the disc or try to play a new one.
	Temperature inside the car is too high.	Cool off or until the ambient temperature return to normal.
	Condensation.	Leave the player off for an hour then try again.
No sound.	Volume is in minimum.	Adjust volume to a desired level.
	Wiring is not properly connected.	Check wiring connection.
Sound skips.	The installation angle is more than 30 degrees.	Adjust the installation angle less than 30 degrees.
	The disc is extremely dirty or defective disc.	Clean the compact disc, then try to play a new one.
The operation keys do not work.	The built-in microcomputer is not operating properly due to noise.	Press the RESET button. Front panel is not properly fixed into its place.
The radio does not work.	The antenna cable is not connected.	Insert the antenna cable firmly.
	The signals are too weak.	Select a station manually.

This product incorporates copyright protection technology that is protected by method claims of certain U.S. patents and other intellectual property rights owned by Macrovision Corporation and other rights owners. Use of this copyright protection technology must be authorized by Macrovision Corporation, and is intended for home and other limited viewing uses only unless otherwise authorized by Macrovision Corporation. Reverse engineering or disassembly is prohibited.

Free Manuals Download Website

<http://myh66.com>

<http://usermanuals.us>

<http://www.somanuals.com>

<http://www.4manuals.cc>

<http://www.manual-lib.com>

<http://www.404manual.com>

<http://www.luxmanual.com>

<http://aubethermostatmanual.com>

Golf course search by state

<http://golfingnear.com>

Email search by domain

<http://emailbydomain.com>

Auto manuals search

<http://auto.somanuals.com>

TV manuals search

<http://tv.somanuals.com>