



Leica GPS1200+

User Manual

Version 7.0
English

- when it has to be **right**

Leica
Geosystems

Download from [Www.Somanuals.com](http://www.somanuals.com). All Manuals Search And Download.

Introduction

Purchase

Congratulations on the purchase of a GPS1200+ series instrument.



This manual contains important safety directions as well as instructions for setting up the product and operating it. Refer to "6 Safety Directions" for further information. Read carefully through the User Manual before you switch on the product.

Product identification





The type and the serial number of your product are indicated on the type plate. Enter the type and serial number in your manual and always refer to this information when you need to contact your agency or Leica Geosystems authorized service workshop.

Type: _____

Serial No.: _____

Symbols

The symbols used in this manual have the following meanings:

Type	Description
 Danger	Indicates an imminently hazardous situation which, if not avoided, will result in death or serious injury.
 Warning	Indicates a potentially hazardous situation or an unintended use which, if not avoided, could result in death or serious injury.
 Caution	Indicates a potentially hazardous situation or an unintended use which, if not avoided, may result in minor or moderate injury and/or appreciable material, financial and environmental damage.
	Important paragraphs which must be adhered to in practice as they enable the product to be used in a technically correct and efficient manner.

Trademarks

- Windows and Windows CE are a registered trademark of Microsoft Corporation
 - CompactFlash and CF are trademarks of SanDisk Corporation
 - Bluetooth is a registered trademark of Bluetooth SIG, Inc
- All other trademarks are the property of their respective owners.



Validity of this manual



- This manual applies to all GPS1200+ instruments. Differences between the various models are marked and described.
- The RX1200 is available as RX1210 or with touch screen functionality as RX1210T, RX1250X, RX1250Xc, RX1250T or RX1250Tc. The name RX1210 is used throughout the manual and may also represent the touch screen models. Only use the supplied stylus on the screens of the touch screen models.

Illustrations

For the purpose of the illustrations, a GX1230+ model has been selected which is representative for all models.

Available documentation

Name	Description	Format	
			
User Manual	All instructions required in order to operate the product to a basic level are contained in the User Manual. Provides an overview of the product together with technical data and safety directions.	x	x

Name	Description	Format	
			
System Field Manual	Describes the general working of the product in standard use. Intended as a quick reference field guide.	-	X
Applications Field Manual	Describes specific onboard application programs in standard use. Intended as a quick reference field guide. The RoadRunner application program is described in a separate manual.	X	X
Technical Reference Manual	Overall comprehensive guide to the product and program functions. Included are detailed descriptions of special software/hardware settings and software/hardware functions intended for technical specialists.	-	X

Refer to the following resources for all GPS1200+ documentation and software:

- the SmartWorx DVD
- <http://www.leica-geosystems.com/downloads>

Table of Contents

In this manual	Chapter	Page
	1 Description of the System	10
	1.1 System Components	10
	1.2 System Concept	16
	1.2.1 Software Concept	16
	1.2.2 Data Storage and Data Conversion Concept	18
	1.2.3 Power Concept	20
	1.3 Container Contents	22
	1.4 Receiver Components	24
	2 User Interface	26
	2.1 Operating Principles	26
	2.2 Icons	32

3	Operation	36
3.1	Equipment Setup	36
3.2	Battery	38
3.3	Working with the CompactFlash Card	41
3.4	Working with the Clip-On-Housings for Devices	45
3.5	Accessing Survey Application Program	55
3.6	Guidelines for Correct Results	59
3.7	Operation with a Typical Configuration Set	60
4	Reference Station	64
4.1	Overview	64
4.2	Equipment Setup	68
4.3	Getting Started with the GRX1200+ Series	73
5	Care and Transport	82
5.1	Transport	82
5.2	Storage	83
5.3	Cleaning and Drying	84

6	Safety Directions	86
6.1	General Introduction	86
6.2	Intended Use	87
6.3	Limits of Use	89
6.4	Responsibilities	90
6.5	Hazards of Use	91
6.6	Electromagnetic Compatibility EMC	101
6.7	FCC Statement, Applicable in U.S.	104
7	Technical Data	110
7.1	Receiver Technical Data	110
7.1.1	Tracking Characteristics of the Receiver	110
7.1.2	Accuracy	113
7.1.3	Technical Data	116
7.2	Antennas Technical Data	123
7.3	RX1200 Technical Data	129
7.4	Conformity to National Regulations	134
7.4.1	RX1250	134
7.4.2	Receiver	136
7.4.3	GFU24, Siemens MC75	138
7.4.4	GFU19 (US), GFU25 (CAN), GFU26 (US) CDMA MultiTech MTMMC-C	140

8 International Limited Warranty, Software License Agreement	142
Index	144

1 Description of the System

1.1 System Components

Main components

Component	Description
Receiver	To calculate a range to all visible satellites.
RX1200	To operate the user interface either by the keyboard or by the touch screen with supplied stylus.
Antenna	To receive the satellite signals from the GNSS (Global Navigation Satellite System) satellites.
LEICA Geo Office	The office software including a series of help programs which support working with GPS1200+.
LEICA GNSS Spider	The reference station software required to operate the reference station receivers of GPS1200+.

Receivers

Depending on the satellite systems and signals configured in **CONFIGURE Satellite Settings** a maximum number of 120 channels is allocated.

Receiver	Description
GX1230+ GNSS	Up to 16 L1, 16 L2, 16 L5 channels (GPS), up to 14 L1, 14 L2 channels (GLONASS), up to 14 E1, 14 E5a, 14 E5b, 14 Alt-BOC channels (Galileo), four channels SBAS, code and phase, real-time capable
GX1230+	16 L1, 16 L2 channels (GPS), four channels SBAS, code and phase, real-time capable
GX1220+ GNSS	Up to 16 L1, 16 L2, 16 L5 channels (GPS), up to 14 L1, 14 L2 channels (GLONASS), up to 14 E1, 14 E5a, 14 E5b, 14 Alt-BOC channels (Galileo), four channels SBAS, code and phase
GX1220+	16 L1, 16 L2 (GPS) channels, four channels SBAS, code and phase
GX1210+	16 L1 channels (GPS), four channels SBAS, code and phase
GX1200+ with PPS/Event option	16 L1, 16 L2 channels (GPS), code and phase, real-time capable, with event and PPS ports

Receiver	Description
GRX1200+	16 L1, 16 L2 channels (GPS), code and phase, real-time capable, with event, PPS, oscillator and NET port, for reference station applications
GRX1200+ GNSS	Up to 16 L1, 16 L2, 16 L5 channels (GPS), up to 14 L1, 14 L2 channels (GLONASS), up to 14 E1, 14 E5a, 14 E5b, 14 Alt-BOC channels (Galileo), code and phase, real-time capable, with event, PPS, oscillator and NET port, for reference station applications



Once the first operational Galileo satellites are available, a software update will be required.



The GX1230+ GNSS, GX1220+ GNSS, and GRX1200+ GNSS receivers are additionally designed to support Compass. The Compass signal definition is not fully finalized, although, test signals have been tracked in a test environment. As changes may still occur, Leica Geosystems cannot guarantee full Compass compatibility.



The GX1230+ GNSS, GX1230+, GX1220+ GNSS, GX1220+, GX1200+ with PPS/Event option and GRX1200+ Series receivers use the GPS P-code signal, which by U.S. policy is liable to be switched off without notice. Phase measurements

on L2 are ensured as these receivers automatically switch to patented tracking techniques.

**Antennas used
with receivers**

Receiver	Antenna
GX1230+ GNSS/GX1230+/ GX1220+ GNSS/GX1220+	Typically: AX1203+ GNSS, otherwise: AT504 GG/ AR25
GX1210+	AX1201
GRX1200+ Series	Typically: AT504 GG/AR25 otherwise: AX1203+ GNSS

LEICA Geo Office

- LGO supports the GPS1200+ and TPS1200+ instruments. It also supports all other Leica TPS instruments.
- LGO is based on a graphical user interface with standard Windows® operating procedures.
- LGO provides the following functionality:

Functionality	Description
Standard Functionality	Includes data exchange between computer and receiver, data management including viewing and editing, reporting, creation and management of codelists, creation and use of format files for data conversion, uploading and deleting of system software and application programs.
Extended Functionality	Includes coordinate transformations, GPS and GLONASS post processing, level data processing, network adjustment, GIS and CAD Export.

- Supported operating systems: Windows® XP, Windows® 2000.

Refer to the online help of LGO for additional information.

LEICA GNSS Spider

The reference station software is known as LEICA GNSS Spider. It is required to operate the GRX1200+ Series receivers.

Use

- to connect from a PC to a GPS1200+ receiver locally or remotely.
- to configure receiver operation.
- to monitor receiver operation.
- to automatically convert data to RINEX format.
- to automatically archive data files.
- to automatically distribute to FTP locations.
- to automatically download raw data.

Operating systems

- Windows® XP
- Windows® 2000

Refer to the online help of LEICA GNSS Spider for additional information.

1.2 System Concept

1.2.1 Software Concept

Description

All receivers use the same software concept.

Software type

Software type	Description
System software	<p>This important software covers the basic functions of the instrument. System software is also referred to as firmware.</p> <p>The programs Survey and Setup are integrated into the firmware and cannot be deleted.</p> <p>The English language is integrated into the firmware and cannot be deleted.</p>
Language software	<p>Numerous languages are available for the receivers. Language software is also referred to as system language.</p> <p>The system software enables a maximum of three languages which can be stored at any one time - the English language and two other languages. The English language is the default language and cannot be deleted. One language is chosen as the active language.</p>

Software type	Description
Application programs	A suite of optional survey-specific application programs are available for the instrument. Some of the programs are activated freely and require no license key and others require purchasing and are only activated with a license key.
Customised application programs	Custom software specific to user requirements can be developed using the GeoC++ development kit. Information on the GeoC++ development environment is available on request from a Leica Geosystems representative.
RX1200 software	For RX1210 and RX1210T. This software covers display, sound and communication settings of the RX1210 and RX1210T.

Software upload

All instrument software is stored in the System RAM of the receiver. The software can be uploaded onto the receiver using the following methods:

- Using LGO the software is transferred via the serial interface to the Compact-Flash card in the receiver, which is then stored to the System RAM.
- By connecting the CompactFlash card directly to the computer either via an internal card slot housing or an external OMNI drive, the software is transferred to the card, which is then stored to the System RAM.

1.2.2 Data Storage and Data Conversion Concept

Description

Data is stored within a job in a database on a memory device. This is either a CompactFlash card or an internal memory.

Memory device

CompactFlash card:

A CompactFlash card slot is standard. A CompactFlash card can be inserted and removed. Various capacities are available.



Whilst other CompactFlash cards may be used, Leica recommends to only use Leica CompactFlash cards and is not responsible for data loss or any other error that may occur whilst using a non-Leica card.

Internal memory:

An internal memory is optional. It resides inside the receiver. Available capacity: 256 MB or 1 GB



Unplugging connecting cables or removing the CompactFlash card during the measurement may cause loss of data. Always return to **GPS1200+ Main Menu** before removing the CompactFlash card and switch off the instrument before removing cables.



For GRX1200+ Series receivers:

While in remote operation mode, stop point occupation and ring buffer logging before removing the CompactFlash card.

Data conversion

Export

Data can be exported from a job in a wide range of ASCII formats. The export format is defined in Format Manager which is a PC tool in LEICA Geo Office. Refer to the online help of LGO for information on creating format files.

Data can also be exported from a job in DXF or LandXML format.

Import

Data can be imported from ASCII, DXF, GSI8 or GSI16 format.

Transfer raw data to LGO

Raw data can be transferred between the database on the CompactFlash card or the internal memory of the receiver and LGO in two ways:

- From the CompactFlash card or the internal memory directly through a serial interface to a project in LGO on a PC.
 - From the CompactFlash card using for example an OMNI drive as supplied by Leica Geosystems to a project in LGO on a PC.
-



CompactFlash cards can directly be used in an OMNI drive as supplied by Leica Geosystems. Other PC card drives may require an adaptor.

1.2.3 Power Concept

General

Use the Leica Geosystems batteries, chargers and accessories or accessories recommended by Leica Geosystems to ensure the correct functionality of the instrument.

Power options**Receiver**

Power for the receiver can be supplied either internally or externally. Up to two external power supplies can be connected using a Y-cable. For the GRX1200+ Series one of the two external power supplies can be configured to be the primary which is always used when available.

Internal power supply: Two GEB221 batteries fit into the receiver.

External power supply: GEB171 battery connected via a cable.

OR

Car battery connected via a converter cable supplied by Leica Geosystems.

OR

10.5-28 V DC power supply via a converter cable supplied by Leica Geosystems.

OR

110/240 V AC to 12 V DC power supply unit, supplied by Leica Geosystems.



For permanent operations use **Uninterruptible Power Supply** units as a back-up in case of a main power failure.

1.3 Container Contents

**Container for
GX1200+ receivers
and delivered
accessories
part 1 of 2**

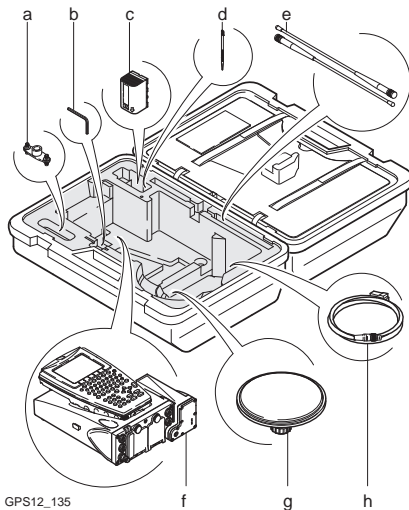

GPS12_135

- a) Double arm for antennas of devices
- b) Allen key
- c) GEB221 internal battery
- d) Supplied stylus
- e) Antennas of device
- f) GX1200+ with RX1210 and device such as radio
- g) Antenna and GAD31 adapter
- h) Cables

**Container for
GX1200+ receivers
and delivered
accessories
part 2 of 2**

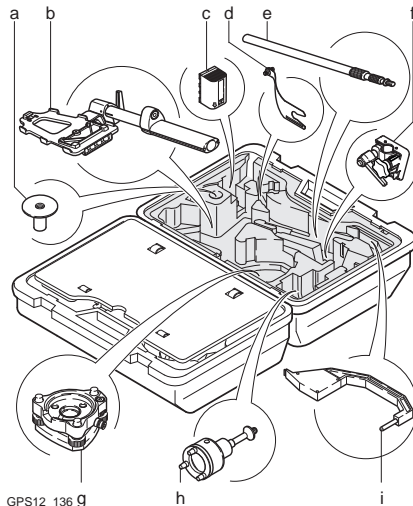

- a) Base for telescopic rod
- b) GHT39 holder for RX1210 on pole with grip for pole
- c) GEB221 internal battery
- d) GAD33 arm 15 cm
- e) Telescopic rod
- f) Holder for GX1200+ on pole
- g) Tribrach
- h) Carrier
- i) Height hook

1.4 Receiver Components

Receiver components

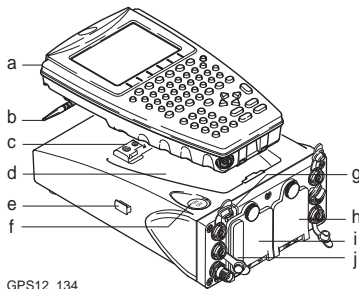

GPS12_134

- a) RX1200
- b) Supplied stylus
- c) Clip-on-contacts for connecting RX1200 without cable
- d) Recess for RX1200
- e) Guide rail for clip-on-housing of a device
- f) ON/OFF button
- g) LED indicators
- h) Battery compartment 2 or port NET
- i) Battery compartment 1
- j) CompactFlash card compartment

ON/OFF button

The receiver can be preprogrammed in the office and used in the field without the RX1200 attached. In this case, the receiver is turned on by holding down the ON/OFF button for 2 s or off by holding down the ON/OFF button for 4 s. A green steady light at the power LED indicates that the receiver is turned on.

2 User Interface

2.1 Operating Principles

Keyboard and touch screen

The user interface is operated either by the keyboard or by the touch screen with supplied stylus. The workflow is the same for keyboard and touch screen. The difference is the way information is selected and entered.

Turn instrument on

Press **PROG**.

Turn instrument off

The instrument can only be turned off in the **GPS1200+ Main Menu** screen.

Press both **USER** and **PROG** simultaneously.

OR

Hold **ESC** for 2 s.

Lock/Unlock keyboard

Option	Description
Lock	To lock the keyboard press and hold SHIFT for 3 s. The message 'Keyboard locked' is momentarily displayed on the Message Line.

Option	Description
Unlock	To unlock the keyboard press and hold SHIFT for 3 s. The message 'Keyboard unlocked' is momentarily displayed on the Message Line.

**Switching between
Leica SmartWorx
software and
Windows CE
desktop**

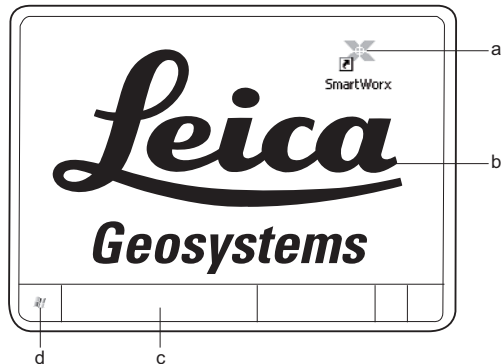

This is valid for RX1250.



RX12_33

- a) Icon to start Leica SmartWorx software
- b) Windows CE desktop
- c) Task bar
- d) Start button

Access Leica SmartWorx software

IF	THEN
RX1250 is started	the Leica SmartWorx software comes up automatically.
Windows CE desktop is active	double click  to display the Leica SmartWorx software. OR SHIFT PROG () to display the Leica SmartWorx software.
Leica SmartWorx software is mini-mised	double click  to maximise it. OR select SmartWorx in the task bar to maximise it.

Access Windows CE desktop

IF	THEN
Leica SmartWorx software is to be minimised	SHIFT MINIM (F5) in Main Menu .
Leica SmartWorx software is to be closed	SHIFT EXIT (F6) in Main Menu .
Windows CE task bar is to be displayed	SHIFT PROG ()

Selecting from a menu

Appearance	Description
 <p>The screenshot shows the top of the GPS1200 interface. At the top, it displays '17:28' and 'GPS1200'. Below that is a 'Management' menu with three options: '1 Jobs' (highlighted in black), '2 Data', and '3 Code lists'. To the right of the menu are several icons and labels: a crosshair, a '7' with a small icon, and 'L1= 6' and 'L2= 6'.</p>	<p>To select an item from a menu, do one of the following:</p> <ul style="list-style-type: none">Move the focus to the item. ENTER or CONT (F1) <p>OR</p> <ul style="list-style-type: none">Type the complete selection number in front of the item. ENTER or CONT (F1) are not required. <p>OR</p> <ul style="list-style-type: none">Tap on the item.

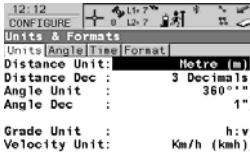

Selecting a page

Appearance	Description
 <p>The screenshot shows the 'CONFIGURE' screen. At the top, it displays '12:12' and 'CONFIGURE'. Below that is a 'Units & Formats' menu with four options: 'Units', 'Angle', 'Time', and 'Format'. The 'Format' option is highlighted in black. Below the menu are several settings: 'Distance Unit: Metro (m)', 'Distance Dec: 3 Decimals', 'Angle Unit: 360°', 'Angle Dec: 1"', 'Grade Unit: h:v', and 'Velocity Unit: Km/h (kmh)'.</p>	<p>To select a page in a screen, do one of the following:</p> <ul style="list-style-type: none">PAGE (F6). <p>OR</p> <ul style="list-style-type: none">Tap on the page tab.

Appearance and selection from a choicelist

Choicelists have various appearances.

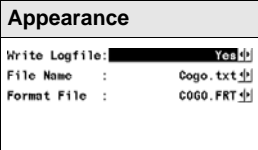
Closed choicelist



Appearance	Description	Selection
	Triangles on the right indicate further available choices.	Use the arrow keys   to toggle through the list or tap the triangles on the screen.

ENTER or tap on the field to access the choicelist. Opening a choicelist reveals either a simple listbox or a comprehensive listbox dialogue.

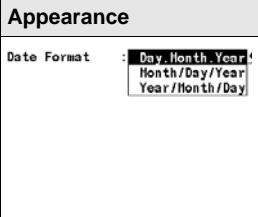
Simple listbox

Appearance	Description	Selection
	<ul style="list-style-type: none"> • Choicelist shows items to select. • A search field is shown if necessary • A scroll bar is shown if necessary. 	<ul style="list-style-type: none"> • Highlight an item and ENTER. • To exit without changes ESC or tap outside the simple listbox.

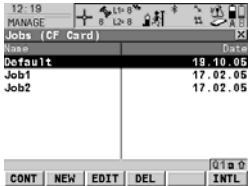
Listbox dialogue

Appearance	Description	Selection
 <p>The screenshot shows a handheld device interface. At the top, there's a status bar with '12:19' and various icons. Below that is a title bar with 'MANAGE' and 'Jobs (CF Card)'. The main area is a listbox with two columns: 'Name' and 'Date'. The list contains three items: 'Default' (highlighted), 'Job1', and 'Job2'. At the bottom, there are several buttons: 'CONT', 'NEW', 'EDIT', 'DEL', and 'INTL'.</p>	<ul style="list-style-type: none">• Choicelist fills the whole screen.• A search field is shown.• A scroll bar is shown if necessary.• The functionality comprises adding, editing and deleting of items.• Listbox dialogues are explained in detail at appropriate places in the manuals.	<ul style="list-style-type: none">• Highlight an item and CONT (F1) or ENTER.• To exit without changes press ESC or tap .

2.2 Icons

Description

Icons show the current status information of the receiver.



The icons provide information related to basic receiver functions. The icons that appear depend upon which GPS1200+ receiver is used and the current receiver configuration.

Position of the icons on the screen

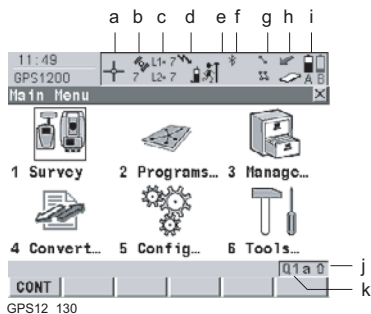

- a) Position status
- b) Number of visible satellites
- c) Contributing satellites
- d) Real-time device and real-time status, Internet online status
- e) Position mode
- f) Bluetooth
- g) Line/area
- h) CompactFlash card/internal memory
- i) Battery
- j) **SHIFT**
- k) Quick coding

Icons

Icon	Description
Position status	Displays the status of the current position. As soon as this icon becomes visible the receiver is in a stage where practical operation can commence.
Number of visible satellites	Displays the number of theoretically visible satellites above the configured cut off angle according to the current almanac.
Contributing satellites	<p>Displays the number of satellites that are contributing to the currently computed position solution.</p> <p> The number of contributing satellites can differ from the number of visible satellites. This may be either because satellites cannot be viewed or the observations to these satellites are considered to be too noisy to be used in the position solution.</p>
Real-time device and real-time status	Displays the real-time device configured to be used and its status.
Internet online status	Receiver is online in the Internet.
Position mode	Displays the current position mode depending on the configuration defined.

Icon	Description
	Symbols are added to the basic position mode icon when raw data logging or logging of auto points is configured.
Bluetooth	The status of each Bluetooth port and any Bluetooth connection is displayed.
Line/area	The number of lines and areas currently open in the active job is displayed.
CompactFlash card/internal memory	The status of the CompactFlash card and internal memory are displayed. <ul style="list-style-type: none">• For the CompactFlash card, the capacity of used space is shown in seven levels.• For the internal memory, the capacity of used memory is shown in nine levels.
Battery	The status and source of the battery is displayed. The remaining power in the battery is indicated by six levels. For GPS1200+ receivers: <ul style="list-style-type: none">• If two internal batteries are inserted, the battery with the lower voltage is used.

Icon	Description
	<ul style="list-style-type: none"> • If an external power supply is connected and one or two internal batteries are inserted, then the external power is used. • If two external power supplies are attached, then the system uses the one which is configured as the preferred power supply. <p>For RX1250:</p> <ul style="list-style-type: none"> • If an external power supply is connected and one internal battery is inserted, then the external power is used.
SHIFT	The status of the SHIFT key is displayed.
Quick coding	Shows the quick coding configuration. Can be used with touch screen to turn quick coding on and off.

3 Operation



3.1 Equipment Setup



Equipment setup step-by-step

The example given is for static operations.

Step	Description
1.	Set up the tripod.
2.	Mount and level the tribrach on the tripod.
3.	Ensure that the tribrach is over the marker.
4.	Place and lock the carrier in the tribrach.
5.	Screw the antenna onto the carrier.
6.	Check that the tribrach is still level.
7.	Insert the batteries into the receiver.
	Alternatively or in addition, to power the receiver externally, connect a GEB171 battery to the port PWR on the receiver. When using the sensor for real-time applications on construction machinery (machine automation), it is recommended to power the sensor externally.

Step	Description
8.	If no internal memory is fitted, insert a CompactFlash card into the receiver.
	A memory device must be available otherwise a survey cannot be carried out.
	Close the lid carefully after insertion of the CompactFlash card in order to prevent water and dust from getting inside the receiver.
9.	Attach the RX1200 to the receiver, if required, either directly or via a connection cable by plugging it into the port RX on the receiver.
10.	Connect the receiver to the antenna using the antenna cable and port ANT on the receiver.
11.	To hang the receiver on the tripod leg, use the hook on the rear of the unit.
	Alternatively place the receiver in the transport container.
12.	Insert the height hook into the carrier.
13.	Measure the antenna height using the height hook.
14.	Press the ON/OFF button on the receiver for at least 2 s or PROG on the RX1200 to switch the receiver on.
15.	The receiver is now ready for operation.

3.2 Battery



Primary use/charging

- The battery must be charged prior to using it for the first time because it is delivered with an energy content as low as possible.
- For new batteries or batteries that have been stored for a long time (> three months), it is effectual to make only one charge/discharge cycle.
- For Li-Ion batteries, a single discharging and charging cycle is sufficient. We recommend carrying out the process when the battery capacity indicated on the charger or on a Leica Geosystems product deviates significantly from the actual battery capacity available.
- The permissible temperature range for charging is between 0°C to +40°C/ +32°F to +104°F. For optimal charging we recommend charging the batteries at a low ambient temperature of +10°C to +20°C/+50°F to +68°F if possible.
- It is normal for the battery to become warm during charging. Using the chargers recommended by Leica Geosystems, it is not possible to charge the battery if the temperature is too high.

Operation/Discharging

- The batteries can be operated from -20°C to $+55^{\circ}\text{C}$ / -4°F to $+131^{\circ}\text{F}$.
- Low operating temperatures reduce the capacity that can be drawn; very high operating temperatures reduce the service life of the battery.

Change battery step-by-step

The batteries are inserted in the front of the receiver.

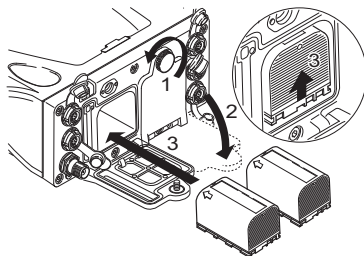

GPS12_085

Step	Description
1.	Loosen the screw of one of the battery compartments.
2.	Open the cover of the battery compartment.

Step	Description
3.	With the Leica logo facing upwards, slide the battery into the battery compartment and push upwards so that it locks into position.
4.	Close the cover of the battery compartment and tighten the screw.
5.	Repeat steps 2. to 4. for the second battery compartment.
6.	To remove a battery, loosen the screw to open the cover of the battery compartment.
7.	Push the battery slightly in and at the same time downwards. This releases the battery from its fixed position.
8.	Pull out the battery.
9.	Close the cover of the battery compartment and tighten the screw.
10.	Repeat steps 6. to 9. for the second battery compartment.

3.3 Working with the CompactFlash Card



- Keep the card dry.
- Use it only within the specified temperature range.
- Do not bend the card.
- Protect the card from direct impacts.



Failure to follow these instructions could result in data loss and/or permanent damage to the card.

Insert and remove a CompactFlash card step-by-step

The CompactFlash card is inserted into a slot inside of battery compartment A on the front of the receiver.

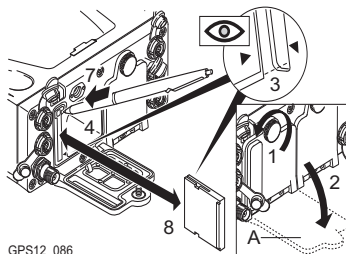



GPS12_086

A Battery compartment A

Step	Description
1.	Loosen the screw of the battery compartment A.
2.	Open the cover of battery compartment A.
3.	The card should be held such that the arrow at the card is aligned with the arrow on the receiver.
4.	Slide the card firmly into the slot until it clicks into position. To avoid damaging the card or the reader, do not use force when inserting the card.
5.	Close the compartment cover.
6.	To remove the card, open the cover of battery compartment A.
7.	Press the eject button above the card slot.
8.	Pull out the CompactFlash card.
9.	Close the compartment cover.

Format a Compact-Flash card step-by-step

Formatting the CompactFlash card before logging data is started is required if a completely new CompactFlash card is used or if all existing data needs to be deleted.

Step	Description
1.	Select Main Menu: Tools...\Format Memory Device.
2.	TOOLS Format Memory Device <Memory Device: CF Card> <Format Method: Format Quick> Select the memory device to be formatted.
	By activating the format command all data will be lost. Make sure that all important data on the CompactFlash card has been backed up before formatting the card. Before formatting the internal memory make sure that all important data is first transferred to the PC.
	To exit the screen without formatting the memory device, press ESC . This returns to the previous screen.
3.	CONT (F1)
4.	YES (F4) to continue with the formatting of the selected device.

Step	Description
	NO (F6) to not continue with the formatting of the selected device and to return to TOOLS Format Memory Device .
5.	Once the formatting of the card is completed the system returns to GPS1200+ Main Menu .

3.4 Working with the Clip-On-Housings for Devices

Devices fitting into a clip-on-housing

Digital cellular phones fitting into a clip-on-housing

Digital cellular phone	Clip-on-housing
Siemens MC75	GFU24
CDMA MultiTech MTMMC-C (US)	GFU19, GFU26
CDMA MultiTech MTMMC-C (CAN)	GFU25

Radios fitting into a clip-on-housing

Radio	Clip-on-housing
Pacific Crest PDL, receive	GFU15
Satellite 3AS, transceive	GFU14

Attach a clip-on-housing step-by-step

The clip-on-housing for devices fits on either of the small sides of the receiver.

Step	Description
1.	Place the clip-on-housing into position such that the guide rails for the clip-on-housing on the receiver and the guide rails on the clip-on-housing are aligned.
2.	Ensure that the connector on the clip-on-housing fits to port P1 or port P3 on the receiver front panel.
3.	Slide the clip-on-housing towards the receiver front panel until the connector is completely plugged into port P1 or port P3.
4.	On the top side of the clip-on-housing, turn the screw clockwise, as shown by the symbols on the screw, to lock the clip-on-housing to the receiver.

Detach a clip-on-housing step-by-step

Step	Description
1.	On the top side of the clip-on-housing, turn the screw anticlockwise, as shown by the symbols on the screw, to unlock the clip-on-housing from the receiver.
2.	Slide the clip-on-housing away from the receiver front panel until the connector is completely unplugged from port P1 or port P3.

Insert a SIM card step-by-step

For those digital cellular phones that require SIM cards.

Step	Description
1.	Take the SIM card, a coin and a pen.
2.	Locate the SIM card screw, that covers the SIM card slot, on the bottom of the clip-on-housing.
3.	Insert the coin into the groove of the SIM card screw.
4.	Turn the coin anticlockwise to loosen the SIM card screw.
5.	Remove the SIM card screw from the housing.
6.	Using the pen, press the small button of the SIM card slot to eject the SIM card holder.
7.	Take the SIM card holder out off the housing.
8.	Put the SIM card into the SIM card holder, the chip facing up.
9.	Insert the SIM card holder into the SIM card slot, the chip facing the connectors inside the slot.
10.	Place the SIM card screw back on the housing.
11.	Insert the coin into the groove of the SIM card screw.

Step	Description
12.	Turn the coin clockwise to tighten the SIM card screw.

Remove a SIM card step-by-step

For those digital cellular phones that require SIM cards.

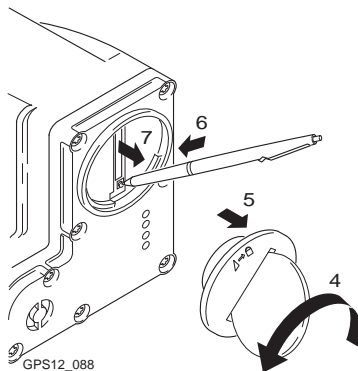

Step	Description
1.	Take a coin and a pen.
2.	Locate the SIM card screw, that covers the SIM card slot, on the bottom of the clip-on-housing.
3.	Insert the coin into the groove of the SIM card screw.

Step	Description
4.	Turn the coin anticlockwise to loosen the SIM card screw.
5.	Remove the SIM card screw from the housing.
6.	Using the pen, press the small button of the SIM card slot to eject the SIM card holder.
7.	Take the SIM card holder out off the SIM card slot.
8.	Take the SIM card out of the SIM card holder.
9.	Put the SIM card holder back into the SIM card slot, the even side not facing the contacts inside the slot.
10.	Place the SIM card screw back on the housing.
11.	Turn the coin clockwise to tighten the SIM card screw.

LED indicators

Description

Each clip-on-housing for a radio, digital cellular phones or bluetooth communication has **Light Emitting Diode** indicators on the bottom side. They indicate the basic device status.

Diagram

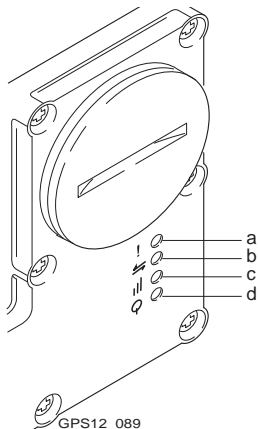

- a) Warning LED, available for Satelline 3AS
- b) Data transfer LED
- c) Signal strength LED
- d) Power LED

Description of the LED's

IF the	on	is	THEN
Warning LED	GFU14 with Satellite 3AS	red	the device is in the configuration mode controlled from the PC via cable.
Data transfer LED	any device	off	data is not being transferred.
		green or flashing green	data is being transferred.
Signal strength LED	GFU19 (US), GFU25 (CAN), GFU26 (US) with CDMA MultiTech MTMMC-C	red	device is on, not registered on the network.
		flashing red	device is on, registered on the network.
		off	download mode or device is off.

IF the	on	is	THEN
	GFU24 with Siemens MC75	red	call is in progress.
		red: long flash, long break	no SIM card inserted, no PIN entered or network search, user authentication or network login in progress.
		red: short flash, long break	logged onto network, no call in progress.
		red: flashing red, long break	GPRS PDP context activated.
		red: long flash, short break	Packet switched data transfer is in progress.
		off	device is off.
	GFU15 with Pacific Crest PDL	red or flashing red	the communication link, Data Carrier Detection , is okay on the roving receiver.
		off	the DCD is not okay.

IF the	on	is	THEN
	GFU14 with Satellite 3AS	red or flashing red	the communication link, Data Carrier Detection , is okay on the roving receiver.
		off	the DCD is not okay.
Power LED	any device	off	power is off.
		green	power is okay.

3.5 Accessing Survey Application Program

Access

Select **Main Menu: Survey**.

OR

Press **PROG**. Highlight **Survey**. **CONT (F1)**.

SURVEY

Survey Begin

11:57
SURVEY
Survey Begin
Job : Job2
Coord System : WGS 1984
Codelist : <None>
Config Set : RTK Rover
Antenna : AX1202 Polc
Q1a
CONT CONF CSYS

CONT (F1)

To accept changes and access the subsequent screen. The chosen settings become active.

CONF (F2)

Available for **<R-Time Mode: None>** and **<R-Time Mode: Rover>**. To configure auto points and hidden point measurements.

CSYS (F6)

To select a different coordinate system. Not available for **<Use Auto CrdSys: Yes>** configured in **CONFIGURE Additional Rover Settings**.

Description of fields

Field	Option	Description
<Job:>	Choicelist	The active job. All jobs from Main Menu: Manage...\Jobs can be selected.
<Coord System:>	Output	The coordinate system currently attached to the selected <Job:> . Cannot be edited for <Use AutoCrdSys: Yes> configured in CONFIGURE Additional Rover Settings .
<Codelist:>	Choicelist	No codes are stored in the selected <Job:> . All codelists from Main Menu: Manage...\Codelists can be selected.

Field	Option	Description
	Output	Codes have already been stored in the selected <Job:> . If codes had been copied from a System RAM codelist, then the name of the codelist is displayed. If codes have not been copied from a System RAM codelist but typed in manually, then the name of the active job is displayed.
<Config Set:>	Choicelist	The active configuration set. All configuration sets from Main Menu: Manage...\Configuration Sets can be selected. The receiver has numerous user configurable parameters and functions. This allows a variety of preferences to be addressed. The configuration of the parameters and functions for an individual measuring technique are combined in a configuration set.
<Antenna:>	Choicelist	The antenna currently defined to be used in the selected configuration set. All antennas from Main Menu: Manage...\Antennas can be selected.

Next step

CONT (F1) accepts the changes and accesses, depending on the selected **<Config Set:>**, **SURVEY Survey: Job Name** or **SURVEY Survey Set Up Reference Station**. Measurements can be performed with **OCUPY (F1)**, **STOP (F1)** and **STORE (F1)**.

3.6 Guidelines for Correct Results

Undisturbed satellite signal reception

Successful GNSS surveys require undisturbed satellite signal reception, especially at the receiver which serves as a reference. Set up the receivers in locations which are free of obstructions such as trees, buildings or mountains.

Steady antenna for static surveys

For static surveys, the antenna must be kept perfectly steady throughout the whole occupation of a point. Put the antenna on a tripod or pillar.

Centred and levelled antenna

Centre and level the antenna precisely over the marker.



3.7 Operation with a Typical Configuration Set



The example given is for static operations.

Static operations step-by-step

Step	Description
1.	Set up the equipment.
	Always fill out a field record sheet for each point.
	It is vital that the antenna height is measured correctly. Measure the height at the beginning and at the end of the occupation.
	The Satellite Settings of the GX1230+ GNSS accomodates three additional fields: <GLONASS:> (selection Yes or No), <Galileo:> (selection Yes or No) and <GPS L5:> (selection Yes or No).
2.	Start the Survey application program.
3.	SURVEY Survey Begin <Job: Default> <Coord System: WGS 1984> <Codelist: <None>> <Config Set:> Select a configuration set for static operations.

Step	Description
	<Antenna: AX1203+ GNSS>
4.	CONT (F1)
5.	SURVEY Survey: Job Name Type in the point ID and the antenna height.
	The position mode icon is the moving icon. This indicates that the antenna can be moved around and that no static observations are being recorded.
6.	OCUPY (F1) starts logging of static observations.
	The position mode icon changes to the static icon indicating that the receiver should remain stationary. For a static survey, the GPS antenna has to be kept totally still.
7.	If required, check information, for example on the satellites, the memory or the battery.
	SHIFT QUIT (F6) always terminates the survey operation, even during a site occupation. In this case all data collected since pressing OCUPY (F1) is lost.
8.	STOP (F1) when enough data is collected.
9.	STORE (F1) to store the point information.

Step	Description
10.	Check that the tribrach is still level and note it down in the field record sheet.
11.	Measure the antenna height and note it down in the field record sheet.
	If the tribrach is not level or the antenna height has changed, the collected data is not reliable.
12.	SHIFT QUIT (F6) to return to from where SURVEY Survey: Job Name was accessed.
13.	ESC until in GPS1200+ Main Menu .
14.	GPS1200+ Main Menu
	PROG plus USER to turn off the receiver.
15.	Take down the equipment and put it back into the transport container.
16.	Are more points to be surveyed? <ul style="list-style-type: none">• If yes, continue with step 17.• If no, continue with step 19.
17.	Move to the next point.
18.	Repeat steps 1. to 16.

Step	Description
19.	Post-process the data in the office.



The antenna must not be moved while data is logged, otherwise the quality of post-processed coordinates is impaired.



The CompactFlash card must be removed in **GPS1200+ Main Menu**. If the card is removed when in any other screen all stored data might get corrupted, preventing LGO from successfully reading the data on the card.

4 Reference Station

4.1 Overview

Description

The GRX1200+ Series

- are designed to operate for specific reference station applications using remote control software, for example LEICA GNSS Spider reference station software.
- support internal logging of raw observations which can be downloaded using an external remote control software package such as LEICA GNSS Spider.
- support streaming output of GPS and GLONASS raw observations and status information.
- can log or stream out data from specific external devices approved by Leica Geosystems, such as meteo and tilt, which can be directly output to an external remote control software package.
- can be used to transmit data for real-time operations in proprietary as well as standard RTCM, CMR and CMR+ formats, using a variety of communication devices, including suitable radios, digital cellular phones or modems. The GRX1200+ Series cannot receive reference station broadcasts and therefore cannot be used as a real-time rover receiver.
- can be configured via a web interface.

- can send out Event E-mails and push Raw data to an FTP server.
 - can log data to MDB, RINEX and compact RINEX files.
 - have the same receiver and measurement performance as the other GPS1200+ receivers. Refer to "7 Technical Data" for information on technical data.
-

Special features

To operate for specific reference station applications, the GRX1200+ Series is, compared with the other GPS1200+ receivers, equipped with some special features.

Specific to the GRX1200+ Series:

- Controllable dual external power supply
- Support of external devices such as meteo and tilt

Additional features for GRX1200+ and GRX1200+ GNSS:

- Ring buffer logging
- Web interface
- Event E-mail
- FTP server/push
- RINEX logging
- DynDNS
- High frequency SNR logging
- RTK multiplexing

-
- One Ethernet port including three logical NET ports
 - One port to output PPS
 - One port to input event messages
 - One port for input from an external oscillator

- Additional features for GRX1200+ GNSS:
- Tracking of GLONASS observables
 - Tracking of GPS L5 observables
 - Tracking of Galileo observables

Data storage

All CompactFlash cards recommended by Leica Geosystems are supported. Storing data on a CompactFlash card enables subsequent data download and post-processing. Refer to "1.2.2 Data Storage and Data Conversion Concept" for information on available memory. Refer to "3.3 Working with the CompactFlash Card" for information on inserting and removing a CompactFlash card.

Data streaming

The receiver can be set to stream the raw observations or RTK corrections out of two different communication ports instead of or in addition to storing data on the CompactFlash card.

Power supply

Refer to "1.2.3 Power Concept".

Commands for remote control

Special commands from **Outside World Interface** or Leica Binary 2 format can be used to control the receiver. Documentation for OWI and LB2 is available on request from the Leica Geosystems representative.

4.2 Equipment Setup

Equipment setup

An example for an equipment setup for a reference station is shown in the following diagram. It is a basic serial setup with LEICA GNSS Spider, including a meteo/tilt device and a local radio to broadcast real-time data.

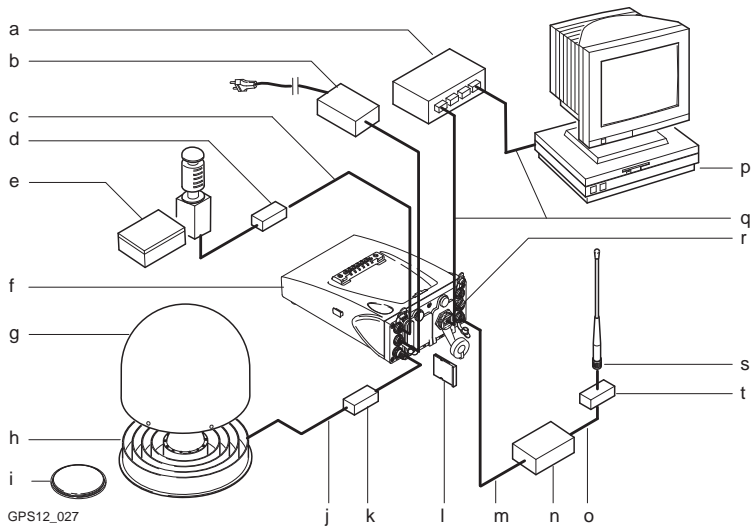

- a) Network hub or router for Internet connection
- b) Power supply unit 100/240 V AC to 12 V DC
- c) Interface cable
- d) DB9 surge arrester with 12 V DC pass through
- e) Meteo/tilt device with interface cable
- f) Receiver GRX1200+ Series
- g) Weather protection radome for AT504 GG/AR25
- h) AT504 GG/AR25
- i) AX1203+ GNSS
- j) TNC to TNC antenna cable
- k) Surge arrester
- l) CompactFlash card
- m) Radio interface cable
- n) Radio
- o) Cable to connect radio antenna
- p) PC for running LEICA GNSS Spider software or the web interface
- q) Ethernet cable for data transfer and receiver communication
- r) Ethernet port
- s) Radio antenna
- t) Radio surge arrester



A ruggedized ethernet cable is used to connect the GRX1200+ Series to the internet. Any PC connected to the internet can then be used to configure the sensor.



The data transfer cable GX RX to RS232 or an ethernet crossover cable can be used to connect the GRX1200+ Series directly to a PC.



Connect the device to transmit real-time data to port P1, P2 or P3 of the receiver. Some devices fit into a clip-on-housing that plugs directly into these ports. Other devices require an interface cable.



Unauthorised radio units should not be connected to the GRX1200+ Series.

Cable connection

Cable connections are identical to other GPS1200+ receivers. Additional cables are available from Leica Geosystems for the specific oscillator and Ethernet ports on the GRX1200+.

Switch on

Hold down the ON/OFF button on the receiver for at least 2 s.

OR

Press **PROG** on the RX1200, if used.

OR

Send a pulse/data to one of the serial ports. Port P1, P2 and P3 can be configured not to allow receiver switch on upon pulse reception.

Switch off

Press the ON/OFF button on the receiver for at least 4 s.

OR

Press **PROG** and **USER** simultaneously on the RX1200, if used.

OR

Click on POWER DOWN in the Web Interface Tools menu.

Behaviour when turning off and on

Turning the GRX1200+ Series off and on again resets the receiver. The consequences are:

- If the configuration of the output is stored in the configuration set, standard NMEA messages are still output.
 - All data/message outputs scheduled via OWI or LB2 commands are no longer output.
 - Data logging parameters and interface configuration options, that have been set by OWI or LB2 commands and have not been saved to a configuration set using the corresponding OWI or LB2 command, are reset.
-

Behaviour after power failure

After temporary power failure, the GRX1200+ Series will automatically power itself up and resume the previously set operations including OWI or LB2 output. Two power fail recovery options are available - **Sudden Loss Only** and **Always**. To access the configuration select either:

- RX1200: **Main Menu: Config...\General Settings...\Start Up & Power Down.**
 - Computer: **Configuration - Start Up & Power Down** in the web interface.
-

4.3 Getting Started with the GRX1200+ Series





Refer to the separate "GRX1200+ Series - Getting Started" manual for more detailed information.

Ways of operating

The GRX1200+ Series can either be operated with the RX1200 like the other GPS1200+ receivers or by remote control, with its web interface or a reference station software.

Operation	Description
With RX1200	<p>The receiver can be fully configured and point occupation can be started/stopped when using the campaign option.</p> <p>Available with full functionality</p> <ul style="list-style-type: none">• Job management• Data management• Configuration of ports• Configuration of operation parameters• Status information• Transfer capabilities including the upload of new firmware

Operation	Description
	<p data-bbox="594 187 656 218"></p> <p data-bbox="704 187 1365 280">With the purchased campaign option, starting and stopping point occupation for raw data logging can be done from the RX1200.</p> <p data-bbox="588 306 733 332">Unavailable</p> <p data-bbox="588 358 1365 415">Any other application program available on GPS1200+ such as Stakeout</p> <p data-bbox="594 441 656 472"></p> <p data-bbox="704 441 1365 534">Refer to the relevant chapters in this manual or to the GPS1200+ Technical Reference Manual for information on configuring and using the receiver.</p>
By remote control	<ul data-bbox="588 555 1365 855" style="list-style-type: none"><li data-bbox="588 555 1365 617">• Special commands from OWI or LB2 can be used to control the GRX1200+ Series through a remote interface.<li data-bbox="588 638 1365 772">• For the majority of applications, the GRX1200+ Series has to be operated using a suitable application software that supports the OWI or LB2 commands, such as LEICA GNSS Spider.<li data-bbox="588 793 1365 855">• Remote control also supports the download of internally logged data and upload of files to the receiver.

Operation	Description
By web interface	<ul style="list-style-type: none">• For the GRX1200+ Series a web server is included in the receiver that allows remote control from any computer via TCP/IP or internet interface connection and web browser.

Configure a remote interface connection



Remote interface to be configured	Configure using
Standard default RS232	<ul style="list-style-type: none">• Each port is by default a remote port. No specific receiver configurations must be done.• The default settings allow immediate communication using the following port communication parameters: Baud rate: 115200 Data bits: 8 Parity: None Stop bit: 1 Flow control: None
Specific devices such as modems for a particular port	Must be configured using the RX1200. Refer to "Configure a modem interface step-by-step" for an example.
GRX1200+ built-in ethernet device for communicating with the receiver	Must be configured using the RX1200 or the Startup Configurator. Refer to "Configure a NET port step-by-step" for an example.

Remote interface to be configured	Configure using
Any other interface and operation configuration required	Can be done using LEICA GNSS Spider or the web interface.

Configure a modem interface step-by-step

In order to use a modem for the remote interface connection, the corresponding device has to be created on the receiver and attached to the receiver serial port. As an example, the following step-by-step description shows how to configure a U.S. Robotics 56k modem for port P1 on the receiver. Refer to the GPS1200+ Technical Reference Manual for more information. Refer to the manual of the modem for information on the modem configuration.

Step	Description
1.	Main Menu: Config...\Interfaces...
2.	CONFIGURE Interfaces Highlight Remote .
3.	EDIT (F3) to access CONFIGURE Remote Interfaces .
4.	Highlight 1.
	Remote must be displayed in column Interface . USE (F6) and YES (F6) to close other interfaces configured on this port.

Step	Description
5.	DEVICE (F5) to access CONFIGURE Devices .
6.	PAGE (F6) changes to the Modem/GSM page.
7.	CONFIGURE Devices, Modem/GSM page Highlight Modem .
8.	NEW (F2) to create a new modem.
9.	CONFIGURE Device Type in a name and the port parameters for the modem.
	ATCMD (F4) to configure the communication commands for the modem.
10.	STORE (F1) to return to CONFIGURE Devices, Modem/GSM page.
	The receiver is ready to accept an incoming call from a remote application.
11.	Connect the modem to port P1 of the receiver using a modem cable.
12.	Connect the modem cable to the phone line and to a suitable power supply.

Configure a NET port step-by-step

In order to use a NET port for the remote interface connection, the RJ45 connector of the GRX1200+/GRX1200+ GNSS must be connected to a network hub or router. If connecting directly to a PC, a crossed Ethernet cable is required. The following step-by-step description shows how to configure a NET port and assign the remote interface to it. Refer to the GPS1200+ Technical Reference Manual and to the "GRX1200+ Series - Getting Started" for more information.

Step	Description
1.	Main Menu: Config...\Instrument Settings...\Set NET Parameters
2.	CONFIGURE Set NET Parameters Enter the Internet Protocol address, the network mask and the gateway.
3.	CONT (F1) returns to GPS1200+ Main Menu.
4.	Main Menu: Config...\Interfaces...
5.	CONFIGURE Interfaces Highlight Remote.
6.	EDIT (F3) to access CONFIGURE Remote Interfaces.
7.	Highlight a NET port.
8.	CTRL (F4) to access CONFIGURE Set NET Port.

Step	Description
9.	CONFIGURE Set NET Port <User: Server> Configure the NET port number and access control.
10.	CONT (F1) to return to CONFIGURE Remote Interfaces .
11.	Is Remote displayed in the column Interface for the selected NET port? <ul style="list-style-type: none">• If yes, continue with step 13.• If no, continue with step 12.
12.	USE (F6) and YES (F6) to close other interfaces configured on this port.
13.	Press CONT (F1) twice to return to GPS1200+ Main Menu.
	The receiver is ready to accept an incoming call from a remote application.
14.	Connect the receivers RJ45 connector NET to a LAN using a suitable network cable.

5 Care and Transport

5.1 Transport

Transport in the field

When transporting the equipment in the field, always make sure that you

- either carry the product in its original transport container,
 - or carry the tripod with its legs splayed across your shoulder, keeping the attached product upright.
-

Transport in a road vehicle

Never carry the product loose in a road vehicle, as it can be affected by shock and vibration. Always carry the product in its transport container and secure it.

Shipping

When transporting the product by rail, air or sea, always use the complete original Leica Geosystems packaging, transport container and cardboard box, or its equivalent, to protect against shock and vibration.

Shipping, transport of batteries

When transporting or shipping batteries, the person in charge of the product must ensure that the applicable national and international rules and regulations are observed. Before transportation or shipping, contact your local passenger or freight transport company.

5.2 Storage

Product

Respect the temperature limits when storing the equipment, particularly in summer if the equipment is inside a vehicle. Refer to "7 Technical Data" for information about temperature limits.

Li-Ion batteries

- Refer to "7.1.3 Technical Data" for information about storage temperature range.
 - A storage temperature range of -20 to +30°C/-4 to 86°F in a dry environment is recommended to minimise self-discharging of the battery.
 - At the recommended storage temperature range, batteries containing a 10% to 50% charge can be stored for up to one year. After this storage period the batteries must be recharged.
 - Remove batteries from the product and the charger before storing.
 - After storage recharge batteries before using.
 - Protect batteries from damp and wetness. Wet or damp batteries must be dried before storing or use.
-

5.3 Cleaning and Drying

Product and accessories

Use only a clean, soft, lint-free cloth for cleaning. If necessary, moisten the cloth with water or pure alcohol.

Do not use other liquids; these may attack the polymer components.

Damp products

Dry the product, the transport container, the foam inserts and the accessories at a temperature not greater than 40°C/104°F and clean them. Do not repack until everything is completely dry. Always close the transport container when using in the field.

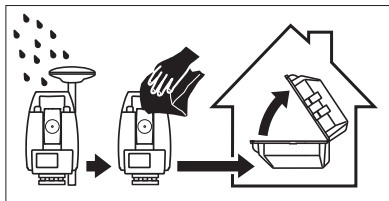

Cables and plugs

Keep plugs clean and dry. Blow away any dirt lodged in the plugs of the connecting cables.

**Connectors with
dust caps**

Wet connectors must be completely dry before attaching the dust cap.

6 Safety Directions

6.1 General Introduction

Description

The following directions should enable the person responsible for the product, and the person who actually uses the equipment, to anticipate and avoid operational hazards.

The person responsible for the product must ensure that all users understand these directions and adhere to them.

6.2 Intended Use

Permitted use

- Measuring raw data and computing coordinates using carrier phase and code signal from GNSS satellites.
 - Carrying out measurement tasks using various GNSS measuring techniques.
 - Recording GNSS and point related data.
 - Computing by means of software.
 - Data communication with external appliances.
-

Adverse use

- Use of the product without instruction.
- Use outside of the intended limits.
- Disabling safety systems.
- Removal of hazard notices.
- Opening the product using tools, for example screwdriver, unless this is specifically permitted for certain functions.
- Modification or conversion of the product.
- Use after misappropriation.
- Use of products with obviously recognizable damages or defects.
- Use with accessories from other manufacturers without the prior explicit approval of Leica Geosystems.

- Inadequate safeguards at the working site, for example when measuring on roads.
- Controlling of machines, moving objects or similar monitoring application without additional control- and safety installations.

 **Warning**

Adverse use can lead to injury, malfunction and damage.

It is the task of the person responsible for the equipment to inform the user about hazards and how to counteract them. The product is not to be operated until the user has been instructed on how to work with it.

6.3 Limits of Use

Environment

Suitable for use in an atmosphere appropriate for permanent human habitation: not suitable for use in aggressive or explosive environments.



Danger

Local safety authorities and safety experts must be contacted before working in hazardous areas, or in close proximity to electrical installations or similar situations by the person in charge of the product.

6.4 Responsibilities

Manufacturer of the product	Leica Geosystems AG, CH-9435 Heerbrugg, hereinafter referred to as Leica Geosystems, is responsible for supplying the product, including the user manual and original accessories, in a completely safe condition.
Manufacturers of non Leica Geosystems accessories	The manufacturers of non Leica Geosystems accessories for the product are responsible for developing, implementing and communicating safety concepts for their products, and are also responsible for the effectiveness of those safety concepts in combination with the Leica Geosystems product.
Person in charge of the product	The person in charge of the product has the following duties: <ul style="list-style-type: none">• To understand the safety instructions on the product and the instructions in the user manual.• To be familiar with local regulations relating to safety and accident prevention.• To inform Leica Geosystems immediately if the product and the application becomes unsafe.
 Warning	The person responsible for the product must ensure that it is used in accordance with the instructions. This person is also accountable for the training and the deployment of personnel who use the product and for the safety of the equipment in use.

6.5 Hazards of Use

Warning

The absence of instruction, or the inadequate imparting of instruction, can lead to incorrect or adverse use, and can give rise to accidents with far-reaching human, material, financial and environmental consequences.

Precautions:

All users must follow the safety directions given by the manufacturer and the directions of the person responsible for the product.

Caution

Watch out for erroneous measurement results if the product has been dropped or has been misused, modified, stored for long periods or transported.

Precautions:

Periodically carry out test measurements and perform the field adjustments indicated in the user manual, particularly after the product has been subjected to abnormal use and before and after important measurements.

Danger

Because of the risk of electrocution, it is very dangerous to use poles and extensions in the vicinity of electrical installations such as power cables or electrical railways.

Precautions:

Keep at a safe distance from electrical installations. If it is essential to work in this environment, first contact the safety authorities responsible for the electrical installations and follow their instructions.

**Warning**

If the product is used with accessories, for example masts, staffs, poles, you may increase the risk of being struck by lightning.

Precautions:

Do not use the product in a thunderstorm.

Warning

During dynamic applications, for example stakeout procedures there is a danger of accidents occurring if the user does not pay attention to the environmental conditions around, for example obstacles, excavations or traffic.

Precautions:

The person responsible for the product must make all users fully aware of the existing dangers.

 **Warning**

Inadequate securing of the working site can lead to dangerous situations, for example in traffic, on building sites, and at industrial installations.

Precautions:

Always ensure that the working site is adequately secured. Adhere to the regulations governing safety and accident prevention and road traffic.

 **Warning**

Only Leica Geosystems authorised service workshops are entitled to repair these products.

 **Warning**

If computers intended for use indoors are used in the field there is a danger of electric shock.

Precautions:

Adhere to the instructions given by the computer manufacturer with regard to field use in conjunction with Leica Geosystems products.

 **Caution**

If the accessories used with the product are not properly secured and the product is subjected to mechanical shock, for example blows or falling, the product may be damaged or people may sustain injury.

Precautions:

When setting-up the product, make sure that the accessories are correctly adapted, fitted, secured, and locked in position.

Avoid subjecting the product to mechanical stress.

 **Caution**

The product uses the GPS P-Code signal which by U.S. policy may be switched off without notice.

 **Caution**

During the transport, shipping or disposal of batteries it is possible for inappropriate mechanical influences to constitute a fire hazard.

Precautions:

Before shipping the product or disposing of it, discharge the batteries by running the product until they are flat.

When transporting or shipping batteries, the person in charge of the product must ensure that the applicable national and international rules and regulations are observed. Before transportation or shipping contact your local passenger or freight transport company.

 **Warning**

Using a battery charger not recommended by Leica Geosystems can destroy the batteries. This can cause fire or explosions.

Precautions:

Only use chargers recommended by Leica Geosystems to charge the batteries.

 **Warning**

High mechanical stress, high ambient temperatures or immersion into fluids can cause leakage, fire or explosions of the batteries.

Precautions:

Protect the batteries from mechanical influences and high ambient temperatures. Do not drop or immerse batteries into fluids.

 **Warning**

Short circuited battery terminals can overheat and cause injury or fire, for example by storing or transporting in pockets if battery terminals come in contact with jewelry, keys, metallized paper or other metals.

Precautions:

Make sure that the battery terminals do not come into contact with metallic objects.

 **Warning**

Incorrect fastening of the external antenna to vehicles or transporters poses the risk of the equipment being broken by mechanical influence, vibration or airstream. This may result in accident and physical injury.

Precautions:

Attach the external antenna professionally. The external antenna must be secured additionally, for example by use of a safety cord. Ensure that the mounting device is correctly mounted and able to safely carry the weight of the external antenna (>1 kg).

 **Warning**

If the product is improperly disposed of, the following can happen:

- If polymer parts are burnt, poisonous gases are produced which may impair health.
- If batteries are damaged or are heated strongly, they can explode and cause poisoning, burning, corrosion or environmental contamination.
- By disposing of the product irresponsibly you may enable unauthorized persons to use it in contravention of the regulations, exposing themselves and third parties to the risk of severe injury and rendering the environment liable to contamination.

Precautions:

The product must not be disposed with household waste.

Dispose of the product appropriately in accordance with the national regulations in force in your country.

Always prevent access to the product by unauthorized personnel.

Product specific treatment and waste management information can be downloaded from the Leica Geosystems home page at <http://www.leica-geosystems.com/treatment> or received from your Leica Geosystems dealer.

 **Danger**

If the product is used with accessories, for example on masts, staffs, poles, you may increase the risk of being struck by lightning. Danger from high voltages also exists

near power lines. Lightning, voltage peaks, or the touching of power lines can cause damage, injury and death.

Precautions:

- Do not use the product in a thunderstorm as you may increase the risk of being struck by lightning.
- Be sure to remain at a safe distance from electrical installations. Do not use the product directly under or in close proximity to power lines. If it is essential to work in such an environment contact the safety authorities responsible for electrical installations and follow their instructions.
- If the product has to be permanently mounted in an exposed location, it is advisable to provide a lightning conductor system. A suggestion on how to design a lightning conductor for the product is given below. Always follow the regulations in force in your country with regard to grounding antennas and masts. These installations must be carried out by an authorised specialist.
- To prevent damages due to indirect lightning strikes (voltage spikes) cables, for example for antenna, power source or modem should be protected with appropriate protection elements, like a lightning arrester. These installations must be carried out by an authorized specialist.
- If there is a risk of a thunderstorm, or if the equipment is to remain unused and unattended for a long period, protect your product additionally by unplugging all systems components and disconnecting all connecting cables and supply cables, for example, receiver - antenna.

Lightning conductors

Suggestion for design of a lightning conductor for a GNSS system:

1. On non-metallic structures

Protection by air terminals is recommended. An air terminal is a pointed solid or tubular rod of conducting material with proper mounting and connection to a conductor. The position of four air terminals should be uniformly distributed around the antenna at a distance equal to the height of the air terminal.

The air terminal diameter should be 12 mm for copper or 15 mm for aluminium. The height of the air terminals should be 25 cm to 50 cm. All air terminals should be connected to the down conductors. The diameter of the air terminal should be kept to a minimum to reduce GNSS signal shading.

2. On metallic structures

Protection is as described for non-metallic structures, but the air terminals can be connected directly to the conducting structure without the need for down conductors.

**Air terminal
arrangement, plan
view**

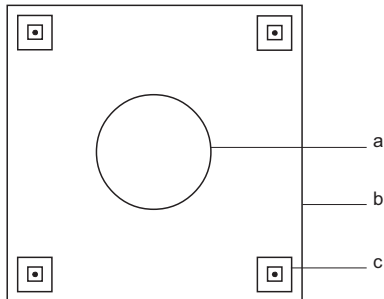

GPS12_059

- a) Antenna
- b) Support structure
- c) Air terminal

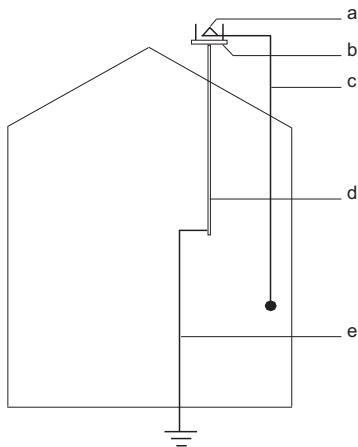
Grounding the receiver/antenna

GPS12_060

- a) Antenna
- b) Lightning conductor array
- c) Antenna/receiver connection
- d) Metallic mast
- e) Connection to earth

6.6 Electromagnetic Compatibility EMC

Description

The term Electromagnetic Compatibility is taken to mean the capability of the product to function smoothly in an environment where electromagnetic radiation and electrostatic discharges are present, and without causing electromagnetic disturbances to other equipment.

Warning

Electromagnetic radiation can cause disturbances in other equipment.

Although the product meets the strict regulations and standards which are in force in this respect, Leica Geosystems cannot completely exclude the possibility that other equipment may be disturbed.

Caution

There is a risk that disturbances may be caused in other equipment if the product is used in conjunction with accessories from other manufacturers, for example field computers, personal computers, two-way radios, non-standard cables or external batteries.

Precautions:

Use only the equipment and accessories recommended by Leica Geosystems. When combined with the product, they meet the strict requirements stipulated by the guidelines and standards. When using computers and two-way radios, pay attention to the information about electromagnetic compatibility provided by the manufacturer.

 **Caution**

Disturbances caused by electromagnetic radiation can result in erroneous measurements.

Although the product meets the strict regulations and standards which are in force in this respect, Leica Geosystems cannot completely exclude the possibility that the product may be disturbed by very intense electromagnetic radiation, for example, near radio transmitters, two-way radios or diesel generators.

Precautions:

Check the plausibility of results obtained under these conditions.

 **Warning**

If the product is operated with connecting cables attached at only one of their two ends, for example external supply cables, interface cables, the permitted level of electromagnetic radiation may be exceeded and the correct functioning of other products may be impaired.

Precautions:

While the product is in use, connecting cables, for example product to external battery, product to computer, must be connected at both ends.

**Radios, digital
cellular phones or
ATX1230+ GNSS
with Bluetooth**



Use of product with radio, digital cellular phone devices or ATX1230+ GNSS with Bluetooth:

Electromagnetic radiation can cause disturbances in other equipment, in installations, in medical devices, for example pacemakers or hearing aids and in aircraft. It can also affect humans and animals.

Precautions:

Although the product meets in combination with radio or digital cellular phone devices recommended by Leica Geosystems the strict regulations and standards which are in force in this respect, Leica Geosystems cannot completely exclude the possibility that other equipment may be disturbed or that humans or animals may be affected.

- Do not operate the product with radio or digital cellular phone devices in the vicinity of filling stations or chemical installations, or in other areas where an explosion hazard exists.
- Do not operate the product with radio or digital cellular phone devices near to medical equipment.
- Do not operate the product with radio or digital cellular phone devices in aircraft.
- Do not operate the product with radio or digital cellular phone devices for long periods immediately next to your body.

6.7 FCC Statement, Applicable in U.S.

Applicability

The grayed paragraph below is only applicable for products of the GPS1200+ System without radio, digital cellular phone devices or Bluetooth.

Warning

This equipment has been tested and found to comply with the limits for a Class B digital device, pursuant to part 15 of the FCC rules.

These limits are designed to provide reasonable protection against harmful interference in a residential installation.

This equipment generates, uses and can radiate radio frequency energy and, if not installed and used in accordance with the instructions, may cause harmful interference to radio communications. However, there is no guarantee that interference will not occur in a particular installation.

If this equipment does cause harmful interference to radio or television reception, which can be determined by turning the equipment off and on, the user is encouraged to try to correct the interference by one or more of the following measures:

- Reorient or relocate the receiving antenna.
- Increase the separation between the equipment and the receiver.
- Connect the equipment into an outlet on a circuit different from that to which the receiver is connected.
- Consult the dealer or an experienced radio/TV technician for help.

**Labelling GFU19,
GFU25, GFU26**

Type: GFUXX

.....

.....

.....

.....

.....

.....

.....

.....

.....

.....

.....



This device complies with part 15 of the FCC Rules. Operation is subject to the following two conditions: (1) This device may not cause harmful interference, and (2) this device must accept any interference received, including interference that may cause undesired operation.

TPS12_218

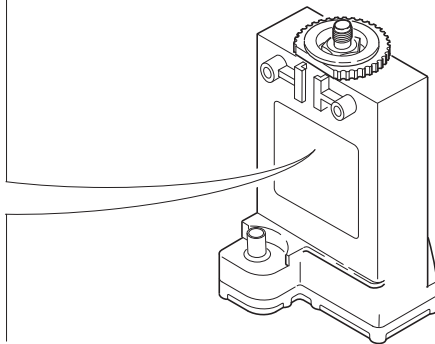

Labelling internal battery GEB211, GEB221

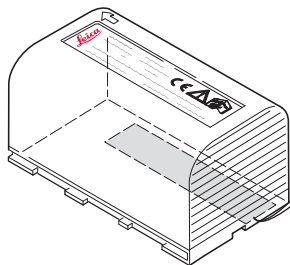

This device complies with part 15 of the FCC Rules. Operation is subject to the following two conditions: (1) This device may not cause harmful interference, and (2) this device must accept any interference received, including interference that may cause undesired operation.

 US LISTED
ITE Accessory
E179078 . 70YL

TPS12_082

7 Technical Data

7.1 Receiver Technical Data

7.1.1 Tracking Characteristics of the Receiver

Receiver technology	SmartTrack+/SmartTrack	
Satellite reception	GX1230+ GNSS/GX1220+ GNSS/ GRX1200+ GNSS: GX1230+/GX1220+/GRX1200+: GX1210+:	Triple frequency Dual frequency Single frequency
Receiver channels	GX1230+ GNSS/GX1220+ GNSS/ GRX1200+ GNSS: GX1230+/GX1220+/GRX1200+:	Up to 16 channels continuous tracking on L1, L2 and L5 (GPS); up to 14 channels continuous tracking on L1 and L2 (GLONASS); up to 14 channels continuous tracking on E1, E5a, E5b and Alt-BOC (Galileo); four channels tracking SBAS. 16 channels continuous tracking on L1 and L2 (GPS); four channels tracking SBAS.

GX1210+:

16 channels continuous tracking on L1 (GPS); four channels tracking SBAS.



Depending on the satellite systems and signals configured in **CONFIGURE Satellite Settings** a maximum number of 120 channels is allocated.

Supported codes and phases

GPS

Type	L1	L2	L5
GX1230+ GNSS/ GX1220+ GNSS/ GRX1200+ GNSS	Carrier phase, C/A code	Carrier phase, C code (L2C) and P2 code	Carrier phase, code
GX1230+/GX1220+/ GRX1200+	Carrier phase, C/A code	Carrier phase, C code (L2C) and P2 code	-
GX1210+	Carrier phase, C/A code	-	-

GLONASS

Type	L1	L2
ATX1230+ GNSS	Carrier phase, C/A code	Carrier phase, P2 code

Galileo

Type	E1	E5a	E5b	Alt-BOC
ATX1230+ GNSS	Carrier phase, code	Carrier phase, code	Carrier phase, code	Carrier phase, code



Carrier phase and code measurements on L1, L2 and L5 (GPS) are fully independent with AS on or off.

Satellites tracked

GX1230+ GNSS/GX1220+ GNSS/
GRX1200+ GNSS:

Up to 16 simultaneously on L1, L2 and L5 (GPS) + up to 14 simultaneously on L1 and L2 (GLONASS) + up to 14 simultaneously on E1, E5a, E5b and Alt-BOC (Galileo) + up to four SBAS

GX1230+/GX1220+/GRX1200+:

Up to 16 simultaneously on L1 and L2 (GPS) + up to four SBAS

GX1210+:

Up to 16 simultaneously on L1 (GPS) + up to four SBAS

7.1.2 Accuracy



Accuracy is dependent upon various factors including the number of satellites tracked, constellation geometry, observation time, ephemeris accuracy, ionospheric disturbance, multipath and resolved ambiguities.

The following accuracies, given as **root mean square**, are based on measurements processed using LGO and on real-time measurements.

The use of multiple GNSS systems can increase accuracy by up to 30% relative to GPS only.

Differential code

For all receivers, the baseline precision of a differential code solution for static and kinematic surveys is 25 cm.

**Differential phase
in post-processing****Normal baselines with
GX1230+ GNSS/GX1230+/GX1220+ GNSS/GX1220+/GRX1200+ Series plus
AX1203+ GNSS**

Static		Kinematic	
Horizontal	Vertical	Horizontal	Vertical
5 mm + 0.5 ppm	10 mm + 0.5 ppm	10 mm + 1 ppm	20 mm + 1 ppm

**Long baselines with
GX1230+ GNSS/GX1230+/GX1220+ GNSS/GX1220+/GRX1200+ Series plus
AT504 GG/AR25**

Static	
Horizontal	Vertical
3 mm + 0.5 ppm	6 mm + 0.5 ppm

Short baselines with GX1210+ plus AX1201

Static	
Horizontal	Vertical
5 mm + 0.5 ppm	10 mm + 0.5 ppm

Differential phase
in real-time

GX1230+ GNSS/GX1230+ plus AX1203+ GNSS

Static		Kinematic	
Horizontal	Vertical	Horizontal	Vertical
5 mm + 0.5 ppm	10 mm + 0.5 ppm	10 mm + 1 ppm	20 mm + 1 ppm

7.1.3 Technical Data

Dimensions

The dimensions are given for the housing without the sockets.

Type	Length [m]	Width [m]	Thickness [m]
All receivers	0.212	0.166	0.079

Weight

Receiver weights without battery and radio:

Type	Weight [kg]
GX1230+ GNSS/GX1230+/GX1220+ GNSS/GX1220+/GX1210+	1.2
GRX1200+/GRX1200+ GNSS	1.3

Recording

Data can be recorded on the CompactFlash card or in the internal memory, if fitted.

Type	Capacity [MB]	Data capacity
CompactFlash card	<ul style="list-style-type: none"> • 256 • 1024 	256 MB is typically sufficient for about GPS only (12 satellites)
Internal memory	<ul style="list-style-type: none"> • 256 	<ul style="list-style-type: none"> • 2000 h L1 + L2 + L5 data logging at 15 s rate • 8000 h L1 + L2 + L5 data logging at 60 s rate • 360000 real-time points with codes GPS + GLONASS (12/8 satellites) <ul style="list-style-type: none"> • 1700 h data logging at 15 s rate • 6800 h data logging at 60 s rate • 360000 real-time points with codes GPS + GLONASS + Galileo (12/8/10 satellites) <ul style="list-style-type: none"> • 800 h data logging at 15 s rate • 3200 h data logging at 60 s rate • 360000 real-time points with codes

Power	Power consumption:	GX1230+ GNSS/GX1230+/GX1220+ GNSS/GX1220+/GX1210+, radio and RX1200 excluded: 3.2 W typically, 270 mA
	External supply voltage:	Nominal 12 V DC (==, GEV71 car battery cable to a 12 V car battery), voltage range 10.5-28 V DC

Battery internal	Type:	Li-Ion
	Voltage:	7.4 V
	Capacity:	GEB221: 4.4 Ah

Battery external	Type:	NiMH
	Voltage:	12 V
	Capacity:	GEB171: 9.0 Ah

Operating times	The given operating times are valid for	
	<ul style="list-style-type: none">• all receiver types except GRX1200+/GRX1200+ GNSS.• receiver plus antenna plus RX1200 without keyboard illumination and without screen heating.• two fully charged GEB221 batteries.• room temperature. Operating times will be shorter when working in cold weather.	

Equipment			Operating time
Type	Radio	Digital cellular phone	
Static	-	-	17 h continuously
Rover	Pacific Crest PDL, receive	-	11 h continuously
Rover	-	Siemens MC75	11 h continuously

Environmental specifications

Temperature

Type	Operating temperature [°C]	Storage temperature [°C]
All receivers	-40 to +65	-40 to +80
Leica CompactFlash cards, all sizes	-40 to +80	-40 to +80
Battery internal	-20 to +55	-40 to +70

Protection against water, dust and sand

Type	Protection
All receivers	IP67 (IEC 60529) Dusttight Waterproof to 1 m temporary immersion

Humidity

Type	Protection
All receivers	Up to 100 % The effects of condensation are to be effectively counteracted by periodically drying out the receiver.

PPS output

For GX1200+ with PPS/Event option and GRX1200+/GRX1200+ GNSS

PPS output characteristics:

Peak: 3.3 V = High

Impedance: 50 Ω

Pulse length: 1 ms

Leading edge: Coinciding with the beginning of each epoch.

PPS output characteristics:

Peak: 3.3 V = High

Positive/negative edge: Selectable via RX1200.

Cable connectivity:

Matched with an appropriate impedance of: 50 Ω

Socket: LEMO ERN.0S.250.CTL

Event input

For GX1200+ with PPS/Event option and GRX1200+/GRX1200+ GNSS

Pulse type:	TTL, positive or negative going pulse
Pulse length:	125 ns at minimum
Voltage:	TTL level, ~ 5 V, min. 3.3 V
Pin definition:	Centre = signal, Case = ground
Socket:	LEMO HGP.00.250.CTL

External oscillator input

For GRX1200+/GRX1200+ GNSS

External clock input:	
Frequency:	5 MHz or 10 MHz
Input impedance:	50 Ω nominal
Input VSWR:	2:1 maximum
Signal level:	0 dBm minimum to +13.0 dBm maximum
Frequency stability:	± 0.5 ppm maximum
Wave shape:	Sinusoidal

Connector: MMCX female

7.2 Antennas Technical Data

Description and use

The antenna is selected for use based upon the application. The table gives a description and the intended use of the individual antennas.

Type	Description	Use
AX1201	L1 SmartTrack antenna with built in groundplane.	With GX1210+ receiver.
AX1203+ GNSS	GPS, GLONASS, Galileo, Compass SmartTrack+ antenna with built in ground-plane.	With GX1220+, GX1220+ GNSS, GX1230+, GX1230+ GNSS receiver or GRX1200+ Series.
AT504 GG	Dorne & Margolin L1/L2 antenna element with gold anodized choke ring ground-plane. Complies with IGS type 'T' antenna, JPL design. Optional protective radome.	With GX1220+, GX1220+ GNSS, GX1230+, GX1230+ GNSS or GRX1200+ Series where higher precision is required. For example static surveys of long baselines, tectonic plate monitoring and reference stations.

Type	Description	Use
AR25	Dorne & Margolin GPS, GLONASS, Galileo, Compass antenna element with gold anodized choke ring groundplane. Optional protective radome.	With GX1220+, GX1220+ GNSS, GX1230+, GX1230+ GNSS or GRX1200+ Series where higher precision is required. For example static surveys of long baselines, tectonic plate monitoring and reference stations.

Dimensions

Type	AX1201/AX1203+ GNSS	AT504 GG	AR25
Height	6.2 cm	14.0 cm	20.0 cm
Diameter	17.0 cm	38.0 cm	38.0 cm

Connector

AX1201/AX1203+ GNSS:	TNC female
AT504 GG/AR25:	N female

Mounting

All antennas:	5/8" Whitworth
---------------	----------------

Weight

AX1201/AX1203+ GNSS:	0.4 kg
----------------------	--------

AT504 GG:
AR25:

4.3 kg, radome 1.1 kg
7.6 kg, radome 1.1 kg

Electrical data

Type	AX1201	AX1203+ GNSS	AT504 GG	AR25
Voltage	4.5 to 18 V DC	4.5 to 18 V DC	4.5 to 18 V DC	3.3 to 12 V DC
Current	35 mA typical	35 mA typical	50 mA max	100 mA max
Frequency				
GPS L1 1575.42 MHz	X	X	X	X
GPS L2 1227.60 MHz	-	X	X	X
GPS L5 1176.45 MHz	-	X	-	X
GLONASS L1 1602.5625- 1611.5 MHz	-	X	X	X
GLONASS L2 1246.4375- 1254.3 MHz	-	X	X	X

Type	AX1201	AX1203+ GNSS	AT504 GG	AR25
Galileo E1 1575.42 MHz	-	X	-	X
Galileo E5a 1176.45 MHz	-	X	-	X
Galileo E5b 1207.14 MHz	-	X	-	X
Galileo Alt-BOC 1191.795 MHz	-	X	-	X
Gain (typically)	27 dBi	29 dBi	29 dBi	40 dBi
Noise Figure (typically)	< 2 dBi	< 2 dBi	3 dBi max	< 1.2 dBi max



Galileo Alt-BOC covers bandwidth of Galileo E5a and E5b.

Environmental specifications

Temperature

Type	Operating temperature [°C]	Storage temperature [°C]
AX1201/ AX1203+ GNSS	-40 to +70	-55 to +85
AT504 GG	-40 to +70	-40 to +70
AR25	-55 to +85	-55 to +90

Protection against water, dust and sand

Type	Protection
All antennas	IP67 (IEC 60529) Dusttight Protected against water jets Waterproof to 1 m temporary immersion

Humidity

Type	Protection
All antennas	Up to 100 % The effects of condensation are to be effectively counteracted by periodically drying out the antenna.

Cable length

Separation distance from receiver ...	to antenna	Supplied cable lengths [m]	Optional cable lengths [m]
GX1230+ GNSS/ GX1220+ GNSS/ GX1230+/GX1220+/ GX1210+	AX1201/	1.2	30
	AX1203+ GNSS	2.8	50
			70
GRX1200+/ GRX1200+ GNSS	AT504 GG/AR25	1.2	30
	AX1203+ GNSS	2.8	50
		10	70

7.3 RX1200 Technical Data

Control unit

Display:	1/4 VGA (320 x 240 pixels), monochrome (RX1210/RX1250X) or color (RX1250Xc), graphics capable LCD, illumination, optional touch screen
Keyboard:	62 keys including 12 function keys, illumination
Angle Display:	360°", 360° decimal, 400 gon, 6400 mil, V %
Distance Display:	m, ft int, ft us, ft int inch, ft us inch
Touch screen if fitted:	Toughened film on glass

Dimensions

Type	Length [m]	Width [m]	Thickness [m]
RX1210	0.218	0.123	0.037
RX1250X/RX1250Xc	0.218	0.123	0.047

Weight

Type	Weight [kg]/[lbs]
RX1210	0.480/1.058
RX1250X/RX1250Xc with GEB211	0.741/1.634

Recording

For RX1250X/RX1250Xc, data can be recorded on the CompactFlash card.

Type	Capacity [MB]	Data capacity
CompactFlash card	<ul style="list-style-type: none"> • 256 • 1024 	<p>256 MB is typically sufficient for about GPS only (12 satellites)</p> <ul style="list-style-type: none"> • 2000 h L1 + L2 + L5 data logging at 15 s rate • 8000 h L1 + L2 + L5 data logging at 60 s rate • 360000 real-time points with codes <p>GPS + GLONASS (12/8 satellites)</p> <ul style="list-style-type: none"> • 1700 h data logging at 15 s rate • 6800 h data logging at 60 s rate • 360000 real-time points with codes <p>GPS + GLONASS + Galileo (12/8/10 satellites)</p> <ul style="list-style-type: none"> • 800 h data logging at 15 s rate • 3200 h data logging at 60 s rate • 360000 real-time points with codes

Power

Type	Consumption [W]	External supply voltage
RX1210	1	Nominal voltage 12 V DC (---) Voltage range 11.5 V-28 V
RX1250X/ RX1250Xc	1.1/ 1.4 Bluetooth to SmartAntenna, digital cellular phone powered from GHT56	Nominal voltage 12 V DC (---) Voltage range 11.5 V-28 V

Internal battery

Type	Battery	Voltage	Capacity	Operating time, typical
RX1250X/ RX1250Xc	Li-Ion	7.4 V	GEB211: 2.2 Ah	12 h/ 11 h Bluetooth to SmartAntenna

Environmental specifications**Temperature**

Type	Operating temperature [°C]	Storage temperature [°C]
RX1200	-30 to +65 Bluetooth: -25 to +65 Color display: -30 to +50	-40 to +80

Protection against water, dust and sand

Type	Protection
RX1200	IP67 (IEC 60529) Dusttight Waterproof to 1 m temporary immersion

Humidity

Type	Protection
RX1200	Up to 100 % The effects of condensation are to be effectively counteracted by periodically drying out the RX1200.

Ports

Type	8 pin LEMO-1	Special clip-on interface
RX1210	For power and/or communication	For power and communication to GPS1200+

Type	8 pin LEMO-1	Special clip-on interface
RX1250X/ RX1250Xc	For power and/or communication	For communication to GHT56 and GPS1200+

7.4 Conformity to National Regulations

7.4.1 RX1250

Conformity to national regulations

- FCC Part 15 (applicable in US)
- Hereby, Leica Geosystems AG, declares that the RX1250 is in compliance with the essential requirements and other relevant provisions of Directive 1999/5/EC. The declaration of conformity may be consulted at <http://www.leica-geosystems.com/ce>.



Class 1 equipment according European Directive 1999/5/EC (R&TTE) can be placed on the market and be put into service without restrictions in any EU Member state.

- The conformity for countries with other national regulations not covered by the FCC part 15 or European directive 1999/5/EC has to be approved prior to use and operation.

Frequency band

Type	Frequency band [MHz]
RX1250, Bluetooth	2400 - 2483.5

Ouput power

Type	Output power [mW]
RX1250, Bluetooth	2.5

Antenna

Type	Antenna	Gain [dBi]	Connector	Frequency band [MHz]
RX1250, Bluetooth	Integrated antenna	-	-	-

7.4.2 Receiver

Conformity to national regulations

- FCC Part 15 (applicable in US)
- Hereby, Leica Geosystems AG, declares that the Receiver is in compliance with the essential requirements and other relevant provisions of Directive 1999/5/EC. The declaration of conformity may be consulted at <http://www.leica-geosystems.com/ce>.



Class 1 equipment according European Directive 1999/5/EC (R&TTE) can be placed on the market and be put into service without restrictions in any EU Member state.

- The conformity for countries with other national regulations not covered by the FCC part 15 or European directive 1999/5/EC has to be approved prior to use and operation.

Frequency band

Type	Frequency band [MHz]
GX1210+	1575.42
GX1230+/GX1220+/GRX1200+	1227.60 1575.42

Type	Frequency band [MHz]
GX1230+ GNSS/GX1220+ GNSS/ GRX1200+ GNSS	1176.45 1191.795 1207.14 1227.60 1246.4375 - 1254.3 1575.42 1602.4375 - 1611.5

Output power

Type	Output power [mW]
Receiver	Receive only

Antenna

Type External GNSS antenna element (receive only)

7.4.3 GFU24, Siemens MC75

Conformity to national regulations

- FCC Part 15, 22 and 24 (applicable in US)
- Hereby, Leica Geosystems AG, declares that the GFU24 is in compliance with the essential requirements and other relevant provisions of Directive 1999/5/EC. The declaration of conformity may be consulted at <http://www.leica-geosystems.com/ce>.



Class 1 equipment according European Directive 1999/5/EC (R&TTE) can be placed on the market and be put into service without restrictions in any EU Member state.

- The conformity for countries with other national regulations not covered by the FCC part 15, 22 and 24 or European directive 1999/5/EC has to be approved prior to use and operation.

Frequency band

Quad-Band EGSM850 / EGSM900 / GSM1800 / GSM1900 MHz

Output power

EGSM850: 2 W
EGSM900: 2 W
GSM1800: 1 W
GSM1900: 1 W

Antennas

Type	GAT 3	GAT 5
Frequency band	900 or 1800 MHz	850 or 1900 MHz
Type	Detachable $\lambda/2$ antenna	Detachable $\lambda/2$ antenna
Gain	0 dBi	0 dBi
Connector	TNC	TNC

Specific Absorption Rate (SAR)

The product meets the limits for the maximum permissible exposure of the guidelines and standards which are force in this respect. The product must be used with the recommended antenna. A separation distance of at least 20 centimeters should be kept between the antenna and the body of the user or nearby person within the intended application.

7.4.4 GFU19 (US), GFU25 (CAN), GFU26 (US) CDMA MultiTech MTMMC-C

Conformity to national regulations

- FCC Part 15, 22 and 24 (applicable in US)
 - The conformity for countries with other national regulations not covered by the FCC part 15, 22 and 24 has to be approved prior to use and operation.
-

Frequency bandDual-Band CDMA850/CDMA1900 MHz

Output powerCDMA850: 2 W
CDMA1900: 0.4 W

Antenna

Type	GAT 5
Frequency band	850 or 1900 MHz
Type	Detachable $\lambda/2$ antenna
Gain	0 dBi
Connector	TNC

Specific Absorption Rate (SAR)

The product meets the limits for the maximum permissible exposure of the guidelines and standards which are force in this respect. The product must be used with the recommended antenna. A separation distance of at least 20 centimeters should be kept between the antenna and the body of the user or nearby person within the intended application.

8 International Limited Warranty, Software License Agreement

International Limited Warranty

This product is subject to the terms and conditions set out in the International Limited Warranty which you can download from the Leica Geosystems home page at <http://www.leica-geosystems.com/internationalwarranty> or collect from your Leica Geosystems distributor.

The foregoing warranty is exclusive and is in lieu of all other warranties, terms or conditions, express or implied, either in fact or by operation of law, statutory or otherwise, including warranties, terms or conditions of merchantability, fitness for a particular purpose, satisfactory quality and non-infringement, all of which are expressly disclaimed.

Software Licence Agreement

This product contains software that is preinstalled on the product, or that is supplied to you on a data carrier medium, or that can be downloaded by you online pursuant to prior authorization from Leica Geosystems. Such software is protected by copyright and other laws and its use is defined and regulated by the Leica Geosystems Software Licence Agreement, which covers aspects such as, but not limited to, Scope of the Licence, Warranty, Intellectual Property Rights, Limitation of Liability, Exclusion of other Assurances, Governing Law and Place of Jurisdiction. Please

make sure, that at any time you fully comply with the terms and conditions of the Leica Geosystems Software Licence Agreement.

Such agreement is provided together with all products and can also be referred to and downloaded at the Leica Geosystems home page at <http://www.leica-geosystems.com/swlicense> or collected from your Leica Geosystems dealer.

You must not install or use the software unless you have read and accepted the terms and conditions of the Leica Geosystems Software Licence Agreement. Installation or use of the software or any part thereof, is deemed to be an acceptance of all the terms and conditions of such licence agreement. If you do not agree to all or some of the terms of such licence agreement, you may not download, install or use the software and you must return the unused software together with its accompanying documentation and the purchase receipt to the dealer from whom you purchased the product within ten (10) days of purchase to obtain a full refund of the purchase price.

Index

A

AC, power supply unit	20
In Diagram	70
Accuracy	113
Antennas	123
Type	123
Used with receivers	13
Application program software	14
Area, icon	34
Attach, clip-on-housing	46

B

Battery	
Change in receiver	39
External, receiver	118
For internal power supply	20
Icon	34
Internal, receiver	118
RX1200	131
Baud rate	76
Bluetooth, icon	34

C

Capacity, memory	
Receiver	117
RX1200	130
Choicelist	30

Clip-on-housing		D	
Attach	46	Data bits	76
Detach	46	Data conversion	19
Commands, remote control	67	Data exchange	
Communication parameters		Between receiver and PC	14
Remote interface	76	Data storage	18
CompactFlash card	41	Reference station	66
Format	43	Data streaming, reference station	66
Icon	34	Detach, clip-on-housing	46
Insert	41	Device	
Memory device	18	Clip-on-housing	45
Remove	41	Status	51
Safety instructions	41	Dimensions	
Connector, antennas	124	Antennas	124
Container contents	22	Receivers	116
Conversion of data	19	RX1200	129
		Documentation	4
		Drive	
		OMNI	19
		PC card, on office computer	19

E

Electrical data, antennas	125
Environmental specifications	
Antenna	127
Receiver	119
RX1200	131
Equipment setup	36, 68
Event input	122
Exchange data	
Between receiver and PC	14
External power supply	20

F

Flashing LED on clip-on-housing	53
Flow control	76
Format CompactFlash card	43
Frequency band	
GFU19, MultiTech MTMMC-C	140
GFU24, Siemens MC45	138
GFU25, MultiTech MTMMC-C	140
GFU26, MultiTech MTMMC-C	140

G

GAT 3, antenna	139
GeoC++	17
GFU19	140
GFU24	138
GFU25	140
GFU26	140

H

Housing for devices	45
---------------------------	----

I

Icons	33
Indicators, LED for clip-on-housing	51
Insert	
CompactFlash card	41
SIM card	47
Interface	
Remote	76
User	26

Internal memory	18	Leica SmartWorx software on RX1250	
Icon	34	Access	28
Internal power supply	20	Activate	27
Internet online status, icon	33	Exit	28
K		Minimise	28
Keyboard	26	LGO	14
Keyboard, lock and unlock	26	Light Emitting Diode, clip-on-housing	51
L		Li-Ion battery	118
Labelling		Storage	83
RX1210	106	Line, icon	34
RX1250 X	106	Lock, keyboard	26
RX1250 Xc	106	M	
LED		Memory device, available	18
Clip-on-housing, description	52	Menu, select from	29
Housing	51	Mount, antennas	124
LEICA		MultiTech MTMMC-C	
Geo Office	10, 14	GFU19/GFU25/GFU26, technical data	140
GNSS Spider	10, 15	N	
		NiCd battery	118

O		Power	20
OFF button	24, 37	RX1200	131
OMNI drive	19	Power supply unit	
ON button	24, 37	AC, reference station setup	70
Operating times	118	Power, receivers	118
Operation		PPS output	120
GRX1200+/GRX1200+ GNSS	73	Q	
GX1200+	60	Quick coding, icon	35
Output power		R	
GFU19, MultiTech MTMMC-C	140	Raw data transfer to LGO	19
GFU24, Siemens MC75	138	Real-time device, icon	33
GFU25, MultiTech MTMMC-C	140	Real-time status, icon	33
GFU26, MultiTech MTMMC-C	140	Receiver components	24
P		Receivers	11
Parameters, remote interface	76	Recording	116
Parity	76	RX1200	130
PC card drive on office computer	19	Remote control	
Ports on RX1200	132	Commands	67
Position mode, icon	33	Reference station	74
Position status, icon	33	Remote interface	76

Remove		SIM card	
CompactFlash card	41	Insert	47
SIM card	49	Remove	49
RX1200		Software	
Operating GRX1200+/GRX1200+ GNSS	73	Application programs	17
With/without touch screen	4	Customised application programs	17
RX1200 technical data	129	Language	16
S		RX1200	17
Satellites		System	16
Icon, contributing	33	Type	16
Icon, visible	33	Upload	17
Select from menu	29	Specifications, environmental	110
Setup	36	Antennas	127
Reference station	68	Receiver	119
SHIFT	35	RX1200	131
Icon	35	Status, device	51
Siemens MC75		Stop bit	76
GFU24, technical data	138	Survey application program	55
		Switching, Leica SmartWorx software and Windows CE	27
		System software	14

T		Temperature range	
Technical data	110	Receiver, drying	84
Receiver	116	Time, operating	118
Temperature		Touch screen	26
Antenna		Tracking characteristics	110
Operating	127	Transfer raw data to LGO	19
Storage	127	U	
Battery internal		Uninterruptible Power Supply	21
Charging	38	Unlock, keyboard	26
Operating	119	Upload software	17
Storage	119	UPS	21
CompactFlash card		User interface	26
Operating	119		
Storage	119		
Receiver			
Operating	119		
Storage	119		
RX1200			
Operating	131		
Storage	131		

W

Weight

Antennas	124
Receiver	116
RX1200	129
Windows CE desktop, access	28
Windows CE, activate	27
Windows key symbol	28

Total Quality Management: Our commitment to total customer satisfaction.



Leica Geosystems AG, Heerbrugg, Switzerland, has been certified as being equipped with a quality system which meets the International Standards of Quality Management and Quality Systems (ISO standard 9001) and Environmental Management Systems (ISO standard 14001).

Ask your local Leica Geosystems dealer for more information about our TQM program.

Leica Geosystems AG

Heinrich-Wild-Strasse
CH-9435 Heerbrugg
Switzerland
Phone +41 71 727 31 31

www.leica-geosystems.com

- when it has to be **right**

Leica
Geosystems

Download from Www.Somanuals.com. All Manuals Search And Download.

Free Manuals Download Website

<http://myh66.com>

<http://usermanuals.us>

<http://www.somanuals.com>

<http://www.4manuals.cc>

<http://www.manual-lib.com>

<http://www.404manual.com>

<http://www.luxmanual.com>

<http://aubethermostatmanual.com>

Golf course search by state

<http://golfingnear.com>

Email search by domain

<http://emailbydomain.com>

Auto manuals search

<http://auto.somanuals.com>

TV manuals search

<http://tv.somanuals.com>