



Leica DM750 P Manual

Chapter overview

Safety regulations	4
The Leica DM750 P	15
Get Ready!	18
Get Set!	24
Go!	36
Care of the Microscope	38
Dimensions	42

Contents

Safety regulations	4	Get Set!	24
Safety concept	5	Basic setup	25
Symbols used in this operating manual	6	Using the Aperture Condenser	26
Important Notes	7	Setting up Polarized Light	27
Instructions on use	8	Focusing	29
Health risks and dangers of use	10	Viewing Tube Adjustment	30
Information for the person responsible for the instrument	11	Koehler Set up	31
Care instructions	12	Objective Centration	32
Accessories, maintenance and repair	13	Bertrand Lens Operation	34
Electrical data and ambient conditions	14	Time Delay Shutoff	35
The Leica DM750 P	15	Go!	36
Introduction	16	Ready! Set! Go!	37
Unpacking	17	Care of the Microscope	38
Get Ready!	18	General maintenance	39
Attaching Analyzer Module or Analyzer/ Bertrand Lens Module	19	Mechanical Maintenance	41
Viewing Tube	20	Dimensions	42
Installing Objectives	21		
Substage Condenser	22		

Safety regulations

Safety concept

The individual modules of the Leica DM microscopy series include an interactive CD-ROM with all relevant user manuals in several languages. Keep it in a safe place, and readily accessible to the user. User manuals and updates are also available for you to download and print from our web site at www.leica-microsystems.com.

This operating manual describes the special functions of the individual modules of the Leica DM microscopy series and contains important instructions for their operational safety, maintenance, and accessories.

The "Safety concept" booklet contains additional safety information regarding the service work, requirements and the handling of microscope, accessories and electrical accessories as well as general safety instructions.

You can combine individual system articles with articles from external suppliers. Please read the user manual and the safety requirements of the supplier.

Before installing, operating or using the instruments, read the user manuals listed above. In particular, please observe all safety instructions.

To maintain the unit in its original condition and to ensure safe operation, the user must follow the instructions and warnings contained in these user manuals.

Symbols used in this operating manual

Warning of a danger



This symbol indicates especially important information that must be read and complied with.

Failure to comply can cause the following:

- Hazards to personnel
- Functional disturbances or damaged instruments

Warning of hazardous electrical voltage



This symbol indicates especially important information that is mandatory to read and observe.

Failure to comply can cause the following:

- Hazards to personnel
- Functional disturbances or damaged instruments

Danger due to hot surface.



This symbol warns against touching accessible hot surfaces, e.g. those of light bulbs.

Important information



This symbol indicates additional information or explanations that intend to provide clarity.

Explanatory notes

- ▶ This symbol within the text points to additional information and explanations.

Important Notes

Description

The Leica DM750 P microscope meets today's state of the art of technology. Nevertheless, hazards may still arise during operation. The potential risks are described below.



Before installing, operating or using the instruments, it is required to read this user manual. In particular, please observe all safety instructions.

Contact address

*Leica Microsystems (Switzerland) Ltd.
Industry Division
Max Schmidheiny Strasse 201
CH-9435 Heerbrugg (Switzerland)*

User Manual

This user manual includes important instructions related to operating safety, maintenance and accessories,



Your Leica DM750 P microscope comes with an interactive CD-ROM with all relevant user manuals. Keep it in a safe place, and readily accessible to the user. User manuals and updates are also available for you to download and print from our web site at www.leica-microsystems.com

Accessories from third-party suppliers

You can combine individual system articles with articles from external suppliers. Please read the user manual and the safety requirements of the supplier.

Original condition

To maintain the unit in its original condition and to ensure safe operation, the user must follow the instructions and warnings contained in these user manuals.

Legal requirements

Adhere to general and local regulations relating to accident prevention and environmental protection.

EC Declaration of Conformity

Electrically operated accessories are constructed based on the state of the art of technology and are provided with an EC Declaration of Conformity.

Instructions on use

Intended use

The Leica DM750 P microscope is an optical instrument which uses magnification and illumination to improve the visibility of objects. It is used for observing and documenting.

The Leica DM750 P microscope may be used only in closed rooms and must be placed on a solid floor.

The Leica DM750 P microscope can be used in clean rooms without any problems.



Position the Leica DM750 P microscope so that it can be disconnected from the power supply at any time. The power cord must remain accessible at all times.

Place of use

Only use the instruments in closed, dust free rooms and between +10 °C and +40 °C. Protect the devices from oil, chemicals and extreme humidity. If using the devices outdoors, protect them from dust and moisture. Never use electrical devices outdoors. Install electrical devices at least 10 cm from the wall and away from flammable substances.

Avoid large temperature fluctuations, direct sunlight and vibrations. These conditions can distort measurements and micrographic images.



In warm and warm-damp climatic zones, the individual components require special care in order to prevent the build-up of fungus.

Non-intended use



Using the instrument in any way contrary to the specifications in the user manual can lead to bodily harm and damage to objects. Doing so can impair the functions of the protective measures provided.



Never install any other plug (NEMA 5-15P) or unscrew any mechanical components unless expressly instructed to do so in the instructions.



The devices and accessories described in this operating manual have been tested for safety and potential hazards.

Instructions on use (continued)



The responsible Leica affiliate must be consulted whenever the instrument is altered, modified or used in conjunction with non-Leica components that are outside of the scope of this manual.



Unauthorized alterations to the device or noncompliant use shall void all rights to any warranty claims.

Transport

If at all possible, use the original packaging for shipping or transporting individual modules.

In order to prevent damage from vibrations, disassemble all moving parts that (according to the user manual) can be assembled and disassembled by the customer and pack them separately.

Disposal

Disposal must comply with locally applicable laws and regulations.

Integration in third-party products

When installing Leica products into third-party products, the manufacturer of the complete system or its dealer is responsible for following all applicable safety instructions, laws and guidelines.

Health risks and dangers of use

Health risks



Workplaces with microscopes facilitate and improve the viewing task, but they also impose high demands on the eyes and holding muscles of the user. Depending on the duration of uninterrupted work, asthenopia and musculoskeletal problems may occur. For this reason, appropriate measures for reduction of the workload must be taken:

- Optimum workplace layout
- Frequent changes of activity
- Thorough training of the personnel, giving consideration to ergonomic and organizational aspects.

The ergonomic design and construction of the Leica microscopy series are intended to reduce the exertion of the user to a minimum.

Danger of infection



Direct contact with eyepieces is a potential transmission method for bacterial and viral infections of the eye.



The risk can be kept to a minimum by using personal eyepieces for each individual or detachable eyecups.

Dangers during use

- The Leica DM750 P microscope may only be connected to a grounded socket.
- The Leica DM750 P microscope may not be operated unless it is in proper functioning condition.

Information for the person responsible for the instrument

Information for the person responsible for the instrument

- Ensure that the Leica DM750 P microscope is used only by qualified personnel.
- Ensure that this user manual is always available at the Leica DM750 P microscope.
- Carry out regular inspections to make certain that the authorized users are adhering to safety requirements.
- When instructing new users, do so thoroughly and explain the meanings of the warning signs and messages.
- Assign individual responsibilities for starting, operating and servicing the instrument and monitor the observance of these responsibilities.
- Do not use the Leica DM750 P microscope unless it is in perfect condition.
- Inform your Leica representative or Leica Microsystems (Schweiz) AG, Industry Division, 9435 Heerbrugg, Switzerland, immediately of any product defect that could potentially cause injury or harm.
- If you use accessories made by third-party manufacturers with the Leica DM750 P microscope, be sure that each such manufacturer confirms the safety-engineering, harmless usability of the product and observe the product's user manual.
- Modifications and maintenance of the Leica DM750 P microscope may only be performed by professionals expressly authorized by Leica.
- Only original Leica replacement parts may be used in servicing the product.
- After service work or technical modifications, the unit must be reconfigured with observance to our technical requirements.
- If the unit is modified or serviced by unauthorized persons, is improperly maintained (as long as maintenance was not carried out by us), or is handled improperly, Leica will not accept any liability.
- The electric installation in the building must conform to the national standard, e.g. current-operated ground leakage protection (fault-current protection) is suggested.

Care instructions

General instructions

- Protect the Leica DM750 P microscope against damp, vapors, acids, alkalis, and corrosive substances. Do not store chemicals in the vicinity.
- Protect the Leica DM750 P microscope from oil and grease. Never grease or oil mechanical parts or sliding surfaces.
- Follow the instructions of the disinfectant manufacturer.
- It is advisable to enter a service agreement with Leica Service.

Cleaning coated parts and plastic parts

- Dust and dirt particles should be removed with a soft brush or lint-free cotton cloth.
- Remove coarse debris with a moistened disposable cloth.
- Clinging dirt can be removed using petroleum ether or alcohol
- Acetone, xylene or nitro-containing thinners must NOT be used.
- Never use chemicals to clean colored surfaces or accessories with rubberized parts. This could damage the surfaces, and specimens could be contaminated by abraded particles.

Cleaning glass surfaces

- Remove dust using a fine, dry and grease-free brush made from hair, by blowing with a squeeze blower, or by using a vacuum.
- Remove dirt using a clean cloth that has been moistened with distilled water.
- Remove tough dirt using alcohol, chloroform or petroleum ether.

Accessories, maintenance and repair

Accessories

Only the following accessories may be used with the Leica DM750 P microscope:

- The Leica accessories described in this user manual.
- Other accessories, provided that these have been expressly approved by Leica as being technically safe in this context.

Maintenance

- The Leica DM750 P microscope is basically maintenance-free. To ensure that it always operates safely and reliably, we recommend that you take the precaution of contacting the responsible service organization.



You can arrange for periodic inspections or, if appropriate, conclude a maintenance contract with them.

- It is advisable to enter a service agreement with Leica Service.
- For maintenance and repair, only OEM spare parts may be used.

Repairs and service work

- Only original Leica Microsystems spare parts may be used.
- Before opening the instruments, switch off the power and unplug the power cable.
- Avoid contact with powered electrical circuits, which can lead to injury.

Service address

In case of problems, please contact us as follows:

*Leica Microsystems (Switzerland) Ltd.
Industry Division
Max Schmidheiny Strasse 201
CH-9435 Heerbrugg (Switzerland)
Phone +41 71 726 33 28*

Electrical data and ambient conditions

Fuse Replacement



Unplug the instrument before changing any fuses. The Leica DM750 P has two fuses, which are located behind the power cord receptacle.



Use only fuse type: 5×20 mm, 1 Amp/250V, Quick acting (# 13RFAG30003)

Electrical data

Input: 100-240 V, 50/60 Hz, 5 W (3 W LED)

Environment

Temperature for use	+10 °C ... +40 °C
Storage temperature	-20 °C ... +52 °C +50 °F ... +104 °F
Manipulation shock	25 mm on 50 mm hard wood
Transport shock (unpacked)	100 g / 6 ms
Transport shock (packed)	800 mm free fall
Transport vibrations (unpacked)	5–200 Hz / 1.5 g
Atmospheric pressure "in use" and for storage:	500–1060 mBar
Humidity "in use" and for storage:	20–90%
Installation Category II (Overvoltage Category)	
Pollution degree 2	

The Leica DM750 P

Introduction

Thank you for purchasing the Leica DM750 P Polarizing Microscope System from Leica Microsystems. The Leica DM750 P is a highly adaptable instrument with superior optics and precision engineering for educational and basic industrial polarized light microscopy applications.

Unpacking

- Carefully remove the microscope and any components from the packing carton.
- Check the components against the planned configuration.
- Optional items such as contrast accessories, camera adapters, cameras, and carrying cases are not shipped as part of the standard equipment. These items are delivered in separate packages.
- Please do not discard any of the packing materials. They should be used for safely storing and transporting the instrument should the need arise.



Get Ready!

Attaching Analyzer Module or Analyzer/Bertrand Lens Module

Tools used

- Allen key



1. Slightly unscrew the set screw located on top of the stand with the Allen key tool provided.



2. Align the shape of the module with the shape of the microscope stand.



3. Insert the dovetail of the module into the stand. (Analyzer/Bertrand Lens Module shown).

4. Tighten the set screw to lock the module into place.



Viewing Tube

1. Slightly unscrew the set screw located on the top of the Analyzer module.



2. Align the shape of the polarizing viewing tube with the shape of the module.
3. Insert the dovetail of the polarizing viewing tube into the module and tighten the set screw firmly without forcing it. This precisely positions the body onto the optical axis of the microscope.



 Install the eyepiece with the crossline reticle into the right eyetube so that the raised feature on the eyepiece aligns and is seated with the orientation slot in the right eyetube.

4. Insert the eyepieces into the eyetubes.



5. If you wear eyeglasses for microscope viewing, keep the rubber eyeguards folded down. If you do not wear eyeglasses, you may find it useful to unfold the rubber eyeguards in order to block out ambient room light.



Installing Objectives

 If you have purchased a standard microscope configuration, you will notice the objectives are already installed on the nosepiece and the substage condenser is already installed on the stand. In this case, go to section "Operation". If you purchased your Leica DM750 P by components and not by standard configuration, please continue in this section.

 Always rotate the nosepiece by using the knurled nosepiece ring.

1. As you rotate the nosepiece clockwise, attach the objectives by screwing them into the nosepiece holes starting with the lowest magnification and advancing to the highest magnification.



Substage Condenser

Substage Condenser

 The Leica DM750 P has an open substage condenser mount. Therefore, the condenser needs to be installed.

1. Raise the stage to its highest position using the coarse focus knob on the right side of the microscope.



2. Adjust the condenser mount to its lowest position using the condenser focus knob on the left-hand side of the substage.



3. Swing the polarizer, which is connected to the bottom of the condenser mount, to the left.



Substage Condenser (cont.)

4. Completely loosen the two thumbscrews on the condenser mount.



5. Slide the substage condenser into the fork mount located underneath the stage by aligning the positioning pin on the condenser into the slot on the back of the fork.



6. Raise the condenser to its highest position using the condenser focus on the left-hand side of the substage

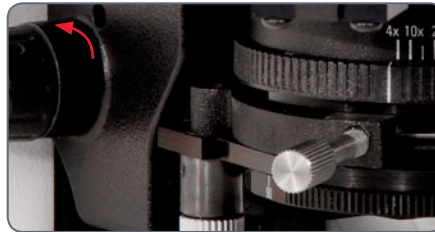

7. Tighten the thumbscrews to roughly center the substage condenser so that the top lens of the condenser is centered beneath the objective in use. You will more accurately center and focus the condenser when you reach section Koehler Setup.





Get Set!

Basic setup



As a safety precaution, the power cord has been grounded to the microscope base. Never use an adapter between the power cord and the power source; it will render the grounding feature ineffective.

Work Surface



Always use your microscope on a hard, stable surface.

Power

1. If the power cord is not already attached, attach it securely to the back of the microscope.



2. Plug the microscope power cord into a suitable grounded electrical outlet. A grounded 3-wire cord is provided.
3. Set the illumination control (knob is located on the bottom left-hand side of the microscope stand) to the lowest setting to start. The illumination control knob allows you to adjust the intensity of light produced by the illumination system.



4. Turn on the microscope using the switch on the bottom right-hand side of the microscope stand.

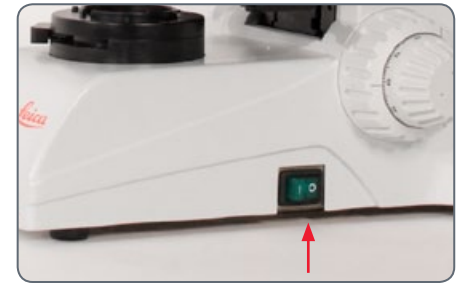

Using the Aperture Condenser

 The condenser is furnished with an iris diaphragm, which can be adjusted to match the effective numerical aperture of the objective.

1. To open and close this diaphragm, simply rotate the knurled condenser ring to the right or to the left so that the line on the rotating ring aligns with the objective magnification in use.
2. To start, fully open the iris diaphragm of the aperture condenser by rotating the ring to the extreme right.



Setting up Polarized Light

 The polarizer is located under the substage condenser in a swing in/out mount. Swing it into place and be sure it "clicks" into place.



1. Loosen the polarizer locking thumbscrew, which is located on the right-hand side of the polarizer.



2. Rotate the polarizer to the zero position.



Setting up Polarized Light (cont.)

 The Analyzer is located in the module between the viewing tube and the stand either in a slider module or in an Analyzer Bertrand Lens module. If you have a slider, slide the Analyzer into position.



3. If you have an Analyzer/Bertrand Lens module, swing in the Analyzer by flipping the lower rocker of the module to the right (the "A" position/Analyzer in), while ensuring the upper rocker of the Analyzer/Bertrand Lens Module is flipped to the left (the "O" position/Bertrand Lens out).



4. Increase the illumination intensity slightly. You will notice while looking into the microscope with the Polarizer and Analyzer in place and no specimen, that the field will look dark. If not, rotate the polarizer slightly until you have the darkest field of view.

Focusing

Focusing

1. Place a polarized light specimen on the stage.
2. Rotate the 10× objective into working position.
3. Raise the microscope stage using the coarse adjustment knob until you reach its positive stop or the specimen touches the objective.
4. Look into the eyepieces and adjust the illumination intensity so that it is comfortable for viewing.
5. Using the fine focus adjustment knob, bring the specimen into sharp focus.

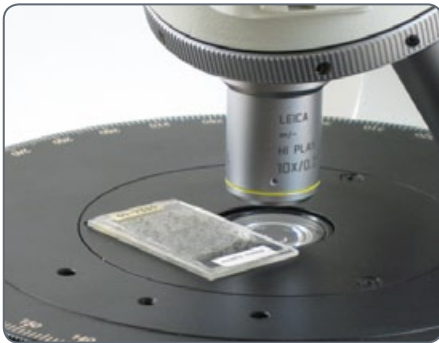

Viewing Tube Adjustment

Adjust the eyetubes for your interpupillary distance.

1. Fold or unfold the eyetubes until you see one illuminated circle.



i The viewing tubes maintain a constant tube length for all interpupillary settings. This means that a change of interpupillary distance does not affect parfocality, magnification, or calibrations that depend on magnification.

! To correctly set the eyepieces, be sure the crosshair eyepiece is seated securely in the slot of the right eyetube.

2. Focus the crosshair reticle by gripping the knurl and rotating the top of the eyepiece until the reticle is in clear focus.
3. While looking through only the crosshair eyepiece, bring the specimen into focus with the fine focus of the microscope.



i It may help to cover your left eye.

4. Now switch to look only through the other eyepiece (focusing eyepiece without crosshair) with the other eye.



This time, focus the specimen by using the focusing capability in the focusing eyepiece. Do not raise or lower the stage to focus!

5. Grip the knurl on the focusing eyepiece with one hand and rotate the top of the eyepiece with the other hand until the specimen is in focus with this eye and this focusing eyepiece. This corrects for any vision differences between your right eye and left eye.
6. Now switch to a high magnification objective (not an oil objective) and focus the microscope while viewing with both eyes.



The higher magnifications have a shallower depth of field. Therefore, after focusing with a high magnification, you will find that when you change to a lower magnification, you only have to adjust the fine focus slightly, if at all.

Koehler Set up

Koehler Set up

1. Close the Koehler field diaphragm on the base of the microscope so that its iris leaves are present within the field of view when looking into the eyepieces.

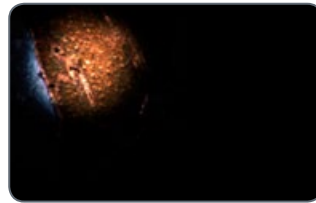

3. Turn the condenser centering thumbscrews simultaneously to center the image of the field diaphragm in the field of view.



2. Use the condenser focus knob on the left-hand side of the substage to bring the leaves of the field diaphragm into sharp focus.

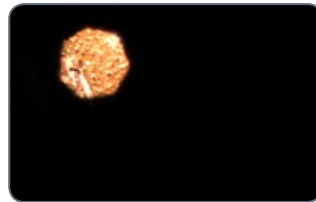

4. Open the field diaphragm until the iris leaves disappear just beyond the field of view.

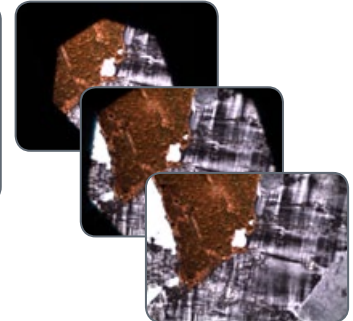

Objective Centration

Tools used

- Centering keys



1. Retrieve the two centering keys from the packaging and insert the centering tools into the centering holes located above the objective in use. Engage the ball end of the centering tools into the set screws, which are hidden in the centering holes.



2. Focus the polarizing sample.
3. Move a noticeable point of the sample to the center of the crosslines.

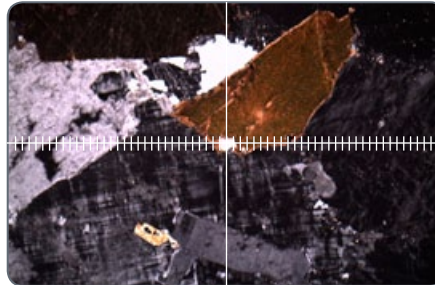

4. Loosen the stage brake and rotate the stage until the noticeable point of the sample is furthest away from the center of the crosslines. This may even be outside of the field of view. This indicates the objective is not centered to the stage.

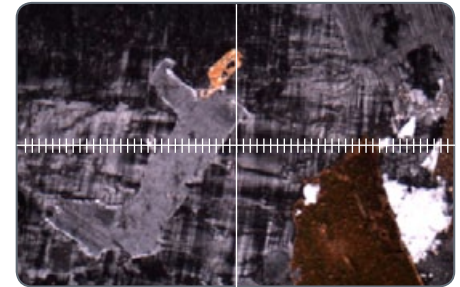

Objective Centration (cont.)

- Adjust the objective centering screws until the noticeable point of the sample is midway between the furthest position and the center of the crosslines. This moves the objective center closer to the stage center.

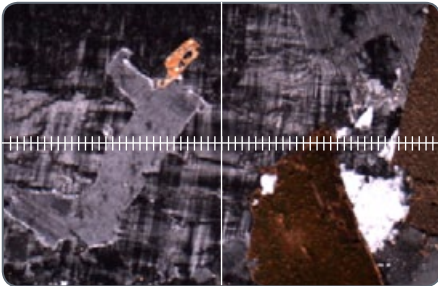

- Move the specimen (not the objective centering screws!) so that the noticeable point is at the center of the crosslines once again.

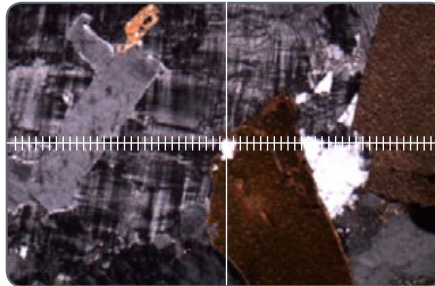

- Check to make sure that the noticeable point stays at the center of the crosslines when the stage is rotated. If not, repeat the centering process.

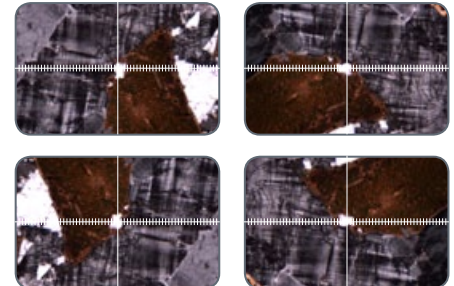

 Each objective must be centered separately. Also, there is a magnetic storage location for the objective centering tools in the back of the Analyzer or Analyzer/Bertrand Lens modules.

Bertrand Lens Operation

 If you have an Analyzer/Bertrand Lens module, you can view a conoscopic image through the eyepieces.

1. Bring the portion of the specimen you would like to view in conoscopy (with the Bertrand Lens) to the center of the field
2. Swing in the Bertrand Lens by flipping the upper rocker of the Analyzer/Bertrand Lens module to the "B" position. Be sure the Polarizer and Analyzer are also in position.



 You can now view the conoscopic image through the eyepieces.

3. If necessary, you can fine tune the Bertrand Lens centration with the tools provided.

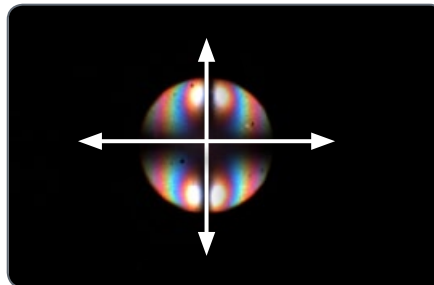

4. If you have an Analyzer/Bertrand Lens with a focusable Bertrand Lens, you can now turn the knob on the upper rocker to focus the Bertrand Lens image.



Time Delay Shutoff

 The Leica DM 750 P is equipped with a time delay shutoff capability, which automatically turns the illumination off after 2 hours of no changes in the intensity control.

- The time delay shutoff IS enabled as a default.

Changing the status of the time delay shutoff

1. Rotate the intensity control to the lowest setting.
2. Turn the power on.
3. Rotate the intensity control to full high intensity, then back to full low intensity all within 5 seconds.



- The LED Illumination will flash to indicate the time delay shutoff status was changed.
- The LED Illumination will flash two times slowly then stay on when you disable the Time Delay Shutoff.
- The LED Illumination will flash three times quickly then stay on when you enable the Time Delay Shutoff.

 When you turn the power off and then turn the power on again, the system will be in the last Time Delay Shutoff status (Enabled or Disabled) and you will not see any blinking.



Go!

Ready! Set! Go!

Now all you need to do is change objectives, set the aperture condenser and field diaphragm appropriately for the objective magnification in use, and enjoy the view!

Care of the Microscope

General maintenance

General



Always carry the microscope using two hands. There is a handle on the back of the microscope and an undercut in the front for this purpose.



- The cord wrap allows you to wrap the cord in such a way that only the length you need is extended.



- Proper storage of accessories in the appropriate positions is important to keep them safe from loss or damage. There are storage places for the objective centering tools and for two compensators in the rear of the Analyzer/Bertrand Lens module.



General maintenance (cont.)

- Keeping all optical components clean is important for maintaining good optical performance.
- The microscope should always be covered with the plastic dust cover (provided with the instrument) when it is not in use.
- If any optical surface becomes coated with dust or dirt, clean the surface by blowing it off with a syringe or brushing it off with a camel hair brush before attempting to wipe the surface clean.
- Optical surfaces should be cleaned with a lint-free cloth, lens tissue or a cotton swab moistened with methanol or commercially available glass cleaner. Do not use alcohol.
- It is very important to avoid the excessive use of solvent, so use them sparingly. The lint-free cloth, lens tissue or cotton swab should be moistened with solvent, but not be wet enough for the solvent to seep around the lens.
- No part of the microscope is quite so vulnerable to collecting dirt, dust, and oil as the front lens of the objective. Whenever you encounter lack of contrast, cloudiness or poor definition, carefully check the condition of the front lens with a magnifier.
- The lower magnification objectives have fairly large front lenses and can be cleaned with a cloth or lens tissue wrapped around a finger and moistened with methanol. Do not use alcohol.
- Cleaning 40× and 100× objectives requires more care. Note: To achieve the high degree of flatness obtained with the higher magnification objectives, the objective has a small concave front lens of fairly short radius or curvature. The surface of this front lens can be readily cleaned with a toothpick covered with a cotton tip, or with a small cotton swab. Moisten the cotton with methanol and squeeze it almost dry. Wipe the front lens lightly without applying undue force or scrubbing action. Make sure that the cotton tip contacts the concave lens surface. Check the objective with a magnifier after cleaning.
- If you need to remove the microscope's viewing body, be careful not to accidentally touch the outer lens surface (located on the underside of the body). Fingerprints on this surface will reduce image clarity. This lens can be cleaned in the same manner as objectives and eyepieces.

Mechanical Maintenance

Mechanical Maintenance

- Use the dust cover. It is the most important way to keep the microscope in good mechanical and physical condition.
- The Leica DM750 P has a durable finish. All non-optical parts of the instrument can be cleaned with methanol, naphtha, or soap and water. Avoid the use of all other organic solvents when cleaning the instrument.

Dimensions

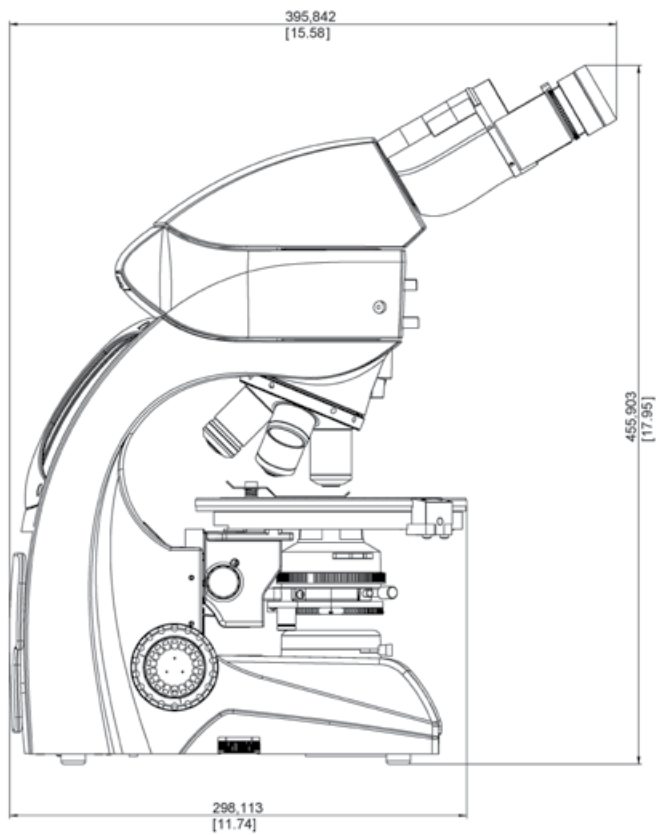
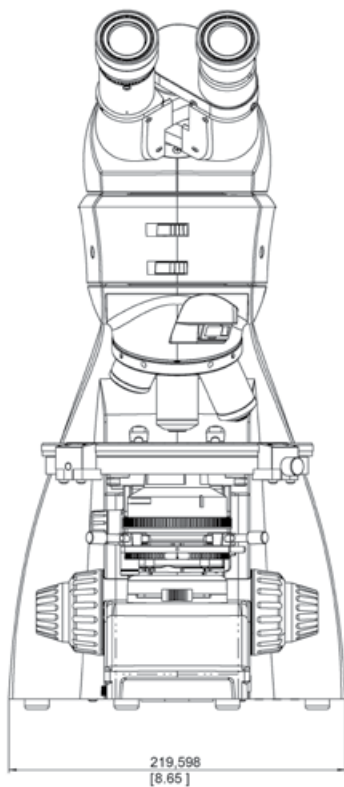

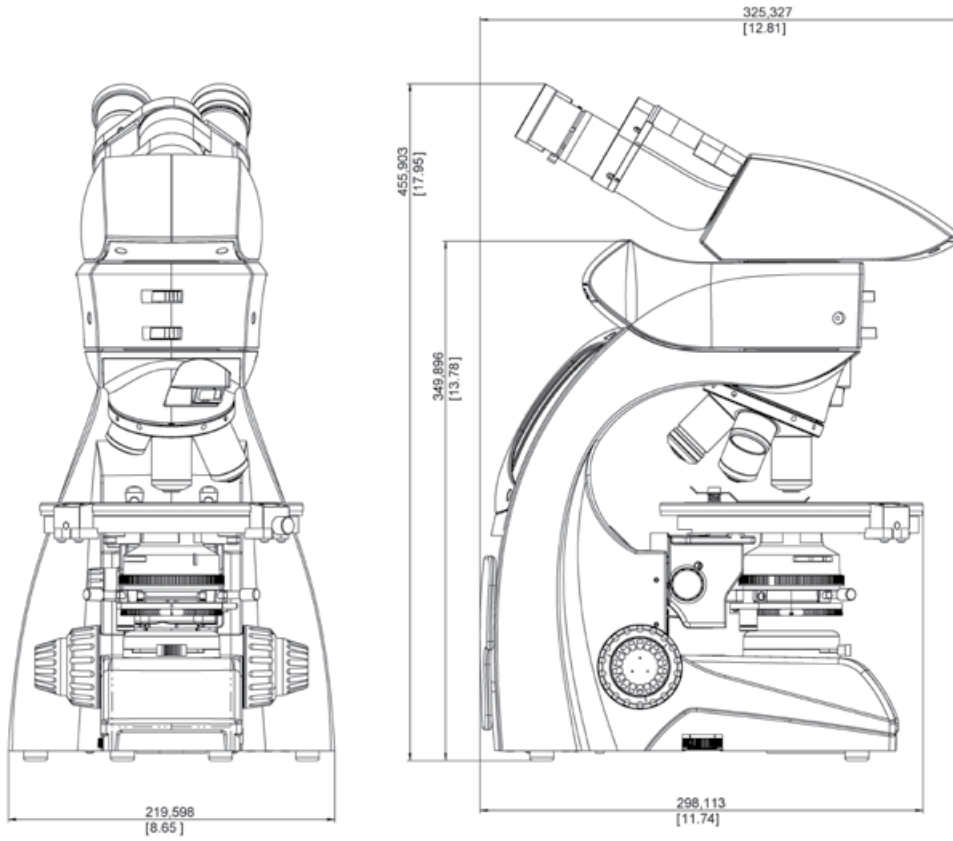

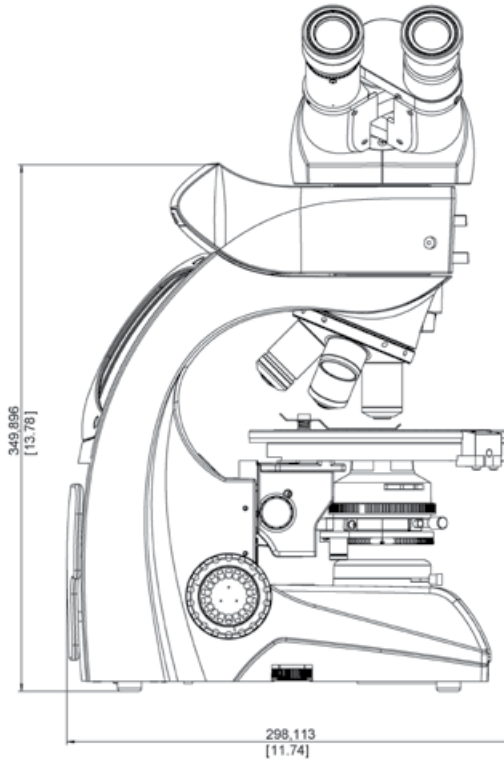
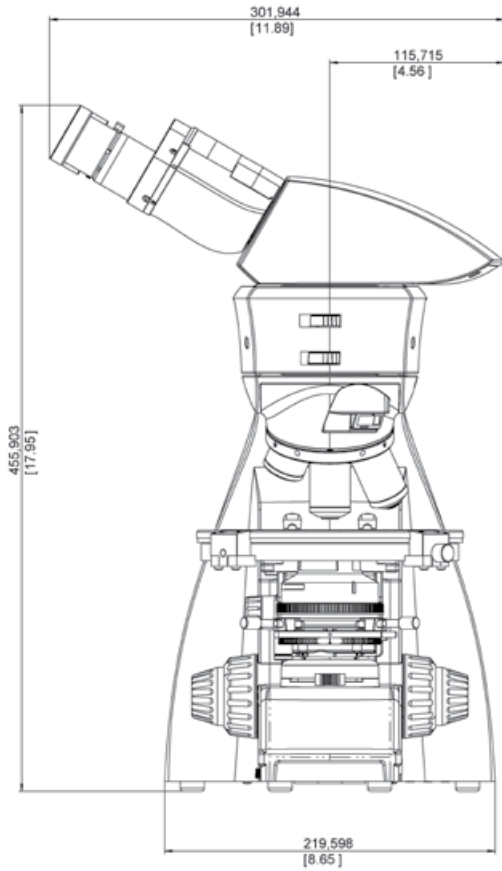

Free Manuals Download Website

<http://myh66.com>

<http://usermanuals.us>

<http://www.somanuals.com>

<http://www.4manuals.cc>

<http://www.manual-lib.com>

<http://www.404manual.com>

<http://www.luxmanual.com>

<http://aubethermostatmanual.com>

Golf course search by state

<http://golfingnear.com>

Email search by domain

<http://emailbydomain.com>

Auto manuals search

<http://auto.somanuals.com>

TV manuals search

<http://tv.somanuals.com>