



Leica CM1950

Cryostat

CE

Operating Manual

Leica CM1950, V 1.1 English – 05/2007

Always keep this manual near the instrument.

Read carefully prior to working with the instrument!

Leica

MICROSYSTEMS

1. NOTE

The information, numerical data, notes and value judgments contained in this manual represent the current state of scientific knowledge and state-of-the-art technology as we understand it following thorough investigation in this field. We are under no obligation to update the present manual periodically and on an ongoing basis according to the latest technical developments, nor to provide our customers with additional copies, updates etc. of this manual.

For erroneous statements, drawings, technical illustrations etc. contained in this manual we exclude liability as far as permissible according to the national legal system applicable in each individual case. In particular, no liability whatsoever is accepted for any financial loss or consequential damage caused by or related to compliance with statements or other information in this manual.

Statements, drawings, illustrations and other information as regards contents or technical details of the present manual are not to be considered as warranted characteristics of our products.

These are determined only by the contract provisions agreed between ourselves and our customers.

Leica reserves the right to change technical specifications as well as manufacturing processes without prior notice. Only in this way is it possible to continuously improve the technology and manufacturing techniques used in our products.

This document is protected under copyright laws. All copyrights to this documentation are held by Leica Biosystems Nussloch GmbH.

Any reproduction of text and illustrations (or of any parts thereof) by means of print, photocopy, microfiche, web cam or other methods – including any electronic systems and media – requires express prior permission in writing by Leica Biosystems Nussloch GmbH.

For the instrument serial number and year of manufacture, please refer to the name plate at the back of the instrument.

© Leica Biosystems Nussloch GmbH

The Leica logo is written in a stylized, red, cursive font.

MICROSYSTEMS

Published by:

Leica Biosystems Nussloch GmbH

Heidelberger Str. 17 - 19

D-69226 Nussloch

Germany

Phone: +49 (6224) 143-0

Fax: +49 (6224) 143-200

eMail: histo_info@leica-microsystems.com

Internet: <http://www.histo-solutions.com>

Table of contents

1.	Important Information	6
1.1	Symbols Used in This Manual and Their Meaning	6
1.2	Qualification of Personnel.....	6
1.3	Designated Use.....	6
1.4	Instrument Type	6
2.	Safety and Design	7
2.1	General Safety Instructions	7
2.2	Unpacking and Installation	7
2.3	Safety Features	10
2.4	Securing/Locking the Handwheel	11
2.5	Cleaning, Disinfection – Turning the Instrument Back On	12
2.6	Handling Specimens – Defrosting	13
2.7	Removal of the Microtome	13
2.8	Maintenance	13
3.	Technical Data	14
4.	Standard Delivery	16
5.	General Overview	18
5.1	Control Panel Fields and Cryostat Chamber	19
6.	Installation	20
6.1	Site Requirements	20
6.2	Transport to the Site	21
6.3	Assembling the Handwheel, Centering the Handwheel (Optional)	22
6.3.1	Locking/Unlocking the Handwheel	23
6.3.2	Installing the Footswitch Dummy (Instruments with Cutting Motor)	23
6.4	Connection to Power Supply System	24
6.5	Installing Accessories/Inserting Chamber Accessories	25
6.5.1	Installing the Adjustable Footrest (Optional)	25
6.5.2	Installing the Storage Systems (Optional)	26
6.5.4	Inserting the Section Waste Tray	26
6.5.3	Shelf, Movable (Optional)	26
6.5.5	Installing the Heat Conductor Block, Stationary (Optional)	27
6.5.6	Installing the Knife/Blade Holder and Adjusting the Clearance Angle	27

7.	Instrument Controls	30
7.1	Control Panel Fields on the CM1950 – Control Panel Field 1	30
	Control Panel Field 2 – Electric Coarse Feed, Sectioning and Trimming Thickness Display	32
	Control panel 3 – Motorized sectioning (optional)	34
8.	Working with the Instrument	36
8.1	Preparing Cutting Tools, Specimen Discs and Preparation Aids	36
8.2	Turning the Instrument On	36
8.3	Configuring the Parameters	37
8.4	Working with the Precooled Cryostat	42
8.4.1	Preparatory Work	42
8.4.2	Trimming with Extraction – Anti-roll Guide Installed	43
8.4.3	Cutting with Extraction – Anti-roll Guide Installed	45
9.	Troubleshooting	48
9.1	Problems During Work	48
10.	Temperature Selection Chart (in minus °C)	52
11.	Optional Accessories	53
11.1	Ordering Information	53
12.	Maintenance and Cleaning	66
12.1	General Maintenance	66
12.2	Changing Fuses	67
12.3	Replacement of the Lamp/UVC Lamp	68
13.	Decontamination Certificate (master)	70
14.	EC Declaration of Conformity	72
15.	Warranty and Service	73
16.	Peoples Republic of China	74

1. Important Information

1.1 Symbols Used in This Manual and Their Meaning



Warnings appear in a gray box and are marked by a warning  triangle.



Notes i.e. important user information appear in a gray box and are marked by an information  symbol.



Caution – UVC radiation!

(5)
(Fig.5) Figures in brackets refer to item numbers in drawings or to the drawings themselves.

1.2 Qualification of Personnel

The Leica CM1950 may be operated by trained laboratory personnel only.

All laboratory personnel designated to operate the instrument must carefully read the present instruction manual prior to starting work with the instrument.



Despite chemical and/or UV-light disinfection, personal safety precautions as per the applicable laboratory regulations must still be taken (i.e. safety goggles, gloves, laboratory coat and mask must be worn). This type of disinfection reduces the number of germs by at least 99.99%.

1.3 Designated Use

The CM1950 is a high-performance cryostat with an encapsulated microtome and separate specimen cooling. It features a UV disinfection system, an (optional) integrated extraction system for section waste and an (optional) motor for motorized sectioning.

The cryostat is designed to produce frozen sections for biological, medical and industrial applications.

The CM1950 is suitable for in-vitro diagnostic (IVD) applications.

The instrument may only be operated within the scope of its designated use as described above and as per the instructions given in this manual.

Any other use of this instrument is considered as improper operation.

1.4 Instrument Type

All information given in this instruction manual applies only to the instrument type indicated on the title page.

A name plate, indicating the instrument serial number, is attached to the back of the instrument.



Fig. 1

2.1 General Safety Instructions

The CM1950 is a cryostat with an encapsulated microtome and separate specimen cooling. It is primarily used for work in the area of fast-cut diagnostics. The displays and instrument controls are easy to operate due to their largely self-explanatory symbols. LED displays make it easy to read. The cryochamber is made of seamlessly welded, high-quality stainless steel that is free of difficult-to-access corners and thus easy to clean and disinfect. This instrument has been built and tested in accordance with the following safety regulations on electrical measuring, control, regulating and laboratory devices. In order to maintain this condition and to ensure safe operation, the operator must observe the instructions and warnings contained in this instruction manual.

For current information about applicable standards, please refer to the CE declaration of conformity on our Internet site:

www.histo-solutions.com

2.2 Unpacking and Installation

- To ensure proper function of the instrument, it must be set up with a minimum distance on all sides from walls and furniture (see 'Site Requirements', p. 20)
- The instrument may only be transported in an upright or slightly inclined position.
- To ensure a safe transport with a fork lift 3 people are required: one operating the fork lift, and the other 2 holding the instrument on either side to prevent it from sliding down.
- Before connecting to the power supply system, please check if the local voltage complies with the power rating specified on the name plate of the instrument (see also 'Technical data')!
- Never connect the instrument to a power socket that does not have a protective conductor terminal.

Length of power cable: up to 3.5 m

extension possible: **no**



After transporting, wait at least 4 hours before turning the instrument on. This waiting period is necessary to allow the compressor oil, which may have been displaced during transport, to return into its original position. Any condensation on electrical parts that has formed due to temperature differences during transport must be allowed to dry completely. Failure to comply with this can cause severe damage to the instrument!

2. Safety and Design



Fig. 2



When the instrument is delivered, check the tilt indicators on the packaging.
If the arrowhead is blue, the shipment was transported laying flat, was tilted at too great an angle or fell over during transport.
Note this on the shipping documents and check the shipment for possible damage.

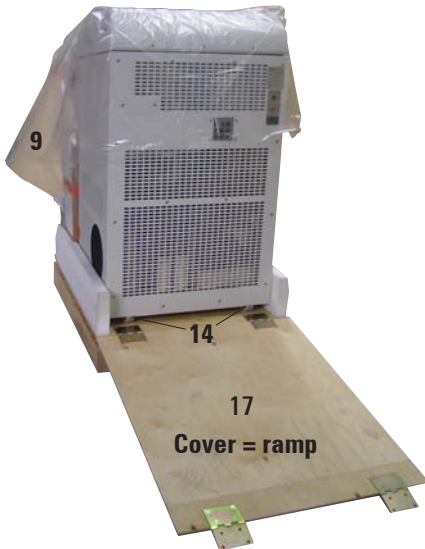

Fig. 3

Opening the packaging

1. Remove the 3 screws (1) on each of the two sides of the box (7) at the top.
2. Remove the 2 screws on each of the 4 hinges (2) on the front and rear side of the box.



Do NOT remove the screws of the hinges on the top lid!

3. Remove 1 screw (3) between the two hinges on the front and rear side of the box.
4. Remove the 3 screws (4) at the bottom on all four sides of the box.
5. Of the two vertical rows of screws (5), remove one on either side (which side does not matter) entirely.

Removing the packaging



Fig. 4

1. Remove the cover (17) and place it on the floor with the foam parts facing downwards. - The cover will be used as a ramp later.
2. Remove the 4 foam parts (6) by pulling them upwards.
3. Open the box (7) on its side hinges like an accordion partition and remove it.
4. Remove the accessories carton (8) and operating manual on the front of the instrument.
5. Pull off the dust cover (9) by pulling upwards.
6. Take off the foam strip (10) on the bottom rear.

Ramp assembly



Fig. 5

1. After the foam strip (10) is removed, 2 screws (12) are visible on the baseplate.
2. Swing out the cover hinges (2) at the front and rear.
3. Attach the cover (17) from the **rear** on the transport pallet (11). The notches (13) of the hinges (2) must be pointing towards the instrument.
4. Move the cover towards the left so that the notches (13) of the hinges slide beneath the heads of the screws (12).

Transport to the Installation Location

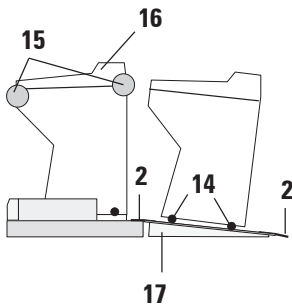

Fig. 6



The instrument must be transported in an upright position.

The cover (17) now forms a ramp on which the instrument can now be rolled down off the transport pallet.



Do not push the device by its hood (16). Use the transport grip points (15 ○). The rollers (14) must run over the cover hinges (2) at the front and rear. Danger of tipping!

1. Carefully roll the instrument backwards from the pallet.
2. Push the instrument to the installation location on the castors (14).

2. Safety and Design

2.3 Safety Features

The instruction manual includes important information related to the operating safety and maintenance of the instrument.

The Operating Manual is an important part of the product, and must be read carefully **before** startup and use and must always be kept near the instrument. If additional requirements on accident prevention and environmental protection apply in the country of operation, this Operating Manual must be supplemented by appropriate instructions to ensure compliance with such requirements.

The instrument is equipped with the following safety devices: an emergency stop switch (motorized instruments only), a handwheel lock and centering system (motorized instruments only), knife guard on the blade and knife holder, and a blade ejector.



To prevent adverse health effects from UV radiation, the UV disinfection cycle can be started only after the sliding window has been properly closed. Closing the window activates the corresponding safety features.

The consistent use of these safety features and strict observation of the warnings and cautions in this manual, will safeguard the operator from accidents and/or personal injury to a great extent.

Microtome knives

- Take care when handling microtome knives/disposable blades. The cutting edge is extremely sharp and can cause severe injury!
- Never leave knives and dismantled knife holders with a knife/blade mounted lying around!
- Do not place a knife on a table with the cutting edge facing upwards!



We strongly recommend using the safety gloves included with the standard delivery!

- **Never** try to catch a falling knife!
- Prior to manipulating the knife and specimen or changing the specimen, always lock the handwheel and cover the cutting edge with the knife guard!
- Avoid contact with cold parts of the instrument as this can cause frostbite!

Knife guard



Prior to manipulating the knife and specimen, changing the specimen or knife, or taking a break, always lock the handwheel and cover the cutting edge with the knife guard.

The CE, CN and CN-Z knife holders feature knife guards; the glass anti-roll plate of the CE knife holder also serves as a knife guard.

2.4 Securing/Locking the Handwheel

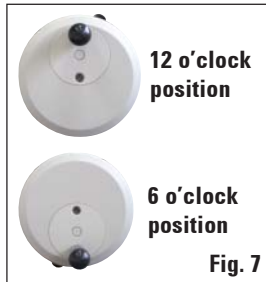

Always lock the handwheel and cover the cutting edge with the knife guard prior to manipulating the knife or specimen, changing the specimen, or taking a break.

To lock the handwheel, press the lever (1) outward. Continue turning the handwheel slowly until the grip is in the upper or lower position and the handwheel is locked. Press the lever fully outward; gently rock the handwheel until the locking mechanism clicks into place noticeably.

To release the handwheel, press the lever (2) on the handwheel toward the cryostat housing.

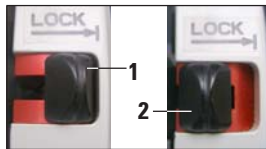

Fig. 8

Centering of the handwheel (motorized instruments only)

Pull out the handwheel's handle and position it in the middle of the handwheel. The handle automatically engages in this position.



Fig. 9



An important safety device on the cryostat is the centering of the handwheel for motorized instruments.



Rotate the handwheel only if the refrigeration system is on and the cryochamber is cold.

2. Safety and Design

2.5 Cleaning, Disinfection – Turning the Instrument Back On



It is not necessary to remove the microtome for disinfection.

- The instrument has been designed for UV disinfection! Spray disinfection with Leica Cryofect is also possible, thanks to the special insulation of the microtome. (Cryofect is not available in all countries!)



Remove section waste after EVERY sectioning operation and BEFORE changing specimens. Remove the section waste using a paper towel soaked in Cryofect or an alcohol-based disinfectant) or remove the waste using the extraction nozzle (optional). Do not start the disinfection until after folding the section stretcher to the side! Each new specimen is a potential source of contamination.

- When disinfecting the instrument, take appropriate protective measures (gloves, mask, protective clothing, etc.).
- When using detergents and disinfectants please comply with the safety precautions of the disinfectant manufacturer.
- The integrated glass anti-roll guide of the blade holder CE, CN and CN-Z can be cleaned either with acetone or alcohol.
- Dispose of waste liquid according to the waste disposal regulations!
- Do not use external heaters for drying the cryochamber. This can cause damage to the cooling system!
- Do not turn the instrument on before the cryochamber is completely dry! Frost formation!
- All components removed from the cryostat must be carefully dried before returning them to the cryochamber!
- The front panel and the slit cover of the microtome must be completely dry before turning on the instrument!



For more detailed information about disinfection, visit the Leica Microsystems website at

www.histo-solutions.com

2.6 Handling Specimens – Defrosting

- When working with contaminated or infected material, the general safety guidelines for laboratories must be applied.
- Before defrosting the cryochamber remove all samples!
- Before defrosting the specimen head, remove all samples!



Never leave samples in the cryochamber! - The instrument is not suitable for storing frozen specimens, as the refrigeration dehydrates the specimens!



The quick freeze shelf can become very hot during the defrosting process. Do not touch it during defrosting.

2.7 Removal of the Microtome

- The microtome is encapsulated and therefore does not require removal by the user.

2.8 Maintenance

Replacing the fuses

- Turn the instrument off and disconnect the power plug before replacing the fuses.
- Use only the fuse types specified in chapter 3, "Technical Data." Failure to comply with this can cause severe damage to the instrument!

Replacing the fluorescent lamp/UVC lamp

- Turn the instrument off and disconnect the power plug before replacing the lamps.



It is possible to break the UVC lamp during replacement. If this happens, the lamp change must be completed by Technical Service. If any metallic mercury is released, handle it carefully and dispose of it properly.



If both disinfection indicator lights are blinking alternately, the UV tube must be replaced!

3. Technical Data



All specifications related to temperature are valid only up to an ambient temperature of 18 °C to 35 °C and a relative humidity of no more than 60%.

Type	-1	-2	-3
Nominal voltage (±10 %)	100 V AC	120 V AC	230 V AC
Nominal frequency	50/60 Hz	60 Hz	50 Hz
Power draw	1900 VA	1900 VA	1900 VA
Max. start-up current for 5 sec.	35 A eff.	35 A eff.	25 A eff.
Protective class	I	I	I
Circuit breaker: (MDA made by Schurter)	15A M3	15A M3	15A M3
Pollution degree ^②	2	2	2
Overvoltage installation category	II	II	II
Heat emission (max.)	1900 J/s	1900 J/s	1900 J/s
Approval	CE/c_CSA_us	CE/c_CSA_us	CE/c_CSA_us

② according to IEC-1010; UL 3101

Microtome

Type:	Rotary microtome, encapsulated
Section thickness range	1 to 100 µm
Trimming range:	
Clinic	10 - 40 µm ^③
Research	1 - 600 µm ^③
Total specimen feed	25 mm + 1 mm
Vertical stroke	59 mm ±0.5 mm
Specimen retraction	20 µm (can be deactivated)
Maximum specimen size	50 x 80 mm
Cutting speed	Slow: 0-50 strokes/min Fast: 0-85 strokes/min Vmax: 85-90 strokes/min
Specimen orientation	8° (x, y-axis)

③ For additional details, see p. 32

Electric coarse feed

Slow	300 µm/s
Fast	900 µm/s



For "Site Requirements," refer to item 6.1 (page 20).

Lamp

50/60 Hz-Version: Osram DULUX L 18W/840

Cryostat

Dimensions:	
Width (w/o handwheel)	700 mm
Width (with handwheel)	835 mm
Depth (cabinet only)	850 mm
Height (total)	1215 mm
Working height (armrest)	1025 mm
Weight:	
Weight (w/motor and suct.)	193 kg
Weight (w/motor, w/o suct.)	185 kg
Weight (w/o motor, w/ suct.)	183 kg
Weight (w/o motor, w/o suct.)	175 kg
Weight (w/ specimen head cool.)	165 kg
Weight (w/o specimen head cool.)	145 kg

General information

Operating temperature range:	18 °C to 35 °C
Temperature range during storage:	+5 °C to +55 °C
Relative humidity:	max. 60 %, non-condensing
Storage humidity:	< 60 %

Refrigeration system	CM1950, 50 Hz	CM1950, 60 Hz
Cryochamber		
Temperature range	0 °C to -35 °C ± 5 K, adjustable in 1K increments, at ambient temperature of 20 °C	0 °C to -35 °C ± 5 K, adjustable in 1K increments ambient temperature of 20 °C
Cooling time to -25 °C	approx. 5 h	approx. 5 h
Cooling time to -35 °C	approx. 8 h	approx. 8 h
Refrigeration capacity ①	690 W	690 W
Cut-out pressure	25 bar	25 bar
Safety factor	3	3
Refrigerant*	300 g (± 5 g) refrigerant R -404A*	300 g (± 5 g) refrigerant R -404A*
Compressor oil*	0.6 l EMKARATE RL22S, ICI*	0.6 l EMKARATE RL22S, ICI*
Defrosting of cryochamber		
Automatic defrosting		
Programmable:	Yes (hot gas defrost) Selectable time	Yes (hot gas defrost) Selectable time
Defrosting intervals	1 defrost in 24 h or manual hot gas defrost	1 defrost in 24 h or manual hot gas defrost
Defrost time:	12 minutes	12 minutes
Automatic shutoff Defrost:	at -5 °C chamber temperature	at -5 °C chamber temperature
Quick-freeze shelf		
Minimum temperature:	- 42 °C (+ 5 K), at chamber temp. -35 °C	- 42 °C (+ 5 K), at chamber temp. -35 °C
Number of freezing stations:	15+2	15+2
Defrost	Manual hot-gas defrost	Manual hot-gas defrost
Peltier element		
Number of freezing stations:	2	2
Max. temperature difference:	17 K, at chamber temp. of -35 °C	17 K, at chamber temp. of -35 °C
Specimen cooling		
Temperature range	-10 to -50 °C ± 3 K	-10 to -50 °C ± 3 K
Refrigeration capacity①	320 W	320 W
Cut-out pressure	25 bar	25 bar
Safety factor	3	3
Refrigerant and quantity	at 230V/50 Hz 140 g (± 5 g), refrigerant R-404A* at 100V/50/60 Hz 110 g (± 5 g), refrigerant R-404A*	at 120V/60 Hz 110 g (± 5 g), refrigerant R-404A*
Compressor oil*	0.4 l alpha 22, Kyodo*	0.4 l alpha 22, Kyodo*
Defrosting of specimen head		
Automatic defrost:	No	No
Manual defrost		
Defrost time	15 min.	15 min.



***) Refrigerant and compressor oil must be replaced by qualified, authorized service personnel only.**

① acc. to CECOMAF: liquid temperature 45 °C, evaporation temperature: -25 °C

4. Standard Delivery

Basic instrument WITHOUT motor/WITHOUT extraction, in the specific voltage variant

1 handwheel, manual	0477 41346
5 specimen discs, 30mm	0477 40044
1 section waste tray	0477 40062
1 position holder for freeze shelf	0477 40080
1 freeze shelf cover	0477 43763
1 tool set	0436 43463
- 1 brush, fine	0183 28642
- 1 Leica brush w/magnet	0183 40426
- 1 Allen key, No. 1.5	0222 10050
- 1 Allen key, No. 2.5	0222 04137
- 1 Allen key, No. 3.0	0222 04138
- 1 Allen key, No. 4.0	0222 04139
- 1 Allen key with dome head, No. 4.0	0222 32131
- 1 Allen key, No. 5.0	0222 04140
- 1 key with handle, No. 5.0	0194 04760
- 1 Allen key, No. 6.0	0222 04141
- 1 Single-head wrench, No. 13	0330 33149
- 1 Single-head wrench, No. 16	0330 18595
1 power cable	
1 bottle of cryostat oil, type 407, 50 ml	0336 06098
1 bottle of OCT freezing compound, 125 ml	0201 08926
1 pair of safety gloves, size M, * for cryosectioning	0340 29011
1 user manual plus language CD	0708 37115
* Note: for the Japanese version: 100V, 50/60 Hz; 1 pair of safety gloves, size S (0340 40859) is included.	

Basic instrument WITHOUT motor and WITH extraction,

Standard scope of delivery as above,
plus:

1 accessory set (extraction)	0477 43300
- Hose adapter 1	0477 40293
- Hose adapter 2	0477 40294
- Suction nozzle	0477 40295
- Silicone hose	0477 43302
- Silicone stopper	0477 43304
- Chamber suction nozzle	0477 43779
- Set of filters (5 pieces)	0477 43792

Compare the delivered components with the parts list and your order. Should you find any discrepancies, please contact your Leica sales office without delay.



A choice of different knife holders is available for the CM1950.

Basic instrument WITH motor/WITHOUT extraction, in the specific voltage variant

1 handwheel, motorized	0477 41347
5 specimen discs, 30 mm	0477 40044
1 section waste tray	0477 40062
1 position holder for freeze shelf	0477 40080
1 freeze shelf cover	0477 43763
1 tool set	0436 43463
- 1 brush, fine	0183 28642
- 1 Leica brush w/magnet	0183 40426
- 1 Allen key, No. 1.5	0222 10050
- 1 Allen key, No. 2.5	0222 04137
- 1 Allen key, No. 3.0	0222 04138
- 1 Allen key, No. 4.0	0222 04139
- 1 Allen key with dome head, No. 4.0	0222 32131
- 1 Allen key, No. 5.0	0222 04140
- 1 key with handle, No. 5.0	0194 04760
- 1 Allen key, No. 6.0	0222 04141
- 1 Single-head wrench, No. 13	0330 33149
- 1 Single-head wrench, No. 16	0330 18595
1 power cable	
1 bottle of cryostat oil, type 407, 50 ml	0336 06098
1 footswitch dummy	0443 30420
1 bottle of OCT freezing compound, 125 ml	0201 08926
1 pair of safety gloves, size M, * for cryosectioning	0340 29011
1 operating instructions plus language CD	0708 37115
* Note: for the Japanese version: 100V, 50/60 Hz; 1 pair of safety gloves, size S (0340 40859) is included.	

Basic instrument WITH and WITH extraction, in the specific voltage variant

Standard scope of delivery as above,
plus:

1 accessory set (extraction)	0477 43300
- Hose adapter 1	0477 40293
- Hose adapter 2	0477 40294
- Suction nozzle	0477 40295
- Silicone hose	0477 43302
- Silicone stopper	0477 43304
- Chamber suction nozzle	0477 43779
- Set of filters (5 pieces)	0477 43792

Compare the delivered components with the parts list and your order. Should you find any discrepancies, please contact your Leica sales office without delay.



A choice of different knife holders is available for the CM1950.

5. General Overview



5.1 Control Panel Fields and Cryostat Chamber

- 1 - Control panel field 1: Extraction, temperature and time control, illumination, UV disinfection
- 2 - Control panel field 2: Electric coarse feed (sectioning and trimming thickness adjustment)
- 3 - Control panel field 3: Motorized sectioning cutting, optional (adjustment of stroke type, cutting speed etc.)



Fig. 11

- | | |
|---|---|
| 4 - Heat conductor block, stationary (optional) | 10c- Knife guard on the blade holder CE |
| 5 - Peltier element (with 2 stations) | 11 - Extraction nozzle on the extraction hose |
| 6 - Freeze shelf, 15 positions | 12 - Extraction hose for section waste |
| 7 - Position holder on freeze shelf | 13 - Brush shelf (optional) |
| 8 - Heat and cold extractor, mobile (opt.) | 14 - Adapter piece for extraction hose
(the coarse filter insert is behind it) |
| 9 - Shelf, movable (optional) | 15 - Object head, directional |
| 10 - Blade holder CE with blade ejector (a) | 16 - Waste tray |
| 10b- Finger rest on the blade holder CE | |

6. Installation

6.1 Site Requirements

The place of installation must meet the following requirements:

- No direct sunlight.
- Power supply at a distance no greater than approx. 3 m.
- No drafts (air condition outlets etc.).
- Even floor.
- Vibration-free floor.
- The instrument is designed for indoor use only.
- Obstruction-free access to the handwheel.
- The power switch/circuit breaker must be freely and easily accessible.
- Room temperature always approx. 22 °C.
- The relative humidity must not exceed 60 %.



To ensure proper function of the instrument, it must be set up while maintaining a minimum distance from walls and furniture.

- Distance to walls and furniture, calculated from the cabinet:
 - rear: 15 cm
 - right side: 30 cm
 - left side: 15 cm
- No heat dissipating appliances around.



High room temperatures and excessive air humidity affect the cooling capacity of the cryostat and lead to ice forming in the instrument!

- Plug the instrument into power sockets with ground only.
 - Power cable length: up to 3.5 m
 - Extendable: no

6.2 Transport to the Site

- First, check if the location meets the conditions specified in "Site requirements".
- Transport the instrument to the desired location.
- Observe the following:



The instrument must be transported in an upright position or slightly tilted (max. 30°)!



When tilting the instrument 2 people must counterbalance from the front side to prevent the instrument from falling down and causing severe injury!



Fig. 12

- When transporting the instrument on wheels (2) grip the cabinet only at the marked locations (○).
- To do so, unscrew the adjustable feet using the No. 13 open-end wrench (when subsequently transporting the instrument on castors, screw the feet back in as far as they will go). To ensure a secure upright position at its intended location, align both adjusting feet (1).



Before transport or relocation, remove the filter bag from the chamber. If you fail to do this, the filter bag will thaw, then freeze solid when the instrument is reconnected. When subsequently removed, the filter will be destroyed, causing section waste to get into the bacteria filter. (Refer to p. 26.)



When not using the extraction for a long period, tightly close the opening for the extraction hose using the silicone stopper (5, page 28) included in the scope of delivery.

6. Installation

Transport with a fork lift

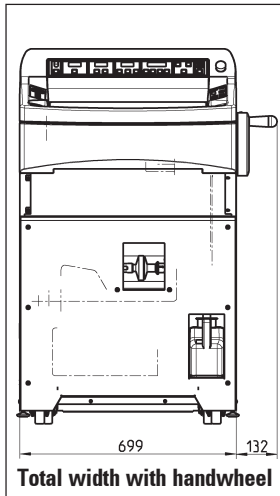

Fig. 13

- The instrument can be transported with a fork lift.



To ensure a safe transport with a fork lift 3 people are required: one operating the fork lift, and the other 2 holding the instrument on either side to prevent it from sliding down.

- At the installation site, unscrew the adjustable feet (1) with the open-end wrench No. 13 (see Fig. 12). This is absolutely necessary for a stable stand.

6.3 Assembling the Handwheel



Fig. 14



Rotate the handwheel only if the refrigeration system is on and the cryochamber is cold.

- Insert the pin (1) of the handwheel shaft into the hole (2) of the handwheel.
 - Tighten the screw (4) using the No. 6 Allen key.
 - Place the protective cap on the screw (4).
- To dismount, proceed in reverse order.

6.3.1 Locking/Unlocking the Handwheel



Fig. 15



Only rotate the handwheel when the refrigeration system is on and the cryochamber is cold!



Always lock the handwheel prior to manipulating the knife or specimen, changing the specimen, or taking a break.

To lock the handwheel, move its handle to the 12 or 6 o'clock position. Press the lever (1) fully outward; gently rock the handwheel until the locking mechanism clicks into place noticeably.

To release the handwheel, press the lever (2) on the handwheel toward the cryostat housing.

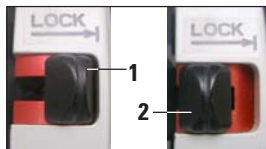

Fig. 16

Centering the Handwheel (Optional)



Fig. 17



An important safety device on the cryostat is the feature for centering the handwheel in motorized sectioning mode.

To do so, pull out the handwheel's handle and position it in the middle of the handwheel. The handle automatically engages in this position.

6.3.2 Installing the Footswitch Dummy (Instruments with Cutting Motor)



Fig. 18

- The footswitch dummy must be installed on the outer right side of the instrument (see page 16, General overview) if no footswitch (optional) is used.

If the red LED in the E-STOP field in control panel field 3 is illuminated, either:

- emergency-stop function active, or
- footswitch dummy (optional footswitch) connected incorrectly or not at all.

6. Installation

6.4 Connection to Power Supply System



After transporting, wait at least 4 hours before turning the instrument on. This waiting period is necessary to allow the compressor oil, which may have been displaced during transport, to return into its original position. Furthermore, any condensation that has formed during this time due to temperature fluctuations must be allowed to dry completely.

Failure to comply with this can cause severe damage to the instrument!

During the start-up of the compressor the nominal voltage must not drop below the values specified in the "Technical Data".

Please note that the compressor requires a start-up current between 25 and 35 A.

Therefore, the electric circuit at the installation site must be inspected by an electrical engineer to ensure that it meets the requirements for a smooth operation of the instrument.

Failure to comply with the above will cause severe damage to the instrument!

- Check mains voltage and mains frequency to comply with the specification on the type plate.
- Do not connect any other consumers to this electric circuit.



Never connect the instrument to a power socket that does not have a protective conductor terminal.

Only for instruments sold in Japan



Fig. 19

Selecting the frequency

- After unpacking the instrument and setting it up at its intended location, use the lever (1) to select the frequency corresponding to the conditions of the existing power system.

6.5 Installing Accessories/Inserting Chamber Accessories

6.5.1 Installing the Adjustable Footrest (Optional)

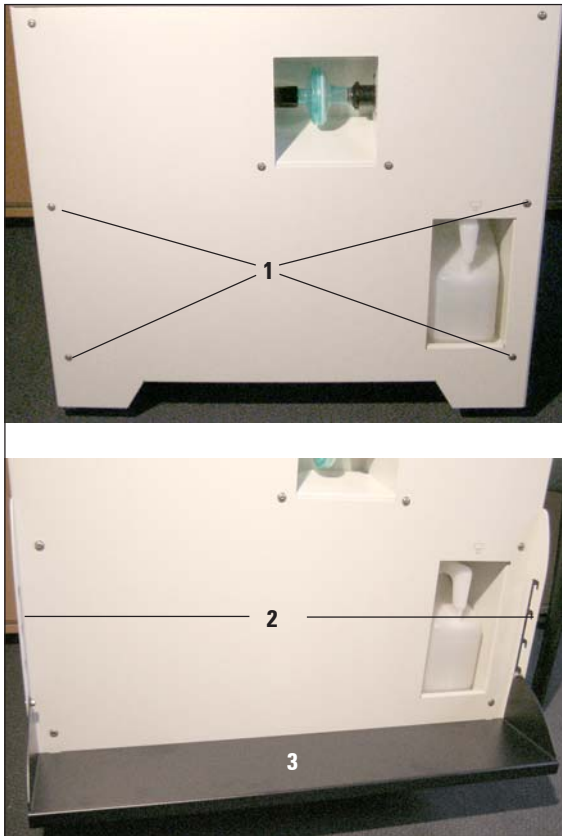

Fig. 20

- To install the optional footrest, unscrew the screws (1) using the No. 3 Allen key provided.



When installing the holder (2), ensure that the cutout faces downwards so that the support (3) can be hooked in.

- Attach the holders (2) for the footrest on the left and right to the front wall of the housing. To do so, use the Allen screws you used earlier. Ensure that the screws are tight.
- Hook the footrest (3) into the installed holder according to individual requirements (height).
- Once installed, the user can adjust the height of the footrest at any time by relocating it (3) to the desired height on both sides in the holder (2).

6. Installation

6.5.2 Installing the Storage Systems (Optional)

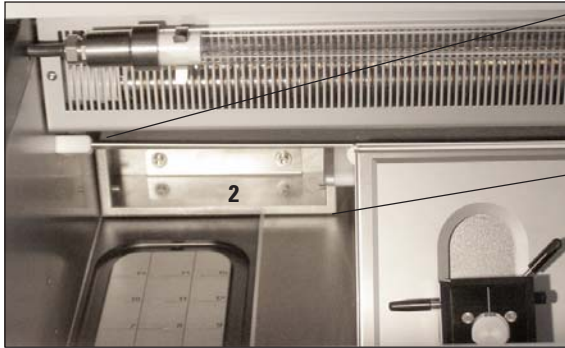

Fig. 21



For reasons of accessibility, the (optional) storage system must always be installed first.

To do so, remove the insert (1), place the frame (2) in front of the bore and tighten the screws/washers on the cryostat housing using the No. 4 Allen key. Afterwards, insert the insert (1) into the frame and fold it up.



Fig. 22

6.5.3 Shelf, Movable (Optional)

Attach the rod for the shelf to the inner front side of the cryostat housing using the provided screws (1) and the No. 3 Allen key, then attach the caps (3). (The rear side of the movable shelf has white plastic screws (2) that prevent the interior of the chamber from being scratched.) Now hook the movable shelf into the guide rod.

6.5.4 Inserting the Section Waste Tray

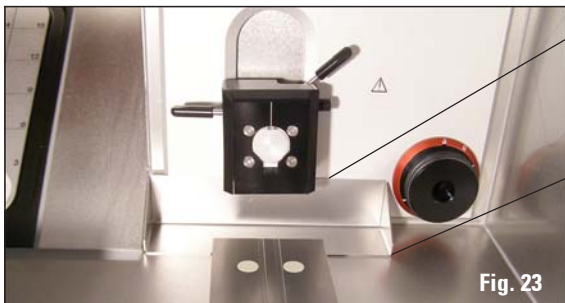
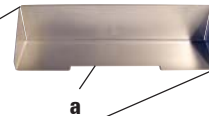

Fig. 23



Before installing the knife/blade holder base, insert the section waste tray with the cutout (a) facing the user.

6.5.5 Installing the Heat Conductor Block, Stationary (Optional)



Fig. 24

The holder (1, Fig. 24) of the heat conductor block is screwed to the left housing wall using the No. 4 Allen key provided. (Preferably, begin with the bottom screw. Then, rotate the holder upwards (see arrow) and insert and tighten the top screw).



Now, attach the cover for the quick freeze shelf to protect the shelf from frost.

6.5.6 Installing the Knife/Blade Holder and Adjusting the Clearance Angle



For temperature reasons, install the knife/blade holder on an appropriate base.

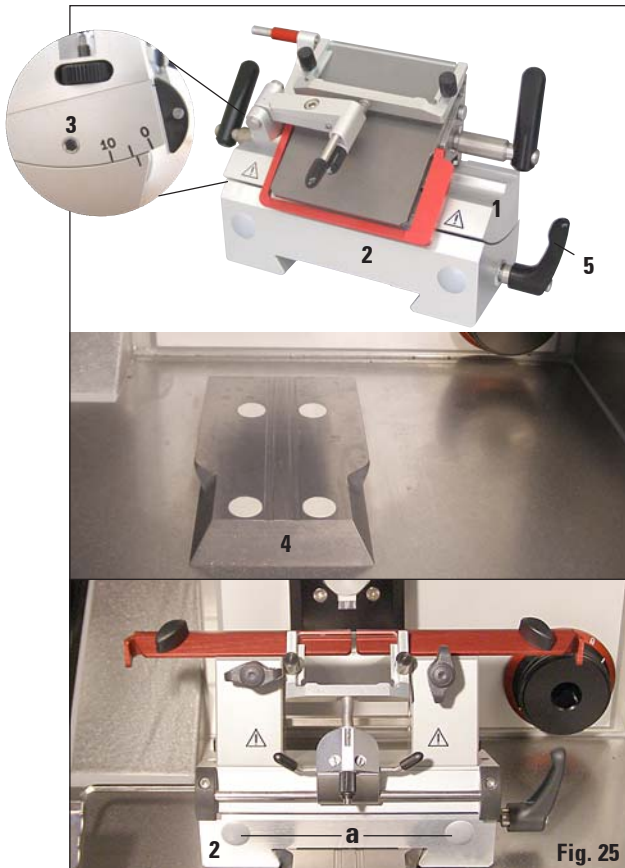

Fig. 25

- Set the knife or blade holder (1, Fig. 25) on the base (2), adjust the clearance angle (on the left of the knife/blade holder) to approx. 2°-5° and secure it in the bore (3) on the base (2) using the No. 4 Allen key.
- Push the knife holder base (2) on the dovetail guide (4) from the front and tighten it using the clamping lever (5). To move the base, open the clamping lever only a little to prevent accidental sliding in the direction of the specimen head.
- If the clamping distance is not sufficient, the clamping lever (3) can be moved. To do so, pull the lever out and move it to the next position.



When removing the knife holder base (2) from the refrigerated cryostat chamber, hold it by the grip points (a – front and rear) to keep your fingers from freezing.

6. Installation

6.5.7 Inserting/Changing the Bacteria Filter

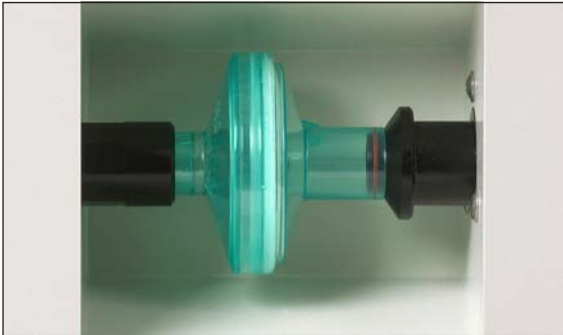

Fig. 26

The holder for the bacterial filter (optional) is visible in the front of the instrument.

- To insert the filter, hold it with one hand, press on the right of the socket, then guide the filter into the tube from the left.
- To change the filter, follow the opposite procedure: press the filter to the right, then pull it to the left and out of the tube.
- The filter must be changed approx. every 3 months (we recommend writing the date on the filter using a marker).



The filter must be disposed of according to valid laboratory specifications.

6.5.8 Assembling the Filter Bag

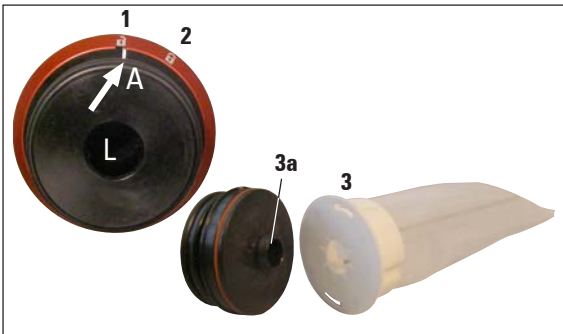

Fig. 27

- Set the mark (A) of the extraction opening (1) and pull it out. Plug the filter (3) into the extraction hose connecting piece (3a) until there is an audible click.

Now push the connected parts back into the opening in the cryostat chamber (filter first) and set it to the "closed" mark (2, Fig. 27).



When not using the extraction, tightly close the opening for the extraction hose using the silicone stopper (E) included in the scope of delivery.



Fig. 28

Reasons:

1. To prevent section waste from falling into the opening.
2. To prevent cold from escaping from the chamber.
3. To prevent moisture from penetrating into the chamber.

6.5.9 Installing the Section Extraction (Optional) – Use with Blade Holder CE Only

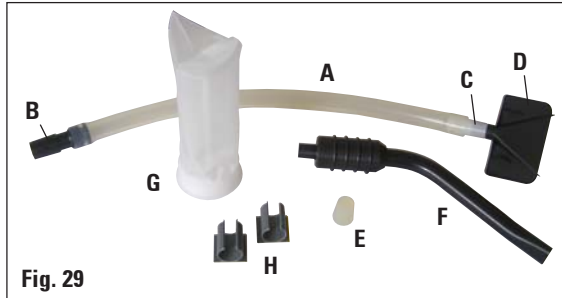

Fig. 29

- Silicone hose (A) with hose adapter 1 (B, to the filter in the instrument), hose adapter 2 (C, for suction nozzle D or F) and suction nozzle (D) – factory pre-assembled
- Silicone stopper (E)
- Chamber suction nozzle (F)
- Filter (G)
- Plastic clip (H), for parking the chamber suction nozzle.

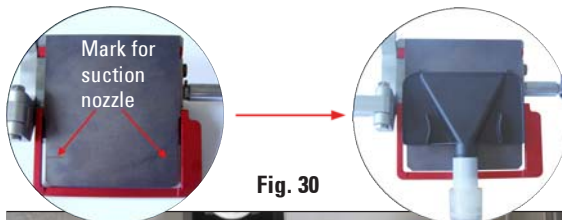

Fig. 30

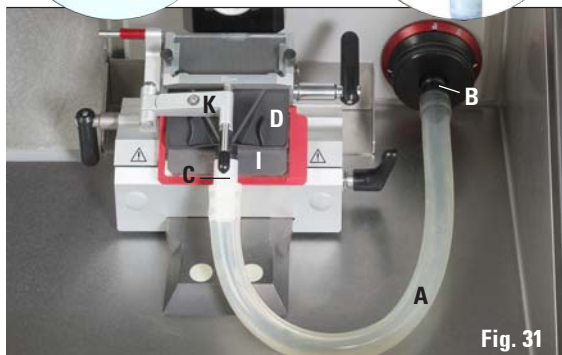

Fig. 31

When the suction nozzles are changed, the adapter (white) remains in the silicone hose. Pull off the nozzle by rotating and pulling it gently and firmly plug in the desired nozzle.



Ensure that the hose with the nozzle is not installed against its "natural" curvature on the pressure plate of the blade holder.

The tension acting on the hose can be minimized by turning the red ring (Fig. 31, top right) clockwise so that the suction nozzle presses against the pressure plate (I, Fig. 31).

Afterwards, fold the anti-roll guide (K) back onto the pressure plate.

- The scope of delivery also includes 2 plastic clips (H). These enable comfortable "parking" of the chamber suction nozzle (F) during sectioning.

The clip must be glued in **before** switching on the refrigeration. Before doing so, briefly degrease the surface to ensure a secure hold.

Preferably, the clip should be attached outside the working area, e.g. on the left inside wall of the instrument.



If the extraction nozzle (D) is not being used, it can be "parked" on one of the two magnetic surfaces indicated in the interior of the instrument.



If the extraction is not used for a long time, it is absolutely necessary to clean the extraction hose in order to ensure maximum extraction capacity. To do so, place the hose in commercially available disinfectant or alcohol. After several cleanings, the hose must be replaced (see order information on p. 49)!

7. Instrument Controls

7.1 Control Panel Fields on the CM1950 – Control Panel Field 1

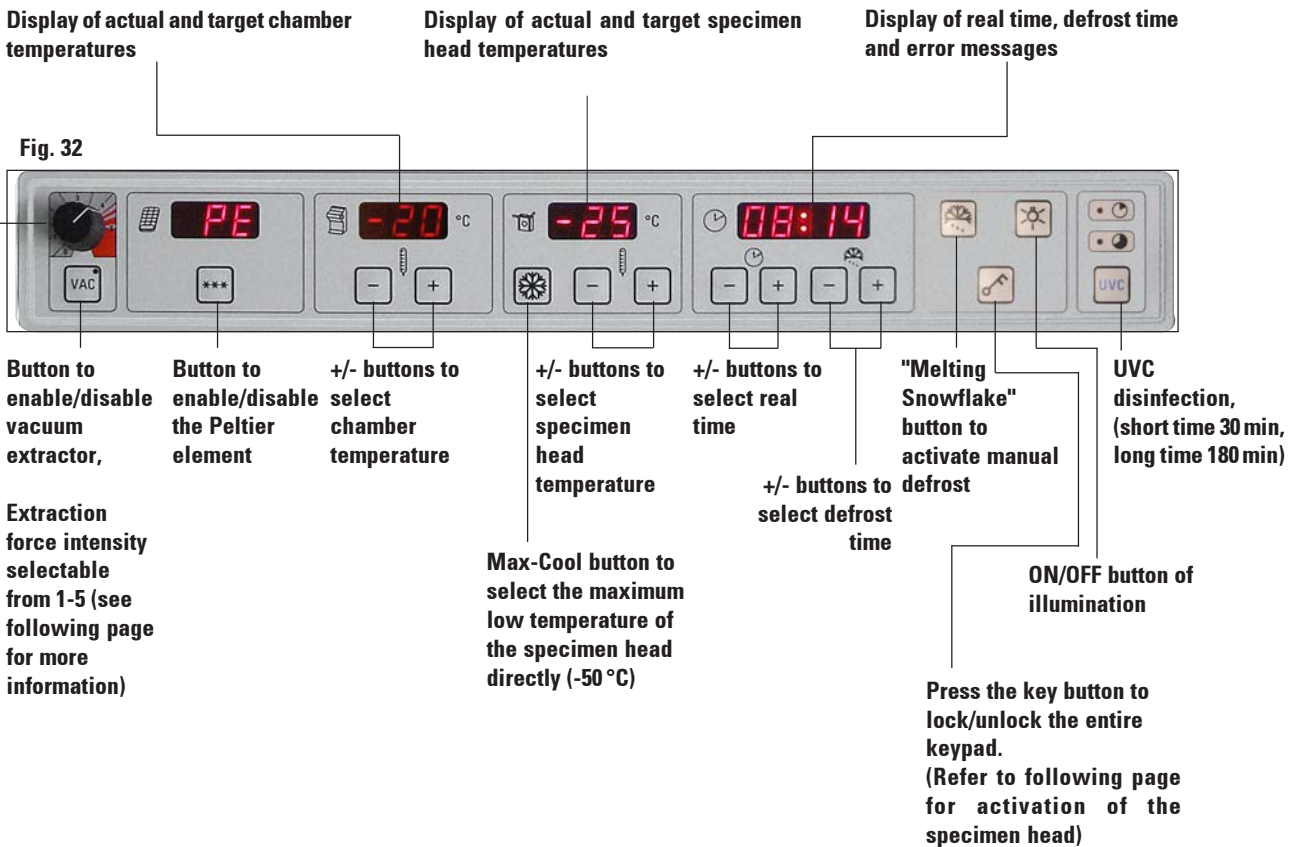

EMERGENCY STOP switch to the right of control panel field 1 (motorized instruments only)

For danger situations during motorized sectioning.

- **Immediate** stop of the sectioning process – motor stops – LED in E-Stop is illuminated in red.
- Turning in direction of arrow cancels the stop – LED in E-Stop goes out.
- Select single stroke (Single) or continuous stroke (Cont.) operating mode again.

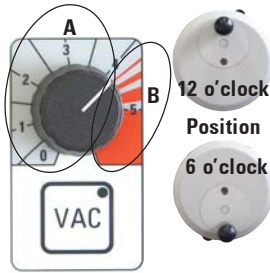

- Press the "VAC" button to enable the vacuum extractor. The LED in the "VAC" button is lit while the extractor is on. Press the button again to disable it.

- Use the knob to adjust the intensity of the vacuum.

A Optimal area for trimming and sectioning

- Trimming: Handwheel position 12 - 6 o'clock, valve open
Handwheel position 6 - 12 o'clock, valve closed
- Cutting: Handwheel position 12 - 3 o'clock, valve open all the way
Handwheel position 3 - 6 o'clock, valve half open
Handwheel position 6 - 12 o'clock, valve closed

B Optimal area for extraction from the chamber

- To clean the chamber, turn the knob to the red range.



The strength of the required extraction force depends on the following:

- Size of the specimen
- Sectioning speed
- Section thickness used



- The Peltier element provides additional cooling for the freezing stations. After the ******* button is pressed, the display changes from "PE" to "10", indicating an additional cooling period of 10 minutes. The remaining cooling time is always shown in the display. Once only 4 minutes are remaining, a dot will appear after the "4". As of this time, the Peltier element may be switched off early by pressing the ******* button again.



Caution:

The specimen head and Peltier do not switch on until the chamber temperature reaches -5°C , in order to prevent icing.



If the condenser (resting phase) is off and the Peltier is activated, the digit 10 flashes until the condenser switches on again to prevent the Peltier from being destroyed when the condenser is not running. When the condenser starts up, the flashing starts and the 10 minutes are counted down.



(For exact instructions for using the chamber, specimen head and real time display fields, refer to the chapter on "Working with the Instrument" on page 37 of this Operating Manual.)

7. Instrument Controls

Control Panel Field 2 – Electric Coarse Feed, Sectioning and Trimming Thickness Display

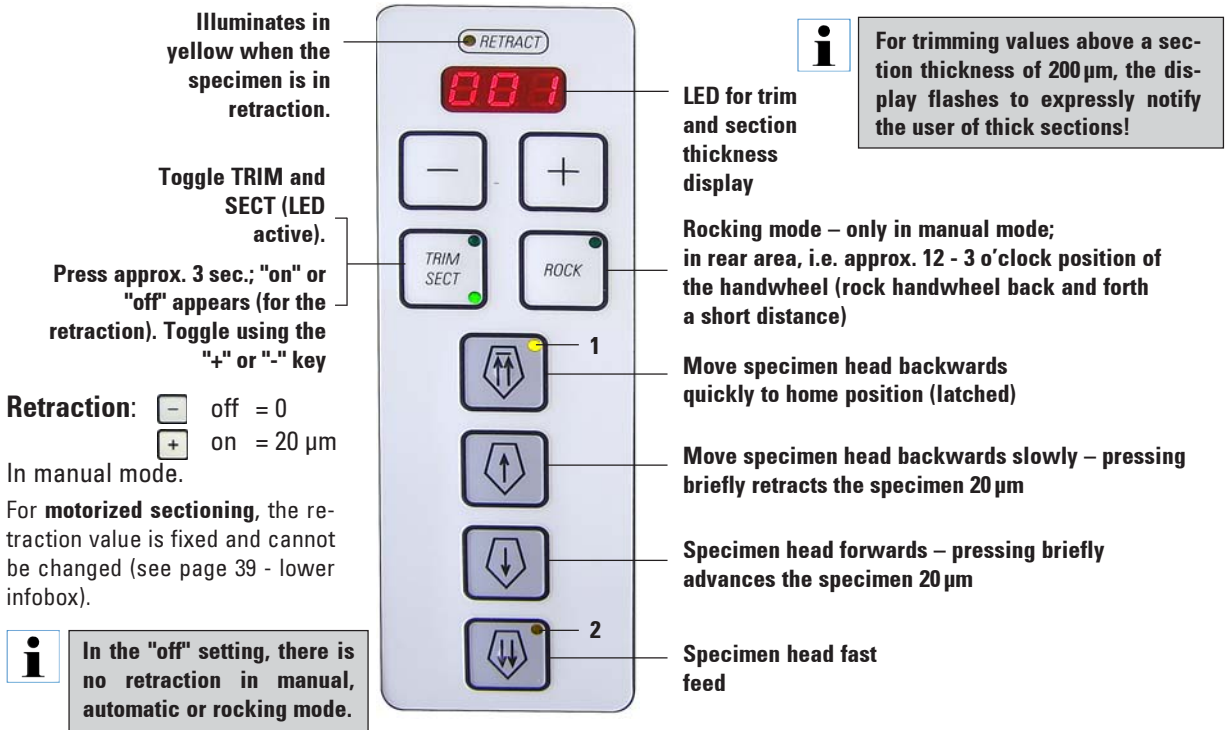

Fig. 33

Setting section/trim thickness

Use the - keys on control panel 2.

Range of **section thickness**: 1 - 100 µm

Values: 1.0 µm - 5.0 µm in 0.5 µm steps
 5.0 µm - 20.0 µm in 1.0 µm steps
 20.0 µm - 60.0 µm in 5.0 µm steps
 60.0 µm - 100.0 µm in 10.0 µm steps

Range of **trim thickness**: 1 - 600 µm
 (Recommended for research applications)

Values: 1.0 µm - 10.0 µm in 1.0 µm steps
 10.0 µm - 20.0 µm in 2.0 µm steps
 20.0 µm - 50.0 µm in 5.0 µm steps
 50.0 µm - 100.0 µm in 10.0 µm steps
 100.0 µm - 600.0 µm in 50.0 µm steps

Trimming section thickness setting range:
 (Recommended for clinical applications)

Values: 10 µm, 20 µm, 30 µm, 40 µm,

Coarse feed functions

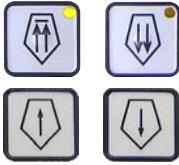

The two-speed electric coarse feed is designed to quickly position the specimen in relation to the knife. The buttons with double arrows move the specimen at 900 $\mu\text{m/s}$; the buttons with single arrows move it at 300 $\mu\text{m/s}$.

Retracting the specimen head from the knife



fast



slow

- Pressing once starts the rapid backwards movement to the rear end position (**Home position**). The LED (1) flashes while the specimen head is in motion. The LED (1) lights up when the rear end position (**Hp.**) has been reached.
- The retraction can be stopped by pressing one of the coarse drive buttons.
- The rapid backwards movement to the rear end position (**Hp.**) starts. The motion continues as long as the button is held.
- A brief press of the button retracts the specimen by 20 μm .

Advancing the specimen toward the knife



slow



fast

- Start the slow forwards movement to the knife. To feed the specimen, press and hold the button.
- Pressing the button briefly results in a feed motion of 20 μm .
- Start the fast forwards movement to the knife.
- The LED (2) flashes while the specimen head is in motion. The LED (2) lights up when the forward end position has been reached.

Manual sectioning mode

Select **ROCK** operating mode (LED active) – retraction must be enabled!

- For sectioning, turn the handwheel a short distance (approx. 1/4 turn) forwards and back (rocking mode) – only possible at rear (handwheel in approx. 12 - 3 o'clock position). Every change in rotation direction is electronically detected and automatically translated into a specimen feed or retraction movement.

7. Instrument Controls

Control panel 3 – Motorized sectioning (optional)

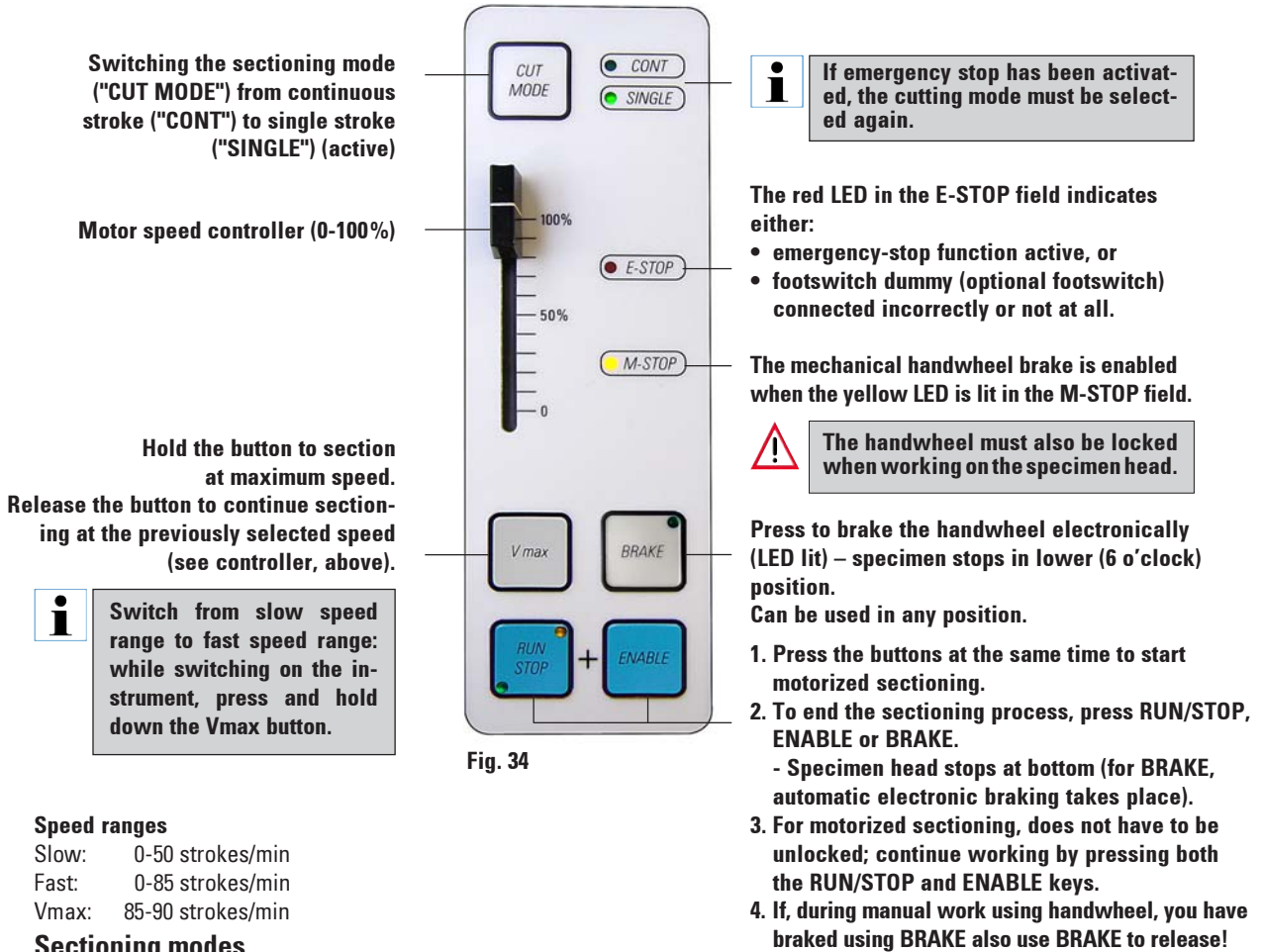

Fig. 34

Speed ranges

Slow: 0-50 strokes/min

Fast: 0-85 strokes/min

Vmax: 85-90 strokes/min

Sectioning modes

The instrument can be used in manual and motorized modes.

The following settings are available:

- **Single stroke (SINGLE)** or **continuous stroke (CONT.)** in automatic mode, as well as
- **ROCK** (sectioning using handwheel) in manual mode.



When switching the instrument on, no operating mode is active for safety reasons.

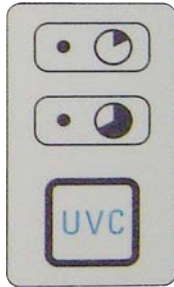

Fig. 35

Disinfection

Duration - 30 min

Duration - 180 min

UVC key - to activate / deactivate the disinfection cycle and/or to acknowledge interruption of a disinfection cycle.

To start disinfection the sliding window must be completely closed.

- Press UVC key once briefly to start the 30 min. mode
- Press UVC key once for a longer time (approx. 4 sec.) to start the 180 min. mode



The germicidal UV lamp is a simple and safe disinfection device which considerably reduces the risk of infection. Nevertheless, UV light disinfection cannot replace chemical disinfection of the cryochamber at regular intervals. UV light disinfection is effective only on those surfaces that are directly illuminated.



Specimens and section waste must be thoroughly removed from the cryochamber first (e. g. using the optional vacuum extractor, or a paper towel soaked with Cryofect or alcoholic disinfectant). Before UV disinfection, move the anti-roll guide to the side to allow complete disinfection.

- Leica Cryofect is not available in all countries.



Opening the sliding window cancels the disinfection cycle. Press the UVC key to acknowledge this.



When the keypad lock is activated (via the key button) the UV lamp can be shut off only by opening the glass, as the UV keys are locked. The cancellation can be acknowledged only if the keypad lock is disabled. Only then can the UV lamp be switched back on.

8. Working with the Instrument

8.1 Preparing Cutting Tools, Specimen Discs and Preparation Aids



**The knives are extremely sharp! Handle with care!
Never try to catch a falling knife!**

- Place working materials such as the blade box or knives (in the knife case), brush, pincers or preparation needles and, where applicable, specimen discs into the cryostat chamber.

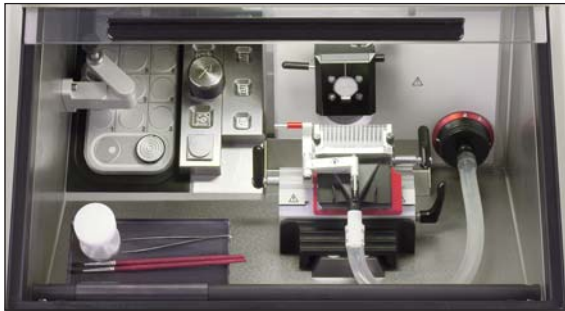

Fig. 36

- The necessary tools and preparation aids can be precooled on the (optional) movable shelf, making them available at all times in a convenient position for the user.
- In addition, specimen discs can be precooled and stored in the storage system (see page 26, Fig. 21).



For installation of knife/blade holder and installation in the chamber, refer to optional accessories on page 50).

8.2 Turning the Instrument On



Fig. 37



The instrument must be switched on at least 5 hours before the planned use.

The circuit breaker is used as power switch. The switch must be in the top position for switching on and in the bottom position for switching off. The switch must be accessible without obstruction.

- Close the sliding window.



**To avoid frost formation always put the cover on the quick freeze shelf.
Always cover the quick freeze shelf during breaks and overnight.**

8.3 Configuring the Parameters



The instrument must be switched on at least 5 hours before the planned use.



- Turn the lamp on or off.



- This button activates or deactivates the manual defrost of the cooling chamber, specimen head or freeze shelf. (For more detailed handling instructions, refer to the chapter on "Working with the Instrument" on p. 39 of this Operating Manual.)



- Pressing the key button for approx. 5 sec. locks the entire keyboard (the LEDs in the clock go out).
- Pressing the key button briefly, then the "-" key in the specimen head control panel field, switches off the specimen head.
- Pressing the key button briefly, then the "+" key in the specimen head control panel field, switches the specimen head back on.

Programming the temperature of the cryochamber

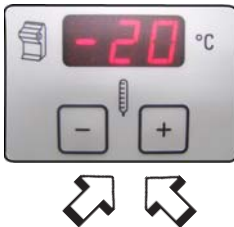

- The temperature of the cryochamber is set and indicated on the control panel marked with the cryostat symbol.

The actual temperature is the standard indication.

Briefly pressing the "+" or "-" button displays the target temperature.

Set the desired value via the "+" / "-" buttons. Pushing the "+" or "-" button for more than 1 sec. increases or decreases the chamber temperature continuously.

The actual value will be indicated 5 seconds after finishing the programming.



Refer to page 52 for a table with guide values. The temperature values given there are based on long-term experience, but are intended solely as guide values, as any tissue may require particular adjustments.

8. Working with the Instrument

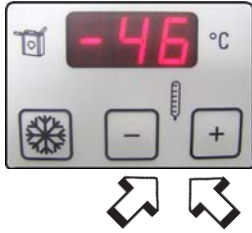

Programming the specimen temperature

- Select the desired temperature of the specimen.
- The specimen temperature is set and indicated on the control panel marked with the specimen head symbol.

The actual temperature is the standard indication.

Briefly pressing the "+" or "-" button displays the target temperature.

Set the desired value via the "+" / "-" buttons. Pushing the "+" or "-" button for more than 1 sec. increases or decreases the specimen temperature continuously.

The actual value will be indicated 5 seconds after finishing the programming.



Caution:

The specimen head and Peltier do not switch on until the chamber temperature reaches -5 °C, in order to prevent icing.

Specimen temperature - "Max-Cool" function

- The snowflake button for the **Max-Cool** function is in the panel with the specimen head symbol. Pressing the  button sets the lowest possible specimen head temperature (-50 °C) as the target temperature. The instrument adjusts the maximum low temperature of the specimen head, i.e. -50 °C.
- Push the snowflake button again to stop the **"Max-Cool"** function. The temperature adjusts to the value programmed prior to activating the "Max-Cool"-function.
- Alternate flashing of "LL" and the actual temperature indicates activation of the Max-Cool function.

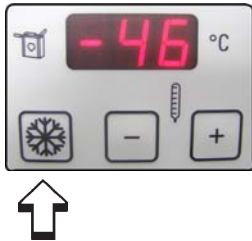



Setting the time

- The clock time is set with the +/- buttons in the control panel marked with the clock symbol. To do so, set the current time using the "+" or "-" button below the small clock symbol. Pushing the "+" or "-" button for more than 1 sec. increases or decreases the time continuously (auto-repeat function).

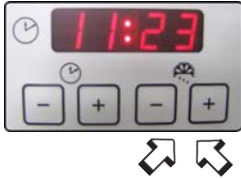

Programming the defrost cycle



- Set the beginning of the automatic defrost cycle.
The automatic defrost cycle takes place once within 24 hours. It is set with the "+"/"-" buttons on the right of the panel with the clock symbol. The two buttons are marked by a melting snowflake .
- Briefly press the "+" or "-" button for indication of the beginning of the defrost cycle which has actually been set. At the same time, the LEDs between the indication of hours and minutes are flashing.
- To change the beginning of the defrost cycle in steps of 15 minutes, push the "+" or "-" key. When the "+" or "-" button is pushed for more than 1 s, the defrost time value increases or decreases continuously.







Before starting the defrost cycle remove all samples from the cryochamber!

- When the automatic defrost cycle begins, the specimen head temperature adjusts to a temperature between - 10°C and - 5°C (reduction of ice formation). The specimen head cooling turns off. This is confirmed by the flashing of the decimal points on the panel for the specimen cooling. The specimen cooling (controlled to set value) automatically turns back on after 4 hours, once the chamber temperature varies by less than 5 K from the target temperature.
- If you want to turn the specimen cooling back on manually before the automatic activation sets in, push the "+" or "-" button on the panel for the specimen cooling and then the key button.
- The temperature of the specimen cooling first raises to +10°C and then adjusts to the programmed specimen temperature.

Manual defrost for the freeze shelf (including Peltier element)



- Press the key for manual defrost , then the  key.
The manual defrost takes 12 min.
- Push the  button and then the  key again to stop the manual defrost.



After defrosting the freeze shelf, carefully wipe it out, as otherwise a lot of water collects in the channel. Ice does not melt during normal defrosting.

8. Working with the Instrument

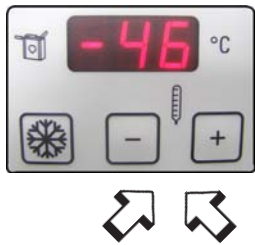
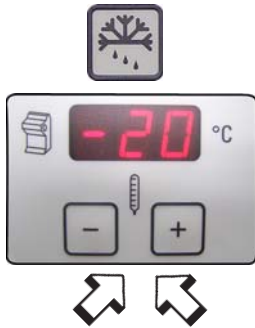

Manual defrosting of the cryochamber

- Push the manual defrost button (with the melting snowflake) on the left over the key button to activate the defrost cycle of the cryochamber on demand.
- Activation is confirmed by an audible signal.
- Then, push the "+" or "-" button on the panel for the cryochamber temperature.
- The manual defrost cycle (12 min.) is activated.
- There is a flashing indication of the temperature of the cryochamber during the whole defrost cycle.
- If necessary, push the manual defrost button again to deactivate the manual defrost cycle.
- When the manual defrost begins, the specimen head adjusts to a temperature between -10°C and -5°C (reduction of ice formation). The specimen head cooling turns off. This is confirmed by the flashing of the decimal points on the panel for the specimen cooling.
- Ten seconds after the manual defrost cycle has been completed, the specimen cooling turns back on.



Before starting the defrost cycle, remove all specimens from the cryochamber!

Manual defrosting of the specimen cooling

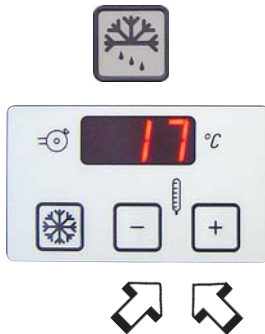

- Push the manual defrost button (with the melting snowflake) on the left over the key button to activate the defrost cycle of the specimen head.
- Activation is confirmed by an audible signal.
- Then, push the "+" or "-" button on the panel for the specimen temperature.
- There is a flashing indication of the specimen temperature during the defrost cycle.
- For 15 minutes, the specimen head is adjusted to a temperature of 45°C .
- Subsequently, the instrument adjusts to the specimen temperature which has been programmed prior to the manual defrost cycle.
- If necessary, push the manual defrost button again to deactivate the manual defrost cycle.



Press the key button, then the "+" button = specimen head on
Press the key button, then the "-" button = specimen head off



Entering the trimming thickness



To switch from a trimming section thickness for research applications (1-600 μm) to a thickness for clinical applications (10, 20, 30 or 40 μm), press and hold down the TRIM/SECT key while switching on the instrument.



- Press the **TRIM/SECT** button. **TRIM** mode is active if the LED at the top right is illuminated.
- Set the desired trimming thickness using the "+" or "-" button in control panel field 2. (Refer to page 32 for adjustable sequence of steps)



Entering the section thickness

- Press the **TRIM/SECT** button. **SECT** mode is active if the LED at the bottom right is illuminated.
- Set the desired section thickness using the "+" or "-" button in control panel field 2. (Refer to page 32 for adjustable sequence of steps)

Switching the retraction on or off in manual sectioning mode

- Press the **TRIM/SECT** button for approx. 3 sec. The LED in control panel field 2 displays on  or off .
- You can switch by pressing the "+" or "-" button.
- "Retraction on" means a specimen retraction of 20 μm in manual mode.



During motorized sectioning, the retraction value is speed-dependent and cannot be changed by the user.

8. Working with the Instrument

8.4 Working with the Precooled Cryostat

8.4.1 Preparatory Work

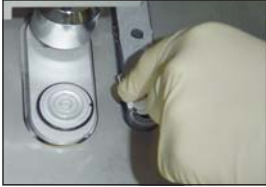

- Lock the handwheel in the top (12 o'clock) position.
- Cut the specimen to size outside of the cryostat.
- Select the precooled specimen disc, cover it with freezing compound, then attach and orient the specimen.
- Attach the specimen disc and specimen to the Peltier position on the freeze shelf. Activate the Peltier element and wait until the specimen is completely frozen.

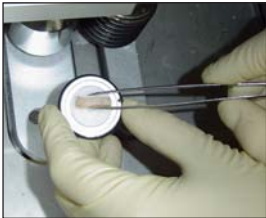

Specimens that have been frozen on the Peltier element are often too cold and split apart during sectioning. Allow time for the specimens to become acclimated.

- Insert the specimen disc into the specimen head.
- Fold the anti-roll guide away and to the side. Insert a precooled knife or blade.



Before using them for the first time, degrease new knives using acetone or alcohol.

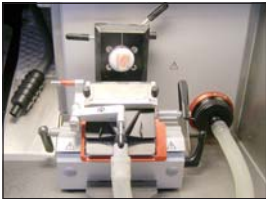

- Approach the specimen with the knife or blade holder:
 - To do so, open the clamping lever of the base, approach the specimen and close the lever again.
- Open the lever of the orientation. Orient the specimen (move it into a favorable position relative to the knife/blade) and close the lever again.
- Approach the knife or blade holder using the coarse feed buttons and gentle movements of the handwheel.



If the sections are cracked, the specimen head temperature is too cold. Set a warmer temperature.

If the sections smear, the specimen head temperature is too warm. Set a colder temperature.

8.4.2 Trimming with Extraction – Anti-roll Guide Installed



Fig. 38

- Remove the silicone stopper from the filter cover (and keep it in a safe place).
- Insert the extraction hose with the black adapter.
- Fold the anti-roll guide to the side and fasten the suction nozzle to the pressure plate – see mark Fig. 39a - (using 4 magnets on the rear side of the nozzle).
- Fold the anti-roll guide back into position.

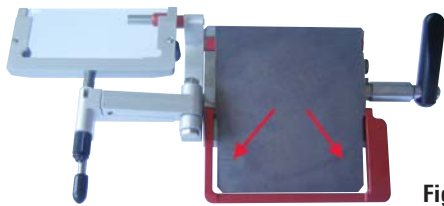

Fig. 39a



Fig. 39b

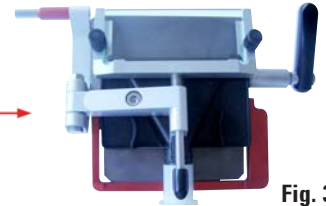

Fig. 39c

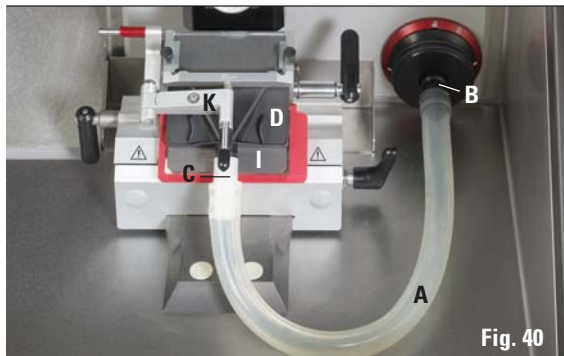

Fig. 40



Ensure that the hose with the nozzle is not installed against its "natural" curvature on the pressure plate of the blade holder.

The tension acting on the hose can be minimized by turning the red ring (Fig. 39, top right) clockwise so that the suction nozzle presses against the pressure plate (I, Fig. 39).



- Check that the anti-roll guide is parallel and correctly adjusted. Readjust if necessary (see page 58).
- Activate trimming mode.
- Select the trimming thickness.
- Switch on the VAC and select a low extraction level (between 1 and 2).
- Start trimming by manually moving the handwheel or press the **RUN/STOP** and **ENABLE** keys simultaneously to start motorized sectioning.

8. Working with the Instrument



For motorized sectioning, always begin at low speed for safety reasons.

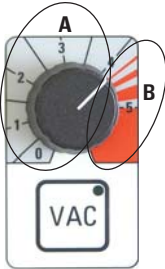

- Optimize the vacuum settings if necessary.
 - Press the "VAC" button to enable the vacuum extractor. The LED in the "VAC" button is lit while the extractor is on. Press the button again to disable it.
 - Use the knob to adjust the intensity of the vacuum.
- A Optimal area for trimming and sectioning**
- Trimming: Handwheel position 12 - 6 o'clock, valve open
Handwheel position 6 - 12 o'clock, valve closed
 - Cutting: Handwheel position 12 - 3 o'clock, valve open all the way
Handwheel position 3 - 6 o'clock, valve half open
Handwheel position 6 - 12 o'clock, valve closed
- B Optimal area for extraction from the chamber**
- To clean the chamber, turn the knob to the red range.



If the handwheel is not moved for approx. 5 sec, the valves close and the fan remains on.
If the handwheel is moved for approx. 1 min, the valves close, the fan shuts off (the LED in the VAC switch goes off to prevent icing).
To continue working, you now have to reactivate the VAC.

2. Trimming with Extraction – Brush Technique, finger rest installed



- Remove the silicone stopper (E) from the filter cover (and keep it in a safe place).
- Insert the extraction hose with the black adapter.
- Fasten the suction nozzle to the pressure plate (using 4 magnets on the rear side of the nozzle) as far as possible towards the blade.



Ensure that the hose with the nozzle is not installed against its "natural" curvature on the pressure plate of the blade holder.



- The tension acting on the hose can be minimized by turning the red ring (Fig. 28 on page 28) clockwise so that the suction nozzle presses against the pressure plate.
- Check that the suction nozzle is seated optimally (by gently turning the handwheel)

- Activate trimming mode.
- Select the trimming thickness.
- Switch on the VAC and select a low extraction level (between 1 and 2).
- Start trimming by manually moving the handwheel or press the **RUN/STOP** and **ENABLE** buttons simultaneously to start motorized sectioning.
- Use a brush to apply the section to a precooled specimen slide, then warm it from below using your finger.
- Move the knife guard forward after removing the section.
- Remove the knife or disposable blade (using the blade ejector!).
- Insert the knife into the knife case.

8.4.3 Cutting with Extraction – Anti-roll Guide installed

- Shut off VAC (LED in VAC button goes out).
- Switch from trimming to sectioning mode (important for section stretching, as the valves work differently than in trimming mode.)
- Set the desired section thickness.
- Switch on the VAC and begin at level 1. If the section does not stretch correctly, turn the VAC knob higher in small increments.
- Once the desired section is on the pressure plate, switch off the VAC! Carefully fold the anti-roll guide to the side and remove the section from the side.



After removing the section, wipe off moisture/condensate from the pressure plate – otherwise, the next sections will become jammed.



Cutting with extraction without anti-roll guide (brush technique) is not possible, as the position of the pressure plate means that no suitable air flow is obtained.

8. Working with the Instrument

A few rules:

- Always begin at a low extraction level, then slowly increase it.
- Do not use high extraction levels unless absolutely necessary.
- Different specimen sizes require different extraction levels.
- The faster the trimming or sectioning speed, the lower the extraction level should be.
- The larger and/or thicker the specimen to be trimmed, the lower the extraction value.
- When section specimens with a diameter of 0.5 cm, the anti-roll guide stretches the section adequately. For larger specimens, we recommend using the vacuum function.

Trimming, 1 x 1cm specimen

Trimming thickness Speed Extract. value

10 µm	40%	1.5
10 µm	60%	1.5
10 µm	80%	1
10 µm	100%	1

20 µm	40%	2
20 µm	60%	2
20 µm	80%	1.5
20 µm	100%	1

30 µm	40%	2.5
30 µm	60%	2.5
30 µm	80%	2
30 µm	100%	1.5

40 µm	40%	3
40 µm	60%	3
40 µm	80%	2.5
40 µm	100%	2

Trimming, 1 x 1cm specimen

Trimming thickness Speed Extract. value

1 µm - 5 µm	40%	2.5
	60%	2
	80%	1.5
	100%	1.5

10 µm	40%	2.5
	60%	2
	80%	2
	100%	1.5



The values listed here are possible settings that depend on the tissue type, specimen size, section thickness and section speed, and are intended for orientation purposes only.

These settings can also vary when using different anti-roll plate!

After trimming or sectioning:

Specimen:

- Unclamp and thaw.
- Immerse in fixative for further processing.

Cleaning

- Use the brush to sweep up the section waste (section waste tray) and remove it from the cryostat (follow applicable laboratory regulations for disposal).

Or:

- Clean the cryostat chamber using the chamber suction nozzle:
 - To do so, turn the (flat) suction nozzle of the extraction hose by holding the hose on the white adapter and removing it with a quick twist. "Park" the flat suction nozzle in a designated place in the chamber, e.g. on the right inside wall of the cryogenic chamber.
 - Remove the chamber suction nozzle from the plastic clip and attach it firmly to the white adapter.
- Check the remaining capacity of the filter (in the interior of the chamber) and change the filter if necessary (see page 28).
- Check the bacterial filter (in the front of the unit, see page 28), change it at least every 3 months.
- Move the anti-roll guide to the side.
- Spray the cryostat chamber using Cryofect.
- Activate the UVC disinfection.

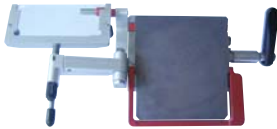

9. Troubleshooting

9.1 Problems During Work

Problem	Causes	Remedies
Frost on chamber walls and microtome	Cryostat is exposed to air currents (open windows and doors, air conditioning). Frost built-up by breathing into the cryochamber.	Change place of installation for the cryostat. Wear mouth protection.
Sections smear	Specimen not cold enough. Anti-roll plate not yet cold enough, thus warming the section.	Select lower temperature. Wait until knife and/or anti-roll plate have reached chamber temperature.
Sections splinter	Specimen too cold.	Select higher temperature.
Sections not properly flattened	Static electricity/air currents. Specimen not cold enough. Large area specimen. Anti-roll plate poorly positioned. Anti-roll plate poorly aligned with knife edge. Incorrect clearance angle. Blunt knife.	Remove cause. Select lower temperature. Trim the specimen parallel, increase section thickness. Reposition anti-roll plate. Align correctly. Set correct angle. Use different part of the knife.
Sections not properly flattened despite correct temperature and correctly aligned anti-roll plate	Dirt on knife and/or anti-roll plate. Edge of anti-roll plate damaged. Blunt knife.	Clean with dry cloth or brush. Replace anti-roll plate. Use different part of the knife.
Sections curl on anti-roll plate	Anti-roll plate does not protrude far enough beyond the knife edge.	Readjust correctly.
Scraping noise during sectioning and specimen return movement	Anti-roll plate protrudes too far beyond the knife edge and is scraping against the specimen.	Readjust correctly.

Problem	Causes	Remedies
Ridged sections	Knife damaged. Edge of anti-roll plate damaged.	Use different part of the knife. Replace anti-roll plate.
Chatter during sectioning	Specimen insufficiently frozen onto the specimen disc. Specimen disc not clamped tightly. Knife not clamped tightly enough. Specimen has been sectioned too thickly and has detached from disc. Very hard, inhomogenous specimen. Blunt knife. Knife profile inappropriate for specimen cut. Incorrect clearance angle.	Refreeze specimen onto the disc. Check disc clamping. Check knife clamping. Refreeze specimen onto the disc. Increase section thickness; reduce specimen surface area if necessary. Use different part of the knife. Use knife with different profile. Set correct angle.
Condensation on anti-roll plate and knife during cleaning	Brush, forceps and/or cloth too warm.	Store all tools on storage shelf in the cryochamber.
Anti-roll plate damaged after adjustment	Anti-roll plate too high above the knife edge. The adjustment was carried out in the direction of the knife.	Replace anti-roll plate. Be more careful next time!
Thick-thin sections	Temperature incorrect for the tissue cut. Knife profile inappropriate for the specimen cut. Ice buildup on the knife back. Handwheel speed not uniform. Knife not clamped tightly enough. Specimen disc not clamped tightly enough. Cryocompound applied to cold specimen disc; specimen detached from disc after freezing.	Select correct temperature. Use knife with different profile (c or d). Remove ice. Adapt speed. Check knife clamping. Check disc clamping. Apply cryocompound to warm disc, mount specimen and freeze.

9. Troubleshooting

Problem	Causes	Remedies
	Blunt knife. Inappropriate section thickness. Incorrect clearance angle. Microtome not dried thoroughly enough. Dried specimen.	Use different part of the knife. Select correct section thickness. Set correct angle. Dry microtome. Prepare new specimen.
Tissue sticks to the anti-roll plate	Anti-roll plate is too warm or incorrectly positioned. Fat on the corner or edge of anti-roll plate. Anti-roll plate not correctly fixed. Rust on the knife.	Cool down anti-roll plate, or reposition correctly. Remove fat from anti-roll plate. Fix correctly. Remove rust.
Flattened sections curl up when anti-roll plate is folded up	Anti-roll plate too warm.	Cool down anti-roll plate.
Sections tear	Temperature too low for the tissue cut. Blunt part, dirt, dust, frost or rust on the knife. Top edge of the anti-roll plate damaged. Hard particles in the tissue. Dirt on knife back.	Increase temperature and wait. Remove cause. Replace anti-roll plate. --- Clean.
Cryostat non-operational	Power plug not properly connected. Defective fuses, or circuit breaker has triggered.	Check if properly connected. Replace fuses, or switch circuit breaker back on. If not possible, call technical service.
Specimen disc cannot be removed	Moisture on the underside cause the specimen to freeze to the freezing shelf or specimen head.	Apply concentrated alcohol to the contact point.

9. Troubleshooting

Problem	Causes	Remedies
No or insufficient refrigeration of the cryochamber	Cooling system or electronic drive defective.	Call technical service.
Sliding window collects condensation	Air humidity and room temperature too high.	Comply with the requirements for the installation site.
No or insufficient refrigeration of the specimen	Cooling system or electronic drive defective.	Call technical service.
Lamp does not work	Lamp defective. Switch defective.	Check lamp and replace it, if necessary. Call technical service.
Both disinfection LEDs flash alternately	UV radiation provided by UV tube no longer sufficient.	Replace UV tube following the manufacturer's instructions.
	Image of an open-ended wrench appears due to fault to be rectified.	Contact technical service and follow the instructions given.

10. Temperature Selection Chart (in minus °C)

Tissue type	Chamber temperature	Specimen head temperature
Spleen	-15°C to -20°C	-11°C
Liver	-10°C -15°C	-20°C off to -15°C
Intestine	-10°C -15°C	-20°C A*: off to -20°C E*: -20°C
Heart	-10°C -15°C	A: -20°C E: -20°C to -30°C off to -20°C
Ovaries	-10°C -15°C	E: -20°C off to -15°C
Fallopian tubes	-10° -15°C	E: -20°C off to -15°C
Kidney	-10°C -15°C -20°C	-20°C A: off to -15°C -20°C
Muscle	-18°C to -20°C	-15°C
Skin with fat	-19°C	-32°C to -40°C
Hard fat	-19°C	-21°C to -25°C
Stomach	-10°C -15°C	-20°C off to -15°C
Brain	-15°C	-10°C, *E

***A = blocked, *E = complete**

The temperature values given above are based on long-term experience, however, these are only approximate values, as any tissue may require particular adjustments.

11.1 Ordering Information

Specimen disc ø 20 mm assembly	0477 43739
Specimen disc ø 30 mm assembly	0477 40044
Specimen disc ø 40 mm assembly	0477 40045
Specimen disc ø 55 mm assembly	0477 40046
Specimen disc 80x50 mm, assembly	0477 43714
O-ring blue (10 pieces), 20 mm	0477 43247
O-ring red (10 pieces), 20 mm	0477 43248
O-ring blue (10 pieces), 30 mm	0477 43247
O-ring red (10 pieces), 30 mm	0477 43248
O-ring blue (10 pieces), 40 mm	0477 43249
O-ring red (10 pieces), 40 mm	0477 43250
O-ring blue (10 pieces), 55 mm	0477 43251
O-ring red (10 pieces), 55 mm	0477 43252
Blade holder base complete	0477 40351
Blade holderextension CE-BB, complete	0477 43005
Insert for low-profile blades for blade holder CE, complete	0477 42488
Finger rest, complete	047740387
Anti-roll plate 70 mm - 50µm spacer	0477 42491
Anti-roll plate 70 mm -100µm spacer	0477 42492
Anti-roll plate 70 mm -150µm spacer	0477 42493
Glass insert 70 mm, polished	0477 42497
Knife holder base assembly	0477 42359
Knife holder CN assembly	0477 42358
Knife support CN short	0477 42380
Knife support CN	0477 42370
Knife holder attachment CNZ, assembly	0477 42363
Anti-roll plate assembly glass 50mm	0419 33981
Heat and cold extractor, assembly	0477 41039
Cold extractor, assembly	0477 43737
Heat extractor, assembly	0477 43126

11. Optional Accessories

Section waste tray	0477 40062
Brush shelf	0477 43036
Storage system, assembly	0477 42618
Shelf, movable	0477 43037
Retaining device	0477 40080
Cover freezing shelf	0477 43763
Specimen disc 37x37mm	0477 42603
Specimen disc 28x28mm	0477 42604
Bar, large	0477 42600
Bar, medium size	0477 42601
Bar, small	0477 42602
Heat extractor, Dr. Peters, assembly	0477 41338
Freezing griddle/block elevator	0201 39119
Dispensing slides 8 pieces	0201 39127
Foot rest assembly	0477 42832
Accessory kit extraction	0477 43300
Bactericidal filter 350/5865	0477 40296
Hose set, silicon 5 pieces	0477 44469
Filter assembly 25 pieces	0477 44307
Cryofect, VPE Leica Cryofect 4x 350ml, low-temp. disinfectant to -20°C	0387 42801
Safety gloves size M	0340 29011
Safety gloves size S	0340 40859
Footswitch, dummy plug CM 3050	0443 30420
Laboratory chair on sliders (8030442)	0710 34911
Footswitch, assembly	0505 33888
Easy Dip staining container white	0712 40150
Easy Dip staining container pink	0712 40151
Easy Dip staining container green	0712 40152
Easy Dip staining container yellow	0712 40153
Easy Dip staining container blue	0712 40154
Easy Dip staining rack gray	0712 40161

Blade holder CE with anti-roll guide for low-profile (NB) and high-profile (BB)

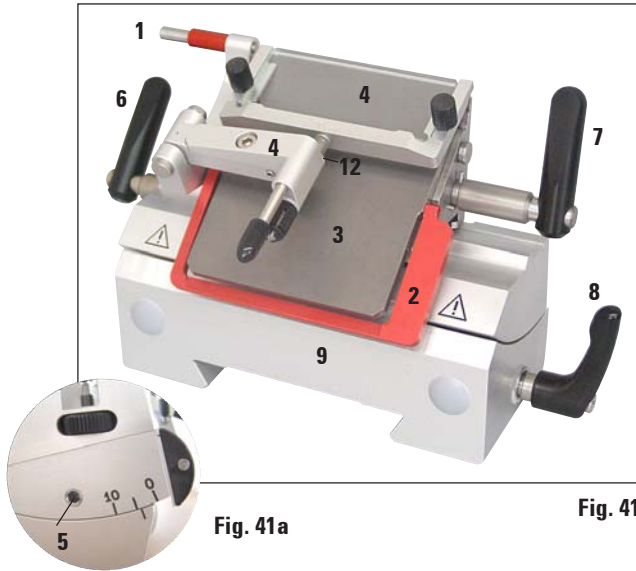

- With blade ejector (1)
- With knife guard (2)
- Integrated lateral shift and stable base
- Clearance angle adjustment (5) with 3 mm Allen key (see detail image 5, to left at knife holder) - recommended angle from 2° to 5°.
- With anti-roll guide (4)
- Lever (6) for the lateral shift
- Lever (7) for clamping the blade
- Lever (8) for clamping the base (9) to the dovetail guide in the chamber
- Pressure plate (3) for section extraction
- When using low-profile blades, the ruler (7, Fig.) must be inserted.

Fig. 41a

Fig. 41

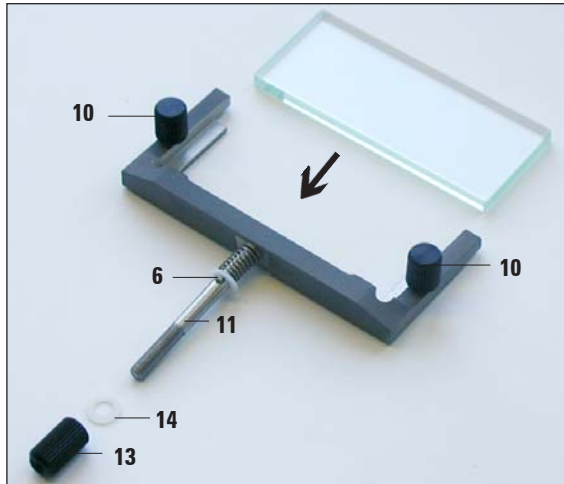

Fig. 42

Assembling the anti-roll guide system (for the blade holder CE)

1. Insert the glare-minimizing glass insert into the interchangeable frame and tighten it evenly using the knurled screw (10).
2. Insert the shaft (11) of the metal frame for exchangeable glass inserts from above into the bore of the swinging arm (12) in such a way that the pin rests in the notch.
3. Push the white plastic plate (14) from below onto the shaft (11).
4. Screw the knurled nut (13) from below onto the shaft (11).



The glass of the anti-roll guide can be used from all 4 sides when replacement is necessary (the glass stage plate can be reordered).

11. Optional Accessories

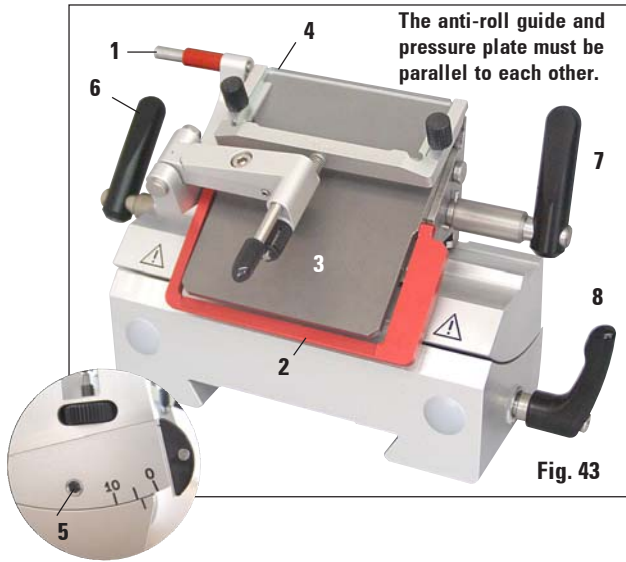

Blade holder CE with finger rest (for NB + BB)

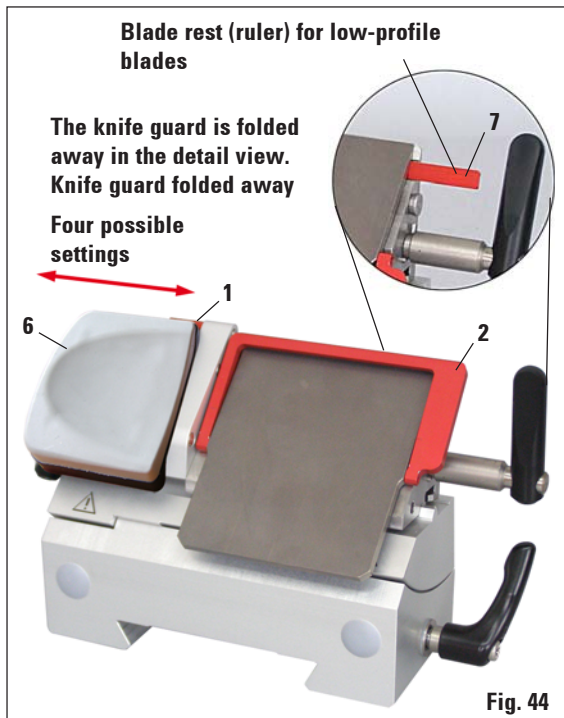

Red elements on the blade or knife holders, such as the knife guard and ejector, are protective devices that may not be removed.

- Blade ejector (1) and knife guard (2)
- Integrated lateral shift and stable base
- Clearance angle adjustment using size 3 Allen key (recommended angle between 2° and 5°)
- With finger rest (6) for brush specimen
- Clamping lever (8) for lateral shift must point downward to permit unhindered shifting of finger rest.
- when using BB knives, remove the knife support (7).

Conversion of blade holder with anti-roll guide to blade holder with finger rest

- Screw off the anti-roll guide.
- Unscrew left Allen screw using 2.5 mm Allen key and remove base of anti-roll guide.
- Attach the finger rest (6) from the left, tighten the hexagon-head screw using the No. 2.5 key – be careful of the blade ejector!



If you are working with the brush technique, the knife guard must be folded upwards.

Inserting the blade into knife holder CE

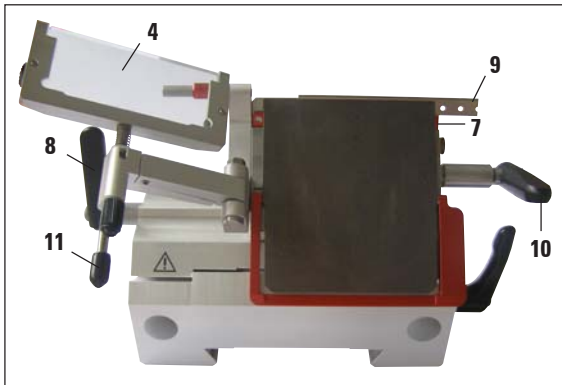

Fig. 45



Anti-roll guide system functions as a knife guard here!

1. Fold the anti-roll guide system (4) to the left – while doing so, hold the lever (11) (**not** the adjusting screw of the anti-roll guide) so that the height of the anti-roll guide remains unchanged.
2. Open the clamping lever (10) by turning it counterclockwise.
3. Carefully insert the blade (9) from above or from the side between the pressure plate and the blade rest. Ensure that the blade is inserted so that it is centered.
4. Rotate lever (10) clockwise to clamp.
5. Fold the anti-roll guide system (4) back to the side using the lever (11).

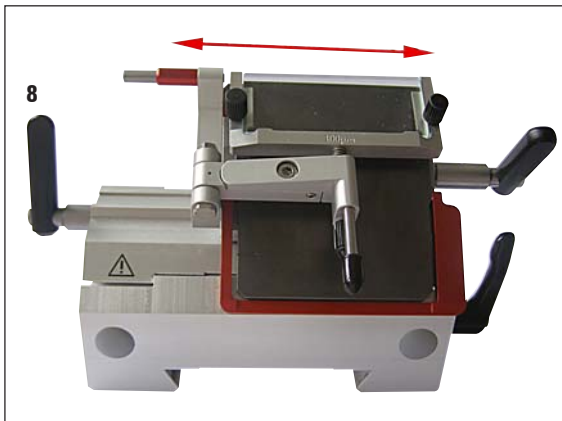

Fig. 46

Lateral shift for Blade Holder CE

If the sectioning results are not satisfactory, the knife holder can be shifted sideways in order to use another part of the blade.

To do so, follow these steps:

1. Release the clamping lever (8) by folding it back and move the knife holder back until the desired position is reached (3-point click stop enables you to accurately find a new cutting position).
2. Fold the clamping lever (8) forwards for clamping.

11. Optional Accessories

Adjusting the Knife Holder with Anti-roll Guide

You can adjust the height of the anti-roll guide system using the knurled nut (1):

- If you turn the nut counterclockwise, the anti-roll guide system moves toward the blade.
- If you turn the nut clockwise, the anti-roll guide system moves away from the blade.

If the anti-roll guide system is in the wrong position relative to the cutter, the following problems will result:



Fig. I: The section rolls over the glass insert of the anti-roll guide system.

Error: Glass insert not high enough.

Remedy: Turn the knurled nut counterclockwise until the section is pushed between the blade and anti-roll guide as shown in Fig. III.



Fig. II: Section tears and block hits the glass insert after sectioning. The section rolls over the glass insert of the anti-roll guide system.

Error: Anti-roll guide system is set too high.

Remedy: Turn the knurled nut clockwise until the section is pushed between the blade and anti-roll guide as shown in Fig. III.



Generally, we recommend pre-adjusting the anti-roll guide system at a high section thickness (e.g. 10 μm). Start from there and work your way down to the desired section thickness in small increments, readjusting the anti-roll guide system at each increment using the knurled nut.

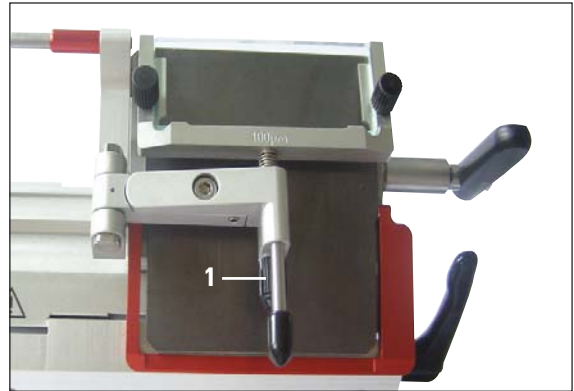

Blade holder CE with glass anti-roll guide

Fig. 47

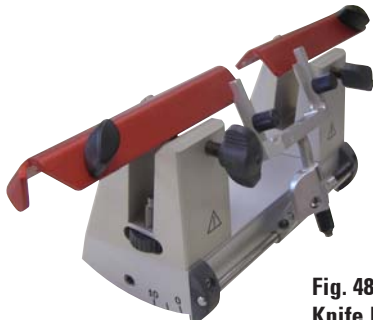

Fig. 48,
Knife holder CN with glass anti-roll guide

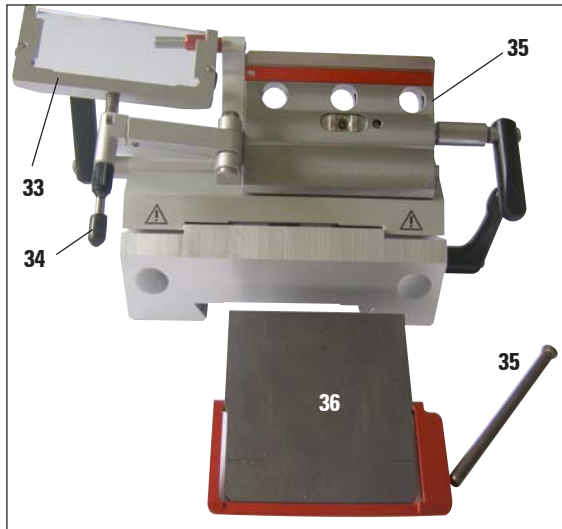

Fig. 49

Cleaning the knife holder CE

Daily cleaning

1. Fold the anti-roll guide system (33) to the left while holding it down by the lever (34).
2. Unscrew the bolts (35) of the pressure plate.
3. Afterwards, the pressure plate (36) can be removed for cleaning (with alcohol or acetone).



For disinfection, commercially available, mild cleaners and disinfectants can be used – we recommend Leica Cryofect.



Fig. 50

Cleaning the knife holder CN

Daily cleaning

For daily cleaning, it is enough to fold the anti-roll guide system forwards and remove the section waste from the knife holder using a dry brush. Please use a cold brush, as otherwise the section waste will thaw and stick to the knife holder.



It is not necessary to oil the parts, such as the T-piece on the microtome base plate, clamping lever etc.

Disinfection (e.g. with Leica Cryofect)

Spray contaminated surfaces with a uniform coat of concentrate or wipe them down with a rag soaked in it, allow it to make contact for 15 minutes, then wipe it off.

11. Optional Accessories

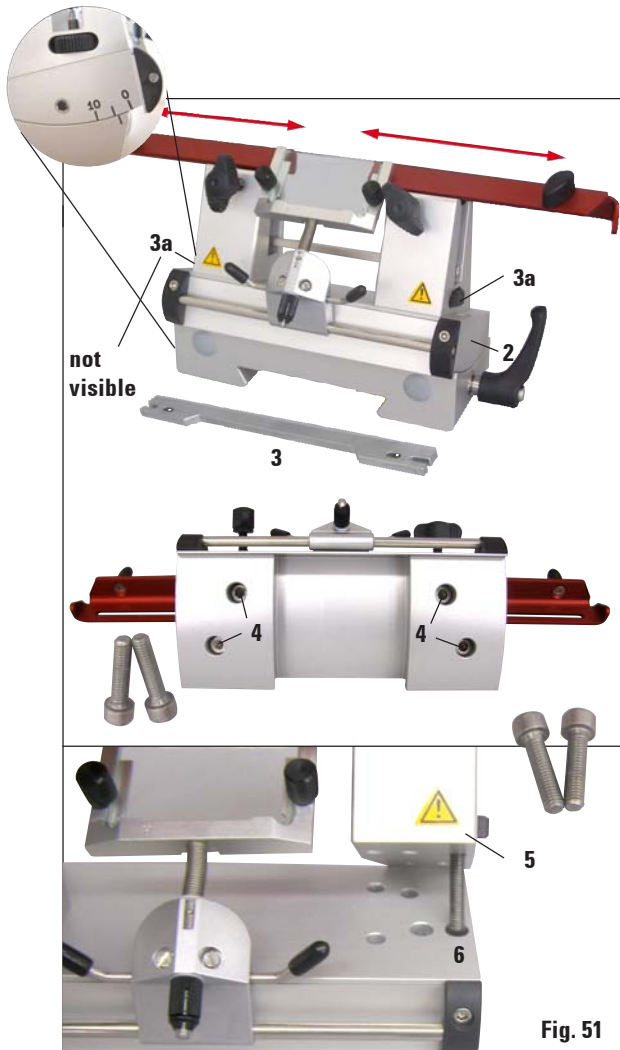

Fig. 51

Knife holder CN with anti-roll guide – Moving the clamping chucks



The specimen disc 50x80mm is suitable only for section thicknesses up to approx. 5µm (due to the large specimen size).

The large specimen disc (80x50 mm) should preferably be used with knife holder CN and the 16 cm C-profile steel knife.

The clamping jaws are factory-installed in the knife holder with a clearance of 64 mm. If necessary, both clamping chucks can be offset with a clearance of 84 mm.

Perform the following steps:

- Use a 3 mm Allen key to loosen the screw over the clearance angle adjustment (1) and remove the segment arch (2) from the knife holder base.
- Use a 3 mm Allen key to loosen the screws (4) on the underside of the segment arch.
- Carefully pull the clamping jaw (5) on the right upward and insert it in the neighboring hole (6). Tighten the screws from the underside of the segment arch. Repeat on the left side.
- Insert the long knife support (3) on the side over the knurled screw (3a) so that the recess faces the user – turn the height adjustment knurled screws until the lower stop is reached.
- The knife can now be inserted from the side and its height adjusted via the knurled screws (3a).



Never work with only one clamping jaw, as this does not ensure the stability required for the sectioning process. Also, a long knife will not be sufficiently protected by the knife guard in this instance.

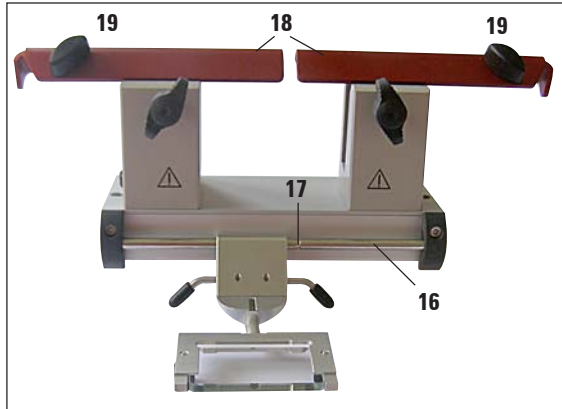

Fig. 52

Knife guard/lateral movement for knife holder CN

The knife guard (18) is fixed and integrated into the clamping jaws. The knife guard has handles (19) that allow it to be moved. The knife guard is adequate for knives up to 22 cm in length. Always cover exposed parts of the knife blade after sectioning.

The anti-roll guide system can be moved side-ways (only for the 84 mm variant). To better find the mid position, a groove (17) is provided in the shaft (16).

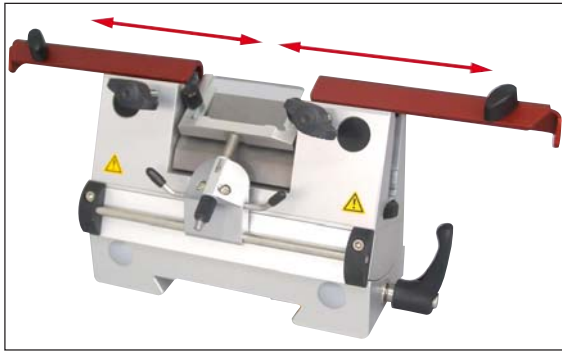

Fig. 53

Knife holder CNZ with anti-roll guide

- Pressure plate permits the full length of the knife to be utilized.
- Use hard metal and steel knives here.



The height of resharpened knives must be adjusted using knurled screws (3) (approx. 1 mm under the edge of the clamping jaw). Ensure that the knife is adjusted in parallel vertically.

11. Optional accessories

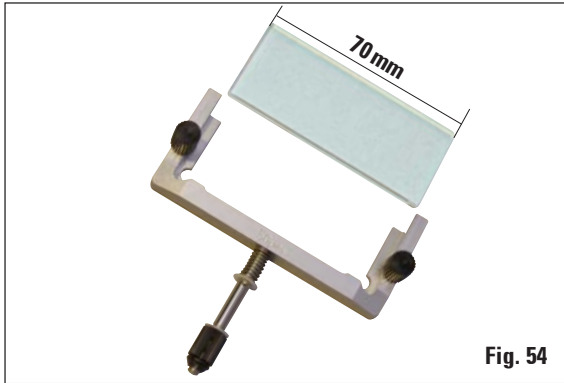

Fig. 54

Anti-roll guide system

Anti-roll plate (with glass stage plate)

Available with various spacers:

- 70 mm - 50 μm , for section thickness: < 20 μm
- 70 mm - 100 μm , for section thickness: 20 μm - 100 μm
- 70 mm - 150 μm , for section thickness: > 100 μm



The 50 μm and 100 μm anti-roll plates are included in the standard scope of delivery of the blade holder CE.

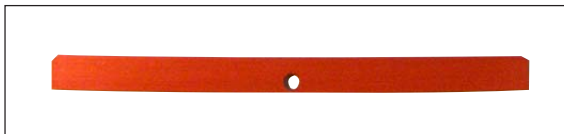

Fig. 55

Straightedge (blade rest)

Insert for low-profile blades for blade holder CE (0477 43005) - replacement



The blade rest is also included in the standard scope of delivery of the blade holder CE.

When using low-profile blades, the blade rest (7) must be inserted into the blade holder first, then the low-profile blade (see page 50, Fig. 40).



Fig. 56

Bacterial filter

- Bactericidal filter 350/5865, pack of 1 unit. Recommendation: replace bactericidal filter every three months.

(note date on filter when installing it)



Filter bags and bacteria filter must be disposed of according to applicable laboratory regulations for infectious material. Filters must be replaced, not cleaned.



Fig. 57

Replacement filters for extraction system (pack of 25)

- Change when vacuum power is impaired.
- When using the cryostat frequently, check the filter bag daily and replace as required.

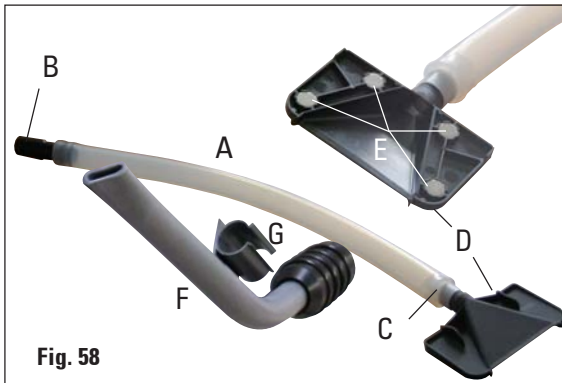

Fig. 58

Vacuum extraction system

- A** - Hose
- B** - Hose adapter, black (for the filter bag in the instrument)
- C** - Hose adapter, white (for suction nozzle **D** or extraction nozzle **F**)
- D** - Suction nozzle – with 4 magnets (**E**) on knife holder
- G** - Plastic clip (for parking the suction nozzle)

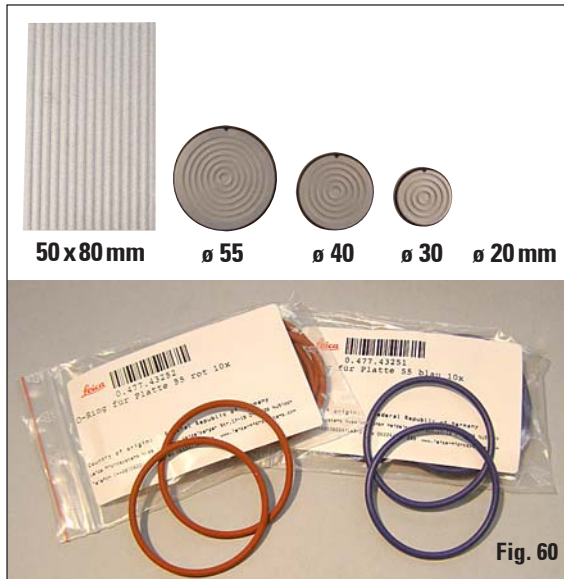

Fig. 59

Storage system, complete ("hidden")

- for installation in rear area of cryostat - for cold storage of specimen discs and sectioning accessories
(For assembly, refer to page 26)

11. Optional Accessories



- Specimen discs in various dimensions



The specimen disc 50x80mm is suitable only for section thicknesses up to approx. 5 μ m (due to the large specimen size).

O-rings in various colors

- for plate \varnothing 20 mm (red or blue), 10x each
 - for plate \varnothing 30 mm (red or blue), 10x each
 - for plate \varnothing 40 mm (red or blue), 10x each
 - for plate \varnothing 55 mm (red or blue), 10x each
- for color-marking of specimen disc

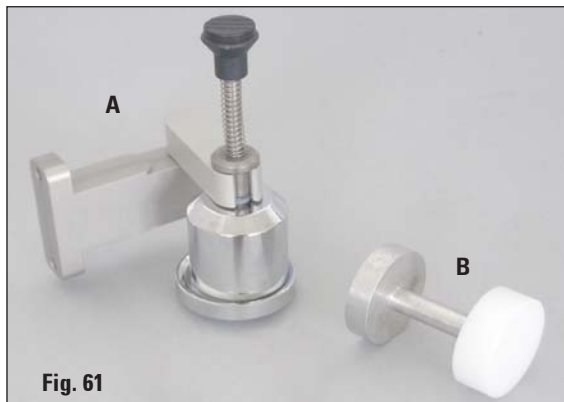

- A** Heat extractor with parking station, stationary
 - for installation in the cryostat - consisting of: support device, heat extractor and parking station
- B** Heat and cold extractor
 - suitable for two different applications: extracts cold when stored in warm environment; extracts heat, when stored in cold environment.

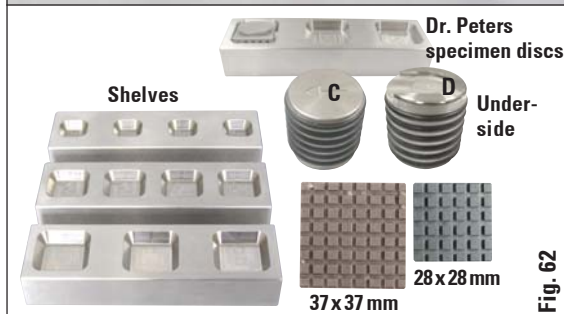

- The specimen discs of the **Dr. Peters cooling system** can be conveniently removed from the shelf using the underside of the heat extractor (removal aid **D**). Slide the underside over the specimen disc in the direction of the arrow so that the disc remains in the slot and can be removed from the rack.

Embedding well bar, large, with 3 wells, LxWxH: 30 x 30 x 7 mm
 Embedding well bar, medium, with 4 wells, LxWxH: 24 x 24 x 6 mm
 Embedding well bar, small, with 4 wells, LxWxH: 18 x 18 x 6 mm



Footswitch,
for use with motorized instruments only

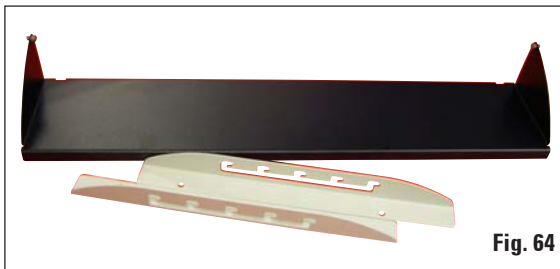

Adjustable support,
individually height-adjustable foot rest with 5 settings.



Brush shelf,
for use with blade holder CE



Storage system, movable
for installation in front area of cryostat - for cold storage of preparation tools

12. Maintenance and Cleaning

12.1 General Maintenance

The microtome is virtually maintenance-free. To ensure a smooth operation of the instrument over several years we recommend the following:

- At least **once** a year, have the instrument inspected by a qualified service engineer authorized by Leica.
- Enter into a service contract at the end of the warranty period. For further information, please contact your local Leica service center.
- Clean the instrument daily.
- Every day, remove frozen section waste from the cryostat using a cold brush or use the (optional) extraction device.
- Remove the section waste tray for emptying.
- Remove the storage shelves and the brush shelf for cleaning.
- Remove the closed sliding window from the front by gently lifting it (see p. 63, "Replacing the Fluorescent Lamp").



Do not use organic solvents or any other aggressive substances for cleaning and disinfecting!
Use only disinfectants listed in this manual such as Leica Cryofect (alcohol or other common alcohol-based disinfectants).

- Drain the cleaning liquid through the hose after the prescribed reagent time is over and collect it in the waste container (1).

Emptying the condensate bottle

Check the fill level of the condensate bottle (1) visible in the front panel of the instrument at regular intervals.

- The bottle collects the condensate that accumulates during defrosting.



Fig. 67



Dispose of the contents of the bottle in accordance with laboratory regulations.

Basically, we recommend UV disinfection (see page 35 for detailed instructions).

For easy-to-use spray disinfection we recommend Leica Cryofect. (Cryofect is not available in all countries!)

The cryostat has to be disinfected after each daily use.



Comply with the instructions for use!
The glass anti-roll plate can remain in place during disinfection.



It is not necessary to oil the parts, such as the T-piece on the microtome base plate, clamping lever etc.

- In case of visible pollution (such as dust), clean the air inlet opening (Fig. 10, p. 18) of the condenser on the bottom right-hand side of the instrument using a brush, broom or extraction cleaner in the direction of the louvers.



Do not turn the instrument on before the cryochamber is completely dry!

Frost formation!

The front panel and the slit cover of the microtome must be completely dry before turning on the instrument!

Dry all parts completely before reinserting them in the cryochamber!

12.2 Changing Fuses

- In case of power supply faults, please contact an authorized Leica service technician immediately.



Do not carry out any repairs on your own as this will invalidate the warranty.

Repairs may only be carried out by qualified service engineers authorized by Leica.

12. Maintenance and Cleaning

12.3 Replacement of the Lamp/UVC Lamp



Turn the instrument off with the automatic power fuse and pull the power plug, before replacing the lamp!

If the lamp is broken, it must be replaced by the technical service, as the replacement involves a high risk of injury. Beware of the metallic mercury in the UV lamp; handle it carefully and dispose of it properly.



A UVC lamp has an estimated service life of approx. 9,000 hours. Each on/off switching cycle reduces the lamp life by approx. one hour plus burning time (30 minutes or 180 minutes respectively).

When both disinfection indicator lights are blinking alternately in control panel field 1, the UVC lamp must be replaced.



Instructions on how to replace the UVC lamp are provided together with the replacement lamp (spare part).

12. Maintenance and Cleaning

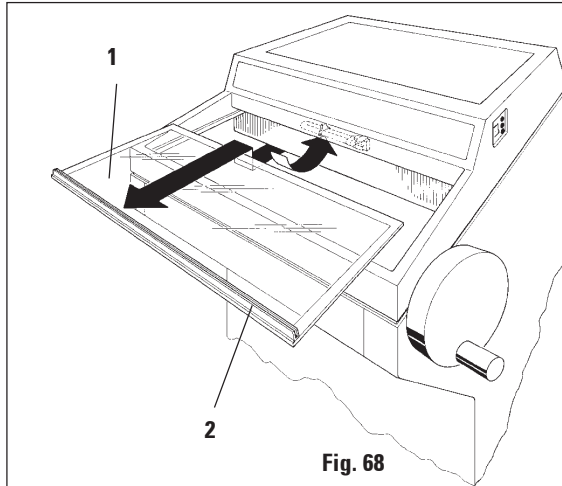

Fig. 68

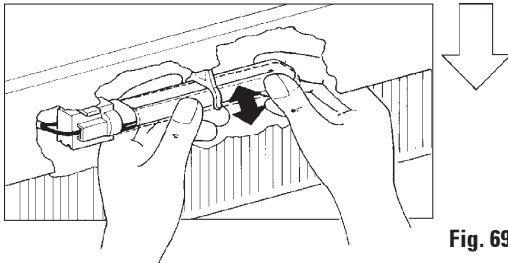

Fig. 69

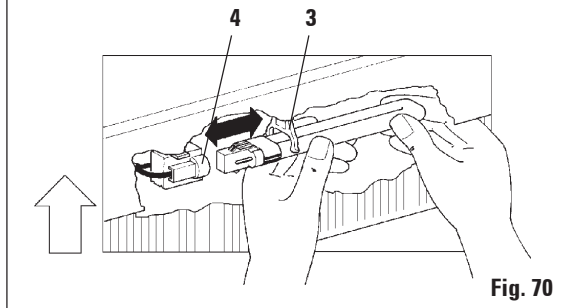

Fig. 70

- Slightly lift the sliding window (1) holding it by the grip (2) and pull it out to the front.

Removal of the lamp

- The lamp is mounted behind a glare shield and therefore not visible.
- Touch the lamp for better orientation.
- Lightly tilt the fluorescent tube down to the left and pull it out of the clip (3).
- Hold the lamp with both hands and pull it to the left out of the holder (4).



Only use lamps of the same specification!

Installation of the new lamp



Type:
OSRAM DULUX L 18W/840.

- Hold the lamp in the correct mounting position as shown and push it to the left until it engages in the holder.

13. Decontamination Certificate (master)

Dear Customer,

Any product which is to be returned to Leica Microsystems or serviced on site, must be cleaned and decontaminated in the appropriate manner. Leica accepts that it is not possible to decontaminate for CJD and its variants and in this instance following current customer safety guidelines is acceptable. Equipment exposed to CJD samples cannot be returned to Leica Microsystems for repair.

This certificate, duly completed, must be placed in the unit prior to packaging or handed over to the service engineer. Packages will not be opened nor servicing commenced until the Company or service engineer have received a satisfactory certificate. Should returned goods be considered a hazard by the Company, they will be returned immediately to the customer at his/her expense.

NB: Microtome knives must be in boxes.

Description

[Redacted]	
Name/Model	Fabr. No.
[Redacted]	[Redacted]
KAT No.	Quantity
[Redacted]	[Redacted]



Tick Box A if applicable. Otherwise please complete all parts of B, providing further information as requested or appropriate.

A Yes This equipment has not been in contact with unfixed biological samples.

B **1** This equipment has been exposed internally or externally to hazardous materials as indicated below:

Yes No

Blood, body fluids, pathological samples

Other biohazards

Chemicals/substances hazardous to health

Other hazards

Please provide further detail here:

[Redacted]
[Redacted]
[Redacted]
[Redacted]

2

This equipment has been cleaned and decontaminated:

Yes No

If yes, give details of the method:

[Redacted]

Please provide further detail here:

[Redacted]
[Redacted]

If no*, please indicate why not:

[Redacted]

* Such equipment must not be returned without the written agreement of Leica Microsystems.

3

Yes **No** The equipment has been prepared to ensure safe handling/transportation.
Whenever possible, please use the original transportation case/box.

Important - to avoid refusal of shipment:

Place one copy in the unit prior to packaging or hand it over to the service engineer. Customer assumes all responsibility for the immediate return shipment of articles sent to Leica without proper decontamination documentation.

If you have any further questions, please call your local Leica organization.

Leica Internal Use: If applicable, note corresponding Job and RAN-/RGA-Number:

Job Sheet No.: _____

SU Return Goods Authorisation: _____

BU Return Authorization Number: _____

Signature/Date

Name

Position

eMail

Institute

Department

Address

Phone

Facsimile



MICROSYSTEMS

Leica Biosystems Nussloch GmbH

Heidelberger Str. 17-19

69226 Nussloch, Germany

Phone: ++49 (0) 6224 143 0

Fax: ++49 (0) 6224 143 200

www.leica-microsystems.com

14. EC Declaration of Conformity



EC Declaration of Conformity



We herewith declare, in exclusive responsibility, that the

Leica CM1950 Cryostat

was developed, designed and manufactured to conform with the

- Council Directive 2006/95/EC (Low Voltage),
- Council Directive 89/336/EEC, Appendix I (Electromagnetic Compatibility) and
- European council Directive 98/79/EC (IVD)

including their amendments up to the date mentioned below.

The following harmonized standards were applied:

- **EN 61010-1: 2001**
Safety requirements for electrical equipment for measurement, control and laboratory use - Part 1: General requirements
- **EN 61010-2-101: 2002**
Safety requirements for electrical equipment for measurement, control and laboratory use - Part 2-101: Particular requirements for in vitro diagnostic (IVD) medical equipment
- **EN 591: 2001**
Instruction for use for in vitro diagnostic instruments for professional use
- **EN 61326-1: 2006**
Electrical equipment for measurement, control and laboratory use - EMC requirements - Part 1: General requirements
- **EN 61326-2-6: 2006**
Electrical equipment for measurement, control and laboratory use - EMC requirements
- **EN 61000-3-2: 2000**
Electromagnetic compatibility (EMC)
Part 3-2: Limits - Limits for harmonic current emissions
- **EN 61000-3-3: 1995 + A1: 2001**
Part 3: Limits -
Section 3: Limitation of voltage changes, voltage fluctuations and flicker in public low-voltage supply systems, for equipment with rated current ≤ 16 A per phase
Electromagnetic compatibility (EMC)
- **EN 418: 1992**
Emergency stop equipment.
Principles for design.
- **EN 1037: 1995**
Safety of machinery.
Prevention of unexpected start-up.

In addition, the following in-house standards were applied:

- **DIN EN ISO 9001: 2000**
Quality management system - requirements.

Leica Biosystems Nussloch GmbH
Postfach 1120
D-69222 Nussloch
October 11, 2007

.....
Anne De Greef-Safft
President Biosystems Division

Warranty

Leica Biosystems Nussloch GmbH guarantees that the contractual product delivered has been subjected to a comprehensive quality control procedure based on the Leica in-house testing standards, and that the product is faultless and complies with all technical specifications and/or agreed characteristics warranted.

The scope of the warranty is based on the content of the concluded agreement. The warranty terms of your Leica sales organization or the organization from which you have purchased the contractual product shall apply exclusively.

Technical service information

If you require technical service or replacement parts, please contact your Leica sales representative or dealer who sold the product.

Please provide the following information:

- Model name and serial number of the instrument.
- Location of the instrument and name of the person to contact.
- Reason for the service call.
- Date of delivery.

Shutdown and disposal of the instrument

The instrument or parts of the instrument must be disposed of in compliance with the local laws.

Dispose of UV tube separately.

16. People's Republic of China

- Administrative Measures on the Control of Pollution Caused by Electronic Products -

部件名称 Name of the part	有毒有害物质或元素 Hazardous substances					
	铅 (Pb)	汞 (Hg)	镉 (Cd)	六价铬 (Cr ⁶⁺)	多溴联苯 (PBB)	多溴二苯醚 (PBDE)
印刷电路板 printed circuit boards	X	O	O	O	O	O
电子元器件 electronic components	X	O	O	O	O	O
机械部件 mechanical parts	X	O	O	X	O	O
光学元器件 optical components	X	O	X	O	O	O
电缆 cables	O	O	O	O	X	X
光源 light sources	O	X	O	O	O	O

- o : 表示该有毒有害物质在该部件中的含量均在SJ/T 11363-2006 标准规定的限量要求以下。
Indicates that the concentration of the hazardous substance in all materials in the parts is below the relevant threshold of the SJ/T 11363-2006 standard.
- x : 表示该有毒有害物质至少在该部件的某一材料中的含量超出SJ/T 11363-2006 标准规定的限量要求。
Indicates that the concentration of the hazardous substance of at least one of all materials in the parts is above the relevant threshold of the SJ/T 11363-2006 standard.

Note: The actual product may or may not include in all the part types listed above

Free Manuals Download Website

<http://myh66.com>

<http://usermanuals.us>

<http://www.somanuals.com>

<http://www.4manuals.cc>

<http://www.manual-lib.com>

<http://www.404manual.com>

<http://www.luxmanual.com>

<http://aubethermostatmanual.com>

Golf course search by state

<http://golfingnear.com>

Email search by domain

<http://emailbydomain.com>

Auto manuals search

<http://auto.somanuals.com>

TV manuals search

<http://tv.somanuals.com>