

**Jabra**  
**M5390**  
MULTIUSE

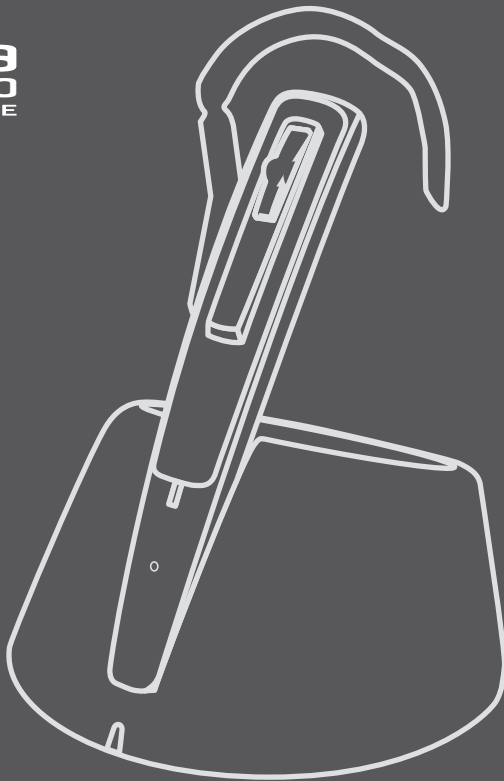

USER MANUAL

**Jabra**

**The Jabra brand is wholly owned by GN Netcom. Customer service is provided by GN Netcom. Please see details below.**

<b>Australia</b>	61 3 8823 9111	<b>Japan</b>	81 3 5297 7975
<b>Austria</b>	43 1 403 4134	<b>P. R. China</b>	86 10 6583 2311
<b>Canada</b>	1 905 212 11 02	<b>Singapore</b>	65 65 42 45 50
<b>Denmark</b>	45 43 43 15 52	<b>Spain</b>	34 91 639 80 64
<b>France</b>	33 1 30 58 30 31	<b>Sweden</b>	46 8 693 09 00
<b>Germany</b>	49 803 126 510	<b>United Kingdom</b>	44 1784 220 140
<b>Hong Kong</b>	852 21 04 68 28	<b>USA</b>	1 603 598 1100
<b>Italy</b>	39 02 5832 8253-61-74		

## Thank you

Thank you for purchasing the Jabra M5390 Multiuse headset.

The Jabra M5390 Multiuse headset is supplied together with the Jabra A335w Dongle and the Jabra M5390 Multiuse base. This unique combination allows you to use one single headset for all your communication needs. The Jabra M5390 Multiuse headset connects simultaneously to mobile phones and desk phones - or to mobile phones and PC softphones.

The headset base and the headset are used together with your desk phone.

The dongle allows the headset to communicate with a softphone such as Microsoft Office Communicator, Skype or Cisco IP Communicator, etc. through your PC or laptop.

The headset can also be connected directly to your Bluetooth®-enabled mobile phone.

Furthermore, the headset and dongle have been optimised for the new wideband technology and are compliant to the TIA-920 specifications that ensure clear and crisp voice reception and transmission (wideband is only supported between the dongle and the headset).

## Contents

1.	Overview . . . . .	2
2.	Fitting the headset . . . . .	3
3.	Setting up your desk phone . . . . .	4
4.	Setting up your mobile phone . . . . .	7
5.	Making a call from your desk phone . . . . .	8
6.	Answering a call from your desk phone . . . . .	9
7.	Making and answering a call from your mobile phone . . . . .	10
8.	Features . . . . .	12
9.	Reset/Pairing . . . . .	15
10.	Using the Jabra M5390 Multiuse Headset with multiple Bluetooth®-enabled devices . . . . .	16
11.	Operating devices in multiuse scenarios . . . . .	16
12.	Switching between Base and Jabra A335w Dongle in a multiuse scenario . . . . .	17
13.	Troubleshooting & FAQ . . . . .	17
14.	Maintenance, safety and disposal . . . . .	18
15.	Appendix – GN 1000 Remote Handset Lifter (RHL) (optional accessory) . . . . .	19

## 1. Overview

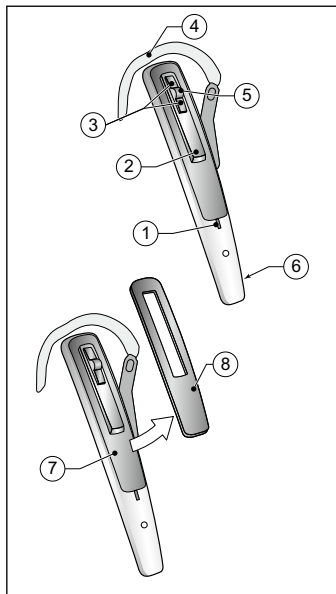
**Headset**

- [1] Visual indicator
- [2] Answer/End button
- [3] Volume up/down
- [4] Ear hook
- [5] Mute button
- [6] Microphone
- [7] Reset button
- [8] Snap-on cover (replaceable)

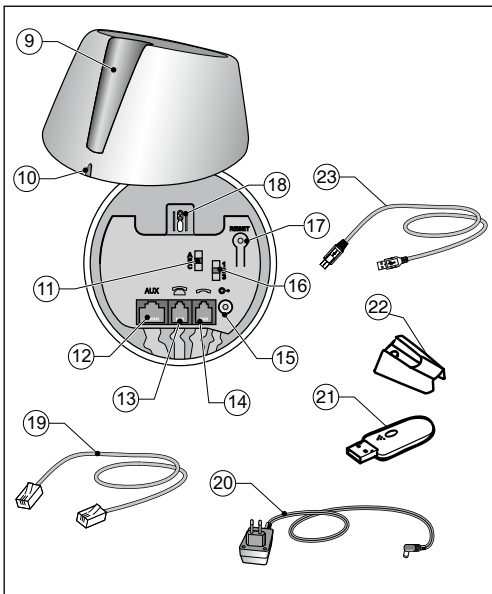
**Base unit**

- [9] Charge cradle
- [10] Visual indicator
- [11] Clear dial tone switch
- [12] AUX port
- [13] Telephone port
- [14] Handset port
- [15] AC power adapter port
- [16] Transmit volume
- [17] Reset button
- [18] Headset switch

**Cords & adapters**

- [19] Connection cord
- [20] AC power adapter
- [21] Dongle
- [22] Travel charger
- [23] USB cable for travel charger

**Definition of "Tap, double tap and press":**

**Tap** = Button press for up to 0.8 sec.

**Press** = Button press for longer than 0.8 sec, and release before 1.5 sec. Tone indication is heard.

**Double tap** = Two taps made within 0.5 sec.

## 2. Fitting the headset

2.1

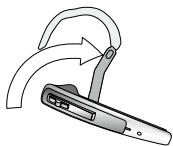

2.2

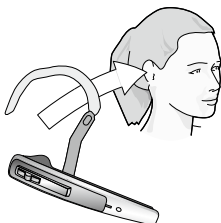

### Fitting to ear

**2.1** Open hinged ear hook as wide as possible. <sup>1)</sup>

**2.2** Hold headset to the ear so speaker fits comfortably and microphone points towards the mouth.

2.3

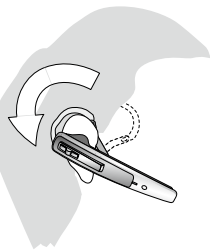

2.4

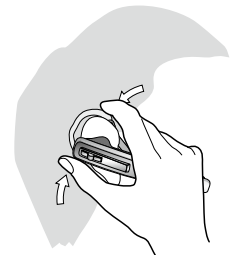

**2.3** Close hinged ear hook over the ear.

**2.4** Adjust ear hook for a comfortable fit.

2.5

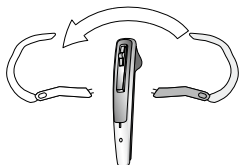

### Fitting to left ear

**2.5** Pull ear hook hinge from the slot and insert it on opposite side of headset marked with L. Perform steps 2.1 – 2.4 above.

1) **Note:** The headset is configured for use with the right ear.

### 3. Setting up your desk phone

#### 3.1

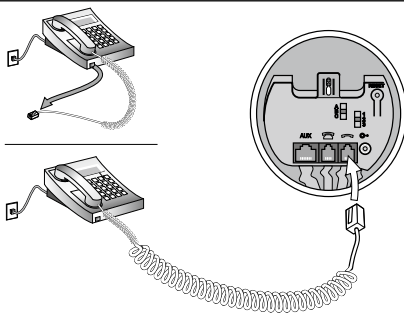

If your telephone has a headset port, go directly to 3.2b.

**3.1** Unplug handset cord from your telephone and connect to the port on base unit marked with .

#### 3.2a

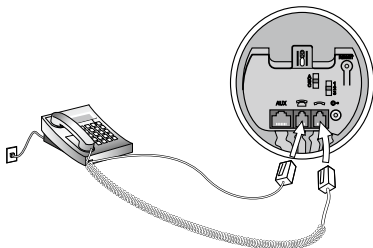

**3.2a** Connect enclosed telephone cord to the now empty handset port on telephone, and to the port on base unit marked with .

#### 3.2b

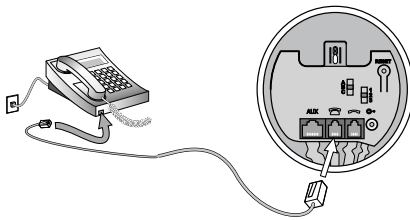

**3.2b** (Headset port use only) Connect enclosed telephone cord to the headset port on telephone, and to the port on base unit marked with .

#### 3.3

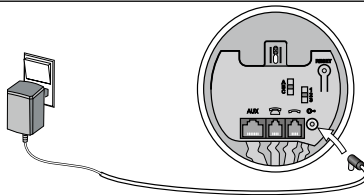

**3.3** Connect AC power adapter to port on bottom of base unit, then connect to AC power outlet. If the headset is disconnected, the indicator on the base will flash green.

**Note:** AUX port is used for Remote Handset Lifter (RHL). Please refer to Appendix.

3.4

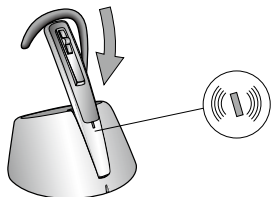

**3.4** Place headset in charge cradle and **charge for a minimum of 30 min. before use.** A full charge takes about 2 hours. Visual indicator on headset will flash green while headset is charging, and light steady green when fully charged. The same procedure is to be followed when using the travel charger.

3.5



**3.5** Turn on headset by pressing Answer/End button for 1 sec. (visual indicator will flash blue four times and headset will beep three times), or by placing headset in charge cradle. Turn off headset by pressing Answer/End button for 2 sec. (visual indicator will flash blue four times and headset will beep three times).

3.6

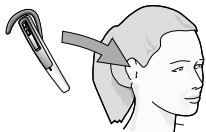

### Clear dial tone

**3.6** Take headset out of charge cradle and put it on.

3.7

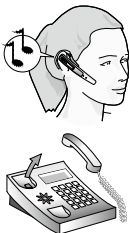

**3.7** Lift handset from telephone and listen for a dial tone in headset.

3.8

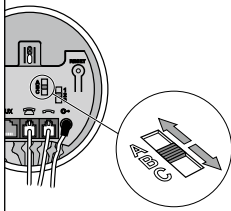

**3.8** If dial tone is missing or unclear, slowly slide the clear dial tone switch on bottom of base unit through the 3 settings.

3.9

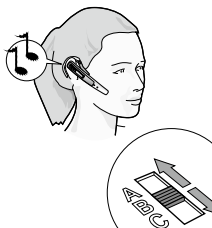

**3.9** Set switch to the position that gives the clearest dial tone.

## 3.10

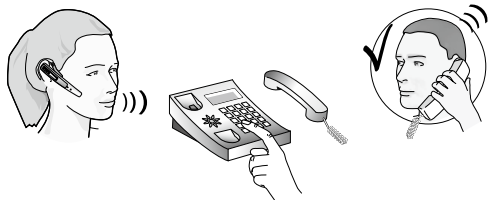
**Setting transmit volume**

**3.10** Make a call (see section 4) to someone who can act as a test person.

## 3.11

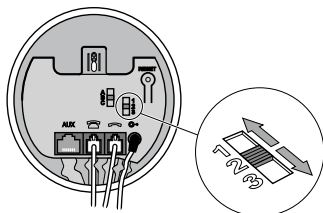

**3.11** Adjust outgoing volume with transmit volume control on base unit. Switch through the 3 settings until test person confirms the appropriate volume. <sup>1)</sup>

## 3.12

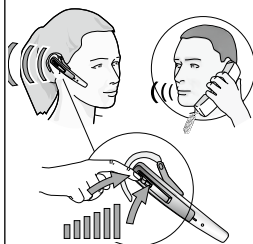
**Setting incoming volume**

**3.12** During a call, adjust incoming volume by pressing Volume button on headset.

## 3.13

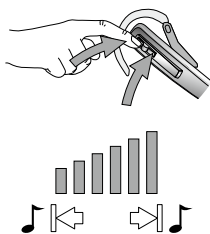

**3.13** A tone in headset will indicate when min./max. volume is reached.

**1) Note:** If you can hear your own voice, transmit volume is probably too high. Reduce volume setting on your desk phone (if available feature) and compensate by increasing volume on headset.



## 4. Setting up your mobile phone

### Setup

#### Pairing your headset with your mobile phone

**NOTE:** *Before use, please charge your headset (see 3.4).*

Before using your Jabra M5390 Multiuse headset with a mobile phone, you need to pair it with your mobile phone.

- Make sure the headset is off.
- During start-up keep pressing the Answer/End button for three seconds. Alternatively remove the snap-on cover and press the reset button on the headset for three seconds. The visual indicator on headset will light constant blue. (see 9.1)
- Set your Bluetooth® phone to 'discover' the Jabra M5390 Multiuse headset:
  - Follow your phone's User Manual. This usually involves going to a 'setup,' 'connect' or 'Bluetooth' menu on your phone and selecting the option to 'discover' or 'add' a Bluetooth® device.
  - Your phone will find the Jabra M5390 Multiuse headset and ask if you want to pair with it.
- Accept pairing by pressing Yes/OK (or similar) on the phone and confirm with the passkey or PIN '0000' (4 zeros).
- Your phone will confirm when pairing is complete. If pairing is unsuccessful, repeat the steps above. Some mobile phones require manual connection after pairing. Note that on some mobile phones, the headset has to be set as "Trusted device".

**NOTE:** *If you accidentally put the headset into pairing mode, tap the Answer/End button to exit pairing mode.*

- ❗ **IMPORTANT:** *The same headset can be paired with multiple mobile phones. However, if you have multiple mobile phones paired, switched on and within range of the headset, the headset will not be able to connect to the base. It is only possible to be connected to one mobile phone and the headset base at a time. To be able to connect to the headset base, only have one paired mobile phone turned on and within range of the headset.*

## 5. Making a call from your desk phone

5.1

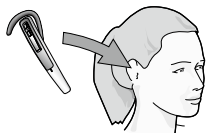

5.2

5.1 Put on headset. <sup>1)</sup>

5.2 Lift handset from telephone, or press telephone's "line" button if connected to the headset port. Then tap Answer/End button to transfer the call to headset.

5.3

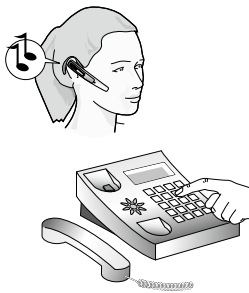

5.4



5.3 Wait for dial tone, then dial number.

5.4 To end call, tap the Answer/End button on the headset and replace handset on telephone, or press telephone's "end call" button if base is connected directly to telephone's headset port.

5.5

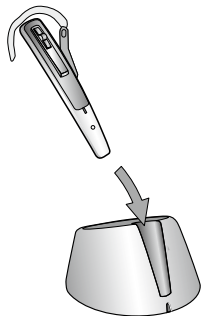

5.6



### Making a call with handset

5.5 Place headset in charge cradle.

5.6 Use handset as usual.

**1) Note:** If making a call with telephone handset, make sure the headset is placed in charge cradle. Otherwise, the call will be routed through to the headset.

## 6. Answering a call from your desk phone

6.1

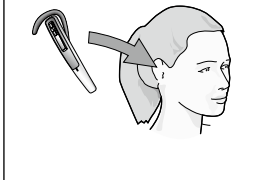

6.2



6.1 Put on headset. <sup>1)</sup>

6.2 Lift handset from telephone, or press telephone's "line" button if connected to the headset port. Then tap Answer/End button to transfer the call to headset.

6.3



6.3 To end call, tap the Answer/End button on the headset and replace handset on telephone, or press telephone's "end call" button if base is connected directly to telephone's headset port.

6.4

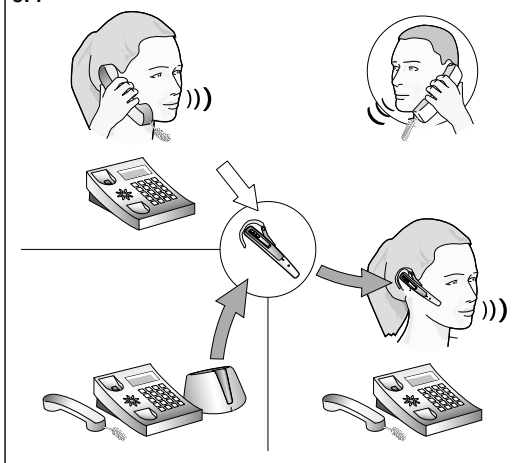

### Switching from handset to headset

6.4 During a call using telephone handset, take headset from charge cradle. Tap Answer/End button and the call will automatically be routed to the headset. <sup>1)</sup>

6.5

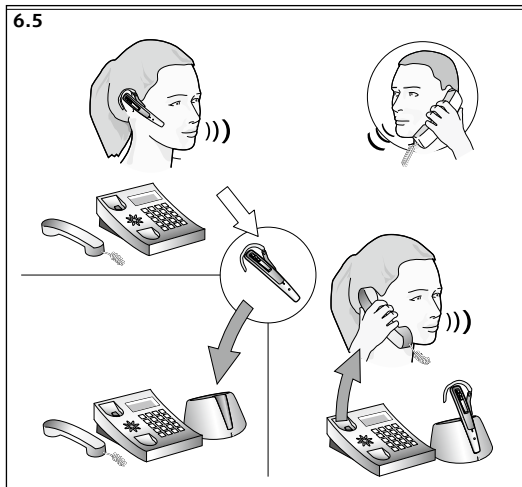

### Switching from headset to handset

**6.5** During a call using the headset, pick up telephone handset and replace headset in charge cradle. The call will not be routed through to the telephone handset until headset is in the charge cradle.

**1) Important:** Do not replace handset on telephone as this will disconnect the call.

## 7. Making and answering a call from your mobile phone

### Making and ending a mobile phone call

- When you make a call from your mobile phone, the call will transfer to your headset automatically (this is subject to phone settings, see your mobile phone's User Manual to find out how to activate this feature).

If your phone does not allow this feature, see your mobile phone's User Manual on how to answer a call with a headset.

- To end a call, tap the headset Answer/End button, OR press End/No (or similar) on your mobile phone.

### Answering and ending an incoming mobile phone call

- To answer, tap the headset Answer/End button on your headset after the first ring OR, if the headset is placed in the base, simply remove it from the base.
- To end a call, tap the headset Answer/End button, OR press End/No (or similar) on your mobile phone, or place the headset in the base.

**ⓘ IMPORTANT:** If you answer a call on your mobile phone handset, some mobile phone models will not automatically transfer the call to your headset.

### Switching from headset to mobile phone

You can switch from your headset to your mobile phone during an active call. You might want to do this if, for example, your headset battery is running low.

- Use the menu on your mobile phone to switch from headset to mobile phone during an active call (see your mobile phone's User Manual).

### Switching from mobile phone to headset

It is possible to switch from your mobile phone to your headset during an active call.

- Use the menu on your mobile phone to switch from mobile phone to headset during an active call (see your mobile phone's User Manual).

### Rejecting an incoming call

- Press the headset Answer/End button when the phone rings to reject an incoming call. Depending on your phone settings, the person who called will either be forwarded to your voice mail or hear a busy signal.

### Making a call with Voice Dial

- **Tap** the headset Answer/End button to enter Voice Dial mode. (Consult your mobile phone's User Manual for more information about how to use this feature.)

For best results, record the voice dialing tag through your headset.

### Redialing the last number

- **Double tap** the headset Answer/End button.

### Handling multiple calls

Having one active call in headset

- **Double tap** on Answer/End button will put active call on hold and make a call to last dialled phone number.

Having one active call while receiving one additional incoming call

- **Tap** on Answer/End button will end active call and answer incoming call.
  - **Double tap** on Answer/End button will reject incoming call.
  - **Press** Answer/End button for app. 1.5 sec to put active call on hold and answer incoming call.
- Having one active call plus one call on hold

- **Tap** on Answer/End button will end active call and retrieve call on hold.
- **Press** Answer/End button for app. 1.5 sec. to switch between the two calls.

Please note that this behaviour might change depending on connected phone type.

## Staying within range

The sound in your headset will deteriorate if you move beyond range.<sup>1)</sup> Move back into range to restore sound quality. If you move too far from your mobile phone, the call might be ended or re-routed to your mobile phone from the headset, depending on what mobile phone model you are using. Please see your mobile phone's User Manual for more information on this function.

## Remember!

For optimal performance, wear the Jabra M5390 Multiuse headset and your mobile phone on the same side of your body or within line of sight. In general, you will get better performance when there are no obstructions between your headset and your mobile phone.

## 8. Features

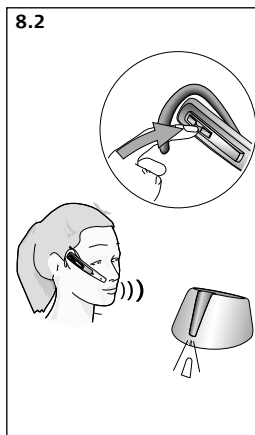
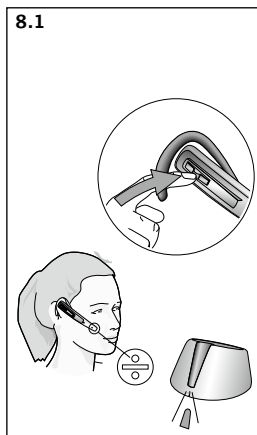

### Muting & unmuting

**8.1** Press Mute button on headset. A dual tone will be heard in the headset.

**8.2** To unmute, press Mute button again. A dual tone will be heard in the headset.

**1) Note:** If answering a call with telephone handset, make sure the headset is placed in charge cradle. Otherwise, the call will be routed through the headset.

8.3

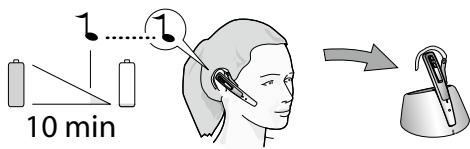

### Low battery

**8.3** Approx. 10 minutes before the headset runs out of battery, the visual indicator on headset will start to flash with a red light and a series of tones will be heard. If the battery runs out of power, visual indicator on headset will switch off automatically. Replace headset in charge cradle and continue the call using telephone handset. The headset contains a battery level indicator. By tapping the Vol. up/down button the visual indicator will flash quickly twice - green, yellow or red depending on the battery level.

8.4

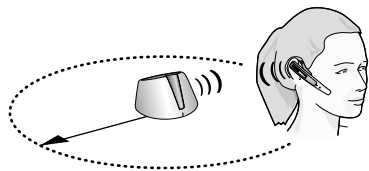

70m

### Out of range

**8.4** If you go out of range (app. 70 m), all buttons except Answer/End button will stop working until back in range again.<sup>2)</sup> Please note that the majority of mobile phones only support 10 m.

If headset is muted when going out of range, it will also be muted when going within range again.

**2) Important:** If headset is out of range for more than 1 min., the link between base and headset will be terminated.

## 8.5

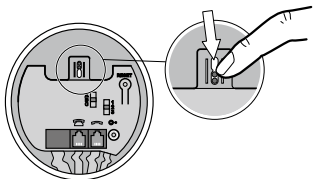
**Headset switch**

**8.5** If the headset is absent, the headset switch must be activated in order to use the handset or, if the headset is in use with another Bluetooth® device, the headset switch must be activated in order to use the handset.

**Features:**

Range	70 m headset/base - headset/dongle 10 m for most mobile phones
Talk time/ standby time	Up to 6 hours/up to 60 hours
Transmission protocol	Bluetooth®
Frequency band	2.4 GHz



## 9. Reset/Pairing

9.1

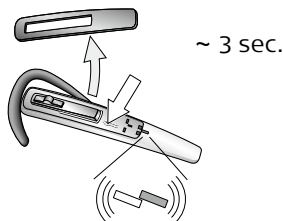

**9.1** Under start-up, keep pressing the Answer/End button for three seconds. Alternatively, remove the snap-on cover and press the reset button on the headset for three seconds. Visual indicator on headset will light constant blue. <sup>1)</sup>

9.2

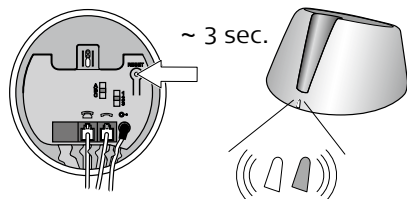

**9.2** Then press reset button on base unit for 3 seconds. Visual indicator on base unit will light constant blue.

9.3

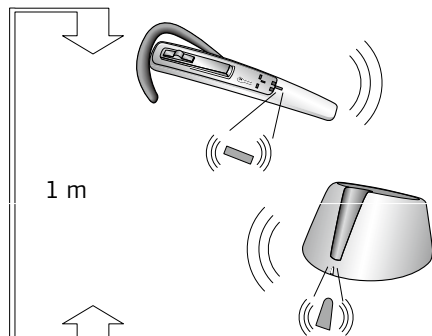

**9.3** Make sure headset and base are within 1 m of each other. When pairing is successful, both visual indicators will flash blue 5 times, and the visual indicator on base unit will turn to steady green.

In order to clear the pairing list in the base, press and hold the reset button underneath the base for 5 seconds. In order to clear the pairing list in the headset, press and hold the reset button on the headset for 5 seconds. Note that after resetting, a new pairing sequence has to be initiated.

**1) Note:** The headset is already paired with the base unit from the factory. Pairing should only be necessary if a new headset has to work with an existing base unit (or vice versa).

## 10. Using the Jabra M5390 Multiuse headset with multiple Bluetooth®-enabled devices

Your Jabra M5390 Multiuse headset can be paired with up to 8 devices. However, only two can be connected (paired with the headset, turned on and in range) with the headset at one time. This could be any two Bluetooth® devices (for example, a mobile phone and the Jabra M5390 Multiuse base, or the Jabra A335w Dongle and a mobile phone, or two mobile phones). Therefore, if the headset is in range of the Jabra M5390 Multiuse base or Jabra A335w Dongle, only one additional Bluetooth® device can be connected to the headset (paired with the headset, turned on and in range).

The headset is per default paired with the base from the factory. This means that the headset will automatically connect to the base if in range and turned on. For the dongle pairing see the dongle manual on CD.

It is also possible to have two Bluetooth®-enabled mobile phones connected to the Jabra M5390 Multiuse headset simultaneously. In this case, both base and dongle should be disconnected from the headset.

## 11. Operating devices in multiuse scenarios

From the button interface of the headset, it is possible to operate both devices in a multiuse scenario (two devices connected to the headset). Operations can be divided into handling for incoming and outgoing calls.

If receiving an incoming call from either of the connected devices, this device will automatically be the device "in focus" and a tap will answer the call. A press will reject the call.

If wanting to place an outgoing call activated from the headset, the user manually has to place one of the devices "in focus". Placing a device "in focus" means that all button presses made on the headset will be sent to the given device. For example, if a Voice Dial is to be activated on the second connected device, the user must first make sure that the given device is "in focus". After that, simply tap the button to activate a Voice Dial command.

In order to switch focus between the two connected devices, the Answer/End button has to be pressed for app. 1.5 seconds.

After having made a focus-swap action, different indicators will be used to inform the user which device is now "in focus"; If swapping focus to the Jabra A335w dongle, then the LED of the dongle will give 5 quick light-blue flashes. Also the speaker of the headset will say "Dongle in focus". If swapping focus to the Jabra M5390 base, the LED of the base will give 5 quick light-blue flashes. Also the speaker of the headset will say "Base in focus". If swapping focus to a mobile phone the speaker of the headset will say "Mobile in focus".

Please note that this only applies to multiuse scenarios. If the headset is only connected to one device, then this device will automatically be "in focus".

Also note that the Last Number Redial command does not use the "in focus" concept. If double tapping the Answer/End button, the Last Number Redial command will automatically be sent to the connected device with the latest incoming call (when connected to the headset).

**NOTE:** When multiple Bluetooth-enabled devices are paired with the headset, the Voice Dial\* function will work with the last device that was paired.

## 12. Switching between base and Jabra A335w Dongle in a multiuse scenario

A typical multiuse scenario is to have the headset connected to one mobile phone and either the base or the dongle. If wanting to switch between base and dongle, while maintaining the mobile phone connection, just press and hold the Volume up/down button for 4 seconds.

## 13. Troubleshooting & FAQ

- Q:** Nothing happens when I try to adjust the clear dial tone.
- A:** Make sure the base is powered (visual indicator on base unit is steady green). Then establish a voice link between base and headset (visual indicators on base unit and headset are flashing green). Also ensure that the telephone is activated (handset is off the hook or "line" button is pressed).
- Q:** I hear myself when I talk.
- A:** Your transmit volume level (please refer to section 3.10) is probably too high. Turn down the transmit volume level (3->2, 2->1).
- Q:** The sound in the headset is of poor quality or the person at the other end cannot hear me.
- A:** Make sure that you have positioned the clear dial tone switch correctly. To do this, call someone to adjust the clear dial tone switch.
- Q:** When I press the Answer/End button, the GN 1000 RHL lifts, but the call is not connected.
- A:** Make sure that you are using the telephone's handset port and not the headset port (if your telephone has one), when using a GN 1000 RHL for remote answering.
- Q:** I have moved desk at work. Is it possible to put my headset on another base?
- A:** Yes, this is possible. The headset only needs to be paired to the new base. Just follow the procedure as described in section 9 of this guide.
- Q:** I cannot hear anything in my headset when using my mobile phone.
- A:**
- Increase the volume on the headset (or phone).
  - As the volume level needed might vary between your desk phone and mobile phone, it might be best to adjust the level on the phones.
  - Then use the headset volume level adjustments for general adjustments (but ensure that the headset is paired with the mobile phone).
  - Make sure that the phone is connected to the headset - if it does not connect either from the phone's Bluetooth® menu or by tapping the Answer/End button, follow the pairing procedure (see section 4 "Pairing your headset with your mobile phone" in this guide).

*\*If the mobile phone supports this feature.*

**Q:** Can I use wideband with a mobile phone or a desk phone?

**A:** No, the headset only supports wideband with the Jabra A335w Dongle. Please see the Jabra A335w Dongle manual on CD for wideband settings.

**Note:** If your desk phone has a volume button, it might help to adjust it to optimize the sound quality in your headset.

## 14. Maintenance, safety and disposal

### Maintenance

The ear hook can be wiped with a dry or slightly damp cloth. The cords and base unit can be dry-dusted as required. Avoid getting moisture or liquids into any button sockets, receptors or other openings. Avoid exposing the product to rain.

### Children and product packaging

The packaging, including plastic bags and wrapping parts, are not toys for children. The bags themselves or the small parts they contain may cause choking if ingested.

### Batteries and product disposal

Do not expose the headset batteries to heat. Dispose of the product and/or batteries according to local standards and regulations.

### Need more help?

For your country's support details, see the European and Australasia Safety & Declaration or North American Declaration & Warranty that came with your Jabra M5390 Multiuse.

### Charger

**Warning:** Do not attempt to charge your Jabra headset with anything other than the AC adapter provided. The use of any other AC adapter may damage or destroy the headset and may invalidate any approval or warranty, and may be dangerous. For availability of approved accessories, please check with your dealer. When you disconnect the power cord of any accessory, grasp and pull the plug, not the cord. Never use a charger that is damaged. **Important:** The "colour" indicator light will be on while charging and will turn off when charging is complete. The Jabra headset cannot be used while charging.

### Battery information

Your device is powered by a rechargeable battery. The full performance of a new battery is achieved only after two or three complete charge and discharge cycles. The battery can be charged and discharged hundreds of times, but will eventually wear out. Recharge your battery only with the provided approved chargers designated for this device. Unplug the charger from the electrical plug and the device when not in use. Do not leave a fully charged battery connected to a charger, since overcharging may shorten its lifetime. If left unused, a fully charged battery will lose its charge over time. Leaving the device in hot or cold places, such as in a closed car in the summer or in winter conditions, will reduce the capacity and lifetime of the battery. Always try to keep the battery between 15°C and 25°C (59°F and 77°F). A device with a hot or cold battery may not work temporarily, even when the battery is fully charged. Battery performance is particularly limited in temperatures well below freezing. Do not dispose of batteries in a fire as they may explode. Batteries may also explode if damaged. Dispose of batteries according to local regulations. Please recycle when possible. Do not dispose as household waste.

## 15. Appendix – GN 1000 Remote Handset Lifter (RHL) (optional accessory)

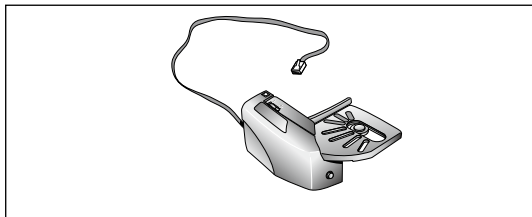

The GN 1000 Remote Handset Lifter (RHL) is an optional accessory that automatically lifts and lowers your telephone's handset when making, answering or ending a call.

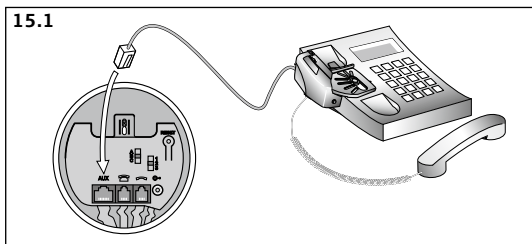

### Setting up

**15.1** Attach RHL to telephone handset cradle. Connect RHL cord to AUX port on bottom of base unit.

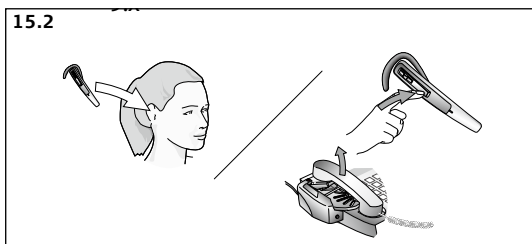

### Making/answering a call

**15.2** Put on headset, or press Answer/End button if already wearing headset. The RHL will automatically lift telephone handset.

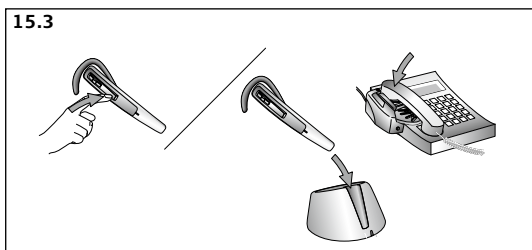

### Ending a call

**15.3** Press Answer/End button, or place handset in charge cradle. The RHL will automatically replace telephone handset, and the call will be terminated.

**Note:** Out of range. If headset is out of range for more than 1 min., any on-going call will be terminated.

© 2008 GN Netcom A/S. All rights reserved. Jabra® is a registered trademark of GN Netcom A/S. All other trademarks included herein are the property of their respective owners. The Bluetooth® word mark and logos are owned by the Bluetooth SIG, Inc. and any use of such marks by GN Netcom A/S is under license. (Design and specifications subject to change without notice).

[www.jabra.com](http://www.jabra.com)

MADE IN CHINA



**Jabra**

## Free Manuals Download Website

<http://myh66.com>

<http://usermanuals.us>

<http://www.somanuals.com>

<http://www.4manuals.cc>

<http://www.manual-lib.com>

<http://www.404manual.com>

<http://www.luxmanual.com>

<http://aubethermostatmanual.com>

Golf course search by state

<http://golfingnear.com>

Email search by domain

<http://emailbydomain.com>

Auto manuals search

<http://auto.somanuals.com>

TV manuals search

<http://tv.somanuals.com>