



## B-VENT GAS FIREPLACE HEATER INSERTS

RETAIN THIS MANUAL FOR  
FUTURE REFERENCE

Suitable for installation  
into masonry or factory  
built fireplaces

Tested &  
Listed By  Beaverton  
Oregon USA  
OMNI-Test Laboratories, Inc.  
Report No. 116-F-15-5

# HOMEOWNER'S CARE AND OPERATION INSTRUCTIONS



Lennox Elite® Series Models: EBVI25 & EBVI30

P/N 775,155M Rev. D,12/2005



### WARNINGS

- **Hot! Do not touch!** The glass and surfaces of this appliance will be hot during operation and will retain heat for a while after shutting off the appliance. Severe burns may result.
- Carefully supervise children in the same room as appliance.
- If small children are present in the home, it is recommended that this appliance be fitted with a screen door or screen panel kit. See *Page 12* for ordering information.

**WARNING: IF THE INFORMATION IN THIS MANUAL IS NOT FOLLOWED EXACTLY, A FIRE OR EXPLOSION MAY RESULT CAUSING PROPERTY DAMAGE, PERSONAL INJURY OR LOSS OF LIFE.**

#### FOR YOUR SAFETY

Do not store or use gasoline or other flammable vapors or liquids in the vicinity of this or any other appliance.

#### WHAT TO DO IF YOU SMELL GAS:

- **DO NOT** light any appliance.
- **DO NOT** touch any electrical switches.
- Do not use any phone in your building.
- Immediately call your gas supplier from a neighbor's phone. Follow your gas supplier's instructions.
- If your gas supplier cannot be reached, call the fire department.

Installation and service must be performed by a qualified installer, service agency or the gas supplier.

**AVERTISSEMENT: ASSUREZ-VOUS DE BIEN SUIVRE LES INSTRUCTIONS DONNÉ DANS CETTE NOTICE POUR RÉDUIRE AU MINIMUM LE RISQUE D'INCENDIE OU POUR ÉVITER TOUT DOMMAGE MATÉRIEL, TOUTE BLESSURE OU LA MORT.**

**POUR VOTRE SÉCURITÉ:** Ne pas entreposer ni utiliser d'essence ni d'autre vapeurs ou liquides inflammables dans le voisinage de cet appareil ou de tout autre appareil.

**POUR VOTRE SÉCURITÉ:** Que faire si vous sentez une odeur de gaz:

- Ne pas tenter d'allumer d'appareil.
- Ne touchez à aucun interrupteur. Ne pas vous servir des téléphones se trouvant dans le bâtiment où vous vous trouvez.
- Evacuez la pièce, le bâtiment ou la zone.
- Appelez immédiatement votre fournisseur de gaz depuis un voisin. Suivez les instructions du fournisseur.
- Si vous ne pouvez rejoindre le fournisseur de gaz, appelez le service des incendies.

L'installation et service doit être exécuté par un qualifié installateur, agence de service ou le fournisseur de gaz.

**CONGRATULATIONS ON THE PURCHASE OF YOUR NEW GAS APPLIANCE MANUFACTURED BY LENNOX HEARTH PRODUCTS.**

When you purchased your new gas-fired heater, you joined the ranks of thousands of individuals whose answer to their home heating needs reflects their concern for efficiency and our environment. We extend our continued support to help you achieve the maximum benefit and enjoyment available from your new gas-fired heater. It is our goal at Lennox Hearth Products to provide you, our valued customer, with an appliance that will ensure years of trouble-free warmth and pleasure.

Thank you for selecting a Lennox Hearth Products gas-fired heater as the answer to your home heating needs.

Sincerely,  
All of us at Lennox Hearth Products

**TABLE OF CONTENTS**

Introduction .....Page 2  
 General Information .....Page 2  
 Burn-In Period .....Page 3  
 Lighting Millivolt Appliances .....Page 3  
 Gas Controls .....Page 3  
 Control Compartment Access .....Page 4  
 Operation & Care of Your Appliance..Page 4  
 Maintenance Procedures.....Page 4  
 Maintenance Schedule .....Page 6  
 Front Glass Door Assembly,  
 Removal and Installation.....Page 7  
 Burner Adjustments .....Page 7  
 Flame Appearance and Sooting.....Page 7  
 Log Placement Instructions .....Page 8  
 Millivolt Appliance Checkout .....Page 11  
 Blower Operation .....Page 11  
 Fireplace Requirements.....Page 11  
 Wiring Diagrams .....Page 11  
 Warranty Information.....Page 12  
 Accessory Components .....Page 12  
 Lighting Instructions – Millivolt .....Page 15  
 Replacement Parts List .....Page 17  
 Troubleshooting Guide.....Page 19

**INTRODUCTION**

The Insert model covered in this manual is a B-Vent gas heater designed for residential application for installation into an existing masonry or factory built solid-fuel fireplace using 4" diameter, UL1777 listed aluminum liner for the exhaust. The vent must be routed through the existing fireplace flue system to the vent termination.

**This millivolt appliance is designed to operate on either natural or propane gas.** A millivolt gas control valve with piezo ignition system provides safe, efficient operation. External electrical power is required to operate the air circulation blower.

This appliance complies with National Safety Standards and is tested and listed by OMNI-Test Laboratories Inc.; Beaverton, Oregon (Report No. 116-F-15-5) to ANSI Z21.88-2002 (in Canada, CSA-2.33-2002), and CAN/CGA-2.17-M91 in both USA and Canada, as vented gas heaters.

Installation must conform to local codes. In the absence of local codes, installation must comply with the current National Fuel Gas Code, ANSI Z223.1. (In Canada, the current CAN-1 B149 installation code.) Electrical wiring must comply with the National Electrical Code ANSI/ NFPA 70 - latest edition. In Canada, the current CSA C22-1 Canadian Electrical Code - latest edition.

**! WARNING**  
**Do not attempt to alter or modify the construction of the appliance or its components. Any modification or alteration may void the warranty, certification and listings of this unit.**

**! WARNING**  
**Improper installation, adjustment, alteration, service or maintenance can cause injury or property damage. Refer to this manual. For assistance or additional information consult a qualified installer, service agency or the gas supplier.**

NOTE: DIAGRAMS & ILLUSTRATIONS ARE NOT TO SCALE.

**! WARNING**

**These fireplace Inserts are vented heaters. Do not burn wood or other material in these appliances.**

**GENERAL INFORMATION**

Installation, repair and annual service inspection should be performed by a qualified service technician.

**It is imperative that the control compartment, burners and circulating air passage ways of the appliance be kept clean.**  
**S'assurer que le brûleur et le compartiment des commandes sont propres. Voir les instructions d'installation et d'utilisation qui accompagnent l'appareil.**

Provide adequate clearances around air openings and adequate accessibility clearance for service and proper operation.

Never obstruct the front openings of the appliance.

Due to high temperatures of this appliance adequate clearances need to be maintained from furniture and draperies and other combustibles. Locate furniture and window coverings accordingly. The recommended clearance zone from the front of the appliance to combustibles is 36 inches (914 mm). Maintain all other clearances as outlined in the Installation Manual.

These fireplaces are designed as supplemental heaters. Therefore, it is advisable to have an alternate heat source when installed in a dwelling.

Input of millivolt model is variable. The rates are shown in the following table:

Millivolt Models with MAnnually-Modulated Gas Valves		
	Nat. Gas	Propane
Model No.	Input Rate (BTU/HR)	Input Rate (BTU/HR)
EBVI25	17,000 to 25,000	19,500 to 25,000
EBVI30	21,500 to 30,000	22,000 to 28,000

*Table 1*

Table 2 shows the main burner gas orifice size for the elevations indicated.

Model No.	Orifice Size		Elevation Feet (meters)
	Nat. Gas	Prop. Gas	
EBVI25	#41 (.096")	#53 (.0595")	0-4500 (0-1372)
EBVI30	#37 (.104")	1/16" (.0625")	0-4500 (0-1372)

Table 2

Tables 3 and 4 show the gas pressure requirements for all models:

Inlet Gas Supply Pressure (all models)		
Fuel #	Minimum	Maximum
Natural Gas	4.5" WC (1.12 kPa)	10.5" WC (2.61 kPa)
Propane	11.0" WC (2.73 kPa)	13.0" WC (3.23 kPa)

Table 3

Manifold Gas Supply Pressure (all models)		
Fuel #	Low	High
Natural Gas	(Lo) 1.6" WC (.40 kPa)	(Hi) 3.5" WC (.87 kPa)
Propane	(Lo) 6.3" WC (1.57 kPa)	(Hi) 10.0" WC (2.49 kPa)

Table 4

Test gauge connections are provided on the front of the millivolt gas control valve (identified IN for the inlet and OUT for the manifold side). See Figures 1 & 2.

This appliance *must be isolated* from the gas supply piping system (by closing its individual manual shut-off valve) during any pressure testing of the gas supply piping system at test pressures **equal to or less than** 1/2 psig (3.5 kPa).

This appliance and its individual shut-off valve *must be disconnected* from the gas supply piping system during any pressure testing of that system at pressures **greater than** 1/2 psig (3.5 kPa).

This appliance must not be connected to a chimney or flue serving a separate solid-fuel appliance.

## WARNING

**Carbon monoxide poisoning: Early signs of carbon monoxide poisoning are similar to the flu with headaches, dizziness and/or nausea. If you have these signs, obtain fresh air immediately. Turn off the gas supply to the appliance and have it serviced by a qualified professional, as it may not be operating correctly.**

## WARNING

**Failure to comply with the installation and operating instructions provided in this document will result in an improperly installed and operating appliance, voiding its warranty. Any change to this appliance and/or its operating controls is dangerous. Improper installation or use of this appliance can cause serious injury or death from fire, burns, explosion or carbon monoxide poisoning.**

### BURN-IN PERIOD

During the first few burns of these appliances there will be some odor due to the curing of the high temperature paint and burning off of lubricants used in the manufacturing process.

Depending on your use, the burn-in period may take a few hours or a few days. **Do not turn on blower during Burn-In period.**

## IMPORTANT

**Keep your house well ventilated during the curing process. The odor and haze emitted by the curing process can be quite noticeable and may set off a smoke detector.**

### LIGHTING MILLIVOLT APPLIANCES

To light millivolt appliances refer to the detailed lighting instructions found on Page 15 (English) and Page 16 (French). Millivolt appliance lighting instructions may also be found on the pull-out lighting instruction labels located in the control compartment (below glass door).

NOTE: DIAGRAMS & ILLUSTRATIONS ARE NOT TO SCALE.

### GAS CONTROLS

These millivolt appliances are fitted with a burner Off/On Switch, located on the side surround panel as shown in Figure 4 on Page 4. Once the pilot is lit, and valve knob is in the ON position, the Off/On switch will control the appliance Off/On operation. To operate, toggle the switch between its ON and OFF positions.

### Variable Flame Height Adjustment

These millivolt appliances are equipped with variable gas control valves. Flame height may be adjusted through a range between fixed low and high settings by rotating the HI/LO knob on the valve (see Figures 1 & 2) while the appliance is in operation.

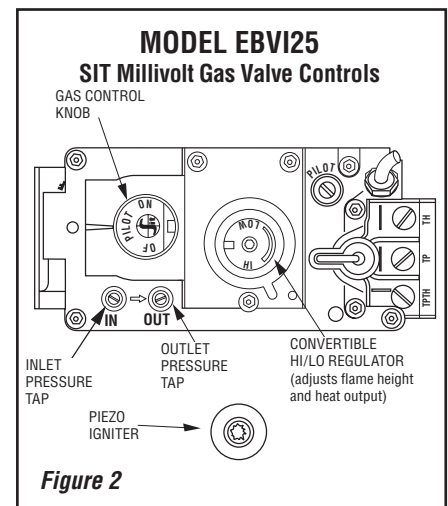
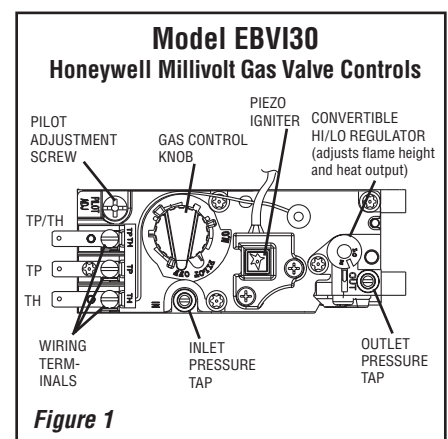

## CONTROL COMPARTMENT ACCESS

Pull down hinged door to access control compartment (see **Figure 3**).

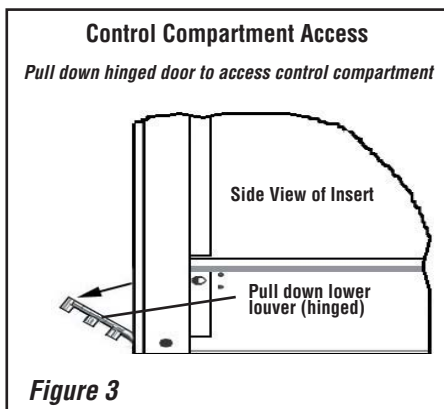

## Burner Off/on Switch and Rheostat Location If optional surround is installed

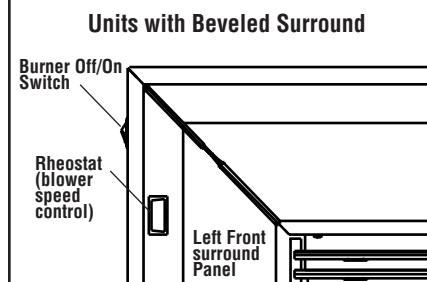

## Units with Flat Surround

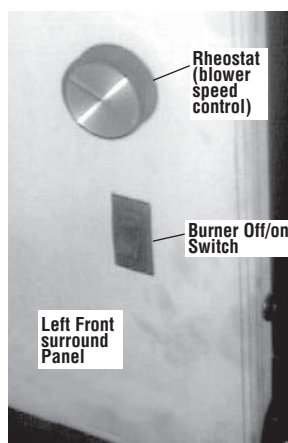

**Figure 4**

## OPERATION AND CARE OF YOUR APPLIANCE

Appliance operation may be controlled through a remotely located optional wall thermostat or remote control.

In lieu of remote control or remote wall thermostat operation, the appliance must be operated directly through the off/on switch located on the side surround panel (see **Figure 4**).

If your millivolt appliance is equipped with an optional wall thermostat kit or remote control kit and the pilot is lit (and valve is in the On position), the appliance main burner may be turned on and off with the wall thermostat or remote control.

Always keep the appliance area clear and free from combustible materials, gasoline and other flammable liquids.

Remember, millivolt appliances have a continuous burning pilot flame. Exercise caution when using products with combustible vapors.

## WARNING

**Do not place clothing or other flammable materials on or near this appliance.**

## AVERTISSEMENT

**Surveiller les enfants. Garder les vêtements, les meubles, l'essence ou autres liquides à vapeur inflammables loin de l'appareil.**

## WARNING

**Children and adults should be alerted to the hazards of high surface temperatures. Use caution around the appliance to avoid burns or clothing ignition. Young children should be carefully supervised when they are in the same room as the appliance.**

**Do not attempt to touch the front enclosure glass with your hands while the fireplace is in use.**

**Note: An Optional Screen Panel for the glass is available (see Page 12 for ordering information).**

## WARNING

**Do not use these appliances if any part has been under water. Immediately call a qualified, professional service technician to inspect the appliances and to replace any parts of the control system and any gas controls which have been under water.**

NOTE: DIAGRAMS & ILLUSTRATIONS ARE NOT TO SCALE.

## AVERTISSEMENT

**Ne pas se servir de cet appareil s'il a été plongé dans l'eau, complètement ou en partie. Appeler un technicien qualifié pour inspecter l'appareil et remplacer toute partie du système de contrôle et toute commande qui ont été plongés dans l'eau.**

## MAINTENANCE

The appliance and venting system should be thoroughly inspected before initial use and at least annually by a qualified service technician. However, more frequent periodic inspections and cleanings should be performed by the homeowner. Homeowner must contact a qualified service technician at once if any abnormal condition is observed.

Refer to the maintenance schedule on **Page 6** for maintenance tasks, procedures, recommended frequency and by whom they should be performed. Always verify proper operation of the appliance after servicing.

Always turn off the gas and unplug the power cord to the appliance before cleaning. Before re-lighting, refer to the lighting instructions in this manual. Instructions are also found on pull-out panels located below the glass door in the control compartment.

Keep lower control compartment clean by vacuuming or brushing at least twice a year. More frequent cleaning may be required due to excessive lint from carpeting, bedding materials, etc. It is important that control compartments, burners and circulating air passageways of the appliance be kept clean.

## WARNING

**Turn off gas and electrical power before servicing the appliance.**

## CAUTION

**Wear gloves and safety glasses for protection while doing required maintenance.**

## IMPORTANT

**Always verify proper operation after servicing.**

## Check Burner Flame Appearance

Visually check the flame of the burner periodically making sure the flames are steady and not lifting or floating (see **Figure 13** on **Page 7**).

## Glass Cleaning

*Note: Clean glass after first two weeks of operation (after Burn-In period is over).*

The viewing glass should be cleaned periodically to remove any build-ups caused from the following:

- During start-up, it is normal for condensation to form on the inside of the glass (this condensation and fog will usually disappear in a few minutes). This can cause lint, dust and other airborne particles to cling to the glass surface.
- Initial curing of the high temperature paint and burning off of lubricants used in the manufacturing process may result in a film on the glass.
- A white coating may form on the glass as a result of impurities and minerals in the fuel.

It is recommended that the glass be cleaned two or three times during each heating season, depending on the circumstances present.

Use one of the following to clean glass:

- Non-ammonia based household cleaner
- 50%-50% mix of white vinegar & water
- gas stove glass cleaner



### IMPORTANT

**Do not use abrasive cleaners on glass. Never clean the glass when it is hot.**



### WARNING

**Do not attempt to touch the front enclosure glass with your hands while the fireplace is in use.**

## Servicing Blower

To access the blower assembly for maintenance, adjustment or replacement, see the following procedure:

1. Unplug 120-volt A.C. power supply to insert.
2. Shut off gas supply to insert.
3. Remove Glass Door (see Procedure For Removing Standard Glass Door Assembly on [Page 7](#)).
4. Remove log set, burner and grate.
5. Remove blower access panel and gasket (see [Figure 5](#) for model EBVI25 and [Figure 6](#) for model EBVI30). **Be careful not to damage the gasket.**

### Model EBVI25

Remove 10 Screws (use phillips screwdriver)



Figure 5

### Model EBVI30

Remove 12 Screws (use phillips screwdriver)



Figure 6

6. (Model EBVI25) Remove the two hex head bolts shown in [Figure 7](#). (Model EBVI30) Remove the two screws shown in [Figure 8](#), then lift out air duct channel.

### Model EBVI25

Remove 2 Bolts

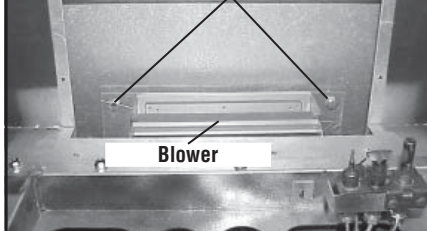

Figure 7

### Model EBVI30

Remove 2 Screws



Figure 8

7. Disconnect wires from the blower.
8. Lift blower up and pull it out from back opening of firebox (see [Figure 9](#)).
9. To reinstall blower, reverse [Steps 1 through 8](#).

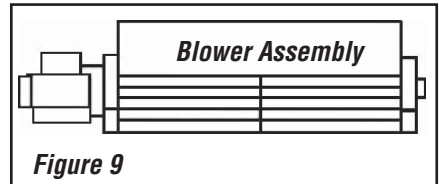

Figure 9

## Small Area Paint Touch-up

The finish of the insert body and surround (optional) is a high-quality powdercoat. Only use factory supplied powdercoat paint kit for touch-ups (cat. no. 90L74).

Do not attempt to repaint the insert until the finish is completely cured (see [Burn-In Period](#) on [Page 3](#)). If the surface later becomes stained or marred, it may be lightly sanded and touched up with spray paint.

Paint is available at your local authorized Lennox Hearth Products dealer. Never attempt to paint a hot insert.

## Inspect Wiring

Inspect and clean all wire connections. Ensure that there is no melting or damage. Inspection should include:

- Terminals at the valve
- Off/On switch
- Wall thermostat, remote control, or control kit (optional parts)
- Spill switch

Refer to wiring diagrams on [Pages 11 & 12](#).



### CAUTION

**Label all wires prior to disconnection when servicing controls. Wiring errors can cause improper and dangerous appliance operation.**

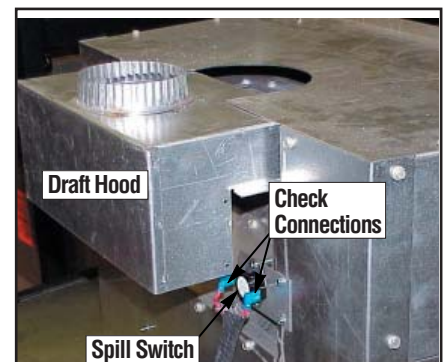

Figure 10

NOTE: DIAGRAMS & ILLUSTRATIONS ARE NOT TO SCALE.

## MAINTENANCE

### Annually (Before the onset of the Burning Season)

Maintenance Task	Accomplishing Person	Procedure
Inspecting/Cleaning Burner, Logs and Controls	Qualified Service Technician	Inspect valve and ensure it is properly operating. Check piping for leaks. Vacuum the control compartment, fireplace logs and burner area.
Check Flame Patterns and Flame Height	Qualified Service Technician	Refer to <b>Figure 13 on Page 7</b> and verify the flame pattern and height displayed by the appliance conforms to the picture. Flames must not impinge on the logs.
Inspecting/Cleaning Pilot and Burner	Qualified Service Technician	Refer to <b>Figure 13 on Page 7 and Figure 25 on Page 11</b> . Remove any surface build-up on pilot and burner assembly. Wipe the pilot nozzles, ignitor/flame rod and hood. Ensure the pilot flame engulfs the flame sensor as shown.
Checking Vent System	Qualified Service Technician	Inspect the vent system at the top and at the base (within the firebox) for signs of blockage or obstruction. Look for any signs of dislocation of the vent components.
Appliance Checkout	Qualified Service Technician	Perform the appropriate appliance checkout procedure detailed in this manual.
Replacing Rockwool Ember Materials	Homeowner/Qualified Services Technician	Remove old ember materials and vacuum the rockwool placement area. Place new rockwool as described on <b>Page 10</b> (see <b>Figure 23</b> ).

### Periodically (After the Burning Season)

Maintenance Task	Accomplishing Person	Procedure
Cleaning Firebox Interior	Homeowner	Carefully remove logs, rockwool and and vermiculite. Vacuum out interior of the firebox. Clean firebox walls and log grate. Replace logs, Rockwool and vermiculite as detailed in this manual.
Check Flame Patterns and Flame Height	Homeowner	Refer to <b>Figure 13 on Page 7</b> and verify the flame pattern and height displayed by the appliance conforms to the picture. Flames must not impinge on the logs.
Checking Vent System	Homeowner	Inspect the vent system at the top and at the base (within the firebox) for signs of blockage or obstruction. Look for any signs of dislocation of the vent components.
Cleaning Front Door Window	Homeowner	Clean as necessary following the directions provided in this manual. <b>DO NOT TOUCH OR ATTEMPT TO CLEAN GLASS WHILE HOT.</b>

## PROCEDURE FOR REMOVING STANDARD GLASS DOOR ASSEMBLY

### **! WARNING**

Handle glass door with extreme care! The glass door assembly is susceptible to damage. Do not scratch while handling or while reinstalling.

### **! WARNING**

Never operate unit without the front glass door panel in place and secure.

Remove the front door assembly from insert as follows:

- 1) Open the two latches below the glass door as shown in **Figures 11 & 12**.

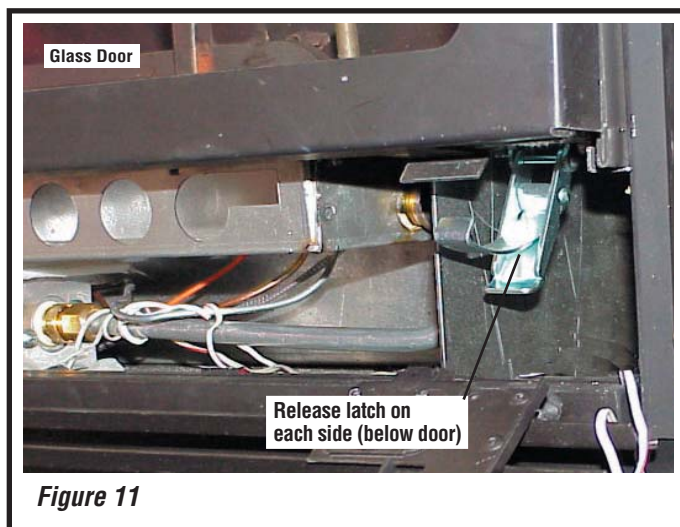

**Figure 11**

- 2) Swing the bottom of the door outward (see **Figure 12**) and lift it off of firebox top. Set door aside in a safe place.

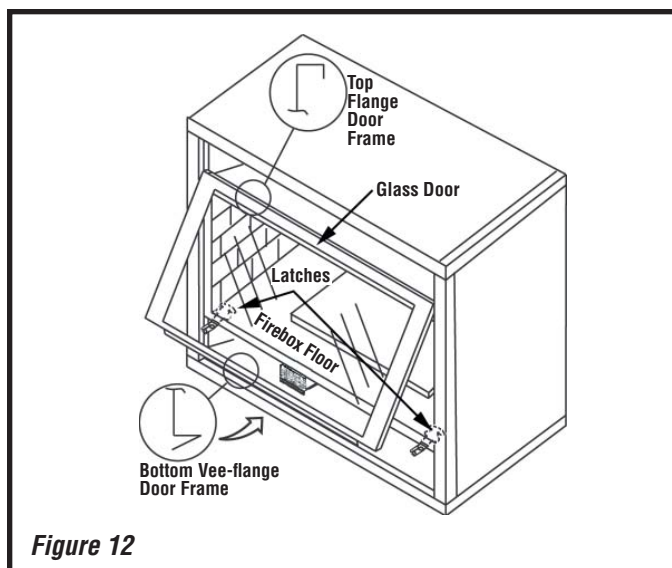

**Figure 12**

## BURNER ADJUSTMENT

### Flame Appearance and Sooting

Proper flame appearance is a flame which is blue at the base and becomes yellow/orange in the top of the flame. When the insert is first lit, the entire flame may be blue and will gradually turn yellow/orange during the first 6-8 minutes of operation. If after 6-8 minutes the flame stays blue, or if the flame is orange with evidence of sooting (black tip), the air shutter may require adjustment.

An appliance operated with an air shutter opening that is too large will exhibit flames that are blue and transparent. These weak, blue and transparent flames are termed anemic. If the air shutter opening is too small, sooting may develop.

### Burner Flame Appearance

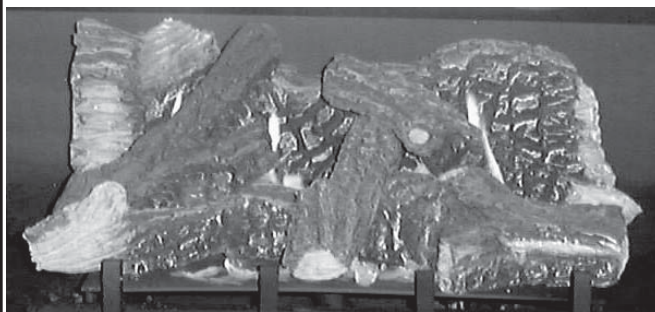

**Figure 13**

EBVI25 Shown

Sooting is indicated by black puffs developing at the tips of very long orange flames. Sooting results in black deposits forming on the logs, appliance inside surfaces and on exterior surfaces adjacent to the vent termination. Sooting is caused by incomplete combustion in the flames and lack of combustion air entering the air shutter opening. To achieve a warm yellow to orange flame that does not soot, the shutter opening must be adjusted between these two extremes.

No smoke or soot should be present. Reposition the logs if flames impinge on any of them. If the logs are properly positioned and sooting conditions exist, the air shutter opening on the main burner tube should be adjusted.

### **! IMPORTANT**

Ensure that the front glass panel is in place and sealed during adjustment.

## Burner Adjustment Procedure

### **! WARNING**

Air shutter adjustment should only be performed by a qualified professional service technician.

### **! CAUTION**

The adjustment rod and nearby appliance surfaces are hot. Exercise caution to avoid injury while adjusting flame appearance.

If the burner flame appearance differs greatly from what is shown in **Figure 13** (see *Burner Flame Appearance*), some adjustment from the factory setting for the air shutter gap may be necessary (to compensate for variables in the installation and fuel such as, BTU value/composition, gas pressure, specific gravity of gas, altitude, etc.).

See **Table 5** on **Page 8** for *Burner Air Shutter Adjustment Guidelines*.

Initially, always position the air shutter to the factory setting as shown in **Figure 14** (adjustment rod is located in the lower control area). This can be done by moving the adjustment rod up or down accordingly. Allow the burner to operate for at least 15 minutes. Observe the flame continuously. If it appears weak or sooty as previously described, adjust the air shutter to a more open position until the proper flame appearance is achieved.

### Burner Air Shutter Adjustment

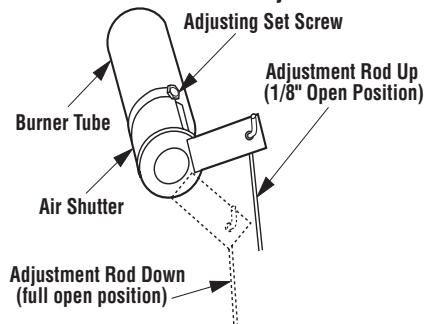

#### MAIN BURNER FACTORY AIR SHUTTER OPENING SETTING

Model	Gas Type	Air Shutter Gap
EBVI30	Natural Gas	5/16" (7.94mm)
	Propane	1/2" (12.7mm)
EBVI25	Natural Gas	1/16" (1.59mm)
	Propane	1/2" (12.7mm)

**Figure 14**

### **! CAUTION**

Carbon will be produced if the air shutter is closed too much. Any damage due to carboning resulting from improperly setting the air shutter is not covered under the warranty.

The following chart is provided to aid you in achieving the correct air shutter adjustment for your installation.

Air Shutter Adjustment Guidelines		
Amount of Primary Air	Flame Color	Air Shutter Adjustment
If air shutter is closed too far →	Flame will be orange →	Air shutter gap should be increased
If air shutter is open too far →	Flame will be blue →	Air shutter gap should be decreased

**Table 5**

## LOGS, VERMICULITE AND EMBERS

### Installation Instructions

### **! WARNING**

If logs are not installed according to the directions shown here, flame impingement and improper combustion could occur and result in soot and/or excessive production of carbon monoxide (CO) - a colorless, odorless, toxic gas.

Carefully install the seven-piece log set into the firebox as shown in these instructions. All logs should fit onto corresponding pins and/or log stoppers. This will ensure a proper flame and safe combustion.

**Note:** Place some vermiculite around burner before installing logs (see **Figure 24**). The entire bag of vermiculite will NOT be used.

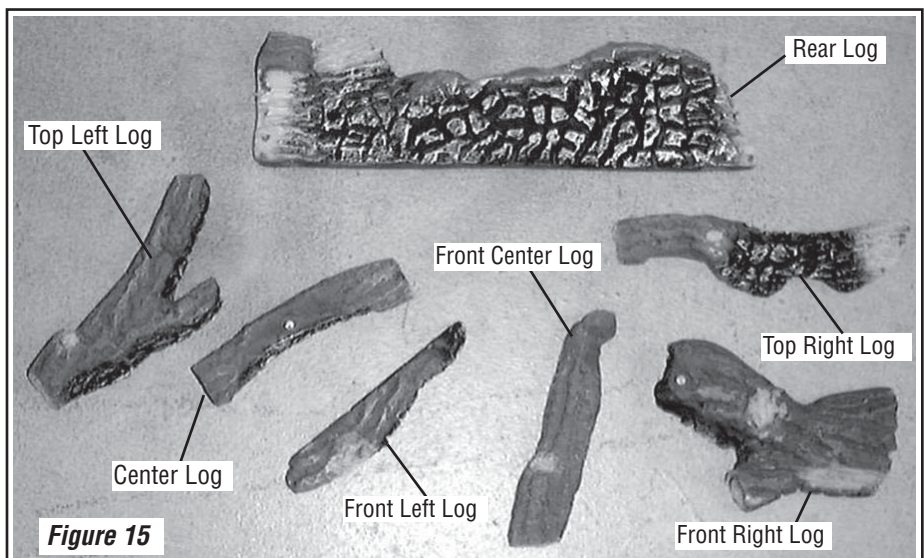
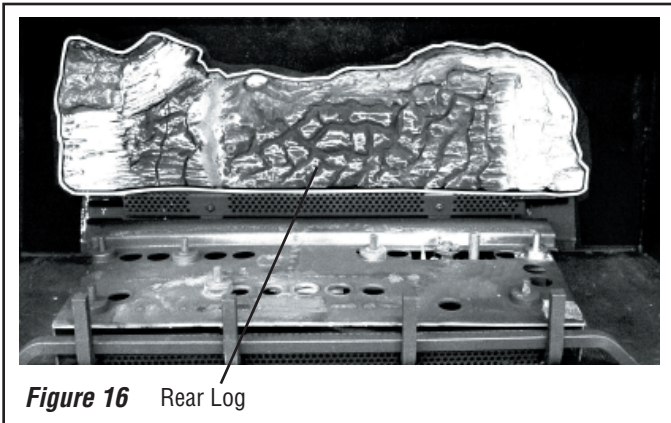

**Figure 15**

NOTE: DIAGRAMS & ILLUSTRATIONS ARE NOT TO SCALE.



1. Place the rear log onto the two corresponding locating pins at the back of the firebox as shown in **Figure 16**.



2. Place the Front Right Log onto the two corresponding locating pins as shown in **Figure 17**.

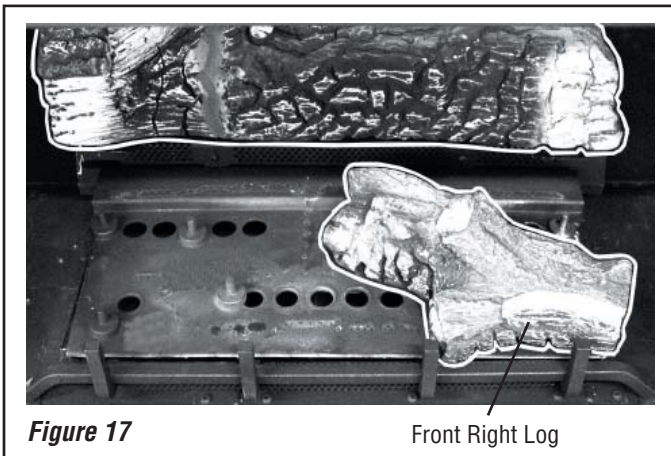

3. Place the Center Log onto the two corresponding locating pins as shown in **Figure 18**.

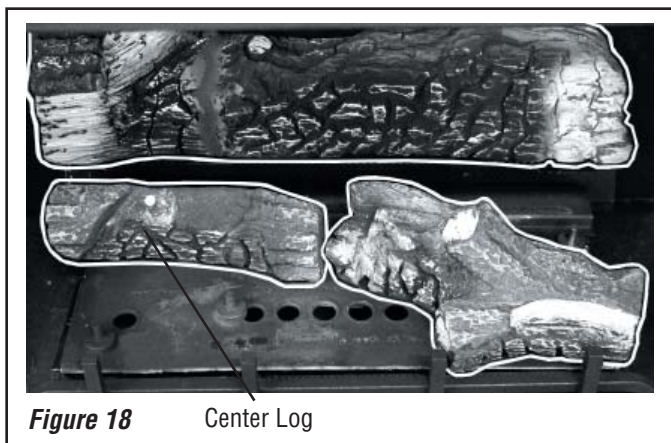

4. Place the Front Left Log onto the two corresponding locating pins as shown in **Figure 19**.

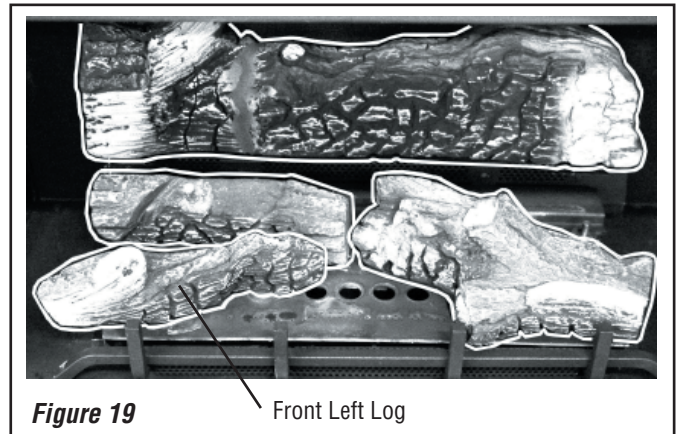

5. Install the Top Left Log onto the corresponding locating pin and indentation on Center Log as shown in **Figure 20**.

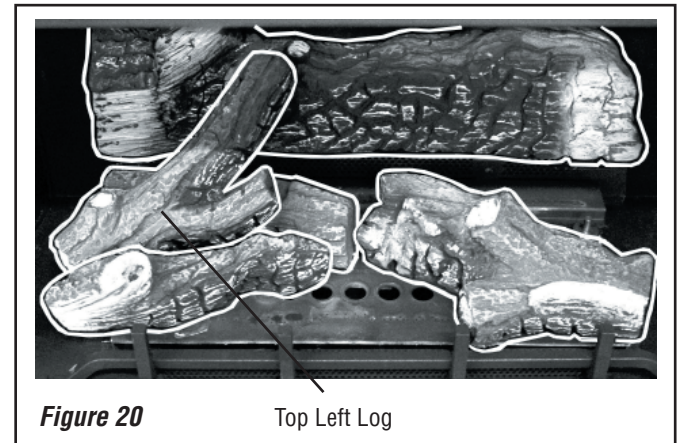

6. Install the Front Center Log over the Front Right Log. The front of log will rest on the burner and the back of log will rest on rear log as shown in **Figure 21**.

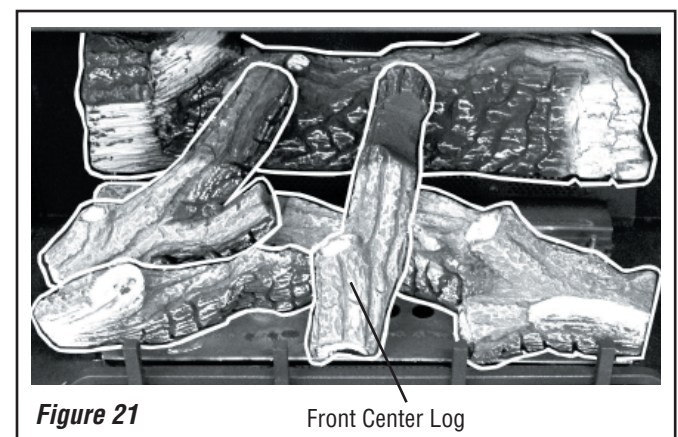

7. Install the Top Right Log into the corresponding indentations on Front Center Log and front right twig as shown in **Figure 22**.



**Figure 22**

Top Right Log

8. Place the glowing embers on the burner as shown in **Figure 23**.

One package of ember material has been included with this log set. You will not need to use the entire bag.

**IMPORTANT:** The quantity and placement of the ember material can affect insert performance therefore it is very important that it be placed as shown in **Figure 23**.

- a. Unpackage and divide the fine ember material (mineral wool) into dime-sized fluffy pieces.
- b. Distribute the pieces over the top of the front burner ports, filling the area in front of the forward logs.

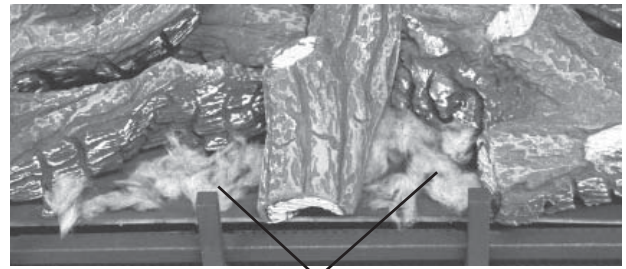

**Figure 23**

Embers

9. Place some vermiculite around the logs as shown in **Figure 24** (the entire bag of vermiculite will NOT be used).



**Figure 24**

Vermiculite

## MILLIVOLT APPLIANCE CHECKOUT

Light the pilot by following the instructions on **Page 15 or 16** of this manual.

The pilot flame should be steady, not lifting or floating. Flame should be blue in color with traces of orange at the outer edge. The top 3/8" (10 mm) at the pilot generator (thermopile) and the top 1/8" minimum (tip) of the quick drop out thermocouple should be engulfed in the pilot flame. The flame should project 1" (25 mm) beyond the hood at all three ports (**Figure 25**).

Replace logs if removed for pilot inspection.

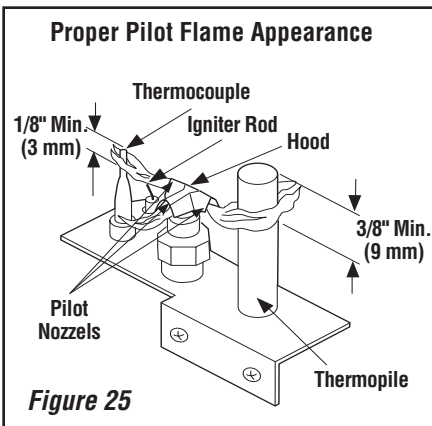

To light the burner, rotate the gas valve control knob counterclockwise to the "ON" position then turn "ON" the off/on switch mounted on the surround assembly (see **Figures 1 & 2** on **Page 3**) or operate the burner with the optional remote control, wall thermostat or control switch.

With proper care and maintenance, your appliance will provide many years of enjoyment. If you should experience any problem, first refer to the troubleshooting guide in this manual. If problem persists, contact your Lennox Hearth Products Dealer.

## BLOWER OPERATION

When the insert heats up, the blower will automatically be turned on by the fan disc located under the firebox bottom on the front left side. It will come on at the speed determined by the rheostat located on the side surround panel (see **Figure 4** on **Page 4**). To adjust the blower speed, dial the rheostat to the desired speed setting. Rotate the dial down (clockwise), just past the click (the first ON position) for the highest speed setting. Turning the knob further clockwise will provide slower blower speeds.

**Note:** If the rheostat is not turned "on," the blower will not operate.

## FIREPLACE REQUIREMENTS

**IMPORTANT:** When installing this appliance into a factory built fireplace or hearthform, the air flow within and around the fireplace shall not be altered by the installation of the insert (i.e. DO NOT BLOCK louvers or cooling air inlet or outlet ports, circulating air chambers in a steel fireplace liner or metal heat circulator).

**CAUTION:** The factory built firebox must accept the insert without modification other than removing bolted or screwed together pieces such as smoke shelf/deflectors, ash lips, screen or door tracks, log grates, refractory and damper assemblies. Any fireplace component, which is removed, must be retained so they can be reinstalled to restore the fireplace to its original operating condition. The removal of any part must not alter the integrity of the outer shell of the pre-engineered fireplace cabinet in any way.

If any components are removed from (or altered) from the existing fireplace, a Warning Label (see below) must be affixed inside the fireplace firebox, so that it shall be visible upon removal of the fireplace insert. Note: RTV high temperature silicone is an approved adhesive.



## WIRING DIAGRAMS

Wiring diagrams are provided here for reference purposes only. This information is also provided on schematics attached directly to the appliance on a pullout panel located within the control compartment.

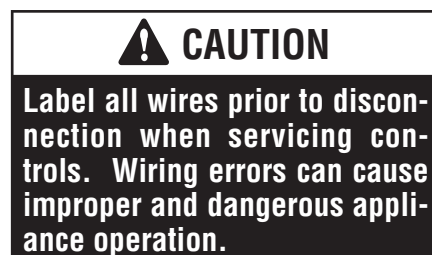

**Room Air Circulation Blower**

**IMPORTANT: BLOWER GROUND WIRE WITH POWER CORD GREEN WIRE SHOULD BE ATTACHED TO THE GROUND SCREW. FAILURE TO DO SO WILL RESULT IN A POTENTIAL SAFETY HAZARD. THE APPLIANCE MUST BE ELECTRICALLY GROUNDED IN ACCORDANCE WITH LOCAL CODES OR, IN THE ABSENCE OF LOCAL CODES, THE NATIONAL ELECTRICAL CODE, ANSI/NFPA 70 - LATEST EDITION. (IN CANADA, THE CURRENT CSA C22-1 CANADIAN ELECTRICAL CODE - LATEST EDITION.**

**WARNING: THE POWER CORD MUST BE PLUGGED DIRECTLY INTO A PROPERLY GROUNDED THREE-PRONG 120 VOLT, 60 HZ WALL RECEPTACLE. DO NOT CUT OR REMOVE THE GROUNDING PRONG FROM THIS PLUG. DO NOT ROUTE POWER CORD UNDER OR IN FRONT OF APPLIANCE.**

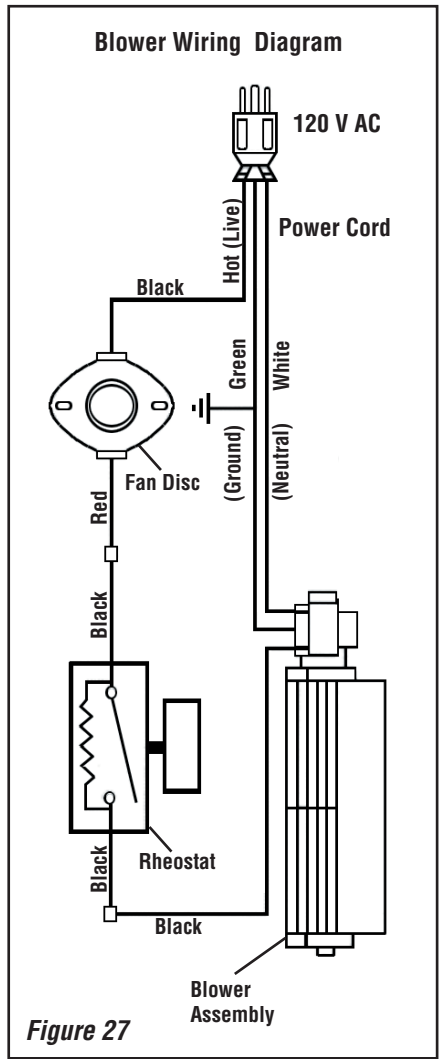

NOTE: DIAGRAMS & ILLUSTRATIONS ARE NOT TO SCALE.

### SIT & Honeywell Millivolt Wiring Diagram

If original wire as supplied must be replaced, it must be replaced with Type AWM 105°C, 18 gauge wire.

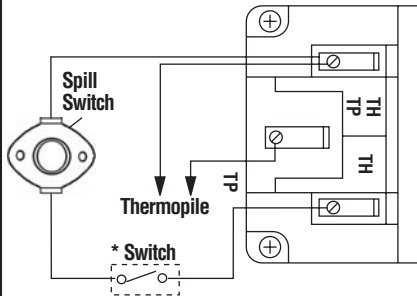

\* Off/on Switch, Optional Thermostat or Remote Control Receiver

Figure 28

If you encounter any problems or have any questions concerning the installation or application of this system, please contact your distributor. For the number of your nearest Lennox dealer, please call 800-9-Lennox.

**LENNOX HEARTH PRODUCTS**  
1110 West Taft Avenue  
Orange, CA 92865

Visit us at [www.LennoxHearthProducts.com](http://www.LennoxHearthProducts.com)

### WARRANTY INFORMATION

Your gas appliance is covered by a limited twenty-year warranty. You will find a copy of the warranty accompanying this manual. Please read the warranty to be familiar with its coverage.

Retain this manual. File it with your other documents for future reference.

### REPLACEMENT PARTS

A complete parts list is found at the end of this manual. Use only parts supplied from the manufacturer.

All parts should be ordered through your Lennox Hearth Products Distributor or Dealer. Parts will be shipped at prevailing prices at time of order.

When ordering repair parts, always give the following information:

1. The model and serial number of the appliance (see rating plate in control compartment of appliance).
2. The part number & description of part (see **Page 17**).
3. The quantity required.
4. The installation date of the appliance.

### PRODUCT REFERENCE INFORMATION

Your Insert's Model Number \_\_\_\_\_

Your Insert's Serial Number \_\_\_\_\_

The Date On Which Your Insert Was Installed \_\_\_\_\_

The Type of Gas Your Insert Uses \_\_\_\_\_

Your Dealer's Name \_\_\_\_\_

### ACCESSORY COMPONENTS

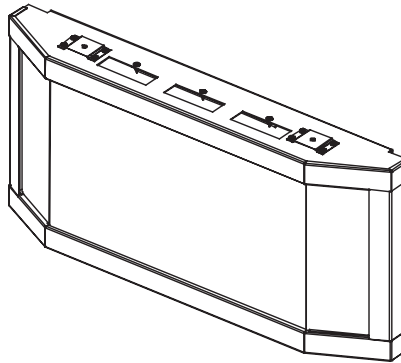

#### Bay Front Kits

These decorative bay front assemblies fit over the standard flat glass doors.

Cat. No.	Model	Description
H1502	BFK-25I	Bay Front Kit, Small, EBVI25
H1581	BFK-30BVI	Bay Front Kit, Medium, EBVI30

### Tall Arch Pane Screen Door Kits

These decorative screen door panels fit on the face of the appliance surround (eliminating the need for the top and bottom louver panels).

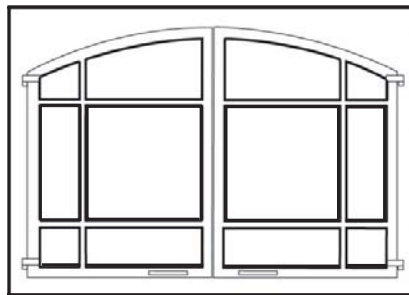

CAT#	MODEL#	DESCRIPTION
H3595	TAPSDK25C	25" Charcoal, EBVI25
H3596	TAPSDK25TI	25" Textured Iron, EBVI25
H3597	TAPSDK25SP	25" Satin Pewter EBVI25
H3840	TAPSDK25PC	25" Pewt/Charc, EBVI25
H3598	TAPSDK30C	30" Charcoal, EBVI30
H3599	TAPSDK30TI	30" Textured Iron, EBVI30
H3600	TAPSDK30SP	30" Satin Pewter, EBVI30
H3841	TAPSDK30PC	30" Pewt/Charc, EBVI30

### Screen Door Kit

These decorative screen door panels fit over the standard glass door panels.

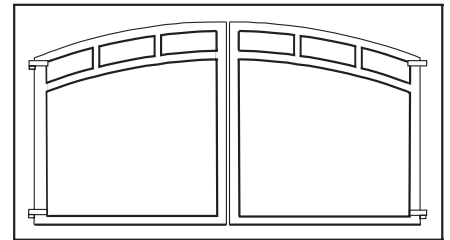

Cat. No.	Model	Description
H0916	TPSDK-30BVI	Twin-Pane Screen Door Kit, Md. BVI
H1501	TPSDK-25	Twin-Pane Screen Door Kit, Sm. BVI

NOTE: DIAGRAMS & ILLUSTRATIONS ARE NOT TO SCALE.

## ACCESSORY COMPONENTS

### Deluxe Remote Control System

The Model RCL-T (Deluxe) Remote Control System has all of the features of the standard system along with an added easy to read LCD screen which presents access to many enhancements, including battery power level indicator, timer, mode of operation, thermostatic display including room temperature in either metric or English units, flame indicator and clock. Fully programmable, the Model RCL-T allows for command over nearly all operational and temperature variables, using the hand held remote control transmitter.



Cat. No.	Model	Description
H0251	RCL-T	Remote Control System (Deluxe)

### Standard Remote Control System

The Model RCL (Standard) Remote Control System, features a simple Off/on control function for the insert. This model includes a hand-held transmitter, a remote receiver with wall-mount coverplate and all hardware required to install the unit. The remote receiver can be wall or hearth mounted.



Cat. No.	Model	Description
H0249	RCL	Remote Control System (Standard)

### Wall Thermostat

The wall thermostat kit provides temperature control for optimum comfort.

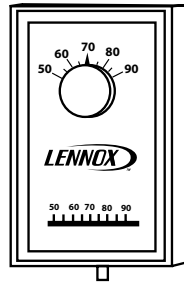

Cat. No.	Model	Description
89L36	WTK	Wall Thermostat Kit

### Control Kit

If an optional surround kit is not purchased, this kit is required to provide the off/on switch and rheostat.

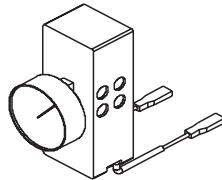

Cat. No.	Model	Description
H0919	CK-EI	Control Kit, Elite Inserts

### Touch-Up Powdercoat Paint Kit

Repair of minor scratches and discoloration of the appliance's charcoal powdercoated surfaces may be accomplished with the use of this touch-up paint kit.



Cat. No.	Model	Description
90L74	TPK-C	Touch-Up Powdercoat Paint Kit

NOTE: DIAGRAMS & ILLUSTRATIONS ARE NOT TO SCALE.

### Brick Liner Kit

The brickade liner kit includes panels for the rear and side walls of the firebox. The panels have brick-like features in relief. This kit can be retro-fitted into a previously installed appliance.



Cat. No.	Model	Description
H0917	BLK-30BVI	Brick Liner Kit, EBVI30
H1577	BLK-25BVI	Brick Liner Kit, EBVI25

### Decorative Bay Window Trim Kits

These decorative trim accents, install along the top and bottom front edges of the bay window. They are available in two different finishes to enhance the beauty of the insert and are sure to fit into any decor.

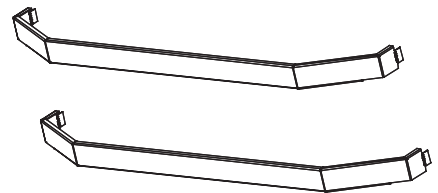

Cat. No.	Model	Description
H1511	BWTK-25G	Bay Window Trim Kit, Gold, EBVI25
H1512	BWTK-25BS	Bay Window Trim Kit, Brushed Stainless, EBVI25
H0898	BWTK-30G	Bay Window Trim Kit, Gold, EBVI30
H0899	BWTK-30BS	Bay Window Trim Kit, Brushed Stainless, EBVI30

## Decorative Flat Louver Kits

These decorative trim accents, install above and below the glass door. They are available in three different finishes to enhance the beauty of the insert and are sure to fit into any decor.



Cat. No.	Model	Description
H1505	FLK-25	Flat Louver Kit, Charcoal, EBVI25
H1506	FLK-25G	Flat Louver Kit, Gold, EBVI25
H1507	FLK-25BS	Flat Louver Kit, Br. Stainless, EBVI25
H0846	FLK-30BVI	Flat Louver Kit, Charcoal, EBVI30
H0847	FLK-30BVI G	Flat Louver Kit, Gold, EBVI30
H0848	FLK-30BVI BS	Flat Louver Kit, Br. Stainless, EBVI30

## Decorative Bay Louver Kits

These decorative trim accents, install above and below the optional Bay Front Assembly. They are available in three different finishes to enhance the beauty of the insert and are sure to fit into any decor.

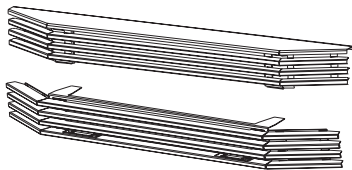

Cat. No.	Model	Description
H1508	BYLK-25	Bay Louver Kit, Charcoal, EBVI25
H1509	BYLK-25G	Bay Louver Kit, Gold, EBVI25
H1510	BYLK-25BS	Bay Louver Kit, Brushed Stainless, EBVI25
H1582	BYLK-30BVI	Bay Louver Kit, Charcoal, EBVI30
H1583	BYLK-30BVI G	Bay Louver Kit, Gold, EBVI30
H1584	BYLK-30BVI BS	Bay Louver Kit, Brushed Stainless, EBVI30

## Beveled Surround Kits

These beveled surround panels install around the insert body providing an attractive finished look.

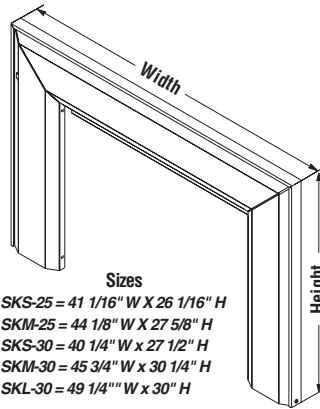

**Sizes**

SKS-25	= 41 1/16" W X 26 1/16" H
SKM-25	= 44 1/8" W X 27 5/8" H
SKS-30	= 40 1/4" W x 27 1/2" H
SKM-30	= 45 3/4" W x 30 1/4" H
SKL-30	= 49 1/4" W x 30" H

Cat. No.	Model	Description
H1503	SKS-25	Beveled Surround, Small, EBVI25
H1504	SKM-25	Beveled Surround, Medium, EBVI25
H0881	SKS-30	Beveled Surround, Small, EBVI30
H0882	SKM-30	Beveled Surround, Medium, EBVI30
H0883	SKL-30	Beveled Surround, Large, EBVI30

## Flat Surround Kits

These flat surround kits are designed to have the outside overall dimensions cut down when custom shaped surround trim panels are needed.

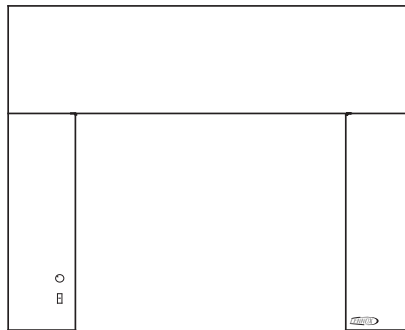

Cat. No.	Model	Description
H3391	EFS-E25I	Elite Insert Flat Surround Kit, EBVI25
H3390	EFS-E30I	Elite Insert Flat Surround Kit, EBVI30

## Hearth Riser Kits

The hearth riser trim kits are designed to be used with the optional surround kits (sold separately). It provides a finished look below the insert face when installed into fireplaces with a elevated firebox.

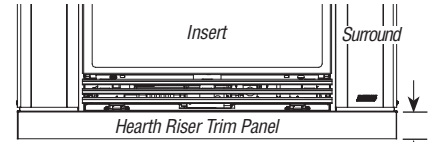

Panels are available in 1", 3" & 6" heights

Cat. No.	Model	Description
EBVI25		
H2042	HRKS1-25	Hearth Riser Kit, SM, E25I, 1"
H2043	HRKS3-25	Hearth Riser Kit, SM, E25I, 3"
H2044	HRKS6-25	Hearth Riser Kit, SM, E25I, 6"
H2045	HRKM1-25	Hearth Riser Kit, MED, E25I, 1"
H2046	HRKM3-25	Hearth Riser Kit, MED, E25I, 3"
H2047	HRKM6-25	Hearth Riser Kit, MED, E25I, 6"
EBVI30		
H2098	HRKS1-30	Hearth Riser Kit, SM, E30I, 1"
H2099	HRKS3-30	Hearth Riser Kit, SM, E30I, 3"
H2100	HRKS6-30	Hearth Riser Kit, SM, E30I, 6"
H2101	HRKM1-30	Hearth Riser Kit, MED, E30I, 1"
H2102	HRKM3-30	Hearth Riser Kit, MED, E30I, 3"
H2103	HRKM6-30	Hearth Riser Kit, MED, E30I, 6"
H2104	HRKL1-30	Hearth Riser Kit, LG, E30I, 1"
H2105	HRKL3-30	Hearth Riser Kit, LG, E30I, 3"
H2106	HRKL6-30	Hearth Riser Kit, LG, E30I, 6"

SM = used with small surround  
 MED = used with medium surround  
 LG = used with large surround

NOTE: DIAGRAMS & ILLUSTRATIONS ARE NOT TO SCALE.

## LIGHTING INSTRUCTIONS – MILLIVOLT GAS VALVE

FOR YOUR SAFETY, READ BEFORE LIGHTING

**WARNING: IF YOU DO NOT FOLLOW THESE INSTRUCTIONS EXACTLY, A FIRE OR EXPLOSION MAY RESULT CAUSING PROPERTY DAMAGE, PERSONAL INJURY OR LOSS OF LIFE.**

- A.** This appliance has a pilot which must be lighted with a piezo igniter. When lighting the pilot, follow these instructions exactly.
- B. BEFORE OPERATING**, smell all around the appliance area for gas. Be sure to smell next to the floor because some gas is heavier than air and will settle on the floor.

### WHAT TO DO IF YOU SMELL GAS

- Extinguish any open flame.
- Open windows.
- Do not light any appliance.
- Do not touch any electrical switches.

- Do not use any phone in your building.
  - Immediately call your gas supplier from a neighbor's phone.
  - If your gas supplier cannot be reached, call the fire department.
- C.** Use only your hand to push in or turn the gas control knob. Never use tools. If the knob will not push in or turn by hand, do not try to repair it, call a qualified service technician. Force or attempted repair may result in a fire or an explosion.
- D.** Do not use this appliance if any part has been under water. Immediately call a qualified service technician to inspect the appliance and to replace any part of the control system and any gas control which has been under water.

## LIGHTING INSTRUCTIONS

- STOP!** Read the safety information above on this page.
- Access the lower control compartment.
- Turn remote wall switch to "OFF."
- Verify main line shut-off valve is open.
- Push in gas control knob slightly and turn clockwise to "OFF."

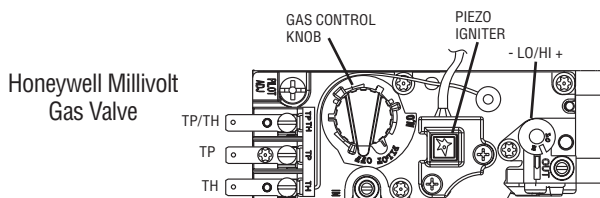
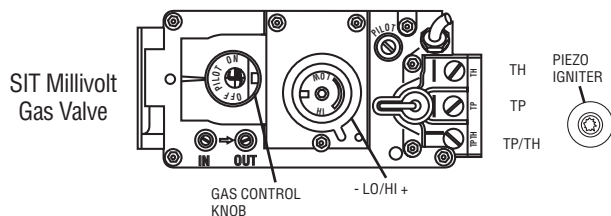

**Note:** Knob cannot be turned from "PILOT" to "OFF" unless the knob is pushed in slightly. Do not force.

- Wait five (5) minutes to clear out any gas. If you then smell gas, STOP! Follow "B" in the safety information above on this page. If you do not smell gas, go to the next step.
- Push in gas control knob slightly and turn counterclockwise to "PILOT."
- Push in control knob all the way and hold in. Immediately light the pilot by triggering the spark igniter (pushing the button) until pilot lights. Continue to hold the control knob in for about 1-1/2 minutes after the pilot is lit. Release knob and it will pop back up. Pilot should remain lit. If it goes out, repeat steps 5 through 8.

- If knob does not pop up when released, stop and immediately call your service technician or gas supplier.
- If pilot will not stay lit after several tries, turn the control knob to "OFF" and call your service technician or gas supplier.

- Turn gas control knob counterclockwise to "ON."
- Close lower control compartment.

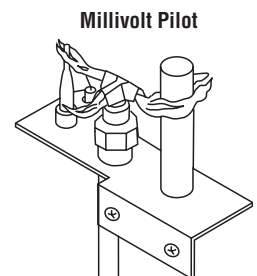

## TO TURN OFF GAS TO APPLIANCE

- Turn remote wall switch "OFF." The pilot will remain lit for normal service.
- For complete shutdown, turn remote wall switch to "OFF."
- Access the lower control compartment.
- Depress gas control knob slightly and turn clockwise to "OFF." Do not force.
- Close lower control compartment.

## INSTRUCTIONS D'ALLUMAGE – VANNE GAZ MILLIVOLT

### POUR VOTRE SÉCURITÉ, LISEZ CES INSTRUCTIONS AVANT L'ALLUMAGE

**AVERTISSEMENT : SI VOUS NE SUIVEZ PAS CES INSTRUCTIONS À LA LETTRE, IL POURRAIT S'EN SUIVRE UN INCENDIE OU UNE EXPLOSION CAUSANT DES DOMMAGES MATÉRIELS, DES BLESSURES CORPORELLES OU MÊME DES PERTES DE VIE.**

- A. Cet appareil est muni d'une veilleuse qui doit être allumée avec un allumeur piézo-électrique. Lorsque vous allumez la veilleuse, suivre exactement ces instructions.
- B. **AVANT L'ALLUMAGE:** Assurez-vous que vous ne détectez aucune odeur de gaz autour de l'appareil ainsi que près du sol; certains gaz, étant plus lourds que l'air, descendent au niveau du sol.  
**VOICI CE QUE VOUS DEVEZ FAIRE SI VOUS DÉCELEZ UNE ODEUR DE GAZ:**
  - Éteignez toute flamme visible.
  - Ouvrez les fenêtres.
  - N'allumez aucun appareil.
  - Ne touchez à aucun commutateur électrique.
  - Ne vous servez d'aucun téléphone dans votre édifice.
- Appelez immédiatement votre compagnie de gaz en utilisant le téléphone du voisin.
- S'il vous est impossible de contacter votre compagnie de gaz, appelez le service des incendies.
- C. N'utilisez que votre main pour manipuler le bouton de réglage du gaz. N'utilisez jamais d'outils. Si le bouton refuse de tourner ou de bouger, n'essayez pas de le réparer. Communiquez immédiatement avec un technicien de service qualifié. Toute tentative pour le forcer ou le réparer, risquerait de provoquer un incendie ou une explosion.
- D. Ne vous servez pas de cet appareil si l'un de ses éléments a été immergé dans l'eau. Appelez immédiatement un technicien compétent pour faire inspecter l'appareil et remplacer toute pièce du système de réglage ou commande du gaz qui a été sous l'eau.

### INSTRUCTIONS D'ALLUMAGE

1. **ARRÊTEZ!** Lisez les consignes de sécurité au verso de cette plaque.
2. Ouvrez le compartiment de contrôle du bas.
3. Tournez l'interrupteur mural à la position d'arrêt "OFF".
4. Assurez-vous que la soupape d'arrêt de la canalisation principale est ouverte.
5. Enfoncez légèrement le bouton de réglage du gaz et tournez-le dans le sens des aiguilles d'une montre jusqu'à la position d'arrêt "OFF".

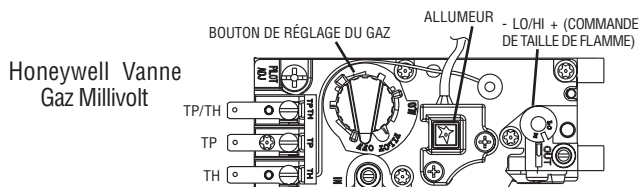
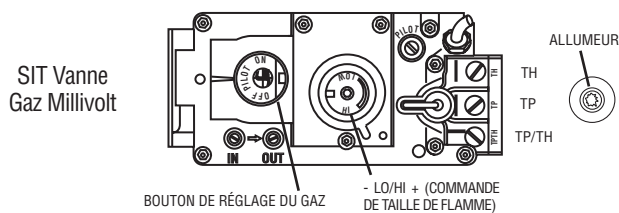

**Remarque:** Il est impossible de tourner le bouton de "PILOT" à "OFF" à moins qu'il ne soit légèrement enfoncé. Ne le forcez pas.

6. Attendez cinq (5) minutes pour l'évacuation du gaz. Si vous décelez une odeur de gaz, **ARRÊTEZ!** Retournez au point "B" des consignes de sécurité au verso de cette plaque. Si vous ne remarquez aucune odeur de gaz, passez à l'étape suivante.
7. Enfoncez légèrement le bouton de réglage du gaz et tournez-le en sens inverse des aiguilles d'une montre jusqu'à la position de veilleuse "PILOT".

8. Enfoncez le bouton de réglage jusqu'au fond et gardez-le enfoncé. Allumez immédiatement la veilleuse en déclenchant l'allume-gaz à étincelle (en poussant le bouton) jusqu'à ce que la veilleuse s'enflamme. Continuez de tenir le bouton de réglage enfoncé pendant environ 90 secondes après l'allumage de la veilleuse. Relâchez le bouton et il sortira subitement. La veilleuse devrait rester allumée. Si elle s'éteint, répétez les étapes 5 à 8 inclusive-ment.

- Si le bouton ne sort pas automatiquement après avoir été relâché, arrêtez immédiatement et téléphonez à votre technicien de service ou à votre fournisseur de gaz.

- Si la veilleuse refuse de rester allumée après plusieurs tentatives, tournez le bouton de réglage jusqu'à sa position d'arrêt "OFF" et téléphonez à votre technicien de service ou à votre fournisseur de gaz.

9. Tournez le bouton de réglage du gaz en sens inverse des aiguilles d'une montre jusqu'à sa position de marche "ON".

10. Fermez le compartiment de contrôle du bas.

11. Au besoin, rebrancher l'appareil au courant électrique et remettre l'interrupteur du brûleur principal à la position "ON" ou régler le thermostat à la température désirée.

12. Si l'appareil ne fonctionne pas, suivre les instructions intitulées "Pour fermer le gaz qui alimente l'appareil" et appeler un technicien ou le fournisseur de gaz.

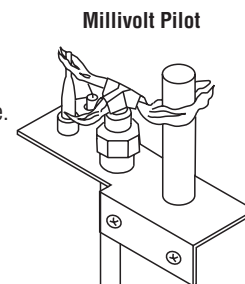

### POUR FERMER LE GAZ QUI ALIMENTE L'APPAREIL

1. Tournez l'interrupteur mural à la position d'arrêt "OFF". La veilleuse restera allumée jusqu'au retour du service normal.
2. Pour une fermeture complète, tournez l'interrupteur mural à la position d'arrêt "OFF".
3. Ouvrez le compartiment de contrôle du bas.
4. Enfoncez légèrement le bouton de réglage du gaz et tournez-le dans le sens des aiguilles d'une montre jusqu'à la position d'arrêt "OFF". Ne forcez pas le bouton.
5. Fermez le compartiment de contrôle du bas.



## REPLACEMENT PARTS LIST

<b>Gas Controls</b>			
<b>Item #</b>	<b>Part/Cat. No.</b>	<b>Description</b>	<b>Where Used</b>
1	67L7001	Pilot Assembly, NG/LP	EBVI25 & EBVI30
2	67L6801	Pilot Tube	EBVI25 & EBVI30
3	67L6701	Thermocouple	EBVI25 & EBVI30
4	60J79	Thermopile (pilot generator)	EBVI25 & EBVI30
5a	111061	Piezo Igniter	EBVI25
5b	24M8901	Piezo Igniter	EBVI30
6	67L8701	Electrode Cable (piezo igniter wire w/ electrode)	EBVI25 & EBVI30
7a	H1657	Gas Valve, NG – SIT	EBVI25
7b	24M1201	Gas Valve, NG – Honeywell	EBVI30
<b>Misc. Gas Components</b>			
8	H1161	Burner Assembly NG/LP	EBVI25 & EBVI30
	H1576	Conversion Kit, NG to LP (GCKNL-E25I)	EBVI25
	H0920	Conversion Kit, NG to LP (GCKNL-E30I)	EBVI30
9	93L32	Connector-Flex Gas	EBVI25 & EBVI30
10a	21L79	Orifice, Burner, NG (#41)	EBVI25
10a	24M1001	Orifice, Burner, NG (#37)	EBVI30
10b	69L45	Orifice, Burner, LP (#53)	EBVI25
10b	21L01	Orifice, Burner, LP (.0625")	EBVI30
<b>Miscellaneous Parts</b>			
12	H1585	Door Kit, Complete	EBVI25
12	H0925	Door Kit, Complete	EBVI30
13	H0928	Grate Assembly	EBVI25 & EBVI30
	69L2101	Latch, Door	EBVI25 & EBVI30
14a	H1138	Switch, Vent Spill Switch	EBVI25 & EBVI30
15	27K30	Switch, Off/on	EBVI25 & EBVI30
<b>Log Set</b>			
16	88L53	FGE Glowing Embers	EBVI25 & EBVI30
17	H1095	Log Set, 7 pc.	EBVI25 & EBVI30
18	42363	Vermiculite, Bag	EBVI25 & EBVI30
<b>Room Air Blower System</b>			
19	H1391	Blower Assembly, 7"	EBVI25
19	H1141	Blower Assembly, 9"	EBVI30
20	H1157	Power Cord	EBVI25 & EBVI30
21a	H1290	Rheostat (knob included)	EBVI25 & EBVI30
21b	527	Knob, Rheostat	EBVI25 & EBVI30
14b	13M2301	Switch, Temp. Control (TOD)	EBVI25 & EBVI30

# REPLACEMENT PARTS DIAGRAMS

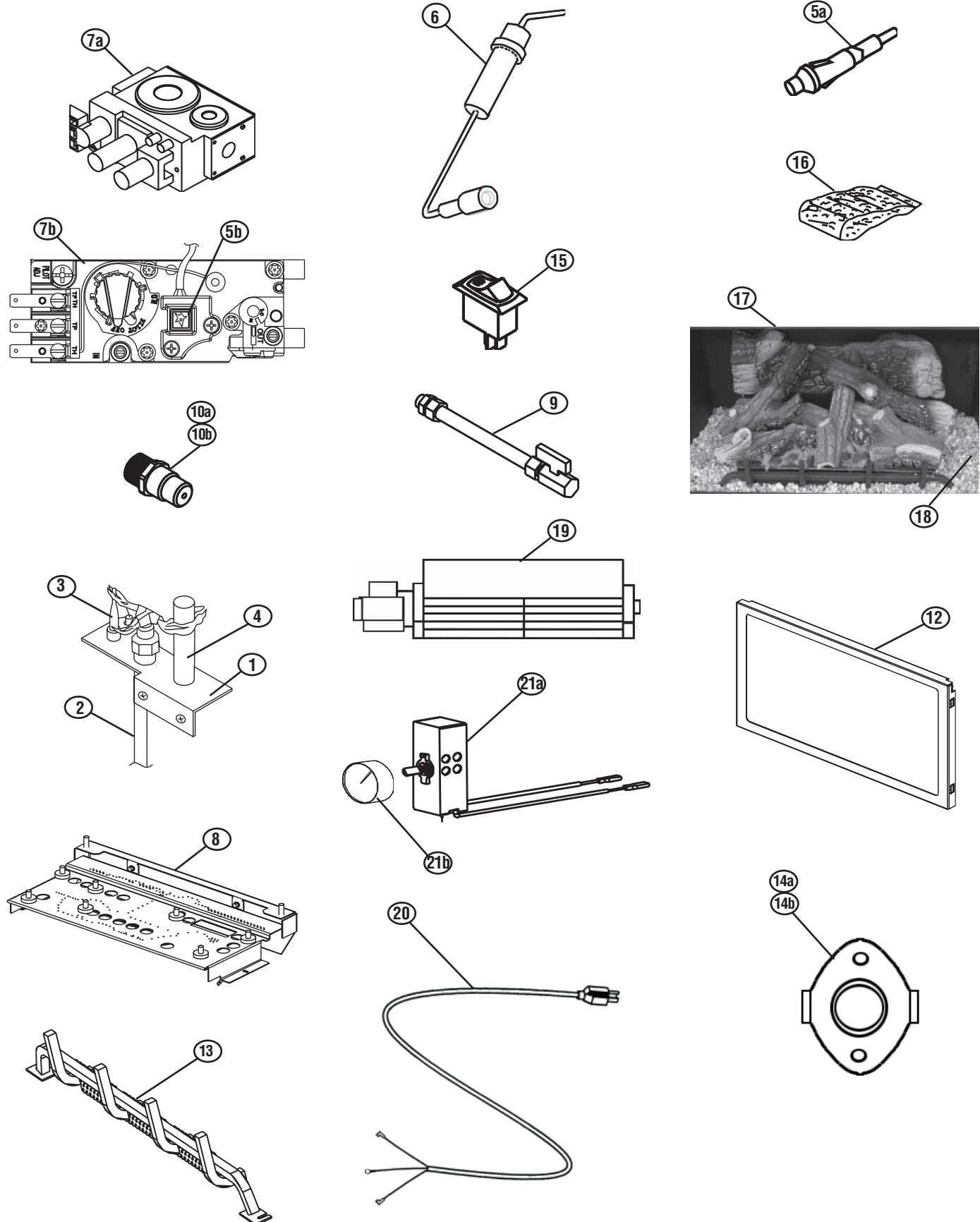

NOTE: DIAGRAMS & ILLUSTRATIONS ARE NOT TO SCALE.

# TROUBLESHOOTING THE MILLIVOLT GAS CONTROL SYSTEM

**Note:** Before troubleshooting the gas control system, be sure external gas shut off valve (located at gas supply inlet) is in the "ON" position. **Important:** Valve system troubleshooting should only be accomplished by a qualified service technician.

SYMPTOM	POSSIBLE CAUSES	CORRECTIVE ACTION
<p>1) Spark igniter will not light pilot after repeated triggering of igniter button.</p> <p><b>WARNING: IF THE PILOT WILL NOT LIGHT AFTER ONE MINUTE OF ATTEMPTING, WAIT FOR AT LEAST FIVE MINUTES FOR GAS TO CLEAR BEFORE ATTEMPTING AGAIN.</b></p>	A. Electrode wire (at piezo igniter) not pushed completely on.	• Check connection
	B. Piezo igniter is defective	• Replace piezo igniter
	C. Defective or misaligned electrode at pilot (spark at electrode)	• Using a match, light pilot. If pilot lights, turn off pilot and trigger the igniter button again. If pilot lights, an improper gas mixture caused the bad lighting and a longer purge period is recommended. If pilot will not light – check gap at electrode and pilot – It should be between 1/8" and 3/16." If the gap is out of this range, adjust the gap or replace the pilot assembly. See <b>Page 11, Figure 25.</b>
	D. Incorrect lighting procedure	• Carefully follow the lighting instructions on <b>Pages 15 &amp; 16</b> or as found in the insert control compartment.
	E. Gas supply problem	• Check for multiple gas shut-offs. Check gas supply lines. Check inlet gas pressure. It should be within the limits as marked on the rating plate.
	F. Pilot orifice plugged	• Clean or replace pilot orifice
<p>2) Pilot will not stay lit after carefully following the lighting instructions.</p>	A. Thermocouple is not firmly connected to control valve	• Check connection at valve
	B. Pilot flame is not directed to top of thermocouple	• Ensure thermocouple is fully inserted into pilot assembly. Clean and/or adjust pilot for maximum flame impingement on thermocouple if necessary.
	C. Thermocouple is defective. The millivolt production should be a minimum of 14 MV with pilot only.	• Replace thermocouple
<p>3) Pilot flame stays lit, but main burner will not light (valve pilot/off/on knob is in ON position, off/on switch, wall thermostat or remote control is set to ON).</p> <p>Read important note below.</p> <p><b>IMPORTANT NOTE: If an optional Remote Switch* is used for burner operation and if the standard burner OFF/ON switch is still installed on appliance, it must be in the "OFF" position.</b></p>	A. Burner control switch (off/on switch, wall thermostat or remote control) is in "OFF" position; or thermostat (if installed) is set to a temperature setting that is too low.	• Turn burner off/on switch on and/or refer to instructions provided with optional thermostat or remote control, if applicable.
	B. Electrical wiring is damaged or poorly connected or remote switch is defective.	• Check wall switch and wires for proper connections. Refer to Millivolt Wiring Diagram ( <b>Page 12, Figure 28</b> ). Jump the wire across terminals at the wall switch, if the burner comes on, replace the defective wall switch. If okay, jumper the wires across the wall switch wires at the valve. If the burner comes on, wires are faulty or connections are bad.
	C. One of the following components may be defective: burner control switch, thermostat, vent spill switch, or thermopile. Thermopile: Millivolt production should be a minimum of 325 MV with pilot only.	• Refer to Millivolt Wiring Diagram ( <b>Page 12, Figure 28</b> ). Electrically bypass components one at a time and replace defective item.
	D. Thermopile may not be generating sufficient millivolts	• Check thermopile with millivolt meter. Take reading at thermopile terminals of gas valve. It should read 325 millivolts minimum with optional wall switch "OFF." Replace faulty thermopile if reading is below specified minimum.
	E. Plugged burner orifice	• Check burner orifice for blockage and remove.
	F. OFF/ON Switch & Remote Switch* are in the "ON" position resulting in excessive resistance	• When turning on the burner using a Remote Switch,* ensure that the standard OFF/ON Switch is in the "OFF" position. If both switches are in the ON position, it may result in excessive resistance (& millivolt drainage) and the burner may not come on.
4) Frequent pilot/burner outage problem	A. Pilot flame may be too low or blowing (high) causing the pilot/valve safety to drop out.	• Clean and/or adjust pilot flame for maximum flame impingement on thermocouple. See <b>Page 11, Figure 25.</b>
<p>5) Main burner stays lit for up to 10 minutes and then shuts off, pilot flame remains lit.</p>	A. Vent is blocked; flue gas is "spilling," which activates the spill switch and shuts down the burner.	• Examine venting system for blockage. Remove any blockage.
	B. The house is negatively pressurized resulting in spill switch activation.	• Open a window to see if the problem is corrected.
6) Smell of gas	A. Pilot, gas supply system, or pilot & burner adjustment screws on valve may be leaking. <b>FOLLOW INSTRUCTIONS ON THE COVER OF THIS MANUAL</b>	• <b>WARNING: NEVER USE AN OPEN FLAME TO CHECK FOR LEAKS.</b> After the gas company or fire department has given clearance to re-enter the dwelling, have a qualified technician test all gas joints from the gas meter to the gas heater regulator for leaks using a gas leak test solution (also referred to as bubble leak solution).
<p>7) A thin coating of black soot forms on the window.</p> <p><b>Note:</b> See <b>Page 5, Glass Cleaning.</b></p>	A. Burner primary air inlet is restricted or blocked	• Ensure all openings (fresh air inlets) in the insert are free from dust and debris. Recheck these areas periodically.
	B. Flames make contact with logs or other surfaces	• Ensure ceramic logs are in their correct positions.
	C. Improper venting	• Check for flue blockage, disconnected flue, improper installation. Make appropriate corrections.
8) A white coating forms on windows, logs, and/or inside walls of firebox.	A. Residues/impurities being burned off or impurities in the fuel	• Follow cleaning guidelines outlined in the MAINTENANCE section of this manual.

\* Optional Remote Switch kits: wall switch, wall thermostat or remote control.

---

LENNOX reserves the right to make changes at any time, without notice, in design, materials, specifications, prices and also to discontinue colors, styles and products.  
Consult your local distributor for insert code information.



**HEARTH PRODUCTS**

1110 West Taft Avenue • Orange, CA 92865

Printed in U.S.A. © LENNOX HEARTH PRODUCTS 2003  
**P/N 775,155M Rev. D 12/2005**

## Free Manuals Download Website

<http://myh66.com>

<http://usermanuals.us>

<http://www.somanuals.com>

<http://www.4manuals.cc>

<http://www.manual-lib.com>

<http://www.404manual.com>

<http://www.luxmanual.com>

<http://aubethermostatmanual.com>

Golf course search by state

<http://golfingnear.com>

Email search by domain

<http://emailbydomain.com>

Auto manuals search

<http://auto.somanuals.com>

TV manuals search

<http://tv.somanuals.com>