



HEARTH PRODUCTS

HEARTH PRODUCTS
KITS AND ACCESSORIES

775,235M
Rev. C, 03/2008

EPIC™ GAS CONVERSION INSTRUCTIONS LP TO NG
CAT. NO. 75355, MODEL EPIC-CK-LP TO NG

INSTALLATION INSTRUCTIONS FOR CONVERTING FROM PROPANE GAS (LP) TO NATURAL GAS (NG). FOR USE WITH THE EPIC DIRECT VENT GAS STOVE

ELITE™ SERIES

KIT CONTENTS (See Figure 1):

- 1 ea. Nova SIT NG Regulator Kit (A)
- 1 ea. #31 NG main burner orifice (40,000 BTU's) (B)
- 1 ea. #36 NG main burner orifice (33,000 BTU's) (C)
- 1 ea. Sticker "EPIC33" if NG orifice was #36
- 1 ea. Instruction Sheet

TOOLS NEEDED (See Figure 2):

- 5/32" Allen Wrench Or T-Handle Wrench
- 1/8" Allen Wrench Or T-Handle Wrench
- Torx Bit (T20 with 1/4" shank and center hole)
- 1/2" Open End Wrench
- 7/16" Open End Wrench

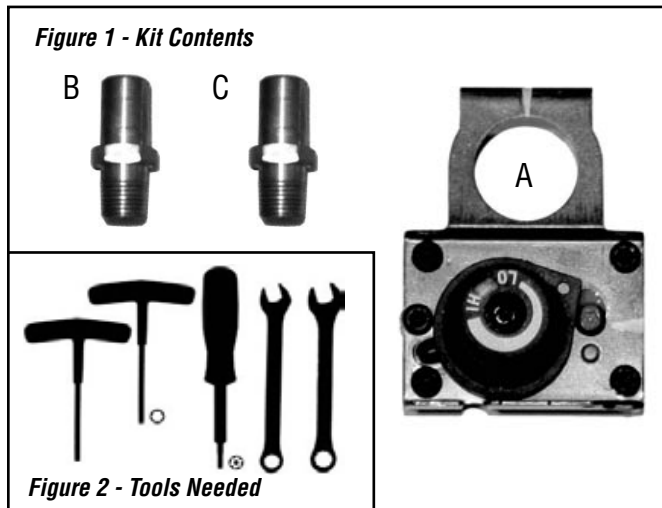

⚠ AVERTISSEMENT

Cet équipement de conversion sera installé par une agence qualifiée de service conformément aux instructions du fabricant et toutes exigences et codes applicables de l'autorisés avoir la juridiction. Si l'information dans cette instruction n'est pas suivie exactement, un feu, explosion ou production de protoxyde de carbone peut résulter le dommages causer de propriété, perte ou blessure personnelle de vie. L'agence qualifiée de service est esponsable de l'installation propre de cet équipement. L'installation n'est pas propre et complète jusqu'à l'opération de l'appareil converti est chèque suivant les critères établis dans les instructions de propriétaire provisionnées avec l'équipement.

⚠ IMPORTANT CANADA

The conversion shall be carried out in accordance with the requirements of the provincial authorities having jurisdiction and in accordance with the requirements of the CAN/CSA B149.1 Installation code.

⚠ IMPORTANT LE CANADA SEULEMENT

La conversion devra être effectuée conformément aux recommandations des autorités provinciales ayant juridiction et conformément aux exigences du code d'installation CAN/CSA B149.1 .

⚠ WARNING

This conversion kit shall be installed by a qualified service agency in accordance with the manufacturer's instructions and all applicable codes and requirements of the authority having jurisdiction. If the information in these instructions is not followed exactly, a fire, explosion or production of carbon monoxide may result causing property damage, personal injury or loss of life. The qualified service agency performing this installation is responsible for the proper installation of this kit and assumes responsibility for this conversion. The installation is not proper and complete until the operation of the converted appliance is checked as specified in the manufacturers instructions supplied with the kit.

⚠ IMPORTANT

The burner orifices provided in this kit are only for use at elevations of 0 to 2,000 feet (610 M) in the USA and 0 to 4,500 feet (0-1372 M) in Canada. At higher elevations the BTU input must be de-rated by 4% for every 1,000 feet (305 M) to maintain the proper ratio of gas to air. If the installer must convert the unit to adjust for varying altitudes, a deration information sticker must be filled out by the installer and adhered to the appliance at the time of the conversion. Contact your local gas supplier for deration requirements for your area.

READ ALL THE STEPS BEFORE STARTING THE CONVERSION.
INSTALLER NOTICE: THESE INSTRUCTIONS MUST BE LEFT WITH THE APPLIANCE.

This kit contains components required to convert this appliance from using Propane Gas to using Natural Gas as the only fuel. All of these components must be replaced in order for the unit to operate safely on Natural Gas.

When installing gas components use pipe joint compound or Teflon tape on all pipe fittings before installing (ensure propane resistant compounds are used, do not use pipe joint compounds on flare fittings).

INSTALLATION INSTRUCTIONS

TURN OFF THE GAS SUPPLY TO THE APPLIANCE.

Step 1. Using an 1/8" allen wrench, remove the control panel cover by removing the 4 button screws around the control panel (indicated by arrows in **Figure 1**). Do not disconnect any wires during this step.

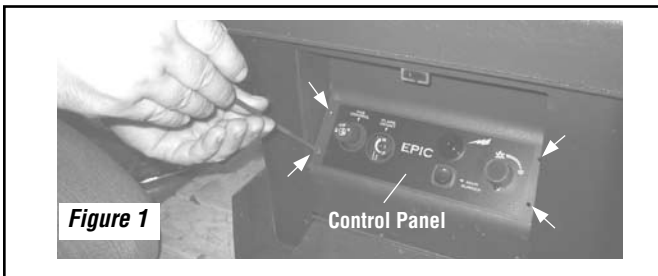

Step 2. Remove the knob extensions on the gas control and flame height knobs by pulling them off.

Step 3. Using a Torx T20 or flat screwdriver, remove the Nova SIT LP Regulator (flame height knob) by removing the 3 screws surrounding it (see **Figures 2 and 3**). Be sure to also remove the LP regulator diaphragm (see **Figures 2 and 4**).

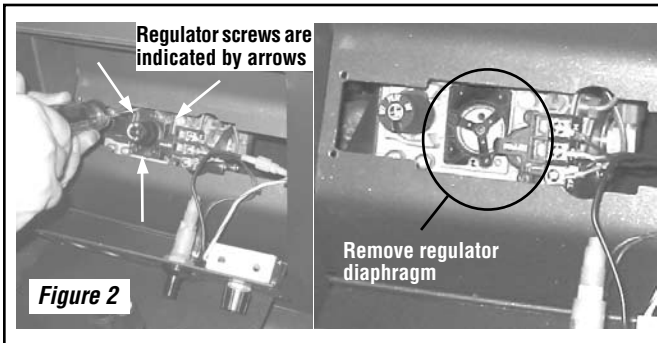

Step 4. Install the Nova SIT NG Regulator (included in this kit) using the 3 new screws provided as shown in **Figure 3**.

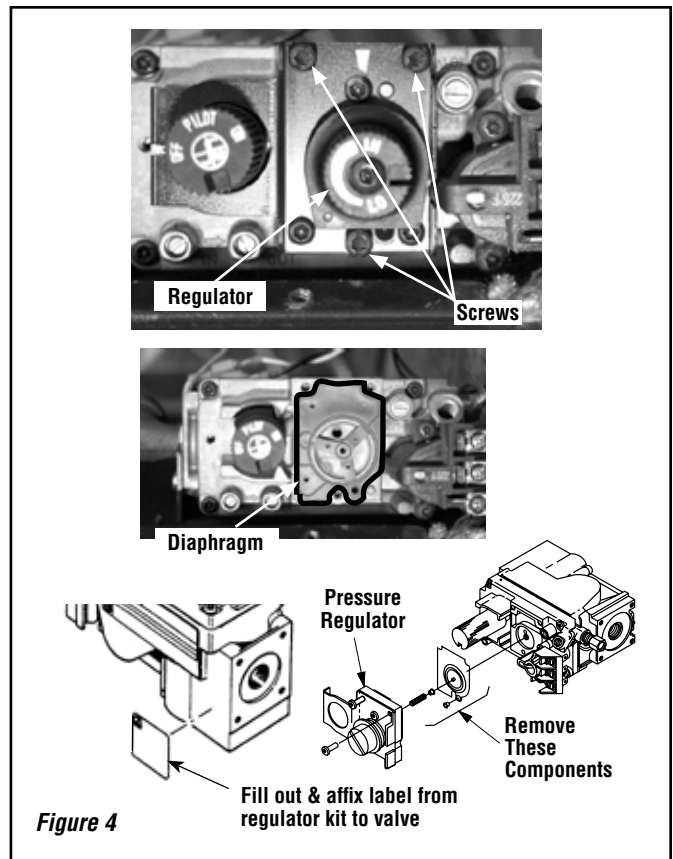
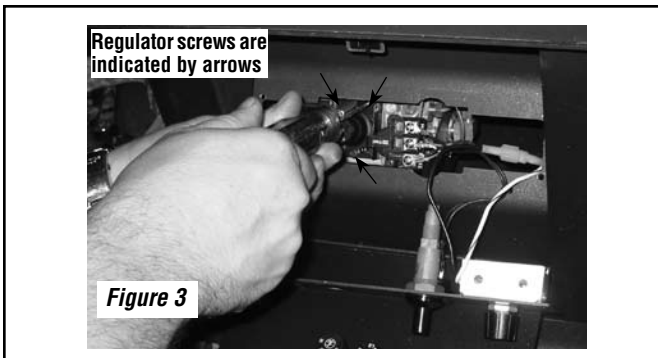

Step 5. Replace the knob extensions on the gas control and flame height knobs. Reinstall the control board panel using the 4 button screws removed during step 1.

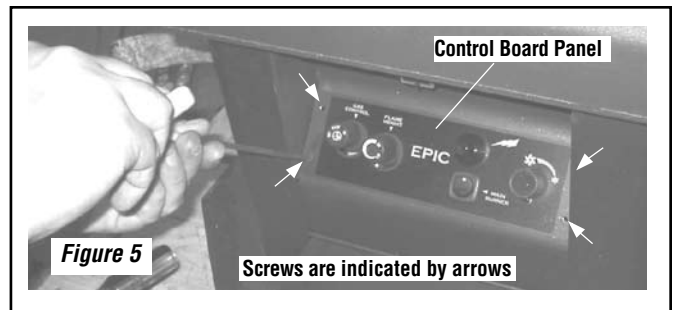

Step 6. Using a 5/32" allen wrench, remove the 2 screws near the rear corners of the burner pan (see **Figure 6**).

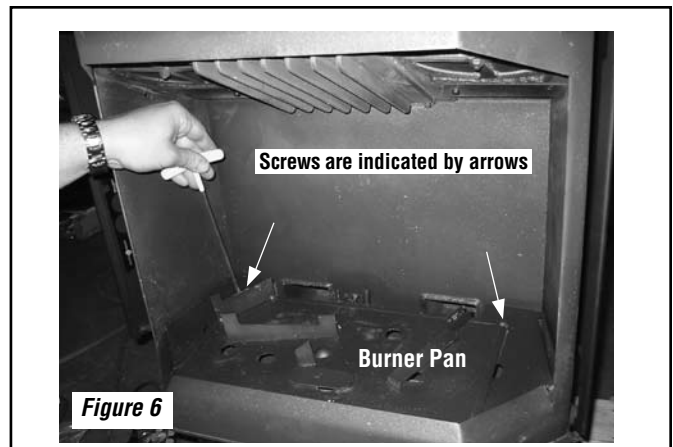

Step 7. Before removing the burner pan slide the air shutter control lever all the way to the right to the open position (see **Figure 7**). To remove the burner pan lift up on the left side, then slide the burner to the left and lift out (see **Figure 8**).

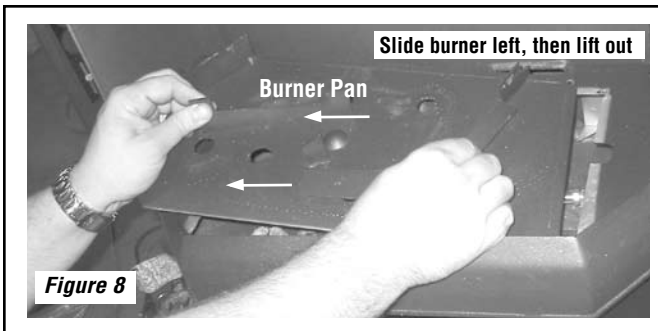
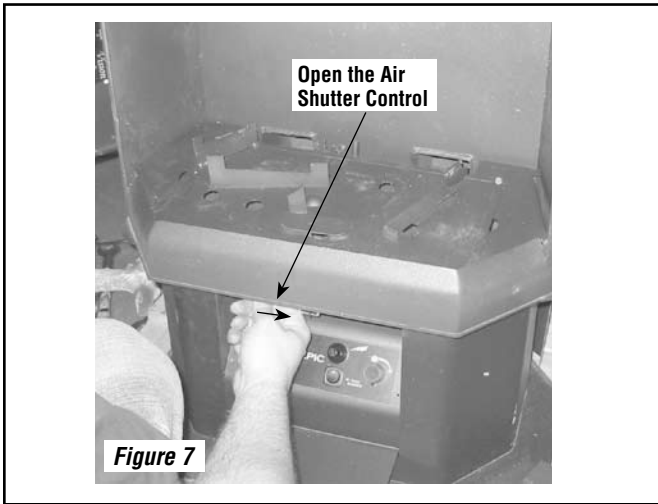

Step 8. Move the air shutter off of the orifice. Using a 1/2" open end wrench, remove the orifice by turning counterclockwise. See **Figure 9**.

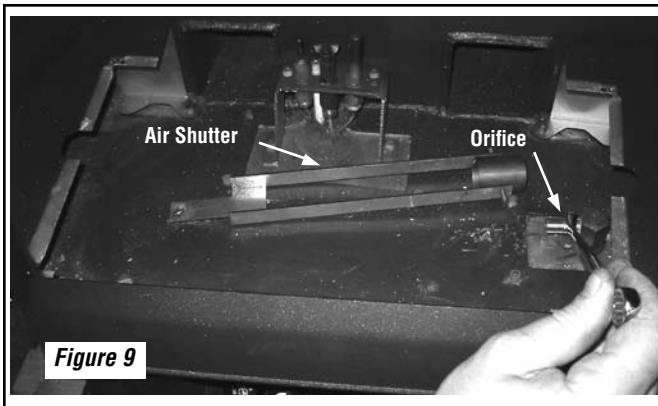

Step 9. Using a 1/2" end wrench, replace the LP orifice with the NG main burner orifice included in this kit (#31 for 40,000 BTU or #36 for 33,000 BTU). See **Figure 9**.

Step 10. Using a 7/16" open-end wrench, loosen the stem of pilot hood assembly with a 1/4 turn counterclockwise (see **Figure 10**).

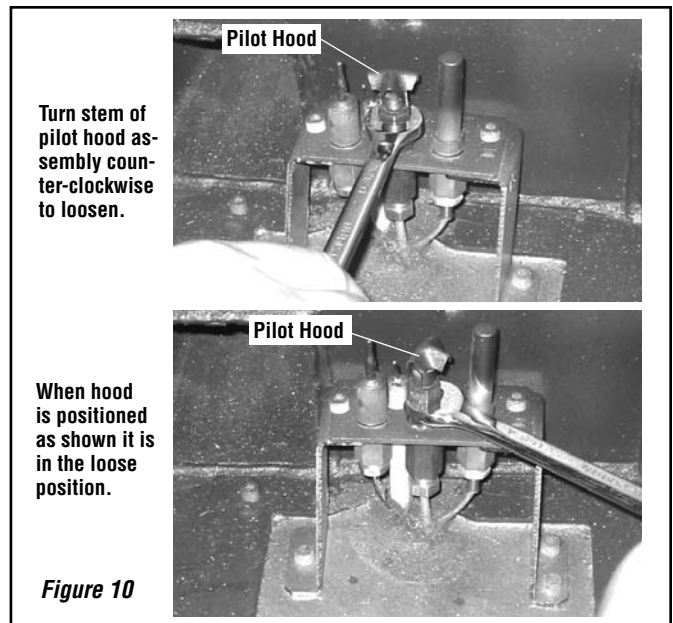

Step 11. Convert the orifice to NG by pushing the orifice slider to the right. The top side of the orifice slider will be labeled NG. See **Figure 11**.

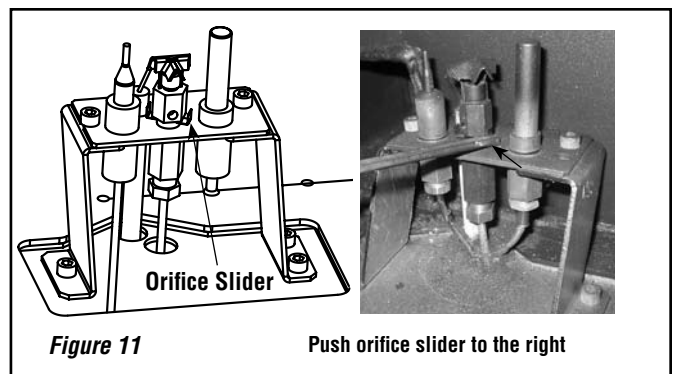

Step 12. Retighten the pilot orifice with 7/16" open end wrench (see **Figure 10**). Ensure that the orifice slider stays in the NG position while tightening (see **Figure 11**).

Step 13. Reinstall the burner, right side first, making sure that the burner neck is seated in the air shutter (see **Figure 12**).



Step 14. Before you secure the burner with screws, double check that the orifice is positioned into the burner neck by feeling around the back of the burner (see **Figure 13**). Then, lower the burner so it sits flush on the burner supports and replace the 2 screws removed in step 6 (see **Figure 13**).

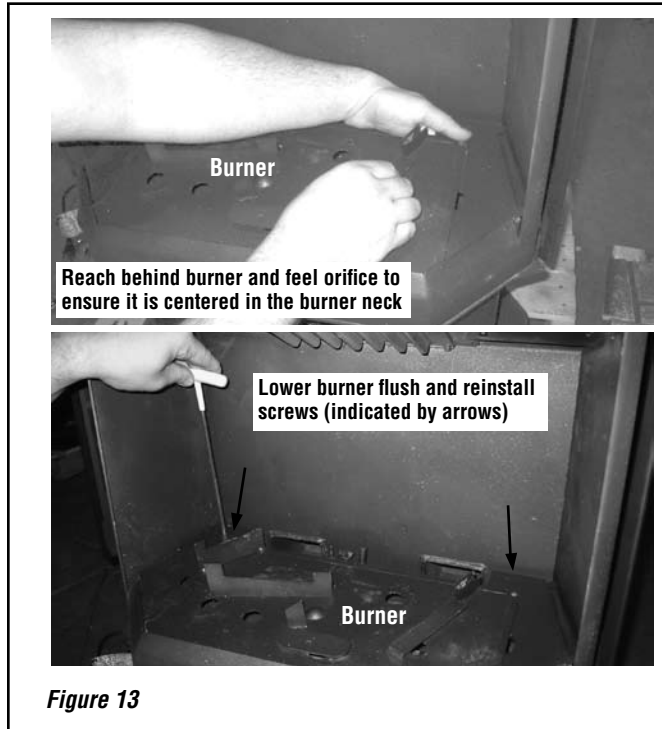

Reach behind burner and feel orifice to ensure it is centered in the burner neck

Lower burner flush and reinstall screws (indicated by arrows)

Figure 13

Step 15. Remove the sticker covering the model on the label so that it reads "Epic NG40" if orifice #31 is installed. Use the sticker "Epic NG33" to cover "Epic NG40" on the label if orifice #36 is installed. The label is located on the inside of the left hand door (see **Figure 14**).



Safety Label

Figure 14

Step 16. Turn on gas supply and test for gas leaks using a gas leak test solution (see **Test Procedure** on **Page 18** of the **Installation and Operation Manual**).

Step 17. Using a manometer, test the inlet and manifold gas pressure per instructions in the **Installation and Operation Manual (Page 18)** and as shown in the following 2 tables.

| Inlet Gas Supply Pressure | | | |
|---------------------------|-----------------------------|--------------------------------|-----------------------------|
| Fuel # | Minimum | Maximum | Desired |
| Nat. Gas | 5" WC/po. C.E (1.24 kPa) | 10.5" WC/po. C.E (2.61 kPa) | 7" WC/po. C.E (1.74 kPa) |

| Manifold Gas Supply Pressure | | |
|------------------------------|------------------------------------|------------------------------------|
| Fuel # | Low | High |
| Natural Gas | (Lo) 1.7" WC/po. C.E (0.42 kPa) | (Hi) 3.5" WC/po. C.E (0.87 kPa) |

Step 14. Reinstall the log set and glass door assembly. See **Page 12 (Log Set Installation)** and **Page 25 (Door Assembly Installation)** in the **Installation and Operation Manual**.

Step 15. Light the appliance per the lighting instructions label on appliance (located inside left door) or lighting instructions on **Page 19** of the **Installation and Operation Manual**. Inspect for proper pilot and burner flame appearances (see **Figures 15 and 16** below). Also see **Flame Color and Behavior** and **Inspect The Pilot System For Proper Flame** on **Page 20** of the **Installation and Operation Manual**.

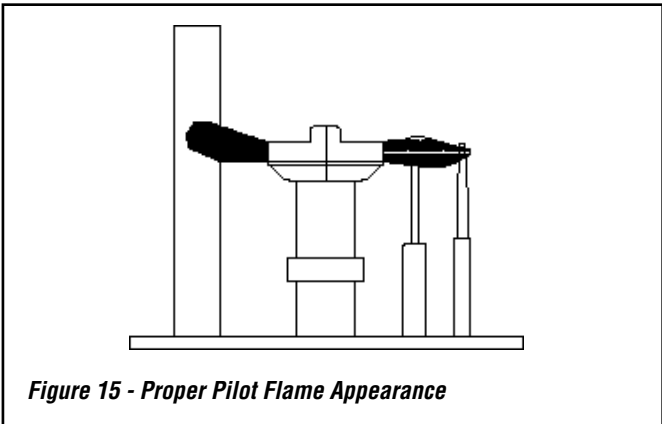

Figure 15 - Proper Pilot Flame Appearance

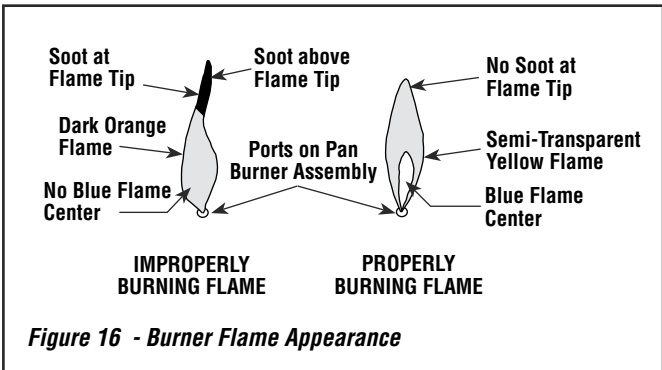

Figure 16 - Burner Flame Appearance

NOTE: DIAGRAMS AND ILLUSTRATIONS ARE NOT TO SCALE.

Lennox reserves the right to make changes at any time, without notice, in design, materials, specifications, prices and also to discontinue colors, styles and products. Consult your local distributor for fireplace code information.



HEARTH PRODUCTS
1110 West Taft Avenue • Orange, CA 92865

Free Manuals Download Website

<http://myh66.com>

<http://usermanuals.us>

<http://www.somanuals.com>

<http://www.4manuals.cc>

<http://www.manual-lib.com>

<http://www.404manual.com>

<http://www.luxmanual.com>

<http://aubethermostatmanual.com>

Golf course search by state

<http://golfingnear.com>

Email search by domain

<http://emailbydomain.com>

Auto manuals search

<http://auto.somanuals.com>

TV manuals search

<http://tv.somanuals.com>