

# APPLICATION GUIDE

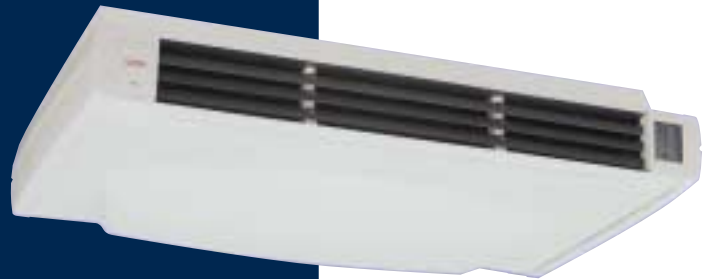

PROVIDING **GLOBAL SYSTEM** SOLUTIONS

WING



---

**Congratulations you have made a wise choice with the purchase of your Lennox  
air conditioning unit.**  
**This product has been designed, assembled and supplied in one of our world class manufacturing facilities  
and we feel sure that it will meet your expectations.**  
**Lennox an international organisation with world wide distribution takes pride in supplying you with this  
product.**

---

CONTENTS

<b>CONTENTS</b>	<b>PÁGE</b>
. PRODUCT RANGE	2-3
. SYSTEM CONFIGURATION	4
. GENERAL DESCRIPTION	5
. SPECIFICATIONS	6-9
. ELECTRICAL DATA	10-11
. ELECTRICAL CONNECTIONS	12-14
. INDOOR MOTOR FAN CHARACTERISTICS	15
. OPERATING LIMITS	16
. REFRIGERANT CONNECTIONS	17-19
. DIMENSIONS AND SETTING UP TEMPLATES OUTDOOR UNIT	20
. DESCRIPTION OUTDOOR UNIT	21-22
. ENTRANCE STANDARD/ OPTIONAL OUTDOOR UNIT	23
. DIMENSIONS AND SETTING UP TEMPLATES INDOOR UNIT	24
. INSTALATION AND MOUNTING	25
. OPTIONS	26-27
. MAINTENANCE	28
. POINTS TO KEEP IN MIND	29

LTX INDOOR UNIT IN COMBINATION, WITH AXIAL FAN OUTDOOR UNIT

MODEL	OUTDOOR UNIT	INDOOR UNIT	V / Ph / 50 Hz	NOMINAL CAPACITY W	NOMINAL CAPACITY KW
				COOLING ONLY	COOLING ONLY
WING 2,8TFK	KJF 2,8K	LTX 3	230V-1Ph	7.350	3,06
WING 3TFK	KJF 3K	LTX 3	230V -1Ph	9.500	3,85
WING 3TFK	KJF 3K		230 V - 3Ph		
WING 3TFK	KJF 3K		400 V - 3Ph		
WING 4TFK	KJF 4K	LTX 5	230 V - 3Ph	11.600	4,70
WING 4TFK	KJF 4K		400 V - 3Ph		
WING 5TFK	KJF 5K	LTX 5	230 V - 3Ph	13.500	5,60
WING 5TFK	KJF 5K		400 V - 3Ph		

LTX INDOOR UNIT IN COMBINATION, WITH CENTRIFUGAL FAN OUTDOOR UNIT

MODEL	OUTDOOR UNIT	INDOOR UNIT	V / Ph / 50 Hz	NOMINAL CAPACITY W	NOMINAL CAPACITY KW
				COOLING ONLY	COOLING ONLY
WING 2,8CFK	KCF 2,8K	LTX 3	230V-1Ph	7.130	3,07
WING 3CFK	KCF 3K	LTX 3	230V -1Ph	9.100	3,86
WING 3CFK	KCF 3K		230 V - 3Ph		
WING 3CFK	KCF 3K		400 V - 3Ph		
WING 4CFK	KCF 4K	LTX 5	230 V - 3Ph	12.100	5,17
WING 4CFK	KCF 4K		400 V - 3Ph		
WING 5CFK	KCF 5K	LTX 5	230 V - 3Ph	14.000	7,00
WING 5CFK	KCF 5K		400 V - 3Ph		

LTX INDOOR UNIT IN COMBINATION, WITH AXIAL FAN OUTDOOR UNIT

MODEL	OUTDOOR UNIT	INDOOR UNIT	V / Ph / 50 Hz	NOMINAL CAPACITY W		NOMINAL CAPACITY KW	
				COOLING ONLY	HEAT PUMP	COOLING ONLY	HEAT PUMP
WING 2,8TB	KJB 2,8	LTX 3	230V-1Ph	7.350	7.800	3,06	2,60
WING 3TB	KJB 3	LTX 3	230V -1Ph	9.250	9.000	3,70	3,00
WING 3TB	KJB 3		230 V - 3Ph				
WING 3TB	KJB 3		400 V - 3Ph				
WING 4TB	KJB 4	LTX 5	230 V - 3Ph	11.600	12.100	4,70	3,90
WING 4TB	KJB 4		400 V - 3Ph				
WING 5TB	KJB 5	LTX 5	230 V - 3Ph	13.700	14.600	5,90	5,00
WING 5TB	KJB 5		400 V - 3Ph				

LTX INDOOR UNIT IN COMBINATION, WITH CENTRIFUGAL FAN OUTDOOR UNIT

MODEL	OUTDOOR UNIT	INDOOR UNIT	V / Ph / 50 Hz	NOMINAL CAPACITY W		NOMINAL CAPACITY KW	
				COOLING ONLY	HEAT PUMP	COOLING ONLY	HEAT PUMP
WING 2,8CB	KCB 2,8S	LTX 3	230V-1Ph	7.130	8.150	3,07	2,77
WING 3CB	KCB 3S	LTX 3	230V -1Ph	9.100	10.220	3,86	3,40
WING 3CB	KCB 3S		230 V - 3Ph				
WING 3CB	KCB 3S		400 V - 3Ph				
WING 4CB	KCB 4S	LTX 5	230 V - 3Ph	12.100	13.500	5,17	4,33
WING 4CB	KCB 4S		400 V - 3Ph				
WING 5CB	KCB 5S	LTX 5	230 V - 3Ph	14.000	17.400	7,00	6,40
WING 5CB	KCB 5S		400 V - 3Ph				

## SYSTEM CONFIGURATION (INDOOR UNIT)

### IMPORTANT

**Prior of making the electrical connections,  
set the switch for heat pump unit or for cooling only unit.**

This unit is valid for operating as a cold only or heat pump application.

The unit should be configured prior to making the electrical connections, by setting the configuration switch as follows:

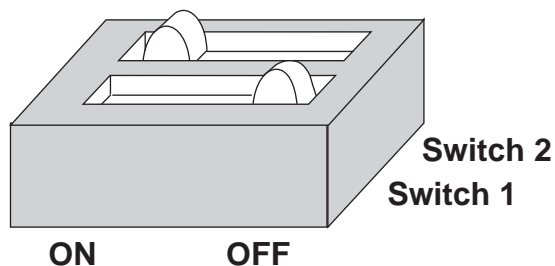

MODEL	SWITCH	
	1	2
COOLING ONLY (*)	OFF	ON
HEAT PUMP	ON	ON

(\*) Configuration from factory..

Check page 8 for more information about the situation of this switch.

### NOTE:

**If errors are made during the configuration of the system, switch off the main power supply, set configuration switch in the correct position and then switch the power on.**

## GENERAL DESCRIPTION

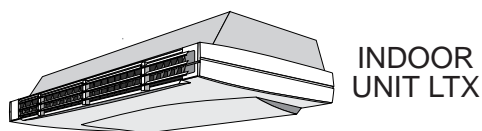

INDOOR  
UNIT LTX

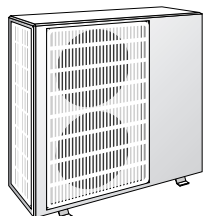

OUTDOOR UNIT  
KJF/KJB



OUTDOOR UNIT  
KCF/KCB

The ceiling air conditioner SPLIT, on version cooling only and heat pump, are units air condensed. The indoor unit with direct air supply, realise function of cooling , heating dehumidification, cleaning air of the sites. Also the option to incorporate with maximum facilities a heating resistance on units cooling only and also on heat pump units.

The indoor unit can be combine with outdoor units provide with axial fan (KJF/ KJB) for outside installation or with outdoor unit provide with centrifugal fan (KCF/ KCB) for installation inside buildings.

## CABINE

The outdoor unit is made on electrozincated steel with epoxy painted finish, able to work outdoors under the worst conditions. its dimensions and features allow the unit to be positioned in almost any location. It incorporate thermal acoustic insulation. The indoor unit is finished in a decorative plastic with thermal acoustic insulation.

## HEAT EXCHANGER

Made of cooper tubes and aluminium fins. Coils have been designed and manufactured to ensure maximum efficiency. The L shaped outside unit heat exchanger makes this unit compact an highly efficiency.

## COMPRESSOR

An hermetically sealed compressor, with internal thermal protection. It is mounted on vibration absorbent blocks both on the inside and outside, statically an dynamically balanced. In all cases the compressors are acoustically isolated, resulting in low noise.

## FANS

The indoor units includes centrifugal motor fan of three speed, with exceptional features on noise level Depending on outdoor type, it includes one or two axial motor fan (units KJF/KJB), or one centrifugal fan (units KCF/ KCB),with exceptional features in noise level and flow .

## AIR SWEEP

The indoor unit (LTX) have an automatic dispositive to distribute horizontal air flow.

## COOLING CIRCUIT

Made of welded dehydrated copper pipe with service port on the suction and liquid lines. Coupling valves on outdoor unit and flare connexion on indoor unit to facilitate the refrigerant connexion. A muffler in the compressor discharge line eliminates noise and pulsation of the discharge line. The unit includes filter dryer and expansion system. It has unidirectional and reversing valves of 4 pipes for unit in heat pump.

## ELECTRIC CIRCUIT

The indoor unit electrical panel includes a printed board, which control the operating of the unit, defrosting timer thermostat and system of reversing on heat pump cycle. The unit is controlled from an infrared remote controller.

## OPTIONS

### OUTDOOR UNIT

- Heating electrical heater.

### OUTDOOR UNIT TYPE KJF/KJB

- Supporting with braxkets( depends on units)
- Winter control.

### OUTDOOR UNIT TYPE KCF/KCB

- Winter control
- Main switch (depends on models)
- Grille external air

## SPECIFICATIONS COOLING ONLY

### OUTDOOR UNIT WITH AXIAL FAN

**R-407C**

MODEL			WING 2,8TFK	WING 3TFK	WING 4TFK	WING 5TFK
Cooling capacity	(*)	W	7.350	9.500	11.600	13.500
<b>OUTDOOR UNIT</b>			<b>KJF 2,8K</b>	<b>KJF 3K</b>	<b>KJF 4K</b>	<b>KJF 5K</b>
<b>COMPRESSOR</b>	Nº / Type		1 / ALT.	1 / ALT.	1 / ALT.	1 / ALT.
<b>FAN</b>						
Air flow outdoor unit		m3/h.	3.100	5.100	5.400	5.400
<b>REFRIGERANT</b>	Type / R-407C	gr. (1)	1650	2500	2600	2600
<b>EXPANSIÓN</b>			Capillary	Capillary	Capillary	Capillary
<b>WEIGHT</b>		Kg	78	85	96	98
<b>DIMENSIONS</b>						
Height		mm.	781	1035	1035	1035
Width		mm.	973	973	973	973
Depth		mm.	333	333	333	333
<b>PACKING DIMENSIONS</b>		mm.	845 x 1060 x 385	1085 x 1275 x 385		
<b>REFRIGERANT COUPLING</b>						
Liquid pipe			3/8"	3/8"	3/8"	1/2"
Gas pipe			5/8"	3/4"	3/4"	3/4"

INDOOR UNIT			LTX 3	LTX 3	LTX 5	LTX 5
<b>FAN</b>						
Air flow indoor unit		m3/h.				
		Max.	1.300	1.300	2.100	2.100
		Min.	1.100	1.100	1.800	1.800
<b>WEIGHT</b>		Kg	40	40	57	57
<b>DIMENSIONS</b>						
Height		mm.	267	267	312	312
Width		mm.	1.409	1.409	1.719	1.719
Depth		mm.	656	656	756	756
<b>PACKING DIMENSIONS</b>		mm.	310 x 1430 x 680		352 x 1749 x 776	
<b>REFRIGERANT COUPLING</b>						
Liquid pipe			3/8"	3/8"	1/2" (2)	1/2"
Gas pipe			3/4"	3/4" (2)	3/4"	3/4"

(\*) Air entry temperature into the indoor unit 27°C DB/19 °C WB

(\*) Air entry temperature into the outdoor unit 35°C DB

(1) Charge of refrigerant, factory charged on outdoor unit. See page 22, to calculate model refrigerant charge.

(2) Use the coupling fittings included in indoor unit for refrigerant connection with outdoor unit.

DB.- Dry Bulb

WB.- Wet Bulb



## SPECIFICATIONS COOLING ONLY

### OUTDOOR UNIT WITH CENTRIFUGAL FAN

**R-407C**

MODEL		WING 2,8CFK	WING 3CFK	WING 4CFK	WING 5CFK	
Cooling capacity	(*)	W	7.180	9.100	12.100	14.000

OUTDOOR UNIT			KCF 2,8K	KCF 3K	KCF 4K	KCF 5K
<b>COMPRESSOR</b>	Nº / Type		1 / ALT.	1 / ALT.	1 / ALT.	1 / ALT.
<b>FAN</b>						
Air flow outdoor unit	<b>m3/h.</b>		2.500	2.500	3.400	5.000
Available pressure	<b>Pa</b>		40	40	50	50
<b>REFRIGERANT</b>	Type / R-407C	<b>gr. (1)</b>	2255	2350	3070	4950
<b>EXPANSIÓN</b>			Capillary	Capillary	Capillary	Capillary
<b>WEIGHT</b>	<b>Kg</b>		89	91	125	140
<b>DIMENSIONS</b>						
Height	<b>mm.</b>		505	505	525	575
Width	<b>mm.</b>		1050	1050	1300	1300
Depth	<b>mm.</b>		750	750	855	855
<b>PACKING DIMENSIONS</b>	<b>mm.</b>		630 x 1140 x 850		775 x 1330 x 865	
<b>REFRIGERANT COUPLING</b>						
Líquid pipe			3/8"	3/8"	3/8"	1/2"
Gas pipe			5/8"	3/4"	3/4"	3/4"

INDOOR UNIT			LTX 3	LTX 3	LTX 5	LTX 5
<b>FAN</b>						
Air flow indoor unit	<b>m3/h.</b>	<b>Max.</b>	1.300	1.300	2.100	2.100
		<b>Min.</b>	1.100	1.100	1.800	1.800
<b>WEIGHT</b>	<b>Kg</b>		40	40	57	57
<b>DIMENSIONS</b>						
Height	<b>mm.</b>		267	267	312	312
Width	<b>mm.</b>		1.409	1.409	1.719	1.719
Depth	<b>mm.</b>		656	656	756	756
<b>PACKING DIMENSIONS</b>	<b>mm.</b>		310 x 1430 x 680		352 x 1749 x 776	
<b>REFRIGERANT COUPLING</b>						
Líquid pipe			3/8"	3/8"	1/2" (2)	1/2"
Gas pipe			3/4" (2)	3/4"	3/4"	3/4"

(\*) Air entry temperature into the indoor unit 27°C DB/19 °C WB

(\*) Air entry temperature into the outdoor unit 35°C DB

(1) Charge of refrigerant, factory charged on outdoor unit. See page 22, to calculate model refrigerant charge.

(2) Use the coupling fittings included in indoor unit for refrigerant connection with outdoor unit.

DB.- Dry Bulb

WB.- Wet Bulb

## SPECIFICATIONS HEAT PUMP

### OUTDOOR UNIT WITH AXIAL FAN

**R-22**

MODEL			WING 2,8TB	WING 3TB	WING 4TB	WING 5TB
Cooling capacity	(*)	W	7.350	9.250	11.600	13.700
Heating capacity	(**)	W	7.800	9.000	12.100	14.600

OUTDOOR UNIT			KJB 2,8	KJB 3	KJB 4	KJB 5
<b>COMPRESSOR</b>	N <sup>a</sup> / Type		1 / ALT.	1 / ALT.	1 / ALT.	1 / ALT.
<b>FAN</b>	Air flow outdoor unit	m <sup>3</sup> /h.	3.100	3.100	5.400	5.600
<b>REFRIGERANT</b>	Type / R-22	gr.	1775	2500	2800	3500
<b>EXPANSIÓN</b>			Capillary	Capillary	Capillary	Restrictor
<b>WEIGHT</b>		Kg	81	83	99	129
<b>DIMENSIONS</b>		mm.				
	Height		781	781	1035	1330
	Width		973	973	973	1005
	Depth		333	333	333	386
<b>PACKING DIMENSIONS</b>		mm.	845 x 1060 x 385		1085 x 1275 x 385	1495 x 1057 x 430
<b>REFRIGERANT COUPLING</b>						
	Líquid pipe		3/8"	3/8"	3/8"	1/2"
	Gas pipe		5/8"	3/4"	3/4"	3/4"

INDOOR UNIT			LTX 3	LTX 3	LTX 5	LTX 5
<b>FAN</b>	Air flow indoor unit	m <sup>3</sup> /h.				
		Max.	1.300	1.300	2.100	2.100
		Min.	1.100	1.100	1.800	1.800
<b>WEIGHT</b>		Kg	40	40	57	57
<b>DIMENSIONS</b>		mm.				
	Height		267	267	312	312
	Width		1.409	1.409	1.719	1.719
	Depth		656	656	756	756
<b>PACKING DIMENSIONS</b>		mm.	310 x 1430 x 680		352 x 1749 x 776	
<b>REFRIGERANT COUPLING</b>						
	Líquid pipe		3/8"	3/8"	1/2" (2)	1/2"
	Gas pipe		3/4" (2)	3/4"	3/4"	3/4"

(\*) Air entry temperature into the indoor unit 27°C DB/19 °C WB

(\*) Air entry temperature into the outdoor unit 35°C DB

(\*\*) Air entry temperature into the indoor unit 20°C DB/12 °C WB

(\*\*) Air entry temperature into the outdoor unit 7°C DB/6°CWB

(1) Charge of refrigerant, factory charged on outdoor unit. See page 22, to calculate model refrigerant charge

(2) Use the coupling fittings included in indoor unit for refrigerant connection with outdoor unit..

DB.- Dry Bulb  
WB.- Wet Bulb

## SPECIFICATIONS HEAT PUMP

R-22

### OUTDOOR UNIT WITH CENTRIFUGAL FAN

MODEL			WING 2,8CB	WING 3CB	WING 4CB	WING 5CB
Cooling capacity	(*)	W	7.180	9.100	12.100	14.000
Heating capacity	(**)	W	8.150	10.220	13.500	17.400

OUTDOOR UNIT			KCB 2,8S	KCB 3S	KCB 4S	KCB 5S
<b>COMPRESSOR</b>	N <sup>a</sup> / Type		1 / ALT.	1 / ALT.	1 / ALT.	1 / ALT.
<b>FAN</b>						
Air flow outdoor unit	m <sup>3</sup> /h.		2.500	2.500	3.400	5.000
Available pressure	Pa		40	40	50	50
<b>REFRIGERANT</b>	Type / R-22	gr. (1)	2425	2525	3400	5300
<b>EXPANSIÓN</b>			Capillary	Capillary	Capillary	Capillary
<b>WEIGHT</b>		Kg	92	94	135	150
<b>DIMENSIONS</b>						
Height		mm.	505	505	525	575
Width		mm.	1050	1050	1300	1300
Depth		mm.	750	750	855	855
<b>PACKING DIMENSIONS</b>		mm.	630 x 1140 x 850		775 x 1330 x 865	
<b>REFRIGERANT COUPLING</b>						
Líquid pipe			3/8"	3/8"	3/8"	1/2"
Gas pipe			5/8"	3/4"	3/4"	3/4"

INDOOR UNIT			LTX 3	LTX 3	LTX 5	LTX 5
<b>FAN</b>						
Air flow indoor unit	m <sup>3</sup> /h.	Max.	1.300	1.300	2.100	2.100
		Min.	1.100	1.100	1.800	1.800
<b>WEIGHT</b>		Kg	40	40	57	57
<b>DIMENSIONS</b>						
Height		mm.	267	267	312	312
Width		mm.	1.409	1.409	1.719	1.719
Depth		mm.	656	656	756	756
<b>PACKING DIMENSIONS</b>		mm.	310 x 1430 x 680		352 x 1749 x 776	
<b>REFRIGERANT COUPLING</b>						
Líquid pipe			3/8"	3/8"	1/2" (2)	1/2"
Gas pipe			3/4" (2)	3/4"	3/4"	3/4"

(\*) Air entry temperature into the indoor unit 27°C DB/19 °C WB

(\*) Air entry temperature into the outdoor unit 35°C DB

(\*\*) Air entry temperature into the indoor unit 20°C DB/12 °C WB

(\*\*) Air entry temperature into the outdoor unit 7°C DB/6°CWB

(1) Charge of refrigerant, factory charged on outdoor unit. See page 22, to calculate model refrigerant charge

(2) Use the coupling fittings included in indoor unit for refrigerant connection with outdoor unit..

DB.- Dry Bulb  
WB.- Wet Bulb

## SPECIFICATIONS

SET WITH AXIAL FAN OUTDOOR UNIT

SOUND LEVEL			WING 2,8TFK WING 2TB	WING 3TFK	WING 3TB	WING 4TFK WING 4TB	WING 5TFK WING 5TB
Sound pressure level (Lp)	Indoor unit (1)	dBA	41/46 (*)	41/46 (*)	41/46 (*)	43/48 (*)	43/48 (*)
	Outdoor unit (2)	dBA	52	55	53	56	56

(1) Sound level measured to a distance of 2m from the unit, normal absorption, room size according to unit capacity.

(2) Sound level measured to a distance of 5 m, free space.

(\*) High speed / Low speed

## ELECTRICAL DATA

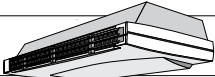
		WING 2,8TFK WING 2TB	WING 3TFK	WING 3TB	WING 4TFK WING 4TB	WING 5TFK	WING 5TB
Voltage	V/f (50 Hz)	230V / 1 Ph		230V-400V / 3 Ph			
Nominal total input power cooling capacity	Kw	3,06	3,85	3,70	4,70	5,60	5,90
Nominal total input power heat pump	Kw	2,60	----	3,00	3,90	---	5,00
Rated current		14,87	19,3	18,3			
	A	13,4/8,0		12,8/7,7	18,3/9,1	20,4/10,2	21,5/11,3
Current max.		17,9	24,4	23,4			
	A	17,3/10,7		16,5/10,2	21,3/12,1	23,1/11,9	24,4/13,2
Starting current max.		91	90	90			
	A	78 / 39		78 / 39	106 / 53	124 / 62	124 / 62
OUTDOOR UNIT		KJF 2,8K KJB 2,8	KJF 3K	KJB 3	KJF 4K KJB 4	KJF 5K	KJB 5
Voltage	V/f (50 Hz)	230V / 1 Ph		230V-400V / 3 Ph			
Nominal total input power cooling capacity	Kw	2,88	3,67	3,52	4,45	5,35	5,65
Nominal total input power heat pump	Kw	2,42	---	2,82	3,65	----	4,75
Rated current		14,05	18,48	17,48			
	A	13,2/7,1		12,0/6,9	17,2/8,0	19,2/9,0	20,4/10,2
Current max.		17,12	23,58	22,60			
	A	16,4/9,8		15,7/9,4	20,2/11,0	22,1/10,9	23,3/12,1
Starting current max.		91	90	90			
	A	78 / 39		78 / 39	106 / 53	124 / 62	124 / 62
INDOOR UNIT		LTX 3	LTX 3	LTX 3	LTX 5	LTX 5	LTX 5
Voltage	V/f (50 Hz)	230V / 1 Ph					
Nominal total input power cooling capacity	Kw	0,18	0,18	0,18	0,25	0,25	0,25
Nominal total input power heat pump	Kw	0,18	---	0,18	0,25	---	0,25
Rated current		0,82	0,82	0,82	1,14	1,14	1,14
	A	0,82		0,82	1,14	1,14	1,14
Starting current max.	A	2,46	2,46	2,46	3,42	3,42	3,42

## SPECIFICATIONS

### SET WITH CENTRIFUGAL FAN OUTDOOR UNIT

SOUND LEVEL			WING 2,8CFK WING 2CB	WING 3CFK WING 3CB	WING 4CFK WING 4CB	WING 5CFK WING 5CB
Sound pressure (Lp) level	Indoor unit (1)	dBA	41/46 (*)	41/46 (*)	43/48 (*)	43/48 (*)
	Outdoor unit (2)	dBA	57	58	60	62

(1) Sound level measured to a distance of 2m from the unit, normal absorption, duct size and installation according to unit capacity.

(2) Sound level measured to a distance of 5 m, normal absorption, duct size and installation according to unit capacity.

(\*) High speed / Low speed

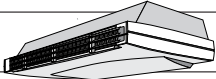
ELECTRICAL DATA			WING 2,8CFK WING 2CB	WING 3CFK WING 3CB	WING 4CFK WING 4CB	WING 5CFK WING 5CB
Voltage	V/f (50 Hz)		230V / 1 Ph		230V-400V / 3 Ph	
Nominal total input power cooling capacity	Kw		3,07	3,86	5,17	7,00
Nominal total input power heat pump	Kw		2,77	3,40	4,33	6,40
Rated current	A		14,92	18,3		
				11,7/5,4	16,6/10,0	22,3/13,3
Current max.	A		19,82	23,4		
				16,5/10,2	21,9/12,7	24,5/16,7
Starting current max.	A		91	90		
				78 / 39	106 / 53	124 / 62
OUTDOOR UNIT			KCF 2,8K KCB 2,8S	KCF 3K KCB 3S	KCF 4K KCB 4S	KCF 5K KCB 5S
Voltage	V/f (50 Hz)		230V / 1 Ph		230V-400V / 3 Ph	
Nominal total input power cooling capacity	Kw		2,89	3,68	4,92	6,75
Nominal total input power heat pump	Kw		2,59	3,22	4,08	6,15
Rated current	A		14,10	17,77		
				10,8/4,5	15,5/8,9	21,2/12,2
Current max.	A		19,00	22,65		
				15,7/9,4	20,8/11,60	23,4/15,56
Starting current max.	A		91	90		
				78 / 39	106 / 53	124 / 62
INDOOR UNIT			LTX 3	LTX 3	LTX 5	LTX 5
Voltage	V/f (50 Hz)		230V / 1 Ph			
Nominal total input power cooling capacity	Kw		0,18	0,18	0,25	0,25
Nominal total input power heat pump	Kw		0,18	0,18	0,25	0,25
Rated current	A		0,82	0,82	1,14	1,14
Starting current max.	A		2,46	2,46	3,42	3,42

## ELECTRICAL CONNECTIONS

### MODELS 2,8-3-4-5

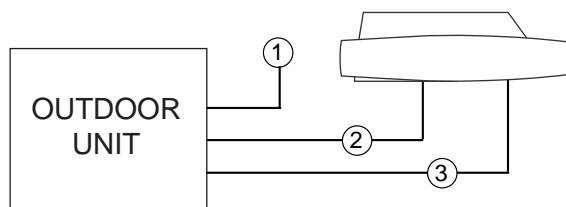

### ELECTRIC WIRING DIAGRAM

For electrical connection refer to wiring diagram in the unit

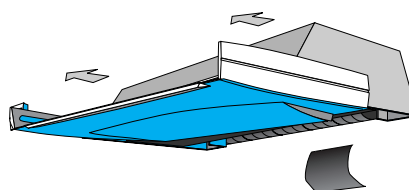

- ① Power supply
- ② Connection indoor unit with outdoor unit
- ③ Sensor connection

- 1° Remove the front details at the corners and unit cover panel.
- 2° Remove the filters  
See picture

MODEL	VOLTAGE	NUMBER OF WIRES X SECTION				
		COOLING ONLY		HEAT PUMP		
		①	②	①	②	③
2.8	230 V / 1Ph	3x4mm <sup>2</sup>	4x1,5mm <sup>2</sup>	3x4mm <sup>2</sup>	6x1,5mm <sup>2</sup>	2x1,5mm <sup>2</sup>
	400 V / 3Ph	5x2,5mm <sup>2</sup>	4x1,5mm <sup>2</sup>	5x2,5mm <sup>2</sup>	6x1,5mm <sup>2</sup>	2x1,5mm <sup>2</sup>
3	230 V / 1Ph	3x4mm <sup>2</sup>	4x1,5mm <sup>2</sup>	3x4mm <sup>2</sup>	6x1,5mm <sup>2</sup>	2x1,5mm <sup>2</sup>
	230 V / 3Ph	4x4mm <sup>2</sup>	4x1,5mm <sup>2</sup>	4x4mm <sup>2</sup>	6x1,5mm <sup>2</sup>	2x1,5mm <sup>2</sup>
	400 V / 3Ph	5x2,5mm <sup>2</sup>	4x1,5mm <sup>2</sup>	5x2,5mm <sup>2</sup>	6x1,5mm <sup>2</sup>	2x1,5mm <sup>2</sup>
4	230 V / 3Ph	4x4mm <sup>2</sup>	4x1,5mm <sup>2</sup>	4x4mm <sup>2</sup>	6x1,5mm <sup>2</sup>	2x1,5mm <sup>2</sup>
	400 V / 3Ph	5x2,5mm <sup>2</sup>	4x1,5mm <sup>2</sup>	5x2,5mm <sup>2</sup>	6x1,5mm <sup>2</sup>	2x1,5mm <sup>2</sup>
5	230 V / 3Ph	4x6mm <sup>2</sup>	4x1,5mm <sup>2</sup>	4x6mm <sup>2</sup>	6x1,5mm <sup>2</sup>	2x1,5mm <sup>2</sup>
	400 V / 3Ph	5x4mm <sup>2</sup>	4x1,5mm <sup>2</sup>	5x4mm <sup>2</sup>	6x1,5mm <sup>2</sup>	2x1,5mm <sup>2</sup>

**NOTE:** The sections has been calculated to a distance no superior o 50m and a low supply of 10V

**IMPORTANT**

**Prior of making the electrical connections, set the switch for heat pump unit or for cooling only unit.**

This unit is valid for operating as a cold only or heat pump application. The unit should be configured prior to making the electrical connections, by setting the configuration switch as follows:

1

Remove the front details at the corners and unit cover panel.

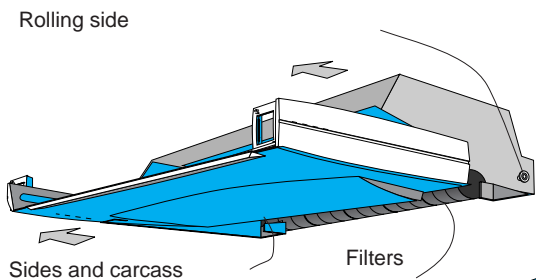

2

Remove the filters

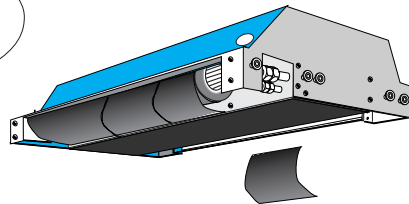

3

DETALLE A

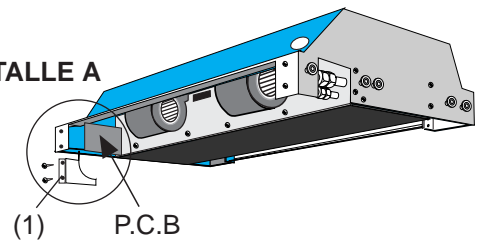

(1) P.C.B

PCB

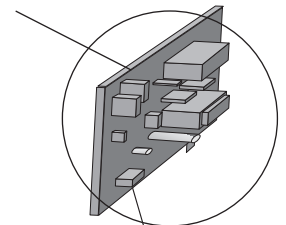

SWICHT CONFIGURATION

**NOTE: THE UNIT LEAVES FACTORY CONFIGURED ON COOLING MODE**

MODEL	SWICHT CONFIGURATION	
	1	2
COOLING ONLY (*)	OFF	ON
HEAT PUMP	ON	ON

(\*) Configuration from factory.

SWICHT CONFIGURATION

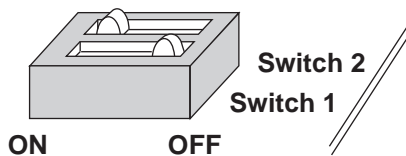

**NOTE:**

If errors are made during the configuration of the system, switch off the main power supply, set configuration switch in the correct position and then switch the power on.

**CONNECTIONS OF OUTDOOR UNITS**

**-FOR HEAT PUMP UNITS**, remove the resistor form the terminal plate and connect the sensor outdoor unit

**-FOR COOLING ONLY UNITS**, keep connected the resistor.

**DON'T TOUCH.**

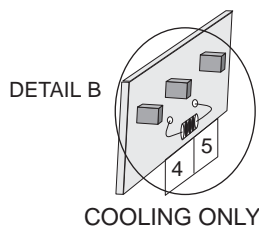

COOLING ONLY

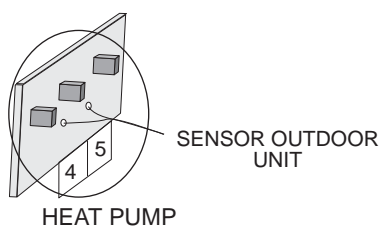

HEAT PUMP

SENSOR OUTDOOR UNIT

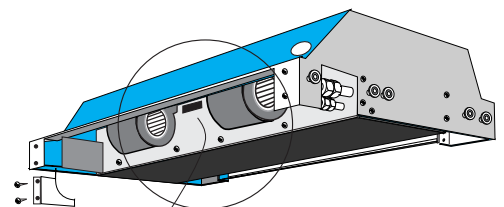

DETALLE B

Regleta de terminales, y conexión de la sonda exterior

# ELECTRICAL CONNECTIONS

## COOLING ONLY

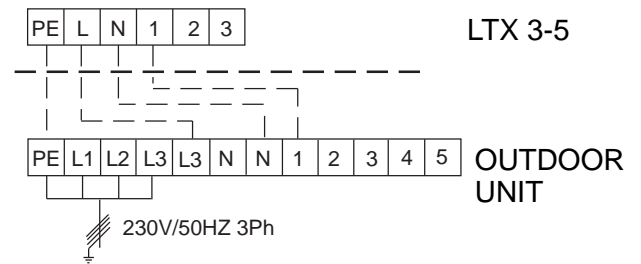
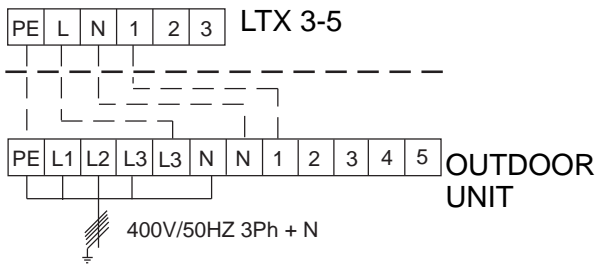
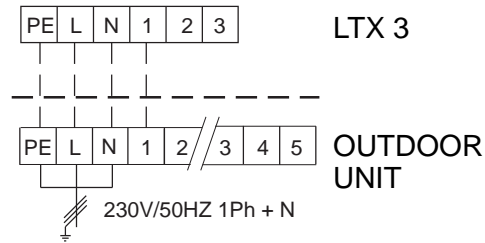

## HEAT PUMP

Wire overwhelm

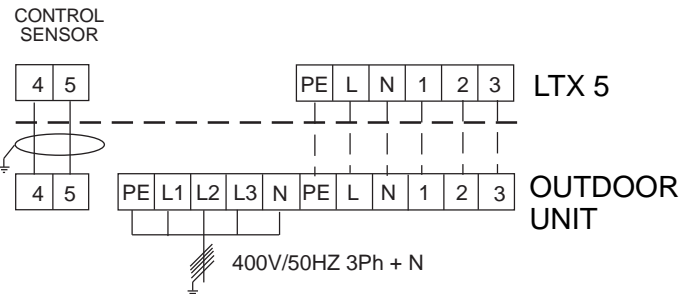
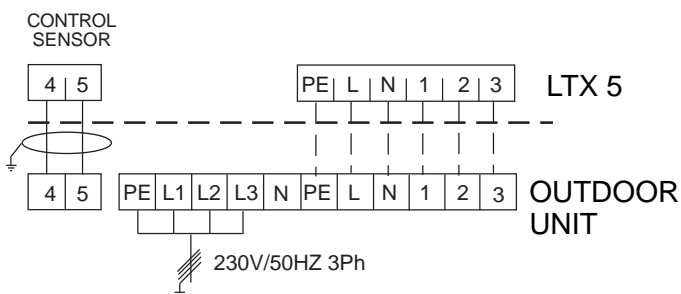
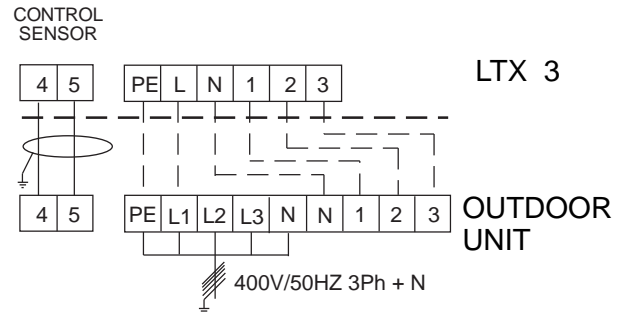
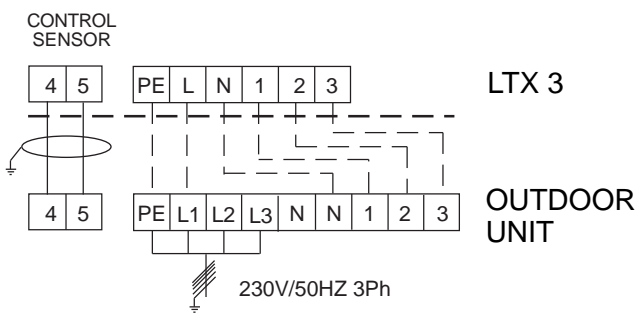
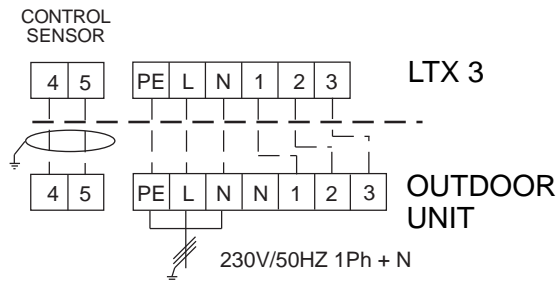



## OUTDOOR UNIT MOTOR-FAN CHARACTERISTICS

OUTDOOR UNIT WITH CENTRIFUGAL FAN



KCF2,8K / KCB 2,8S

KCF 3K / KCB 3S

		STATIC PRESSUERE AVIALABLE <b>Pa.</b>				STATIC PRESSUERE AVIALABLE <b>Pa.</b>			
		110	75	40	0	100	70	54	0
AIR FLOW	<b>m<sup>3</sup>/h</b>	1500	1700	2500	2900	1500	1650	2500	2900

KCF 4K / KCB 4S

KCF 5K / KCB 5S

		STATIC PRESSUERE AVIALABLE <b>Pa.</b>				STATIC PRESSUERE AVIALABLE <b>Pa.</b>			
		110	80	50	0	150	110	50	0
AIR FLOW	<b>m<sup>3</sup>/h</b>	2800	3100	3400	3800	4250	4650	5050	5400

 AIR FLOW

## OPERATING LIMITS

### OPERATING LIMITS COOLING ONLY UNITS

- \* Supply air temperature into the outdoor unit °C
- \*\* Supply air temperature into the indoor unit °C

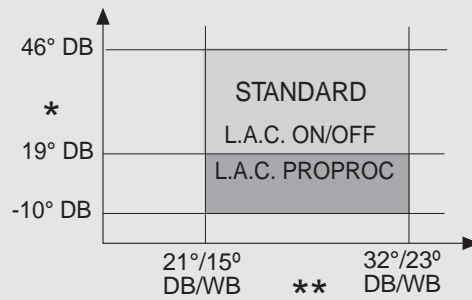

DB.- Dry Bulb  
WB.- Wet Bulb

THE ON/OFF LOW AMBIENT CONTROL IS STANDARD  
THE PROPORTIONAL LOW AMBIENT CONTROL IS OPTIONAL

### OPERATING LIMITS HEAT PUMP UNITS

- \* Supply air temperature into the outdoor unit °C
- \*\* Supply air temperature into the indoor unit °C

DB.- Dry Bulb  
WB.- Wet Bulb

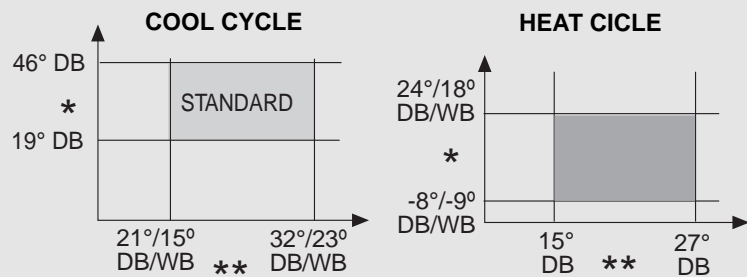

## REFRIGERANT CONNECTIONS

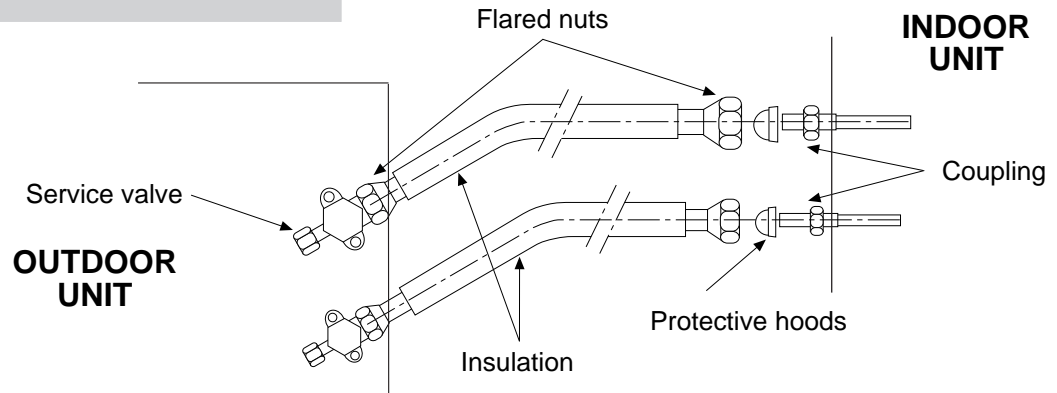

### REFRIGERANT CONNECTION FOR UNITS WITH COUPLINGS AND SERVICE VALVES

**NOTE: THE REFRIGERANT LINES GAS AND LIQUID, MUST BE INSULATED**

**Make the refrigerant connections between the outdoor and indoor unit, as follows:**

- With the valves closed on outdoor unit, unscrew the flare nuts, removing all the protective hoods.
- Unscrew the flare nuts and the coupling on indoor unit, removing the protecting hoods.
- Introduce the flare nuts in the corresponding union tubes, previously isolated.
- Make the thread union of the tubes in valves and coupling using the keys, as shown in the picture.
- To do vacuum, first close the valves on outdoor unit, second connect the plug of the vacuum pump to the suction valves service port 1/4", do vacuum to get an absolute pressure of 0.5 mm Hg. This way the vacuum will be created in indoor unit and union pipes.
- Remove the plugs and open the valves of outdoor unit.
- Verify leakage in couplings.
- Insulate pipes and service ports.

#### CUT THE PIPE PROPERLY

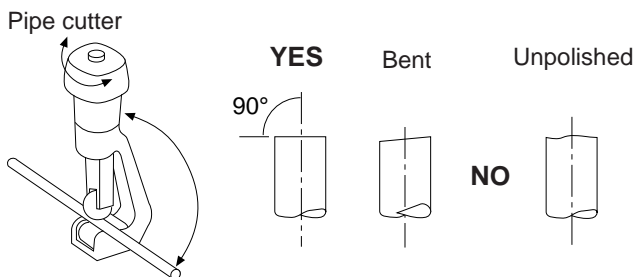

#### MAKE A CORRECT FLARE

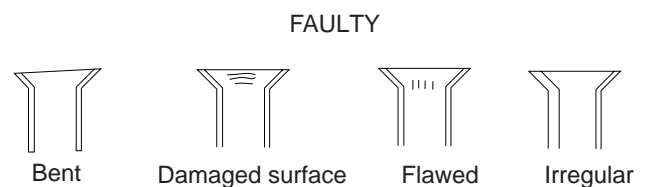

AVOID FROM METALIC DUST ENTERING INTO THE PIPE

CLEAN THE BURRS

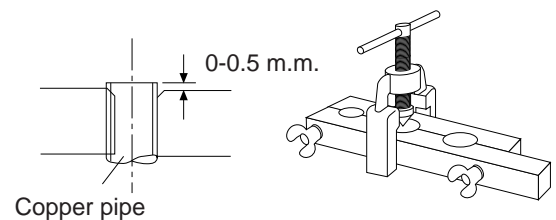
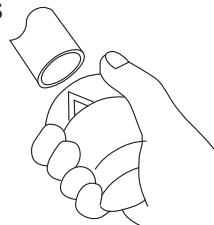

**TIGHTENING TORQUE**  
Apply the tightening torque shown in the table.  
Insufficient tightening torque could cause refrigerant leak,  
excessive tightening torque will damage pipe flare.

PIPE DIAMETER	TIGHTENING TORQUE
3/8"	31-35 Nm
1/2"	50-55 Nm
3/4"	65-70 Nm

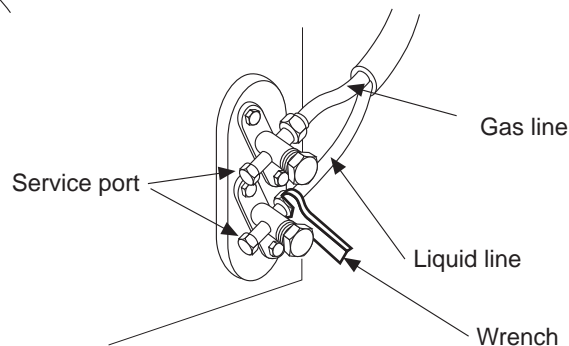

## REFRIGERANT CONNECTIONS

### DISTANCES BETWEEN UNITS

To locate the outdoor and the indoor units, refer to the following information.

L : Distance length between both units.  
 1 = Refrigerant vapour line.  
 2 = Liquid aspiration line.

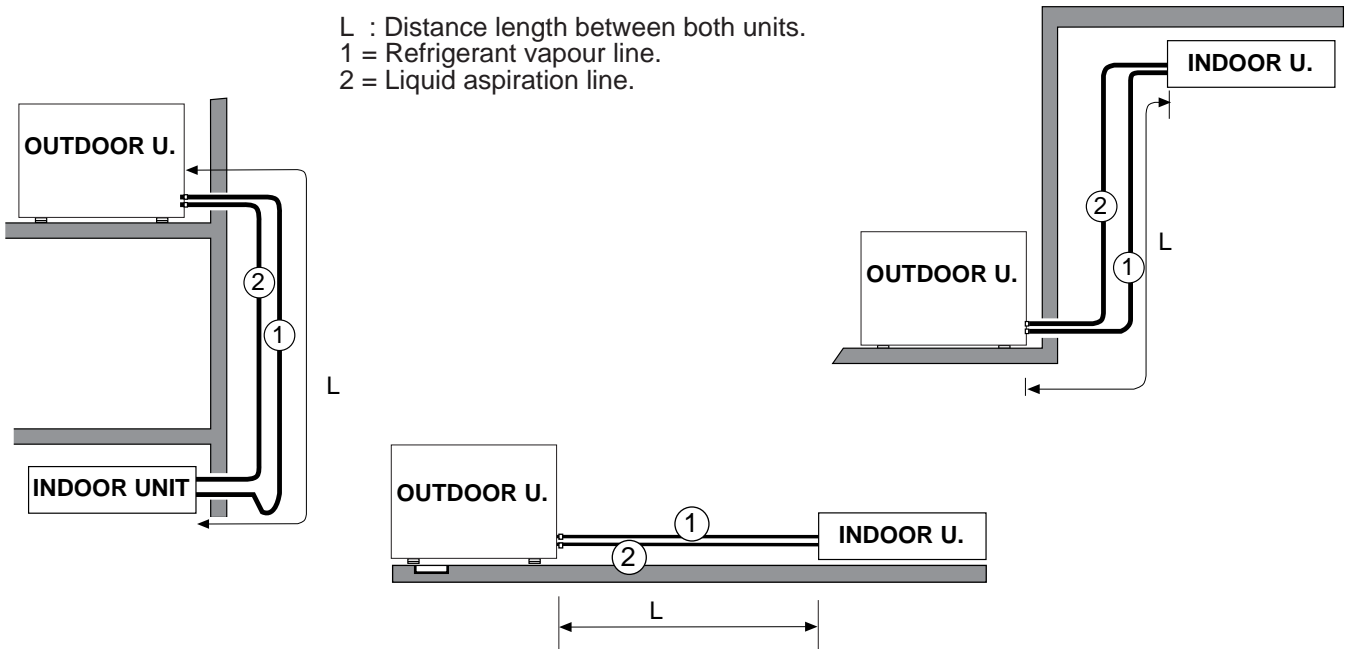

MODEL		2,8	3	4	5
Tube size	Liquid	3/8"	3/8"	3/8"(1)	1/2"
	Vapour	5/8"(1)	3/4"	3/4"	3/4"
Refrigerant lines sizes	Máx.Vertical	15	15	15	15
Refrigerant lines sizes L	Total vertical + Horizontal	20	25	20	20
Max. number of bends		8	12	8	8

If the height length is greater than 5 meters, a siphon suction must be installed on the suction line every 5 meters to ensure that oil return to the compressor.

(1) Use the coupling fittings included in indoor unit for refrigerant connection with outdoor unit..

**NOTE: THE REFRIGERANT LINES GAS AND LIQUID, MUST BE INSULATED**

For other positions and longer lengths, consult the Lennox Technical Support Department for application assistance.

The following data will be obtained from that estimation:  
 Pipe dimensions, Siphon suction, Insulation, Refrigerant charge

## REFRIGERANT CONNECTIONS

### REFRIGERANT CHARGE

OUTDOOR UNITS TYPE KJF-K/ KJB



MODEL		2,8	3	4	5
COOLING ONLY	(gr.) (*)	1.650	2.500	2.600	2.600
	(gr.) (**)	5	5	5	5
	(gr.) (***)	30	30	30	55
HEAT PUMP	(gr.) (*)	1.775	2.500	2.800	3.500
	(gr.) (**)	5	5	5	5
	(gr.) (***)	45	45	45	105

OUTDOOR UNITS TIPO KCF-K/ KCB



MODEL		2,8	3	4	5
COOLING ONLY	(gr.) (*)	2.255	2.350	3.070	4.950
	(gr.) (**)	5	0	5	5
	(gr.) (***)	30	30	30	55
HEAT PUMP	(gr.) (*)	2.425	2.525	3.400	5.300
	(gr.) (**)	5	0/5	5	5/0
	(gr.) (***)	45	45	45	105

(\*) Refrigerant charge R-22 precharge from factory on the outdoor unit.

(\*\*) Meter of installation line where outdoor unit is precharged+charge also to the group

(\*\*\*) If line is different to meters indicated on table put more or less charge of refrigerant per meter indicated.

#### EXAMPLE:

If you need to install a group WING 5CFK, with distance of line between indoor and outdoor unit of 6 meter. The refrigerant charge R-407C needed in the installation is:

$$\begin{aligned}
 \text{Charge precharge on outdoor unit} &= 5300 \\
 \text{Charge per line } 55\text{gr/m} \times (6-5)\text{m} &= 55 \\
 \text{Total charge of the installation} &= \underline{5355} \text{ gr}
 \end{aligned}$$

DIMENSIONS OF OUTDOOR UNIT WITH CENTRIFUGAL FAN (mm.)

MAXIMUM DIMENSIONS

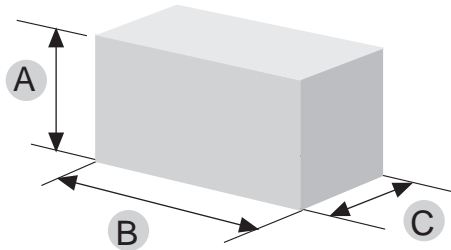

MODELS  
KCF-K / KCB-S 2,8-3

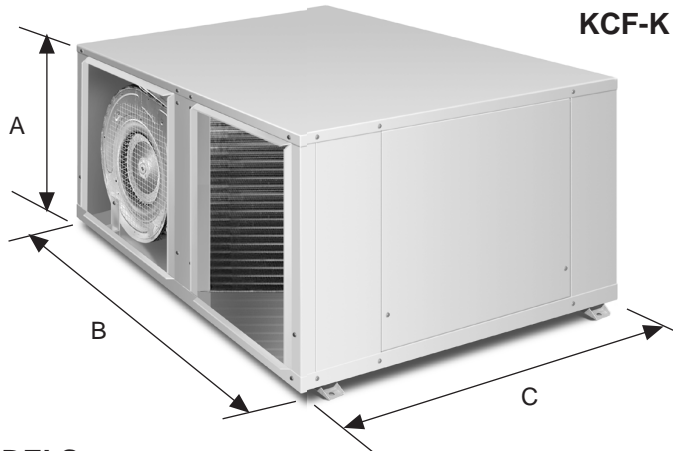

MODELS  
KCF-K / KCB-S- 4-5

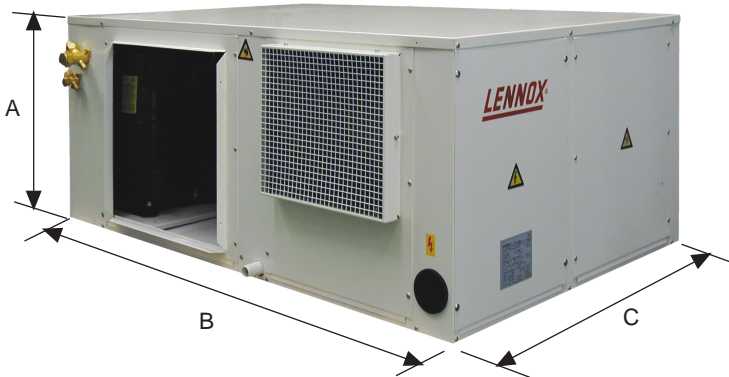

KCF-K KCB-S	2,8-3	4	5
<b>A</b>	490	525	575
<b>B</b>	1050	1300	1300
<b>C</b>	750	830	830
<b>A</b>	505	525	575
<b>B</b>	1100	1300	1300
<b>C</b>	841	890	890

SETTING UP  
TEMPLATE (mm)  
UNITS 2-2,5-2,8-3

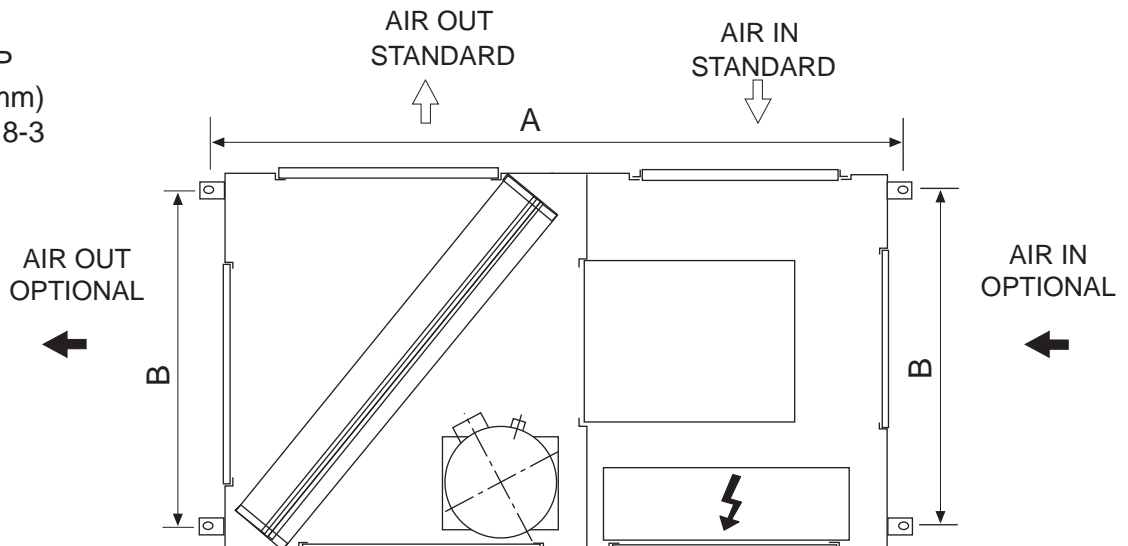

Use 4 rod of a diameter of 10mm if the unit is fixed in the roof, or screw M.10 if the unit is fixed on the ground.

Dimensions recommended on point A and B are referred to the hole of support of the unit.

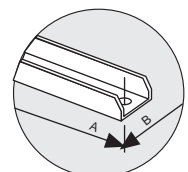

	A	B
KCF / KCB-S- 2,8 - 3	1064	660

## DESCRIPTION OUTDOOR UNIT KCF-K / KCB 2,8-3

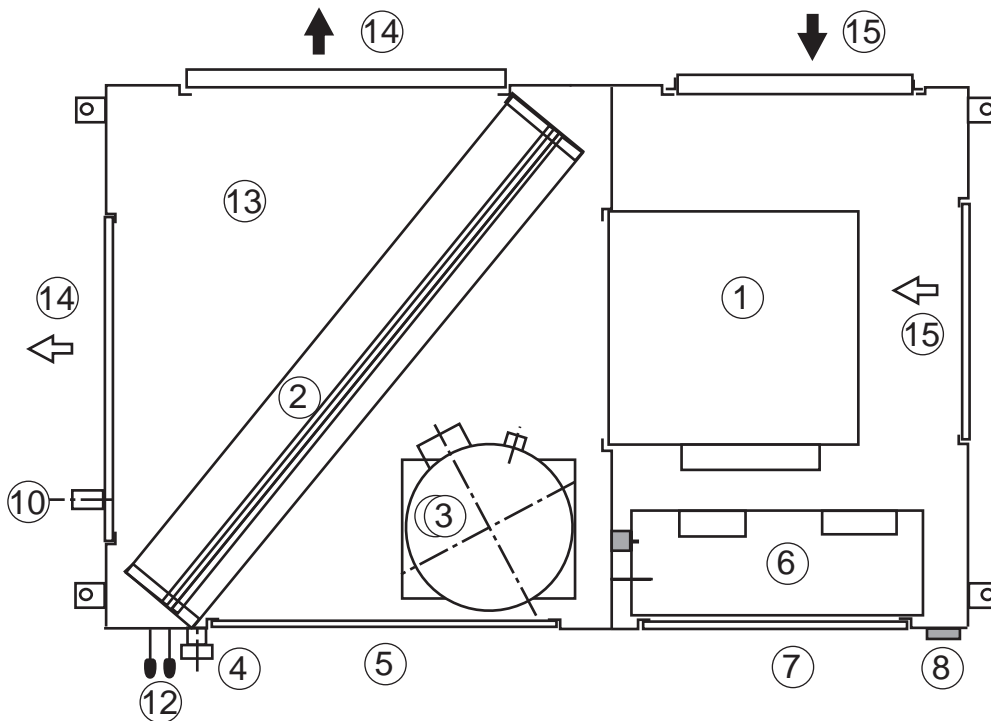

- |   |                               |
|---|-------------------------------|
| ① FAN   | ⑩ DRAINAGE ( Ø 16 EXTERNAL)   |
| ② EXCHANGER                                       | ⑪ REARM ON ON HIGH PRESSOSTAT |
| ③ COMPRESSOR                                      | ⑫ INTAKE PRESSURE (MOD.2,8-3) |
| ④ CONNETION PIPE                                  | ⑬ CONDENSATE PUMP             |
| ⑤ ACCESS PANEL TO COMPRESSOR AND PIPES COMPONENTS | ⑭ AIR OUT                     |
| ⑥ ELECTRICAL BOX                                  | ➡ POSICIÓN STANDARD           |
| ⑦ ACCESS PANEL TO ELECTRICAL BOX                  | ⇨ POSICIÓN OPCIONAL           |
| ⑧ MAIN SWITCH (OPTIONAL)                          | ⑮ AIR IN                      |
| ⑨ ELECTRICAL SUPPLY ENTRY ELECTRICAL SUPPLY       | ➡ POSITION STANDARD           |
|   | ⇨ POSTION OPTIONAL            |

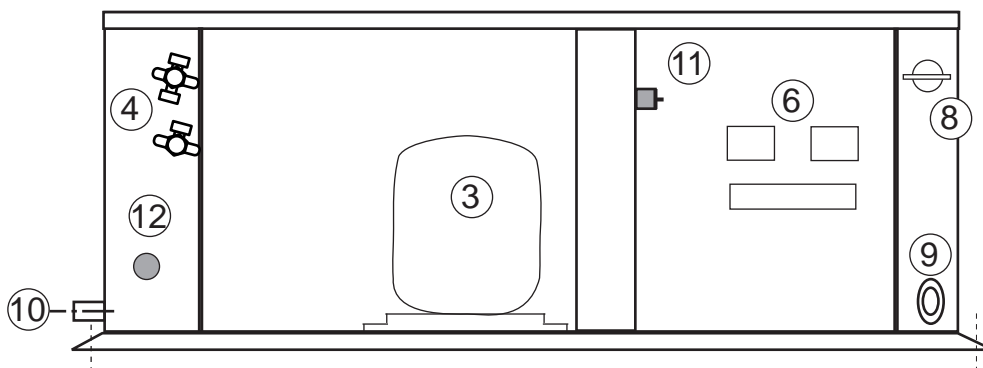

### ACCESS TO ELECTRICAL BOX

In the electrical box is included the mechanism of high pressostat rearm.

DESCRIPTION OUTDOOR UNIT KCF / KCB-S 4 - 5

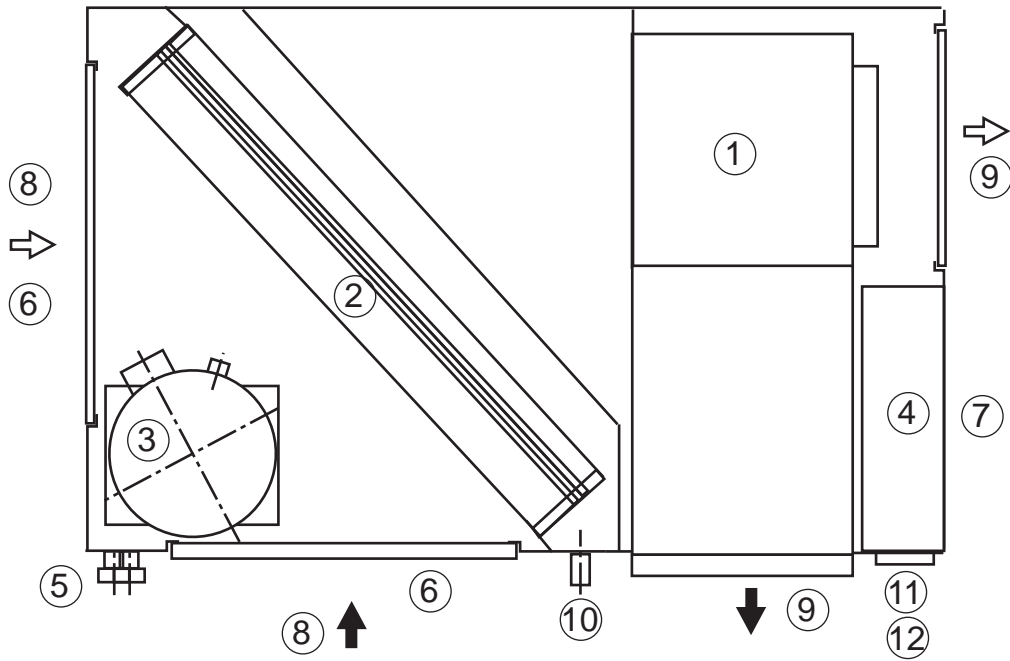

- ① FAN
- ② EXCHANGER
- ③ COMPRESSOR
- ④ ELECTRICAL BOX
- ⑤ CONNETION PIPE
- ⑥ ACCESS PANEL TO COMPRESSOR AND PIPES COMPONENTS
- ⑦ ACCESS PANEL TO ELECTRICAL BOX
- ⑧ AIR OUT
  - ➔ POSICIÓN STANDARD
  - ➞ POSICIÓN OPCIONAL
- ⑨ AIR IN
  - ➔ POSITION STANDARD
  - ➞ POSTION OPTIONAL
- ⑩ DRAINGE ( Ø 16 EXTERNAL)
- ⑪ ELECTRICAL SUPPLY ENTRY ELECTRICAL SUPPLY
- ⑫ MAIN SWITCH (OPTIONAL)

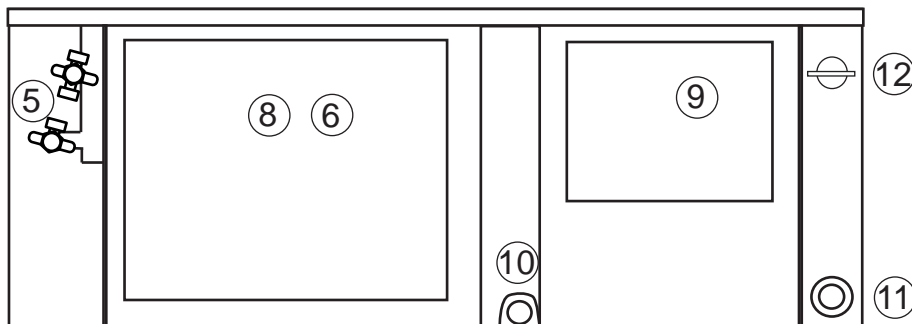



# ENTRANCE STANDARD/ OPTIONAL OUTDOOR UNIT KCF-K / KCB

## ENTRANCE STANDARD

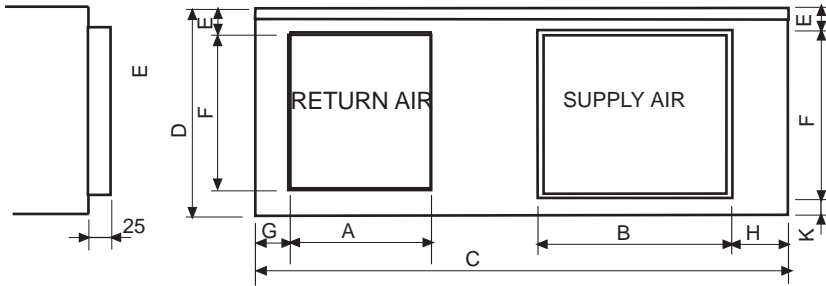

RETURN AIR OPTIONAL **MODELS 2,8-3**

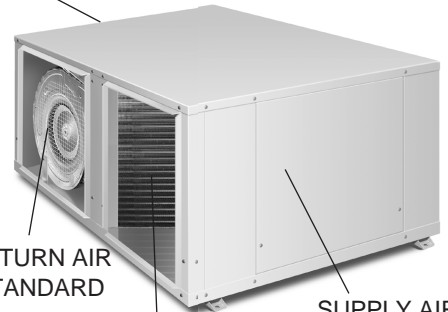

## ENTRANCE OPTIONAL (TO BE REALISE BY THE INSTALLATOR)

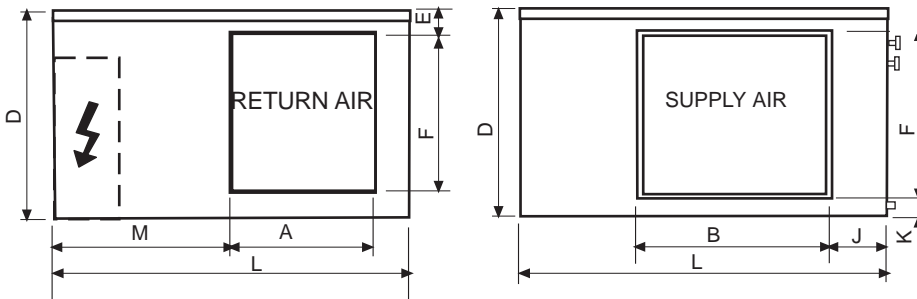

RETURN AIR STANDARD

SUPPLY AIR STANDARD

SUPPLY AIR OPTIONAL

## ENTRANCE STANDARD

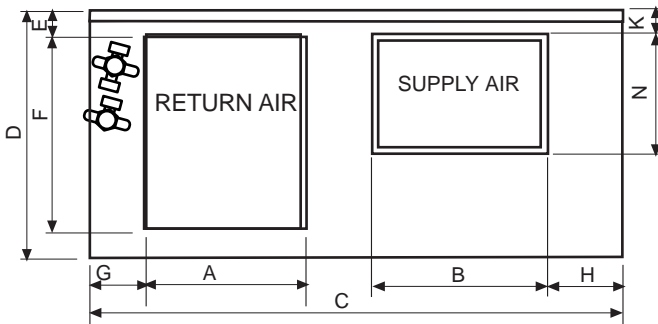

RETURN AIR OPTIONAL

**MODELS 4-5**



## ENTRANCE OPTIONAL (TO BE REALISE BY THE INSTALLATOR)

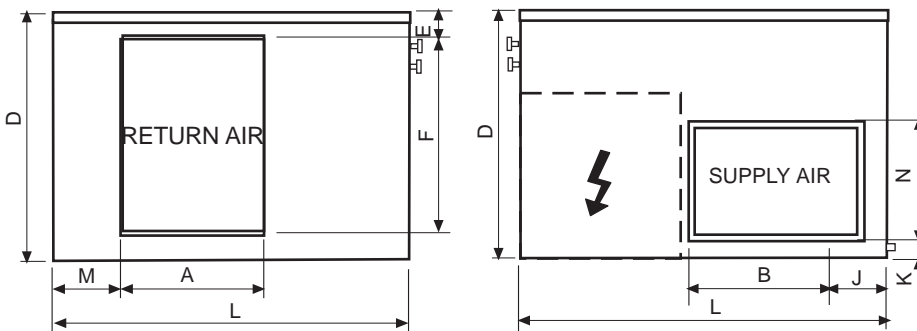

To change entrances from standard position to optional position, you must substitute the entrance panel correspondent, and refixe using the same fixation screw.

	A	B	C	D	E	F	G	H	J	K	L	M	N
<b>KCF-K / KCB 3S</b>	350	470	1050	490	36,5	400	45.5	35,5	147	53,5	750	332,5	---
<b>KCF-K / KCB 4S</b>	500	375	1300	525	36	432	195	110	65	35,3	830	50	293,4
<b>KCF-K / KCB 5S</b>	500	375	1300	575	36	432	195	110	65	35,3	830	50	293,4

## DIMENSIONS AND SETTING UP TEMPLATES OF OUTDOOR UNIT WITH AXIAL FAN

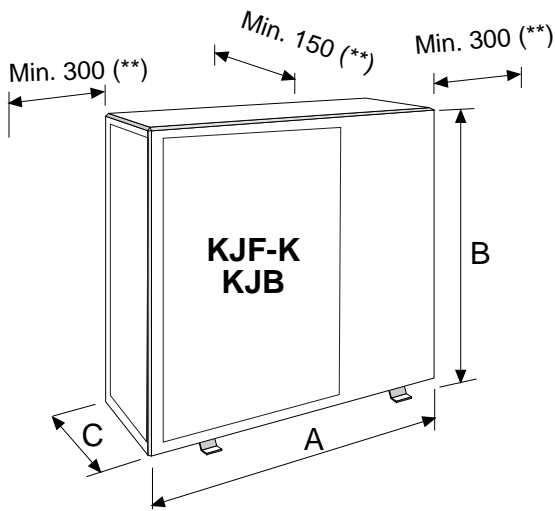

**(\*\*)** ALWAYS KEEP FREE

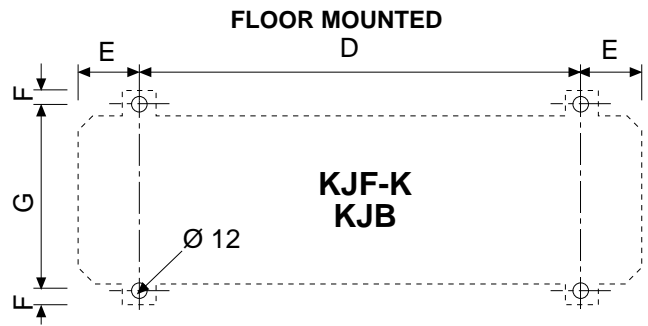

**OUTDOOR UNIT**

	KJF-2.8K	KJF-3K		KJF-4K	KJF-5K	
	KJB-2.8		KJB-3	KJB-4		KJB-5
A	973	973	973	973	973	1.005
B	781	1.035	781	1.035	1.035	1.330
C	333	333	333	333	333	386
D	620	620	620	620	620	602
E	176,4	176,4	176,4	176,4	176,4	198
F	10	10	10	10	10	10
G	343,5	343,5	343,5	343,5	343,5	410

## DIMENSIONS AND SETTING TEMPLATES OF INDOOR UNIT LTX

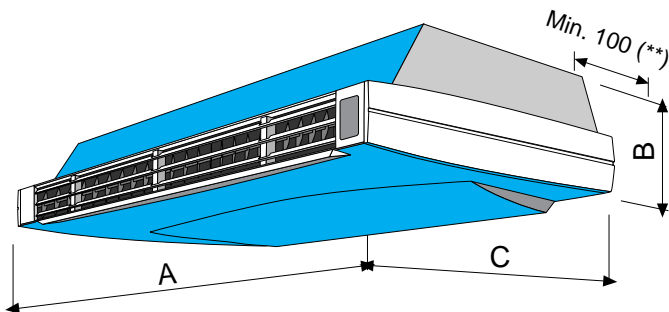

**FLOOR MOUNTED**

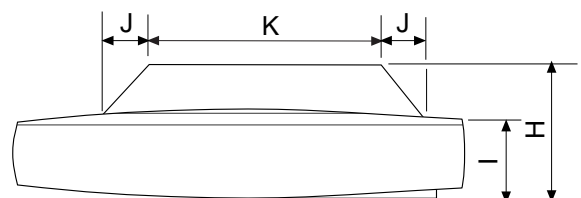

	LTX 3	LTX 5
A	1.409	1.719
B	223	268
C	656	756
D	1.104	1.330
E	1.076	807
F	14	261,5
G	359,5	383
H	267,5	312,5
I	177,5	177,5
J	52	78
K	460	508
L	653	753
M	162,5	213
N	131	157

**LTX 5**

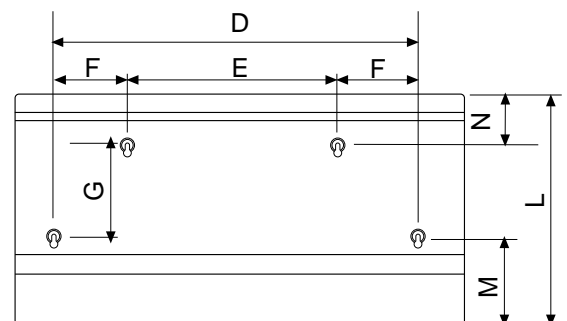

**LTX 3**

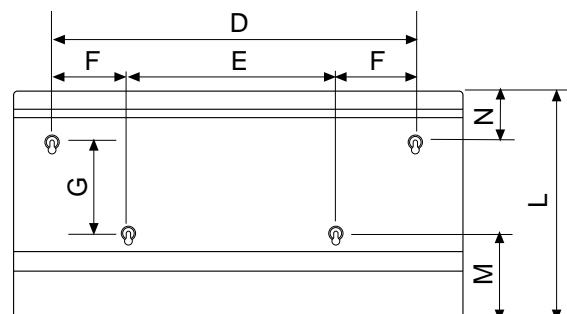

## INSTALLATION INDOOR UNIT

### INSTALLATION UNIT

Install the unit in a way that the discharge air would not be direct to persons, differences of temperature can create disturbs.

Keep in mind in the installation of the unit, some ambient can supply electromagnetic radiation that can affect the good function of the unit, follow then the following instruction recommended in this document.

**A**

To remove the casing, slide them over the rolling sides and remove horizontally (See picture A).

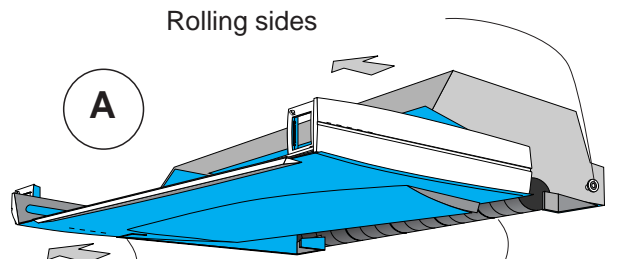

**B**

Remove the AIR VANES by moving them in the opposite direction of the air sweep motor until they come out, then release the central fixing clip, so that the AIR SWEEP is removed giving better access to the top of the unit (See picture B).

Sides and carcass

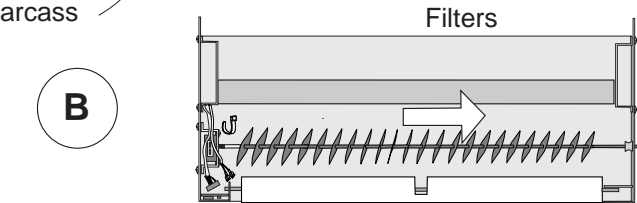

**B**

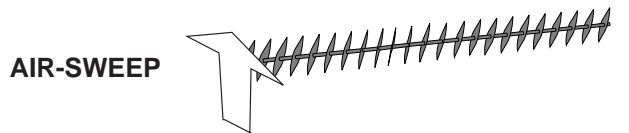

**C**

Install the unit with the M-8 screws, always use washers. Fix the screws following the pattern on page 26.

Check the strength of the screws to avoid movement of the indoor unit when removing the side and cover panel.. See picture C

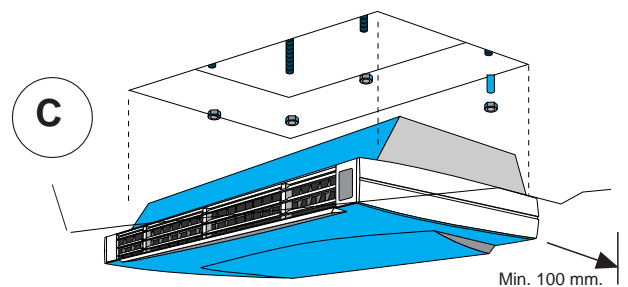

**D**

Always install the filters. If the unit operates without filters there is a risk of damage in the indoor unit from dust..

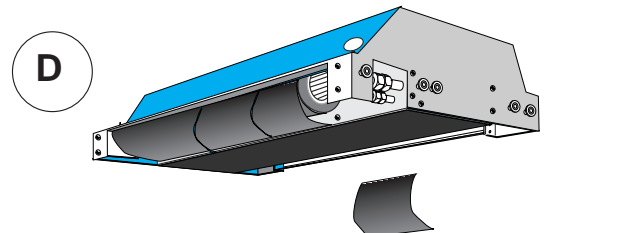

### OPENING IN FLASE CEILING

	LTX 3	LTX 5
X	1.321 mm	1.630 mm
Y	562 mm	670 mm

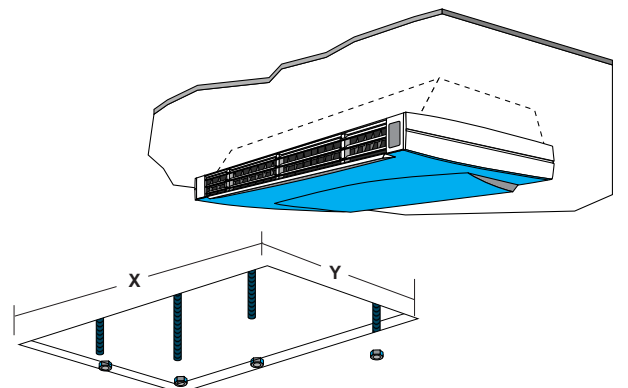

ELECTRICAL HEATER

**BEFORE ATTEMPTING TO PERFORM ANY SERVICE OR MAINTENANCE, TURN OFF THE ELECTRICAL POWER, AND CHECK THAT THE FAN HAS STOPPED**

- ① To remove the casing, slide them over the rolling sides and remove horizontally
- ② Remove the filters.
- ③ Remove drain pan.
- ④ Introduce the electrical heater kit rods in the holes of one side of the coil and fix with screws on the other.
- ⑤ Fix the contactor to the fan deck.

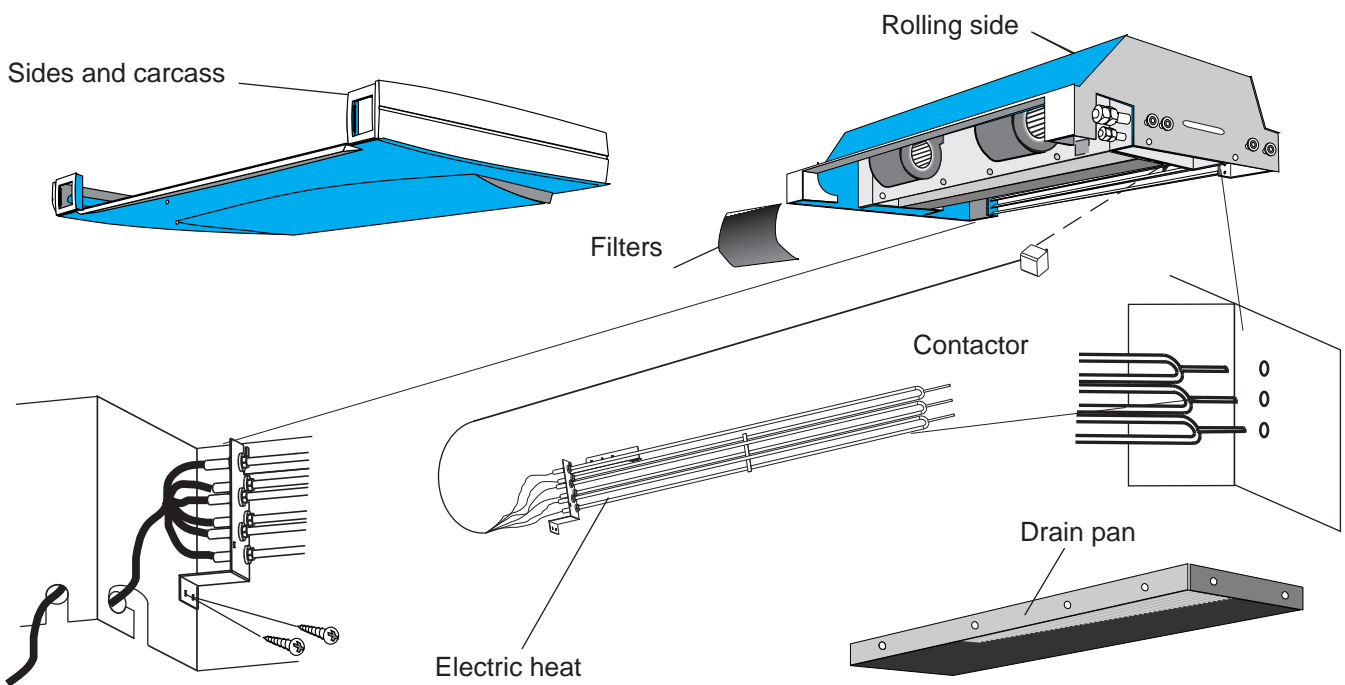

**FIG 1**

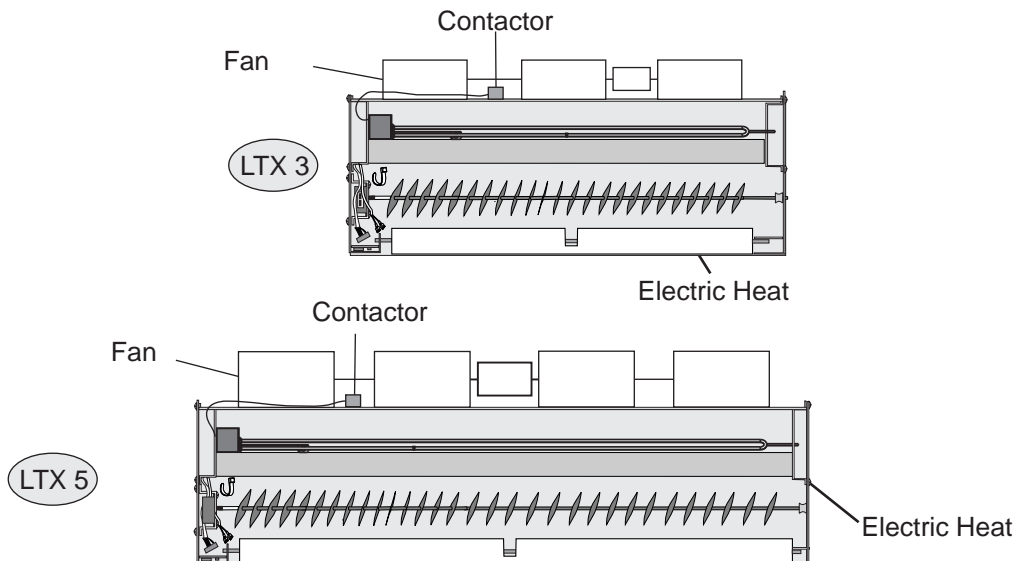

**NOTE:** The safety thermostat must always be at the top of the heater.

---

## OUTDOOR UNIT OPTIONALS

### MAIN SWITCH

The main switch is located on the access panel to the electrical box, in such a way that the unit is disconnected when the panel is opened, for the models KCF and KCB.

(Refer to the size diagram on pages 25 to 30, to see the position of the electrical box access panel)

### WINTER CONTROL

The low ambient kit should be fitted to the cooling units, when the outdoor temperature is lower than 19 °C. in cooling cycle. Keeps condensing temperature constant approximately 40°C.

### KIT GRID OF TAKES OF FOREIGN AIR

Field assembly.

This kit is comprised of an air filter and grille for outdoor air intake which should be installed on the suction side of the outdoor unit.

## MAINTENANCE OF THE UNIT

### POSSIBLE PROBLEMS

PROBLEM	SOLUTION
1.- Unit do not work.	<ul style="list-style-type: none"> <li>• Check electrical supply of the unit.</li> <li>• Check electrical connexion.</li> <li>• Check the remote controller and parameter works correctly.</li> </ul>
2.- The fan of the unit works quicker without any	<ul style="list-style-type: none"> <li>• Check that the filter of the unit is clean.</li> <li>• Check electrical connexion.</li> <li>• If the problem persist, check the function of the motor.</li> </ul>
3.- Noise on pipe system. NOTE: Some noises are normal when unit stop and	<ul style="list-style-type: none"> <li>• Check refrigerant charge is correct.</li> <li>• Was the vacuum done correctly?</li> <li>• Check internal temperature, could be quite low.</li> </ul>
4.- Excess of condensation	<ul style="list-style-type: none"> <li>• Check possible obstructions in the condensate pan, and also out of the pan.</li> <li>• Check correct level of the unit.</li> <li>• Check drainage pipe.</li> </ul>
5.- The indoor battery freeze continuously.	<ul style="list-style-type: none"> <li>• Check the air filter of the indoor unit.</li> <li>• Check the level of refrigerant.</li> <li>• Check strangulation air flow or recirculation.</li> <li>• If the freeze persist the expansion can be obstructed.</li> <li>• ¿Is the temperature below 21 ° C?</li> <li>• Check indoor temperature sensor.</li> </ul>
6.- Unit work perfectly on cooling mode, but do not produce heat on mode heat	<ul style="list-style-type: none"> <li>• Check if you have configurate correctly the function mode of the unit.</li> <li>• Check inverter valve of the outdoor unit.</li> <li>• Check the plate PCB to the solenoid inverted valve.</li> </ul>
7.-External fan stop	<ul style="list-style-type: none"> <li>• Check that terminal connexion are slack.</li> <li>• Check the motor.</li> <li>• Check the condenser situation.</li> <li>• Check that that the rele of defrost is not activited (Units heat pump).</li> </ul>
8.-Excessive pressure of condensation (Working cooling cycle)	<ul style="list-style-type: none"> <li>• Check that the external exchanger is not dirty and obstructed.</li> <li>• Check that there is no condensable gas and air in the refrigerant circuit.</li> <li>• Check that the external fan works correctly.</li> <li>• Check that the refrigerant charge is correct</li> </ul>
9.-Low pressure condensation. (Working on cooling cycle)	<ul style="list-style-type: none"> <li>• Check that the refrigerant charge is correct</li> <li>• Check possible obstruction on the expansion system of the outdoor unit, liquid</li> <li>• Check that air filter is not dirty or wrong function of indoor fan.</li> </ul>
10.-Excessive pressure on return air (Working on heat pump)	<ul style="list-style-type: none"> <li>• Check that the refrigerant charge is correct</li> <li>• Check the situation of inverter valve.</li> <li>• Check retention valve situation.</li> </ul>
11.-Low pressure on return air. (working on heat pump)	<ul style="list-style-type: none"> <li>• Check that the refrigerant charge is correct</li> <li>• Check possible obstruction on the expansion system of the outdoor unit</li> <li>• Check that the external fan works correctly.</li> <li>• Check the correct function of the defrost thermostat .</li> </ul>

## POINTS TO KEEP IN MIND



Abrasive surfaces



Low temperatures



High temperatures



Risk of injury with moving objects

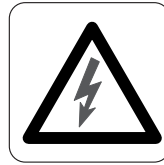

Electrical voltage



Risk of injury with rotating objects

### WARNING

Electric shock hazard can cause injury or death. Before attempting to perform any service or maintenance on the unit, turn OFF the electrical power, and check that the fan has stopped.

The air filter cleaning operations do not require technical service; however when an electrical or mechanical operation is required call an Engineer.

### FILTER CLEANING

Check the air filter and make sure it is not blocked with dust or dirt.

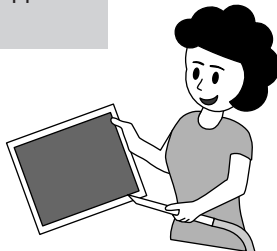
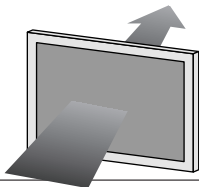

If the filter is dirty, wash it in a bowl with neutral soap and water, drying it in the shade before inserting it in the unit.

## Standard Guidelines to Lennox Refac equipment

All technical data contained in these operating instructions including the diagrams and technical description remains the property of Lennox Refac and may not be used (except for the purpose of familiarising the user with the equipment), reproduced, photocopied, transferred or transmitted to third parties without prior written authorisation from Lennox Refac.

The data published in the operating instructions is based on the latest information available. We reserve the right to make modifications without notice.

We reserve the right to modify our products without notice without obligation to modify previously supplied goods.

These operating instructions contain useful and important information for the smooth operation and maintenance of your equipment.

The instructions also include guidelines on how to avoid accidents and serious damage before commissioning the equipment and during its operation and how to ensure smooth and fault-free operation. Read the operating instructions carefully before starting the equipment, familiarise yourself with the equipment and handling of the installation and carefully follow the instructions. It is very important to be properly trained in handling the equipment. These operating instructions must be kept in a safe place near the equipment.

Like most equipment, the unit requires regular maintenance. This section concerns the maintenance personnel and management.

If you have any queries or would like to receive further information on any aspect relating to your equipment, do not hesitate to contact us.







**BELGIUM :** LENNOX BENELUX N.V./S.A.  
tél. : + 32 3 633 30 45  
fax : + 32 3 633 00 89  
e-mail : info.be@lennoxbenelux.com

**CZECH REPUBLIC :** LENNOX JANKA  
tél. : + 420 2 510 88 111  
fax : + 420 2 579 10 393  
e-mail : janka@janka.cz

**FRANCE :** LENNOX FRANCE  
tél. : + 33 4 72 23 20 20  
fax : + 33 4 78 20 07 76  
e-mail : accueil@lennoxfrance.com

**GERMANY :** LENNOX DEUTSCHLAND GmbH  
tél. : + 49 69 42 09 79 0  
fax : + 49 69 42 09 79 40  
e-mail : info.de@lennoxdeutschland.com

**MIDDLE EAST :** LENNOX DISTRIBUTION  
tél. : + 971 4 262 9309  
fax : + 971 4 266 7082  
e-fax : + 1 240 368 73 62  
Mobile : 971 50 4510669  
e-mail : mmrifa1@emirates.net.ae

**NETHERLANDS :** LENNOX BENELUX B.V.  
tél. : + 31 33 2471 800  
fax : + 31 33 2459 220  
e-mail : info@lennoxbenelux.com

**POLAND :** LENNOX POLSKA Sp. z o. o.  
tél. : + 48 22 832 26 61  
fax : + 48 22 832 26 62  
e-mail : info@lennoxpolska.pl

**PORTUGAL :** LENNOX CLIMATIZAÇÃO LDA.  
tél. : +351 22 999 84 60  
fax : +351 22 999 84 68  
e-mail : info@lennoxportugal.com

**RUSSIA :** LENNOX DISTRIBUTION MOSCOW  
tél. : + 7 095 246 07 46  
fax : + 7 502 933 29 55  
e-mail : lennox.dist.moscow@mtu-net.ru

**SLOVAKIA :** LENNOX SLOVAKIA  
tél. : + 421 2 44 87 19 27  
fax : + 421 2 44 88 64 72

**SPAIN :** LENNOX REFAC S.A.  
tél. : + 34 915 40 18 10  
fax : + 34 915 42 84 04  
e-mail : marketing@lennox-refac.com

**UKRAINE :** LENNOX DISTRIBUTION KIEV  
tél. : + 380 44 213 14 21  
fax : + 380 44 213 14 21  
e-mail : jankauk@uct.kiev.ua

**UNITED KINGDOM :** LENNOX INDUSTRIES LTD  
tél. : + 44 1604 599400  
fax : + 44 1604 594200  
e-mail : marketing@lennoxind.com

**OTHER EUROPEAN COUNTRIES, AFRICA, LENNOX DISTRIBUTION :**  
tél. : + 33 4 72 23 20 14  
fax : + 33 4 72 23 20 28  
e-mail : marketing@lennoxdist.com



**LENNOX**<sup>®</sup>

[www.Lennox europe.com](http://www.Lennox europe.com)

MIL55S-101 05-2001

## Free Manuals Download Website

<http://myh66.com>

<http://usermanuals.us>

<http://www.somanuals.com>

<http://www.4manuals.cc>

<http://www.manual-lib.com>

<http://www.404manual.com>

<http://www.luxmanual.com>

<http://aubethermostatmanual.com>

Golf course search by state

<http://golfingnear.com>

Email search by domain

<http://emailbydomain.com>

Auto manuals search

<http://auto.somanuals.com>

TV manuals search

<http://tv.somanuals.com>