

www.lenovo.com



lenovo

Version 1.0 2009.8



31037825



IdeaCentre K3 User Guide

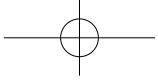

Important Safety Information

Before using this manual, it is important that you read and understand all of the related safety information for this product. Refer to the *Safety and Warranty Guide* that you received with this product for the latest safety information. Reading and understanding this safety information reduces the risk of personal injury or damage to your product.



Danger: Be aware of extremely hazardous or lethal situations.



Attention: Be aware of possible damage to programs, devices, or data.



Note: Pay attention to this important information.

© Copyright Lenovo 2007, 2009.

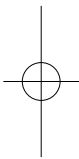
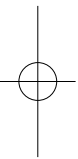
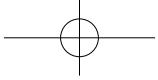

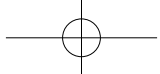

Contents

Important Safety Information

Chapter 1 Using the Computer Hardware	1
1.1 Front view of the chassis	2
1.2 Rear view of the chassis	3
1.3 Connecting your computer	4
1.4 Power Dial	12
Chapter 2 Using the Rescue System	17
2.1 OneKey Recovery	18
2.2 Driver and Application Installation	18
2.3 System Setup	19
2.4 System Backup	20
2.5 System Recovery	20
2.6 Create Recovery Disc	20
Chapter 3 Using the Computer Software	21
3.1 Power2Go - Burning Discs	22
3.2 WinDVD	23
3.3 Lenovo Healthcare Software	24
3.4 McAfee Security Center	27
3.5 BackOn Track	28
Chapter 4 System Maintenance and Recovery	31
4.1 Restoring the System	32
4.2 Backup and Restore	32
4.3 Cleaning Up the Disk	32
4.4 Checking For, and Correcting Disk Errors	33
4.5 Defragmenting the Disk(s)	33

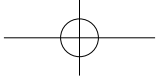

4.6 Performing Daily Maintenance Tasks.....33

Chapter 5 Troubleshooting and Confirming Setup 35

5.1 Troubleshooting Display Problems36

5.2 Troubleshooting Audio Problems37

5.3 Troubleshooting Software Problems.....37

5.4 Troubleshooting Problems with Optical Drives and
Hard Disks.....38

5.5 Special considerations for troubleshooting Windows39

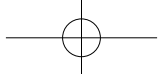

1

Chapter

Using the Computer Hardware

This chapter contains the following topics:

- Computer hardware introduction
- Information on computer connections

! **Note:** The descriptions in this chapter might vary from your computer, depending on computer models and configurations.

1

2

3

4

5

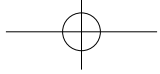

1.1 Front view of the chassis



Attention: Be sure not to block any air vents on the computer. Blocked air vents can cause thermal problems.

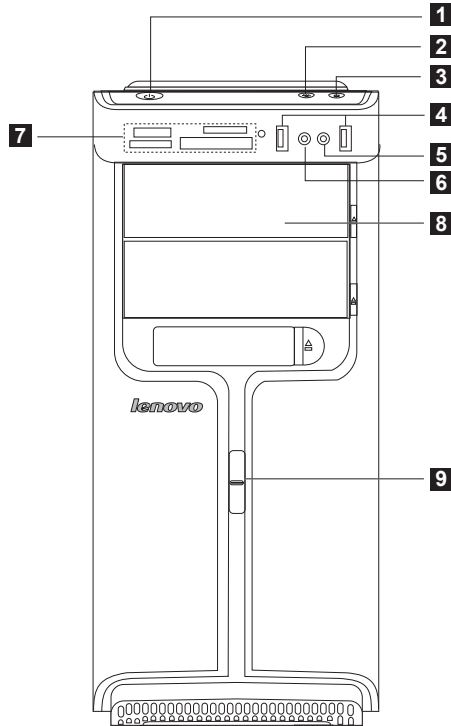

- 1** Power button
- 2** Power Dial indicator ON/OFF
- 3** File backup button
- 4** USB connector
- 5** Microphone connector
- 6** Headphone connector
- 7** Memory card reader (selected models only)
- 8** Optical drive (Some models are equipped with only one optical drive.)
- 9** Power Dial switch

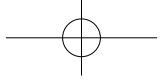

1.2 Rear view of the chassis

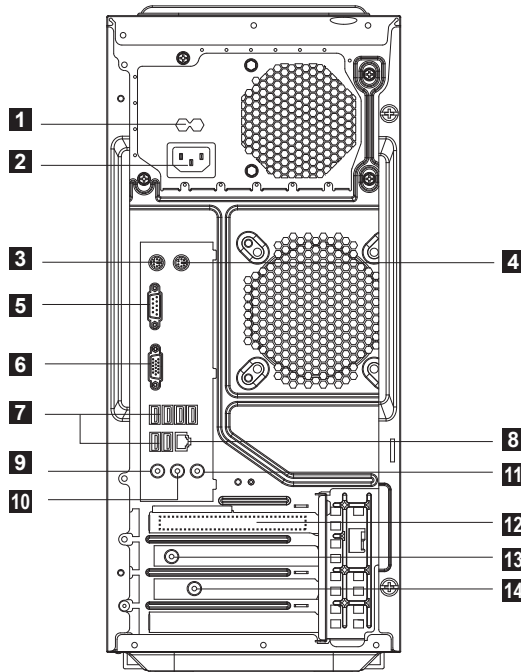

- 1** Voltage selection switch (selected models only)
- 2** Power connector
- 3** PS/2 keyboard connector
- 4** PS/2 mouse connector
- 5** Serial connector
- 6** On-board VGA connector (selected models only)
- 7** USB connectors (6)
- 8** Ethernet connector
- 9** Microphone connector
- 10** Audio line-out connector
- 11** Audio line-in connector
- 12** PCI Express x16 graphics adapter connector (Some models are equipped with this connector. For more information about the graphics adapter, see the description below).

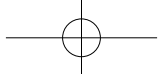

- 13** WiFi antenna connector (This connector only equipped on the model with WiFi card. For more information about this connector, see WM600-B-LO Wireless 802. 11b/g Wireless PCI-E Adapter Card User Manual.)
- 14** TV-Tuner (selected models only)

1.3 Connecting your computer

Use the following information when connecting your computer.

- Look for the small connector icons on the back of your computer. Match the connectors to the icons.
- If your computer cables and connector panel have color-coded connectors, match the color of the cable end with the color of the connector.

! **Note:** Your computer might not have all of the connectors that are described in this section.

1.3.1 Check the position of the voltage-selection switch on the rear of the computer. Use a ballpoint pen to slide the switch if necessary.

! **Note:** Some computers do not have the voltage switch. These computers automatically control the voltage.

- If the voltage supply range is 100-127 V ac, set the switch to 115 V.
- If the voltage supply range is 200-240 V ac, set the switch to 230 V.

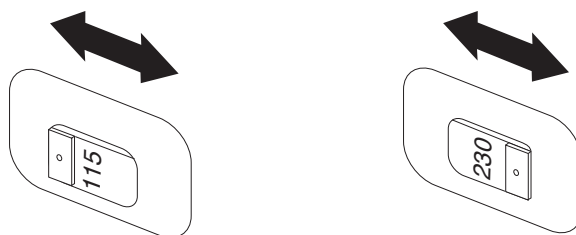

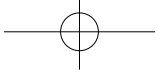

1.3.2 Connect the keyboard cable to the appropriate keyboard connector. (PS/2 connector or USB connector)

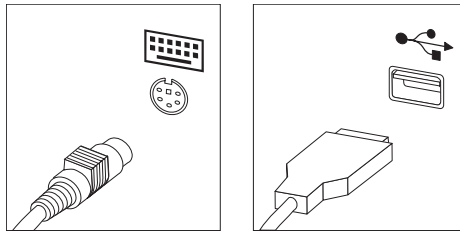

1.3.3 Connect the mouse cable to the appropriate mouse connector. (PS/2 connector or USB connector)

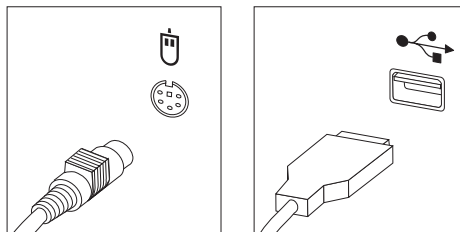

! **Note:** If your computer is equipped with a wireless keyboard or mouse, follow those installation instructions.

1.3.4 Connect the monitor cable to the monitor connector on the computer.

- If you have a Video Graphics Array (VGA) Standard monitor, connect the cable to the connector as shown.

! **Note:** If your model has two monitor connectors, be sure to use the connector on the graphics adapter.

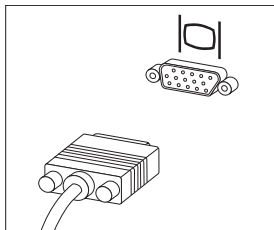

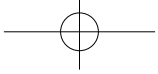

- If you have a digital video interface (DVI) monitor, your computer must have an adapter installed that supports the DVI monitor. Connect the cable to the connector as shown.

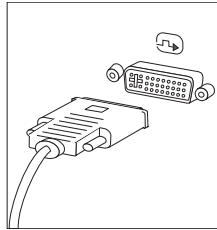

- If you only have a DVI connector on the graphics card and the monitor only has a VGA connector, these two connectors can be connected with a DVI-VGA commutator.

1.3.5 If you have audio devices, attach them using the following instructions.

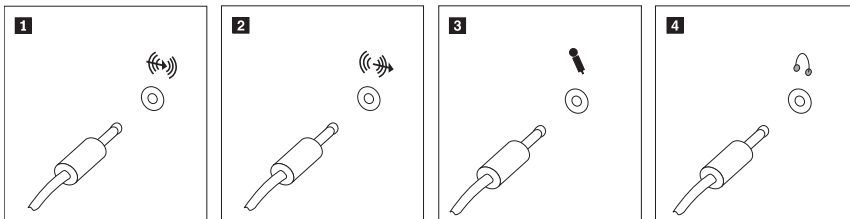

- 1 Audio line-in** This connector receives audio signals from an external audio device, such as a stereo system.
- 2 Audio line-out** This connector sends audio signals from the computer to external devices, such as powered stereo speakers.
- 3 Microphone** Use this connector to attach a microphone to your computer when you want to record sound or if you use speech-recognition software. This connector might be located on the front of the computer.
- 4 Headphone** Use this connector to attach headphones to your computer when you want to listen to music or other sounds without disturbing anyone. This connector might be located on the front of the computer.

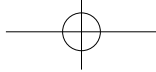

1.3.6 Audio configuration instruction: (This instruction is only for the pc model which mainboard supports audio transforming from 2.0 stereo to 5.1 surround.)

This model of computer supports transforming stereo sound into 5.1 surround sound.

Use the following guides when connecting to the 5.1 surround audio device:

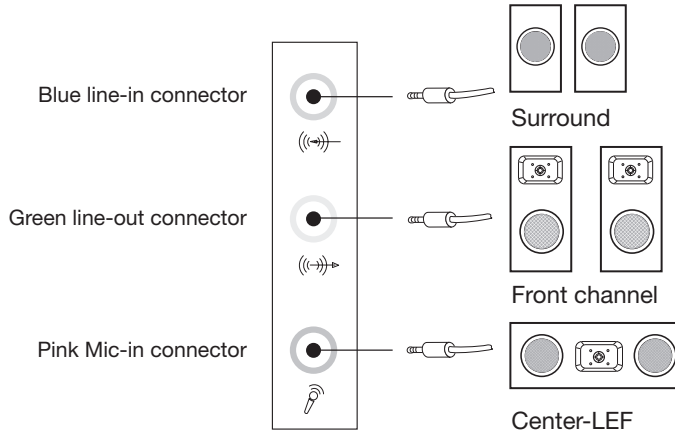

The configurations are as followings:

1. Right click the Sound icon in system property bar and select sounds option to setup the sounds in the pop-up dialog box.
2. Select a playback device from the playback dialog box, and then click configure button to configure it.
3. Select 5.1 surround from audio channels in the pop-up speaker setup dialog box to proceed with the speaker setup by following as prompted.
4. After the configuration, 5.1 surround can be used.

Note: If the audio configuration interfaces in above are different from your actual computer, you may use above steps as reference to configure the 5.1 surround audio device in your actual audio configuration interface and read the electronic Help information for further assistance.

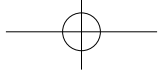

1.3.7 If you have *powered* speakers with an adapter:

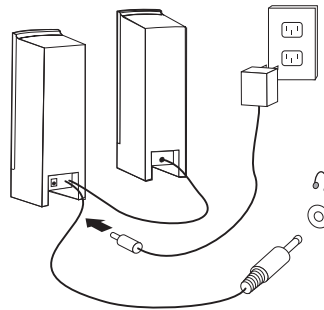

(This picture is only a sketch print, it does not show the actual figure of the speaker)

- Connect the cable that runs between the speakers, if necessary. On some speakers, this cable is permanently attached.
- Connect the adapter cable to the speaker, if necessary. On some speakers, this cable is permanently attached.
- Connect the speakers to audio line-out port on the computer.
- Connect the adapter to the power source.

1.3.8 If you have *powered* speakers without an adapter:

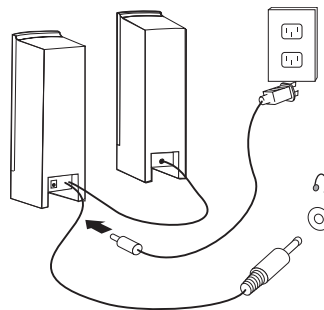

(This picture is only a sketch print, it does not show the actual figure of the speaker)

- Connect the cable that runs between the speakers, if necessary. On some speakers, this cable is permanently attached.
- Connect the cable to the speaker, if necessary. On some speakers, this cable is permanently attached.
- Connect the speakers to audio line-out port on the computer.
- Connect the plug to the power source.

! Note: Some models are not equipped with external speaker.

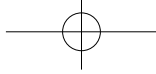

1.3.9 Connect any additional devices that you have. Your computer might not have all connectors that are shown.

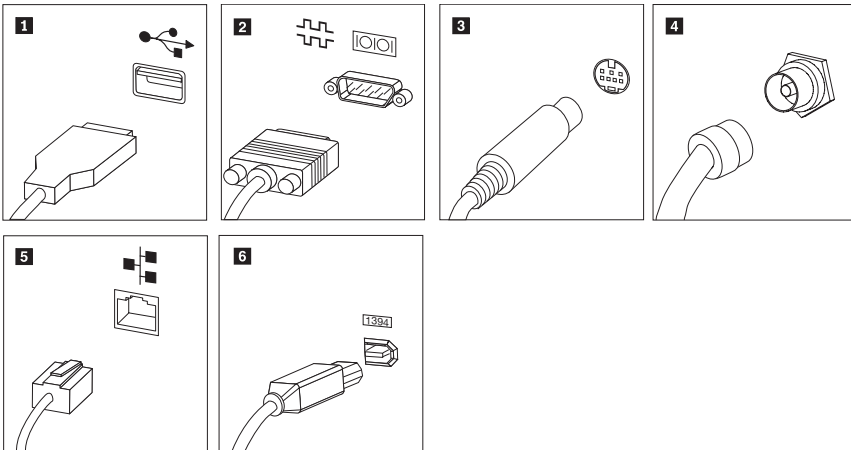

- 1 USB connector** Use this connector to attach a device that requires a USB connection.
- 2 Serial connector** Use this connector to attach an external modem, serial printer, or other device that uses a 9-pin serial connector.
- 3 S-Video** Use this connector to attach a television set that has a S-Video connector.
- 4 TV-Tuner connector** Only supported on systems with optional TV tuner card.
- 5 Ethernet** Use this connector to attach the computer to an Ethernet-type local area network
- 6 IEEE 1394** This connector offers connection to several types of consumer electronics, including digital audio devices and scanners.



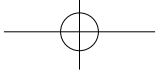

1.3.10 Connect the WiFi antenna to WiFi card connector.

(This connector only equipped on the model with WiFi card. For more information about this connector, see WM600-B-LO Wireless 802. 11b/g Wireless PCI-E Adapter Card User Manual.)

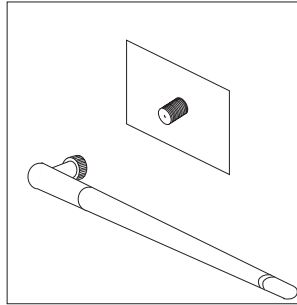

WiFi antenna connector — To connect the computer to a wireless network. Screw the WiFi antenna on the WiFi card connector if the model you purchased is equipped with the WiFi card.

! **Note:** Wifi card cannot be used to connect to network in Lenovo Rescue System. Please update virus package via Onekey Antivirus in Lenovo Rescue System with cable network.

1.3.11 Connect the power cords properly to ground electrical outlets.

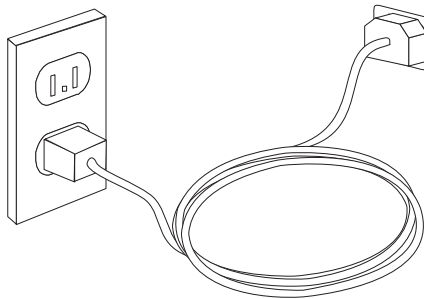

1.3.12 If your computer is equipped with Memory Card Reader Connector, it is able to read/write data from

Micro Drive, Compact Flash type I&II
xD picture card

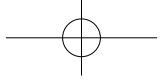

Memory stick, Memory stick pro, Memory stick duo, Memory stick pro duo, Memory stick select, Magic gate memory stick, Magic gate memory stick duo

Secure Digital Card, SD High Capacity, Mini Secure Digital card, Mini SD High Capacity

Multi Media Card, Reduce Size Multi Media Card, Multi Media Card Plus, Multi Media Card Mobile, SD High Speed, MMC High Speed.

Micro Secure Digital,

Micro Multi Media Card,

Micro Secure Digital HC,

M2.

1.3.13 Keyboard and Mouse (wired)

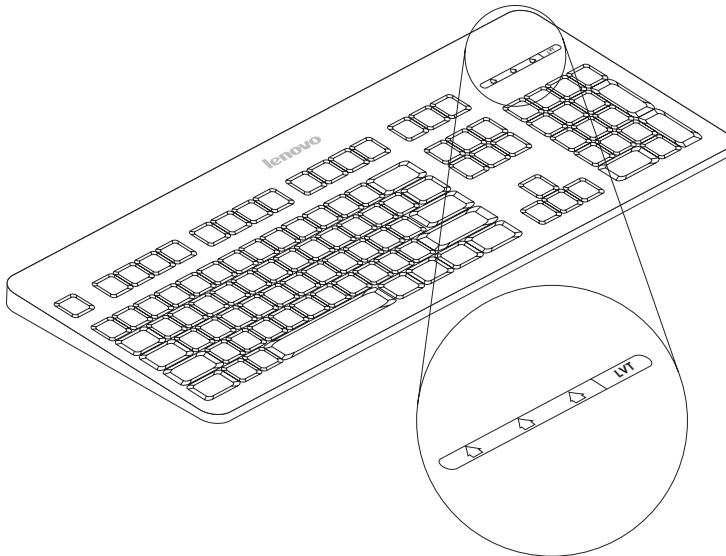

- LVT** — After entering Windows, press this key to launch the LVT (Lenovo Vantage Technology) program, Lenovo's pre-loaded Home PC software. In addition to its own functions, the LVT program will allow you to start other Windows compatible software, specially configured to run on this model of computer.
- F2** — Your computer has the Lenovo Rescue System installed. To learn more about this program, turn on the computer, and when the **Lenovo** logo appears, press the F2 key and the Lenovo Rescue System will open.

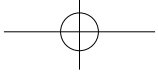

1.4 Power Dial

The Power Dial feature allows your computer to adjust to different modes, thus providing you with varied experiences during operations.

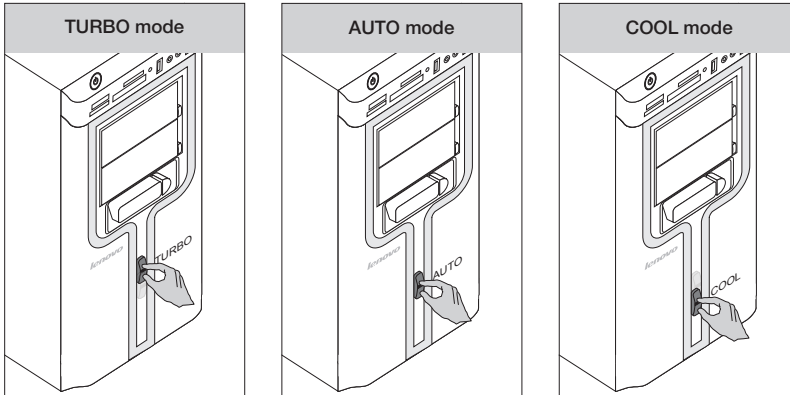

Operation of the Power Dial

The Power Dial function supports three operating modes: the AUTO mode, the TURBO mode and the COOL mode. System resources are optimized by toggling among those three different modes. Different modes are used for different applications.

Display the main screen of software

Double click the Power Dial icon in the Quick Launch bar.

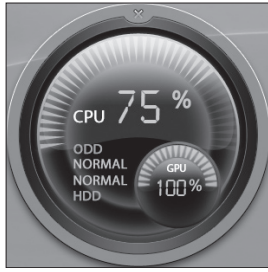
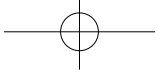

Open the running status for each component under the Mode Switch:

GPU — Show the percentage of the current GPU clock frequency against the nominal maximal GPU clock frequency.

CPU — Show the percentage of the current CPU clock frequency against the nominal maximal CPU clock frequency.

ODD — The status of the optical drive.

HDD — The status of the hard disk drive.

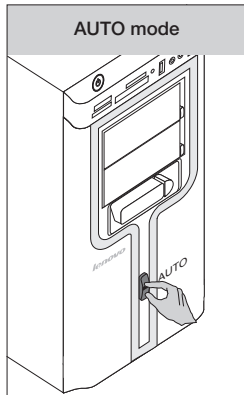

AUTO

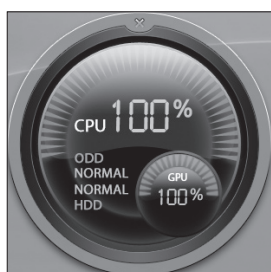
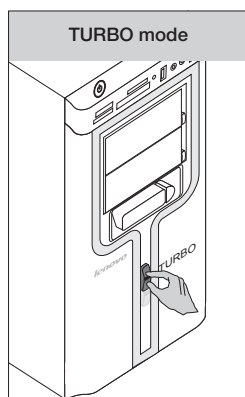
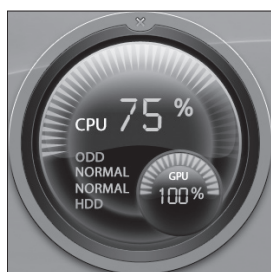
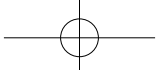

AUTO

Each component operates as it is displayed in the picture. The numeric values might vary because each model is configured differently.

TURBO

Runs at full speed. The system achieves its optimal performance. Turn the Power Dial knob to the TURBO position.

TURBO

Each component operates as shown in the adjacent picture. The values might vary because each model is configured differently.

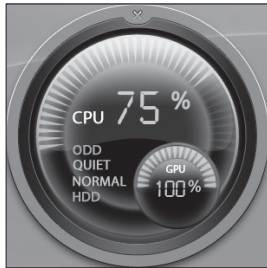
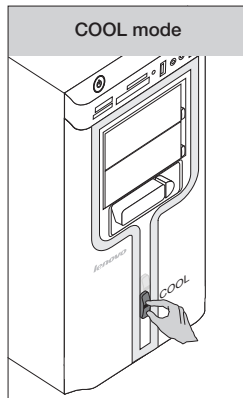
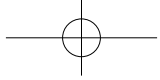

COOL

The CPU runs at low frequency. The system consumes minimum power. Turn the Power Dial knob to the COOL position.

COOL

Each component operates as shown in the adjacent picture. The values may vary because each model is configured differently.

If other applications such as the burner program or some game software change the parameter settings for the COOL mode when it is launched, a prompt dialog box will pop up indicating that your "COOL settings" has been changed. In this case, click OK.

To restore the previous COOL mode, exit other applications then turn the Power Dial knob mounted on the chassis, to the COOL mode.

⚠ Notes:

- When you are running large games or programs that consume a high proportion of the system resources, you should choose TURBO mode. This will allow you to achieve optimal performance.
- When the ODD status is shown as 'QUIET', it indicates that the current maximal data CD reading speed is lower than the nominal maximal reading speed of the ODD.

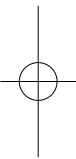
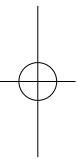
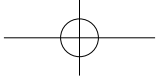

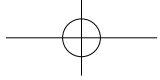

2

Chapter

Using the Rescue System

This chapter contains the following topics:

- OneKey Recovery
- Driver and Application Installation
- System Setup
- System Backup
- System Recovery
- Create Recovery Disc



Attention: Using this program will result in a loss of data.

- You can recover the C drive of the computer to the factory default settings or to the last system backup status using **OneKey Recovery**. With this operation, all of the existing data on drive C will be lost, whereas the content and format of the other partitions of the hard disk drive will remain unchanged.
- If you want to install an operating system with the Windows Recovery DVD and back it up with **OneKey Recovery**, you must format the C partition in **NTFS** format and install the operating system on the C partition. Otherwise, the **OneKey Recovery** system cannot run.

1

2

3

4

5

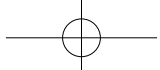

Note about the service partition:

The files and relevant data used by the rescue system are saved in the service partition. Deleting this partition will make the rescue system unusable. For more detailed information, see the following instructions:

By selecting **Control Panel** → **Administrative Tools** → **Computer Management** → **Disk Management**, you can see the service partition, which must not be deleted.

! **Note:** The recovery files and relevant data used by the rescue system are saved in the service partition. If the service partition is deleted or damaged by someone other than authorized Lenovo servicers, Lenovo will not be liable for any losses arising there from in any way.

2.1 OneKey Recovery

OneKey Recovery is an easy-to use application. You can use it to restore your computer to the system default or a previously backed up state.

Detailed Operation Procedure

1. Turn on the computer. When the *Lenovo* logo appears, press the **F2** key on the keyboard to start the **Rescue System**, then you can select **OneKey Recovery**.

! **Note:** System Recovery will overwrite all of the data on drive C. To prevent loss of data, be sure to back up relevant data before performing system recovery.

2. Follow the onscreen instructions to select the backup task you want to restore from and disk you want to install operation system, and press **Next** to start restoration.
3. Please wait during the process of system recovery. Do not interrupt the operation during the recovery process.
4. After the system is recovered successfully, the software prompts to restart the computer. Restart the computer and enter the system.

2.2 Driver and Application Installation

The Driver and Application Installation function in the rescue system provides a way for the user to conveniently re-install all of the Lenovo applications and drivers that were shipped with your Lenovo hardware.

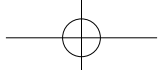

Method 1: Automatic Installation

Turn on the computer. When the Lenovo logo appears, press the **F2** key on the keyboard to start the **Rescue System**, then select **Drivers and Application Installation**.

Follow the screen prompts to install the Lenovo Drivers and Application Installation. Click **Install** to start installing the Lenovo Drivers and Application Installation.

The system will restart. After the system has restarted, the installation process will continue until completion.

Method 2: Manual Installation

In the Windows system, Click **Start** → **All Programs** → **Lenovo** → **Lenovo Drivers and Application Installation**.

After starting the procedure, install all the drivers and software manually according to the prompts.

! Notes:

1. It is recommended not to install the software which is already on the computer.
2. Before accessing the operating system, make sure that the Drivers and Application installation has been installed automatically. After that, the manual installation function can be used.

2.3 System Setup

System Setup configures the network configuration for the Lenovo Rescue System to ensure your Rescue System can connect to internet. In addition, System Setup sets and manages all passwords for the Lenovo Rescue system.

2.3.1 Launch

Turn on the computer. When the *Lenovo* logo appears, press the **F2** key to launch **Rescue System**. Then select **System Setup**.

2.3.2 Network Settings

Depending on the network access mode of the computer, select "ADSL" or "LAN Connection" in the network connection modes.

1. If you select "ADSL," input the username and password of the ADSL connection.

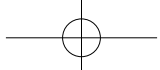

2. If you select “LAN connection,” configure the IP address and proxy server of the LAN.

2.3.3 Password Management

Password Management allows you to set the password for Lenovo Rescue System and manage it.

The default password is blank.

Set a password when you access the **Password Management** for the first time. If you don't want to set a password, access the system directly and operate accordingly.

2.4 System Backup

Back up your system partition to an image file. In case of a system failure, you can restore your system from this image file.

In the Windows system, click **Start** → **All Programs** → **Lenovo** → **Lenovo Rescue System**.

After starting the procedure, click **System Backup** to back up your system partition according to the prompts.

2.5 System Recovery

Reboot your computer into the system recovery environment. You can choose to restore to a system backup point or the initial state.

2.6 Create Recovery Disc

Create a bootable recovery disc from current system. These recovery discs are used to boot your computer and will guide you through the entire restoration process.

In the Windows system, click **Start** → **All Programs** → **Lenovo** → **Lenovo Rescue System**.

After starting the procedure, click **Create Recovery Disc** to create a bootable recovery disc from current system.

Follow the screen prompts to create recovery discs.

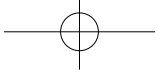

3

Chapter

Using the Computer Software

This chapter contains the following topics:

- Computer software instructions

! **Note:** The interface and function of each of these features are subject to the actual software that was shipped with the computer model that you purchased.

1

2

3

4

5

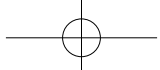

3.1 Power2Go - Burning Discs (This software only can be used on model with a rewritable optical drive and Blu-ray Burning Disc software is only equipped on the model with Blu-ray Disc rewritable optical drive.)

Power2Go is the software for disc burning. It provides various burning tools that enable you to easily store your files into CDs, DVDs or Blu-ray Discs.

Power2Go can make common data discs, music discs, video/photo discs and mixed discs and bootable discs. It also supports disc duplication.

You can create a bootable CD, DVD, Blu-ray Disc, which you can use to boot your computer from your disc drive if your operating system ever fails.

 **Note:** This software does not support the burning of VCD audio.

3.1.1 Launch

1. Choose **All Programs** → **Lenovo** → **Power2Go** → **Power2GoExpress** from the **Start** menu to launch the burner program.
2. The shortcut to launch the burner software is the block icon on the desktop. To use the burner program, just drag and drop the files to be recorded onto their appropriate data, music, or video icon.

3.1.2 Starting the burner software

1. Choose **All Programs** → **Lenovo** → **Power2Go** → **Power2Go** from the **Start** menu to launch the burner program.
2. Choose a task for the burner from the task list. Then start the burner to record files.
3. You can choose the medium to burn from the disc type, and then click the OK icon to access the burner interface.
4. Select the file to be burned from the select source box, and then click the add files icon to add your files into the disc compilation column. Click the burn icon to start burning process.

3.1.3 Disc Utility

The burner also provides utility tools for preparing and processing various CDs and DVDs, such as the recording of mirror files, erasing of discs, and conversion of audio.

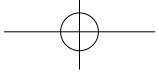

3.1.4 Help

For more information about the use of Power2Go, click the Help icon.

3.2 WinDVD (Some models are equipped with WinDVD software and the WinDVD Blu-ray software is only equipped on the model with the Blu-ray optical drive.)

With WinDVD, you can play DVDs and VCDs.











To launch the player:

Choose **All Programs** → **InterVideo WinDVD** from the **Start** menu to launch the player.

Click the “?” icon to obtain more information about **WinDVD**.

WinDVD Blu-ray Disc (BD) is the software for playing discs. It can play DVD standard format discs and Blu-ray format discs with the optical drive.

The WinDVD player includes the following basic buttons:

-  — Play
-  — Move backward within the current track
-  — Pause
-  — Move forward within the current track
-  — Track list
-  — Stop
-  — Go to the previous track
-  — Eject
-  — Go to the next track
-  — Mute
-  — Volume

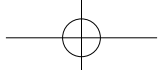

3.3 Lenovo Healthcare Software

Lenovo Healthcare Software is a smart software platform that helps parents to guide their children to use the computer correctly by protecting and providing a healthy computing experience for them.

With the eyesight protection and brightness adjustment function, the **Lenovo Healthcare Software**:

- Automatically monitors the distance between the child's head and the computer display during computer operation, and prompts the child to keep a proper distance from the computer monitor.
- Automatically adjusts the display brightness of the computer according to the ambient brightness.
- Helps the child keep a proper sitting posture while operating a computer. The **Lenovo Healthcare Software** protects the healthy growth of childrens' spines and vision (**Lenovo PC Bright Eye** camera is required in order to use these functions).

3.3.1 Eyesight Protection Setting

1. The **Lenovo PC Bright Eye** camera and **Lenovo Healthcare Software** work together to maintain proper distance between the computer operator and the computer display. It also automatically adjusts the display brightness to a comfortable level thereby protecting the operator's vision.
2. This function applies only to the computers equipped with a **Lenovo PC Bright Eye** camera and is available only after the camera is installed.
3. For details about installing **Lenovo PC Bright Eye** camera, see "Installation Guide for **Lenovo PC Bright Eye Camera**" in this document.
4. Before using this software, you need adjust the pitching angle of the web camera to the appropriate position.

To use this software, do the following:

- 1) Click **Start** → **All Programs** → **Lenovo USB2.0 UVC Camera** → **vmcap**.

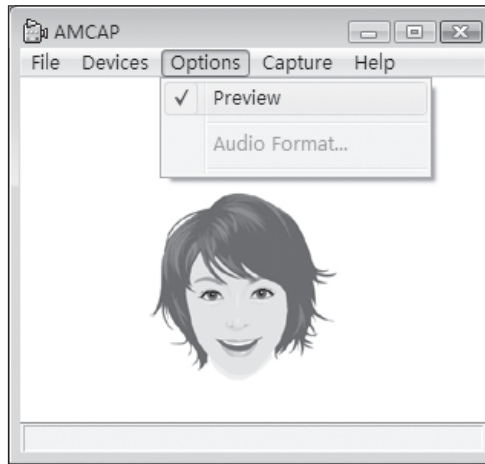
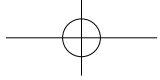

- 2) Select **Options** → **Preview** from the pop-up window to display the image in the video capture window.

⚠ **Note:** If there is no image display in the AMCAP video capture window, please confirm that preview in the options has been checked.

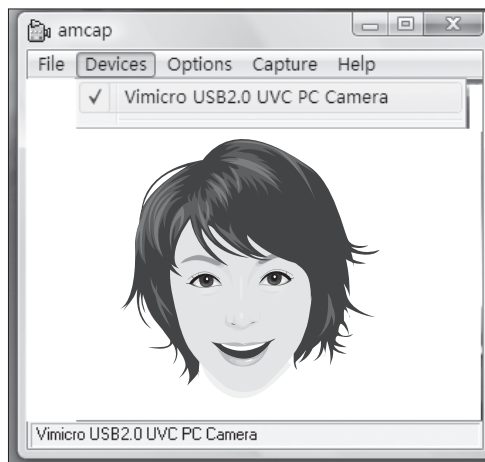

- 3) Confirm that **Devices** → **Vimicro USB 2.0 UVC PC Camera** has been checked. If there are other devices in this option, do not check them. Only choose the **“Vimicro USB2.0 UVC PC Camera”** device, and the window should display the camera image. An image, which is caught by Lenovo PC Bright Eye camera, will be displayed in the video capture window. Adjust the position and pitch angle of the camera to ensure the whole face is displayed in the video capture window.

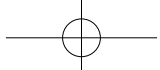

Now you have successfully configured the **Lenovo PC Bright Eye camera** with **Lenovo Health Care Software**.

5. Click **Start** → **All Programs** → **Lenovo** → **Lenovo Healthcare Software**.
6. Click **Eyesight Protection** or **Brightness Adjustment** to adjust the camera.

3.3.2 Distance Setup

1. Select the display type according to the size of the display used.
2. Select Healthy Viewing Distance Selection to set the distance between the computer operator and the computer display.
By default, a setting is selected. You can adjust the viewing distance according to your requirement.
3. Select Response Time Setting to set the duration of time before an alarm is given when the distance between the operator and the display is shorter than the healthy viewing distance.

3.3.3 Brightness Adjustment

1. Adjust the display brightness according to the ambient brightness.
2. There are three levels of ambient brightness: Dim, Moderate, and Bright.
3. When you use the computer for the first time, you should set the proper display brightness according to each level of ambient brightness.
4. For each level of the ambient brightness, the recommended display brightness is selected by default. Please adjust your display brightness to a comfortable level.
5. After the brightness setting is completed, the display brightness will be automatically changed according to the current level of ambient brightness.

3.3.4 The Limitations of the Lenovo Bright Eye Camera

1. Ensure the lens of the camera is exposed and not covered.
2. Ensure your eyes are exposed and not covered.
(The function that detects the distance between the user and monitor is based on the position of the user's eyes. Therefore, if the eyes are covered or there is a strong reflection, the distance detection may be affected.)
Wear glasses may affect the accuracy of the face image verification.
3. The limitation of the distance detection by the camera:
The minimum distance : about 20 centimeters (7.90 inches)
The maximum distance : about 70 centimeters (27.55 inches)

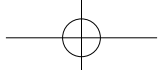

The pitch angle (the face rotary angle scope in the vertical):

Elevation angle: 20 degrees

Depression angle: 30 degrees

The horizontal rotary angle (the face rotary angle scope in the horizontal):

-20~+20 degrees

3.4 McAfee Security Center

McAfee VirusScan Center offers proactive PC security to prevent malicious attacks. It also provides security against multi-pronged attacks by combining anti-virus, anti-spyware and firewall technologies.

 **Note:** Connect to the Internet before activation.

3.4.1 Using McAfee Security Center

Choose **All Programs** → **McAfee** → **McAfee Security Center** from the **Start** menu to launch the antivirus software.

Or, Double click the **McAfee Security Center** on the desktop to launch the antivirus software.

3.4.2 Scanning for Viruses

Click **Scan** on the Security Center home page. Select a task on the Scan Options pane, Click **Start** to launch the scan program. Upon completion, the software will pop up a system scanning report, which lists all virus files detected, and you can then quarantine or delete them as required.

3.4.3 Check for updates

Click **Update** on the Security Center home page to check for updates.

 **Note:** Connect to the Internet before upgrading.

3.4.4 Help and Support

For more information on the operation of Security Center, see product help Information in the **Help** option. In the help document, you can learn more about McAfee Security Center operation and settings.

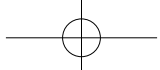

3.5 BackOn Track

The BackOn Track lets you easily back up important files to a disc, hard drive, or other storage device. A Back Up Files project can be scheduled to run daily, weekly, or monthly. Large backups are automatically spread across as many discs as you need.

3.5.1 Using BackOn Track

Choose **All Programs** → **Lenovo** → **FileBackup** from the **Start** menu to launch the BackOn Track software.

3.5.2 Back up files

Begin by selecting the drive, drive partition, or folder containing the files you like to archive. You can choose to archive all the files in the selected path or just certain types of files. Back up any files that have changed since a specified date, or create a custom backup based on certain file extensions. Finally, schedule the project to run on a regular basis, or begin backing up right away.

3.5.3 My Project

My projects is used to manage your saved backup projects. Any backup projects that you have saved will be listed under My Projects.

3.5.4 Restore Files

The Restore Files project restores individual files and folders that you have protected using the Back Up Files project. With Restore Files, you select a backup, search for the file or folder you would like to restore, and then click **Next**. The files will be restored to the location you choose.

3.5.5 Help

For more information on the operation of BackOn Track, see Product Help Information in the Help option. In the help document, you can learn more about the operation and settings of BackOn Track software.

3.5.6 File Backup button

After starting the Windows operating system, press the File backup button on the top of the chassis to launch the BackOn Track software.

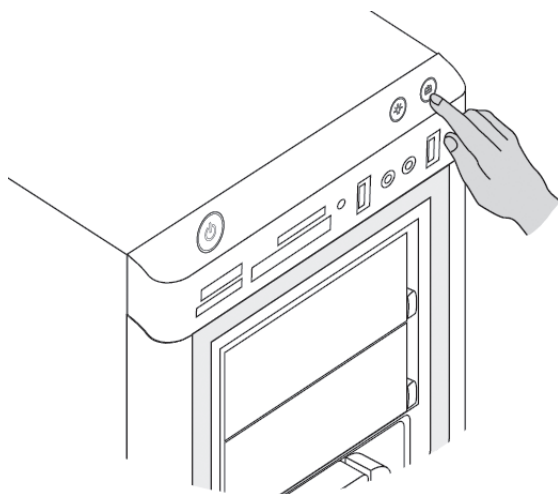
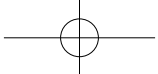

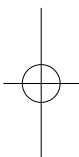
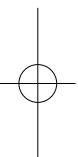
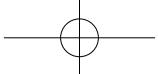

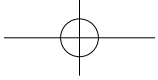

4

Chapter

System Maintenance and Recovery

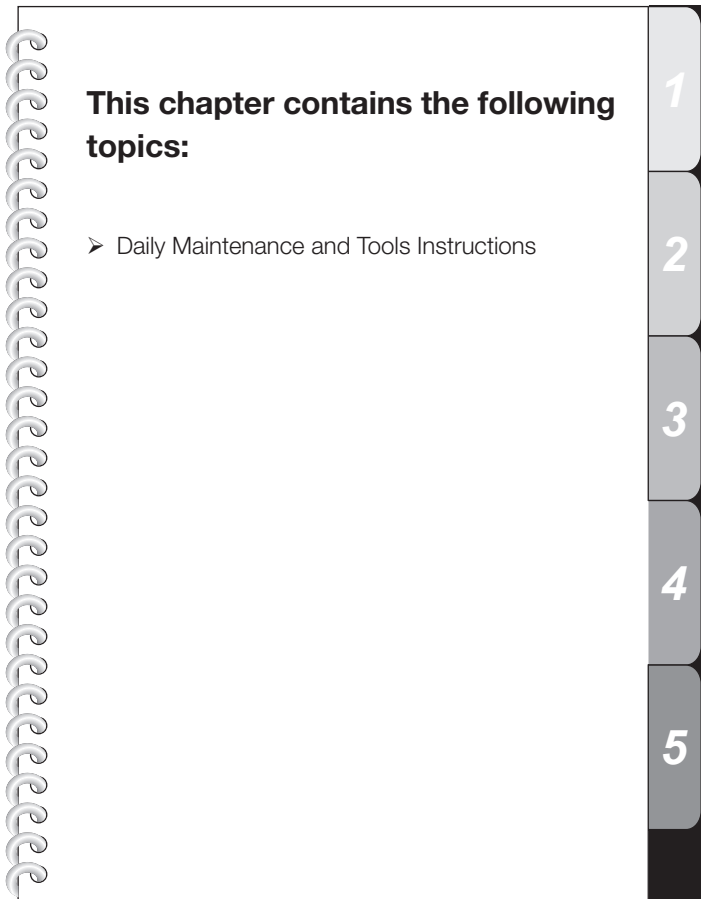

This chapter contains the following topics:

- Daily Maintenance and Tools Instructions

1

2

3

4

5

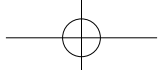

4.1 Restoring the System

The system can develop problems due to erroneous operation or the installation of additional software. If software problems develop in the originally installed software, you can restore the system by using system backup and restoration features.

! **Note:** The existing system settings will change after restoration. Check the settings of the restored system to ensure they match settings that may be critical to your needs.

Use the following procedure to restore the software to a known functional level:

1. Click **Start** → **All Programs** → **Accessories** → **System Tools** → **System Restore**.
2. Choose either the recommended restore point, or select a different recovery time from the pop-up box. Choose the latest date when the system was running properly.
Click **Next** to continue.
3. The system will start restoration. When all processes run to completion, the system displays a message informing you that the restore operation has completed successfully.

4.2 Backup and Restore

For security purposes, you can back up the system status before you install additional software, or otherwise modify system settings. To back up the system status, do the following:

1. Click **Start** → **All Programs** → **Maintenance** → **Backup and Restore**.
2. Select the location for your backup. Click **Next** and follow the instructions to continue.

4.3 Cleaning Up the Disk

Do the following periodically to clean up the disks and possibly enhance your computer's performance:

1. Click **Start** → **All Programs** → **Accessories** → **System Tools** → **Disk Cleanup**.
2. Choose the disk you want to clean up.
3. Click the **OK** button to start the cleanup process.

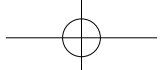

4.4 Checking For, and Correcting Disk Errors

To properly maintain your system, you should periodically check for and fix hard disk errors by doing the following:

1. Right-click the icon for the hard disk drive (HDD) that you want to reorganize, then select **Properties** from the pop-up menu.
2. Select the **Tools** tab, and then click **Check Now**.
3. Check your inspection items for the disk and click **Start**.

 **Note:** You cannot start error checking until the computer is restarted and initialized.

4.5 Defragmenting the Disk(s)

Disk fragments are tiny unused storage areas scattered on the disk. The system cannot directly reutilize these “blank” spaces and system performance can decrease as system operations usually cause the number of unused storage gaps to increase. To defragment your disk storage, do the following:

1. Right-click the icon for the hard disk drive (HDD) that you want to reorganize, then select **Properties** from the pop-up menu.
2. Go to the **Tools** tab from disk **Properties** and select **Defragment Now**.
3. Select the time and scheme to be used by the defragging program, then start the defragmenting program. Depending on the amount of defragmentation on the hard disk drive, this procedure can take a long time (sometimes more than one hour).

4.6 Performing Daily Maintenance Tasks

Cleaning the computer components

Because many of the computer components consist of sophisticated integrated circuit boards, it is very important to periodically clean around the computer to prevent dust buildup. The cleaning supplies you need in order to clean the components include: a vacuum cleaner, a soft cotton cloth, clear water (pure water preferred) and cotton swabs.

 **Attention:** Before you clean your computer, disconnect the computer from the electrical outlet. Clean your computer with a soft cloth dampened with water. Do not use liquid or aerosol cleaners, which may contain flammable substances.

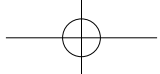

- !** **Note:** To avoid damaging the computer or display, do not spray cleaning solution directly onto the display. Only use products specifically designed for cleaning displays, and follow the instructions that are included with the product.

The following are general methods for cleaning the components:

- You can use a soft cloth to remove dust on the surface of the computer, the monitor, the printer, the speakers and the mouse.
- You can use a vacuum cleaner to clean in otherwise inaccessible corners.
- To clean the keyboard thoroughly, shut down the computer and scrub it gently with a wet cloth.
- Do *not* use the keyboard until it is dry.

Do not do any of the following:

- Allow water to enter the computer
- Use a heavily dampened cloth
- Spray water directly onto the surface of the monitor or inside of computer.

Daily attention should be given to LCD monitors. Use a dry cloth daily to brush dust from the monitor and keyboard. Keep all surfaces clean and free of grease stains.

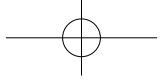

5

Chapter

Troubleshooting and Confirming Setup

This chapter contains the following topics:

- Troubleshooting and Problem Resolution

! **Note:** The description of the TV-Tuner card in this manual is only used for the machines which have the TV-Tuner card. It does not apply to those machines that do not have a TV-Tuner card.

1

2

3

4

5

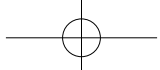

Solving Problems

Follow these tips when you troubleshoot your computer:

- If you added or removed a part before the problem started, review the installation procedures and ensure that the part is correctly installed.
- If a peripheral device does not work, ensure that the device is properly connected.
- If an error message appears on the screen, write down the exact message. This message may help support personnel diagnose and fix the problem(s).
- If an error message occurs in a program, see the program's documentation.

 **Note:** The procedures in this document were written for the Windows default view, so they may not apply if you set your Lenovo® computer to the Windows Classic view.

5.1 Troubleshooting Display Problems

Problem: Blank screen or no image is displayed on the monitor

Troubleshooting and problem resolution:

1. Check that the monitor has been turned on; if not, press the Power button.
2. Check to see if the monitor power cord is loose; if so, securely plug the power cord to the monitor.
3. Check that the signal cable to the monitor is securely connected to the connector on the computer graphics card; if not, shut down the computer then securely connect the signal cable of the monitor.

Problem: You need to change display property settings.

Setting display background and icon properties:

1. Right-click the desktop anywhere except over an icon, then select Personalize from the pop-up menu.
2. From here, select the appropriate options to:
 - Change the desktop background
 - Select a screen saver
 - Select colors and appearance options for icons and characters
 - Set resolution and colors by using Display Settings options.

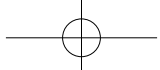

Problem: Ripple on screen

Troubleshooting and problem resolution:

1. Check for devices located less than one meter from the computer such as refrigerators, electric fans, electric dryers, UPSs, regulators, fluorescent lamps or other computers that may be generating magnetic interference.
2. Move any interfering devices away from the computer.
3. If the problem persists, consult with Lenovo Service.

5.2 Troubleshooting Audio Problems

Problem: No sound from integrated speakers

Troubleshooting and problem resolution:

- Adjust the windows volume control — Double-click the speaker icon in the lower-right corner of your screen. Ensure that the volume is turned up and that the sound is not muted. Adjust the volume, bass, or treble controls to eliminate distortion.
- Reinstall the audio driver
- Disconnect headphones from the headphone connector — Sound from the speakers is automatically disabled when headphones are connected to the computer's side-panel headphone connector.

Problem: No sound from headphones

Troubleshooting and problem resolution:

- Check the headphone cable connection — Ensure that the headphone cable is securely inserted into the headphone connector.
- Adjust the windows volume control — Click or double-click the speaker icon in the lower-right corner of your screen. Ensure that the volume is turned up and that the sound is not muted.

5.3 Troubleshooting Software Problems

Problem: You are unable exit a running program normally.

Troubleshooting and problem resolution:

1. Open the **Task Manager** window by pressing **Ctrl, Alt** and **Delete** at the same time.
2. Select the **Application** tab, select the problem program, and then click the **End Task** button.

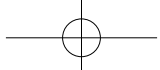

Problem: You need to install or uninstall a program.

Problem resolution:

During installation never abort the install process by powering the system off or through other drastic means. This can cause system program disorder or even failure during system initialization.

During the uninstall process, never directly delete the files or folders. This is harmful to the system, and might cause a system-wide malfunction.

Use the following procedure to properly uninstall programs:

1. Back up all documents and system settings related to the program before removing it.
2. If the program has its own uninstaller, run it directly to uninstall the program.
3. If the program does not have its own uninstaller, then select Control Panel from Start menu.
4. From the Control Panel, choose Programs and Functions.
5. Find the applicable program from the Programs and Functions dialog box and then select Uninstall/Modify.
6. Perform the instructions displayed to uninstall the software.

5.4 Troubleshooting Problems with Optical Drives and Hard Disks

Problem: The Optical drive is unable to read a CD/DVD.

Troubleshooting and problem resolution:

1. Check to determine if there is an optical drive icon in the resource manager of the operating system. If not, restart your computer. If there is still no icon, contact Lenovo Service. Otherwise, continue with the next step of this procedure.
2. Confirm that the CD/DVD has been properly placed in the drive. If not, reload the CD or DVD. Otherwise, continue with the next step of this procedure.
3. Check the specifications that came with your computer to confirm that this optical drive is supposed to be able to read this type of CD or DVD.
4. If the CD/DVD cannot be read, replace it with a known good CD/DVD such as one that was shipped with the computer.
5. If the known good CD cannot be read, visually check the operating side of the CD/DVD for defects.

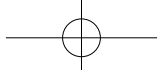

Problem: The capacity of the hard disk, as indicated by the system, is less than the nominal capacity.

Troubleshooting and problem resolution: For computers equipped with the OneKey Recovery feature, the system recovery feature needs to occupy some hard disk space. This may account for the apparent hard disk capacity deficit.

Further Technical Explanation: The nominal capacity of the hard disk is expressed in the decimal system, 1000 bytes. But the actual hard disk capacity is expressed in the binary system as 1024 bytes (For example, the nominal capacity 1G is 1000M, while the actual capacity 1G is 1024M).

The capacity of the hard disk shown in Windows can be calculated according to the calculations in the following example:

The nominal capacity of the hard disk is 40G, while its actual capacity should be: $40 \times 1000 \times 1000 \times 1000 / (1024 \times 1024 \times 1024) = 37\text{G}$.

If the Service partition of 3G - $3 \times 1000 \times 1000 \times 1000 / (1024 \times 1024 \times 1024) = 2.79\text{G}$ is subtracted, the capacity of the hard disk shown in the system can be obtained.

The capacity of the hard disk as calculated using this method may be slightly different from the actual capacity due to the rounding of totals.

5.5 Special considerations for troubleshooting Windows

Record the following information that may later be useful in troubleshooting system problems:

1. The serial number of the software. The serial number was shipped with the computer and was provided separately by the manufacturer. The Help Center is unable to retrieve this number.
2. The drivers for this computer model only support the Windows 7 system.
3. When you use the Windows Media Center to watch TV, be particularly attentive to the following:
 - In the following two situations, you must re-save a channel list:
 - a. When you change your TV signal from digital to analog, your saved channel list for digital TV is deleted. When you want to watch digital TV again, you must create and save a new channel list.
 - b. When you change your TV signal from analog to digital, your saved channel list for analog TV is deleted. When you want to watch analog TV again, you must create and save a new channel list.

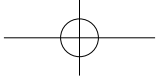

- Before you can watch teletext programming, you must set the TV tuner input signal to analog.

Free Manuals Download Website

<http://myh66.com>

<http://usermanuals.us>

<http://www.somanuals.com>

<http://www.4manuals.cc>

<http://www.manual-lib.com>

<http://www.404manual.com>

<http://www.luxmanual.com>

<http://aubethermostatmanual.com>

Golf course search by state

<http://golfingnear.com>

Email search by domain

<http://emailbydomain.com>

Auto manuals search

<http://auto.somanuals.com>

TV manuals search

<http://tv.somanuals.com>