



Note

Before using this information and the product it supports, be sure to read the general information under "Safety Information" on page xiii, Appendix B, and "Notices" on page 163.

First Edition (June 1998)

The following paragraph does not apply to the United Kingdom or any country where such provisions are inconsistent with local law:

INTERNATIONAL BUSINESS MACHINES CORPORATION PROVIDES THIS PUBLICATION "AS IS" WITHOUT ANY WARRANTY OF ANY KIND, EITHER EXPRESS OR IMPLIED, INCLUDING, BUT NOT LIMITED TO, THE LIMITED WARRANTIES OF MERCHANTABILITY OR FITNESS FOR A PARTICULAR PURPOSE. Some states do not allow disclaimers of express or implied warranties in certain transactions; therefore, this statement may not apply to you.

This publication could include technical inaccuracies or typographical errors. Changes are periodically made to the information herein; these changes will be incorporated in new editions of the publication. IBM may make improvements or changes in the products or the programs described in this publication at any time.

Requests for technical information about IBM products should be made to your IBM Authorized Dealer or your IBM Marketing Representative.

Copyright International Business Machines Corporation 1998. All rights reserved. Note to U.S. Government Users – Documentation related to restricted rights – Use, duplication, or disclosure is subject to restrictions set forth in GSA ADP Schedule Contract with IBM Corp.



Thank You for Selecting an IBM ThinkPad 560Z Computer

The thin and light IBM ThinkPad 560Z computer
is designed to satisfy
your mobile computing needs.

We hope you enjoy its fast processing power,
brilliant display, and flexible communication capability.

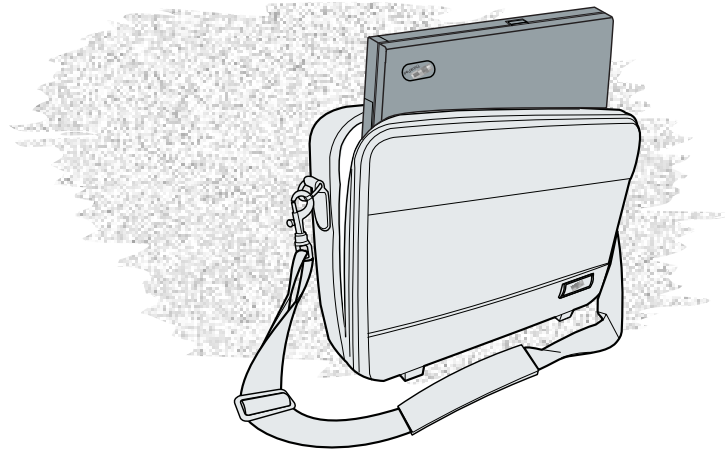

Functional Highlights

Ultra portability

The slim computer has excellent portability to assist you anytime and anywhere.

High-speed processor

The Intel Pentium II processor enables high-speed data processing and provides advanced performance.

Large-capacity hard disk drive

The large customer-upgradable hard disk drive provides for your demanding data storage needs. It can be optionally upgraded, or you may choose to have a secondary hard disk drive.

SVGA color LCD

The 12.1-inch TFT (thin-film transistor) display provides clear and brilliant color text and graphics.

Easy-to-use keyboard and pointing device

The full-size, full-stroke keyboard and the TrackPoint with "Press-to-Select" function increase your effectiveness and productivity in the office or on the road.

Lithium-ion battery pack

The long battery life and fast recharging extend the operating time of your computer, further contributing to ultra portability.

Audio features

Your computer is equipped with internal audio record and playback capabilities, including 3D (three-dimensional) audio. The computer also supports DOS Sound Blaster Pro** games.

PC Card Support

Your computer provides two PC Card slots that accept a 16-bit PC Card, CardBus Card, and Zoomed Video Card.



Communication

The 56-Kbps modem (on a PC Card) allows for efficient data and fax communication. Your computer's infrared technology enables wireless point-to-point communication with other systems or devices equipped with an infrared port.





Contents

Functional Highlights	iv
About This Book	xi
Safety Information	xiii
Chapter 1. Getting Familiar with Your Computer	1
Identifying the Hardware Features	2
System-Status Indicators	6
Functions of Your Computer	8
Attaching the External Diskette Drive	8
Keyboard Functions	10
ThinkPad Utility Programs	17
Online User's Guide	29
Backing Up Your System	30
ThinkPad Customization CD	30
Recovery CD	30
Diskette Factory	30
ConfigSafe	31
ThinkPad Web Site or Bulletin Board	31
Replacing the Battery Pack	32
Chapter 2. Extending the Features of Your Computer	35
Customizing the TrackPoint	36
Increasing Memory	39
Installing the DIMM	40
Removing the DIMM	43
Upgrading the Hard Disk Drive	45
Attaching an External Mouse, Keypad, and Keyboard	47
Attaching an External Mouse or Numeric Keypad	47
Attaching an External Keyboard and Mouse	49
Disabling the TrackPoint	51
Attaching an External Monitor	52
Installing a PC Card	56
Removing the PC Card	59
Installing the PC Card Modem	60
Using a Port Replicator	63
Enabling the CardBus Sockets (for Windows 98)	65

Chapter 3. Protecting Your Computer	67
Using Passwords	68
Entering a Password	69
Setting a Password	70
Changing or Removing a Password	74
Using the Personalization Editor	80
Entering Your Personal Data	80
Deleting the Personalization Window	83
Using Locks	84
Using the Security Screw	85
Chapter 4. Solving Computer Problems	87
Frequently Asked Questions	88
Considerations	96
Using Power Management	101
Using a PC Card	101
A USB Connector Consideration	102
A CardWizard Consideration	102
Using a Second CardBus Card	102
Using an External Condenser Microphone	102
Using the NetMeeting Software	103
Troubleshooting Guide	104
Troubleshooting Charts	105
Error Codes or Messages	106
No Error Codes or Messages	111
Input Problems	112
Suspend or Hibernation Problems	113
LCD Problems	116
Indicator Problems	117
Battery Problems	117
A Hard-Disk-Drive Problem	118
Infrared Communication Problems	118
A Universal Serial Bus (USB) Problem	119
PC Card Problems	120
A Printer Problem	123
External Monitor Problems	124
Port Replicator Problems	125
Other Option Problems	127
Software Problems	129
Other Problems	129
Testing Your Computer	131

Recovering Lost or Damaged Software	133
Using the Diskette Factory	133
Using the ThinkPad Customization CD	133
Using the Recovery CD	135
Chapter 5. Getting Service	137
Information on Your Computer	139
Option List	139
Identification Numbers	139
Problem Recording Sheet	140
Customer Support and Service	141
Help by ThinkPad Web Site	141
Help by Telephone	141
ThinkPad EasyServ	142
Getting Help around the World	142
Fax Information	143
Electronic Support Services	143
Purchasing Additional Services	146
Enhanced PC Support Line	146
Client Support Line	146
Network and Server Support Line	147
Ordering Support Line Services	148
Warranty and Repair Services	149
Obtaining IBM Operating System Updates	150
Getting Update Diskettes	150
Ordering Publications	150
Appendix A. Features and Specifications	151
Features	151
Specifications	153
IBM Power Cords	154
Appendix B. Handling Tips	157
Appendix C. Product Warranty and Notices	161
Notices	163
Year 2000 Readiness and Instructions	163
Trademarks	164
Electronic Emission Notices	165
Glossary	167



Index 171



About This Book

This book contains information that will help you operate the IBM ThinkPad 560Z computer. Be sure to read the *ThinkPad Setup Guide* and Chapter 1 of this book before using the computer.



Chapter 1 "Getting Familiar with Your Computer,"

acquaints you with the basic features of your computer.

Chapter 2 "Extending the Features of Your Computer,"

provides information on installing options and using your computer's high-technology features.

Chapter 3 "Protecting Your Computer,"

provides information on using passwords, identifying yourself with the Personalization Editor, and using locks.

Chapter 4 "Solving Computer Problems,"

describes what to do when you have a computer problem. The chapter includes a troubleshooting guide and information on how to recover lost or damaged software.

Chapter 5 "Getting Service,"

describes various options of IBM's support and service.

Appendix A, "Features and Specifications,"

describes the features and specifications associated with your computer, including information on power cords.

Appendix B, "Handling Tips,"

provides information you need to know when you are using your computer.

Appendix C, "Product Warranties and Notices,"

contains the warranty statements for your computer and notices for this book.

The **glossary** defines terms appearing in this book. The book concludes with an **index**.



Icons Used in This Book

For procedures or information unique to the operating system installed in your computer:



Information for Microsoft Windows 98 users



Information for IBM Operating System/2 (OS/2) users



Information for Microsoft Windows 95 users



Information for IBM DOS users



Information for Microsoft Windows NT users



Information for Microsoft Windows 3.1 users



Safety Information

Electrical Safety Notice

Note: In the U.K., by law:

The telephone line cable must be connected after the power cord.

The power cord must be disconnected after the telephone line cable.



Electrical current from power, telephone, and communication cable is hazardous. To avoid shock hazard, connect and disconnect cables as shown below when installing, moving, or opening the covers of this product or attached devices. The 3-pin power cord must be used with a properly grounded outlet.

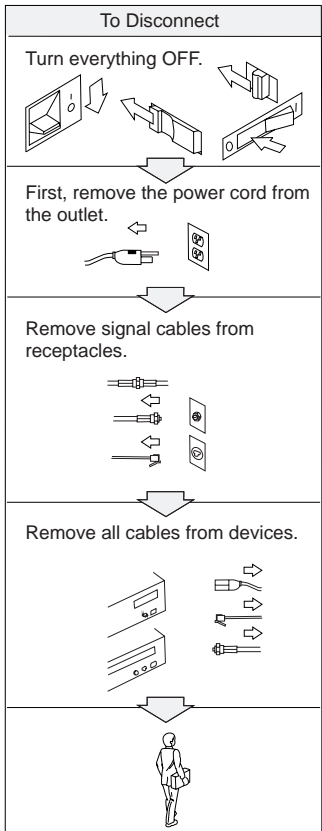
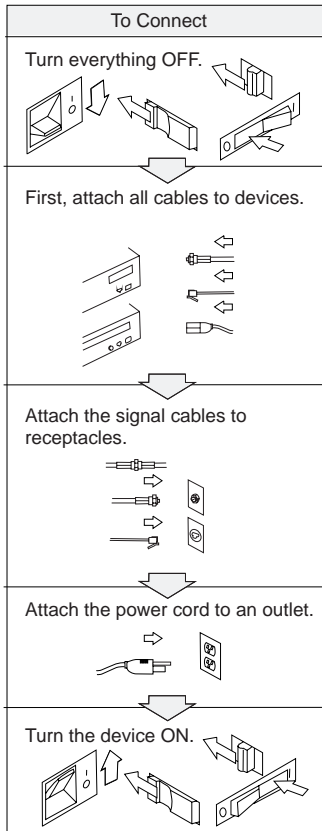

 **DANGER**

Do not disassemble, incinerate, or short-circuit the rechargeable battery pack. Do not put it in trash that is disposed of in landfills. Dispose of it as required by local ordinances or regulations. In the United States, call IBM at 1-800-IBM-4333 for information on disposal.

 **DANGER**

The lithium battery (IBM P/N 12J1695 UL-recognized component—File No. MH12210) can be replaced only by your dealer or an IBM service representative. It contains lithium and can explode if not properly used, handled, or disposed of. Do not: (1) throw or immerse into water, (2) heat to more than 100°C (212°F), or (3) repair or disassemble. Dispose of it as required by local ordinances or regulations.

CAUTION:

The fluorescent lamp in the liquid crystal display (LCD) contains mercury. Do not put it in trash that is disposed of in landfills. Dispose of it as required by local ordinances or regulations.

The LCD is made of glass, and rough handling or dropping the computer can cause the LCD to break. If the LCD breaks and the internal fluid gets into your eyes or on your hands, immediately wash the affected areas with water for at least 15 minutes; then get medical care if any symptoms are present after washing.

Chapter 1

Getting Familiar with Your Computer

This chapter provides basic information about your computer.

Note

If you power off the computer, wait at least 5 seconds before you power it on again. If you put your computer into suspend or hibernation mode, you should also wait at least 5 seconds before resuming normal operation.

To power off the computer without shutting it down, hold the power switch at least 1.5 seconds.

- Identifying the Hardware Features 2
- System-Status Indicators 6
- Functions of Your Computer 8
 - Attaching the External Diskette Drive 8
 - Keyboard Functions 10
 - TrackPoint 10
 - Fn Key 13
 - Numeric Keypad 16
 - ThinkPad Utility Programs 17
 - Easy-Setup 17
 - ThinkPad Configuration Program 25
 - Online User's Guide 29
- Backing Up Your System 30
 - ThinkPad Customization CD 30
 - Recovery CD 30
 - Diskette Factory 30
 - ConfigSafe 31
 - ThinkPad Web Site or Bulletin Board 31
- Replacing the Battery Pack 32

Identifying the Hardware Features

Identifying the Hardware Features

Front View

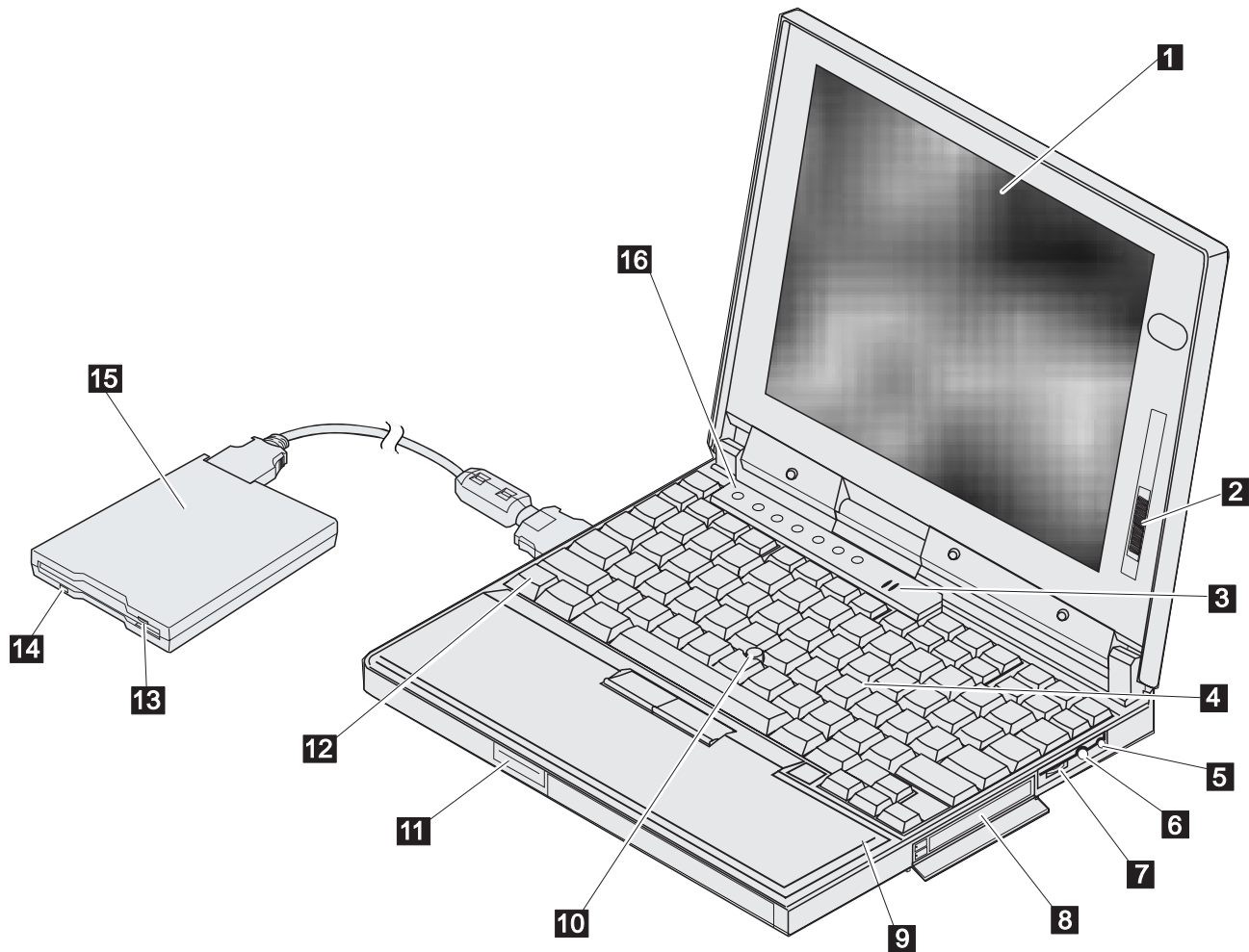

Identifying the Hardware Features

- 1 The **color LCD screen** displays computer output.
- 2 The **brightness control** moves up or down to adjust the brightness of the display.
- 3 The **built-in microphone** captures sound and voice when it is used with an application program capable of handling audio.
- 4 The **keyboard** is used to enter data into the computer. (To use the **numeric keypad** on the keyboard, see page 16.)
- 5 The **headphone jack**, a 1/2 inch (3.5-mm) diameter jack, is where you connect a stereo headphone or external speakers.
- 6 The **microphone/line-in jack**, a 1/2 inch (3.5-mm) diameter jack, is where you connect a microphone or an external stereo audio device.
- 7 The **infrared port** allows the computer to communicate with other devices that have infrared data-transfer capability.
- 8 The **PC Card slots** accept PC Cards.
- 9 The **PC Card eject buttons** eject the PC Card from the PC Card slot.
- 10 The **TrackPoint** is a built-in pointing device that provides a function similar to that of a mouse.
- 11 The **LCD button** opens the LCD when pressed.
- 12 The **Fn key** is used with the function keys to activate the **Fn key** functions.
- 13 The **diskette-eject button** ejects a diskette from the diskette drive.
- 14 The **diskette drive in use indicator** is on when data is read or written to a diskette. (Refer to page 6.)
- 15 The **external diskette drive** reads data from or writes data to a diskette.
- 16 The **system-status indicators** consist of the indicators and their associated symbols. (Refer to page 6.)

Identifying the Hardware Features

Rear View

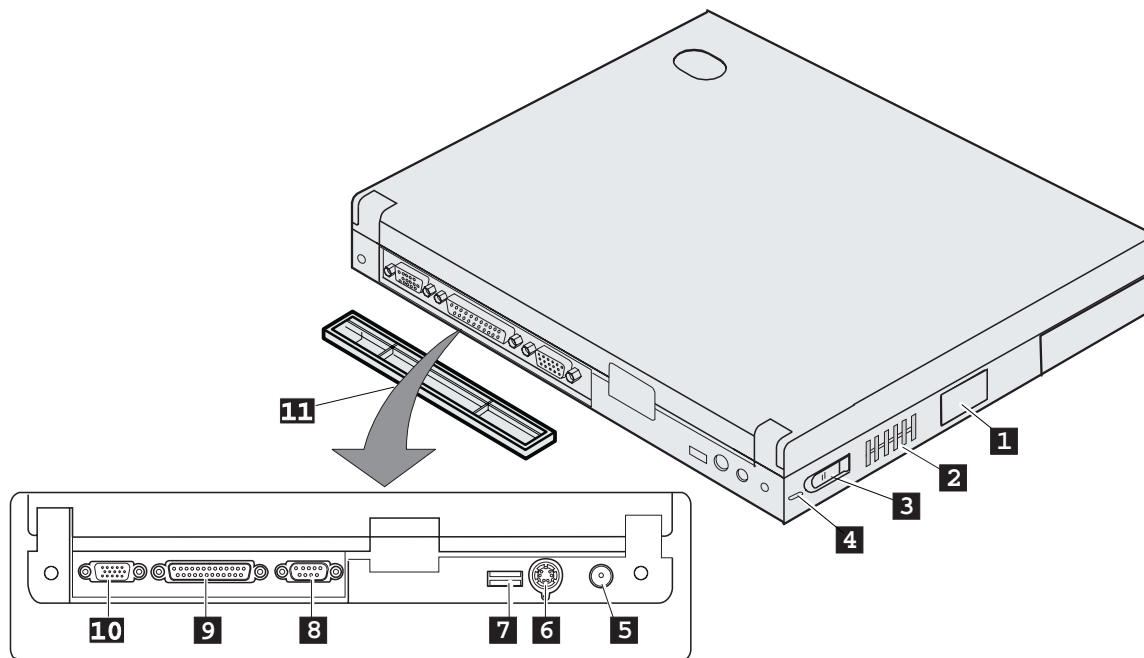

- 1 The **external-diskette-drive connector** is where you connect the cable of the external diskette drive.
- 2 The **fan louver** allows the inside of the computer to stay cool. **Do not place anything in front of the louver that might block air flow.** The cooling fan starts at power-on, and then stops and starts alternately depending on the temperature inside the computer.
- 3 The **power switch** turns the computer on and off.
- 4 The **security keyhole** is used with a mechanical lock.
- 5 The **power jack** is where the AC Adapter cable is connected.
- 6 The **external-input-device connector** is used to attach a mouse, external keyboard, or external numeric keypad to the computer.
- 7 The **Universal Serial Bus (USB) connector** allows you to connect any device that conforms to the USB interface. Many recent digital device comply to this new standard.
- 8 The **serial connector** is where you connect a 9-pin, serial-device cable.
- 9 The **parallel connector** is where you connect a parallel-printer signal cable.
- 1 The **external-monitor connector** is where you attach the external monitor.
- 11 The **connector cover** is removable.

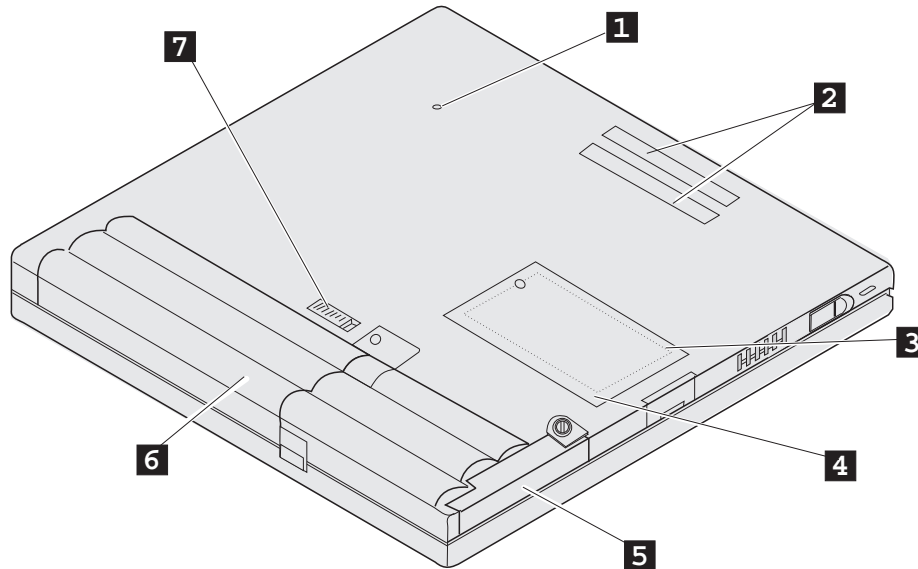
Bottom View (with Battery Installed)

- | | | |
|---|--|--|
| <p>1 The power shutdown switch is used to turn the computer off when an application locks up or the computer will not accept any input. Use the tip of a pen to press this switch.</p> <p>2 The expansion connectors allow you to connect the port replicator (available as an option).</p> | <p>3 The memory slot accepts a dual inline memory module (DIMM) option.</p> <p>4 The memory-slot cover covers the memory slot.</p> <p>5 The hard disk drive can be upgraded with an optional one. The security screw shipped with your computer can prevent the hard disk drive from removing easily. (Refer to page 45.)</p> | <p>6 The battery pack is a built-in power source for the computer.</p> <p>7 The battery-pack latch locks or releases the battery pack.</p> |
|---|--|--|







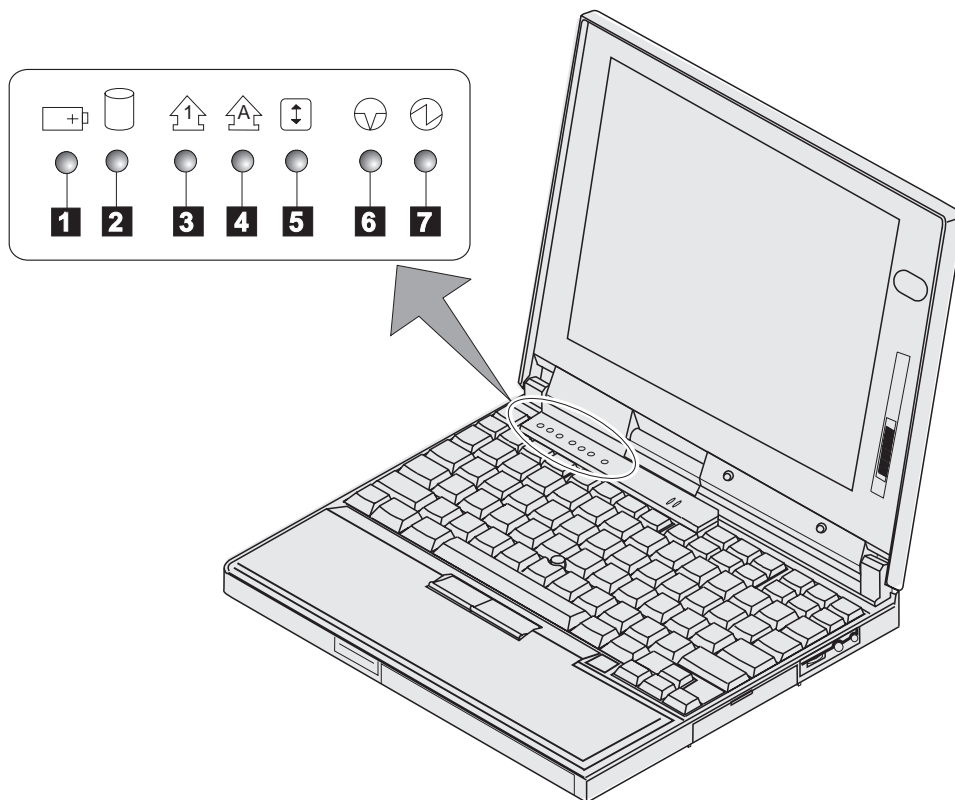

System-Status Indicators

System-Status Indicators

The system-status indicators on the computer show the current status of your computer by their on or off states and colors (green and orange). Each indicator is identified with a symbol. The following shows the location and the meaning of each icon:



System-Status Indicators

Symbol	Color	Meaning
1 Battery 	Green	Enough battery power remains for operation.
	Orange	The battery pack is being charged.
	Blinking orange	The battery pack needs to be charged. If the indicator starts blinking orange, the computer beeps three times.
2 Hard disk in use 	Orange	Data is being read from or written to the hard disk. <i>Do not enter suspend mode or power off the computer when this indicator is on.</i>
3 Numeric lock 	Green	The numeric keypad on the keyboard is enabled. You enable or disable the keypad by pressing and holding the Shift key, and pressing the NumLk key. For details, see “Numeric Keypad” on page 16.
4 Caps lock 	Green	The Caps Lock mode is enabled. All alphabetic characters (A–Z) are entered in capital letters without the Shift key being pressed. You enable or disable the Caps Lock mode by pressing the Caps Lock key.
5 Scroll lock 	Green	Scroll Lock mode is enabled. The Arrow keys can be used as screen-scroll function keys. The cursor cannot be moved with the Arrow keys. <i>Not all application programs support this function.</i> You enable or disable Scroll Lock mode by pressing the ScrLk key.
6 Suspend mode 	Green	The computer is in suspend mode. (See “Basic” in the <i>Online User's Guide</i> for details.)
	Blinking green	The computer is entering suspend mode or hibernation mode, or is resuming normal operation.
7 Power on 	Green	The computer is operational. This indicator is on when the computer is on and not in suspend mode.



Functions of Your Computer

Your computer features a diskette drive that is attached externally. Your computer also has unique keyboard functions and utility programs for easy configuration. This section describes the following features:

- External diskette drive
- Keyboard functions
- ThinkPad utility programs
- The *Online User's Guide*

Attaching the External Diskette Drive



You **do not** need to power off your computer. The computer will recognize the external diskette drive whenever you attach it to your computer.

- 1 Open the cover on the external-diskette-drive connector.

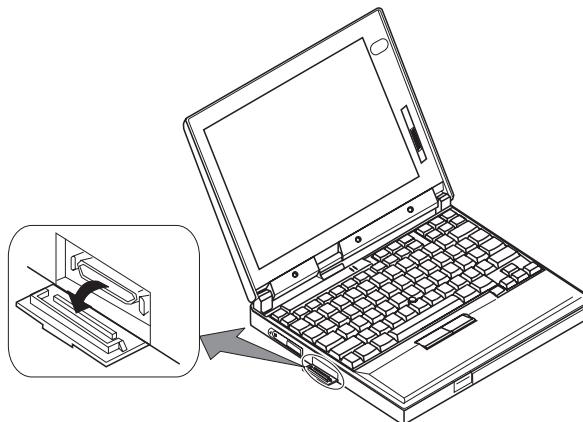

2 Attach the cable first to the external diskette drive; then attach it to the external-diskette-drive connector on the side of the computer.

Press the sides of the connector **1** as you connect it to the devices **2**.

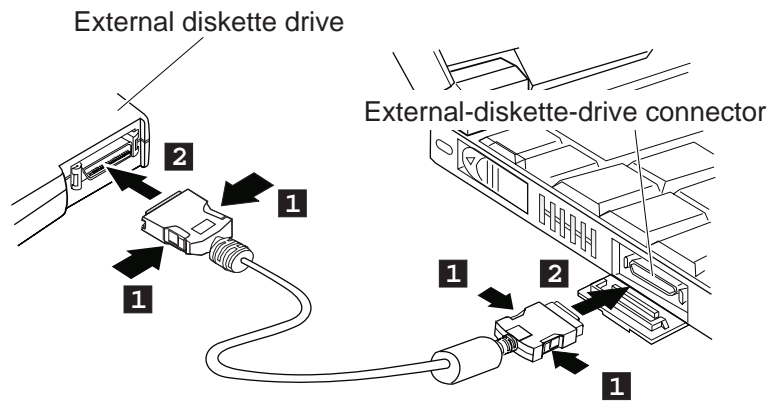



Functions of Your Computer



Keyboard Functions

Your computer's keyboard has the following functions:

- TrackPoint
- Fn key
- Numeric keypad

TrackPoint

The keyboard contains a unique cursor-pointing device called the *TrackPoint*. Pointing, selecting, and dragging all become part of a single process you can perform without moving your fingers from their typing position.



NOTE

You can set the following features by customizing the TrackPoint:

- Press-to-Select
- Sensitivity

For more information → “Customizing the TrackPoint” on page 36.



The TrackPoint consists of a **stick** on the keyboard and a pair of **click buttons** below the keyboard. Movement of the cursor on the screen is controlled by the amount of pressure you apply to the nonslip cap on the stick in any direction parallel to the keyboard; the stick itself does *not* move. The speed at which the cursor moves corresponds to the pressure you apply to the stick. The function of the click buttons corresponds to the left and right mouse buttons on a traditional mouse, and depends on the software you are using.

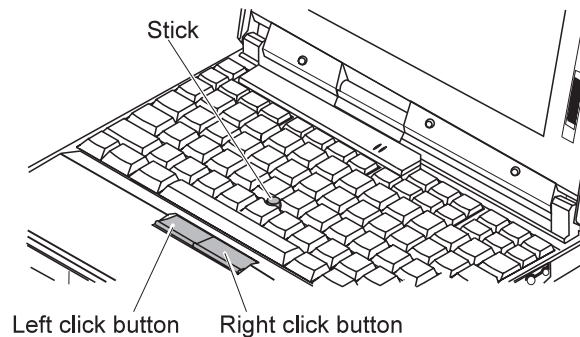

If you are not familiar with using the TrackPoint, these instructions will help you get started:

- 1** Place your hands in the typing position and press gently with either index finger on the stick in the direction you want the cursor to move.

Pressing the stick away from you moves the cursor up the screen; pressing it toward you moves the cursor down the screen. You can also move the cursor side to side by pressing sideways.

**NOTE**

The cursor might drift. This is not a defect. Do not use the TrackPoint until the cursor stops moving.



Functions of Your Computer

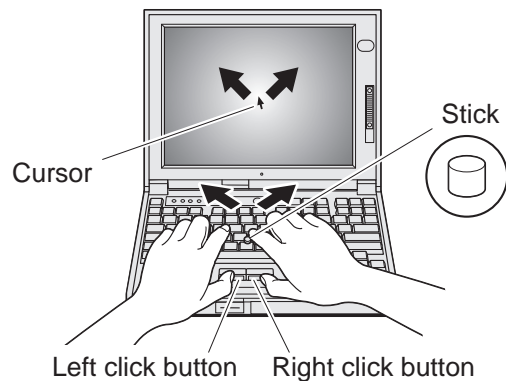

- 2 Press the click buttons with either thumb to select and drag as required by your software.

By enabling Press-to-Select, you can make the TrackPoint stick function the same as the left or right click button. For more information → “Customizing the TrackPoint” on page 36.



Changing the Cap

The cap 1 on the end of the TrackPoint stick is removable. You can replace it with one of the spares shipped with your computer.

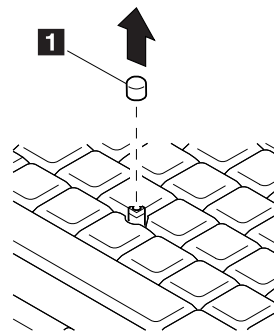

Fn Key

The **Fn** key function allows you to change operational features instantly. When you use the following functions, press and hold the **Fn** key **1**; then press the appropriate function key **2** (**F1** to **F12**, **PgUp**, **PgDn**, or **BackSpace**).

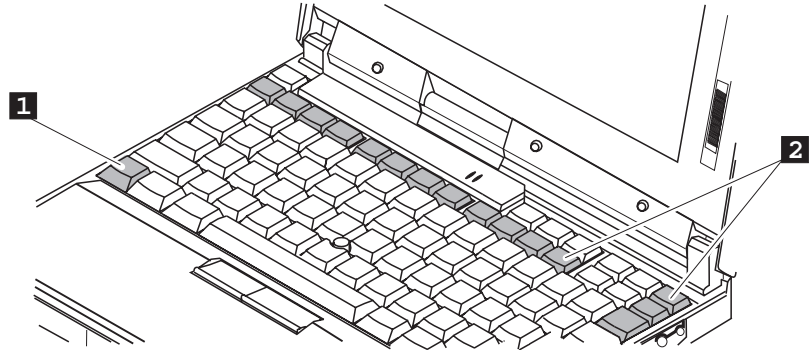

The Fn Key Lock Function

The following setup gives you the same effect as when you press and hold the **Fn** key and then press an appropriate function key.









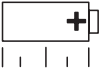
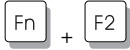

Start the ThinkPad Configuration program. (See “ThinkPad Configuration Program” on page 25.) Click on the **Accessibility** () button, and click on **Enable for Fn key lock**. You can also set up by typing `PS2 FNS E` at the command prompt.

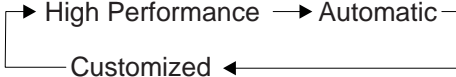
After you enable the **Fn** key lock and press **Fn** *once*, press one of the function keys. The computer works the same as when you press **Fn** + the function key.

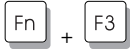

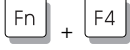



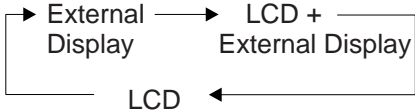



If you press **Fn** *twice* after enabling the lock, pressing a function key alone is recognized as a combination of **Fn** + that function key. To stop this function, press **Fn** again.

Functions of Your Computer

The following table shows the function of the **Fn** key combined with keys:

Feature and icon	Key Combination	Meaning
Power Mode Functions		
Fuel-Gauge display on or off 	 (Only for OS/2 or Windows users)	If you press this key combination, the window for the battery status appears or disappears. You can set parameters for battery status in the window. Note: The Fuel-Gauge program must be activated before you can use this key combination. To activate the Fuel-Gauge program, do the following: <ol style="list-style-type: none"> 1. Click on Start. 2. Move the cursor to Programs, ThinkPad, and then click on Fuel.
Power mode switching 		During battery-power operation, the processor speed changes as follows: 
Power Conservation Functions for Battery Power		
Standby mode 		The computer enters standby mode. For more information about this mode → "Basic" in the <i>Online User's Guide</i> .
Suspend mode 		The computer enters suspend mode. For more information about this mode → "Basic" in the <i>Online User's Guide</i> .
Hibernation mode 		The computer enters hibernation mode. For more information about this mode → "Basic" in the <i>Online User's Guide</i> .
Other Functions		
Switching between the LCD and the external monitor 		Computer output is displayed in the following order when an external monitor is attached. 

Functions of Your Computer

Feature and icon	Key Combination	Meaning
Screen expansion	 + 	The LCD screen image size switches between expanded and normal mode if the size of your LCD image is smaller than that of the physical LCD.
Volume up 	 + 	The volume increases.
Volume down 	 + 	The volume decreases.
Mute 	 + 	Sound turns off. Note: To turn on the sound, press Fn + PgUp or Fn + PgDn .



When the computer is in suspend mode and you press the **Fn** key independently without any function key, the computer returns to normal operation.

Functions of Your Computer

Numeric Keypad

The keyboard has some keys that, when enabled, work as if they were a 10-key numeric keypad. (The numeric keypad on the keyboard is not active when the external keyboard or the external numeric keypad is attached to the computer.)

To enable or disable the numeric keypad, press and hold **Shift** and then press **NumLk**.



NOTE

The functions of the numeric keypad are printed on the front of the keys.

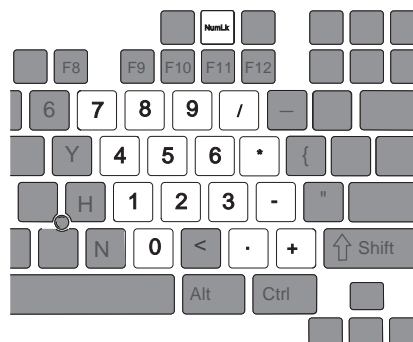

If the numeric keypad is enabled, press and hold **Shift** to temporarily use the cursor- and screen-control keys.



NOTE

The functions of the cursor- and screen-control keys are not printed on the keys.

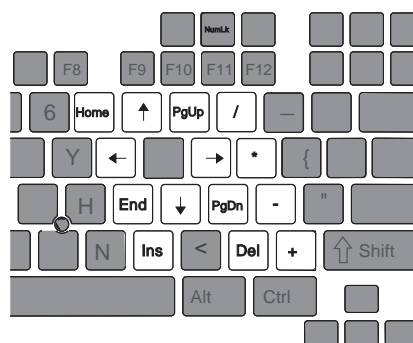

ThinkPad Utility Programs

Your computer has the following utility programs for easy configuration:

Easy-Setup
ThinkPad Configuration program

This section summarizes these utility programs.

Easy-Setup

Your computer provides a user-friendly program called *Easy-Setup*, which allows you to select various setup parameters:

Config: Set the configuration of your computer.

Date/Time: Set the date and time.

Password: Set a password.

Start up: Set the startup device.

Test: Test the system.

Restart: Restart the system.

To start Easy-Setup, do as follows:

- 1** Power off the computer, and remove any diskette from the diskette drive.
- 2** Press and hold **F1**; then power on the computer. Hold **F1** until the "Easy-Setup" menu appears:

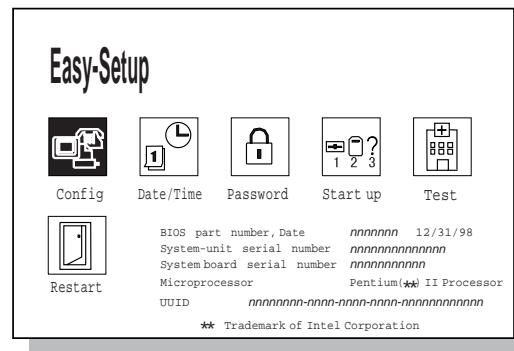

- 3** Move to an icon you want to change, using the arrow keys or the TrackPoint, and click on the icon.

A submenu is displayed.



Functions of Your Computer



4 Change the items you wish to change.

5 Click on **Exit** to exit from the submenu.

6 Click on **Restart** to exit from the “Easy-Setup” menu.

Your computer restarts.



Changing the Screen Color

You can change the color of the “Easy-Setup” menu by pressing the **Ctrl+PgUp** keys or by pressing the **Ctrl+PgDn** keys.

To return to the original color, press the **Ctrl+Home** keys.

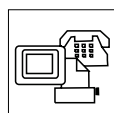

Config

Clicking on the **Config** button displays the following “Config” submenu, which provides information about the installed memory and system board:

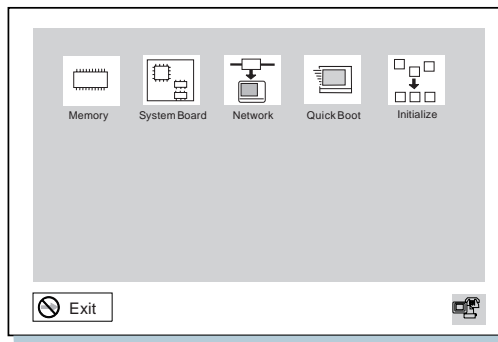

The **Memory** button shows the amount of memory installed and available.



The **System Board** button provides information on the system board installed.



The **Network** button enables or disables the Wake on LAN and Flash over LAN function. You can use these functions only with the ThinkPad Port Replicator with Advanced EtherJet Feature (option).





The **Quick Boot** button enables or disables the Simple Boot Flag function.



Simple Boot Flag function

This function automatically optimizes the behavior and boot performance of the BIOS and operating system, based on the installed operating system and previous boot.

If this function is **Enabled** and once a Plug and Play–capable operating system is installed, the system BIOS does not configure such hardware resources as system interruptions, memory windows, and I/O port ranges for all the devices in the system.

If you are going to use a non–Plug and Play–capable operating system, disable this function so that the BIOS will configure hardware resources.



The **Initialize** button sets all device settings to their default values.

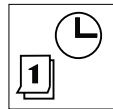

Date/Time

Clicking on the **Date/Time** button displays the following “Date and Time” submenu, which you can use to set the current date and time:

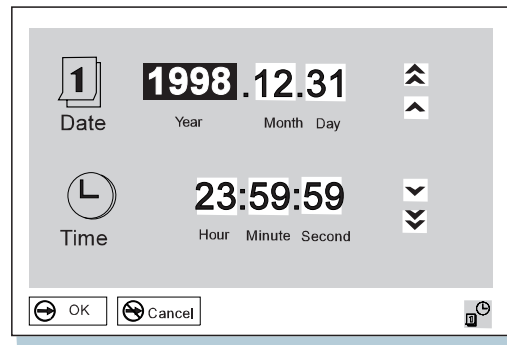



Functions of Your Computer



To change the date and time, do the following:

- 1 Move the cursor to any field (Year, Month, Day, Hour, Minute, Second); then type the date and time.



Instead of typing, you can place the pointer on any of the arrow icons (↕, ▲, ▼, or ⇅) to adjust the date and time. Clicking on the double-arrow icon scrolls the numbers faster.

- 2 Click on **OK** to save the changes or on **Cancel** to cancel them.



You can also set the current date and time with the application included with the operating system installed in your computer.



Password

Clicking on the **Password** button displays the “Password” submenu, which you can use to set the power-on password, hard-disk password, and supervisor password. For more information → “Using Passwords” on page 68.



An open lock icon shows that a password has not been set yet.

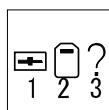

Start up

Clicking on the **Start up** button displays the “Start up” submenu, which you can use to change the startup or boot sequence.

For example, if you have different operating systems on different replaceable hard disk drives or PC cards, you can have the system boot up from one of these devices.



ATTENTION

You must be extremely careful not to specify a wrong device during a copy, save, or a format operation after you change your startup sequence. If you specify a wrong device, your data and programs might be erased or overwritten.

To change the startup sequence, do the following:

- 1 Click on **Start up** in the “Easy-Setup” menu. The “Startup” submenu appears:

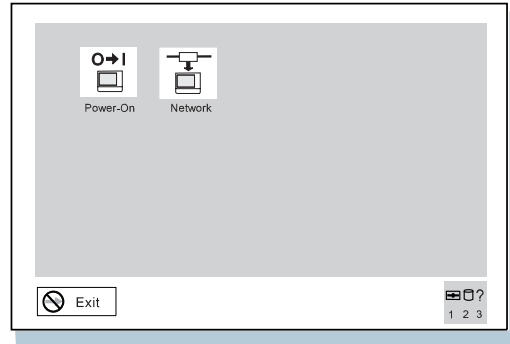
**Note:**

The **Power-On** button sets the startup sequence when the power switch is set to ON.



The **Network** button sets the startup sequence when Wake on LAN is started. Wake on LAN is typically used by LAN administrators in corporate networks to access your computer remotely. This function can be used only with the ThinkPad Port Replicator with Advanced EtherJet Feature (option).

Functions of Your Computer

2 Click on one of the following:

Power-On in the submenu.

The "Power-On" submenu appears:

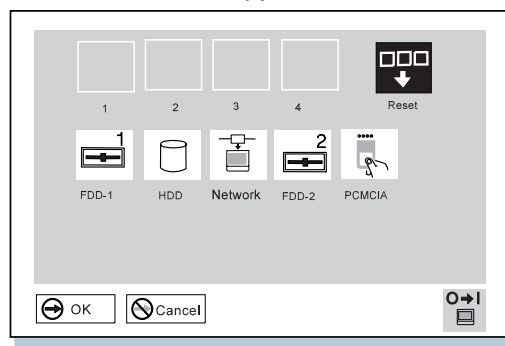

The **FDD-1** icon is the diskette drive in the computer. If you have an additional diskette drive connected to a port replicator, that drive becomes **FDD-2**.

Network in the submenu.

This function can be used only with ThinkPad Port Replicator with Advanced EtherJet Feature (option).

The “Network” submenu appears, where you can enable or disable the Wake on LAN function:

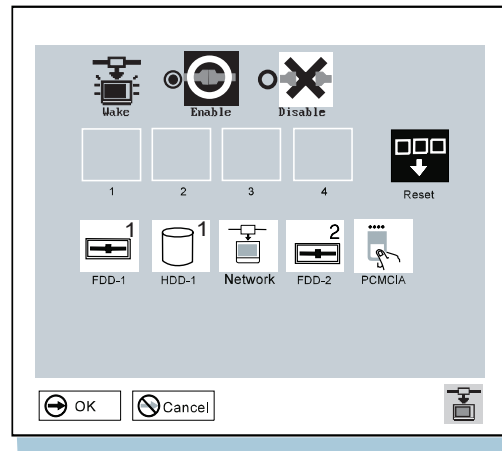

If Wake on LAN is enabled, the network administrator can power on remote machines connected in a LAN using remote network-management software. Disable the function if your computer is not under system management of a network administrator.

For more information → “System Management” in the *Online User's Guide*.

3 Move the cursor to the **Reset** icon, and click on it.



Functions of Your Computer



- 4 Select the first device you want for the startup sequence; then click on it.

The device moves up to box 1. You cannot set a hard disk drive before a PC Card.

If you are using a **remote program loading (RPL) system** through a token-ring card or some other network card, do the following:

- a Select **Network** in either the Power-On or the Network submenu, and click on it. The "Speed" menu appears.
- b If you are using a token-ring card, select the speed you want (**4** or **16**), and click on it; then press **Enter**.

If you are using a network card other than a token-ring card, such as an Ethernet card, you need not specify the RPL speed. Press **Esc** to exit this menu.

- 5 Repeat these steps for the other devices. You can set up to four devices.

- 6 Click on **OK** or press **Enter** to save the changes.

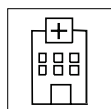

Test

Pressing the **Test** button displays the "Test" submenu. It is used to run diagnostic tests on your computer to check for hardware errors. For more information → "Testing Your Computer" on page 131.

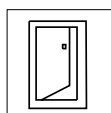

Restart

Pressing the **Restart** button ends the Easy-Setup program and restarts the computer.



ThinkPad Configuration Program



To get specific details about ThinkPad Configuration program, click the help button.

The ThinkPad Configuration program allows you to set up and customize the computer's built-in devices to your needs. For example, you can enable or disable a port, switch between your computer's LCD and an external monitor, and set the power management mode.

This section describes how to start the ThinkPad Configuration program.



For Windows 98:

To start the ThinkPad Configuration program for Windows 98, find the ThinkPad icon on the bottom right of the taskbar ¹; then double-click on the icon.



You can also start the ThinkPad Configuration program as follows:

1. Click on **Start** ().
2. Move the cursor to **Programs, ThinkPad**; then click on **ThinkPad Configuration**.

Functions of Your Computer

The following window appears:



- 1 The **Display Device** buttons. Click on one of these buttons to set the display output type to the LCD, external monitor, or both.
- 2 The **Power Scheme** buttons change the preset power options.
- 3 The **Launch Device Manager** button displays the “System Properties” window, where you can make a device available or unavailable.
- 4 The **Show Allocated Resources View** button displays the “Allocated Resources View” window, where you can check the memory addresses and other allocation settings.
- 5 The **Help** button displays online help.
- 6 The **Device** buttons. Click on the button of your choice from the window. If the device is enabled, the red indicator next to the button is lit. Otherwise, it stays off.



For Windows NT:

To start the ThinkPad Configuration program for Windows NT, do as follows:

- 1** Click on **Start** at the bottom corner of the screen.
- 2** Move the cursor on **Programs, ThinkPad**; then click on **ThinkPad Configuration**.

The following window appears:

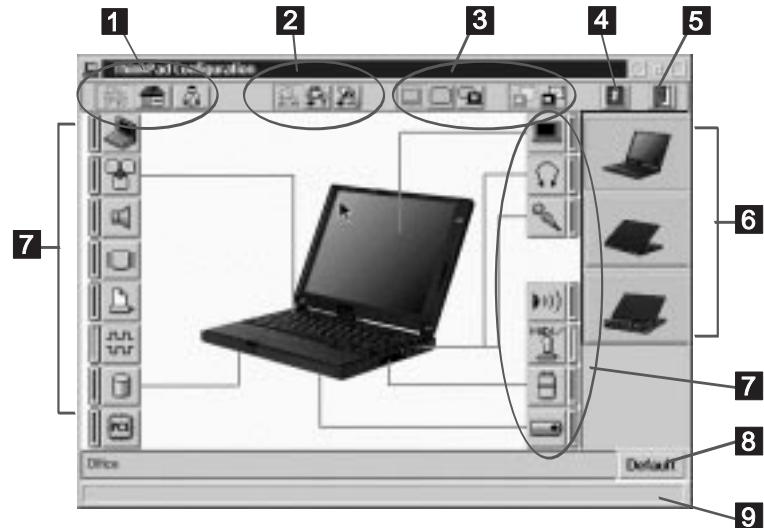

- 1** The **One-Touch Setup** buttons. Click on one of these buttons to set the system configuration.
- 2** The **Power Mode** buttons. Click on one of these buttons to set the power mode to High Performance mode, Automatic mode, or Customized mode.
- 3** The **Display Device** buttons. Click on one of these buttons to set the display output type to the LCD, external monitor, or both. When making a presentation, you can click on the presentation button to disable any system timers, such as the LCD turn-off timer or the power management mode timers.
- 4** The **Help** button displays online help.



Functions of Your Computer



- 5 The **Exit** button. Click on this button to save the changes you made and to exit the ThinkPad Configuration window.
- 6 The **View Angle** buttons. Click on the front view or the rear view (with or without the port replicator) buttons to display the hardware feature locations.
- 7 The **Device** buttons. Click on the button of your choice from the window; then set the options for that device from the window that appears. If the device is enabled, the red indicator next to the button is lit. Otherwise, it stays off.
- 8 The **Default** button. Click on this button to set the default values for each option and to cancel the changes you just made.
- 9 The **Status** bar. The device name and its status appears in the status bar when you place the cursor on a device button.

Only the top portion of the window is displayed when you click on the minimize button in the top-right corner.



Online User's Guide

Your computer features an *Online User's Guide*, so that you will always have key information at your fingertips even if you are traveling. It contains the following information:

Basic:

- Using your computer outside your country
- Using the audio features
- Using your computer with a PC Card
- Using your computer with a battery pack

Advanced:

- Installing software
- Using system management
- Frequently Asked Questions

To start the *Online User's Guide*, click on **Start**, move the cursor to **Programs** and **ThinkPad 560**; then click on **ThinkPad 560 User's Guide**.

The *Online User's Guide* appears. Go to the section you want, and make a printout if necessary.



NOTE

You can start the *Online User's Guide* from the ThinkPad Customization CD as follows:

1. From the ThinkPad Customization Center main menu, click on **Online Library**.
2. Click on **Click here to launch the Online User's Guide**.

You can also access the *Online User's Guide* from the IBM Web site.

Backing Up Your System

Backing Up Your System



You need an external CD-ROM drive to use the ThinkPad Customization CD and the Recovery CD. Use a CD-ROM drive that is compatible to your computer.

To back up your system or reinstall the operating system, your ThinkPad computer has the following features:

- The ThinkPad Customization CD
- The Recovery CD
- The Diskette Factory program
- ConfigSafe
- The ThinkPad Web site or bulletin board

For more information about recovering lost or damaged software → “Recovering Lost or Damaged Software” on page 133.

ThinkPad Customization CD

You can customize your system using this CD. It contains all the software applications and hardware device drivers for your computer. It also contains device drivers and installation instructions for other operating systems such as Windows NT (To use the ThinkPad Customization CD → “Using the ThinkPad Customization CD” on page 133.)

Recovery CD

If you accidentally erase your hard disk, you can use the Recovery CD to restore the contents of the preinstalled hard disk to what it was at the time of purchase. (To use the Recovery CD → “Using the Recovery CD” on page 135.)

Diskette Factory

The Diskette Factory program contains all the hardware device drivers for your computer.

With this program, you can create the utility and device driver diskettes. (To use the Diskette Factory → “Using the Diskette Factory” on page 133.)

For more information about installing a new operating system (such as Windows NT) and device drivers → “Advanced” in the *Online User's Guide*.

ConfigSafe

ConfigSafe is an application program for Windows 98, Windows 95, or Windows NT that periodically takes *snapshots* of your system files. If your computer does not operate properly after you install a new device driver or software, use ConfigSafe to restore the last working version of your system files. Although it might not make your new hardware or software work, it will set your computer up and running again. This application protects your data.

ThinkPad Web Site or Bulletin Board

IBM supplies all of the latest hardware device drivers and system BIOS for your computer on the ThinkPad Web site:
<http://www.ibm.com/thinkpad>

You can also use the IBM bulletin board service.

For more information about electronic service and support →
Chapter 5.



Replacing the Battery Pack



Replacing the Battery Pack

To replace the battery pack, do as follows:



NOTE

You can replace the battery when the computer is in hibernation mode. (You cannot replace it when the computer is in suspend mode.) If you are using a PC Card, however, the computer might not be able to enter hibernation mode. If this happens, power off the computer.

- 1** Power off your computer, or enter hibernation mode.
- 2** Close the LCD and turn the computer over.
- 3** Slide the battery pack latch **1** ; then slide the battery pack toward the front of the computer and remove the battery pack.

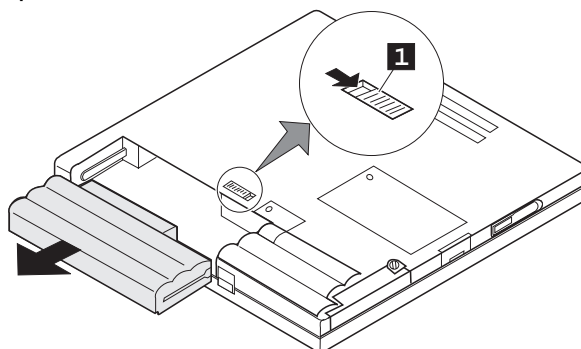

Replacing the Battery Pack

- 4** Align the guides on the fully charged spare **1** with the guides on the computer **2** ; then slide the battery pack into the computer.

Fully press the battery pack into the computer. When it is fully installed, the battery pack latch **3** automatically locks into place.

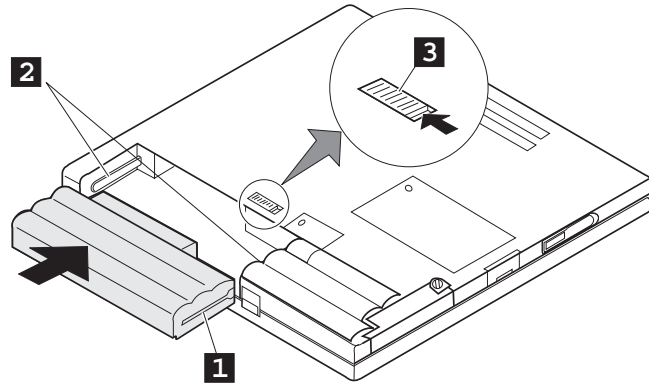

- 5** Turn the computer over again; then power on.
You have finished replacing the battery pack.



Replacing the Battery Pack



Chapter 2

Extending the Features of Your Computer

This chapter provides information about how to attach external devices or to increase memory.

Customizing the TrackPoint	36
Increasing Memory	39
Installing the DIMM	40
Removing the DIMM	43
Upgrading the Hard Disk Drive	45
Attaching an External Mouse, Keypad, and Keyboard	47
Attaching an External Mouse or Numeric Keypad	47
Attaching an External Keyboard and Mouse	49
Disabling the TrackPoint	51
Attaching an External Monitor	52
Installing a PC Card	56
Removing the PC Card	59
Installing the PC Card Modem	60
Using a Port Replicator	63
Enabling the CardBus Sockets (for Windows 98)	65



Customizing the TrackPoint



Customizing the TrackPoint

You can customize the TrackPoint by doing the following:

- 1 Start the ThinkPad Configuration program.
- 2 Click on the **TrackPoint** button ().
- 3 Click on **TrackPoint Properties...**

The "TrackPoint Properties" window appears:

You can set the following features in this window:

- Press-to-Select
- Sensitivity

Setting Press-to-Select



If you enable Press-to-Select by putting a check mark in the **Enable Press-to-Select** box, you can make the TrackPoint stick function the same as the left or right click button.



Customizing the TrackPoint

If you check **Enable dragging**, you can drag the icon that you select with the TrackPoint stick by putting light pressure on the stick.

If you check **Enable Release-to-Select**, you can click simply by lifting your finger quickly off the TrackPoint. Moving the cursor onto an icon and then lifting your finger off the TrackPoint works like clicking. Pressing the TrackPoint again works like double-clicking.

Click on one of the **Press means** radio buttons to select which button the stick will simulate: either the left or the right button. For example, if you select **Left Click**, you can start a program with the TrackPoint by putting the cursor on the program's icon and applying light pressure on the stick.

To adjust the pressing timing of the stick, set **Click Pace**.



NOTE

If you set the pace too slow, you might notice unintended clicks, a cursor delay, or a dragging delay. However, if you set the pace too fast, you might find Press-to-Select hard to use.



Customizing the TrackPoint



Setting Sensitivity



This function adjusts the force required for both cursor movement and Press-to-Select. Slide toward **Firm Touch** to increase the force needed to move the cursor and to activate Press-to-Select. Slide toward **Light Touch** to decrease the force needed to move the cursor and to activate Press-to-Select.



Increasing Memory

Increasing memory capacity is an effective way to make programs run faster. You can increase the amount of memory in your computer by installing a *dual inline memory module (DIMM)*, available as an option.

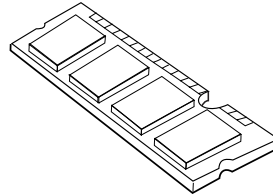

Different capacities of DIMM (up to 64 MB) are available. You can install a DIMM directly in the memory slot on the bottom of the computer. Your computer memory capacity can be expanded up to 96 MB (32-MB base memory and a 64-MB DIMM option) or 128 MB (64-MB base memory and a 64-MB DIMM option).



Your computer supports the 60-ns extended data output dynamic random access memory (EDO DRAM) card only. It does not support the 70-ns EDO DRAM card or the synchronous dynamic random access memory (SDRAM) card. The appropriate memory option can be purchased through your IBM reseller or IBM marketing representative.

Increasing Memory

Installing the DIMM

To install the DIMM, do the following:

- 1** Power off the computer; then disconnect the AC Adapter and all cables from the computer.
- 2** Close the LCD, turn the computer over, and then remove the battery pack.
- 3** Loosen the screw on the memory slot cover; then remove the cover.

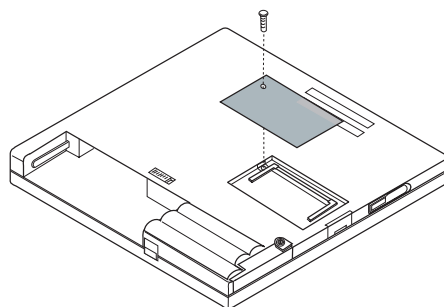

ATTENTION

To avoid damaging the DIMM, do not touch its contact edge.

4 Install the DIMM into the memory slot.

- a** Find the notch on the side of the DIMM.
- b** With the notched end of the DIMM toward the right side of the socket, insert the DIMM, at an angle of approximately 20°, into the socket; then press it firmly **1**.
- c** Pivot the DIMM until it snaps into place **2**.

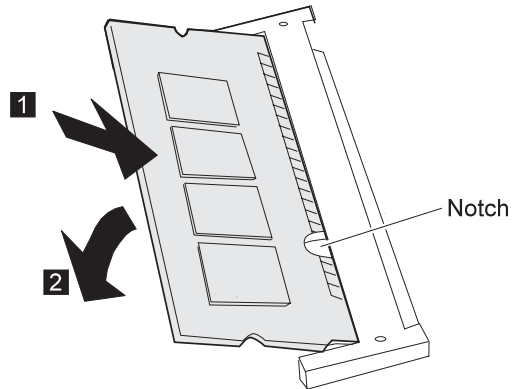

Side View

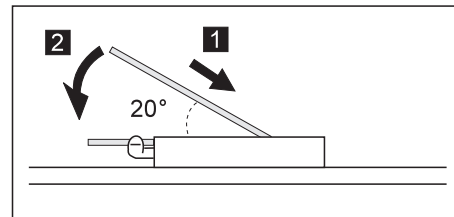

Increasing Memory

5 Replace the memory slot cover over the memory slot, aligning the back side of the cover first; then tighten the screw.

6 Replace the battery pack.

7 Turn the computer over again and power it on. Then confirm that the new memory size appears at the upper left corner of the screen.

For example, if you install a 32-MB DIMM into your computer with 32-MB base memory, you should see the following. (See the next page for how to calculate the total memory size.)

```
6496 KB OK
```

You have finished installing the DIMM. Reconnect all cables.



NOTE

1. For the following status, turn off the computer and go to page 40 to reinstall the DIMM and do the memory test with Easy-Setup (see page 24).

If a 2 1 error code appears under the memory count.

```
48576 KB OK  
2 1
```

If the total memory size is not the same as the value you calculated.

If the 225 error code appears, the memory you are installing is not supported by your computer.

2. If you changed the memory installed in the computer, you need to create a new hibernation file as follows:

- a) Power off the computer.
- b) Remove the DIMM you added.
- c) Power on the computer and disable hibernation mode.
- d) Add the DIMM.
- e) Enable hibernation mode.

To disable and enable hibernation mode → “Basic” in the *Online User's Guide*.



How to Calculate Total Memory Size

Calculate your total memory size in kilobytes (KB) by adding the DIMM memory size to the base memory size (32192 KB).

For example, if you installed a 32-MB DIMM into your computer with 32-MB base memory, you should have about 64 MB.

Your computer might display memory size in kilobytes. For example, 64 MB=64960 KB.

Note: 576 KB is reserved by the system.

Removing the DIMM

- 1** Power off the computer and disconnect the AC Adapter and all cables from the computer.
- 2** Close the LCD, turn the computer over, and then remove the battery pack.
- 3** Loosen the screw and remove the memory slot cover.

Increasing Memory

- Press out on the latches on both edges of the socket at the same time.

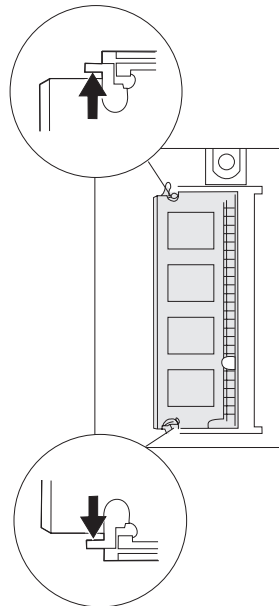

- Remove the DIMM.
Be sure to save the DIMM for future use.
- Replace the memory slot cover; then tighten the screw.
- Replace the battery pack.
- Turn the computer over again; then connect the AC Adapter and all the cables you disconnected.

Upgrading the Hard Disk Drive

You can increase the storage capacity of your computer by replacing the original, built-in hard disk drive with an optional one. You can purchase the option from your IBM reseller or IBM marketing representative.

**NOTE**

Replace the hard disk drive only if you upgrade it or have it repaired. **You should not replace it often.**

**ATTENTION****Handling a Hard Disk Drive**

- Do not drop or apply any shock.**
- Do not apply pressure to the cover.**
- Do not touch the connector.**

The drive is very sensitive. Incorrect handling can cause damage and permanent loss of data on the hard disk. Before removing the hard disk drive, make a backup copy of all the information on the hard disk. Never remove the drive while the system is operating, in suspend mode, or in hibernation mode.

To replace the hard disk drive, do the following:

- 1** Power off the computer; then disconnect the AC Adapter and all cables from the computer, and turn the computer upside down.
- 2** Remove the battery pack. (→ page 32.)



Upgrading the Hard Disk Drive



- 3 Remove the coin screw by rotating it counterclockwise with a coin, as shown 1 ; then remove the hard disk drive cover 2 .

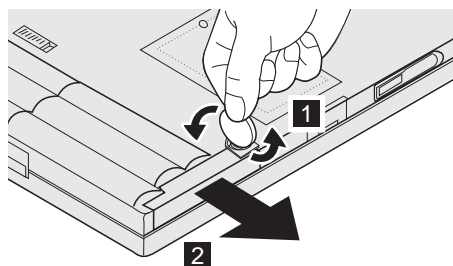

- 4 Pull the strap of the hard disk drive to remove the drive.

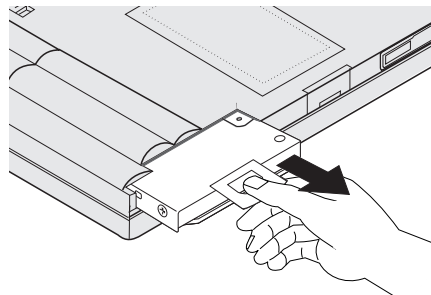

- 5 Insert the new hard disk drive into the bay. Make sure you connect the drive firmly.



Do not use force when inserting the hard disk drive into the bay. The connector is sensitive, and it might get damaged.

- 6 Replace the hard disk drive cover, and reinstall the screw.

- 7 Put the battery pack into your computer. (→ page 32.)

- 8 Turn the computer right-side up, and power it on.



You can replace the coin screw with a security screw to prevent the hard disk drive from being removed easily. For more information → “Using the Security Screw” on page 85.



Attaching External Mouse, Keypad, and Keyboard

Attaching an External Mouse, Keypad, and Keyboard

This section explains how to attach an external mouse, external numeric keypad, and external keyboard to your computer.

Attaching an External Mouse or Numeric Keypad

You can attach an external mouse or numeric keypad to the external-input-device connector () on the rear of the computer.

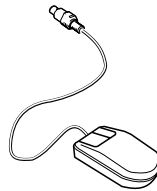

Mouse

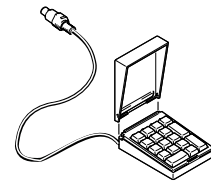

Numeric Keypad

If you want to attach the mouse, attach it directly to the external-input-device connector as shown:

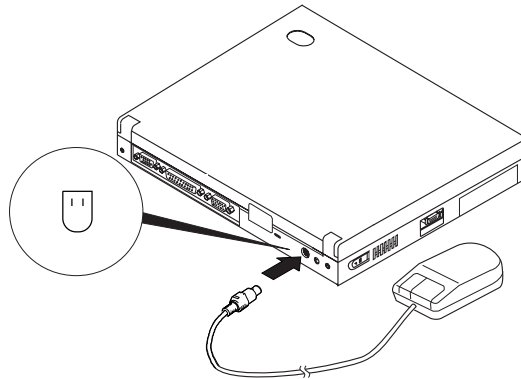

Attaching External Mouse, Keypad, and Keyboard



ATTENTION

You can use both the IBM PS/2 Miniature Mouse and the TrackPoint as an input device. To connect a mouse other than an IBM PS/2 Miniature Mouse → "Disabling the TrackPoint" on page 51.

If you want to use both the external numeric keypad and mouse at the same time, first connect the keypad cable to the computer; then connect the mouse cable 1 to the connector at the rear of the keypad.

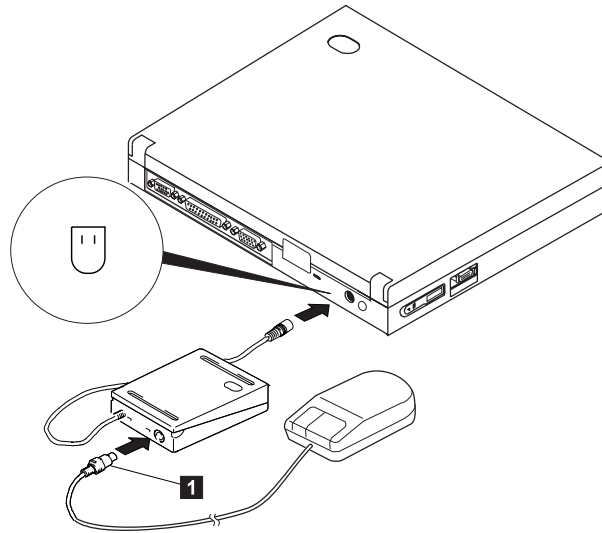

NOTE

You can remove the keypad cover and use it as a stand for the keypad.

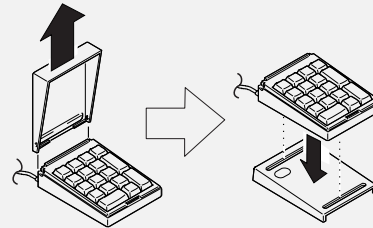

Attaching External Mouse, Keypad, and Keyboard

Attaching an External Keyboard and Mouse

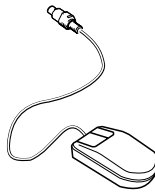

Mouse

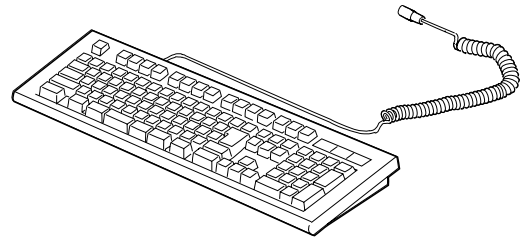

External Keyboard

If you want to attach an external keyboard to your computer, do the one of the following:

- Use the optional keyboard/mouse cable.
- Use an optional port replicator.

The external keyboard will not work if it is connected directly to the computer's external-input-device connector.

See the *Options by IBM Catalog* supplied with your computer for details about the options.

When the external keyboard is attached, the following keys are not available:

- Numeric keypad on the computer keyboard
- External numeric keypad

Instead, use the numeric keypad on the external keyboard.

Attaching External Mouse, Keypad, and Keyboard

To attach the external keyboard, power off the computer, attach the keyboard to the keyboard connector of the keyboard/mouse cable 1 , and then attach the keyboard/mouse cable to the computer 2 .

You can attach a mouse to the mouse connector of the keyboard/mouse cable.

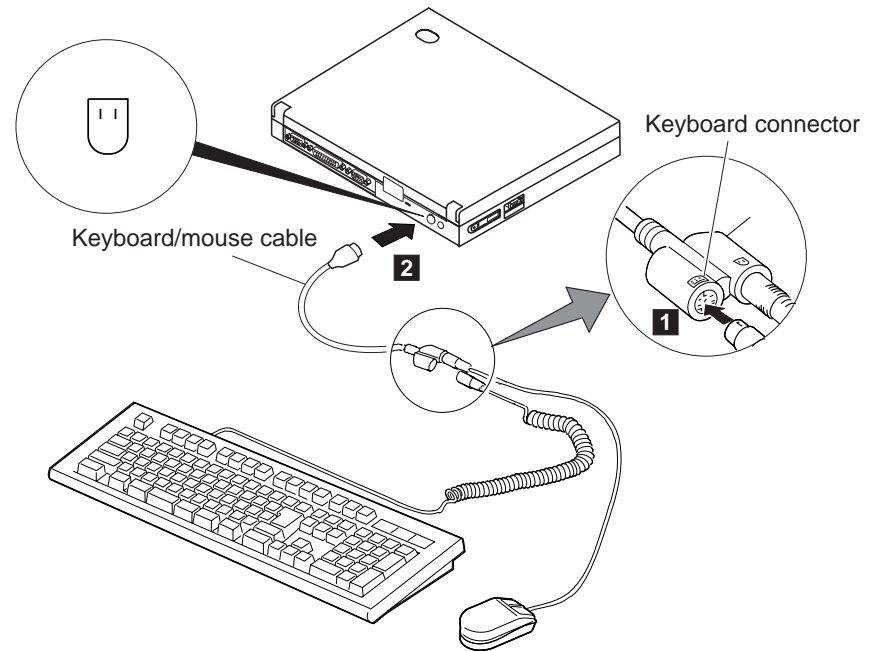

Using the IBM ThinkPad Space Saver Keyboard

If you are using the IBM ThinkPad Space Saver Keyboard, **do not** install the device driver supplied with the keyboard. The device driver on the computer's utility diskette automatically enables or disables the TrackPoint when the power to the computer is turned on.

Attaching External Mouse, Keypad, and Keyboard

Disabling the TrackPoint

The TrackPoint is designed to work simultaneously with another pointing device (such as a mouse) attached to the system. But some mouse types require the TrackPoint to be disabled before you can use them, such as:

- A mouse that is not fully compatible with the PS/2 mouse connected to the external-input-device connector

- A mouse connected to the serial connector

- A mouse connected to the USB connector

To disable the TrackPoint:

- 1** Start the ThinkPad Configuration program.

See "ThinkPad Configuration Program" on page 25.

- 2** Click on the **TrackPoint** () button.

- 3** Click on **Auto-Disable** for the TrackPoint.

This setting automatically disables the TrackPoint whenever a mouse is connected to the external-input-device connector. If no external mouse is connected, the TrackPoint is enabled.



If you use a mouse connected to the serial connector or the USB connector, you need to select **Disable**, instead of **Auto-Disable**.



Attaching an External Monitor



Attaching an External Monitor

This section provides information about using the computer LCD and an external monitor. The LCD of your computer displays in SVGA (800-by-600 resolution) video mode and 16M colors.

If you attach an external monitor that supports resolution higher than VGA mode, you can achieve a maximum of 1024-by-768 video resolution.

To attach an external monitor, do the following:

- 1** Power off the computer.
- 2** Connect the external monitor to the external-monitor connector () on the rear of the computer; then connect the monitor to an electrical outlet.
- 3** Power on the external monitor and the computer.





**ATTENTION**

Do not change the display output location while a moving picture is being drawn—for example, playing a movie or a game. Stop the application before changing the display output location.

4 Start the ThinkPad Configuration program.

See “ThinkPad Configuration Program” on page 25.

5 Change the display output location by clicking on the **LCD + External Display** () button or the **External Display** () button (with Windows 98, at the *top left* of the screen; with Windows NT, a little to the *right of the top center* of the screen).**ATTENTION**

If you are attaching an external monitor that supports only VGA mode (640-by-480 resolution), do **not** click on **LCD + External Display**. Doing so would cause the external monitor screen to be scrambled and the output not to be displayed; in addition, the screen might become damaged. Use **External Display** instead.

**NOTE**

You can also change the display output location by pressing **Fn+F7**.

6 Set your monitor type and display device driver as follows.**NOTE**

For information on the supported color depths and resolutions, → “Resolutions, Color Depths, and Frame Rates” on page 54.



Attaching an External Monitor



- a) Start the ThinkPad Configuration program.
- b) Click on the other **External Display** () button (on the *right* side of the screen).
- c) Click on the **Advanced...** button.
- d) Click on the **Monitor** tab.
- e) Click on the **Change...** button.

The "Update Device Driver Wizard" window appears. Follow the instructions on the screen to select your monitor type from the monitor list, or click on a new resolution and refresh rate.

7 Restart the computer to make the changes effective.



Do not disconnect the external monitor while the computer is in suspend mode or hibernation mode. If no external monitor is attached when the computer resumes, the LCD remains blank and output is not displayed. This restriction does not depend on the resolution value.

Resolutions, Color Depths, and Frame Rates: The following tables show the resolutions, color depths, and frame rates available with your computer or external monitor. Use these tables to set the display output (**LCD**, **External Display**, or **LCD + External Display**).



When installing an operating system, you must install the display driver supplied with the computer to use SVGA mode.



Attaching an External Monitor

Displaying output on the LCD or on both the LCD and the external monitor (**LCD** or **LCD + External Display**)

Resolution	Supported Color Depth
640x480	16, 256, 64K, and 16M
800x600	256, 64K, and 16M
1024x768 (virtual screen)	256 and 64K



NOTE

You can use the *virtual screen* function, available with the ThinkPad Configuration program, to display a part of the high-resolution screen image produced by your computer. You can see other parts by moving the screen with the TrackPoint or other pointing device.

Displaying output on the monitor (**External Display**)

Resolution	Supported Color Depth	Frame Rate
640x480	256	60 Hz, 75 Hz, or 85 Hz
	16M	
	64K	
800x600	256	60 Hz, 75 Hz, or 85 Hz
	64K	
	16M	
1024x768	256	60 Hz, 70 Hz, or 75 Hz
	64K	



NOTE

If you are using an old external monitor, the resolution and refresh rate might be limited.



Installing a PC Card



Installing a PC Card

This section describes how to install a PC Card.

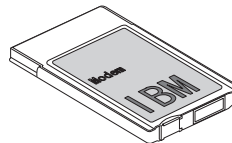

ATTENTION

Do not insert a PC Card while the computer is in suspend mode. Otherwise, the system might hang.

Your computer has two PC Card slots (upper slot and lower slot) and supports the following types of cards:

- PC Card (Type I, Type II, and Type III)
- CardBus
- Zoomed Video (ZV)

1 Find the notched edge 1 of the PC Card as shown.

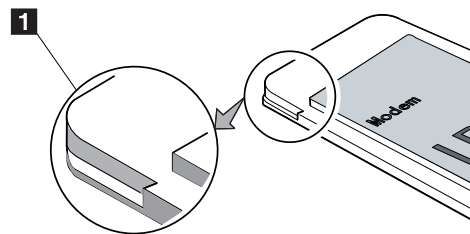

2 Insert the PC Card into the appropriate slot according to your PC Card type.



NOTE

If you are using a PC Card with an XJACK** connector, insert it into the upper slot.

If you are using a Type I or Type II PC Card, insert it into either the upper slot or the lower slot.

If you are using a Type III PC Card, insert the card into the lower slot.



Installing a PC Card

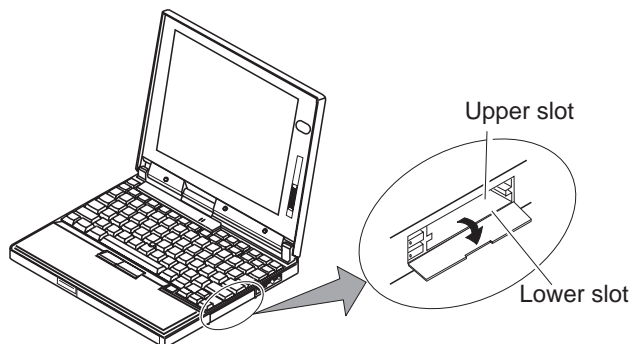

- 3** Press the PC Card firmly into the connector until the eject button pops out. Then pull the eject button out slightly **1** and fold it toward you **2**.

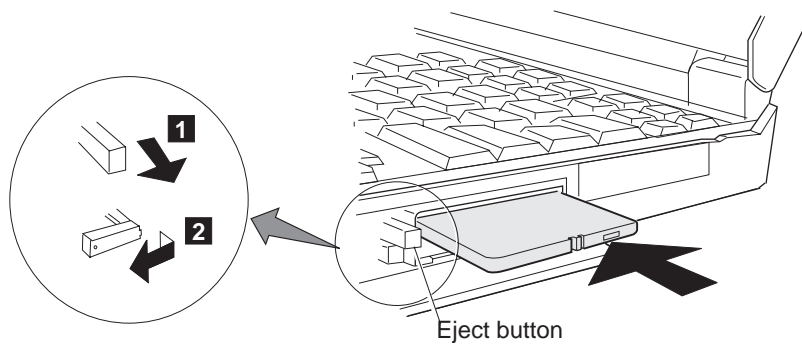

Installing a PC Card



For Windows 98:

If you have not installed the PC Card driver, Windows 98 starts "PCMCIA Card Services Wizard" to install it. Follow the instructions on the screen.

For Windows NT:

Your computer has PC Card support software called CardWizard. You can use the PC Card as soon as you insert the card into the computer. The "SystemSoft CardWizard" window appears and informs you about the new card.

You have completed setting up the PC Card, and you can now use it. For information on how to use the PC Card software → "Basic" in the *Online User's Guide*.

Removing the PC Card

Before removing a PC Card, **you must stop it**. Otherwise, the system might freeze or data might be corrupted or lost.

1 Stop the card.

To stop the PC Card → “Basic” in the *Online User's Guide*.



NOTE

The **Stop** option appears in gray when you are in CardSoft mode or when the card is already stopped.

2 Raise the PC Card eject button 1 for the PC Card you want to remove. Then press the PC Card eject button 2 until the PC Card pops out.

3 Remove the PC Card and store it safely for future use.

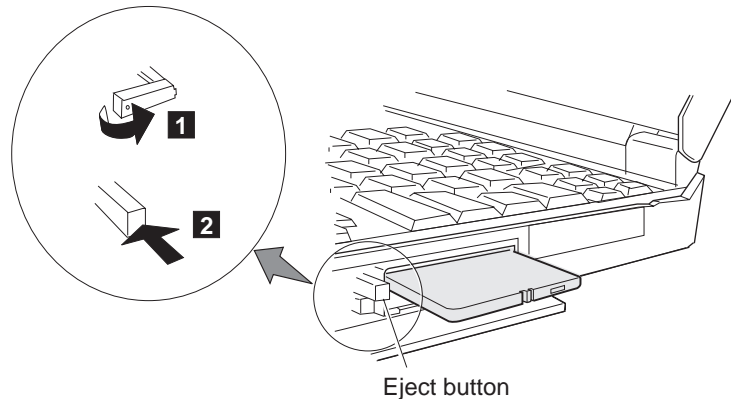

For more information for using a PC Card → “Basic” in the *Online User's Guide*.

Installing a PC Card

Installing the PC Card Modem



Your computer can be connected only to a public telephone line (analog line). Do not use a digital telephone line. Use of a phone line other than an analog can damage your modem.



Danger:

To avoid shock hazard, do not connect the cable to or disconnect the cable from the telephone outlet on the wall during electrical storms.

To install the PC Card modem, do as follows:

- 1 Insert the PC Card modem in a PC Card slot.

To configure the proper modem device driver, follow the instructions on the screen. You might need to install the modem device driver from a manufacturer's diskette. See the documentation provided with the PC Card modem.

- 2 Click on **Start**, and move the cursor to **Settings** and **Control Panel**.

- 3 Click on **Control Panel**; then double-click on **Modem**.

The "Location Information" window appears:



- 4 Fill in the necessary information; then click on the **OK** button.

5 Release the telephone jack socket on the PC Card modem.

For example, push the push-pop of the PC Card modem 1 .
For other types of modems, follow the instructions in the manual supplied with the modem.

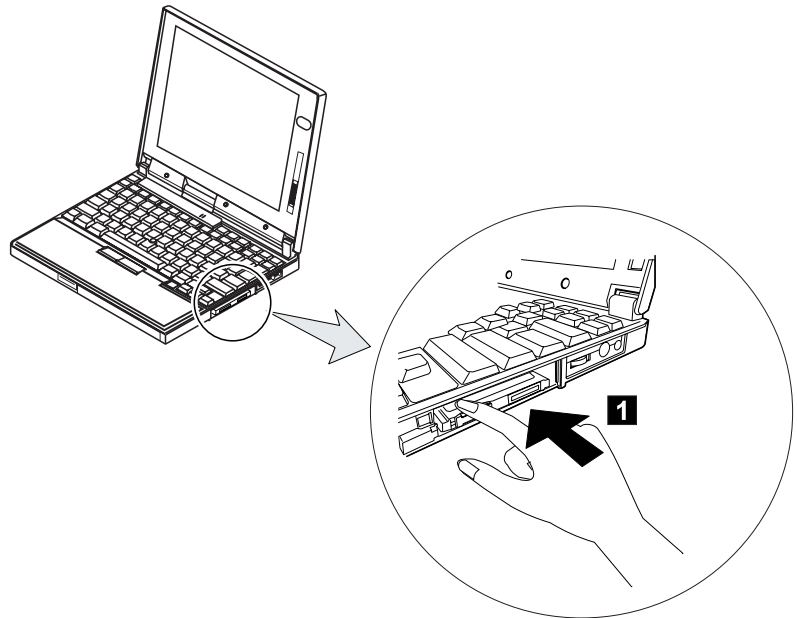

6 Connect one end of the telephone cable to the PC Card modem 1 and the other end of the cable to a telephone outlet 2 .

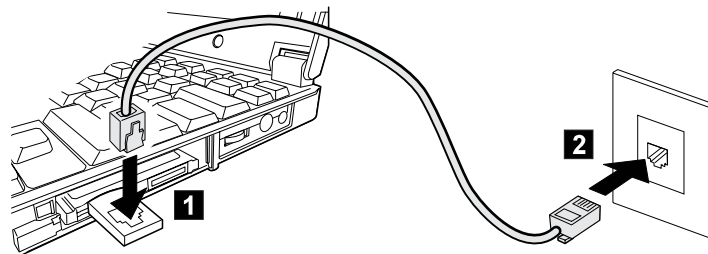

Installing a PC Card



If your computer shares a single telephone cable with a telephone, use the cable supplied with your computer.

You have completed setting up the PC Card modem.

For details on PC Card Support Software → “Basic” in the *Online User's Guide*.

Using a Port Replicator



See the user's guide shipped with the port replicator for how to dock or undock your computer.

After you dock your computer to a port replicator, all connectors on the rear of the computer are covered and are not available for use. Instead, you can use the connectors on the port replicator, plus extra features.

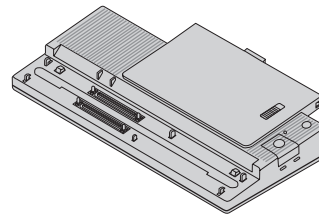

ThinkPad Port Replicator with Advanced EtherJet Feature



You can also attach the **ThinkPad 560 Port Replicator** to your computer.



The port replicator works only with ac power. You cannot use the port replicator with battery power from the computer. Do not remove the AC Adapter while you are using the port replicator. Removing it during use might cause the computer to malfunction.



Using a Port Replicator



For Windows 98:

You can dock or undock the computer **while the computer is in suspend mode or when the computer power is turned off.**

For example, when undocking the computer, you have the following alternatives:

Select **Eject PC** in the **Start** menu (suspend mode).

or:

Press the **Eject Request** button of the port replicator (suspend mode).

or:

Power off the computer and close the LCD.

Do not dock or undock when the computer is in hibernation mode.

For Windows NT:

You can dock or undock the computer only **when the computer power is turned off.**

Power off the computer and close the LCD.



If the power-on indicator of the computer or the port replicator does not turn on, press **Fn**.



Enabling the CardBus Sockets (for Windows 98)

The port replicator might not function properly if you attach a computer to it that is in suspend mode. In such a case, enable the CardBus sockets by doing the following:

- 1** Click on **Start**, move the cursor to **Settings**, and then click on **Control Panel**.
- 2** Double-click on **System**.
- 3** Click on **Device Manager**, and double-click on **PCMCIA socket**. If the CardBus sockets are not enabled, you see two **Texas Instruments PCI-1250 CardBus Controller** lines with an exclamation mark (!) under **PCMCIA socket**.
- 4** Click on one of the lines. Then click on the **Remove** button.
- 5** Click on the other line. Then click on the **Remove** button.
- 6** Click on the **Refresh** button.

The CardBus sockets are now enabled.



Using a Port Replicator



Chapter 3

Protecting Your Computer

This chapter provides information about how to protect your computer from theft or unauthorized use. It also describes how to display your personal information, such as your name or address, on the password prompt screen.

Using Passwords	68
Entering a Password	69
Setting a Password	70
Changing or Removing a Password	74
For a Power-On Password or Hard-Disk-Drive Password	74
For a Supervisor Password	76
Removing a Power-On Password with Supervisor Authority	78
Using the Personalization Editor	80
Entering Your Personal Data	80
Deleting the Personalization Window	83
Using Locks	84
Using the Security Screw	85

Using Passwords

Using Passwords

The password-setting feature helps to prevent your computer from being used by others. Once you set a password, a prompt appears on the screen each time you turn on the computer. You must enter your password at the prompt. You cannot use the computer unless you type the correct password.

You can set the following passwords on your computer:

Power-on password

Set the power-on password to protect your computer from use by another person. It provides the following security features:

- You need to type the power-on password at startup. Therefore, unauthorized users cannot use your computer.
- You need to type the power-on password when resuming from suspend mode. Therefore, unauthorized users cannot use your computer.

Hard-disk-drive password

The hard-disk-drive password provides an extra measure of security. Even if you set a power-on password, another user can remove the hard disk drive in your computer and put it in a different computer to access your data. If you set a hard-disk-drive password, however, another person cannot access the data on your hard disk without knowing the password. A hard-disk-drive password provides the following security features:

- You need to type the hard-disk-drive password at startup.
- If the hard disk drive is moved to another computer, the hard-disk-drive password must be typed at startup. Therefore, unauthorized users cannot access your hard disk even if the drive is removed from the computer.
- If you have not set a supervisor password, the hard-disk-drive password is required when the computer resumes from suspend mode.
- If you put a check mark in the **Prompt for password when computer goes off standby** check box in the “Power Management Properties” window, you are required to use the Windows 98 logon password to resume from suspend mode.

Supervisor password

The supervisor password is a tool provided for the system administrator to control many ThinkPad computers. The supervisor password is set by the system administrator and it is not required for users. Users can start the computer without providing the supervisor password. The supervisor password is required only to access Easy-Setup. It provides the following security features:

- Only a system administrator can access Easy-Setup. If a supervisor password is set, a password prompt appears if you try to start Easy-Setup.
- You can use a power-on password to protect your data from unauthorized use.
- The system administrator can use the supervisor password to access the computer even if you have set a power-on password. The supervisor password overrides the power-on password.
- The supervisor password has priority over the hard-disk-drive password. The hard disk is protected by the supervisor password so that unauthorized users cannot access data on the hard disk.
- The system administrator can set the same supervisor password on many ThinkPad computers to make administration easier.

Other passwords

Some Microsoft operating systems provide special Windows passwords. Refer to that system user's guide for information on how to set, change, and use these passwords.

Entering a Password

Once you set a password, a password prompt appears at the top left corner of the screen. This prompt appears each time you power on your computer or when your computer returns from suspend mode to normal operation.

However, a password prompt is not displayed if the computer returns to normal operation because of a preset timer or an incoming call on the modem, in which case you will have to display it by pressing a key or moving the pointing device.

Using Passwords

To enter a password, do the following:

1 Type your password.

The  symbol appears each time you press a key. Don't hold down a key too long, because the same character will be entered continuously.

2 Press the **Enter** key.

An **OK** appears if you enter the correct password, and an **X** appears if you enter the wrong password. If you fail to enter the correct password in three tries, you must turn off the computer, wait 5 seconds, and then turn it on again and retry.

Setting a Password

To set a password, do the following:

1 Start Easy-Setup.

- a) Press and hold **F1**; then turn on the computer.
- b) Hold **F1** until the "Easy-Setup" menu appears.

2 Click on **Password** in the "Easy-Setup" menu. The "Password" submenu appears:

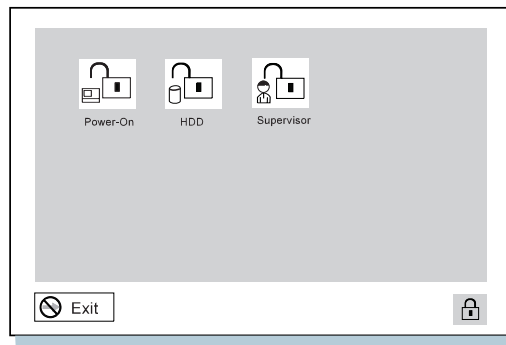

Selecting this icon displays a submenu for setting the **power-on** password.



Selecting this icon displays a submenu for setting the **hard-disk-drive (HDD)** password.



Selecting this icon displays a submenu for setting the **supervisor** password.



NOTE

An unlocked keylock icon indicates that the password is not set.

3 Click on the type of password you want to set:
Power-On, HDD, or Supervisor.

4 Type your desired appropriate password.

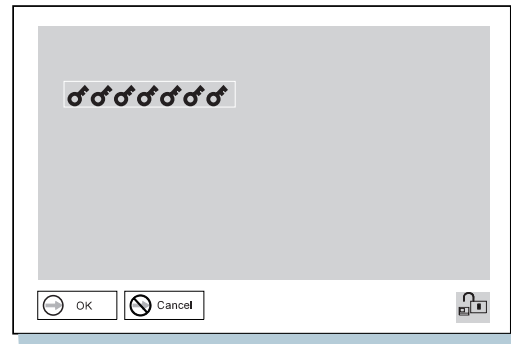

NOTE

You can type a maximum of seven random characters using a combination of letters (A to Z) and numbers (0 to 9). Uppercase and lowercase letters (for example, A and a) are treated as the same character.

If you type a wrong character, use the **Backspace** key to erase it and then type the correct one.



Using Passwords



5 Press **Enter**. The “Password Confirmation” window appears:

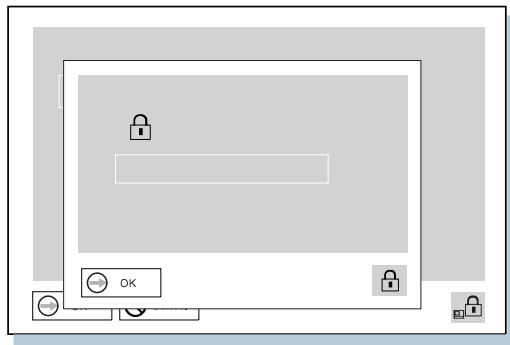

6 Type your password again to verify it; then press **Enter** again.



The following window appears if you are setting the hard-disk-drive or the supervisor password, reminding you to write down the password and keep it in a safe place:

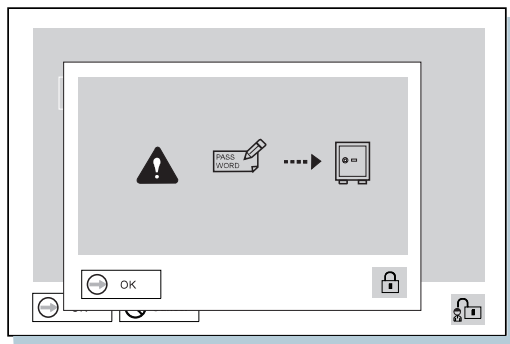

Your password is set.





Do Not Forget Your Password

If you forget your hard-disk-drive or supervisor password, there is **no way to reset your password or recover data from the hard disk**. You have to take your computer to an IBM reseller or an IBM marketing representative to have the hard disk or the system board replaced. Proof of purchase is required, and an additional charge might be required for the service. Neither an IBM reseller nor IBM marketing representative can make the hard disk drive usable.



Using Passwords



Changing or Removing a Password

This security feature prevents someone from removing a password and using your computer. To change or remove a password, do the following:

For a Power-On Password or Hard-Disk-Drive Password

- 1** Power off the computer and wait at least 5 seconds; then power on the computer.

The password prompt appears.

- 2** Type your current password.

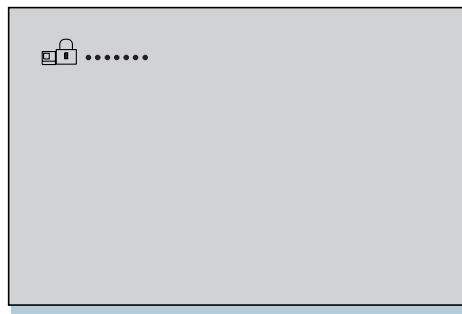

- 3** Press the **Spacebar**.

To change the password, go to step 4 .

To remove the password, press **Enter**.

The following window appears, and the system starts:

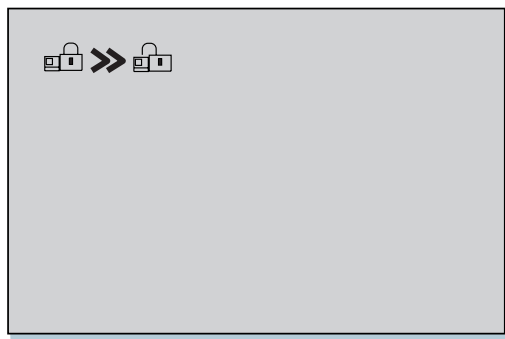

You have removed your password. Skip the remaining steps.





4 To change the password, type the new password; then press the **Spacebar**.

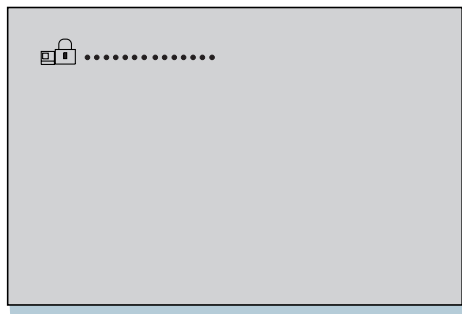

5 Type the new password again to verify it; then press **Enter**.

The following window appears, and the system starts:

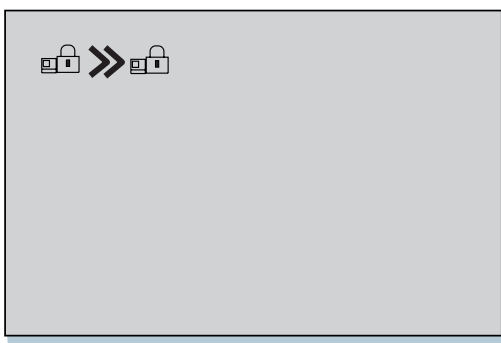

NOTE

Write down the password and keep it in a safe place.

You have changed your password.





Using Passwords



For a Supervisor Password

1 Start Easy-Setup.

- a) Press and hold **F1**; then turn on the computer.
- b) Hold **F1** until the password prompt appears.

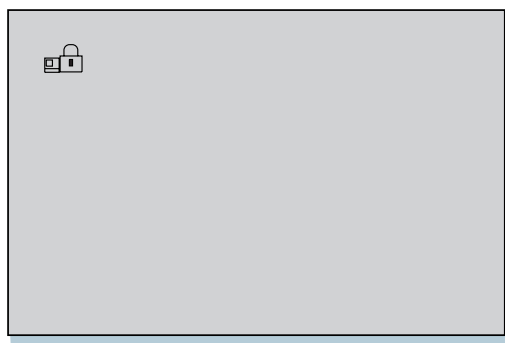

2 Enter the supervisor password.

The "Easy-Setup" menu appears.

3 Select **Password** on the menu.

4 Select **Supervisor**.

To change the password, go to setp 8 .

5 To remove the password, enter the current password and press the **Spacebar**.

6 Press **Enter** twice.

7 Click on **Exit**; then **Restart**.

The supervisor password has been removed. Your computer restarts. Skip the remaining steps.





8 Enter the current password and press the **Spacebar**.

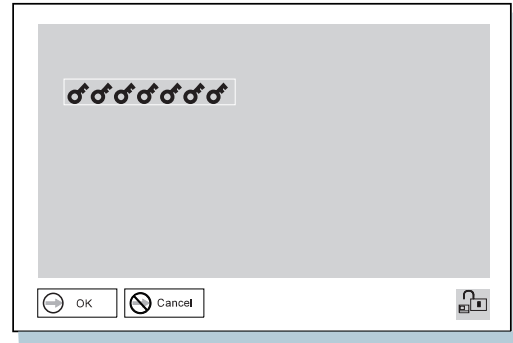

9 Type the new password; then press **Enter**.

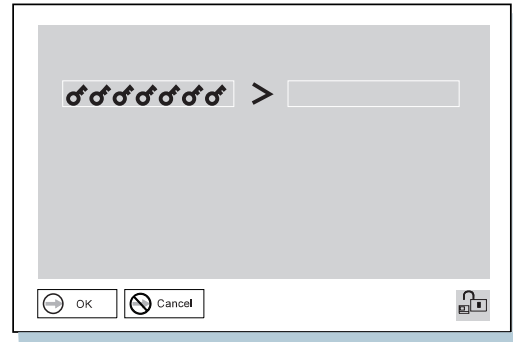

Using Passwords

- 10** Type the new password again to verify it; then press **Enter**.



The following window appears, reminding you to write down the password and keep it in a safe place:

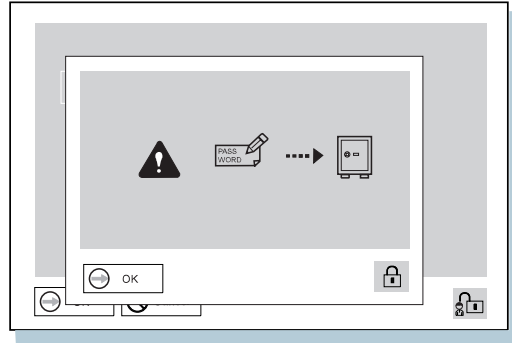

- 11** Press **Enter** again.

- 12** Click on **Exit**; then **Restart**.

The supervisor password has been changed. Your computer restarts.

Removing a Power-On Password with Supervisor Authority

You can remove a power-on-password (even if you don't know it) if you know the supervisor password.

- 1** Power on the computer by pressing **F1**.

The password prompt appears.

- 2** Enter the supervisor password.

The "Easy-Setup" menu appears.

- 3** Select **Password** on the menu.

- 4** Select **Power on** on the menu.

- 5** Type the supervisor password; then press the **Spacebar**.

6 Press **Enter**.

The "Password Confirmation" window appears:

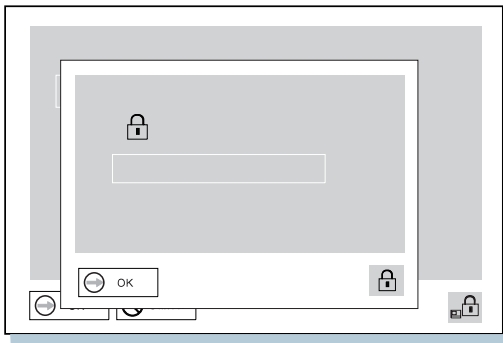

7 Press **Enter** again.

8 Click on **Exit**; then select **Restart**.

Your computer restarts. The power-on password has been removed.



Using the Personalization Editor



Using the Personalization Editor

With the Personalization Editor, you can display such personal information as your name and address on the screen each time you power on your computer. This feature helps you to identify your computer when identical computers are being used in your location, or to deter theft.

Entering Your Personal Data

A personalized password-prompt window consists of two parts: the *personal data area* 1 and the *background bitmap area* 2 .

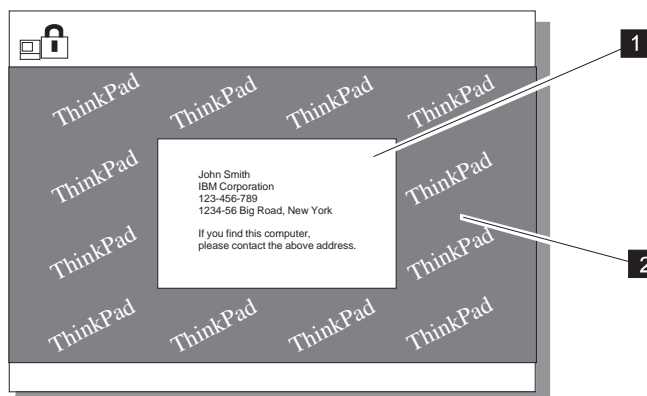

Using the Personalization Editor

To register your name, address, and company on the Personalization Editor, do the following:



For this information to be displayed, the power-on password must already be set.

- 1** Power on the computer.
- 2** Make a backup copy of the *Utility Diskette for DOS, Personalization* with the Diskette Factory. (For more information → “Backing Up Your System” on page 30.)
- 3** Insert the backup copy of the *Utility Diskette for DOS, Personalization* into the diskette drive.
- 4** Open the **Personalization Editor**.
 - a) Click on **Start**.
 - b) Move the cursor to **Programs** and **ThinkPad**; then click on **Personalization Editor**.

The following window appears:

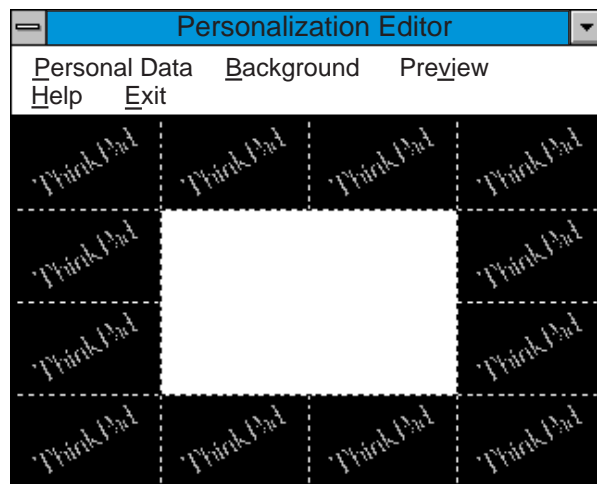

Using the Personalization Editor

- 5** Click on **Personal Data** and type the necessary information into the boxes; click on **OK** to save your data.

If you want to create the background bitmap, continue with step 6; otherwise, go to step 10.

- 6** Select **Background** in the “Personalization Editor” window.

Windows Paint automatically opens.

- 7** Draw an image or color the background.

Your bitmap size must be 160 by 100 pels. To change the size, select **Image** and then **Attribute**. Specify a **Width** of 160 and a **Height** of 100, and set **Unit** to pels.

- 8** Select **File** and **Save As** to save and name your drawing as a 16-color bitmap file on the backup copy of the *Utility Diskette for DOS, Personalization*.



To preview the actual full size of the screen, select **Preview**.

- 9** Press **Enter** to return to the previous window.

- 10** Shut down the system, and power off the computer.

- 11** Insert the backup copy of the *Utility Diskette for DOS, Personalization* into the diskette drive; then power on the computer.
- 12** Select **Update personalization data** at the menu window; then follow the instructions on the window.
Your data is copied from the *Utility Diskette for DOS, Personalization* and stored in the nonvolatile memory in the computer.
- 13** After the data is stored, power off the computer.
- 14** Set your password if you have not yet set it.
Click on **Help** for more information.

The information that you typed in will be displayed the next time you power on the computer.

Deleting the Personalization Window

To delete the personalization window and revert to the default password prompt, do the following:

- 1** Power off the computer.
- 2** Insert the backup copy of the *Utility Diskette for DOS, Personalization* into the diskette drive; then power on the computer.
- 3** Select **Delete personalization data** from the menu; then follow the instructions on the screen.
- 4** After the data is updated, restart the computer.



Using Locks



Using Locks

You can attach a mechanical lock to your computer, to help to prevent it from being removed without your permission.

Attach a mechanical lock to the keyhole 1 on the left side of the computer; then secure the chain on the lock to a secure stationary object.

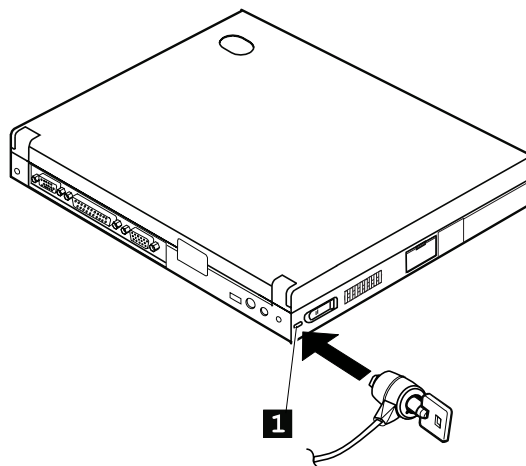

NOTE

You are responsible for evaluating, selecting, and implementing the locking devices and security features. IBM makes no comments, judgments, or warranties about the function, quality, or performance of locking devices and security features.



Using the Security Screw

You can use the security screw shipped with your computer to prevent the hard disk drive from being removed easily.

To replace the coin screw with the security screw, do as follows:

- 1** Power off the computer; then disconnect the AC Adapter and all cables from the computer.
- 2** Turn the computer over, and remove the screw with a coin.
- 3** Install the security screw and tighten it with a 2.5-mm allen wrench.
- 4** Turn the computer back to its original position. Connect the AC Adapter; then power on the computer.



Using the Security Screw



Chapter 4

Solving Computer Problems

Frequently Asked Questions	88
Considerations	96
Using Power Management	101
Using a PC Card	101
A USB Connector Consideration	102
A CardWizard Consideration	102
Using a Second CardBus Card	102
Using an External Condenser Microphone	102
Using the NetMeeting Software	103
Troubleshooting Guide	104
Troubleshooting Charts	105
Error Codes or Messages	106
No Error Codes or Messages	111
Input Problems	112
Suspend or Hibernation Problems	113
LCD Problems	116
Indicator Problems	117
Battery Problems	117
A Hard-Disk-Drive Problem	118
Infrared Communication Problems	118
A Universal Serial Bus (USB) Problem	119
PC Card Problems	120
A Printer Problem	123
External Monitor Problems	124
Port Replicator Problems	125
Other Option Problems	127
Software Problems	129
Other Problems	129
Testing Your Computer	131
Recovering Lost or Damaged Software	133
Using the Diskette Factory	133
Using the ThinkPad Customization CD	133
Using the Recovery CD	135

Frequently Asked Questions

Frequently Asked Questions

This section addresses frequently asked questions. Go to the page indicated in the following chart and do the specified action.

Questions	Page
How can I stop the screen from blanking?	90
How can I set the infrared port?	90
How can I set the serial connector?	91
How can I switch the TrackPoint and mouse?	92
How can I set the display resolution?	92
How can I set the external monitor?	93
How can I maximize battery life?	94
How can I install the operation system?	94
How can I use the Recovery CD?	95

Frequently Asked Questions

To solve the problems discussed in this section, you need to use the ThinkPad Configuration program. To start the ThinkPad Configuration program, find the ThinkPad icon on the taskbar; then double-click on the icon.

The ThinkPad Configuration program window appears:

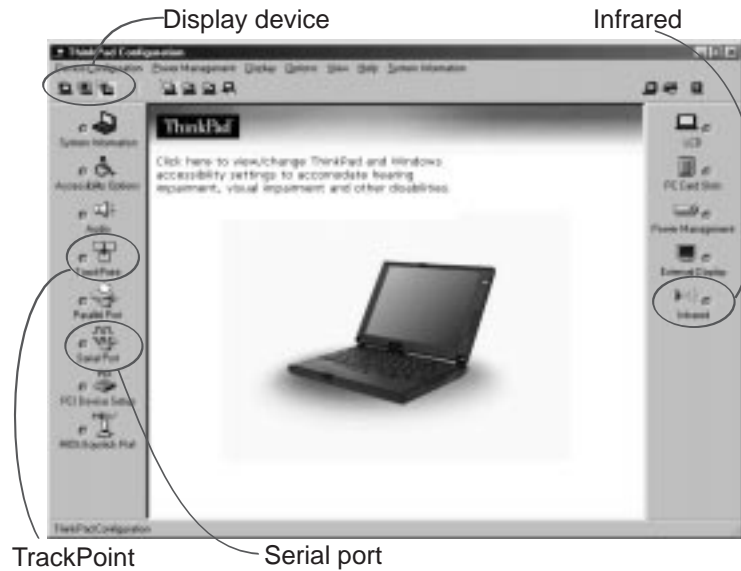

Note: You can also open the ThinkPad Configuration program as follows:

1. Click on **Start**.
2. Move the cursor to **Programs** and **ThinkPad**; then click on **ThinkPad Configuration**.

Frequently Asked Questions

My screen keeps blanking when I do not want it to. How can I stop this?

You can disable any system timers, such as the LCD turnoff timer or the system standby timer, with the ThinkPad Configuration program.

- 1 Start the ThinkPad Configuration program.
- 2 Click on the **Power Management** button; then click on the **Power Schemes** tab.

You can disable the system timers by selecting **never** rather than a specific time.

How can I use my infrared port as a communication port?

If the infrared port is disabled, you must enable it before you can use it again. To enable your infrared port, do as follows:

- 1 Save your work and quit any program you are using.
- 2 Start the ThinkPad Configuration program.
- 3 Click on the **Infrared** button.
- 4 Click on **Enable**.

A "Warning" might appear that the hardware resource is being used by another communication device.

- 5 Click on **Disable Device**.

Another "Warning" window prompts you to restart your computer.

- 6 Click on **OK**. The computer restarts.

Notes:

1. If you check your infrared port and it is already enabled, you can use it immediately without changing any settings.
2. You can disable your computer's serial connector to free resources for another communication device, such as the infrared port.

Frequently Asked Questions

After your infrared port is enabled, you can use it as a communication port. If it does not work properly, you might have a problem with your communication software or the device that you are trying to communicate with. Check the online help for your communication software if the other device appears to be working properly.

How can I use my serial connector as a communication port?

If the serial connector is disabled, you must enable it before you can use it again. To enable your serial connector, do as follows:

- 1** Save your work and any program you are using.
- 2** Start the ThinkPad Configuration program.
- 3** Click on the **Serial Port** button.
- 4** Click on **Enable**.

A "Warning" might appear that the hardware resource is being used by another communication device.

- 5** Click on **Disable Device**.

Another "Warning" window prompts you to restart your computer.

- 6** Click on **OK**. The computer restarts.

Notes:

1. If you check your serial connector and it is already enabled, you can use it immediately without changing any settings.
2. You can disable your computer's infrared port to free resources for another communication device, such as the serial connector.

After your serial connector is enabled, you can use it as a communication port. If it does not work properly, you might have a problem with the communication software application or the cable or device attached to the serial connector. Check the online help system for your communication software if the cable and attached device appear to be working properly.

Frequently Asked Questions

How can I use an external mouse when I am at my desk, but then use the TrackPoint when I am away from my desk?

The TrackPoint has an “auto disable” setting that disables it when you power on or restart the computer with an external mouse attached. When you want to enable the TrackPoint, remove the external mouse; then restart the computer.

Note: You can set up the TrackPoint manually with the ThinkPad Configuration program as follows:

- 1** Start the ThinkPad Configuration program.
- 2** Click on the **TrackPoint** button.
- 3** Select **enable**, **disable**, or **auto disable**.
- 4** Click on **OK**.

Why do I not get the highest possible resolution out of my external monitor when I am using the LCD and external monitor at the same time?

You can set any resolution for either the ThinkPad LCD or the external monitor. When you use both at the same time, the resolution of both is the same. If you set a higher resolution for the ThinkPad LCD, you can see only part of the screen at a time. You can see other parts by moving the image with the TrackPoint or other pointing device. You can change the display output type to the LCD, external monitor, or both with the **Display Device** buttons of the ThinkPad Configuration program or with **Fn+F7**.

You can set up the external monitor as follows:

- 1** Double-click on **My Computer**, **Control Panel**, and then **Display**.

The “Display Properties” window appears.

- 2** Click on the **Settings** tab.
- 3** Click on the **Advanced...** button.
- 4** Click on the **Monitor** tab.
- 5** Click on the **Change...** button.

The “Update Device Driver Wizard” window appears.

- 6** Follow the instructions on the screen by selecting **Display a list of all the drivers in a specific location, so you can select the driver you want;** and then **Show all hardware**.
- 7** Select **Manufacturers** and **Models** for your monitor.
- 8** Click on **OK** to close the “Advanced Property” window.
- 9** Set **Color** and **Screen area** in the “Display Properties” window.
- 10** Click on the **OK** button.

How can I set up the external monitor if the Windows plug-and-play feature does not detect it?

Do as follows:

- 1** Double-click on **My Computer, Control Panel,** and then **Display**.
The “Display Properties” window appears.
- 2** Click on the **Settings** tab.
- 3** Click on the **Advanced...** button.
- 4** Click on the **Monitor** tab.
- 5** Make sure that **Automatically detect Plug & Play monitors** is checked.
- 6** If the option is checked and your monitor is still not recognized after you restart the computer, click on the **Change...** button. The “Update Device Driver Wizard” window appears.
- 7** Check if the display driver information in the window is correct. If necessary, install the display driver.
- 8** Click on the **Close** button.

Frequently Asked Questions

How can I maximize battery life?

To maximize battery life, do the following:

Use the battery until the charge is completely depleted (until the battery and power LEDs flash in unison).

Recharge the battery completely before using (the battery is fully charged when the AC Adapter is plugged in and the battery LED is green).

For a new battery or a battery that you have not used recently:

1. Use the battery until the charge is completely depleted (until the battery and power LEDs flash in unison).
2. Recharge completely before using (the battery is fully charged when the AC Adapter is plugged in and the battery LED is green).
3. Repeat these steps three times.

Always use power management features such as power modes, standby, suspend, and hibernation.

For more detailed information about power management features → “Basic” in the *Online User's Guide*.

How can I load a different operating system on my computer?

–Or–

Where can I get ThinkPad device drivers for this operating system?

See “Advanced” in the *Online User's Guide* for information on installing a new operating system and device drivers. You can get the ThinkPad device drivers by using the Diskette Factory. Before installing a new operating system, do the following:

1. Print the software installation section of “Advanced” in the *Online User's Guide*.

Frequently Asked Questions

2. Make backup diskettes of the device drivers and applications for your new operating system with the Diskette Factory. For more information → “Using the Diskette Factory” on page 133.
3. Make a DOS system diskette that has the DOS FDISK.COM and FORMAT.COM utilities and the CD-ROM device driver for DOS.

How can I use the Recovery CD to reload my factory-installed ThinkPad operating system and applications?

→ “Using the Recovery CD” on page 135.



Considerations



Considerations

This section discusses considerations you should be aware of and some limitations.



For Windows 98:

In Windows 98, it takes longer to enter suspend mode and resume normal operation than it does in Windows 95. This performance difference is a result of Windows 98, not the ThinkPad features.

For more information about Windows 98, see the following Web site:

<http://www.ibm.com/thinkpad>

See the following site for technical support:

<http://www.pc.ibm.com/support>

Three power modes are described in this book: **standby mode**, **suspend mode**, and **hibernation mode**. You can enter these modes as follows:

- **Fn + F3** standby mode
- **Fn + F4** suspend mode
- **Fn + F12** hibernation mode

The computer also enters suspend mode or hibernation mode from other triggers. For example, if you select **Stand by** in the **Shut Down...** menu when you click on the **Start** button at the bottom left of the Windows 98 screen, you can enter suspend mode. Also, you can set the **system standby timer** in the "Power Management Properties" window to specify a timeout for entering suspend mode.



The word *standby* in the Windows 98 screen has a different meaning from the word *standby mode* in this book.

For more information → "Basic" in the *Online User's Guide*.



**For Windows 95:**

If you are using the Intel USB camera and the system resumes from suspend mode, the USB camera is disabled. To enable it, unplug it and plug it in again.

Because of the CD-ROM drive property settings, your computer might not enter suspend mode or hibernation mode after the end of a timeout period specified in the ThinkPad Configuration program. If you want to use suspend mode and hibernation mode, change the properties of the CD-ROM drive as follows:

1. Click on **Start** and move the cursor to **Settings** and **Control Panel**. Then click on **Control Panel**.
2. Double-click on **System**.
3. Click on the **Device Manager** tab, and double-click on **CD-ROM**.
4. Click on the CD-ROM drive name under the **CD-ROM**; then click on the **Properties** button.
5. Click on the **Settings** tab and remove the check mark from the **Auto insert notification** check box in **Options** by clicking on it.
6. Click on **OK**, and restart the computer.

**For Windows NT:**

For Windows NT 4.0, hibernation is not supported if the drive is formatted by NTFS.

For more information, refer to the following Web site:
<http://www.pc.ibm.com/support>

If you insert a PC Card into the PC Card slot, there might be an **X** mark in the list of the card information in the "PC Card [PCMCIA] Device" window in the **Control Panel**. The **X** does not affect any function, however.

Considerations



For Windows 3.1:

If a memory shortage or memory error occurs, do as follows:

1. Unload any unnecessary drivers from the CONFIG.SYS file.
(For example, unload printer drivers if you do not use a printer.)
2. Reconfigure the UMB (upper memory block) using the DEVICEHIGH statement.
3. Use the multiple configuration setup for DOS (refer to the documents supplied with DOS).

Use the DOS command `command MEM /C` to review your DOS memory usage occasionally.



For OS/2 Warp:

If you have formatted your drive using high-performance file system (HPFS) and your system has more than 64 MB memory installed, hibernation mode is not supported.

If the COM port does not work even though you have set it up correctly with the ThinkPad Configuration program, do as follows:

1. Open **System Setup**.
2. Select **Hardware Manager**.
3. Select a folder from the menu.
4. Select **Properties**.
5. In the default pull-down menu, select **No Hardware Detection**. If it has already been selected, change the setting.
6. Open the ThinkPad Configuration program.
7. Set the COM port as desired.
8. Restart the system.

If you receive incoming faxes or mail under OS/2, you must set the modem settings in the fax application to one of the following:

- Hardware FIFO enabled
- Hardware Flow Control on
- UART 16550A modem

In OS/2 FaxWorks for example, select **Utilities, Settings, Modem Type, and Use HW FIFO (16550A)**.

If you do not set your modem to one of these settings, you will not be able to receive an incoming fax or an incoming call in suspend mode.

If you do not have the PC Card device driver for OS/2 but you have one for DOS, your PC Card might run in the VDM (virtual DOS machine) environment. Refer to the *Online User's Guide* for setting the VDM and the sample configuration files on the PC Card Installation Diskette for OS/2, Windows 95, Windows 98. (If the PC Card Installation Diskette did not come with the computer, create it using the Diskette Factory program.)

DOS For DOS:

If a memory shortage or memory error occurs, do as follows:

1. Try the same actions as described for Windows 3.1.
2. Unload any unnecessary programs from the WIN.INI file (for example, FUELWIN for ac operations).

Considerations

You can use the ThinkPad Configuration program from the DOS prompt. To start the program, do the following:

1. Click on **Start**; then click on the **DOS Prompt** icon.

The DOS prompt window appears.

2. Type `PS2 ?` at the DOS prompt.

The "ThinkPad Configuration" online help window appears:

```
C:\>PS2 ?

(C) Copyright IBM Corp. 1993,1998. All rights reserved.
  US Government Users Restricted Rights - Use, duplication
  or disclosure restricted by GSA ADP Schedule Contract
  with IBM Corp.

Command Syntax: PS2  [Parameter1] [Parameter2] [Parameter3]

Following are available [Parameter1].
For the complete command syntax, type 'PS2 ?
[Parameter]'.

1.Power Management related
```

3. Select an item from the menu, and follow the instructions on the screen to set the features.

You can also create a batch file like the one shown to match your operating environment. The following sample batch file sets a longer battery operating time:

```
@Echo Off

Rem SAMPLE:Set the parameters to provide maximum power utilization.

Rem =====

PS2 PMode Custom DC           > Nul
PS2 LCd 3                     > Nul
PS2 DISK 3                    > Nul
PS2 Power 5                   > Nul
PS2 Speed Fixed Slow          > Nul
PS2 IR Disable                > Nul
PS2 Serial OFF                > Nul
```

Using Power Management

Suppose you activate the alarm action as follows:

Notification: Display message

Power level: When the alarm goes off, the computer will **Standby**.

Now if your computer enters suspend or hibernation mode when the battery is low before the alarm message appears, you see the message when the computer resumes. To resume normal operation, press **OK**.

Note: You can set the Alarm action as follows:

1. Start the ThinkPad Configuration program.
2. Click on **Power Management**.
3. Click on the **Alarm** tab.
4. Put a check mark in the **Low Battery Alarm** check box, the **Critical Low Battery Alarm** check box, or both.
5. Set the percentage of the power level.
6. Click on the **Alarm Action...** button. You can set the alarm action in the next window.

Using a PC Card

If you are communicating with a PC Card modem or inserting a PC Card in a PC Card slot, do not enter your computer into suspend mode, enter into hibernation mode, or click on **Stand by** in the "Shut Down Window" window.

Note: If you want to enter your computer into suspend mode, first stop the PC Card in the "PC Card (PCMCIA) Properties" window as follows:

1. Click on **Start**, move the cursor to **Settings**, and click on **Control Panel**.
2. Double-click on **PC Card (PCMCIA)**.
3. From the list, select the card you are stopping.
4. Click on the **Stop** button.

If you remove a communication PC Card from the PC Card slot and then reinsert it later, it might not work correctly. You need to reboot your computer.

Considerations

A USB Connector Consideration

If your computer tries to enter suspend mode and the request is rejected, the device in the USB connector might be disabled. If this occurs, do a hot-unplug and -plug operation for the USB device.

A CardWizard Consideration

If you disabled the PCIC controller and then later reenabled it in the Device Manager, correct the CONFIG.SYS file as follows before you run the CardWizard:

1. Click on **Start**.
2. Move the cursor over **Programs**; then click on **MS-DOS Prompt**.
3. At the command prompt, type `cd . .`
and press **Enter**.
4. Type `edit config.sys`
and press **Enter**.
5. On each line where it occurs in the file, remove the following phrase:
`REM - by PC Card (PCMCIA) wizard -`
Do not remove the rest of the line.
6. Save the updated CONFIG.SYS file.
7. Reboot your system.

Using a Second CardBus Card

If a CardBus Card is already configured in your computer, you must set up a second CardBus Card manually by using the Device Manager. To get to the Device Manager, click on the **System** icon in the Control Panel.

Using an External Condenser Microphone

If you are using a microphone with your computer, use the ThinkPad-option headset. Some microphones, such as condenser microphones, might need a battery. See the instructions that come with the microphone.

The microphone/line-in jack supports the following type of microphones:

- A dynamic microphone
- A self-battery-powered condenser microphone

The microphone/line-in jack of your computer supports either microphone input or line-in input, but not both. You need to mute the function you don't use, as follows:

1. Click on **Start**.
2. Move the cursor to **Programs, Accessories, Entertainment,** and then **Volume Control**.
3. Put a check mark in the **Mute** check box in the column for the function you don't use.

Using the NetMeeting Software

If you are hanging up a video phone call in NetMeeting, you might see the following Windows exception error message: "An exception OE has occurred in VxD VWIN32(1)..." This message appears only when you are making a video phone call directly over the telephone line and after you use such data sharing tools as the whiteboard, file transfer, chat, and application sharing. If this error occurs, shut down Windows and restart your computer. This error does not occur if you are using the Intel Video Phone for Internet Video Conferencing software.



Troubleshooting Guide



Troubleshooting Guide

The following chart shows how to find or solve a problem.

If a beep sounds, if a message appears, or if a function-related problem occurs:

- 1** Find your symptom from the table and try solving the problem. → "Troubleshooting Charts" on page 105.
- 2** If you can't solve the problem, run the test and make sure the hardware and the device drivers are OK. → "Testing Your Computer" on page 131.
- 3** Note the error code and have the computer serviced. → Chapter 5.

If you accidentally lose or damage software in your computer:

- Recover it by using either the ThinkPad Customization CD, the Recovery CD, or the Diskette Factory. → "Recovering Lost or Damaged Software" on page 133.



Troubleshooting Charts

If your computer has an error, it often displays a message or an error code, or a beep sounds when you power it on. Go through the charts and look for your problem. If you find the problem, go to the page indicated and do the specified action.

Troubleshooting Chart	Page
Error codes or messages	106
No error codes or messages	111
Input problems	112
Suspend or hibernation problems	113
LCD problems	116
Indicator problems	117
Battery problems	117
A hard disk drive problem	118
Infrared communication problems	118
A universal serial bus problem	119
PC Card problems	120
A printer problem	123
External monitor problems	124
Port replicator problems	125
Other option problems	127
Software problems	129
Other problems	129

Troubleshooting Charts

Error Codes or Messages



Note: In the charts, x can be any character.

Message	Action
I9990301 I9990302 I9990305 (Incorrect connection of the hard disk drive might cause these error codes to appear.)	Your computer can't find the startup drive. Do the following: <ol style="list-style-type: none"> 1. Power off the computer. 2. Press and hold F1; then power on the computer to start Easy-Setup. Hold F1 until the Easy-Setup menu appears. 3. Select the Start up icon. If you are unable to set the startup sequence, have the computer serviced. 4. Check the devices in the startup sequence box. Is the default drive listed in the startup sequence box? Yes Exit this window, and power off the computer. No Select the Reset icon. 5. Is an operating system installed? Yes Go to step 7. No Install the operating system in your computer. 6. After you install the operating system, power off the computer. 7. Power on the computer. If the same screen message appears, have the computer serviced.
I99xxxxx (except the above I999030x errors)	Have the computer serviced.
158 (supervisor password error)	The hard-disk-drive password was not set, even though the supervisor password was set. Do the following: <ol style="list-style-type: none"> 1. Type the supervisor password at the password prompt, and press Enter. 2. A POST error prompt appears; then press Enter. The password menu appears. 3. Select the Supervisor icon. The same password as the supervisor password is set on the hard disk drive. 4. Press Esc to restart the computer.

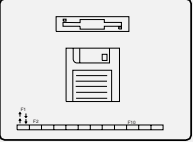
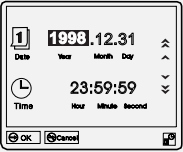
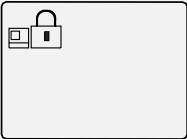

Message	Action
159 (supervisor password error)	<p>The hard-disk-drive password is not set the same as the supervisor password. Do the following:</p> <ol style="list-style-type: none"> 1. Type the supervisor password at the password prompt, and press Enter. 2. Type the hard-disk-drive password at the hard-disk-drive password prompt, and press Enter. 3. A POST error prompt appears; then press Enter. The password menu appears. 4. Select the Supervisor icon. The same password as the supervisor password is overwritten on the hard disk drive, as the new hard-disk-drive password. 5. Press Esc to restart the computer.
16x or 17x (undefined date or configuration error)	Follow the instructions on the screen.
174 (device configuration error)	Make sure that the hard disk drive is connected correctly. If the problem persists, have the computer serviced.
175, 177, 178 (EEPROM error)	Have the computer serviced.
183 (invalid password error)	The password entered at the supervisor password prompt is invalid. Check your supervisor password.
184 (invalid password error)	<p>The password entered is invalid.</p> <p>Power off the computer and wait at least 5 seconds; then power it on again and type the correct password.</p>
185 (startup sequence error)	The startup sequence is not valid. Power off the computer and wait at least 5 seconds; then power it on again to reset the startup sequence in Easy-Setup.
190 (critical low-battery error)	<p>The computer powered off, because the battery is low.</p> <p>Connect the AC Adapter to the computer and charge the battery pack, or replace the battery pack with a fully charged one.</p>
192 (cooling fan error)	Have the computer serviced.

Troubleshooting Charts

Message	Action
195 (hibernation error)	<p>The system configuration differs between the time your computer entered hibernation mode and the time it exited this mode, and your computer cannot resume normal operation.</p> <p>Change the system configuration to what it was before your computer entered hibernation mode. If the memory size was changed, re-create the hibernation file.</p>
196 (hibernation error)	<p>The computer cannot read the hibernation file. Have the computer serviced.</p>
225 (unsupported memory)	<p>The installed DIMM is not supported.</p> <p>Note: The ThinkPad 560Z computer supports EDO DRAM only. It does not support SDRAM.</p>
2xx (memory error)	<p>Make sure that the DIMM option is correctly installed.</p>
30x (keyboard error)	<p>Make sure that no object is placed on the keyboard or on the external keyboard, if you have one. Power off the computer and power off all attached devices. Power on the computer first; then power on the attached devices.</p> <p>If you still have a problem, do the following:</p> <p>If an external keyboard is connected, do the following:</p> <ul style="list-style-type: none"> – Power off the computer and disconnect the external keyboard; then power on the computer. Make sure that your keyboard operation is correct. If it is, have the external keyboard serviced. – Make sure that the external keyboard is connected to the correct connector. <p>Test the computer by selecting the Start icon in the Easy-Setup “Test” submenu.</p> <ul style="list-style-type: none"> – If the computer stops during the test, have the computer serviced.
6xx (diskette error)	<p>Have the computer serviced.</p>
11xx (serial port error)	<p>Have the computer serviced.</p>
12xx (infrared error)	<p>Have the computer serviced.</p>
17xx (hard disk error)	<p>Have the computer serviced.</p>
1801 (unsupported port replicator)	<p>The attached port replicator is not supported.</p>

Message	Action
24xx (video error)	Have the computer serviced.
808x (PC Card slot error)	Have the computer serviced.
860x (pointing device error)	Make sure that the external mouse or the external keyboard is connected correctly. If it is connected correctly, Have the computer serviced.
Diskette and F1 prompts 	<p>Make sure that the self-starting diskette is inserted correctly (with the label facing up and metal-shutter end first) in the diskette drive.</p> <p>If it is, press F1. If both prompts remain, have the computer serviced.</p>
<p>A 163 error appears and then the <i>Date and Time</i> window appears.</p> 	<p>Neither the date nor the time is set in the computer.</p> <p>Set the date and time.</p> <p>When both the power-on password and supervisor password are set, do the following:</p> <ol style="list-style-type: none"> 1. Power on the computer. The password prompt appears after the error code. 2. Type the supervisor password, <i>not</i> the power-on password. An error window appears. 3. Click on OK or press Enter. 4. Set the time and date in the next window; then press Enter. The system reboots.
<p>The power-on password prompt</p> 	<p>A power-on password or supervisor password is set. Type the correct password and press Enter to use the computer (see page 70).</p> <p>If the power-on password is not accepted, a supervisor password might have been set. Type the supervisor password and press Enter.</p> <p>If you still have a problem, have the computer serviced.</p>
<p>The hard-disk-drive password prompt</p> 	<p>A hard-disk-drive password is set. Type the correct password and press Enter to use the computer (see page 70).</p> <p>If you still have a problem, have the computer serviced.</p>

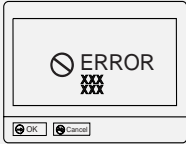
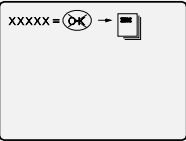
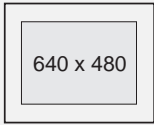
Troubleshooting Charts

Message	Action
<p>The "Test" submenu</p> 	<p>Select the Start icon and follow the instructions to test your system.</p> <p>If you cannot complete the test, have the computer serviced.</p> <p>If the test does not find the problem, but the problem persists, see if you can find your problem in the Troubleshooting Charts.</p> <p>If the test ends in an error, note the error code and have the computer serviced.</p>
<p>A POST error prompt</p> 	<p>An error was found during POST. Press Enter; then select Start from the "Test" submenu and run the test.</p> <p>If the test ends in an error, note the error code and have the computer serviced.</p>
<p>An error prompt</p> 	<p>Power off the computer and start Easy-Setup; then select Test to test the computer.</p> <p>If the test ends in an error, note the error code and have the computer serviced.</p> <p>You can start the operating system by pressing F1 instead, and ignore the error.</p>
<p>The DOS full-screen looks smaller.</p> 	<p>If you use a DOS application that supports only the 640x480 resolution (VGA mode), the screen image might appear smaller than the display size. This is to maintain compatibility with other DOS applications. To expand the screen image to the same size as the actual screen, start the ThinkPad Configuration program and click on LCD (); then enable the Screen expansion function. (The image might look slightly distorted.)</p> <p>Note: You can use the Fn+F8 keys to do the same thing.</p>
<p>A panel or message that is not listed in the troubleshooting charts.</p>	<p>Power off the computer and start Easy-Setup; then select Test to test the computer.</p> <p>If the test ends in an error, note the error code and have the computer serviced.</p> <p>If you cannot start Easy-Setup, have the computer serviced.</p>
<p>xxxxx KB OK appears and the computer stops.</p>	<p>Have the computer serviced.</p>

No Error Codes or Messages

Problem	Action
<p>The screen is blank and you don't hear any beeps.</p> <p>Note: If you are not sure whether you heard any beeps, power the computer off; then power it on again, and listen again.</p> <p>If you are using an external monitor, go to "External Monitor Problems" on page 124.</p>	<p>If a power-on password is set, press any key to display the power-on password prompt, and then type the correct password and press Enter (see page 70).</p> <p>If the power-on password does not appear, the brightness control might be set to minimum brightness. Adjust the brightness.</p> <p>If the screen still remains blank, make sure that:</p> <ul style="list-style-type: none"> The battery pack is installed correctly. The AC Adapter is connected to the computer and the power cord is plugged into a working electrical outlet. The computer power is on. (Power on the power switch again for confirmation.) <p>If these items are correct and the screen remains blank, have the computer serviced.</p>
<p>The screen is blank and you hear a continuous beep, or two or more beeps.</p>	<p>Have the computer serviced.</p>
<p>Only the cursor appears.</p>	<p>Reinstall your operating system and power on the computer.</p> <p>If you still have a problem, have the computer serviced.</p>

Troubleshooting Charts

Input Problems

Problem	Action
The cursor does not move after the computer awakens from one of the power management modes.	Make sure you followed the instructions in "Advanced" in the <i>Online User's Guide</i> correctly when you installed Windows with the Advanced Power Management (APM) option.
All or some keys on the keyboard do not work.	<p>If the problem occurred immediately after the computer returned from suspend mode, enter the power-on password if it is set.</p> <p>If an external keyboard is connected, the numeric keypad on your computer cannot work. This is not a defect.</p> <p>If an external numeric keypad or a mouse is connected:</p> <ol style="list-style-type: none"> 1. Power off the computer. 2. Remove the external numeric keypad or the mouse. 3. Power on the computer and try using the keyboard again. <p>If the keyboard problem is solved, check the connection of the external numeric keypad, external keyboard, or mouse.</p> <p>If you still have a problem, have the computer serviced.</p>
The cursor drifts when the computer is powered on or after it resumes normal operation.	<p>The cursor might drift when you are not using the TrackPoint during normal operation. This is a normal characteristic of the TrackPoint and is not a defect. Cursor drifting might occur for several seconds under the following conditions:</p> <ul style="list-style-type: none"> When the computer is powered on. When the computer resumes normal operation. When the TrackPoint is pressed for a long time. When the temperature changes.
The cursor does not work for a while after the settings in the "TrackPoint Properties" window have been changed.	This is a normal characteristic of the cursor. Wait for several seconds until the cursor returns to the normal state.
The mouse or pointing device does not work.	<p>Make sure that the pointing device is enabled in the ThinkPad Configuration program.</p> <p>Make sure that the mouse or pointing-device cable is securely connected to the computer.</p> <p>Try using the TrackPoint. If the TrackPoint works, the error might be due to the mouse.</p> <p>If your mouse is incompatible with the IBM PS/2 mouse, disable the TrackPoint using the ThinkPad Configuration program.</p> <p>Note: See the manual supplied with the mouse for more information.</p>



Problem	Action
The mouse buttons don't work.	Change the mouse driver to Standard PS/2 Port Mouse , and then reinstall PS/2 TrackPoint . See "Advanced" in the <i>Online User's Guide</i> for how to install the driver.
A number appears when you type a letter.	The numeric lock function is on. To disable it, press and hold Shift ; then press NumLk .
All or some keys on the external numeric keypad do not work.	Make sure that the external numeric keypad is correctly connected to the computer.
All or some keys on the external keyboard do not work.	To use an external keyboard, you need to attach the keyboard/mouse connector to the computer. Make sure that: <p style="margin-left: 40px;">The keyboard/mouse connector is correctly connected to the computer.</p> <p style="margin-left: 40px;">The keyboard connector is connected to the correct side of the keyboard/mouse connector.</p> <p>If these items are correct, disconnect the keyboard/mouse connector from the computer and make sure that the operation of the system keyboard is correct. If the system keyboard works, have the keyboard/mouse connector or the external keyboard serviced.</p>

Suspend or Hibernation Problems

Problem	Action
The computer enters suspend mode automatically.	The computer enters suspend mode automatically when the processor temperature reaches a certain level. This is not a defect.
The computer enters suspend mode immediately after POST (the suspend lamp turns on).	Make sure that: <p style="margin-left: 40px;">The battery pack is charged.</p> <p style="margin-left: 40px;">The operating temperature is within the acceptable range. Refer to Appendix A.</p> <p>If these items are correct, have the computer serviced.</p>
Error 19 appears and the computer immediately powers off.	The battery pack power is getting low. Connect the AC Adapter to the computer, or replace the battery pack with a fully charged one.

Troubleshooting Charts

Problem	Action
The computer does not return from suspend mode, or the suspend lamp stays on and the computer does not work.	The computer automatically enters suspend or hibernation mode when the battery power is empty. Do one of the following: Replace the battery pack with a fully charged one and then press Fn . Connect the AC Adapter to the computer; then press Fn .
The LCD is blank after resuming.	Check if an external monitor was connected before the computer entered suspend mode. Do not disconnect the external monitor while the computer is in suspend mode or hibernation mode. If no external monitor is attached when the computer resumes, the LCD remains blank and output is not displayed. This restriction does not depend on the resolution value.
Your computer does not enter suspend or hibernation mode.	Check if the any option has been selected to disable your computer from entering suspend or hibernation mode. For more information → “Basic” in the <i>Online User's Guide</i> .

Problem	Action
<p>The computer does not enter hibernation mode with the Fn+F12 key combination.</p>	<p>Enable hibernation mode as follows:</p> <p>For Windows 98:</p> <ol style="list-style-type: none"> 1. Start the ThinkPad Configuration program. 2. Click on Power Management (). 3. Click on the Hibernation tab. 4. Click on the Enable hibernation... button. 5. Click on the Create Now button. <p>The computer cannot enter hibernation mode if you are using one of the IBM communication PC Cards.</p> <p>To enter hibernation mode, stop the communication program, and then remove the PC Card or turn off power on the PC Card slot using the Control Panel.</p> <p>For Windows NT:</p> <p>Note: You must format your hard disk with the FAT format system to use hibernation mode in Windows NT. If you format your hard disk with NTFS, the Windows NT default format, you cannot use hibernation mode.</p> <ol style="list-style-type: none"> 1. Start the ThinkPad Configuration program. 2. Click on Power Management (). 3. Click on Suspend/Resume Options (). 4. Click on Enable Hibernation. 5. Click on OK. <p>The computer cannot enter hibernation mode when you are using one of the IBM communication PC Cards.</p> <p>To enter hibernation mode, stop the communication program, and then remove the PC Card or turn off power on the PC Card slot using the Control Panel.</p>

Troubleshooting Charts

LCD Problems

Problem	Action
The screen is unreadable or distorted.	<p>Make sure that:</p> <ul style="list-style-type: none"> The display device driver is installed correctly. The display resolution and color depth are correctly set. The monitor type is correct. <p>To check, do as follows:</p> <ol style="list-style-type: none"> 1. Click on Start. 2. Move the cursor to Settings and Control Panel. 3. Click on Control Panel, and then double-click on Display. 4. Select the Settings tab. 5. Check if the color depth and resolution are correctly set. 6. Click on Advanced.... 7. Select the Adapter tab. Make sure it shows "NeoMagic MagicGraph 128XD." 8. Select the Monitor tab. Make sure the information is correct.
Incorrect characters appear on the screen.	<p>Did you install the operating system or application program correctly?</p> <p>If they are installed and configured correctly, have the computer serviced.</p>
The screen stays on even after you power off your computer.	<p>Press the power shutdown switch with the tip of a pen and power off your computer; then power it on again.</p>
Missing, discolored, or bright dots appear on the screen every time you power on your computer.	<p>This is not a problem. It is an intrinsic characteristic of the TFT technology. Your computer display contains multiple thin-film transistors (TFTs). A small number of missing, discolored, or bright dots on the screen might exist all the time.</p>

Indicator Problems

Problem	Action
The battery status indicator does not go on even though a battery pack is installed in the computer.	The over-current protection device inside the battery pack has been activated. Wait several hours and try again. If the indicator still does not go on, replace the battery pack or have the computer serviced.
The diskette-drive-in-use icon stays on.	<p>If a diskette is in the drive, make sure that:</p> <ul style="list-style-type: none"> - The externally diskette drive is firmly connected to the computer. - The diskette contains the necessary files to start the system. - There is nothing wrong with your application program. - There is nothing wrong with the diskette. - The diskette is inserted correctly (label facing up and the metal-shutter end first) in the diskette drive. <p>If these items are correct, have the computer serviced.</p> <p>If there is no diskette in the drive, have the computer serviced.</p>

Battery Problems

Problem	Action
The battery pack cannot be fully charged in 3 hours by the power-off charging method.	<p>The battery pack might be over-discharged. Do the following:</p> <ol style="list-style-type: none"> 1. Power off the computer. 2. Make sure that the over-discharged battery pack is in the computer. 3. Connect the AC Adapter to the computer and let it charge. <p>If the battery pack cannot be fully charged in 24 hours, use a new battery pack.</p>
<p>Your computer shuts down before the battery status indicator shows empty.</p> <p>-or-</p> <p>Your computer operates after the battery status indicator shows empty.</p>	Repeat discharging and charging the battery pack at least three times.
The operating time for a fully charged battery pack is short.	Repeat discharging and charging of the battery pack three to six times. If you still have a problem, use a new battery pack.

Troubleshooting Charts

Problem	Action
The computer does not operate with a fully charged battery pack.	The over-current protective function in the battery pack might be activated. Power off the computer for 1 minute to reset this function; then power it back on again.

A Hard-Disk-Drive Problem

Problem	Action
The hard disk drive makes an intermittent rattling noise.	<p>The rattling noise might be heard when:</p> <ul style="list-style-type: none"> The hard disk drive starts accessing the data or when it stops. You are carrying the hard disk drive. You are carrying your computer. <p>This is a normal characteristic of a hard disk drive and is not a defect.</p>

Infrared Communication Problems

Problem	Action
Your computer cannot communicate with other devices using the infrared port.	<p>Make sure that:</p> <ul style="list-style-type: none"> The communication speeds are the same. The infrared ports are clean. No objects are between the computer and the communicating device. The distance and angle between your computer and the device is within the set range. The application software in the other computer is compatible with that in yours. You are not operating under direct sunlight. The infrared ports are directly facing the other communication port. <p>Communication might be affected by the light from the display on the computer. To avoid this, open the display to a wide angle.</p> <p>The same communication application has to be running on your computer and the other computer. Refer to the application manuals for more information.</p> <p>ThinkPad mode cannot be used if you are using a conventional communication application that uses the serial port and cable for data exchange. (In this case, the infrared port is a substitute for them.)</p>

Problem	Action
Incorrect data is sent between your computer and a communicating device.	<p>Make sure that:</p> <ul style="list-style-type: none"> The distance and angle between your computer and the device is within the set range. The communication speeds are the same. There are no other devices that radiate infrared rays, such as remote-controlled devices or wireless headphones, near your computer or the communicating device. You are not operating under direct sunlight. No fluorescent lamps are near your computer or the communicating device.
You cannot use DMA channels for both the parallel connector and the infrared port.	<p>If you enable ECP and choose DMA3 (the default value) for the parallel connector, you might be prompted if you want to disable DMA for the infrared port. To use DMA channels for both the parallel and infrared ports, do the following:</p> <ol style="list-style-type: none"> 1. Click on OK to disable DMA for the infrared port. 2. Close a parallel port panel. 3. Click on the Infrared device button to open the infrared panel. 4. Choose DMA0 or DMA1 for infrared port on the panel. 5. If you see the panel prompting if you want to disable DMA for an audible device, click on OK.

A Universal Serial Bus (USB) Problem

Problem	Cause and Action
A device connected to the USB connector does not work.	<ol style="list-style-type: none"> 1. Make sure that the USB device is connected correctly. 2. Open the "Device Manager" window, and make sure that the USB device setup is correct, and that computer resource assignment and device driver installation are correct. <p>Note: To open the "Device Manager" window, click on Start and move the cursor to Settings and Control Panel. Click on Control Panel and double-click on System. Then click on the Device Manager tab in the "System Properties" window.</p> <p>Refer to "Testing Your Computer" on page 131 and run the diagnostic test for the USB connector.</p>

Troubleshooting Charts

PC Card Problems

Problem	Action
The PC Card shows "Ready," but it does not work correctly.	<p>Make sure that:</p> <ul style="list-style-type: none">The system resources reserved for the PC Card do not conflict with other system devices.Refer to "Advanced" in the <i>Online User's Guide</i>.The resources reserved for the PC Card match the settings in the application program.If you are using a modem card, check the COM number, I/O port address, and IRQ level. If you are using a network card, check the I/O port address, IRQ level, and memory window address. To check the resources assigned to the PC Card, click on PC Card Slots and the Allocated Resources tab in the ThinkPad Configuration program.
A system resource conflict occurred when a PC Card was used.	See "Advanced" in the <i>Online User's Guide</i> .

Problem	Action
Your PC Card modem does not work.	<p>Make sure that the infrared port is disabled and the modem is set up correctly.</p> <p>Make sure that the COM port you set for the modem with the ThinkPad Configuration program is the same in the following procedure and that there is no resource conflict.</p> <p>For Windows 98:</p> <p>To set up the modem, do the following:</p> <ol style="list-style-type: none"> 1. Click on Start and move the cursor to Settings and Control Panel. 2. Click on Control Panel, and then double-click on Modem. The "Modem Properties" window appears. 3. Make sure the PC Card (PCMCIA) modem is in the window. 4. Click on Properties, <i>not</i> Dialing Properties. 5. Click on the Connection tab. 6. If there is a check mark () in the Wait for dial tone before dialing check box, click and remove it. 7. Click on Advanced... 8. If there is a check mark () in the Use error control check box, click and remove it. 9. Put a check mark () in the Use flow control check box by clicking on it and make sure that Hardware (RTS/CTS) is selected. 10. Close the window by clicking on OK. 11. Return to the "Modem Properties" window by clicking on OK. 12. Click on Dialing Properties in the "Modem Properties" window, and fill in all boxes. <p>Note: Click on either Tone dialing or Pulse dialing. Most telephones today use tone dialing.</p> <ol style="list-style-type: none"> 13. Click on OK. 14. Click on Close to close the window. 15. Close all active windows. <p>Run your modem application again.</p>
PC Card support software does not recognize your PC Card.	<p>Make sure that:</p> <p>If the PC Card is not a modem, an ATA, a Flash, or an SRAM card, you have the proper client device driver for the card.</p> <p>Your PC Card supports PCMCIA Release 2.0, 2.01, or 2.10. Refer to the manual that came with your PC Card.</p> <p>If your PC Card does not support PCMCIA Release 2.0, 2.01, or 2.10, you cannot use PC Card Director. Contact your PC Card supplier.</p> <p>Your PC Card is working by following the diagnostic instructions for your PC Card, if any.</p>

Troubleshooting Charts



Problem	Action
<p>The PC Card is recognized by PC Card support software, but the "Not Ready" or "Not Configured" message is shown.</p>	<p>Make sure that:</p> <ul style="list-style-type: none"> The PC Card enabler is installed. Refer to the manuals supplied with your PC Card. If the PC Card is not a modem, an ATA, a Flash, or an SRAM card, you have the proper client device driver for the card. The resources for the PC Card are correctly reserved. Refer to "Basic" in the <i>Online User's Guide</i>.
<p>The ATA PC Card does not run correctly.</p>	<p>If the ATA PC Card is set up in <i>CardSoft Mode</i>, there are some cards that the system cannot correctly recognize. Change the card driver to <i>Plug and Play</i> as follows:</p> <ol style="list-style-type: none"> 1. Start the ThinkPad Configuration program. 2. Click on PC Card Slots. The "PC Card Slots" window appears. 3. Click on Device Manager. The "System Properties" window appears. 4. Double-click on PCMCIA Socket. 5. Click on PCMCIA Card Services. The "PCMCIA Card Service Properties" window appears. 6. Click on Driver tab and then the Update Driver button. The "Update Device Driver Wizard" window appears. 7. Follow the instructions on the screen.
<p>The PC Card is installed and configured, but it does not work.</p>	<p>Modem card: Make sure all settings in the "Modem Control" panel and in your communication application correspond and are correct.</p> <p>SCSI card: Make sure the correct driver for the SCSI card is installed.</p> <p>Note: SCSI cards can be inserted while you are operating your computer; however, it is recommended that you insert them at boot time.</p> <p>Network card: Make sure all network components are correctly installed.</p> <p>Combo card: Make sure the correct driver for the Combo card is installed. Reboot the system, and then insert the Combo card.</p>

A Printer Problem

Problem	Action
The printer does not work.	<p>Make sure that:</p> <ul style="list-style-type: none">The parallel connector is enabled.1. Start the ThinkPad Configuration program.2. Click on Parallel Port ().3. Select Enable.4. Click on OK. <p>The printer is turned on and ready to print. The printer signal cable is connected to the correct connector of your computer.</p> <p>If these items are correct and the printer still does not work, run the tests described in the printer manual. If the tests show that the printer is OK, have the computer serviced.</p>

Troubleshooting Charts

External Monitor Problems

Problem	Action
<p>The external monitor is blank.</p>	<p>Do the following:</p> <ol style="list-style-type: none"> 1. Connect the external monitor to another computer to make sure it works. 2. Reconnect the external monitor to your computer. 3. Start the ThinkPad Configuration program. 4. Click on External Display () or LCD + External Display () on the toolbar in the ThinkPad Configuration. <p>If nothing appears on the external monitor, have the computer serviced.</p>
<p>You cannot set a higher resolution than the present one on your external monitor.</p>	<p>Make sure that:</p> <p>The display driver is installed correctly by doing the following:</p> <ol style="list-style-type: none"> 1. Click on Start. 2. Move the cursor to Settings and Control Panel. 3. Click on Control Panel, and then double-click on Display. 4. Select the Settings tab in the "Display Properties" window. 5. Click on the Advanced... button. 6. Click on the Adapter tab. Make sure that it shows "NeoMagic MagicGraph 128XD." <p>If you are not sure that the display driver is installed correctly, reinstall it.</p> <p>An appropriate monitor type is selected by doing the following:</p> <ol style="list-style-type: none"> 1. Click on Start. 2. Move the cursor to Settings and Control Panel. 3. Click on Control Panel, and then double-click on Display. 4. Select the Settings tab in the "Display Properties" window. 5. Click on the Advanced... button. 6. Click on the Monitor tab. 7. Click on the Change... button. <p>The "Update Device Driver Wizard" appears.</p> <ol style="list-style-type: none"> 8. Follow the instructions on the screen by selecting Display a list of all the drivers in a specific location, so you can select the driver you want, and then Show all hardware. 9. Select Manufacturers and Models for your monitor. 10. Click on OK to close the "Advanced Property" window. 11. Set Color and Screen area in the "Display Properties" window. 12. Click on the OK button.

Problem	Action
The screen is unreadable or distorted.	<p>Make sure that:</p> <p>The display driver is installed correctly by doing the following:</p> <ol style="list-style-type: none"> 1. Click on Start. 2. Move the cursor to Settings and Control Panel. 3. Click on Control Panel, and then double-click on Display. 4. Select the Settings tab in the "Display Properties" window. 5. Click on Advanced... 6. Click on the Adapter tab. <p>Make sure that it shows "NeoMagic MagicGraph 128XD."</p> <p>The monitor is set correctly by doing the following:</p> <ol style="list-style-type: none"> 1. Click on the Advanced... button in the Settings tab in the "Display Properties" window. 2. Click on the Monitor tab. 3. Make sure you choose the correct monitor. 4. Click on OK to close the window. <p>The refresh rate is correctly selected by doing the following:</p> <ol style="list-style-type: none"> 1. Click on the Adapter tab. 2. Select the correct refresh rate for your monitor. <p>If you are not sure, select Optimal.</p> <p>If the settings are correct, run the tests described in the manual supplied with the external monitor. If the tests show that the external monitor is OK, have the computer serviced.</p>
Wrong characters appear on the screen.	<p>Did you install the operating system or application program with the correct procedure?</p> <p>If you did, have the external monitor serviced.</p>

Port Replicator Problems

Problem	Action
The computer hangs when you power on or resume operation.	<p>Make sure that:</p> <p>The AC Adapter is connected to the port replicator.</p> <p>The power-on indicator of the port replicator is on.</p> <p>The computer is securely attached to the port replicator.</p> <p>If there is still a problem, have the port replicator serviced.</p>

Troubleshooting Charts



Problem	Action
<p>The PC Card installed in a port replicator is not recognized and the PC Card slots are unusable.</p>	<p>Make sure that:</p> <ul style="list-style-type: none"> The AC Adapter is connected to the port replicator. The power-on indicator of the port replicator is on. The computer is securely attached to the port replicator. <p>This problem might happen when you reinstall Windows 98, or when you initialize the system with Easy-Setup.</p> <p>Do the following procedure to confirm the settings of Windows 98:</p> <ol style="list-style-type: none"> 1. Shut down Windows 98 and power off the computer. 2. Connect the AC Adapter to the port replicator and attach the computer to the port replicator. 3. Power on the computer and start Windows 98. 4. Click on Start and move the cursor to Settings and Control Panel. Then click on Control Panel and double-click on System. 5. Click on the Device Manager tab, and double-click on System Device and PCI Bus. 6. Click on the Settings tab, and confirm that Use BIOS is selected. If not, click on USE BIOS. 7. Click on IRQ Steering, and confirm that check marks are added in checkboxes of Get Use table using ACPI BIOS, Get IRQ table using US Specification table, and Get IRQ table from Read Mode PCIBIOS 2.1 call. If not, add check marks in both boxes. 8. Click on OK twice. 9. Follow the instructions on the screen and restart the computer. <p>This problem might also happen when you install a PC Card in a port replicator for the first time.</p> <p>To avoid this problem, do as follows:</p> <ol style="list-style-type: none"> 1. Click on Start and move the cursor to Settings and Control Panel. 2. Click on Control Panel and double-click on System. 3. Click on the Device Manager tab. 4. Click on Refresh and OK.

Problem	Action
The MIDI connector of a port replicator does not work.	<p>To enable the MIDI connector of a port replicator, use the ThinkPad Configuration program. Make sure that the MIDI connector is enabled by doing the following procedure:</p> <ol style="list-style-type: none"> 1. Start the ThinkPad Configuration program. 2. Click on MIDI/Joystick Port. 3. Confirm that the MIDI Port is enabled. If not, click on Enable; then click on OK. 4. Close the ThinkPad Configuration program and restart the computer. <p>Note: When you restart the computer, the installation of a MIDI device driver might be required. Follow the instructions on the screen and install the device driver for your computer's operating system.</p>

Other Option Problems

Problem	Action
An IBM option that you just installed does not work.	<p>Make sure that:</p> <ul style="list-style-type: none"> The option is designed for your computer. The option was installed according to the instructions supplied with the option. Other installed options or cables are not loose. There is no I/O address or interrupt level (IRQ) DMA channel conflict. To see the system resource status, start the ThinkPad Configuration program and click on the respective device buttons. <p>If the test program for the option did not find the problem, have the computer and option serviced.</p>
An IBM option that used to work no longer works.	<p>Make sure that:</p> <ul style="list-style-type: none"> The option is securely connected to your computer. The option passes its own test. If the option came with its own test instructions, use those instructions to test the option. There is no system resource conflict (see "Advanced" in the <i>Online User's Guide</i>). <p>If these items are correct and the test program did not find the problem, have the computer and option serviced.</p>

Troubleshooting Charts

Problem	Action
The serial connector does not work.	<p>Make sure that the serial connector is enabled by doing the following:</p> <p>For Windows 98:</p> <ol style="list-style-type: none">1. Start the ThinkPad Configuration program.2. Click on Serial Port ().3. Select Enable.4. Click on Device Manager.5. Check the ports in the "Device Manager" window and make sure the settings are correct.6. Click on OK. <p>For Windows NT:</p> <ol style="list-style-type: none">1. Start the ThinkPad Configuration program.2. Click on Serial Port ().3. Select Enable; then select COM1, COM2, COM3, or COM4.4. Click on OK.

Software Problems

Problem	Action
An application does not run correctly.	<p>Check the following to make sure that the problem is not being caused by the application:</p> <ul style="list-style-type: none"> Your computer has the minimum required memory to run the application. Refer to the manuals supplied with the application. The application is designed to operate with your operating system. Other applications run correctly on your computer. The necessary device drivers are installed (→ “Advanced” in the <i>Online User's Guide</i>). The application works OK when it is run on some other computer. <p>If an error message appears when you are using the application program, refer to the manuals supplied with the application.</p> <p>If these items are correct and you still have a problem, contact your place of purchase or a service representative for help.</p>
The main window bitmap in the ThinkPad Configuration program is distorted (Windows NT only).	<p>Installing the Active Desktop, bundled with Internet Explorer Version 4.0 on Windows NT, might cause this problem. Do one of the following:</p> <ul style="list-style-type: none"> Uninstall the Active Desktop. (Merely disabling the Active Desktop is not effective to avoid the problem.) Close the ThinkPad Configuration program and start it again. (This is a temporary recovery.)

Other Problems

Problem	Cause or Action
The computer locks or does not accept any input.	<p>Your computer might lock when it enters suspend mode during a communication operation. Disable the suspend timer when you are working on the network.</p> <p>To power off the computer, press the power shutdown switch using the tip of a ballpoint pen.</p>
The computer does not power off with the power switch.	<p>If the suspend indicator is on and you are working under battery power, change the battery to a fully charged one or change your power source to ac power.</p> <p>If you still have a problem, press the power shutdown switch using the tip of a ballpoint pen.</p>
The computer does not start from a diskette.	<p>Make sure that the startup sequence in Easy-Setup is set so that the computer starts up from the diskette drive (see page 20).</p>

Troubleshooting Charts

Problem	Cause or Action
Performance degrades when the computer gets hot during use.	The processor speed might decrease under the following conditions: Use in a hot environment High-powered processing that requires high-power consumption This is not a defect.
The ThinkPad Configuration window does not appear correctly in the Windows NT environment.	Uninstall Active Desktop if Internet Explorer Version 4.0 is installed. –Or– Close the ThinkPad Configuration window and restart it. (This solves the problem temporarily.)

Testing Your Computer

If you still have a problem with your computer after using the Troubleshooting Charts, test the computer using the Easy-Setup **Test** function.

To test your computer, do the following:

- 1 Press and hold **F1**; then power on the computer to start Easy-Setup. Hold **F1** until the “Easy-Setup” menu appears:

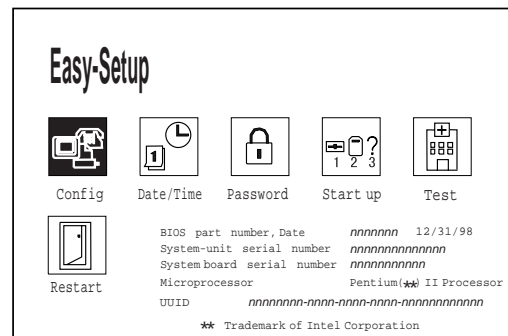

You will hear a short beep. If you are not sure whether you heard a beep, press **Fn+PgUp** a few times to make the speaker volume loud. power off the computer and try again. If you still don't hear a beep, the speaker is not working. Have your computer serviced.



Testing Your Computer



2 Select the **Test** icon; then select the **Start** icon or press **Enter**.



Do not touch the keyboard or the pointing device during the test.

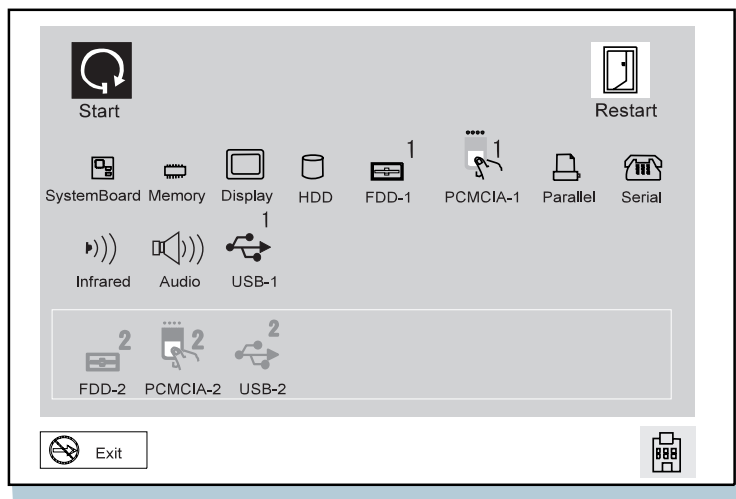

If you cannot go to the next menu, have the computer serviced.

If an X appears to the left of a device with an error code below it, make a note of the error code and have the computer serviced.



Recovering Lost or Damaged Software

This section describes how to recover lost or damaged software.

Using the Diskette Factory

To recover a particular device driver or utility program, create the backup diskettes for it with the Diskette Factory; then reinstall it.

To create the backup diskettes, do the following:

- 1 Click on **Start**.
- 2 Move the cursor to **Programs** and **ThinkPad 560**; then click on **Diskette Factory**.
- 3 Click on the tab at the top corresponding to the operating system you are using.
- 4 Click on the diskette group for the backup copy that you want to make.



NOTE

1. You can select more than one group by clicking while pressing **Ctrl**.
2. The number of the diskettes required is shown beside the diskette group. You do not need to use a blank diskette; the Diskette Factory prompts you to reformat diskettes that are not blank.

- 5 Click on **Build**.
- 6 Follow the instructions on the screen.

For detail on how to install software → “Advanced” in the *Online User's Guide*.

Using the ThinkPad Customization CD

You need an external CD-ROM drive.



NOTE

Use a CD-ROM drive that is compatible with your computer.

Recovering Lost or Damaged Software

The ThinkPad Customization CD is provided for your installation convenience. If you need to reinstall a software application or a hardware device driver, put the ThinkPad Customization CD in your CD-ROM drive. The menu of the features appears automatically.



The ThinkPad Customization CD is compatible with Internet Explorer Version 4.0 or later. Some functions are available in other Web browsers. See the instructions printed on the CD label for more information.

The following features are included:

Getting Started

Use this page for first-time setup, such as registration and ThinkPad personalization.

System Customization

Use this page for doing the following:

- Reinstalling a software application for Windows 98
- Reinstalling a hardware device driver for Windows 98
- Installing all hardware device drivers when installing Windows 95
- Installing all hardware device drivers when installing Windows NT

News and Updates

This page has all of the latest tools and links to the IBM Web site for system information, service and support information, and other information.

Online Library

In case you do not have the *Online User's Guide* on your hard disk drive, you always have a copy on your ThinkPad Customization CD.

Using the ThinkPad Customization CD

This page contains an overview of ThinkPad Customization CD.

Using the Recovery CD

The Recovery CD package consists of a boot diskette and a CD-ROM containing the original preinstalled image.

You need an external CD-ROM drive.



This CD deletes all personal data and your customized configuration setting. It resets your computer to most of the factory-shipped default values. You should back up your personal files before you use this CD.



Use a CD-ROM drive that is compatible with your computer.

- 1** Power off the computer.
- 2** Connect the CD-ROM drive to your computer.
- 3** Connect the external diskette drive to your computer.
- 4** Insert the Recovery CD Boot Diskette into the diskette drive.
- 5** Power on the computer.
Your hard disk is formatted.
- 6** Insert the CD-ROM into the CD-ROM drive.
- 7** Follow the instruction that appears on the screen.
- 8** When the process is complete, remove the Recovery CD Boot Diskette from the diskette drive.
- 9** Press **Restart**.

Your computer restarts with the original preloaded software and hardware configuration.



Recovering Lost or Damaged Software



Chapter 5

Getting Service

If you need further assistance, you can call your IBM reseller or IBM marketing representative.

You will need to know the following information when requesting repair service:

- Identification number of your computer
- Options installed in your system

Note: Use the record sheet on page 139.

- Error message or problem

Note: Error messages can help identify which service action is required and help the service representative provide quick and efficient service.

Use the record sheet on page 140.

About Your Warranty

During the warranty period, you might be responsible for repair costs if the product damage was due to misuse, accident, modification, unsuitable physical or operating environment, or improper maintenance.

For full information on product warranties, see Appendix C.

For your convenience, write the service phone numbers here:

Information on Your Computer

Option List

DIMM

_____ MB

PC Cards

_____ MB Hard Disk Drive
External Diskette Drive

Battery Pack

Identification Numbers

The serial number label is on the bottom of your computer. Write down the machine **Type** and the serial number (**S/N**) in the following box:

IBM Product Name	ThinkPad 560Z
Machine Type	2640- _____
Serial Number	_____

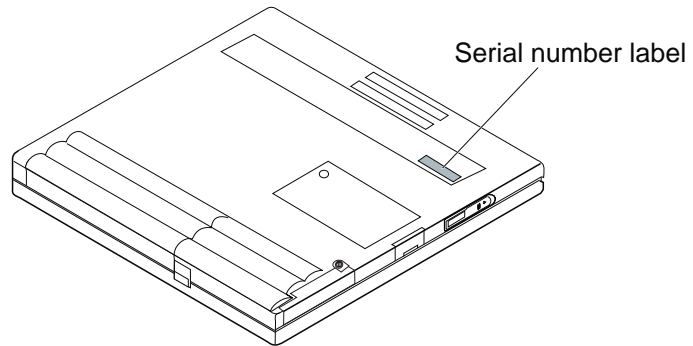



Information on Your Computer



Problem Recording Sheet

Computer information:

Machine type: _____

Serial number: _____

Date of purchase: ___/___/___

Type of problem:

Continuous problem

Intermittent problem

Error code:

The operating system and its version number, if available:

Windows 98 Version _____

Windows 3.1 Version _____

Windows 95 Version _____

OS/2 Version _____

Windows NT Version _____

DOS Version _____

Application programs running at the time of the problem:

Problem symptom:

Describe the problem specifically:

Can the problem be reproduced?

Yes No

If yes, describe how it can be reproduced:



Customer Support and Service

Purchasing an IBM PC hardware product entitles you to receive support and services during the limited warranty period. If you need additional support and services, a wide variety of extended solutions that addresses most needs are available for purchase.

Help by ThinkPad Web Site

You can get support and information at the ThinkPad Web site.

The latest information about the ThinkPad computers

➔ <http://www.ibm.com/thinkpad>

The technical support information

➔ <http://www.pc.ibm.com/support>

IBM may make improvements or changes in these Web sites at any time without any notice.

Help by Telephone

You can get support and information by telephone during the limited warranty period at no additional charge, through the IBM PC Support Line. Experienced technical-support representatives will be on hand to assist you in answering any questions you might have, such as:

How to set up your computer

How to install and set up your IBM options purchased directly from IBM or through an IBM reseller

How to use the 30-day support for the preinstalled operating system

How to get service

Please have the following information ready when you call:

Serial number of your computer and proof of purchase

Description of the problem

Exact wording of the error message

Hardware and software configuration information for your system

Customer Support and Service

If possible, be at your computer when you call:

In the U.S. and Puerto Rico, call 1-800-772-2227.

In Canada, call 1-800-565-3344.

These lines are available 24 hours a day, 7 days a week. The answering technical-support representative can also fax or mail you technical or product information, such as:

Product brochures

Location of IBM resellers

Services available from IBM

ThinkPad EasyServ

ThinkPad *EasyServ* is a courier repair service for IBM mobile products whereby your ThinkPad computer is picked up, sent to IBM for repair, and then returned to the location of your choice. This service is available at no additional charge during the limited warranty period. Most computers can be repaired the day that they arrive at the IBM repair location.

Support personnel first try to solve your problem over the phone. If they are unsuccessful, you can arrange for EasyServ service by calling the PC Support Line.

If possible, you should use the original ThinkPad shipping materials that your computer came in for re-sending it to IBM. If the box is not available, the courier will deliver a shipping carton and will return later to pick it up. This service is available only in the U.S. and Canada.

Getting Help around the World

If you make frequent overseas trips or you are residing abroad, you can register with the International Warranty Service Office. The office will issue an International Warranty Service Certificate, which you can use wherever IBM or IBM resellers sell and service IBM PC products.

For more information on registering with the International Warranty Service Office, call 1-800-497-7426 in the U.S. or Canada.

Fax Information

In the U.S. and Canada, if you have a touch-tone telephone and access to a fax machine, you can receive marketing and technical information on such topics as computer hardware, operating systems, and local area networks (LANs) by fax. You can call the IBM Automated Fax System 24 hours a day, 7 days a week. Follow the recorded instructions, and the information that you request will be sent your fax machine.

To access the IBM Automated Fax System, call:

In the U.S., 1-800-426-3395

In Canada, 1-800-465-3299

Electronic Support Services

If you have a modem, you can access such public information services as the electronic bulletin boards and messaging areas, electronic conferences, and searchable databases available in several of the most popular online information services.

Bulletin boards and online services contain information on many topics such as:

- PC user groups
- PC questions and answers
- OS/2 topics
- Problem solving
- Technical information
- Hardware and software configurations
- Networking

The IBM Bulletin Board System (BBS) can be reached 24 hours a day, 7 days a week. Modem speeds of up to 14,400 baud are supported. Long-distance telephone charges might apply.

Customer Support and Service

To access the BBS, call:

In the U.S., 1-919-517-0001

For Canada, call the center closest to you:

- 905-316-4255 (Markham, Ontario)
- 514-938-3022 (Montreal)
- 416-492-1823 (Toronto)
- 604-664-6466 (Vancouver)

Commercial online services that have information on IBM products are:

CompuServe:

Use the **GO** word **ThinkPad**.

Prodigy:

Use the **Jump** command; type **IBM** and select **PC Product Support**.

America Online:

Use the **Go to** keyword **IBM**.

You can also contact us on the Internet for answers to your technical support questions. If you link to our support home page, you can search for technical tips, download update drivers, and find out about many other things. You can visit the site at the following URL:

<http://www.pc.ibm.com/support>

Customer Support and Service

Personalized Web-based PC support provides PC users easy access to online support, including a personalized IBM Web site tailored to their machine type, computing environment, and such individual interests as business applications or games. Once you set up a profile with IBM, you are thereafter greeted by name and presented targeted information selected specifically to meet your particular needs. For example, if you are a corporate ThinkPad user, you might receive information on Microsoft Windows NT and remote connectivity. You can also choose to receive proactive e-mail, alerting you to time-saving hints and tips and such product-specific updates as modem speed and BIOS files. Interactive Web-based forums are monitored around the clock by IBM specialists, complementing its support on all the major Internet service providers. You can set up your profile at:

<http://www.pc.ibm.com/support>



Purchasing Additional Services



Purchasing Additional Services

During and after the limited warranty period, you can purchase additional services, such as:

- Support for IBM and non-IBM hardware, operating systems, and application programs

- Network setup and configuration

- Upgraded or extended hardware repair services

- Custom installation

The availability of the service and its name might vary by country.

Enhanced PC Support Line

Enhanced PC Support is available for desktop and mobile IBM computers that are not connected to a network. Technical support is provided for IBM computers and IBM or non-IBM options, operating systems, and application programs on the supported products list.

This service includes technical support for the following:

- Installing and configuring your out-of-warranty IBM computer

- Installing and configuring non-IBM options in IBM computers

- Assistance with the preloaded operating system

- Using selected application software and games

- Tuning performance, such as memory management

- Installing device drivers remotely

- Setting up and using multimedia devices

- Identifying system problems

- Interpreting documentation

You can purchase this service for a single incident or for multiple incidents. For more information about purchasing the Enhanced PC Support → "Ordering Support Line Services" on page 148.

Client Support Line

Client support is available to provide assistance with the following:

- Installation and configuration of clients

- Identification of system problems related to the client in a network environment



Purchasing Additional Services

Assistance with client network interface cards and options

You can purchase this service on a one-time basis (for a single incident).

Network and Server Support Line

Network and Server Support includes all the features of the Enhanced PC Support Line and is available for simple and complex networks made up of IBM workstations and servers using major network operating systems. This line also supports the many popular non-IBM adapters and network interface cards.

This service includes technical support for the following:

- Installing and configuring client workstations and servers
- Identifying system problems and correcting problems on the client or the server
- Using IBM and non-IBM network operating systems
- Interpreting documentation

You can purchase this service for a single incident or for multiple incidents.

For more information about purchasing Network and Server Support → "Ordering Support Line Services" on page 148.

Purchasing Additional Services

Ordering Support Line Services

The Enhanced PC Support Line, Client Support Line, and Network and Server Support Line services are available for products on the Supported Products list.

To receive a Supported Products list,

In the U.S:

- Call 1-800-772-2227.
- Select the automated fax system option.
- Select the service for which you would like a Supported Products list:
 - For the Enhanced PC Support Line, select document 11682.
 - For the Network and Server Support Line, select document 11683.

In Canada:

- Call 1-800-465-7999 or 1-800-465-3299.

In other countries, contact your IBM reseller or IBM marketing representative.

For more information on how to purchase the Support Line Services:

In the U.S.: call 1-800-772-2227.

In Canada: call 1-800-465-7999.

In other countries, contact your IBM reseller or IBM marketing representative.

Warranty and Repair Services

You can extend your period of ThinkPad EasyServ warranty service.

For more information on warranty extensions:

In the U.S., call 1-888-426-4343.

In Canada, call 1-800-465-7999.

In other countries, contact your IBM reseller or IBM marketing representative.

For more details on service offerings in the U.S., refer to the EasyServ information under "ThinkPad" at the following Web site:
<http://www.pc.ibm.com/us/infobrf>

Obtaining IBM Operating System Updates

Obtaining IBM Operating System Updates

IBM provides update diskettes, called ServicePacks or corrective service diskettes (CSDs), to customers who report a DOS or an OS/2 problem for which there is or will be a corrective program.

Getting Update Diskettes

You can obtain update diskettes from:

IBM Software Solutions Center (1-800-992-4777 for the U.S. and Canada)

An IBM authorized reseller or an IBM marketing representative

Ordering Publications

Additional publications are available for purchase from IBM. For a list of publications available in your country:

In the U.S. and Puerto Rico: call IBM PC Books at 1-800-426-7282.

In Canada: call 1-800-465-1234.

In other countries, contact your IBM authorized reseller or IBM marketing representative.

Appendix A. Features and Specifications

This appendix describes features and specifications for your computer.

Features

Microprocessor

Intel Mobile Pentium II processor

Memory

Standard: 32 MB or 64 MB

Maximum: 96 MB or 128 MB

Storage devices

2.5-inch customer-upgradable hard disk drive

Display

The color LCD display uses TFT technology and support

Up to 800-by-600 resolution on the LCD

Up to 1024-by-768 resolution on the external monitor

Brightness control

Keyboard

84-key, 85-key, or 89-key

TrackPoint

Fn key function

Features

External Diskette Drive

To get the best performance from your diskette drive, use high-quality diskettes (such as IBM diskettes) that meet or exceed the following standards:

1-MB, 3.5-inch, unformatted diskette:

- ANSI (American National Standards Institute) X3.137
- ISO (International Standards Organization) 8860
- ECMA (European Computer Manufacturers Association) 100

2-MB, 3.5-inch, unformatted diskette:

- ANSI X3.171
- ISO 9529
- ECMA 125

External interface

Serial connector (EIA-RS232D)

Parallel connector (Centronics)

External input-device connector

External-monitor connector

External-diskette-drive connector

Expansion connector

PC Card slots (two Type I or Type II PC Cards, or one Type III PC Card)

Headphone jack

Microphone/line-in jack (supports a dynamic microphone or a self-battery-powered condenser microphone)

Infrared port

Universal Serial Bus (USB) port

Specifications

Size

Width: 297 mm (11.7 in.)
Depth: 222 mm (8.7 in.)
Height: 31.0 mm (1.22 in.)

Environment

Note:

When you charge the battery pack, its temperature must be at least 10°C (50°F).

Temperature (at altitudes less than 2438 m [8000 ft]):

- Operating with no diskette: 5° to 35°C (41° to 95°F)
- Operating with a diskette: 10° to 35°C (50° to 95°F)
- Nonoperating: 5° to 43°C (41° to 109°F)

Relative humidity:

- Operating with no diskette in the drive: 8% to 95%
- Operating with a diskette in the drive: 8% to 80%

Maximum altitude: 3048 m (10,000 ft) in unpressurized conditions

- Maximum temperature at 3048 m (10,000 ft): 31.3°C (88° F)

Heat output

Approximately 30 Kcal per hour

Electrical (AC Adapter)

Sine-wave input, at 50 to 60 Hz, is required
The input rating of the AC Adapter: 100–240 V ac, 50/60 Hz

Lithium-ion battery pack

Nominal voltage: 10.8 V dc
Capacity: 2.2 AH

IBM Power Cords

IBM Power Cords

IBM power cords for a specific country are usually available only in that country:

For 2-pin power cords:

IBM Power Cord Part Number	Used in These Countries
13H5264	Bahamas, Barbados, Bermuda, Bolivia, Canada, Cayman Islands, Colombia, Costa Rica, Dominican Republic, Ecuador, El Salvador, Guatemala, Guyana, Haiti, Honduras, Jamaica, Korea (South), Mexico, Netherlands Antilles, Nicaragua, Panama, Peru, Philippines, Saudi Arabia, Suriname, Taiwan, Thailand, Trinidad (West Indies), United States of America, Venezuela
13H5267	Abu Dhabi, Albania, Antigua, Bahrain, Brunei, Dubai, Fiji, India, Ireland, Kenya, Kuwait, Macao, Malaysia, Nigeria, Oman, People's Republic of China (including Hong Kong), Qatar, Singapore, United Kingdom
13H5270	Austria, Belgium, Bosnia-Herzegovina, Bulgaria, Chile, Croatia, Czech Republic, Denmark, Egypt, Finland, France, Germany, Greece, Hungary, Iceland, Indonesia, Israel, Italy, Macedonia, Netherlands, Norway, Poland, Portugal, Romania, Slovakia, Slovenia, Spain, Sweden, Switzerland, Turkey, Yugoslavia
13H5273	Japan
13H5276	Argentina, Australia, New Zealand, Papua New Guinea, Paraguay, Uruguay
13H5279	Bangladesh, Pakistan, South Africa, Sri Lanka

For 3-pin power cords:

IBM Power Cord Part Number	Used in These Countries
76H3514	Argentina, Australia, New Zealand, Papua New Guinea, Paraguay, People's Republic of China (other than Hong Kong), Uruguay
76H3516	Aruba, Bahamas, Barbados, Bermuda, Bolivia, Brazil, Canada, Cayman Islands, Colombia, Costa Rica, Curacao, Dominican Republic, Ecuador, El Salvador, Guatemala, Guyana, Haiti, Honduras, Jamaica, Korea (South), Liberia, Mexico, Netherlands Antilles, Nicaragua, Panama, Peru, Philippines, Saudi Arabia, Suriname, Taiwan, Thailand, Trinidad (West Indies), United States of America, Venezuela
76H3518	Austria, Belgium, Bosnia-Herzegovina, Bulgaria, Croatia, Czech Republic, Egypt, Finland, France, Germany, Greece, Hungary, Iceland, Indonesia, Macao, Macedonia, Netherlands, Norway, Poland, Portugal, Romania, Slovakia, Slovenia, Spain, Sweden, Turkey, Yugoslavia
76H3520	Denmark
76H3522	Bangladesh, Pakistan, Myanmar, South Africa, Sri Lanka
76H3524	Abu Dhabi, Albania, Antigua, Bahrain, Brunei, Dubai, Fiji, Hong Kong, India, Ireland, Kenya, Kuwait, Malaysia, Nigeria, Oman, Qatar, Singapore, United Kingdom
76H3528	Switzerland, Liechtenstein
76H3530	Chile, Ethiopia, Italy, Libya
76H3532	Israel
76H3535	Korea

Note

The grounded adapter is required for full MPRII compliance. If a 3-pin power cord came with your computer, see "Safety Information" on page xiii.



IBM Power Cords



Appendix B. Handling Tips

By using common sense and by following these handling tips, you will get the most use and enjoyment out of your computer for a long time to come.

This appendix provides tips for handling notebook computers in general. Some descriptions might not suit your situation. Check your shipping checklist to confirm the items you get with your computer.

Notebook computers are precision machines that require a bit of careful handling. Though your computer is designed and tested to be a durable notebook computer that functions reliably in normal work environments, you need to use some common sense in handling it.

ThinkPad Don'ts

- Do not subject your computer to physical punishment, such as dropping or bumping.
- Do not place heavy objects on your computer.
- Do not spill liquids into your computer.
- Do not use your computer in or near water (to avoid the danger of electrical shock).
- Do not pack your computer in a tightly packed suitcase or bag. Your LCD might be damaged.

A scratchlike marking on your LCD might be a stain transferred from the keyboard (including from the TrackPoint stick) when the cover was pressed from the outside. Wipe such a stain gently with a dry soft cloth. If the stain remains, moisten the cloth with LCD cleaner and wipe the stain again. Be sure to dry the LCD before closing it.

- Do not disassemble your computer. Only an authorized IBM ThinkPad repair technician should disassemble and repair your computer.
- Do not scratch, twist, hit, or push the surface of your computer display.
- Do not place any objects between the display and keyboard.
- Do not pick up or hold your computer by the display. When picking up your open computer, hold it by the bottom (keyboard) half.
- Do not modify or tape the latches to keep the display open or closed.
- Do not turn your computer over while the AC Adapter is plugged in. This could break the adapter plug.
- Do not move the computer when the hard disk drive is accessing data (when the indicator is blinking).
- Do not use or store your computer where the temperature is below 5° C or above 35° C (41° F and 95° F).
- Do not place your computer closer than 13 cm (5 in.) from any electrical appliance that generates a strong magnetic field, such as a motor, a magnet, a TV, a refrigerator, or large audio speakers.
- Do not hard-mount your computer in a vehicle or anywhere that it is subject to strong vibration. See "Ruggedized Mobile Computers" in this appendix for information on a more appropriate model for demanding applications.
- Do not crush or drop the external or removable hard disk, diskette, or CD-ROM drive when it is outside your computer.
- Do not press on the middle part of the diskette drive or CD-ROM drive.
- Do not insert a diskette at an angle. Not inserting the diskette straight into the drive can damage the drive.
- Do not place more than one label on a diskette. Multiple or loose labels can detach or tear and then lodge in the drive.
- Do not touch the lens on the CD-ROM tray.
- Do not close the CD-ROM tray until you hear the CD-ROM click into the center pivot of the CD-ROM drive.
- Do not touch the surface of a compact disc; handle the compact disc only by its edges.
- Do not connect the modem to a PBX (private branch exchange) or other digital telephone extension line. **Your computer can use only a public-switched telephone network (PSTN).** Use of a phone line other than PSTN can damage your modem. If you are not sure which kind of phone line you are using, contact your telephone company. Many hotels or office buildings use digital telephone extension lines, so check before connecting the telephone cable in such places.
- Do not leave the base of your computer in contact with your lap or any part of your body for an extended period when the computer is functioning or when the battery is charging. Your computer dissipates some heat during normal operation. This heat is a function of the level of system activity and battery charge level.

ThinkPad Do's

- Store your CD-ROM drive in the CD carrying case and the diskette drive in its enclosure.
- When installing your hard disk, diskette, or CD-ROM drive, follow the instructions in this book and apply pressure only where needed on the device.
- Treat your computer like a precision piece of electronic machinery.
- Retain and store packing materials safely out of reach of children to prevent the risk of suffocation from plastic bags.

Handling Tips

Register your ThinkPad products with IBM (refer to the *Setup Guide*). This can help authorities return your computer to you if it is lost or stolen. Registering your computer also enables IBM to notify you about possible upgrades. Check the IBM Web pages at <http://www.pc.ibm.com> periodically to get current information about your computer.

Cleaning Your Computer

Occasionally clean your computer as follows:

Use a soft cloth moistened with nonalkaline detergent to wipe the exterior of the computer.
Don't spray cleaner directly on the display or keyboard.
Gently wipe the LCD with a dry, soft cloth.

Carrying Your Computer

When carrying your computer, follow these instructions to prevent possible damage to your computer and data:

1. Remove any media from the CD-ROM drive or diskette drive.
2. Turn off all attached devices.
3. Power off the computer, or enter suspend or hibernation mode; then close the LCD. Make sure the suspend indicator is on when it is in suspend mode, or the power indicator is off when it is powered off or in hibernation mode.
4. Unplug all external cables and cords connected to your computer.
5. Make sure all computer doors and covers are closed.
6. Use a quality carrying case that provides adequate cushion and protection.

Do not move the computer when the hard disk drive is accessing data (when the indicator is blinking). Make sure the indicator is off before you carry the computer.

Extending Your Computer's Battery Life

The amount of battery power consumed by your computer depends on such conditions as the usage frequency, the operating temperature, and the period in storage (if unused). The following tips can help you to extend the life of your battery:

If your battery is brand new and you are charging it for the first time, it might not become fully charged due to the characteristics of the chemicals in the cell. To maximize performance, ensure that all chemicals in the battery are fully activated by cycling the battery (fully charge, then fully discharge) three times. Also, follow this procedure if you stored the battery for a few months.

Do not charge the battery pack until all of its power is used. Recharging a battery pack that is not completely discharged can shorten battery life.

Once you start charging the battery pack, do not use it until it is fully charged.

Whenever possible, use the ThinkPad battery power-saving modes:

- **Standby**
- **Suspend**
- **Hibernation**

For more information → "Basic" in the *Online User's Guide*.

Decrease the LCD brightness.

Use Advanced Power Management (APM). Each operating system comes with its own power management.

Stop the supply of power to the internal serial devices, including the modem, the serial port, and the infrared port, if they are not in use.

Remove the battery pack and keep it in a cool place if you will not be using the computer for a long period.

Ruggedized Mobile Computers

Some professionals work in environments that may require special ruggedized features to protect their computers from extreme temperature, humidity, and physical punishment. Construction, public service, distribution, repair service, and utilities are some of the environmentally demanding professions that may require rugged mobile computers that can withstand stresses. For these applications, IBM offers such computers (not ThinkPad systems), especially designed for mobile professionals who need a system for managing and communicating information from the field.

For more information on these computers, consult your IBM Business Partner.

Ergonomics Information

This is important information you should read before using your computer in your “virtual office.”

Working in the virtual office might mean adapting to frequent changes in your environment. Following some simple “rules of the road” will make things easier and bring you the maximum benefits of your computer. Keeping in mind such basics as good lighting and proper seating, for example, can go a long way in helping you enhance your performance and achieve greater comfort wherever you are.

Note:

The example shown here is of someone in a traditional setting. Even when not in such a setting, you can follow many of these tips. Develop good habits, and they will serve you well.

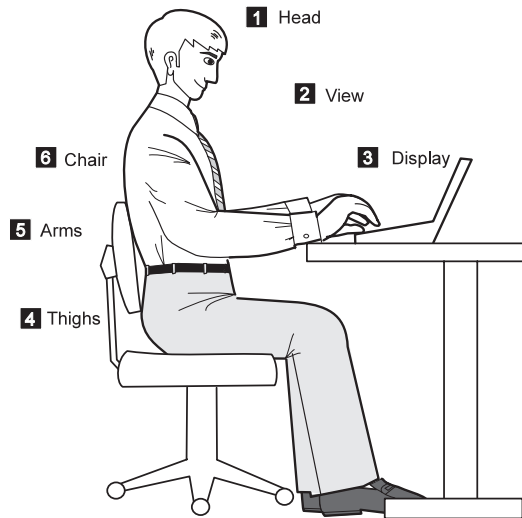

- | | |
|--|---|
| <p>1 Head
Keep your head in a comfortable and vertical position.</p> <p>2 View
Maintain a comfortable viewing distance of 510–760 mm (20–30 in.).</p> <p>3 Display
Position the display to avoid glare or reflections from overhead lighting or outside sources of light.
Keep the display screen clean and set the contrast and brightness to levels that allow you to see the screen clearly.</p> | <p>4 Thighs
Keep your thighs parallel to the floor and your feet flat on the floor or on a footrest.</p> <p>5 Arms
Keep your forearms, wrists, and hands in a relaxed and neutral position. Don't pound the keys; type with a soft touch.</p> <p>6 Chair
Use a chair that gives you good back support.</p> |
|--|---|

What if you are traveling?

It may not be possible to observe the best ergonomics practices when you are using your computer while on the move or in a “casual” setting. Regardless of the setting, try to observe as many of the tips for proper usage as possible. Sitting properly and using adequate lighting, for example, will help you maintain desirable comfort and performance levels.

Questions about vision?

IBM's visual display screens are designed to meet the highest standards and to provide you with clear, crisp images and large, bright displays that are easy to see, yet easy on the eyes. Of course, any concentrated and sustained visual activity can be tiring. If you have questions on eye fatigue or visual discomfort, consult a vision care specialist for advice.



Handling Tips



Appendix C. Product Warranty and Notices

International Business Machines Corporation

Armonk, New York 10504

Statement of Limited Warranty

The warranties provided by IBM in this Statement of Limited Warranty apply only to Machines you originally purchase for your use, and not for resale, from IBM or an IBM authorized reseller. The term "Machine" means an IBM machine, its features, conversions, upgrades, elements, or accessories, or any combination of them. Machines are subject to these terms only if purchased in the United States or Puerto Rico, or Canada, and located in the country of purchase. If you have any questions, contact IBM or your reseller.

Machine: IBM ThinkPad 560Z and the Battery Pack

Warranty Period*: One Year

**Elements and accessories are warranted for three months. Contact your place of purchase for warranty service information.*

Production Status

Each Machine is manufactured from new parts, or new and serviceable used parts (which perform like new parts). In some cases, the Machine may not be new and may have been previously installed. Regardless of the Machine's production status, IBM's warranty terms apply.

The IBM Warranty

IBM warrants that each Machine 1) is free from defects in materials and workmanship and 2) conforms to IBM's Official Published Specifications. IBM calculates the expiration of the warranty period from the Machine's Date of Installation. The date on your receipt is the Date of Installation, unless IBM or your reseller informs you otherwise.

During the warranty period, IBM or your reseller will provide warranty service under the type of service designated for the Machine and will manage and install engineering changes that apply to the Machine. IBM or your reseller will specify the type of service.

For a feature, conversion, or upgrade, IBM or your reseller may require that the Machine on which it is installed be 1) the designated, serial-numbered Machine and 2) at an engineering-change level compatible with the feature, conversion, or upgrade. Some of these transactions (called "Net-Priced" transactions) may include additional parts and associated replacement parts that are provided on an exchange basis. All removed parts become the property of IBM and must be returned to IBM.

Replacement parts assume the remaining warranty of the parts they replace.

If a Machine does not function as warranted during the warranty period, IBM or your reseller will repair or replace it (with a Machine that is at least functionally equivalent) without charge. If IBM or your reseller is unable to do so, you may return it to your place of purchase and your money will be refunded.

If you transfer a Machine to another user, warranty service is available to that user for the remainder of the warranty period. You should give your proof of purchase and this Statement to that user.

Warranty Service

To obtain warranty service for the Machine, you should contact your reseller or call IBM. In the United States, call IBM at **1-800-772-2227**. In Canada, call IBM at **1-800-565-3344**. You may be required to present proof of purchase.

Depending on the Machine, the service may be 1) a "Repair" service at your location (called "On-site") or at one of IBM's or a reseller's service locations (called "Carry-in") or 2) an "Exchange" service, either On-site or Carry-in.

When a type of service involves the exchange of a Machine or part, the item IBM or your reseller replaces becomes its property and the replacement becomes yours. The replacement may not be new, but will be in good working order and at least functionally equivalent to the item replaced.

It is your responsibility to:

Product Warranty

1. obtain authorization from the owner (for example, your lessor) to have IBM or your reseller service a Machine that you do not own;
2. where applicable, before service is provided —
 - a) follow the problem determination, problem analysis, and service request procedures that IBM or your reseller provide,
 - b) secure all programs, data, and funds contained in a Machine,
 - c) inform IBM or your reseller of changes in a Machine's location, and
 - d) for a Machine with exchange service, remove all features, parts, options, alterations, and attachments not under warranty service. Also, the Machine must be free of any legal obligations or restrictions that prevent its exchange; and
3. be responsible for loss of, or damage to, a Machine in transit when you are responsible for the transportation charges.

Extent of Warranty

IBM does not warrant uninterrupted or error-free operation of a Machine.

Unless IBM specifies otherwise, IBM provides non-IBM machines on an "AS IS" basis. However, non-IBM manufacturers may provide their own warranties to you.

Misuse, accident, modification, unsuitable physical or operating environment, improper maintenance by you, removal of product labels or parts identification labels, or failure caused by a product for which IBM is not responsible may void the warranties.

THESE WARRANTIES REPLACE ALL OTHER WARRANTIES, EXPRESS OR IMPLIED, INCLUDING, BUT NOT LIMITED TO, THE IMPLIED WARRANTIES OF MERCHANTABILITY AND FITNESS FOR A PARTICULAR PURPOSE. HOWEVER, SOME LAWS DO NOT ALLOW THE EXCLUSION OF IMPLIED WARRANTIES. IF THESE LAWS APPLY, THEN ALL EXPRESS AND IMPLIED WARRANTIES ARE LIMITED IN DURATION TO THE WARRANTY PERIOD. NO WARRANTIES APPLY AFTER THAT PERIOD.

In Canada, warranties include both warranties and conditions.

Some jurisdictions do not allow limitations on how long an implied warranty lasts, so the above limitation may not apply to you.

Limitation of Liability

Circumstances may arise where, because of a default on IBM's part (including fundamental breach) or other liability (including negligence and misrepresentation), you are entitled to recover damages from IBM. In each such instance, regardless of the basis on which you are entitled to claim damages, IBM is liable only for:

1. bodily injury (including death), and damage to real property and tangible personal property; and
2. the amount of any other actual loss or damage, up to the greater of \$100,000 or the charge for the Machine that is the subject of the claim.

Under no circumstances is IBM liable for any of the following:

1. third-party claims against you for losses or damages (other than those under the first item listed above);
2. loss of, or damage to, your records or data; or
3. economic consequential damages (including lost profits or savings) or incidental damages, even if IBM is informed of their possibility.

Some jurisdictions do not allow the exclusion or limitation of incidental or consequential damages, so the above limitation or exclusion may not apply to you.

This warranty gives you specific legal rights and you may also have other rights which vary from jurisdiction to jurisdiction.

Notices

References in this publication to IBM products, programs, or services do not imply that IBM intends to make these available in all countries in which IBM operates. Any reference to an IBM product, program, or service is not intended to state or imply that only that IBM product, program, or service may be used. Any functionally equivalent product, program, or service that does not infringe any of the intellectual property rights of IBM may be used instead of the IBM product, program, or service. The evaluation and verification of operation in conjunction with other products, except those expressly designated by IBM, are the responsibility of the user.

IBM may have patents or pending patent applications covering subject matter in this document. The furnishing of this document does not give you any license to these patents. You can send license inquiries, in writing, to the IBM Director of Licensing, IBM Corporation, 500 Columbus Avenue, Thornwood, NY 10594, U.S.A.

Year 2000 Readiness and Instructions

A product is Year 2000 Ready if the product, when used in accordance with its associated documentation, is capable of correctly processing, providing, and receiving date data within and between the 20th and 21st centuries, provided all other products (for example, software, hardware, and firmware) used with the product properly exchange date data with it.

This IBM PC hardware product has been designed to process four-digit date information correctly within and between the 20th and 21st centuries. If your IBM computer is on when the century changes, you should turn it off and then back on again once, or restart the operating system, to ensure that the internal clock resets itself for the new century.

This IBM PC product cannot prevent errors that might occur if software you use or exchange data with is not ready for the Year 2000. IBM software that comes with this product is Year 2000 Ready. However, software from other companies might come with this IBM PC product. IBM cannot take responsibility for the readiness of that software. You should contact the software

Notices

developers directly if you wish to verify readiness, understand limitations, or look for any software updates.

To learn more about IBM PC products and the Year 2000, visit our Web site at <http://www.pc.ibm.com/year2000>. The information and tools there can help you with your Year 2000 transition plan, especially if you have multiple IBM PCs. IBM encourages you to check periodically for updated information.

Trademarks

The following terms are trademarks of the IBM Corporation in the United States or other countries or both:

IBM	PS/2
Operating System/2	RediSafe
OS/2	ThinkPad
PC Card Director	TrackPoint
	WIN-OS/2

Microsoft, Windows, Windows NT, Windows 98, and the Windows 95 flag logo are trademarks or registered trademarks of Microsoft Corporation.

Intel , Pentium , and MMX are trademarks or registered trademarks of Intel Corporation in the U.S. and other countries.

Other company, product, and service names, which may be denoted by a double asterisk (**), may be trademarks or service marks of others.

Electronic Emission Notices

Federal Communications Commission (FCC) Statement

ThinkPad 560Z, model number 2640

This equipment has been tested and found to comply with the limits for a Class B digital device, pursuant to Part 15 of the FCC Rules. These limits are designed to provide reasonable protection against harmful interference in a residential installation. This equipment generates, uses, and can radiate radio frequency energy and, if not installed and used in accordance with the instructions, may cause harmful interference to radio communications. However, there is no guarantee that interference will not occur in a particular installation. If this equipment does cause harmful interference to radio or television reception, which can be determined by turning the equipment off and on, the user is encouraged to try to correct the interference by one or more of the following measures:

- Reorient or relocate the receiving antenna.

- Increase the separation between the equipment and receiver.

- Connect the equipment into an outlet on a circuit different from that to which the receiver is connected.

- Consult an IBM authorized dealer or service representative for help.

Properly shielded and grounded cables and connectors must be used in order to meet FCC emission limits. Proper cables and connectors are available from IBM authorized dealers. IBM is not responsible for any radio or television interference caused by unauthorized changes or modifications to this equipment. Unauthorized changes or modifications could void the user's authority to operate the equipment.

This device complies with Part 15 of the FCC Rules. Operation is subject to the following two conditions: (1) this device may not cause harmful interference, and (2) this device must accept any interference received, including interference that may cause undesired operation.

Responsible Party:

International Business Machines Corporation
New Orchard Road
Armonk, NY 10504
Telephone 1-919-543-2193

Notices

Industry Canada Class B Emission Compliance Statement

This Class B digital apparatus complies with Canadian ICES-003.

Avis de conformité à la réglementation d'Industrie Canada

Cet appareil numérique de la classe B est conforme à la norme NMB-003 du Canada.

European Community Directive Conformance Statement

This product is in conformity with the protection requirements of EU Council Directive 89/336/EEC on the approximation of the laws of the Member States relating to electro-magnetic compatibility. IBM cannot accept responsibility for any failure to satisfy the protection requirements resulting from a non-recommended modification of the product, including the fitting of non-IBM option cards.

A declaration of Conformity with the requirements of the Directive has been signed by IBM United Kingdom Limited, PO BOX 30 Spango Valley Greenock Scotland PA160AH.

This product satisfies the Class B limits of EN 55022.

Glossary

This glossary includes terms and definitions from the *IBM Dictionary of Computing* (New York: McGraw-Hill, 1994).

ac. Alternating current.

ac power. Power that is supplied to the computer through an electrical outlet.

ANSI. American National Standards Institute.

APM. Advanced Power Management.

application program. A program that performs specific tasks on your computer, such as word processing or the creation of spreadsheets.

ASCII. American National Standard Code for Information Interchange.

ATA PC Card. A PC Card with an AT attachment hard disk drive interface, such as a storage device PC Card.

AUTOEXEC.BAT. A file that contains a startup procedure of DOS. Each time you start your system, DOS performs the commands that are stored in this file.

backup copy. A copy, usually of a file or group of files, that is kept in case the original file or files are unintentionally changed or destroyed.

BIOS (Basic Input/Output System). Microcode that contains such basic hardware operations as interactions with diskette drives, hard disk drives, and the keyboard.

bitmap graphics. (1) A form of graphics in which all points on the display are directly addressable. (2) In multimedia

applications, a form of graphics in an area of computer memory or storage that can be displayed as an image.

boot. To prepare a computer system for operation by loading an operating system.

bps. Bits per second. In serial transmission, the instantaneous bit speed with which a device or channel transmits a character.

bus. A facility for transferring data between several devices located between two end points, only one device being able to transmit at a given moment.

cache memory. A special memory, smaller and faster than main memory, that is used to hold a copy of instructions and data in main memory that are likely to be needed next by the processor, and that have been obtained automatically from main memory.

CD-i. Compact disc-interactive.

combination keys. Keys that have specific functions when you hold them down at the same time.

CONFIG.SYS. A file that contains a group of commands to load installable device drivers and reserve space in system memory for information processing. This file is referred to by DOS during system startup.

configuration. (1) The manner in which the hardware and software of an information processing system are organized and interconnected. (2) The physical and logical arrangement of devices and programs that make up a data processing system. (3) The devices

and programs that make up a system, subsystem, or network.

CRT. Cathode ray tube display.

device driver. (1) A file that contains the code needed to use an attached device. Operating system loads device drivers for screens, keyboards, printers, diskette drives, hard disk drives, and auxiliary devices. (2) A program that enables a computer to communicate with a specific peripheral device—for example, a printer, a video disc player, or a CD drive. (3) A collection of subroutines that control the interface between I/O device adapters and processors.

DIMM. Dual inline memory module.

directory. A type of file containing the names and controlling information for other files or other directories.

Diskette Factory. The preload program for creating the installation diskettes of the device drivers and the operating system.

DMA. Direct memory access. The transfer of data between memory and input/output units without processor intervention.

double-click. To press and release a mouse button twice within a time frame defined by the user, without moving the pointer off the choice.

DRAM. Dynamic random access memory.

DSP. Digital signal processor.

ECP. Extended Capability Port.

EDO DRAM. Enhanced data output dynamic random access memory.

EGA. Enhanced graphics adapter.

EIA. Electronics Industries Association.

EIA-232D. An EIA interface standard that defines the physical, electronic, and functional characteristics of an interface line that connects a communication device and associated workstation. It uses a 25-pin connector and an unbalanced line voltage.

EMS. Expanded memory specification.

FAQ. Frequently asked questions.

fax. (1) Facsimile machine. (2) A transmitted document from a facsimile machine.

FDD. Floppy disk drive.

fixed disk. In personal computing, *fixed disk* is synonymous with *hard disk*.

Flash memory. Electrically rewritable storage.

folder. A file used to store and organize documents.

fuel gauge. An indicator on the screen that constantly shows the current power status of the battery pack.

HHR. Half-horizontal resolution.

hibernation. One of the power-saving methods that stores data and applications running in the computer's memory on the hard disk. During hibernation, the computer is automatically turned off to save power. When power is turned on again, the computer immediately restores the same data and applications as when hibernation started, without restarting the operating system.

high-resolution mode. Video resolutions that are greater than 640 by 480 pels.

icon. A graphic symbol, displayed on a screen, that a user can point to with a

pointing device such as a TrackPoint or mouse to select a particular function or software application.

IDE. Integrated device electronics.

IR. Infrared.

IrDA. Infrared data association.

ISA. Industry standard architecture.

ISO. International Organization for Standardization.

JEIDA. Japan Electronics Industry Development Association.

kilobyte (KB). 1024 bytes.

LAN. Local area network.

LCD. Liquid crystal display.

MCI. Media Control Interface.

megabyte (MB). 1024 kilobytes. About 1 million bytes.

memory. Often referred to as random-access memory (RAM), measured in kilobytes (KB) or megabytes (MB) of information.

MHz. Megahertz.

microcode. One or more microinstructions used in a product as an alternative to hard-wired circuitry to implement functions of a processor or other system component.

MIDI. Musical Instrument Digital Interface.

modem. A device that connects your computer to a telephone line, allowing it to communicate with another computer at another location.

parallel port. A port used to attach such devices as dot-matrix printers and

input/output units; it transmits data 1 byte at a time.

partial suspend mode. A kind of standby mode that occurs if the computer has failed to enter suspend mode. In this mode, the console is locked if the power-on password is set.

password. A series of letters or numbers that you designate to restrict access to your computer.

PC Card. A card that is based on the PC Card standard.

pel. Picture element.

Personalization Editor. A feature that helps you to identify your computer when identical computers are being used in your location, or to deter theft.

picture element. In computer graphics, the smallest element of a display surface that can be independently assigned color and intensity.

pixel. Picture element.

pointing device. An instrument, such as a mouse, TrackPoint, or joystick, that is used to move a pointer on the screen.

pop-up menu. On the display screen, a menu that emerges in an upward direction from a particular point or line on a display screen.

port replicator. An option to expand the capabilities of the ThinkPad computer by providing additional PC Card slots and ports.

POST. Power-on self-test.

power mode. A mode of battery operation to conserve power. The ThinkPad computer has three power modes: High Performance, Automatic, and Customize.

prompt. A visual or audible message sent by a program to request the user's response.

pull-down menu. On the display screen, a menu that emerges in a downward direction from a point or line at or near the top of the screen.

reboot. To restart all operations of the computer as if the power had just been turned on.

resume. To begin computer operations again from suspend mode.

ROM. Read-only memory.

SDRAM. Synchronous dynamic random access memory.

serial port. A port used to attach such devices as display devices, letter-quality printers, modems, plotters, and such pointing devices as light pens and mice; it transmits data 1 bit at a time.

suspend. To stop all operations of the computer to reduce power drain and restrict access to the files.

SVGA. Super VGA.

TFT. Thin-film transistor.

TrackPoint. The built-in pointing device of the ThinkPad computer.

TSRs. Terminate-and-stay-resident programs, memory-resident programs that are loaded into memory and stay there so you can conveniently access them whenever you need to.

USB. Universal serial bus.

vertical expansion. A video display technique in character-display mode to fit video images on the whole LCD screen by adjusting the number of character dots vertically.

VESA. Video Electronics Standards Association.

VGA. Video graphics array, a video mode that produces up to 640-by-480 resolution.

VSYNC. Vertical synchronization frequency.

XMS. Extended memory specification.

Index

A

activating the alarm 101
America Online 144
auto-disable, TrackPoint 51, 92

B

backing up 30, 133
 creating diskettes 133
battery
 maximizing the life 94, 158
 problems 117
 recharging 94
 replacing 32
 status, checking 14
boot
 optimizing 19
 sequence, setting 20
built-in devices, setting up 25
Bulletin Board System (BBS) 143

C

calculating memory size 43
CardBus Card, secondary 102
CardBus sockets, enabling 65
carrying the computer 158
CD-ROM
 changing properties 97
changing
 password 74
 volume 15, 131
cleaning the computer 158
Client Support Line 146
color, changing screen 18
COM port, setting 98
CompuServe 144
ConfigSafe 31
configuration

configuration (*continued*)
 program 25
 setup 18
corrective service diskettes (CSDs) 150
CRT
 See external monitor
cursor
 See TrackPoint
cursor drift 11
customizing
 built-in device 25
 system 30
 TrackPoint 36

D

date, setting 19
DIMM
 installing 40
 removing 43
disabling
 numeric keypad, keyboard 16
 standby timer 90
 TrackPoint 51
 turnoff timer, LCD 90
diskette drive, external 8
Diskette Factory 30
 using 133
display
 See also external monitor
 See also LCD
 output location, changing 53
 switching between LCD and external
 monitor 14
docking, port replicator 64
drivers
 Diskette Factory 30
 Web site, getting from 31

E

- Easy-Setup 17
 - password 68
 - testing 131
- EasyServ 142
- EDO DRAM 39
- electronic bulletin boards 143
- enabling
 - infrared port 90
 - numeric keypad, keyboard 16
 - TrackPoint 51
- Enhanced PC Support Line 146
- ergonomics information 159
- error codes 106
- error messages 106
- expanding screen 15
- external diskette drive 8
- external keyboard
 - problems 112
 - setting 49
 - using with numeric keypad 49
- external monitor
 - changing display output location 53
 - plug-and-play 93
 - problems 124
 - resolutions 54, 92
 - setting 52, 92
 - switching to LCD 14
- external mouse
 - problems 112
 - setting 47, 92
 - using with external numeric keypad 48
 - using with TrackPoint, restrictions 51
- external numeric keypad
 - using with external mouse 48

F

- fax, help by 143
- floppy disk drive
 - See external diskette drive
- Fn key combination 14
- function keys and Fn key 13

H

- handling tips 157
- hard disk
 - problem 118
 - recovering contents 30
 - upgrading 45
- hard-disk-drive password 68
 - changing 74
 - forgetting 73
 - removing 74
 - setting 70
- hibernation mode
 - entering 14
 - problems 113
 - restrictions with PC Card 32
 - using CD-ROM drive with, for Windows 95 97
 - with HPFS format, for OS/2 98
 - with NTFS format, for Windows NT 97

I

- IBM Bulletin Board System 143
- increasing storage capacity 45
- indicator 6
 - problems 117
- infrared port
 - enabling 90
 - problems 118
- input problems 112
- installing
 - memory 40
 - PC Card 56
 - software 94
- International Warranty Service Certificate 142

K

- keyboard
 - See external keyboard
- keyboard function
 - Fn key 13
 - numeric keypad 16

keyboard function (*continued*)
TrackPoint 10

L

LAN remote operation, enabling 23
LCD
 problems 116
 switching to external monitor 14
 turnoff timer, disabling 90
location
 bottom view 5
 front view 2
 rear view 4
lock, mechanical 84

M

memory 39
 increasing 45
 installing 40
 removing 43
 shortage
 for DOS 99
 for Windows 3.1 98
microphone
 using 102
modem, PC Card
 restrictions 60
 setting, for OS/2 99
monitor
 See external monitor
mouse
 See external mouse
 See TrackPoint
muting
 microphone 103
 sound 15

N

NetMeeting 103
network administration, enabling 23
Network Support Line 147
numeric keypad, setting
 external 47

numeric keypad, setting (*continued*)
 keyboard 16

O

online services 144
Online User's Guide, using 29
operating system, reinstalling 30
option problems 127

P

password 68
 changing 74
 character, setting 71
 displaying prompt 69
 entering 69
 removing 74
 setting 70
 supervisor authority 78
PC Card
 installing 56
 modem, using 60
 restrictions 60
 setting, for OS/2 99
 problems 120
 removing 59
 restrictions 101
 stopping 101
 types 56
PC Card modem
 restrictions 60
 setting, for OS/2 99
PC Support Line 146
Personalization Editor
 deleting 83
 setting 80
pointer
 See TrackPoint
port replicator 63
 problems 125
 restrictions 63
 suspend mode, in 65
power cord 154
power management, using 101
power-on password 68

- power-on password (*continued*)
 - changing 74
 - removing 74
 - setting 70
 - press-to-select, TrackPoint 36
 - printer problem 123
 - problems, troubleshooting guide 104
 - processor speed, changing 14
 - Prodigy 144
 - profile setting 145
 - protecting data 31
 - publications, ordering 150
- R**
- recovering software 133
 - Recovery CD 30
 - restrictions 135
 - using 135
 - reinstalling software 94, 133
 - remote operation, enabling 23
 - removing
 - memory 43
 - password 74
 - PC Card 59
 - resolutions 54
 - restoring system files 31
 - restrictions
 - external mouse with TrackPoint 51
 - hibernation mode with PC Card 32
 - PC Card 101
 - PC Card modem 60
 - port replicator 63
 - suspend mode with PC Card 56
 - TrackPoint with external mouse 51
 - RPL, setting 24
 - ruggedized mobile computer 158
- S**
- safety information xiii
 - screen
 - color changing 18
 - expanding or shrinking 15
 - problems 111, 116
 - resolutions, setting 92
 - screen (*continued*)
 - setting 90
 - SDRAM 39
 - security
 - mechanical lock 84
 - password 68
 - Personalization Editor 80
 - screw 85
 - security screw, using 85
 - sensitivity, TrackPoint 38
 - serial connector
 - problem 128
 - setting 91
 - Server Support Line 147
 - service
 - for DOS or OS/2 150
 - getting 141
 - ServicePacks 150
 - setup 17
 - shrinking screen 15
 - simple boot flag function 19
 - snapshots of system files 31
 - software problems 129
 - sound, muting 15
 - Space Saver Keyboard, using 50
 - specifications 153
 - standby mode, entering 14
 - startup
 - optimizing 19
 - sequence, setting 20
 - storage capacity, increasing 45
 - supervisor password 69
 - changing 76
 - forgetting 73
 - removing 76
 - setting 70
 - support line 146
 - ordering services 148
 - suspend mode
 - entering 14
 - problems 113
 - restrictions with PC Card 56
 - using CD-ROM drive with, for Windows 95 97
 - system files, restoring 31
 - system-status indicator 6
 - problems 117

T

- telephone, help by 141
- testing 131
- ThinkPad Configuration program 25
 - for DOS 100
 - window, for Windows 98 26
 - window, for Windows NT 27
- ThinkPad Customization CD 30
 - using 133
- ThinkPad Space Saver Keyboard 50
- ThinkPad Web site 31
 - help by 141
- time, setting 19
- token-ring operation, setting up for 24
- TrackPoint 10
 - changing the cap 12
 - customizing 36
 - disabling 51
 - enabling 51
 - using 11
 - with external mouse, restrictions 51
- troubleshooting
 - battery problems 117
 - error codes 106
 - error messages 106
 - external monitor problems 124
 - hard disk drive problem 118
 - hibernation problems 113
 - indicator problems 117
 - infrared communication problems 118
 - input problems 112
 - LCD problems 116
 - no error code 111
 - no error message 111
 - other option problems 127
 - other problems 129
 - PC Card problems 120
 - port replicator problems 125
 - printer problem 123
 - software problems 129
 - suspend problems 113
 - universal serial bus (USB) problem 119

U

- undocking, port replicator 64
- update diskettes, getting 150
- updating a configuration file 102
- upgrading hard disk 45
- USB
 - camera, enabling 97
 - connector, consideration 102
 - problem 119

V

- virtual screen function 55
- volume, changing 15, 131

W

- Wake on LAN, enabling 23
- warranty 161
 - period extending 149
 - repair 149
- Web site 31
 - help by 141

Free Manuals Download Website

<http://myh66.com>

<http://usermanuals.us>

<http://www.somanuals.com>

<http://www.4manuals.cc>

<http://www.manual-lib.com>

<http://www.404manual.com>

<http://www.luxmanual.com>

<http://aubethermostatmanual.com>

Golf course search by state

<http://golfingnear.com>

Email search by domain

<http://emailbydomain.com>

Auto manuals search

<http://auto.somanuals.com>

TV manuals search

<http://tv.somanuals.com>