

Lenox Sound[®]

COMPACT DISC PLAYER

AM/FM STEREO CASSETTE RECORDER

MODEL CD-102

OPERATING INSTRUCTIONS

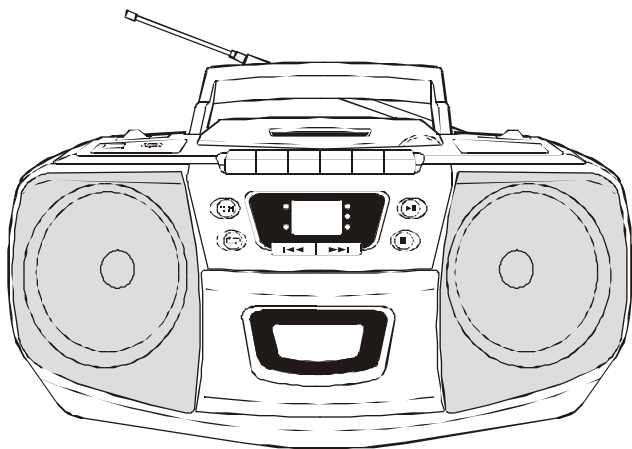

- **PLAYS ALL MUSIC COMPACT DISCS**
- **FULLY PROGRAMMABLE CD PLAYER WITH REPEAT**
- **RECEIVES AM/FM STEREO BROADCASTS**
- **RECORDS FROM CD, RADIO, OR BUILT-IN MICROPHONE**
- **FM STEREO AND POWER LED INDICATORS**
- **2 WAY POWER - AC/DC**
- **REQUIRES 6 SIZE "C" BATTERIES (not included)**

PLEASE READ CAREFULLY BEFORE USE

Download from www.Somanuals.com. All Manuals Search & Download here.



SAFETY INSTRUCTIONS



The lightning flash and arrow head within the triangle is a warning sign alerting you of "dangerous voltage" inside the product.

CAUTION

**RISK OF ELECTRIC SHOCK
DO NOT OPEN**

CAUTION: TO REDUCE THE RISK OF ELECTRIC SHOCK, DO NOT REMOVE COVER (OR BACK). NO USER SERVICEABLE PARTS INSIDE. REFER SERVICING TO QUALIFIED SERVICE PERSONNEL.



The exclamation point within the triangle is a warning sign alerting you of important instructions accompanying the product.

SEE BOTTOM OF THE SET

WARNING: TO REDUCE THE RISK OF FIRE OR ELECTRIC SHOCK, DO NOT EXPOSE THIS APPLIANCE TO RAIN OR MOISTURE.

THESE IMPORTANT SAFETY INSTRUCTIONS ARE INCLUDED, AS APPLICABLE TO THE APPLIANCE, CONVEYING TO THE USER THE INFORMATION ITEMIZED BELOW:

1. **Read Instructions** - All the safety and operating instructions should be read before the appliance is operated.
2. **Retain Instructions** - The safety and operating instructions should be retained for future reference.
3. **Heed Warnings** - All warnings on the appliance and in the operating instructions should be adhered to.
4. **Follow Instructions** - All operating and use instructions should be followed.
5. **Water and Moisture** - The appliance should not be used near water - for example near a bathtub, washbowl, kitchen sink, laundry tub, in a wet basement, or near a swimming pool, and the like.
6. **Wall or Ceiling Mounting** - The appliance should not be mounted to a wall or ceiling.
7. **Ventilation** - The appliance should be situated so that its location or position does not interfere with its proper ventilation. For example, the appliance should not be situated on a bed, sofa, rug, or similar surface that may block the ventilation openings; or, placed in a built-in installation, such as a bookcase or cabinet that impede the flow of air through the ventilation openings.
8. **Heat** - The appliance should be situated away from heat sources such as radiators, heat registers, stoves, or other appliances (including amplifiers) that produce heat.
9. **Power Sources** - The appliance should be connected to a power supply only of the type described in the operating instructions or as marked on the appliance.
10. **Grounding or Polarization** - Precautions should be taken so that the grounding or polarization means of an appliance is not defeated.
11. **Power Cord Protection** - Power supply cords should be routed so that they are not likely to be walked on or pinched by items placed upon or against them, paying particular attention to cords at plugs, convenient receptacles, and the point where they exit from the appliance.
12. **Cleaning** - The appliance should be cleaned only as recommended by the manufacturer.
13. **Nonuse periods** - The power cord of the appliance should be unplugged from the outlet when left unused for a long period of time.

SAFETY INSTRUCTIONS

14. **Object and Liquid Entry** - Care should be taken so that objects do not fall and liquids are not spilled into the enclosure through openings.
15. **Damage Requiring Service** - The appliance should be serviced by qualified service personnel when:
 - A. The power supply cord or the plug has been damaged; or
 - B. Objects have fallen, or liquid has been spilled into the appliance; or
 - C. The appliance has been exposed to rain; or
 - D. The appliance does not appear to operate normally or exhibits a marked change in performance; or
 - E. The appliance has been dropped, or the enclosure damaged.
16. **Servicing** - The user should not attempt to service the appliance beyond that described in the operating instructions. All other servicing should be referred to qualified service personnel.
17. **Power lines** - An outdoor antenna should be located away from power lines.
18. **Outdoor Antenna Grounding** - If an outside antenna is connected to the receiver, be sure the antenna system is grounded so as to provide some protection against voltage surges and built up static charges. Section 810 of the National Electrical Code, ANSI/NFPA 70 provides information with respect to proper grounding of the mast and supporting structure, grounding of the lead-in wire to an antenna discharge unit, size of grounding conductors, location of antenna-discharge unit, connection to grounding electrodes, and requirements for the grounding electrode. See Figure.

EXAMPLE OF ANTENNA GROUNDING AS PER
NEC - NATIONAL ELECTRICAL CODE

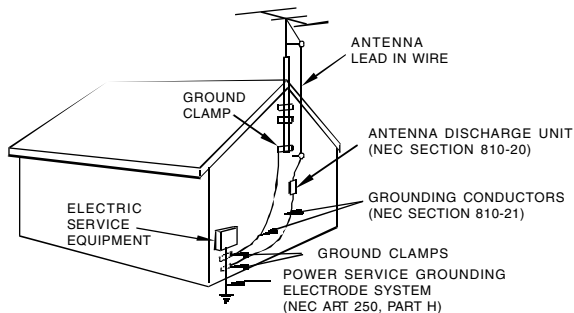

It is the intent of Lenoxx that this product be used in full compliance with the copyright laws of the United States and that prior permission be obtained from copyright owners whenever recording songs from the RADIO or CD's.

Do not apply oil or petroleum products or solvents to any part of this set.

CAUTION

Use of controls or adjustments or performance of procedures other than those specified herein may result in hazardous radiation exposure.
This compact disc player is classified as CLASS 1 LASER PRODUCT as stated on the bottom of the set.

BATTERY SAFETY INSTRUCTIONS

CAUTION: TO REDUCE THE RISK OF FIRE OR PERSONAL INJURY OR DAMAGE TO YOUR SET, READ AND FOLLOW THESE INSTRUCTIONS.

1. Use only the type and size of batteries mentioned in the operating instructions booklet (batteries are not included with this set, please buy the proper batteries).
2. Do not dispose of the batteries into a fire. The cells may explode. Check with local codes for possible special disposal instructions.
3. Do not open or mutilate the batteries. Released electrolyte is corrosive and may cause damage to the eyes or skin. It may be toxic if swallowed.
4. Be careful when handling batteries in order not to short the battery with conducting materials such as rings, bracelets and keys. The battery or conductor may over heat and cause burns.
5. Do not attempt to recharge non-rechargeable batteries. The batteries may leak corrosive electrolyte or explode.
6. Do not attempt to rejuvenate the batteries identified for use with this product by heating them. Sudden release of the battery electrolyte may cause burns or irritation to eyes or skin.
7. All batteries should be replaced at the same time. Mixing fresh and discharged batteries could increase internal cell pressure and rupture the batteries.
8. When inserting batteries into this product, the proper polarity (\oplus and \ominus) or direction must be observed. Reverse insertion of some or all of the batteries may result in battery electrolyte leakage or explosion.
9. Remove the batteries from this product if the product will not be used for a long period of time (several months or more) since during the period the batteries could leak, damaging the product.
10. Discard weak or dead batteries as soon as possible since they are more likely to leak in the product. Batteries should be replaced (depending on the product) when the display gets dim or if the Low Battery Indicator shows or if the sound gets distorted.
11. Do not store this product in high temperature areas. Batteries that are stored in a freezer or refrigerator for the purpose of extending shelf life should be protected from condensation during storage and defrosting. Batteries should be stabilized at room temperature prior to use after cold storage.
12. If this product does not operate normally, see TROUBLE SHOOTING in this instruction manual. If you can't resolve the problem, or if the product is damaged, refer to the LENOXX WARRANTY INFORMATION. Opening or removing covers may expose you to dangerous voltages or other risks. Incorrect reassembly can cause electric shock when the appliance is subsequently used.
13. If liquid leaks from the batteries, carefully wipe this liquid. Do not allow it to touch your skin, and discard the leaking batteries.
14. Do not mix batteries (OLD and NEW or CARBON and ALKALINE, etc.).
15. The use of rechargeable batteries is not recommended for this set because their voltage and life is lower than standard batteries.
16. Installation of batteries should be done by an adult only.

SAVE THESE INSTRUCTIONS

CHOOSING THE POWER SOURCES

You can use the AC power or batteries as a power source.

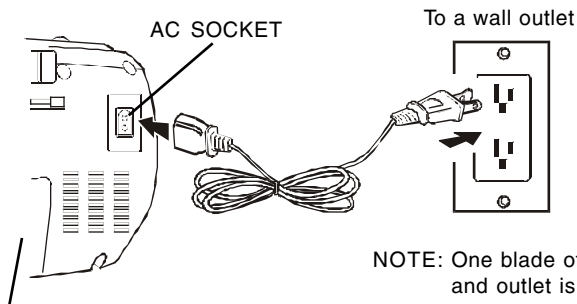

Battery compartment

TIP

If the plug of the AC power cord does not match your wall outlet, do not force it. Reverse it and try again. The plugs are polarized and only fits one way into the wall outlet and back of the set.

TIP

Replace the batteries when the POWER lamp dims or when the player stops operating. Replace all the batteries with new ones. Before you replace the batteries, be sure to take out the CD from the player and remember to check the Battery Safety Instructions on Page 3.

1. Connecting the AC power cord

Insert one end of the supplied AC power cord (located in the battery compartment) into the socket located at the rear of the player, and the other end to the wall outlet.

2. Using the player on batteries

Insert 6 size "C" batteries (not supplied) into the battery compartment.

To use the player on batteries, disconnect the AC power cord from the player.

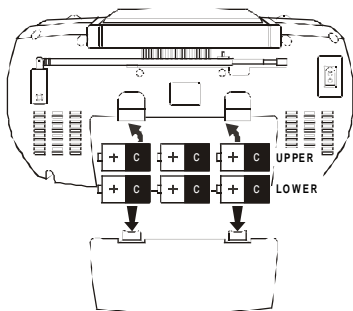

PLAYING A CD

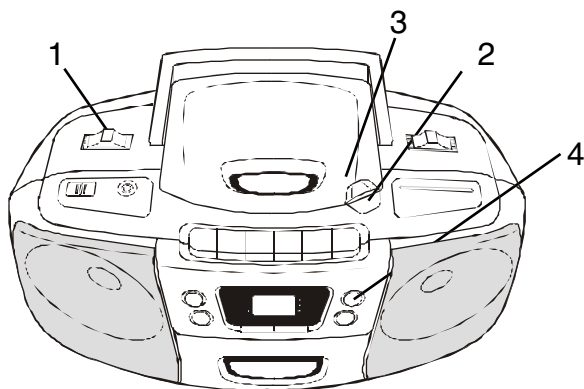

Connect the supplied AC power cord or batteries (see page 4).

1

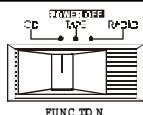

Slide the **FUNCTION** switch to **CD** position (power on), the **POWER** lamp will be on.

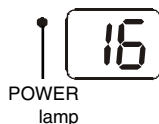

2

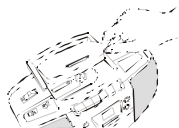

Lift the right corner of the **CD DOOR** to open it and place the **CD** in the **CD compartment**. The label side of the **CD** should face upward.



3

Close the **CD DOOR** by pushing it down. The display will show the total tracks on that **CD**.



4



**PLAY/
PAUSE**

Press the **CD PLAY/PAUSE** button. The **PLAY/PAUSE** lamp will be steady on, the player plays all the tracks once.

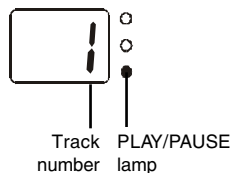

USE THESE BUTTONS FOR ADDITIONAL OPERATIONS

VOLUME CONTROL
(at the left side of the set)

OPEN THE CD DOOR
BY LIFTING HERE

FUNCTION SWITCH

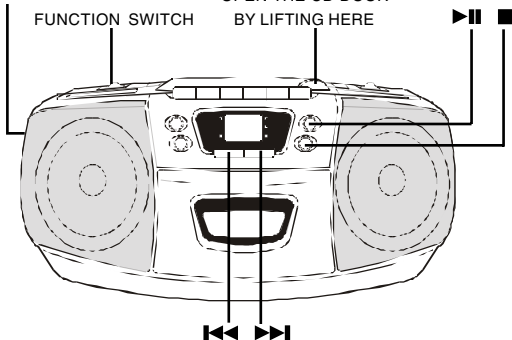

TIP

When CD play is paused, the PLAY/PAUSE lamp will flash and no music will play.

To resume play, press the PAUSE button again, the PLAY/PAUSE lamp will stop flashing and music will play.

TIP

If you bump the set during CD play, the music will stop or skip for a few seconds. This is normal for this type of player.

To	Press or Adjust
Adjust the volume	VOLUME control
Stop playback	■
Pause playback	▶▶ The PLAY/PAUSE lamp will flash during pause. Press again to resume play after pause.
Go to the next track	▶▶ FORWARDS
Go back to the previous track	◀◀ BACKWARDS
Locate a point in a song	◀◀ or ▶▶ Press and hold down while playing until you find the point.
Remove the CD	Lift the CD DOOR (press STOP first)
Turn off the power	Slide the FUNCTION switch to TAPE position

LISTENING TO THE RADIO

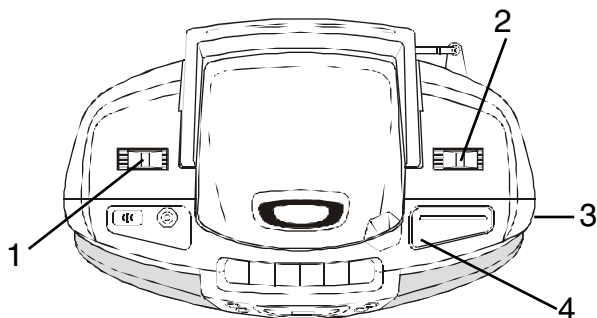

Connect the supplied AC power cord or batteries (see page 4).

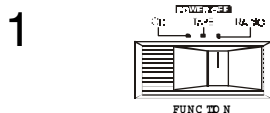

Slide the FUNCTION switch to RADIO position, the POWER lamp will be on.

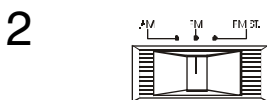

Slide the BAND switch to the proper band position (AM, FM, or FM STEREO) that you want.



Tune into the station you prefer using the TUNING control (at the right side of the set). Adjust for the clearest sound.



This indicator will light up when receiving FM Stereo broadcasts.

USE THESE BUTTONS FOR ADDITIONAL OPERATIONS

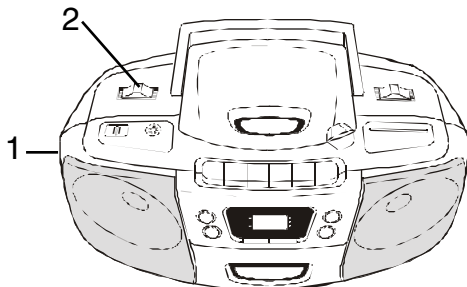

TIP

- If the FM broadcast is noisy, slide the BAND switch from FM Stereo to FM position (MONO).
- Next time you want to listen to the radio, just slide the FUNCTION switch to RADIO. The player automatically starts playing the previously tuned station.

To	Slide or Adjust
Adjust the volume	VOLUME control (at the left side of the set)
Turn off the Radio	Slide the FUNCTION switch to TAPE position

To improve broadcast reception

Change position of the antenna for FM or FM Stereo.
Move the set itself for AM.

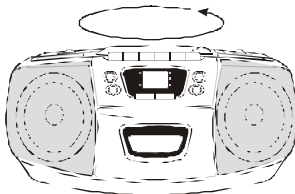
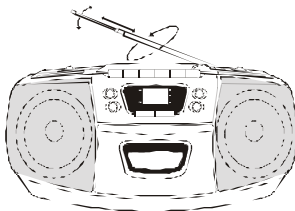

PLAYING A TAPE

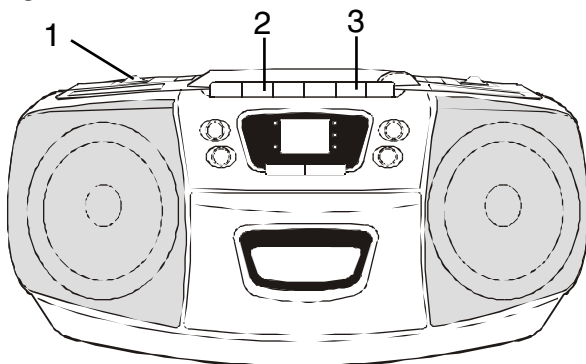

Connect the supplied AC power cord or batteries (see page 4).

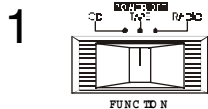

Slide the **FUNCTION** switch to **TAPE** position.



Press the **STOP/EJECT** button to open the tape compartment and insert a recorded tape. Close the door.

INSERT TAPE THIS WAY
FULL REEL ON RIGHT



Press the **PLAY** button. The player turns on and starts playing.



When the set finishes playing this side of the tape, the set will stop. To hear the other side of the tape, flip the tape over, then insert and press **PLAY**.

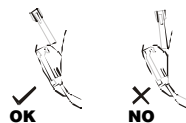

USE THESE BUTTONS FOR ADDITIONAL OPERATIONS

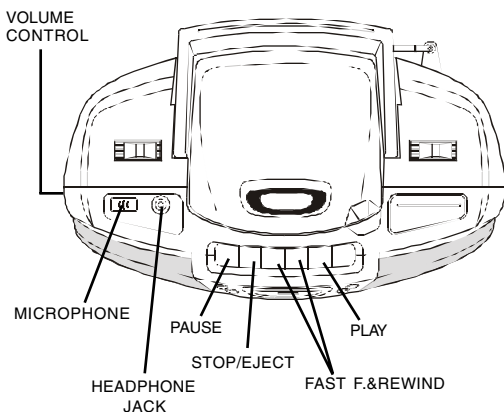

To	Press or Adjust
Adjust the volume	VOLUME control (at the left side of the set)
Stop playback	STOP/EJECT button
Fast forward or rewind the tape	FAST FORWARD button or REWIND button
Pause playback	PAUSE button Press again to resume play after pause.
Eject the cassette	STOP/EJECT button
To enjoy the music without disturbing others	Insert your headphone plug into the HEADPHONE Jack
To shut power off	Make sure cassette buttons are all up (stop) and FUNCTION switch is in the center position (power off).

RECORDING ON A TAPE

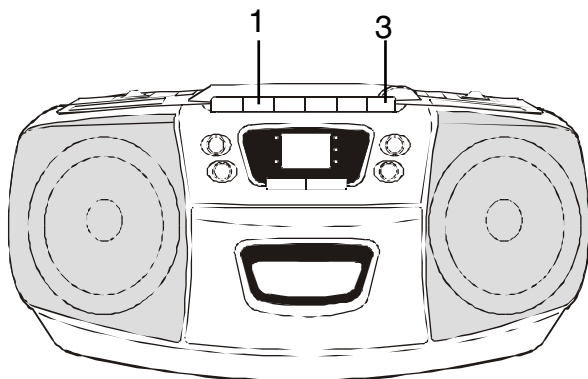

Connect the supplied AC power cord or batteries (see page 4).

1 
STOP/EJECT

Press the STOP/EJECT button to open the tape compartment and insert a blank tape. Select the program source (AM, FM, CD, or, built-in microphone) you want to record.

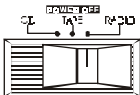

2 

To record from the CD player, insert a CD and follow the steps to play a CD (see page 5).

To record from a radio, slide the FUNCTION switch to RADIO, and tune into the station you want (see page 7).

INSERT TAPE THIS WAY
FULL REEL ON RIGHT



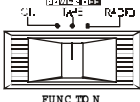

To record from the built-in microphone, leave the FUNCTION switch at the TAPE position, and speak in front of the set.

3 
RECORD

Press the RECORD button to start recording. (The PLAY button is depressed automatically.)

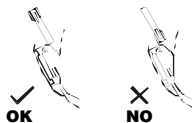

4 
REWIND PLAY

To hear what you recorded, slide the FUNCTION switch to TAPE position, then press REWIND and PLAY.

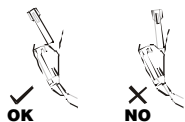

USE THESE BUTTONS FOR ADDITIONAL OPERATIONS

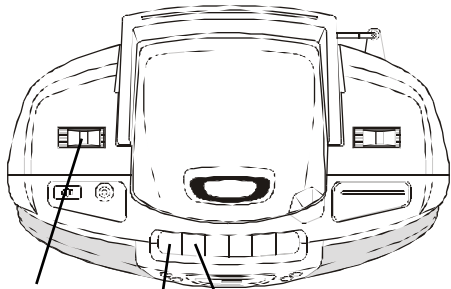

TIP

- For best recording effect, use the AC power instead of batteries.
- To erase a recording, just start a new recording, and the old one is automatically replaced.

To	Press or Adjust
Stop recording	STOP/EJECT button
Pause recording	PAUSE button Press the button again to resume recording.
Turn off the power	Press the STOP/EJECT button and slide the FUNCTION switch to TAPE position.

PLAYING CD TRACKS REPEATEDLY (REPEAT PLAY)

You can play CD tracks over and over in normal or program play modes (see page 14).

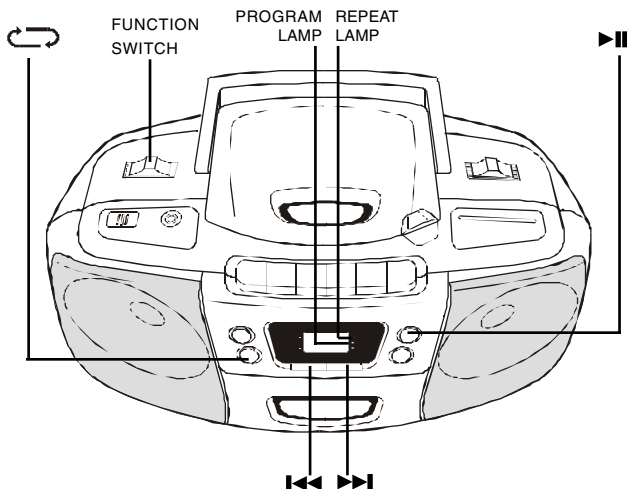

1. Slide the FUNCTION switch to CD position.
2. Select the track by pressing **⏮** or **⏭**, and then press **⏸**.
3. Press the CD REPEAT button.

To repeat	Press	Repeat Lamp
a single track (song)	Press the REPEAT button once	Flashing
all the tracks (all songs)	Press the REPEAT button twice	Steady on
programmed tracks	During programmed play, press the REPEAT button twice	Steady on (the PROGRAM lamp also on)

To cancel Repeat Play

Press the REPEAT button until the REPEAT lamp goes off.

SELECTING YOUR OWN MUSIC PLAYING ORDER (Programmed Play)

You can make a program of up to 16 tracks in the order you want them to be played.

NOTE: Programming is only done during stop mode.

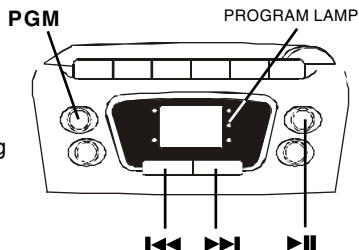

1. Slide the FUNCTION switch to CD position.
2. Press the PROGRAM button. The letters "Pr" and the PROGRAM lamp will flash.
3. Press ►► or ◀◀ to select the tracks you want to program in the order you want.
4. Press the PROGRAM button to confirm. The letters "Pr" and the PROGRAM lamp will flash.
5. Repeat steps 3 and 4. You can program up to 16 tracks.
6. Press ►|| to start program play. The PROGRAM lamp will be steady on.

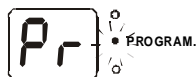

To check the order of tracks before play

Press the PROGRAM button, the programmed track number appears in the display automatically.



To change the current program

Just create a new program following the programming procedure.

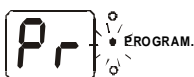

To cancel Program Play

Press the STOP button twice and the PROGRAM lamp goes off.



PRECAUTIONS

On Safety

- As the laser beam used in the CD player section may be harmful to the eyes, do not attempt to disassemble the cabinet. Refer servicing to qualified personnel only.
- Should any solid object or liquid fall into the player, unplug the player, and have it checked by qualified personnel before operating it any further.

On Placement

- Do not leave the player in a location near a heat source, or in a place subject to direct sunlight, excessive dust or mechanical shock.
- Do not place the player on an inclined or unstable place.
- Do not place anything within 1 inch of the back of the cabinet. The ventilation holes must not be covered for the player to operate properly and prolong the life of its components.
- If the player is left in a car parked in the sun, be sure to choose a location in the car where the player will not be subjected to the direct rays of the sun.
- Since a strong magnet is used for the speakers, keep personal credit cards using magnetic coding or springwound watches away from the player to prevent possible damage from the magnets.

On Power Sources

- For battery operation, use 6 size C batteries. We recommend alkaline batteries for longer life.
- When the batteries will not be used for a few weeks or more, remove them to avoid damage that can be caused by battery leakage or corrosion.

On Operation

- If the player is brought directly from a cold to a warm location, or is placed in a very damp room, moisture may condense on the lens inside the CD player section. Should this occur, the player will not operate properly. In this case, remove the CD and wait about an hour for the moisture to evaporate. If the player has not been used for a long time, set it in the playback mode to warm it up for a few minutes before inserting a cassette.
- This CD player is designed to be played on a stable no vibration position. If you bump the set during CD play, the music will stop or skip for a few seconds. This is normal for this type of player.
- If you have any questions or problems concerning your player, please contact our customer service department at 1-800-315-5885.
(Monday - Thursday 09:00 AM - 05:00 PM, Friday 09:00 AM - 01:00 PM EST)

PRECAUTIONS (continued)

Notes on CDs

- Before playing, clean the CD with a cleaning cloth. Wipe the CD from the center out.



- Do not use solvents such as benzene, thinner, commercially available cleaners or anti-static spray intended for vinyl LPs.
- Do not expose the CD to direct sunlight or heat sources such as hot air ducts, nor leave it in a car parked in direct sunlight as there can be a considerable rise in temperature inside the car.
- Do not stick paper or stickers on the CD, nor scratch the CD.
- After playing, store the CD in its case. If there is a scratch, dirt or fingerprints on the CD, it may cause a tracking error or skipping.

Notes on Cassettes

- Break off the cassette tab from side A or B to prevent accidental recording.

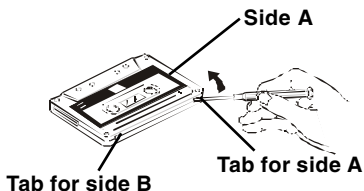

- To record on a tape with its tab broken off, cover the respective tab hole for side A or B with adhesive tape.
- The use of a cassette with more than 90 minutes of play time is not recommended except for long continuous recording or playback.
- To reduce the chances of tape jamming or tangling, you should check that there are no loose layers of tape visible through the cassette center window. If any, tighten these loose layers of tape using a pencil before inserting the cassette into the set.

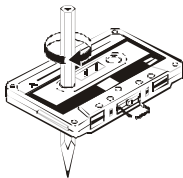

MAINTENANCE

Cleaning the Lens

If the lens becomes dirty, it may cause a skipping of sound during CD operation. Clean with a commercially available lens cleaner and blower.

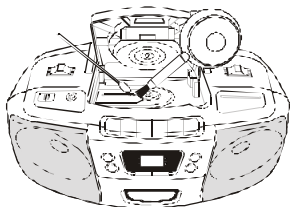

Notes for Storing Cassette Tapes

1. Do not put a tape near a magnetic field, such as a TV, or speaker. Magnetic fields may reduce the tape sensitivity or even erase the recording.
2. Do not store tape for any length of time in a hot, moist or dusty place.

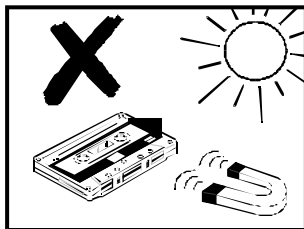

Cleaning the Tape Heads

Wipe the heads, the pinch roller and the capstan with a cleaning swab slightly moistened with cleaning fluid or alcohol after every 10 hours of operation for optimum playback and recording quality. After cleaning, insert a tape when the areas cleaned are completely dry.

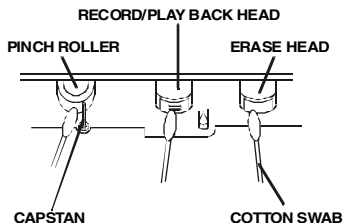

Cleaning the Cabinet

Clean the cabinet, panel and controls with a soft cloth slightly moistened with a mild detergent solution. Do not use any type of abrasive pad, scouring powder, or solvent, such as alcohol or benzene.

NOTE: In order to see and clean the head, you may have to press PLAY first.

TROUBLE SHOOTING

	Problem	Remedy
General	The power is not on.	<ul style="list-style-type: none">• Connect the AC power cord to a wall outlet securely.• Make sure the batteries are inserted correctly and they are fresh.
	There is no sound.	<ul style="list-style-type: none">• Make sure the FUNCTION switch is at the right position as you want.• Adjust the volume.• Unplug the headphones when listening through speakers.
	"00" appears in the display even when a CD is in place.	<ul style="list-style-type: none">• Insert the CD with the label side up.
CD player	CD does not play.	<ul style="list-style-type: none">• Make sure that the CD compartment is closed.• Place the CD with the label side up.• Clean the CD.• Take out the CD and leave the CD DOOR open for about an hour to dry moisture condensation.• Make sure the FUNCTION switch is at CD position.
	The sound drops out.	<ul style="list-style-type: none">• Clean the CD, or replace it if the CD is badly damaged.• Place the player in a location free from vibration.• Check if your batteries are fresh.
	The sound is weak or has poor quality.	<ul style="list-style-type: none">• Replace all the batteries with new ones if they are weak, or bring the set near a window, or rotate the set.
Radio	The RECORD button does not function/The tape does not play.	<ul style="list-style-type: none">• Make sure the safety tab on the cassette is in place.• Make sure the FUNCTION switch is at TAPE position.
	The tape does not erase completely.	<ul style="list-style-type: none">• Clean the erasing head (see page 17).• Replace all the batteries with new ones if they are weak.
	The tape does not record.	<ul style="list-style-type: none">• Make sure the tape is inserted properly.• Make sure the safety tab of the cassette is in place.
	The sound is weak/The sound quality is poor.	<ul style="list-style-type: none">• Clean the heads, pinch roller and capstan (see page 17).
	Cassette PLAY button pops up.	<ul style="list-style-type: none">• The tape has reached its end. Remove it, flip to the other side and re-insert.

SPECIFICATION

General Description

Power source:	AC 120V, 60Hz 12Watts DC 12V (6 size "C" batteries) (Alkaline batteries are recommended)
Speakers:	2 - 3 ¹ / ₂ " 8 ohm
Output power:	1.5W/channel
Dimensions:	Width: 14 1/2" Depth: 8" Height: 6 3/4" Weight: 5LBs (without batteries)

CD Section

Plays disc type:	Any normal CD used in portable players	
Laser wavelength:	760 - 800 NM	
Tracking method:	3 - spot error detection	3.86 mm lens
Frequency response:	80Hz - 15kHz	

Tape Recorder Section

Frequency response:	Standard normal bias cassette tape, 70 - 10kHz
---------------------	---

Radio Section

Frequency range:	FM: 88 - 108 MHz AM: 530 - 1700 kHz
------------------	--

LENOXX reserves the right to make design and specification changes for product improvement.

PROTECT YOUR FINE FURNITURE!

WE RECOMMEND A CLOTH OR OTHER PROTECTIVE MATERIAL BE PLACED UNDER THE SET WHEN PLACING IT ON SURFACE WITH A NATURAL OR LACQUER FINISH.

For customer service

Dial 1-800-315-5885 (MONDAY - THURSDAY 09:00 AM - 5:00 PM, FRIDAY 09:00 AM - 1:00 PM EST)

or Visit Our Website: <http://www.lenoxx.com>

© 2000 LENOXX ELECTRONICS CORP.
2 GERMAK DRIVE
CARTERET, N.J. 07008
MADE & PRINTED IN CHINA

Free Manuals Download Website

<http://myh66.com>

<http://usermanuals.us>

<http://www.somanuals.com>

<http://www.4manuals.cc>

<http://www.manual-lib.com>

<http://www.404manual.com>

<http://www.luxmanual.com>

<http://aubethermostatmanual.com>

Golf course search by state

<http://golfingnear.com>

Email search by domain

<http://emailbydomain.com>

Auto manuals search

<http://auto.somanuals.com>

TV manuals search

<http://tv.somanuals.com>