

Lenox Sound[®]

COMPACT DISC PLAYER

AM/FM STEREO CASSETTE RECORDER

MODEL CD-104

OPERATING INSTRUCTIONS

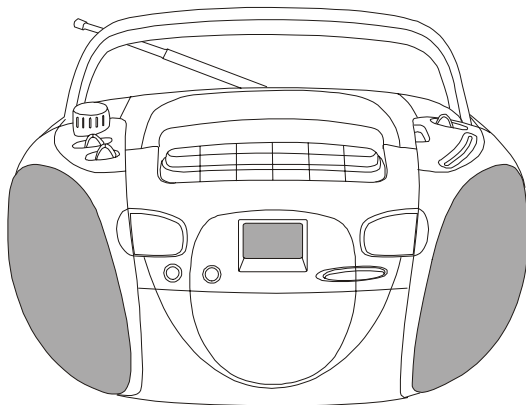

- **PLAYS MUSIC COMPACT DISCS**
- **FULLY PROGRAMMABLE CD PLAYER WITH REPEAT**
- **RECEIVES AM/FM STEREO BROADCASTS**
- **RECORDS FROM CD, RADIO, OR BUILT-IN MICROPHONE**
- **FM STEREO AND POWER LED INDICATORS**
- **2 WAY POWER - AC/DC**
- **REQUIRES 8 SIZE "C" BATTERIES (not included)**

PLEASE READ CAREFULLY BEFORE USE

IB-CD104(TA)-FD-E-043002

Download from [Www.Somanuals.com](http://www.Somanuals.com). All Manuals Search And Download.

WARNING

TO PREVENT FIRE OR SHOCK HAZARD, DO NOT USE THE PLUG WITH AN EXTENSION CORD, RECEPTACLE OR OTHER OUTLET UNLESS THE BLADES CAN BE FULLY INSERTED TO PREVENT BLADE EXPOSURE. TO PREVENT FIRE OR SHOCK HAZARD, DO NOT EXPOSE THIS APPLIANCE TO RAIN OR MOISTURE.



The lightning flash with arrowhead symbol, within an equilateral triangle, is intended to alert the user to the presence of uninsulated "dangerous voltage" within the product's enclosure that may be of sufficient magnitude to constitute a risk of electric shock to persons.

WARNING

**RISK OF ELECTRIC SHOCK
DO NOT OPEN**

WARNING: TO REDUCE THE RISK OF ELECTRIC SHOCK, DO NOT REMOVE COVER (OR BACK). NO USER SERVICEABLE PARTS INSIDE. REFER SERVICING TO QUALIFIED SERVICE PERSONNEL.



The exclamation point within an equilateral triangle is intended to alert the user to the presence of important operating and maintenance (servicing) instructions in the literature accompanying the appliance.

IMPORTANT SAFETY INSTRUCTIONS

1. Read these instructions.
2. Keep these instructions.
3. Heed all warnings.
4. Follow all instructions.
5. Do not use this apparatus near water.
6. Clean only with dry cloth.
7. Do not block any ventilation openings, install in accordance with the manufacturer's instructions.
8. Do not install near any heat sources such as radiators, heat registers, stoves, or other apparatus (including amplifiers) that produce heat.
9. Do not defeat the safety purpose of the polarized or grounding-type plug. A polarized plug has two blades with one wider than the other. A grounding type plug has two blades and a third grounding prong. The wide blade or the third prong are provided for your safety. If the provided plug does not fit into your outlet, consult an electrician for replacement of the obsolete outlet.
10. Protect the power cord from being walked on or pinched particularly at plugs, convenience receptacles, and the point where they exit from the apparatus.
11. Only use attachments/accessories specified by the manufacturer.
12. Unplug this apparatus during lightening storms or when unused for long periods of time.
13. Refer all servicing to qualified service personnel. Servicing is required when the apparatus has been damaged in any way, such as power-supply cord or plug is damaged, liquid has been spilled or objects have fallen into the apparatus, the apparatus has been exposed to rain or moisture, does not operate normally or has been dropped.
14. This appliance shall not be exposed to dripping or splashing water and that no object filled with liquid such as vases shall be placed on the apparatus.

ADDITIONAL SAFETY INSTRUCTIONS

1. **Power Sources** - The appliance should be connected to a power supply only of the type described in the operating instructions or as marked on the appliance.
2. **Wall or Ceiling Mounting** - The appliance should not be mounted to a wall or ceiling.
3. **Object and Liquid Entry** - Care should be taken so that objects do not fall and liquids are not spilled into the enclosure through openings.
4. **Servicing** - The user should not attempt to service the appliance beyond that described in the operating instructions. All other servicing should be referred to qualified service personnel.

It is the intent of Lenoxx that this product be used in full compliance with the copyright laws of the United States and that prior permission be obtained from copyright owners whenever recording songs from the RADIO or CD's.

Do not apply oil or petroleum products or solvents to any part of this set.

CAUTION

Use of controls or adjustments or performance of procedures other than those specified herein may result in hazardous radiation exposure.
This compact disc player is classified as CLASS 1 LASER PRODUCT as stated on the bottom of the set.

BATTERY SAFETY INSTRUCTIONS

CAUTION: TO REDUCE THE RISK OF FIRE OR PERSONAL INJURY OR DAMAGE TO YOUR SET, READ AND FOLLOW THESE INSTRUCTIONS.

1. Use only the type and size of batteries mentioned in the operating instructions booklet (batteries are not included with this set, please buy the proper batteries).
2. Do not dispose of the batteries into a fire. The cells may explode. Check with local codes for possible special disposal instructions.
3. Do not open or mutilate the batteries. Released electrolyte is corrosive and may cause damage to the eyes or skin. It may be toxic if swallowed.
4. Be careful when handling batteries in order not to short the battery with conducting materials such as rings, bracelets and keys. The battery or conductor may over heat and cause burns.
5. Do not attempt to recharge non-rechargeable batteries. The batteries may leak corrosive electrolyte or explode.
6. Do not attempt to rejuvenate the batteries identified for use with this product by heating them. Sudden release of the battery electrolyte may cause burns or irritation to eyes or skin.
7. All batteries should be replaced at the same time. Mixing fresh and discharged batteries could increase internal cell pressure and rupture the batteries.
8. When inserting batteries into this product, the proper polarity (\oplus and \ominus) or direction must be observed. Reverse insertion of some or all of the batteries may result in battery electrolyte leakage or explosion.
9. Remove the batteries from this product if the product will not be used for a long period of time (several months or more) since during the period the batteries could leak, damaging the product.
10. Discard weak or dead batteries as soon as possible since they are more likely to leak in the product. Batteries should be replaced (depending on the product) when the display gets dim or if the Low Battery Indicator shows or if the sound gets distorted.
11. Do not store this product in high temperature areas. Batteries that are stored in a freezer or refrigerator for the purpose of extending shelf life should be protected from condensation during storage and defrosting. Batteries should be stabilized at room temperature prior to use after cold storage.
12. If this product does not operate normally, see TROUBLE SHOOTING in this instruction manual. If you can't resolve the problem, or if the product is damaged, refer to the LENOXX WARRANTY INFORMATION. Opening or removing covers may expose you to dangerous voltages or other risks. Incorrect reassembly can cause electric shock when the appliance is subsequently used.
13. If liquid leaks from the batteries, carefully wipe this liquid. Do not allow it to touch your skin, and discard the leaking batteries.
14. Do not mix batteries (OLD and NEW or CARBON and ALKALINE, etc.).
15. The use of rechargeable batteries is not recommended for this set because their voltage and life is lower than standard batteries.
16. Installation of batteries should be done by an adult only.

SAVE THESE INSTRUCTIONS

CHOOSING THE POWER SOURCES

You can use the AC power or batteries as a power source.

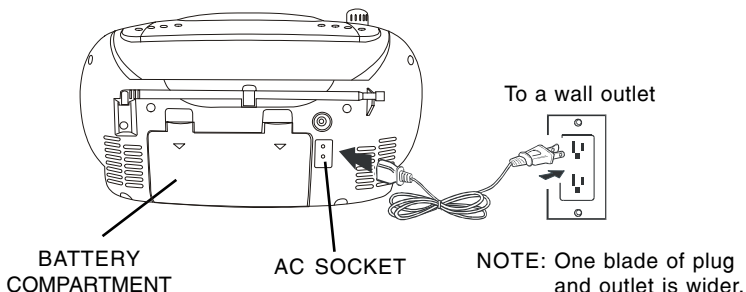

TIP

If the plug of the AC power cord does not match your outlet, do not force it. Reverse it and try again. The plugs are polarized and only fit one way into the wall outlet and back of the set.

TIP

Replace the batteries when the POWER lamp dims or when the player stops operating. Replace all the batteries with new ones. Before you replace the batteries, be sure to take out the CD from the player and remember to check the Battery Safety Instructions on Page 3.

1. Connecting the AC power cord

Insert one end of the supplied AC power cord (located in the battery compartment) into the socket located at the rear of the player, and the other end to the wall outlet.

2. Using the player on batteries

Insert 8 size "C" batteries (not supplied) into the battery compartment.

To use the player on batteries, disconnect the AC power cord from the player.

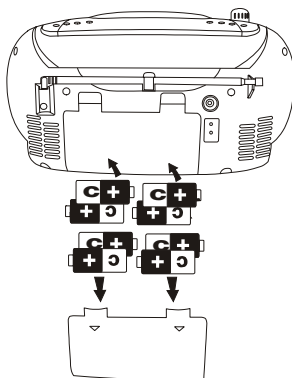

PLAYING A CD

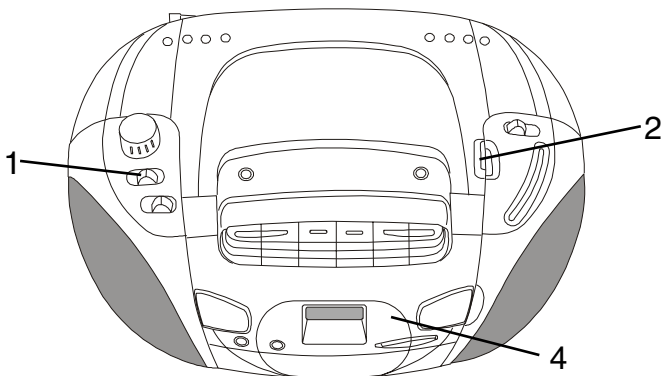

Connect the supplied AC power cord or batteries (see page 4).

- 1** Slide the FUNCTION switch to CD position (power on), the POWER lamp will be on.

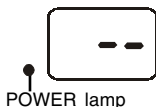

- 2** Lift the right corner of the CD DOOR marked OPEN to open it and place the CD in the CD compartment. The label side of the CD should face upward.

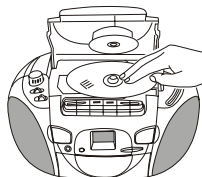

- 3** Close the CD DOOR by pushing it down. The display will show the total tracks on that CD.

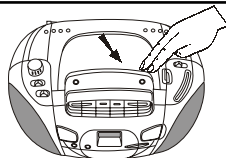

- 4** Press the CD PLAY button, the track number and "PLAY" will show steady on, the player plays all the tracks once.



PLAYING CD TRACKS REPEATEDLY (REPEAT PLAY)

You can play CD tracks over and over in normal or programmed play mode (see page 7).

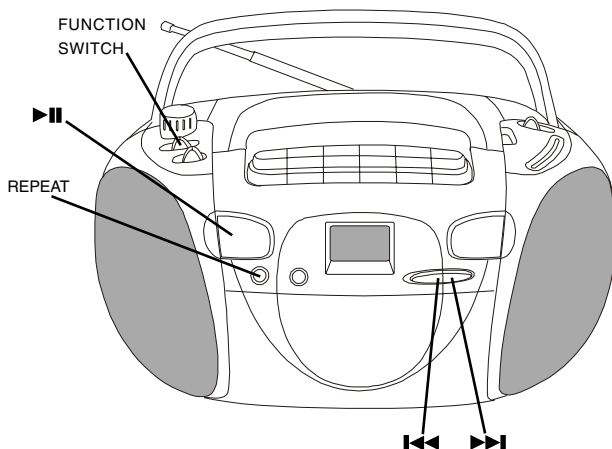

1. Slide the **FUNCTION** switch to CD position.
2. Select the track by pressing **◀◀** or **▶▶** , and then press **▶||** .
3. Press the CD **REPEAT** button.

To repeat	Press	Display shows:
a single track (song)	Press the REPEAT button once	"REP."
all the tracks (all songs)	Press the REPEAT button twice	"REP.A"
programmed tracks	During programmed play, press the REPEAT button twice	"REP.A" & "PROG." flashing

To cancel Repeat Play

Press the **REPEAT** button until **"REP."** and **"REP.A"** go off in the display.

SELECTING YOUR OWN MUSIC PLAYING ORDER (Programmed Play)

You can make a program of up to 19 tracks in the order you want them to be played.

NOTE: Programming is only done during stop mode.

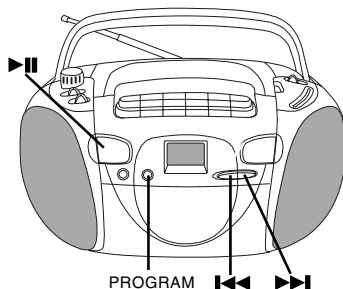

1. Slide the FUNCTION switch to CD position.
2. Press the PROGRAM button. The "PROG." and "00" will flash in the display.
3. Press ►► or ◀◀ to select the tracks you want to program in the order you want.
4. Press the PROGRAM button to confirm.
5. Repeat steps 3 and 4. You can program up to 19 tracks, and the display will show " - - " if you continue to program.
6. Press ►|| to start programmed play. The "PROG." will flash in the display.



To check the order of tracks before play

Press the PROGRAM button, the programmed track number appear in the display automatically every time you press the PROGRAM button.

PROGRAM



To change the current program

Just create a new program following the programming procedure.

PROGRAM

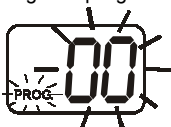

To cancel Programmed Play

Press the STOP button in programming mode.



USE THESE BUTTONS FOR ADDITIONAL OPERATIONS

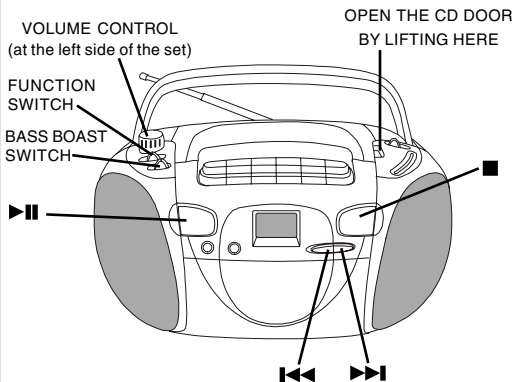

TIP

When CD play is paused, "PLAY" will flash and no music will play.

To resume play, press the PAUSE button again, "PLAY" will stop flashing and music will play.

TIP

If you bump the set during CD play, the music will stop or skip for a few seconds. This is normal for this type of player.

To	Press or Adjust
Adjust the volume	VOLUME control
Stop playback	■
Pause playback	▶▶ "PLAY" will flash during pause. Press again to resume play after pause.
Go to the next track	▶▶▶ FORWARDS
Go back to the previous track	◀◀◀ BACKWARDS
Locate a point in a song	◀◀◀ or ▶▶▶ Press and hold down while playing until you find the point.
Remove the CD	Lift the CD DOOR (press STOP first).
Turn off the power	Slide the FUNCTION switch to TAPE position.
Hear more bass	Slide the BASS BOOST switch to ON position.

LISTENING TO THE RADIO

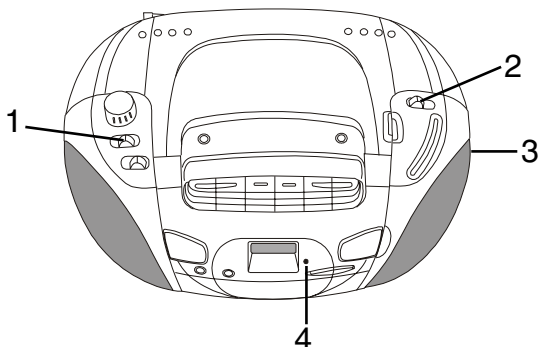

Connect the supplied AC power cord or batteries (see page 4).

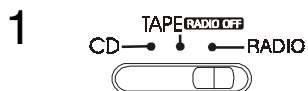

Slide the FUNCTION switch to RADIO position, the POWER lamp will be on.

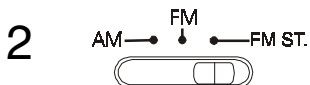

Slide the BAND switch to AM, FM or FM ST. you prefer.



Tune into the station you prefer using the TUNING control (at the right side of the set). Adjust for the clearest sound.



This FM STEREO indicator will light up when receiving FM Stereo broadcasts.

USE THESE BUTTONS FOR ADDITIONAL OPERATIONS

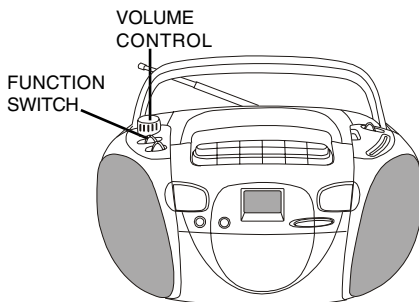

TIP

- Next time you want to listen to the radio, just slide the FUNCTION switch to RADIO. The player automatically starts playing the previously tuned station.

To	Slide or Adjust
Adjust the volume	VOLUME control (at the left side of the set)
Turn off the Radio	Slide the FUNCTION switch to TAPE position

To improve broadcast reception

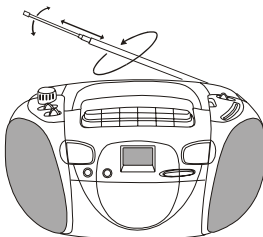

Change position of the antenna for FM or FM Stereo.

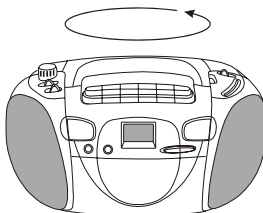

Move the set itself for AM.

PLAYING A TAPE

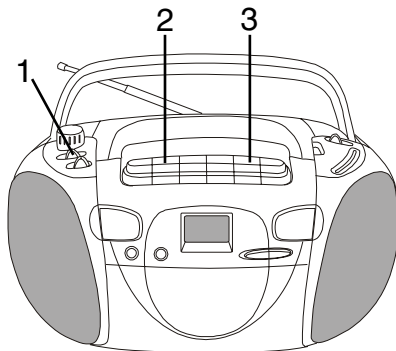

Connect the supplied AC power cord or batteries (see page 4).



Slide the **FUNCTION** switch to **TAPE** position.



Press the **STOP/EJECT** button to open the tape compartment and insert a recorded tape. Close the door.

INSERT TAPE THIS WAY
FULL REEL ON RIGHT

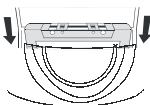

Press the **PLAY** button. The player turns on and starts playing.

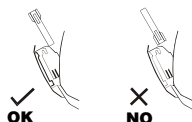

4 **AUTO STOP**

When the set finishes playing this side of the tape, the set will stop. To hear the other side of the tape, flip the tape over, then insert and press **PLAY**.

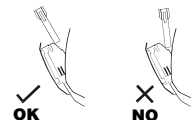

USE THESE BUTTONS FOR ADDITIONAL OPERATIONS

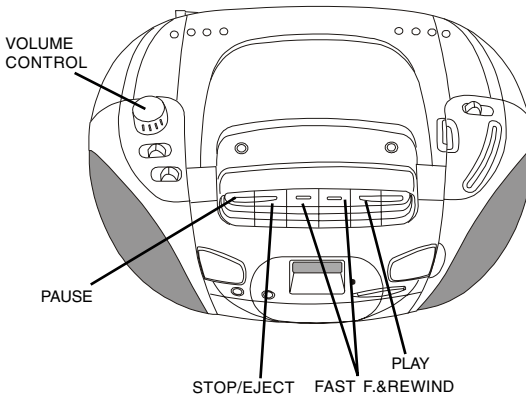

To	Press or Adjust
Adjust the volume	VOLUME control (at the left side of the set)
Stop playback	STOP/EJECT button
Fast forward or rewind the tape	FAST FORWARD button or REWIND button
Pause playback	PAUSE button Press again to resume play after pause.
Eject the cassette	STOP/EJECT button
To shut power off	Make sure cassette buttons are all up (stop) and FUNCTION switch is in the TAPE position (power off).

RECORDING ON A TAPE

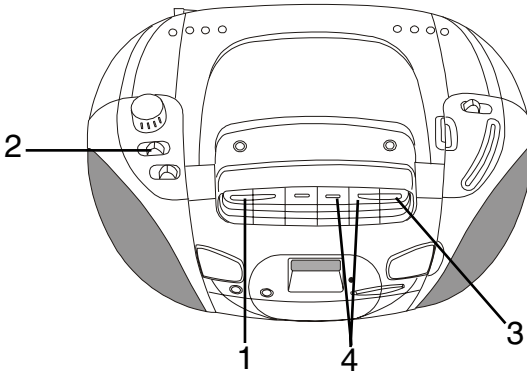

Connect the supplied AC power cord or batteries (see page 4).



Press the STOP/EJECT button to open the tape compartment and insert a blank tape. Select the program source (AM, FM, CD, or built-in microphone) you want to record.

TAPE PLAY DIRECTION

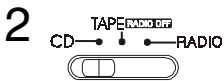

To record from the CD player, insert a CD and follow the steps to play a CD (see page 5).



To record from a radio, slide the FUNCTION switch to RADIO position, and tune into the station you want (see page 9).



To record from the built-in microphone, leave the FUNCTION switch at the TAPE position, and speak in front of the set.

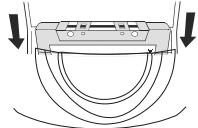

Press the RECORD button to start recording. (The PLAY button is depressed automatically.)

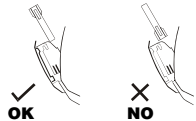

To hear what you recorded, slide the FUNCTION switch to TAPE position, then press REWIND and PLAY.

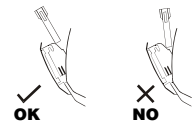

USE THESE BUTTONS FOR ADDITIONAL OPERATIONS

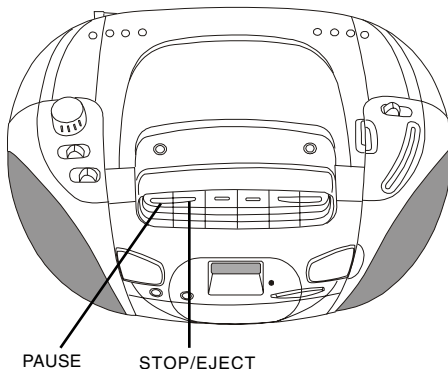

TIP

- For best recording effect, use the AC power instead of batteries.
- To erase a recording, just start a new recording, and the old one is automatically replaced.

To	Press or Adjust
Stop recording	STOP/EJECT button
Pause recording	PAUSE button Press the button again to resume recording.
Turn off the power	Press the STOP/EJECT button.

PRECAUTIONS

On Safety

- As the laser beam used in the CD player section may be harmful to the eyes, do not attempt to disassemble the cabinet. Refer servicing to qualified personnel only.
- Should any solid object or liquid fall into the player, unplug the player, and have it checked by qualified personnel before operating it any further.

On Placement

- Do not leave the player in a location near a heat source, or in a place subject to direct sunlight, excessive dust or mechanical shock.
- Do not place the player on an inclined or unstable place.
- Do not place anything within 1 inch of the back of the cabinet. The ventilation holes must not be covered for the player to operate properly and prolong the life of its components.
- If the player is left in a car parked in the sun, be sure to choose a location in the car where the player will not be subjected to the direct rays of the sun.
- Since a strong magnet is used for the speakers, keep personal credit cards using magnetic coding or springwound watches away from the player to prevent possible damage from the magnets.

On Power Sources

- For battery operation, use 8 size "C" batteries. We recommend alkaline batteries for longer life.
- When the batteries will not be used for a few weeks or more, remove them to avoid damage that can be caused by battery leakage or corrosion.

On Operation

- If the player is brought directly from a cold to a warm location, or is placed in a very damp room, moisture may condense on the lens inside the CD player section. Should this occur, the player will not operate properly. In this case, remove the CD and wait about an hour for the moisture to evaporate. If the player has not been used for a long time, set it in the playback mode to warm it up for a few minutes before inserting a cassette.
- This CD player is designed to be played on a stable no vibration position. If you bump the set during CD play, the music will stop or skip for a few seconds. This is normal for this type of player.

PRECAUTIONS (continued)

Notes on CDs

- Before playing, clean the CD with a cleaning cloth. Wipe the CD from the center out.

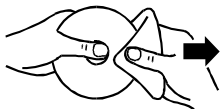

- Do not use solvents such as benzene, thinner, commercially available cleaners or anti-static spray intended for vinyl LPs.
- Do not expose the CD to direct sunlight or heat sources such as hot air ducts, nor leave it in a car parked in direct sunlight as there can be a considerable rise in temperature inside the car.
- Do not stick paper or stickers on the CD, nor scratch the CD.
- After playing, store the CD in its case. If there is a scratch, dirt or fingerprints on the CD, it may cause a tracking error or skipping.

Notes on Cassettes

- Break off the cassette tab from side A or B to prevent accidental recording.

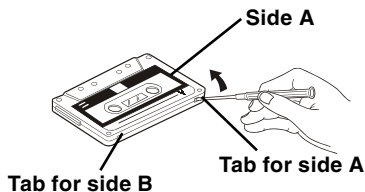

- To record on a tape with its tab broken off, cover the respective tab hole for side A or B with adhesive tape.
- The use of a cassette with more than 90 minutes of play time is not recommended except for long continuous recording or playback.
- To reduce the chances of tape jamming or tangling, you should check that there are no loose layers of tape visible through the cassette center window. If any, tighten these loose layers of tape using a pencil before inserting the cassette into the set.

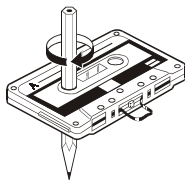

MAINTENANCE

Cleaning the Lens

If the lens becomes dirty, it may cause a skipping of sound during CD operation. Clean with a commercially available lens cleaner and blower.

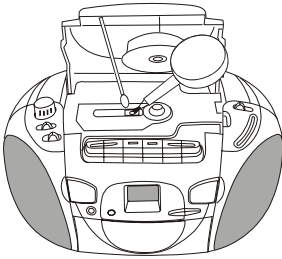

Cleaning the Tape Heads

Wipe the heads, the pinch roller and the capstan with a cleaning swab slightly moistened with cleaning fluid or alcohol after every 10 hours of operation for optimum playback and recording quality. After cleaning, insert a tape when the areas cleaned are completely dry.

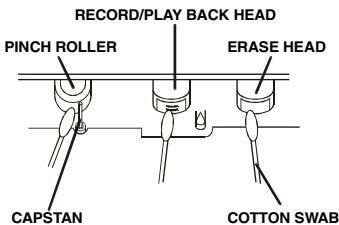

NOTE: In order to see and clean the head, you may have to press PLAY first.

Notes for Storing Cassette Tapes

1. Do not put a tape near a magnetic field, such as a TV, or speaker. Magnetic fields may reduce the tape sensitivity or even erase the recording.
2. Do not store tape for any length of time in a hot, moist or dusty place.

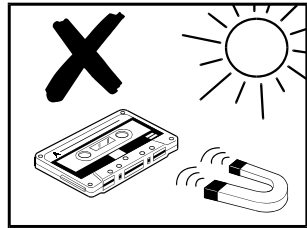

Cleaning the Cabinet

Clean the cabinet, panel and controls with a soft cloth slightly moistened with a mild detergent solution. Do not use any type of abrasive pad, scouring powder, or solvent, such as alcohol or benzene.

TROUBLE SHOOTING

	Problem	Remedy
General	The power is not on.	<ul style="list-style-type: none"> • Connect the AC power cord to a wall outlet securely. • Make sure the batteries are inserted correctly and they are fresh.
	There is no sound.	<ul style="list-style-type: none"> • Make sure the FUNCTION switch is at the right position as you want. • Adjust the volume.
	“ — — ” appears in the display even when a CD is in place.	<ul style="list-style-type: none"> • Insert the CD with the label side up.
CD player	CD does not play.	<ul style="list-style-type: none"> • Make sure that the CD compartment is closed. • Place the CD with the label side up. • Clean the CD. • Take out the CD and leave the CD DOOR open for about an hour to dry moisture condensation. • Make sure the FUNCTION switch is at CD position.
	The sound drops out.	<ul style="list-style-type: none"> • Clean the CD, or replace it if the CD is badly damaged. • Place the player in a location free from vibration. • Check if your batteries are fresh.
	The sound is weak or has poor quality.	<ul style="list-style-type: none"> • Replace all the batteries with new ones if they are weak, or bring the set near a window, or rotate the set.
Radio	The RECORD button does not function/The tape does not play.	<ul style="list-style-type: none"> • Make sure the safety tab on the cassette is in place. • Make sure the FUNCTION switch is at tape position.
	The tape does not erase completely.	<ul style="list-style-type: none"> • Clean the erasing head (see page 17). • Replace all the batteries with new ones if they are weak.
	The tape does not record.	<ul style="list-style-type: none"> • Make sure the tape is inserted properly. • Make sure the safety tab of the cassette is in place.
	The sound is weak/The sound quality is poor.	<ul style="list-style-type: none"> • Clean the heads, pinch roller and capstan (see page 17).
	Cassette PLAY button pops up.	<ul style="list-style-type: none"> • The tape has reached its end. Remove it, flip to the other side and re-insert.

SPECIFICATION

General Description

Power source:	AC 120V, 60Hz 12 Watts DC 12V (8 size "C" batteries) (Alkaline batteries are recommended)
Speakers:	2 - 3 1/2" 8 ohm
Output power:	1.5W/channel
Dimensions:	Width: 12" Depth: 8" Height: 6" Weight: 5LBs (without batteries)

CD Section

Plays disc type:	Any normal CD used in portable players	
Laser wavelength:	760 - 800 NM	
Tracking method:	3 - spot error detection	3.86 mm lens
Frequency response:	50Hz - 15kHz (+1/-2 dB)	

NOTE: This CD player will only play **NORMAL** music CDs (or CD-R CDs).
This set will not play **CDRW** encoded discs.

Tape Recorder Section

Frequency response: Standard normal bias cassette tape,
70Hz - 10kHz

Radio Section

Frequency range: FM: 88 - 108 MHz
AM: 530 - 1700 kHz

LENOXX reserves the right to make design and specification changes for product improvement.

PROTECT YOUR FINE FURNITURE!

WE RECOMMEND A CLOTH OR OTHER PROTECTIVE MATERIAL BE PLACED UNDER THE SET WHEN PLACING IT ON SURFACE WITH A NATURAL OR LACQUER FINISH.

© 2002 LENOXX ELECTRONICS CORP.
2 GERMAK DRIVE
CARTERET, N.J. 07008
MADE & PRINTED IN CHINA

19

IB-CD104(TA)-FD-E-043002

Free Manuals Download Website

<http://myh66.com>

<http://usermanuals.us>

<http://www.somanuals.com>

<http://www.4manuals.cc>

<http://www.manual-lib.com>

<http://www.404manual.com>

<http://www.luxmanual.com>

<http://aubethermostatmanual.com>

Golf course search by state

<http://golfingnear.com>

Email search by domain

<http://emailbydomain.com>

Auto manuals search

<http://auto.somanuals.com>

TV manuals search

<http://tv.somanuals.com>