

Lenox Sound[®]

AM/FM RADIO RECEIVER PROGRAMMABLE CD PLAYER

MODEL CD-61
OPERATING INSTRUCTIONS

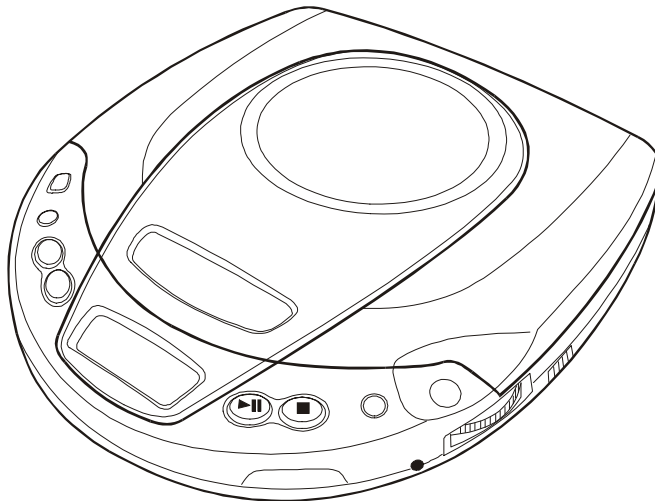

- BUILT-IN AM/FM RADIO RECEIVER
- PLAYS MUSIC COMPACT DISCS
- 6 DIGIT LCD VISUAL DISPLAY
- TRACK REPEAT & DISC REPEAT
- BASS BOOST SYSTEM
- DELUXE STEREO HEADPHONES INCLUDED
- USES 2 SIZE "AA" BATTERIES (NOT INCLUDED)

PLEASE READ CAREFULLY BEFORE USE

CD-61(70C-0A9)031900 NL v.1 

LOCATION OF CONTROLS

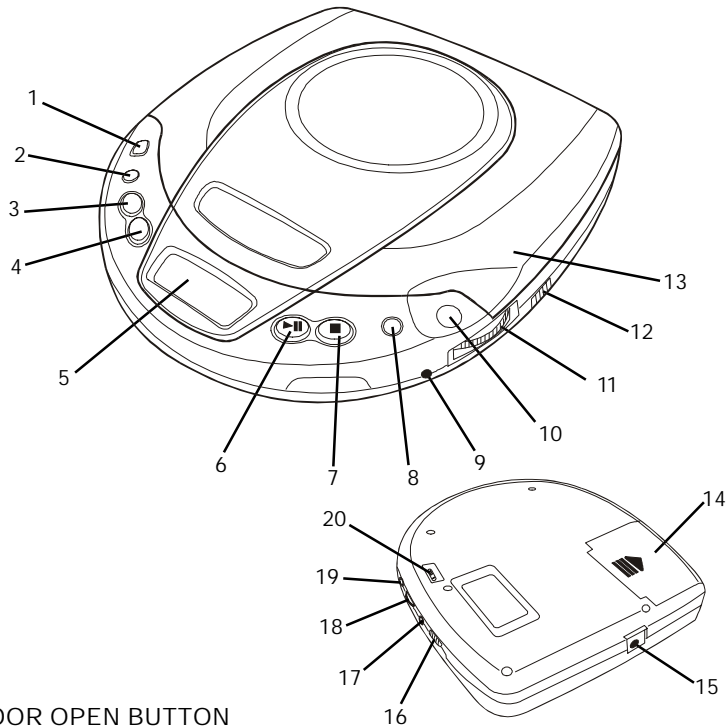

1. CD DOOR OPEN BUTTON
2. CD REPEAT BUTTON
3. CD BACKWARD SKIP/SEARCH BUTTON (◀▶)
4. CD FORWARD SKIP/SEARCH BUTTON (▶▶)
5. CD LCD VISUAL DISPLAY
6. CD PLAY/PAUSE AND POWER ON BUTTON
7. CD STOP AND POWER OFF BUTTON (POWER OFF IS AUTOMATIC AFTER 30 SECONDS)
8. PROGRAM (PROGRAMMING) BUTTON
9. FM STEREO INDICATOR
10. AM/FM DIAL LENS
11. AM/FM TUNING CONTROL
12. AM/FM BAND SWITCH
13. CD DOOR
14. BATTERY DOOR
15. AC ADAPTOR JACK (AC ADAPTOR NOT INCLUDED)
16. CD/RADIO FUNCTION SWITCH
17. PHONES JACK (HEADPHONE JACK)
18. VOLUME CONTROL
19. AUX OUT JACK (FOR HOME STEREO USE)
20. BASS BOOST SWITCH (ON BOTTOM OF THE SET)

POWER SOURCES

Power your CD player by connecting an optional (not included) AC ADAPTOR or by inserting 2 size "AA" fresh alkaline batteries.

NOTE: Before you buy an AC Adaptor, please note the only AC ADAPTOR suitable for this player is DC 4.5V 600mA, with polarity $\ominus \text{---} \oplus$, others may damage your player. Please check voltage & current (mA) before buying an AC ADAPTOR.

Using with Batteries

Insert two size "AA" alkaline batteries according to the + and - markings on the back cabinet.

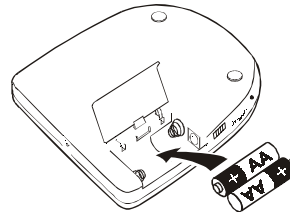

TIPS ON BATTERY USE

- Reversing polarities will damage the batteries and possibly your set. Be sure to follow polarity (+ and -) as indicated.
- Do not mix different types together (Alkaline, Carbon-Zinc, Nickel-Cadmium etc.), or old batteries with new ones.
- When not in use for an extended period of time, or while internal batteries will not be used, remove them to prevent possible acid leakage or corrosion resulting in damage to your player.
- When the batteries have become discharged, they must be disposed of in a safe manner that complies with all applicable laws.
- Installation of batteries should only be done by an adult (for safety).

ALKALINE BATTERY LIFE

Bear in mind that battery life expectancy is based upon volume and bass listening levels.

Maximum battery power consumption happens at maximum settings. Typical life for 2 size "AA" alkaline batteries is above 8 hours of continuous use for CD play and 5 hours longer for radio use.

WHEN **BATT** SHOWS OR FLASHES IN THE DISPLAY

While CD playing, if the alkaline batteries are weak and discharged, this symbol "**BATT**" shows or flashes in the display, then the power automatically turns off. If this occurs, replace the alkaline batteries (also if the display does not show anything, the batteries are dead).

NOTE 1: The display is blank when you listen to the radio, so when the display does not show anything, please check if the CD/RADIO FUNCTION switch is moved to the CD position.

NOTE 2: The radio may work normally for about 5 hours when "**BATT**" shows or flashes on the display indicating batteries are weak for CD play, but still OK for the radio.

NOTE 3: You may use rechargeable batteries on this set. However, because rechargeable batteries generally have lower voltage (1.2 volts instead of 1.5 volts). Your playing time will be much less than normal fresh alkaline batteries.

CONNECTING TO HOME STEREO SYSTEMS

The AUX OUT jack is made to accept a stereo mini plug (3.5mm). Simply connect the cable's mini plug to the AUX OUT jack on your player, and the other appropriate end usually RCA JACKS to the CD/AUX INPUTS of your home stereo.

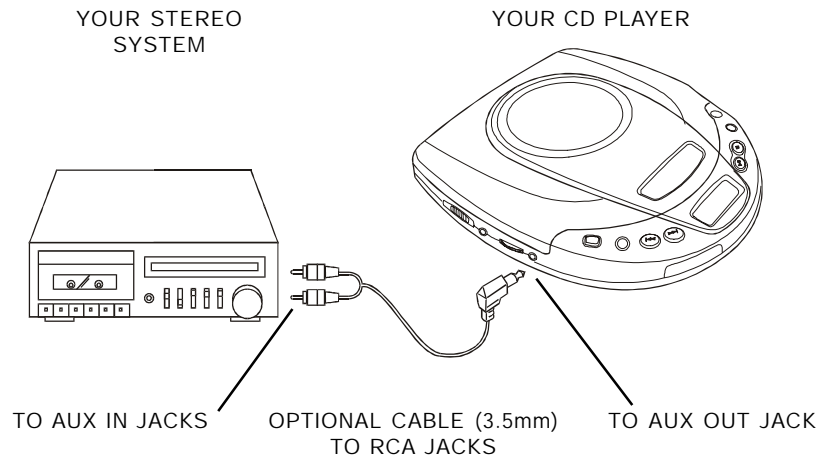

DISC PLAYING

- 1 Slide the CD/RADIO FUNCTION switch to CD position.

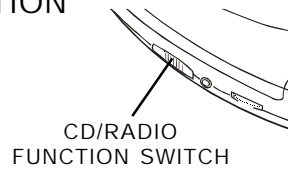

- 2 Load the disc.

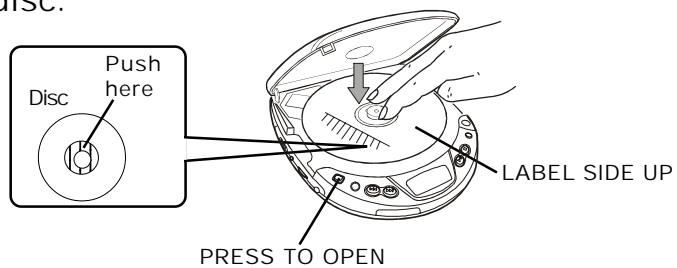

- 3 Connect the headphones.

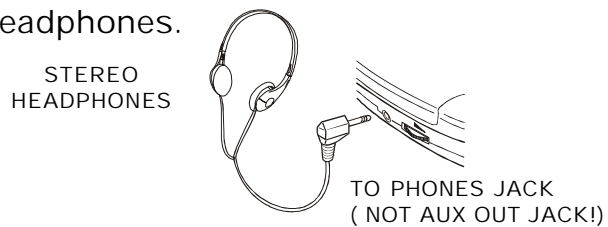

- 4 Press the PLAY/PAUSE button (▶||).

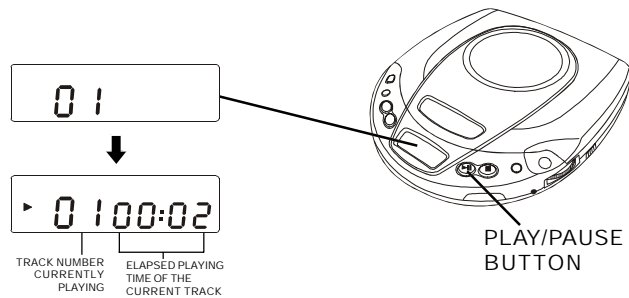

- 5 Adjust the volume.

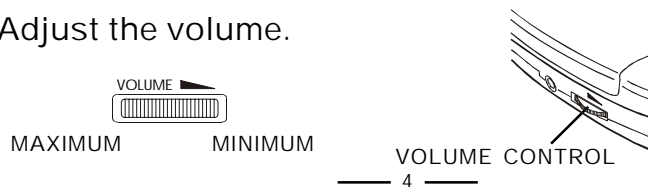

OTHER OPERATIONS

Operation ● Press ● Display window shows

To pause play

 PLAY/PAUSE button

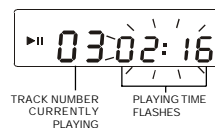

To release pause and resume play

 PLAY/PAUSE button

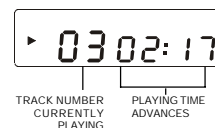

To stop
or
To turn off the power



 STOP (POWER OFF) button



To skip to the next track(s)

 once (or repeatedly)

To skip to the previous track(s)

 once (or repeatedly)

To go ahead at high speed
(search forward)



Keep  depressed and release when the desired music section of the disc is found.

- If you press and hold the SKIP button () while the last track is playing, and the end of the track is reached, the music stops and the display will show the next track number, then power will shut off after 30 seconds.

To go back at high speed
(search backward)

Keep  depressed and release when the desired music section of the disc is found.

Get into Stop Mode (for programming)

Press the PLAY/PAUSE button , the set begins to play, then press the STOP (POWER OFF) button , the display will show six digits similar to the example show here.



Auto power off function

The power turns off automatically 30 seconds after all tracks on the disc have been played or after the STOP button is pressed to stop play.

REPEAT PLAY

SINGLE TRACK REPEAT

Plays one song over and over till you press STOP.

During play, select the song you want to repeat with either of the SKIP/SEARCH buttons (◀◀ or ▶▶), then press the REPEAT button once, the symbol REPEAT 1 appears in the display.

The song currently playing will repeat over and over, until you press STOP.

To resume normal play, press the REPEAT button another two times.

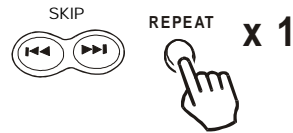

ALL TRACKS REPEAT (DISC REPEAT)

Repeats all songs in order, till you press STOP.

During play, press the REPEAT button twice, the symbol REPEAT ALL will show in the display.

All songs will keep playing in sequence 1, 2, 3, etc. and when finished, will start all over again until you press the STOP button.

To resume normal play, press the REPEAT button again.



REPEAT PROGRAMMED PLAY

After you have programmed your own sequence (as instructed on page 7), you may play the songs repeatedly in your programmed sequence.

1. Follow the instructions on page 7 and press the PLAY button to start programmed play. PGM (program) will show in the display.
2. During play, press the REPEAT button twice, the symbol REPEAT ALL will show in the display.

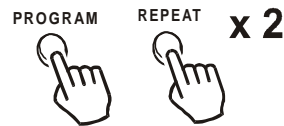

The set will play the songs in the order you programmed, when finished, will start all over again until you press the STOP button.

PROGRAMMING YOUR PLAYING SEQUENCE

PROGRAMMED PLAY

- The tracks (songs) on the disc can be programmed (arranged in advance) to play in any order you prefer (up to 21 tracks can be programmed).

Programming Example:								
Program Number	1	2	3	4	5	6	7	8 etc.
Track Number (song number)	3	5	8	1	2	4	1	1 etc.

- During CD play, the PROGRAM button functions the same as the REPEAT button. The set must be in stop mode (as instructed on page 5) to program it.
- During programming, the word PGM (program) shows in the display. To program songs to play in your preferred order, follow steps below:

1. Press the PROGRAM button once in stop mode.



The word PGM will show in the DISPLAY.

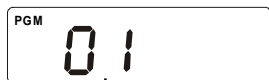

Program number

2. Press the SKIP/SEARCH button (◀◀ or ▶▶) to select track number 3 (example). PGM will flash in the display.



Track number

3. Press the PROGRAM button. Track 3 is now programmed.



Program #2 will now show in the display, ready for your next selection of track.



4. Repeat steps 2 and 3 to program other tracks till you finish (up to 21 selections).

5. After programming is finished, press PLAY to begin programmed play. ▶ shows in the display together with PGM, and music begins.



NOTE:

- The player will stop automatically after all programmed tracks have been played.
- To quit programmed play, press STOP button once. Then you may press PLAY button to re-start normal play.

Your programmed memory will be lost:

- When the alkaline batteries are exhausted or removed, or the AC ADAPTOR is disconnected.
- When the power is shut off.

RADIO OPERATION

- 1 Slide the CD/RADIO FUNCTION switch to RADIO position.

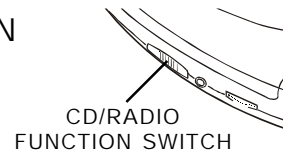

- 2 Select AM or FM with the AM/FM BAND switch.

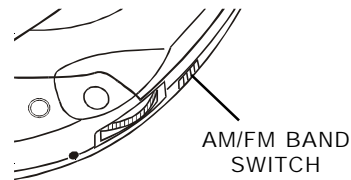

- 3 Rotate the TUNING CONTROL to select your favorite radio station.

NOTE: If you tune into a FM stereo station, the FM STEREO indicator will be turned on.

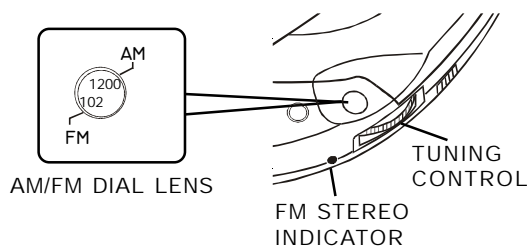

- 4 Adjust the volume.

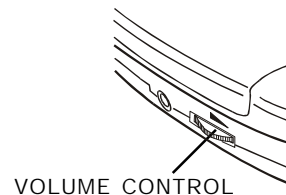
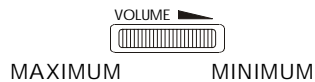

- 5 If you prefer more bass, slide the BASS BOOST switch to ON position.

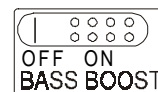

NOTE: The BASS BOOST switch is on the bottom of the set.

- 6 To turn off the radio, slide the CD/RADIO FUNCTION switch to the CD position.

MAINTENANCE

Cleaning the lens

A dirty lens will cause sound skipping. If the lens is very dirty, the player may not work. We suggest using a special cleaning disk (not included) available in most music and Hi-Fi stores. However, if you do not have one, you may use the instructions below.

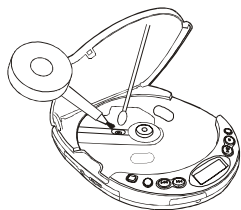

Use a cotton swab very slightly dampened with alcohol to clean the lens.

Cleaning the cabinet

Wipe with a soft cloth. If the cabinet is very dirty, dampen (not dripping wet) the cloth with a weak solution of soapy water, and then wipe clean.

Cleaning the Discs

- Fingerprints should be carefully wiped from the surface of disc with a soft cloth. Unlike conventional records, compact discs have no grooves to collect dust and microscopic dirt, so gently wiping them with a soft cloth should remove most particles. Wipe in a straight motion from the center to the edge.

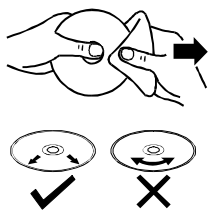

- Never use thinner, benzene, record cleaner or antistatic spray on a compact disc. Such chemicals can damage its plastic surface.

Handling Compact Discs

- Dirty, scratched or warped discs may cause skipping or noise.
- Handle the disc only by the edges. To keep clean, do not touch its surface.



- Discs should be stored in their cases after use to avoid scratches.
- Do not expose discs to direct sunlight, high humidity, high temperatures, or dust, etc. Prolonged exposure to extreme temperatures can warp the disc (such as leaving the discs in your car during summertime).
- Do not stick or write anything on either side of disc. Sharp writing instruments, or the inks used in some felt-tip pens, may damage its surface.

To remove the Disc

Open the CD DOOR by pressing the DOOR OPEN button, hold the disc by the edge while slightly pressing on the center spindle as illustrated, then lift it from the edge to release and remove.

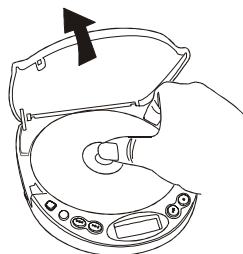

NOTE

Always press STOP button and wait for the disc to stop rotating before pressing the DOOR OPEN button to remove the disc.

SAFETY PRECAUTIONS

Do not take the set apart. The laser beam used in the set may harm your eyes. Refer servicing to qualified service personnel only.

Do not insert pins or coins, clips, or any objects inside the set.

This set is equipped with a safety device which automatically turns the laser beam off when the disc door is opened.

Do not drop the set or subject it to strong shocks. Doing so could result in damage.

Do not place the set in locations where the temperature is high, or in humid or dusty locations, or locations with long heavy vibrations, or tilted surfaces.

The set's cabinet may warp or the set may otherwise be damaged if it is placed in direct sunlight, near heaters (where the temperature is 140°F/60°C or higher) or in cars with the windows closed. In the summer, the temperature may get as high as 212°F/100°C or more.

Use the set within a temperature range of 41°F/ 5°C to 95°F/35°C.

Use ONLY the DC 4.5V 600mA AC Adaptor with polarity , others may damage your set. Disconnect the Adaptor from the wall outlet when the set is not to be used for an extended period of time (3 days or more).

When cleaning your set, use a soft dry cloth. Do not use solvents or commercially available cleaners, as they may damage or discolor the finish.

Do not wear headphones while operating a motor vehicle. This could create a traffic hazard and is illegal in many areas. Do not use this set when bicycling or running.

The headphones supplied with your set provide superb stereo listening while allowing you to hear some outside sounds when listening at normally low volume levels. Listening at extremely high volume levels minimizes the intrusion of outside noise/sounds. In the interest of safety, it is strongly advised against the use while engaging in activities where the exclusion of external sounds (whistles, horns, sirens, traffic, etc.) could be hazardous. Also loud volume can hurt your ears. If you notice that the sound has become weak or distorted or if tracks do not change, this is an indication that your batteries are low. Replace both batteries at the same time (see BATTERY OPERATION). Your CD-61 is identified by a serial number located in the BATTERY COMPARTMENT. Record this number in the space provided below.

Model CD-61	Serial No. <input type="text"/>	Date Purchased: <input type="text"/>
-------------	---------------------------------	--------------------------------------

This Instruction Manual contains detailed information on its safety and use. Please read it carefully so that you may take full advantage of its many features, and ensure a safe reliable operation. Keep this Instruction Manual for future reference.

CONDENSATION

If cold water is poured into a glass, water droplets form on the outside of the glass. This is called condensation. Condensation may occur on internal operating parts of the lens.

Condensation occurs:

When the set is brought from the cold outdoors into a warm room, or if it is in a cold room to a room which is heated, or in the summer, if the set is moved from an air-conditioned room or car to a hot or humid location.

Should condensation occur, the set may not operate properly. Open the CD DOOR and wait for about 20 minutes (to allow the internal parts to adjust to the surrounding temperature) before using the set.

IMPORTANT INFORMATION REQUIRED BY THE FCC

Since the CD circuitry may cause interference to other radios nearby, switch this set off when not in use or move it away from the affected radios.

This device complies with Part 15 of the FCC Rules. Operation is subject to the following two conditions: (1) This device may not cause harmful interference, and (2) This device must accept any interference received, including interference that may cause undesirable operation.

NOTE: This equipment has been tested and found to comply with the limits for a Class B digital device, pursuant to Part 15 of the FCC Rules. These limits are designed to provide reasonable protection against harmful interference in a residential installation. This equipment generates, uses and can radiate radio frequency energy and, if not installed and used in accordance with the instructions, may cause harmful interference to radio communications. However, there is no guarantee that interference will not occur in a particular installation. If this equipment does cause harmful interference to radio or television reception, which can be determined by turning the equipment off and on, the user is encouraged to try to correct the interference by one or more of the following measures:

- Reorient or relocate the receiving antenna.
- Increase the separation between the equipment and receiver.
- Connect the equipment into an outlet on a circuit different from that to which the receiver is connected.
- Consult the dealer or an experienced radio/TV technician for help.

SAFETY CERTIFICATION

This AM/FM Compact Disc Player is made and tested to meet safety standards of the FCC requirements and compliance with safety performance of the U.S. Department of Health and Human Services, and also with FDA Radiation Performance Standards 21 CFR Subchapter J.

WARNING

- To prevent fire or shock hazard, do not expose this appliance to rain or moisture.
- Unauthorized recording of copyrighted material may violate laws.

LASER SAFETY

THIS SET EMPLOYS AN OPTICAL LASER BEAM SYSTEM IN THE CD MECHANISM, DESIGNED WITH BUILT-IN SAFEGUARDS. DO NOT ATTEMPT TO DISASSEMBLE. EXPOSURE TO THIS INVISIBLE LASER LIGHT BEAM MAY BE HARMFUL TO HUMAN EYES. THIS IS A CLASS-1 LASER PRODUCT. USE OF ADJUSTMENTS OTHER THAN THOSE SPECIFIED HEREIN, MAY RESULT IN HAZARDOUS LASER LIGHT BEAM EXPOSURE. THIS COMPACT DISC PLAYER SHOULD NOT BE ADJUSTED OR REPAIRED BY ANYONE EXCEPT QUALIFIED SERVICE PERSONNEL. THE LASER MECHANISM IN THE SET CORRESPONDS TO THE STYLUS (NEEDLE) OF A RECORD PLAYER. ALTHOUGH THIS PRODUCT USES A LASER PICK-UP LENS, IT IS COMPLETELY SAFE WHEN OPERATED ACCORDING TO DIRECTIONS.

TROUBLE SHOOTING GUIDE

Symptoms	Causes	Solutions
Tracks do not change or set does not play normally.	Batteries are weak (they may test OK on tester but they are weak for CD operation).	Replace both batteries with fresh alkaline batteries. Battery life with fresh batteries is above 8 hours for continuous CD play and 5 hours longer for radio use (rechargeable batteries have 1/2 of that life).
CD Player will not turn on.	Dead or weak batteries.	Replace both batteries with fresh ones.
	The optional AC ADAPTOR not connected properly.	Check the optional AC ADAPTOR connection at AC outlet and the rear of the set.
Disc will not play.	Disc inserted incorrectly.	Re-insert disc with label side facing up.
	Defective compact disc.	Try another compact disc.
	CD DOOR not closed.	Close the door securely.
	Moisture has formed inside the CD deck.	Take out the CD and leave the CD Door open for about 20 minutes to dry the moisture condensation.
No sound from headphones.	Headphone plug not inserted properly.	Re-insert headphone plug into Phones Jack (not Aux Out).
	VOLUME control set to minimum.	Increase the volume.
	Weak batteries.	Replace with fresh batteries or use the optional AC ADAPTOR.
	Defective compact disc.	Try another compact disc.
VOLUME control has no function.	Headphones plugged into AUX OUT Jack.	Plug headphones into PHONES jack. (NOT THE AUX OUT JACK)
Sound is skipping or sound stops.	The compact disc or lens is dirty or CD is scratched.	Clean or replace the compact disc or clean the lens.
Sound is distorted.	Music is too loud.	Lower the VOLUME control.
	BASS BOOST is ON.	Slide BASS BOOST switch to OFF.
	Weak batteries.	Replace both batteries or use the optional AC ADAPTOR.
Buttons do not work.	Electronic or static error caused circuitry to lock.	Remove batteries and the optional AC ADAPTOR. Wait 15 seconds and re-insert. Make sure batteries are fresh or the optional ADAPTOR has power.
Radio does not work.	FUNCTION switch is in the CD position	Slide the FUNCTION switch to the RADIO position.
FM reception is weak.	The FM Antenna is built-into your headphone wire.	Straighten your headphone wire, or bring your set closer to a window.
AM reception is weak	The built-in AM Antenna is directional.	Rotate the set or bring the set near a window.

TECHNICAL SPECIFICATIONS CD Player Section

Frequency response	20Hz - 20kHz +1 / -2dB
Wow and flutter	Below measurable limits
Sampling frequency	44.1kHz
D/A converter	1-bit
Error correction method	CIRC
Pickup	Optical 3-beam semiconductor laser (780 nm wavelength)
Laser diode material GaAlAs	
Laser output less than 44.6 μ w	

NOTE: This CD player will only play NORMAL music CDs (or CD-R CDs).
This set will not play CDRW encoded discs.

Radio Section

Frequency Range	AM: 530 - 1700 kHz
	FM: 88 - 108 MHz

General

Maximum output (stereo headphones)	20mW + 20mW
Power Supply	
AC Adaptor Input.....	120V/60Hz - 4.5V DC Output (not included)
DC	3V: Using 2 size "AA" batteries
Set Dimensions (approximate)	
Width	5 1/8"
Depth	5 1/2"
Height	1"
Weight (approximate)	9.5oz. (270g) (set only)

LIMITED WARRANTY

We warrant this product to be free from defects in material and workmanship under normal use for a period of 90 days after purchase and we will repair it free of charge or replace it at no charge, should it become defective under this warranty, providing you submit proof of purchase (sales slip) with the set.

During the initial 90 day period after original purchase, we will service or exchange, at no charge, the set that is returned to LENOXX ELECTRONICS CORP. After the initial 90 day period expires, and for a period of 12 months from original purchase, we will repair the unit covering any part(s) that need to be replaced at no charge, but will charge for the cost of labor, return postage paid by Lenoxx.

This warranty does not apply to any products which have been subject to misuse, neglect or accident. This warranty does not cover broken headphones or cabinet. UNDER NO CIRCUMSTANCES WILL LENOXX ELECTRONICS CORP. BE LIABLE FOR ANY INCIDENTAL OR CONSEQUENTIAL DAMAGES. Some states do not allow the exclusion or limitation of incidental or consequential damages, so the above limitations or exclusions may not apply to you.

This warranty gives you specific legal rights, and you may also have other rights which vary from state to state. The following charges apply to repairs beyond the warranty period: \$20.00. Be sure to pack carefully and return postage paid insured together with your money order (personal checks will not be accepted) and sales receipt to: LENOXX ELECTRONICS CORP. 2 GERMAK DRIVE, CARTERET N.J. 07008

For customer service

Dial 1-800-315-5885 (MONDAY - THURSDAY 9:00 AM - 5:00 PM, FRIDAY 9:00 AM - 1:00 PM EST)

or Visit Our Website: <http://www.lenoxx.com>

© 2001 LENOXX ELECTRONICS CORP.
2 GERMAK DRIVE
CARTERET, N.J. 07008
MADE & PRINTED IN CHINA

Free Manuals Download Website

<http://myh66.com>

<http://usermanuals.us>

<http://www.somanuals.com>

<http://www.4manuals.cc>

<http://www.manual-lib.com>

<http://www.404manual.com>

<http://www.luxmanual.com>

<http://aubethermostatmanual.com>

Golf course search by state

<http://golfingnear.com>

Email search by domain

<http://emailbydomain.com>

Auto manuals search

<http://auto.somanuals.com>

TV manuals search

<http://tv.somanuals.com>