

Lenox Sound[®]

45 SECOND ESP PLUS[™]
ELECTRONIC SHOCK PROTECTION
PROGRAMMABLE COMPACT DISC PLAYER

MODEL CD-87

OPERATING INSTRUCTIONS

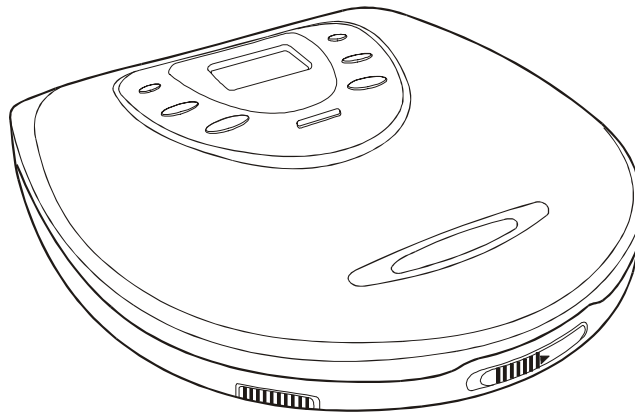

- PLAYS ALL MUSIC COMPACT DISCS
- BASS BOOST SYSTEM
- 6 DIGIT LCD VISUAL DISPLAY
- TRACK REPEAT & DISC REPEAT
- 45 SECOND ESP (ELECTRONIC SHOCK PROTECTION) PLUS[™] SYSTEM
- DELUXE STEREO HEADPHONES INCLUDED
- AC ADAPTOR INCLUDED
- USES 2 SIZE "AA" BATTERIES (NOT INCLUDED)
- AUX OUT JACK - CONNECTS TO YOUR STEREO SYSTEM

————— PLEASE READ CAREFULLY BEFORE USE —————

CD87(12A-45J2)010801 NL v.1 

INTRODUCTION

1

Your new Lennox Sound model CD-87 portable compact disc player, uses the latest technology to give you crisp clean sound from all your compact discs. Please read these operating instructions completely to take advantage of all the features of this set.

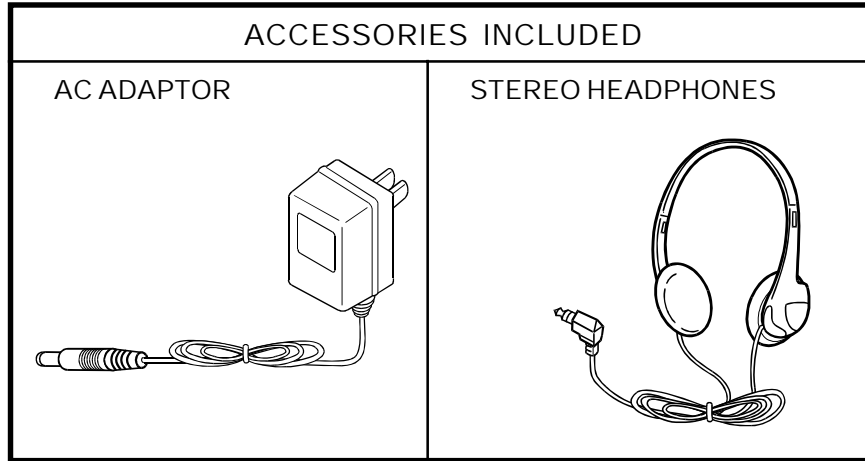

CD87(12A-45J2)010801 NL v.1 

LOCATION OF CONTROLS

2

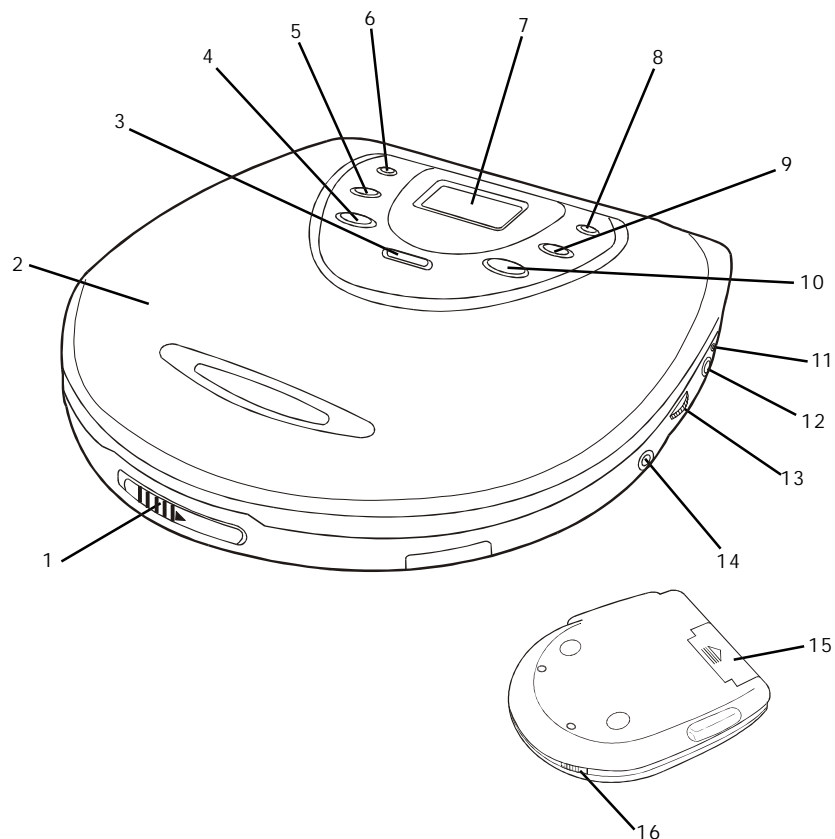

1. CD DOOR OPEN BUTTON (slide to open)
2. CD DOOR
3. ESP (electronic shock protection) BUTTON
4. STOP AND POWER OFF BUTTON
5. BACKWARD SKIP/SEARCH BUTTON (◀)
6. REPEAT/RANDOM BUTTON
7. LCD DISPLAY
8. PROGRAM BUTTON
9. FORWARD SKIP/SEARCH BUTTON (▶)
10. PLAY/PAUSE BUTTON
11. AC ADAPTOR JACK
12. AUX OUT JACK (for home stereo connection)
13. VOLUME CONTROL
14. PHONES JACK (headphones jack)
15. BATTERY DOOR
16. BASS BOOST SWITCH

CD87(12A-45J2)010801 NL v.1 

POWER SOURCES

3

1. Using with Batteries

Insert two size "AA" alkaline batteries according to the + and - markings in the BATTERY COMPARTMENT.

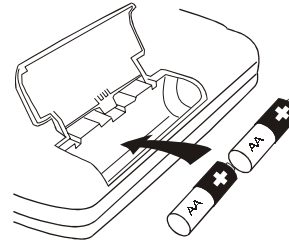

TIPS ON BATTERY USE

- Reversing polarities will damage the batteries and possibly your set. Be sure to follow polarity (+ and -) as indicated.
- Do not mix different types together (Alkaline, Carbon-Zinc, Nickel-Cadmium etc.), or old batteries with new ones.
- When not in use for an extended period of time, or while internal batteries will not be used, remove them to prevent possible acid leakage or corrosion resulting in damage to your player.
- When the batteries have become discharged, they must be disposed of in a safe manner that complies with all applicable laws.
- Installation of batteries should only be done by an adult (for safety).

ALKALINE BATTERY LIFE

Bear in mind that battery life expectancy is based upon volume and bass listening levels.

Maximum battery power consumption happens at maximum settings. Typical life for 2 size "AA" alkaline batteries is above 8 hours of continuous use.

WHEN SHOWS OR FLASHES IN THE DISPLAY

If the alkaline batteries are weak and discharged, this symbol "  " shows or flashes in the display, then the power automatically turns off. If this occurs, replace the alkaline batteries (also if display does not show anything, the batteries are dead).

NOTE: You may use rechargeable batteries on this set. However, because rechargeable batteries generally have lower voltage (1.2 volts instead of 1.5 volts). Your playing time will be much less than normal fresh alkaline batteries.

CD87(12A-45J2)010801 NL v.1 

2. Using AC Power

Your player may be powered from any household 120V AC outlet, using the AC ADAPTOR included. Insert the ADAPTOR's small connector plug into the DC 4.5V jack marked \ominus — \oplus on player (on the right side of the set), and plug the ADAPTOR into an AC outlet.

NOTE: If the AC ADAPTOR is connected, and regular batteries are installed, the player automatically switches to the AC ADAPTOR power and the batteries are not used.

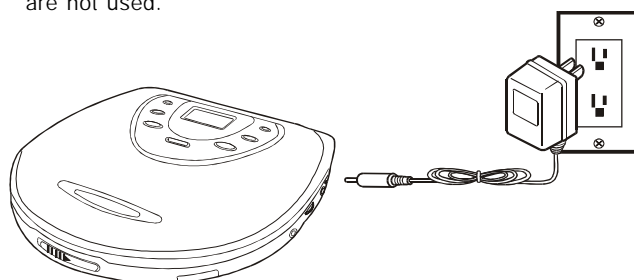

CAUTION:

To prevent electric shock, do not use this AC ADAPTOR with an extension cord or outlet, unless it can be fully inserted without exposing any part of the blades. Do not use any other AC adaptor to power this set or you may damage your set.

CONNECTING TO HOME STEREO SYSTEMS

The AUX OUT jack is made to accept a stereo mini plug (3.5mm). Simply connect the cable's mini plug to the AUX OUT jack on your player, and the other appropriate end usually RCA JACKS to the CD/AUX INPUTS of your home stereo.

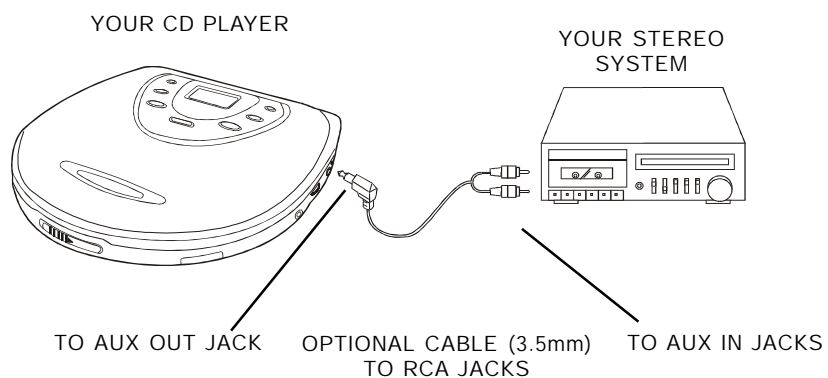

CD87(12A-45J2)010801 NL v.1

CD PLAYING

5

1 Load the Disc.

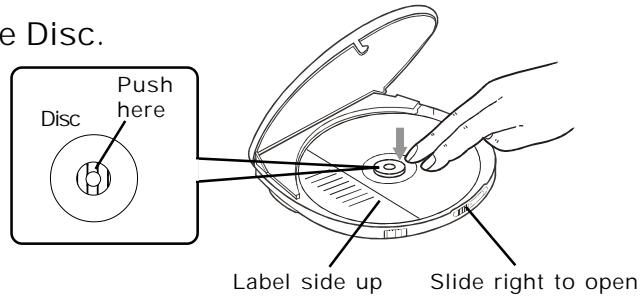

2 Connect the Headphones.



3 Press the PLAY/PAUSE button.

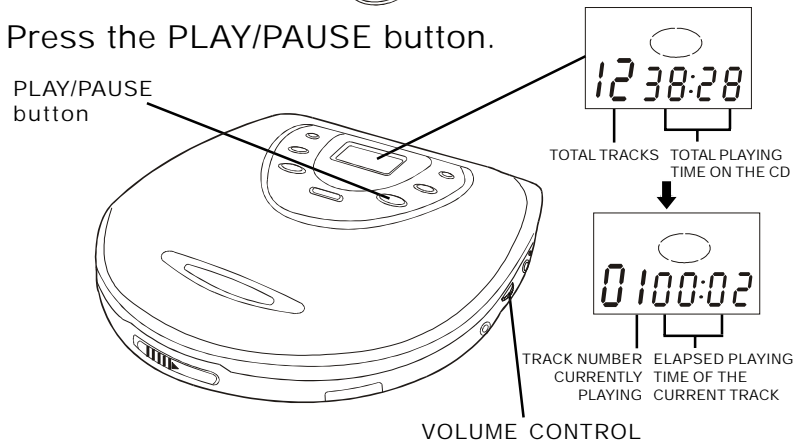



NOTE: The ESP PLUS™ function will turn on automatically when the PLAY/PAUSE button is pressed. Press the ESP button if you need not ESP function.

4 Adjust the Volume.

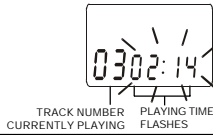
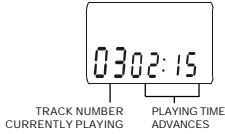

CD87(12A-45J2)010801 NL v.1 

Other Operations

Operation	Press	Display window shows
To pause play	PLAY/PAUSE button	
To release pause and resume play	PLAY/PAUSE button	
To stop	STOP button	
To turn off the power	STOP button once and wait 30 seconds, or press STOP button twice	
To skip to the next track(s)	▶▶ once (or repeatedly)	
To skip to the previous track(s)	◀◀ once (or repeatedly)	
To go ahead at high speed (search)	Keep ▶▶ depressed and release when the desired music section of the disc is found.	
To go back at high speed (search)	Keep ◀◀ depressed and release when the desired music section of the disc is found.	

BASS BOOST switch

This switch enhances the low frequency (bass) sounds at low listening levels. Switch this ON or OFF to suit your taste.

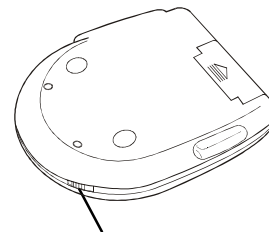

BASS BOOST switch

REPEAT, INTRO AND RANDOM PLAY

7

You may have repeat, intro or random play using the REPEAT/RANDOM button. Press the REPEAT/RANDOM button several times, and the display will show the followings in turn:

↻¹ --> ↻ ALL --> INTRO --> SHUFF (RANDOM) --> NORMAL PLAY

Single Track Repeat

Plays one song over and over till you press STOP.

During play, select the song you want to repeat with either of the SKIP/SEARCH buttons (◀◀ or ▶▶), then press the REPEAT/RANDOM button once, the symbol ↻¹ appears in the display.

The song currently playing will repeat over and over, until you press STOP.

REPEAT
RANDOM

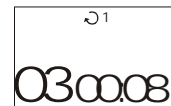

All Tracks Repeat

Repeats all songs in order, till you press STOP.

During play, press the REPEAT/RANDOM button twice, the symbol ↻ ALL will show in the display.

All songs will keep playing in sequence 1, 2, 3, etc. and when finished, will start all over again until you press the STOP button.

REPEAT
RANDOM

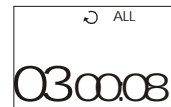

Intro Play

This plays the first 10 seconds of songs in sequential order.

1. During play, press the REPEAT/RANDOM button three times, the word INTRO will flash in the display.
2. Press the PLAY button, the word INTRO will stop flashing and the first 10 seconds of each song on the CD will play in sequential order.
3. When you find a song you like, press the PLAY button, normal play will be resumed, that song (and the following songs) will play NORMALLY.

REPEAT
RANDOM



Random Play

This plays the songs on the disc in a random order.

1. During play, press REPEAT/RANDOM button four times the word SHUFF will flash.
2. Press the PLAY button, this will play all of the songs in random order selected by the CD player. The word SHUFF will stop flashing.
3. Press the SKIP/SEARCH button ▶▶ to skip to the next random song.

REPEAT
RANDOM



CD87(12A-45J2)010801 NL v.1

PROGRAM PLAY

The tracks (songs) on the disc can be programmed (arranged in advance) to play in any order you prefer (up to 20 tracks can be programmed).

Programming Example:									
Program Number	1	2	3	4	5	6	7	8	etc.
Track Number (song number)	3	5	8	1	2	4	1	1	etc.

During programming, the word PROG flashes in the display. To program songs to play in your preferred order, follow steps below:

1. During play, press the PROGRAM button.



The word PROG will flash in the display.



2. Press the SKIP/SEARCH button (◀◀ or ▶▶) to select track number 3 (example). PROG and track number "03" will flash in the display.

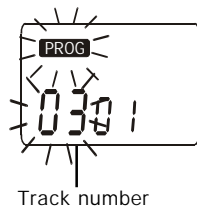
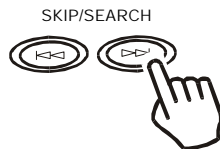

3. Press the PROGRAM button. Track 3 is now programmed.

Program #2 will now show in the display, ready for your next selection of track.



4. Repeat steps 2 and 3 to program other tracks till you finish (up to 20 selections).

5. After programming is finished, press PLAY to begin programmed play. PROG changes to be steady on in the display, and music begins to play in the order you programmed.



NOTE:

- The player will stop automatically after all programmed tracks have been played.
- To quit programmed play, press STOP button once. Then you may press PLAY button to re-start normal play.

Your programming will be lost:

- When the alkaline batteries are exhausted or removed, or the AC ADAPTOR is disconnected.
- When the power is shut off.

45 SECOND ESP PLUS™ SYSTEM

9

This set is designed with 45 second ESP (Electronic Shock Protection) PLUS™ - which allows virtually unlimited gentle skip protection, and 45 second normal shock protection.

The ESP PLUS™ function prevents the sound from skipping by using a buffer memory that stores music data. The new ESP PLUS™ system can store more music than normal anti-skip systems.

This new design allows gentle swaying of the set without music skipping as in walking. This set will not work during jogging.

The ESP PLUS™ function will turn on automatically when the PLAY/PAUSE button is pressed. Press the ESP+ button to turn off the ESP PLUS™ if you need not ESP PLUS™ function.

When the ESP PLUS™ function is switched ON or OFF during play, the sound will be interrupted for a few seconds. This is normal.

When the PLAY/PAUSE button is pressed during play, the "○" (memory buffer) indicator will appear in the display, the digital data equivalent to approximately 45 seconds of music is stored in the "read-ahead" memory buffer before it is decoded and played.

The "○" mark changes to the "⊗" mark, indicating that the memory buffer is full.

- When the set is subject to a shock or a bump during play, the data stored in memory continues to be decoded and played. This gives the pickup time to stabilize and continue reading new music. As the data is used from memory, the indicator changes from "⊗" to "⊗". Once the pickup returns to its original position, new data is stored in memory and the display changes back to the "⊗" mark.
- If the set is subject to repeated shocks and all the data stored in memory is used up, the "○" mark is displayed and the sound will skip or stop for a brief period until the memory buffer has time to fill up again.
- To turn off the 45 second ESP PLUS™ function, press the ESP button.
- Keep the digital ESP PLUS™ function off when using the set in a stable, no vibration area, where it will not receive shocks. The batteries will last longer when the ESP function is off.

NOTE:

- The music may stop if the player receives continuous shocking.
- You may hear noise or skipping if the CD is dirty or scratched.
- If during ESP play, you press PLAY/PAUSE, or SEARCH buttons, the memory buffer will empty itself temporarily.



CD87(12A-45J2)010801 NL v.1 

MAINTENANCE

Cleaning the lens

A dirty lens will cause sound skipping. If the lens is very dirty, the player may not work. We suggest using a special cleaning disk (not included) available in most music and Hi-Fi stores. However, if you do not have one, you may use a cotton swab very slightly dampened with alcohol to clean the lens.

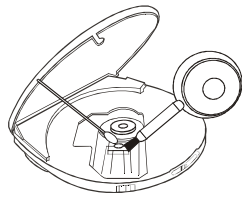

Cleaning the cabinet

Wipe with a soft cloth. If the cabinet is very dirty, dampen (not dripping wet) the cloth with a weak solution of soapy water, and then wipe clean.

Cleaning the Discs

- Fingerprints should be carefully wiped from the surface of disc with a soft cloth. Unlike conventional records, compact discs have no grooves to collect dust and microscopic dirt, so gently wiping them with a soft cloth should remove most particles. Wipe in a straight motion from the center to the edge.

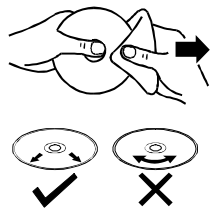

- Never use thinner, benzene, record cleaner or antistatic spray on a compact disc. Such chemicals can damage its plastic surface.

Handling Compact Discs

- Dirty, scratched or warped discs may cause skipping or noise.
- Handle the disc only by the edges. To keep clean, do not touch its surface.

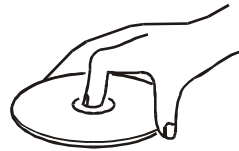

- Discs should be stored in their cases after use to avoid scratches.
- Do not expose discs to direct sunlight, high humidity, high temperatures, or dust, etc. Prolonged exposure to extreme temperatures can warp the disc (such as leaving the discs in your car during summertime).
- Do not stick or write anything on either side of disc. Sharp writing instruments, or the inks used in some felt-tip pens, may damage its surface.

To remove the Disc

Open the CD DOOR by sliding the DOOR OPEN button, hold the disc by the edge while slightly pressing on the center spindle as illustrated, then lift it from the edge to release and remove.

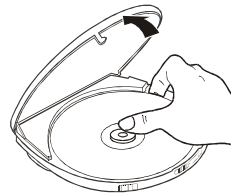

NOTE

Always press the STOP button and wait for the disc to stop rotating before sliding the DOOR OPEN button to remove the disc.

CD87(12A-45J2)010801 NL v.1

SAFETY PRECAUTIONS

11

Do not take the set apart. The laser beam used in the set may harm your eyes. Refer servicing to qualified service personnel only.

Do not insert pins or coins, clips, or any objects inside the set.

This set is equipped with a safety device which automatically turns the laser beam off when the CD DOOR is opened.

Do not drop the set or subject it to strong shocks. Doing so could result in damage.

Do not place the set in locations where the temperature is high, or in humid or dusty locations, or locations with long heavy vibrations, or tilted surfaces.

The set's cabinet may warp or the set may be damaged if it is placed in direct sunlight, near heaters (where the temperature is 140°F/60°C or higher) or in cars with the windows closed. In the summer, the temperature may get as high as 212°F/100°C or more.

Use the set within a temperature range of 41°F/5°C to 95°F/35°C.

Use ONLY the AC ADAPTOR provided, others may damage your set. Disconnect the ADAPTOR from the wall outlet when the set is not to be used for an extended period of time (3 days or more).

When cleaning your set, use a soft dry cloth. Do not use solvents or commercially available cleaners, as they may damage or discolor the finish.

Do not wear headphones while operating a motor vehicle. This could create a traffic hazard and is illegal in many areas. Do not use this set when bicycling or running.

The headphones supplied with your set provide superb stereo listening while allowing you to hear some outside sounds when listening at normally low volume levels. Listening at extremely high volume levels minimizes the intrusion of outside noise/sounds. In the interest of safety, it is strongly advised against the use while engaging in activities where the exclusion of external sounds (whistles, horns, sirens, traffic, etc.) could be hazardous. Also loud volume can hurt your ears. If you notice that the sound has become weak or distorted or if tracks do not change, this is an indication that your batteries are weak. Replace both batteries at the same time (see Using with Batteries). Your CD-87 is identified by a serial number located in the BATTERY COMPARTMENT. Record this number in the space provided below.

Model CD-87	Serial No. <input type="text"/>	Date Purchased: <input type="text"/>
-------------	---------------------------------	--------------------------------------

This manual contains detailed information on its safety and use. Please read it carefully so that you may take full advantage of its many features, and ensure a safe reliable operation. Keep this manual for future reference.

CONDENSATION

If cold water is poured into a glass, water droplets form on the outside of the glass. This is called condensation. Condensation may occur on internal operating parts of the lens.

Condensation occurs:

When the set is brought from the cold outdoors into a warm room, or if it is in a cold room to a room which is heated, or in the summer, if the set is moved from an air-conditioned room or car to a hot or humid location.

Should condensation occur, the set may not operate properly. Open the CD DOOR and wait for about 20 minutes (to allow the internal parts to adjust to the surrounding temperature) before using the set.

CD87(12A-45J2)010801 NL v.1 

IMPORTANT REQUIREMENT BY THE FCC 12

Since the CD circuitry may cause interference to other radios nearby, switch this set off when not in use or move it away from the affected radios.

This device complies with Part 15 of the FCC Rules. Operation is subject to the following two conditions: (1) This device may not cause harmful interference, and (2) This device must accept any interference received, including interference that may cause undesirable operation.

NOTE: This equipment has been tested and found to comply with the limits for a Class B digital device, pursuant to Part 15 of the FCC Rules. These limits are designed to provide reasonable protection against harmful interference in a residential installation. This equipment generates, uses and can radiate radio frequency energy and, if not installed and used in accordance with the instructions, may cause harmful interference to radio communications. However, there is no guarantee that interference will not occur in a particular installation. If this equipment does cause harmful interference to radio or television reception, which can be determined by turning the equipment off and on, the user is encouraged to try to correct the interference by one or more of the following measures:

- Reorient or relocate the receiving antenna.
- Increase the separation between the equipment and receiver.
- Connect the equipment into an outlet on a circuit different from that to which the receiver is connected.
- Consult the dealer or an experienced radio/TV technician for help.

SAFETY CERTIFICATION

This Compact Disc Player is made and tested to meet safety standards of the FCC requirements and comply with safety performance of the U.S. Department of Health and Human Services, and also with FDA Radiation Performance Standards 21 CFR Subchapter J.

WARNING

- To prevent fire or shock hazard, do not expose this appliance to rain or moisture.
- Unauthorized recording of copyrighted material may violate laws. Do not copy songs without permission of the copyright holder.

LASER SAFETY

THIS SET EMPLOYS AN OPTICAL LASER BEAM SYSTEM IN THE CD MECHANISM, DESIGNED WITH BUILT-IN SAFEGUARDS. DO NOT ATTEMPT TO DISASSEMBLE. EXPOSURE TO THIS INVISIBLE LASER LIGHT BEAM MAY BE HARMFUL TO HUMAN EYES. THIS IS A CLASS-1 LASER PRODUCT. USE OF ADJUSTMENTS OTHER THAN THOSE SPECIFIED HEREIN, MAY RESULT IN HAZARDOUS LASER LIGHT BEAM EXPOSURE. THIS COMPACT DISC PLAYER SHOULD NOT BE ADJUSTED OR REPAIRED BY ANYONE EXCEPT QUALIFIED SERVICE PERSONNEL. THE LASER MECHANISM IN THE SET CORRESPONDS TO THE STYLUS (NEEDLE) OF A RECORD PLAYER. ALTHOUGH THIS PRODUCT USES A LASER PICK-UP LENS, IT IS COMPLETELY SAFE WHEN OPERATED ACCORDING TO DIRECTIONS.

CD87(12A-45J2)010801 NL v.1 **E**

TROUBLE SHOOTING GUIDE

13

Symptoms	Causes	Solutions
Tracks do not change or set does not play normally.	Batteries are weak (they may test OK on tester but they are weak for CD operation).	Replace both batteries with fresh alkaline batteries. Battery life with fresh batteries is above 8 hours (rechargeable batteries have 1/2 of that life).
CD Player will not turn on.	Dead or weak batteries.	Replace both batteries with fresh ones.
	AC ADAPTOR not connected properly.	Check AC ADAPTOR connection at AC outlet and the right side of set.
Disc will not play.	Disc inserted incorrectly.	Re-insert disc with label side facing up.
	Defective compact disc.	Try another compact disc.
	CD DOOR not closed.	Close the door securely.
	Moisture has formed inside the CD deck.	Take out the CD and leave the CD DOOR open for about 20 minutes to dry the moisture condensation.
No sound from headphones.	Headphone plug not inserted properly.	Re-insert headphone plug into PHONES jack (not AUX OUT).
	VOLUME control set to minimum.	Increase the volume.
	Weak batteries.	Replace with fresh batteries or use AC ADAPTOR.
	Defective compact disc.	Try another compact disc.
VOLUME control has no function.	Headphones plugged into AUX OUT jack.	Plug headphones into PHONES jack. (NOT THE AUX OUT JACK)
Sound is skipping or sound stops.	The compact disc or lens is dirty or CD is scratched.	Clean or replace the compact disc or clean the lens.
	Strong vibrations.	Press the ESP button to start the ESP PLUS™ function, or place the player on a stable level.
Sound is distorted.	Music is too loud.	Lower the VOLUME control.
	BASS BOOST is ON.	Slide BASS BOOST switch to OFF.
	Weak batteries.	Replace both batteries or use AC ADAPTOR.
Buttons do not work.	Electronic or static error caused circuitry to lock.	Remove batteries and ADAPTOR. Wait 15 seconds and re-insert. Make sure batteries are fresh or ADAPTOR has power.

CD87(12A-45J2)010801 NL v.1 E

TECHNICAL SPECIFICATIONS

CD Player Section

Frequency response	20Hz-20kHz
Wow and flutter	Below measurable limits
Sampling frequency	44.1kHz
D/A converter	1-bit
Error correction method	CIRC
Pickup	Optical 3-beam semiconductor laser (780 nm wavelength)
Laser diode material	GaAlAs
Laser output less than	44.6µw

General

Maximum output (stereo headphones)	20mW + 20mW
Power Supply	
AC adaptor	120V/60Hz
DC	3V: Using 2 size "AA" batteries
Set Dimensions (approximate)	
Width	5 1/4"
Depth	5 3/4"
Height	1"
Weight (approximate)	9.5oz. (270g) (set only)

Because the products are subject to continuous improvement, Lenoxx reserves the right to modify product designs and specifications without notice and without incurring any obligation.

LIMITED WARRANTY

We warrant this product to be free from defects in material and workmanship under normal use for a period of 90 days after purchase and we will repair it free of charge or replace it at no charge, should it become defective under this warranty, providing you submit proof of purchase (sales slip) with the set.

During the initial 90 day period after original purchase, we will service or exchange, at no charge, the set that is returned to LENOXX ELECTRONICS CORP. After the initial 90 day period expires, and for a period of 12 months from original purchase, we will repair the unit covering any part(s) that need to be replaced at no charge, but will charge for the cost of labor, return postage paid by Lenoxx.

This warranty does not apply to any products which have been subject to misuse, neglect or accident. This warranty does not cover broken headphones or cabinet. **UNDER NO CIRCUMSTANCES WILL LENOXX ELECTRONICS CORP. BE LIABLE FOR ANY INCIDENTAL OR CONSEQUENTIAL DAMAGES.** Some states do not allow the exclusion or limitation of incidental or consequential damages, so the above limitations or exclusions may not apply to you.

This warranty gives you specific legal rights, and you may also have other rights which vary from state to state. The following charges apply to repairs beyond the warranty period: \$25.00. Be sure to pack carefully and return postage paid insured together with your money order (personal checks will not be accepted) and sales receipt to: LENOXX ELECTRONICS CORP. 2 GERMAK DRIVE, CARTERET N.J. 07008

For customer service Dial 1-800-315-5885

(MONDAY - THURSDAY 9:00 AM - 5:00 PM, FRIDAY 9:00 AM - 1:00 PM EST)

© 2001 LENOXX ELECTRONICS CORP.
2 GERMAK DRIVE
CARTERET, N.J. 07008
<http://www.lenoxx.com>
MADE & PRINTED IN CHINA

CD87(12A-45J2)010801 NL v.1 

Free Manuals Download Website

<http://myh66.com>

<http://usermanuals.us>

<http://www.somanuals.com>

<http://www.4manuals.cc>

<http://www.manual-lib.com>

<http://www.404manual.com>

<http://www.luxmanual.com>

<http://aubethermostatmanual.com>

Golf course search by state

<http://golfingnear.com>

Email search by domain

<http://emailbydomain.com>

Auto manuals search

<http://auto.somanuals.com>

TV manuals search

<http://tv.somanuals.com>