

Lenoxx Sound[®]

PROGRAMMABLE COMPACT DISC PLAYER

MODEL CD-57

OPERATING INSTRUCTIONS

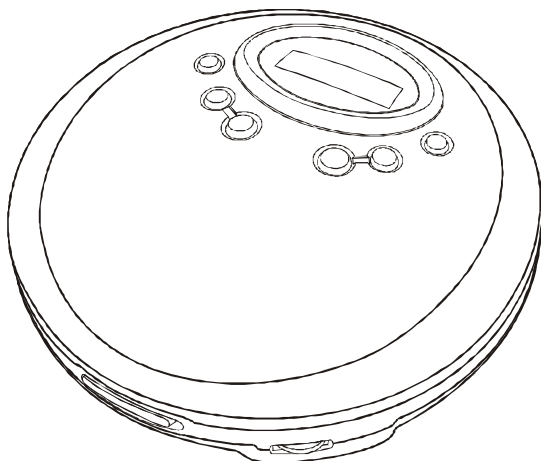

- **PLAYS MUSIC COMPACT DISCS**
- **6 DIGIT LCD VISUAL DISPLAY**
- **TRACK REPEAT & DISC REPEAT**
- **BASS BOOST SYSTEM**
- **DELUXE STEREO HEADPHONES INCLUDED**
- **USES 2 SIZE "AA" BATTERIES (NOT INCLUDED)**

PLEASE READ CAREFULLY BEFORE USE

IB-CD57-FD-E-063004



LOCATION OF CONTROLS

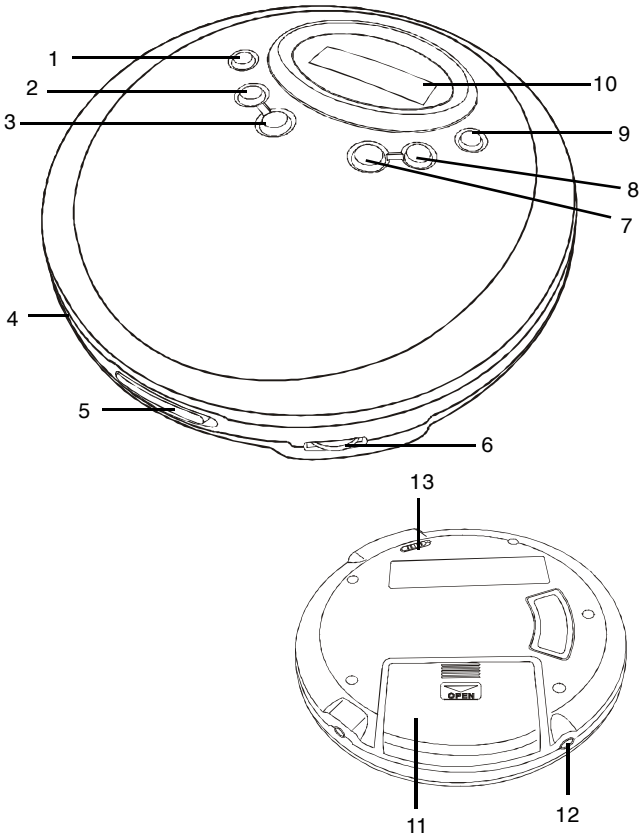

1. PROGRAM BUTTON
2. BACKWARD SKIP/SEARCH BUTTON (◀◀)
3. FORWARD SKIP/SEARCH BUTTON (▶▶)
4. HEADPHONE JACK
5. CD DOOR OPEN BUTTON (SLIDE TO OPEN)
6. VOLUME CONTROL
7. PLAY/PAUSE BUTTON (▶⏸)
8. STOP & POWER OFF BUTTON (■)
9. REPEAT BUTTON
10. LCD VISUAL DISPLAY
11. BATTERY DOOR
12. AC ADAPTOR JACK (AC ADAPTOR NOT INCLUDED)
13. BASS BOOST SWITCH



POWER SOURCES

Power this CD player by inserting 2 size "AA" fresh alkaline batteries.

USING WITH BATTERIES

Insert two size "AA" alkaline batteries according to the + and - markings on the bottom of the set.

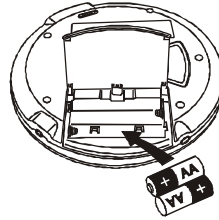

TIPS ON BATTERY USE

- Reversing polarities will damage the batteries and possibly this set. Be sure to follow polarity (+ and -) as indicated.
- Do not mix different types together (Alkaline, Carbon-Zinc, Nickel-Cadmium etc.), or old batteries with new ones.
- When not in use for an extended period of time, or while internal batteries will not be used, remove them to prevent possible acid leakage or corrosion resulting in damage to this player.
- When the batteries have become discharged, they must be disposed of in a safe manner that complies with all applicable laws.
- Installation of batteries should only be done by an adult (for safety).

ALKALINE BATTERY LIFE

Bear in mind that battery life expectancy is based upon volume and bass listening levels.

Maximum battery power consumption happens at maximum settings. Typical life for 2 size "AA" fresh alkaline batteries is above 8 hours of continuous CD play.

AC ADAPTOR (OPTIONAL)

You can also power this CD player by connecting an optional AC adaptor. Before you buy an optional AC Adaptor, please note, the only AC ADAPTOR suitable for this player is DC 4.5V 600mA, with polarity \ominus --- \oplus , others may damage this player. Please check voltage & current (mA) before buying an AC ADAPTOR.

WHEN SHOWS OR FLASHES IN THE DISPLAY

While the CD is playing, if the alkaline batteries are weak or discharged, this symbol " " shows or flashes in the display, then the power automatically turns off. If this occurs, replace both alkaline batteries (also if the display does not show anything, the batteries are dead).

NOTE: You may use rechargeable batteries on this set. However, because rechargeable batteries generally have lower voltage (1.2 volts instead of 1.5 volts), your playing time will be much less than normal fresh alkaline batteries.





CD PLAYING

1 Load the disc.

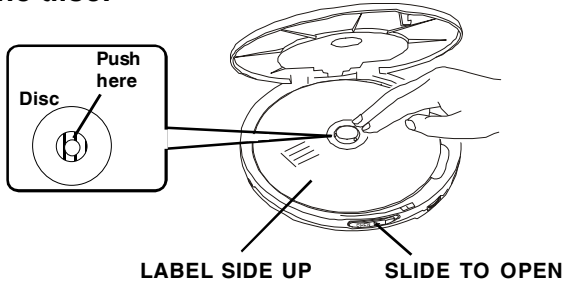

2 Connect the headphones.

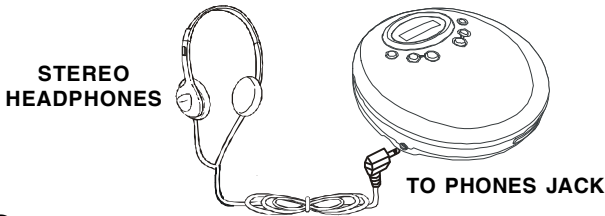

3 Press the PLAY/PAUSE button (▶||).

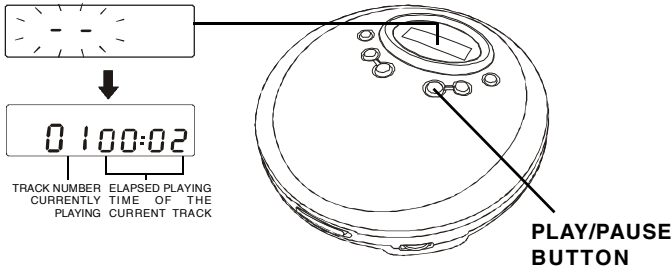

4 Adjust the volume.

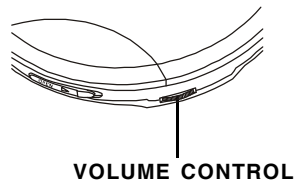
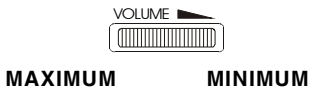



OTHER OPERATIONS

Operation ● **Press** ● **Display window shows**

To pause play

PLAY/PAUSE button

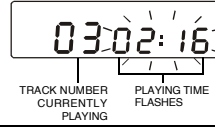

To release pause and resume play

PLAY/PAUSE button

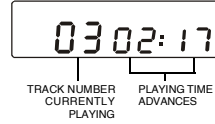

To stop play

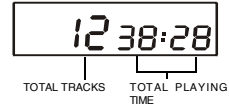

STOP button



To turn off the power

Press the STOP button once and wait 30 seconds, or press STOP button twice quickly.

To skip to the next track(s)

 once (or repeatedly)

To skip to the previous track(s)

 once (or repeatedly)

To go ahead at high speed (search forward)

Keep  depressed and release it when the desired music section of the disc is found.

- If you press and hold the SKIP button () while the last track is playing, and the end of the track is reached, the music stops and the display will show the total tracks and total playing time of the CD, then the power will shut itself off after 30 seconds.

To go back at high speed (search backward)

Keep  depressed and release it when the desired music section of the disc is found.

BASS BOOST switch

This switch enhances the low frequency (bass) sound at low listening levels. Switch the BASS BOOST switch (on the bottom of the set) ON or OFF to suit your taste.

BASS BOOST
ON OFF





REPEAT, INTRO AND RANDOM PLAY

You may have repeat, intro or random play using the REPEAT button. Press the REPEAT button several times, and the display will show the followings in turn:

REPEAT 1 → REPEAT ALL → INTRO → SHUFF → NORMAL PLAY

SINGLE TRACK REPEAT

Plays one song over and over till you press STOP.

During play, select the song you want to repeat with either of the SKIP/SEARCH buttons (◀◀ or ▶▶), then press the REPEAT button once, the symbol **REPEAT 1** appears in the display.

The song currently playing will repeat over and over, until you press STOP.



ALL TRACKS REPEAT (DISC REPEAT)

Repeats all songs in order till you press STOP.

During play, press the REPEAT button twice, the symbol **REPEAT ALL** will show in the display.

All songs will keep playing in sequence 1, 2, 3, etc. and when finished, will start all over again until you press the STOP.



INTRO PLAY

This plays the first 10 seconds of songs in sequential order.

1. During play, press the REPEAT button three times, the word **INTRO** will flash in the display.
2. Press the PLAY button, the word **INTRO** will stop flashing and the first 10 seconds of each song on the CD will play in sequential order.
3. When you find a song you like, press the PLAY button, normal play will be resumed, that song (and the following songs) will play normally.



RANDOM PLAY

This plays the songs on the disc in a random order.

1. During play, press the REPEAT button four times, the word **SHUFF** will flash.
2. Press the PLAY button, this will play all of the songs in random order selected by the CD player. The **SHUFF** will stop flashing.
3. Press the SKIP/SEARCH button ▶▶ to skip to the next random song.





PROGRAMMED PLAY

The tracks (songs) on the disc can be programmed (arranged in advance) to play in any order you prefer (up to 20 tracks can be programmed).

Programming Example									
Program Number	1	2	3	4	5	6	7	8	etc.
Track Number (song number)	3	5	8	1	2	4	1	1	etc.

During programming, the word **PROG** (program) flashes in the display. To program songs to play in your preferred order, follow steps below:

1. Press the PROGRAM button.



The word "PROG" and "00" will flash in the DISPLAY.



Program number

2. Press the SKIP/SEARCH button (◀▶ or ▶▶) to select track number 3 (example). the "PROG" and "03" will flash in the display.



Track number

3. Press the PROGRAM button to confirm. The track 3 is now programmed.



Program #2 will now show in the display, ready for your next selection of track.



4. Repeat steps 2 and 3 to program other tracks till you finish (up to 20 selections).

5. After programming is finished, press PLAY to begin programmed play. The word **PROG** shows in the display and music begins.



NOTE:

- The player will stop automatically after all programmed tracks have been played.
- To quit programmed play, press STOP button once. Then you may press PLAY button to re-start normal play.

Your programmed memory will be lost:

- When the power is off, or the CD Door is opened.
- When the alkaline batteries are exhausted or removed, or the AC ADAPTOR is disconnected.



MAINTENANCE

Cleaning the lens

A dirty lens will cause sound skipping. If the lens is very dirty, the player may not work. We suggest using a special cleaning disk (not included) available in most music and Hi-Fi stores. However, if you do not have one, you may use the instructions below.

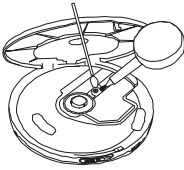

Use a cotton swab very slightly dampened with alcohol to clean the lens.

Cleaning the cabinet

Wipe with a soft cloth. If the cabinet is very dirty, dampen (not dripping wet) the cloth with a weak solution of soapy water, and then wipe clean.

Cleaning the Discs

- Fingerprints should be carefully wiped from the surface of disc with a soft cloth. Unlike conventional records, compact discs have no grooves to collect dust and microscopic dirt, so gently wiping them with a soft cloth should remove most particles. Wipe in a straight motion from the center to the edge.

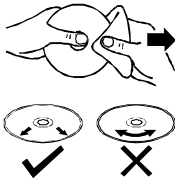

- Never use thinner, benzene, record cleaner or antistatic spray on a compact disc. Such chemicals can damage its plastic surface.

Handling Compact Discs

- Dirty, scratched or warped discs may cause skipping or noise.
- Handle the disc only by the edges. To keep clean, do not touch its surface.



- Discs should be stored in their cases after use to avoid scratches.
- Do not expose discs to direct sunlight, high humidity, high temperatures, or dust, etc. Prolonged exposure to extreme temperatures can warp the disc (such as leaving the discs in your car during summertime).
- Do not stick or write anything on either side of disc. Sharp writing instruments, or the inks used in some felt-tipped pens, may damage its surface.

To remove the Disc

Open the CD DOOR by sliding the **CD DOOR OPEN** button, hold the disc by the edge while slightly pressing on the center spindle as illustrated, then lift it from the edge to release and remove.

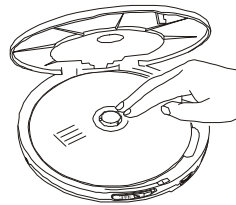

NOTE:

Always press the STOP button and wait for the disc to stop rotating before sliding the CD DOOR OPEN button to remove the disc.



SAFETY PRECAUTIONS

Do not take the set apart. The laser beam used in the set may harm your eyes. Refer servicing to qualified service personnel only.

Do not insert pins or coins, clips, or any objects inside the set.

This set is equipped with a safety device which automatically turns the laser beam off when the disc door is opened.

Do not drop the set or subject it to strong shocks. Doing so could result in damage.

Do not place the set in locations where the temperature is high, or in humid or dusty locations, or locations with long heavy vibrations, or tilted surfaces.

The set's cabinet may warp or the set may otherwise be damaged if it is placed in direct sunlight, near heaters (where the temperature is 140°F/60°C or higher) or in cars with the windows closed. In the summer, the temperature may get as high as 212°F/100°C or more.

Use the set within a temperature range of 41°F/5°C to 95°F/35°C.

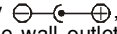
Use ONLY the optional DC 4.5V 600mA AC Adaptor with polarity , others may damage this set. Disconnect the Adaptor from the wall outlet when the set is not to be used for an extended period of time (3 days or more).

When cleaning this set, use a soft dry cloth. Do not use solvents or commercially available cleaners, as they may damage or discolor the finish. Do not wear headphones while operating a motor vehicle. This could create a traffic hazard and is illegal in many areas. Do not use this set when bicycling or running.

The headphones supplied with this set provide superb stereo listening while allowing you to hear some outside sounds when listening at normally low volume levels. Listening at extremely high volume levels minimizes the intrusion of outside noise/sounds. In the interest of safety, it is strongly advised against the use while engaging in activities where the exclusion of external sounds (whistles, horns, sirens, traffic, etc.) could be hazardous. Also loud volume can hurt your ears. If you notice that the sound has become weak or distorted or if tracks do not change, this is an indication that the batteries are low. Replace both batteries at the same time (see BATTERY OPERATION).

This CD-57 is identified by a serial number located in the BATTERY COMPARTMENT. Record this number in the space provided below.

Model CD-57

Serial No.

Date Purchased:

This Instruction Manual contains detailed information on its safety and use. Please read it carefully so that you may take full advantage of its many features, and ensure a safe reliable operation. Keep this Instruction Manual for future reference.

CONDENSATION

If cold water is poured into a glass, water droplets form on the outside of the glass. This is called condensation. Condensation may occur on internal operating parts of the lens.

Condensation occurs:

When the set is brought from the cold outdoors into a warm room, or if it is in a cold room to a room which is heated, or in the summer, if the set is moved from an air-conditioned room or car to a hot or humid location.

Should condensation occur, the set may not operate properly. Open the CD DOOR and wait for about 20 minutes (to allow the internal parts to adjust to the surrounding temperature) before using the set.



IMPORTANT INFORMATION REQUIRED BY THE FCC

Since the CD circuitry may cause interference to other radios nearby, switch this set off when not in use or move it away from the affected radios.

This device complies with Part 15 of the FCC Rules. Operation is subject to the following two conditions: (1) This device may not cause harmful interference, and (2) This device must accept any interference received, including interference that may cause undesirable operation.

NOTE: This equipment has been tested and found to comply with the limits for a Class B digital device, pursuant to Part 15 of the FCC Rules. These limits are designed to provide reasonable protection against harmful interference in a residential installation. This equipment generates, uses and can radiate radio frequency energy and, if not installed and used in accordance with the instructions, may cause harmful interference to radio communications. However, there is no guarantee that interference will not occur in a particular installation. If this equipment does cause harmful interference to radio or television reception, which can be determined by turning the equipment off and on, the user is encouraged to try to correct the interference by one or more of the following measures:

- Reorient or relocate the receiving antenna.
- Increase the separation between the equipment and receiver.
- Connect the equipment into an outlet on a circuit different from that to which the receiver is connected.
- Consult the dealer or an experienced radio/TV technician for help.

SAFETY CERTIFICATION

This Compact Disc Player is made and tested to meet safety standards of the FCC requirements and compliance with safety performance of the U.S. Department of Health and Human Services, and also with FDA Radiation Performance Standards 21 CFR Subchapter J.

WARNING

- To prevent fire or shock hazard, do not expose this appliance to rain or moisture.

LASER SAFETY

THIS SET EMPLOYS AN OPTICAL LASER BEAM SYSTEM IN THE CD MECHANISM, DESIGNED WITH BUILT-IN SAFEGUARDS. DO NOT ATTEMPT TO DISASSEMBLE. EXPOSURE TO THIS INVISIBLE LASER LIGHT BEAM MAY BE HARMFUL TO HUMAN EYES. THIS IS A CLASS-1 LASER PRODUCT. USE OF ADJUSTMENTS OTHER THAN THOSE SPECIFIED HEREIN, MAY RESULT IN HAZARDOUS LASER LIGHT BEAM EXPOSURE. THIS COMPACT DISC PLAYER SHOULD NOT BE ADJUSTED OR REPAIRED BY ANYONE EXCEPT QUALIFIED SERVICE PERSONNEL. THE LASER MECHANISM IN THE SET CORRESPONDS TO THE STYLUS (NEEDLE) OF A RECORD PLAYER. ALTHOUGH THIS PRODUCT USES A LASER PICK-UP LENS, IT IS COMPLETELY SAFE WHEN OPERATED ACCORDING TO DIRECTIONS.



TROUBLE SHOOTING

Symptoms	Causes	Solutions
Tracks do not change or set does not play normally.	Batteries are weak (they may test OK on tester but they are weak for CD operation).	Replace both batteries with fresh alkaline batteries. Battery life with fresh batteries is above 8 hours for continuous CD play (rechargeable batteries have 1/2 of that life).
CD Player will not turn on.	Dead or weak batteries.	Replace both batteries with fresh ones.
	The optional AC ADAPTOR not connected properly.	Check the optional AC ADAPTOR connection at AC outlet and the rear of the set.
Disc will not play.	Disc inserted incorrectly.	Re-insert disc with label side facing up.
	Defective compact disc.	Try another compact disc.
	CD DOOR not closed.	Close the door securely.
	Moisture has formed inside the CD deck.	Take out the CD disc and leave the CD Door open for about 20 minutes to dry the moisture condensation.
No sound from headphones.	VOLUME control set to minimum.	Increase the volume.
	Weak batteries.	Replace with fresh batteries or use the optional AC ADAPTOR.
Sound is skipping or sound stops.	The compact disc or lens is dirty or CD is scratched.	Clean or replace the compact disc or clean the lens.
Sound is distorted.	Music is too loud.	Lower the VOLUME control.
	BASS BOOST is ON .	Slide BASS BOOST switch to OFF.
	Weak batteries.	Replace both batteries or use the optional AC ADAPTOR.
Buttons do not work.	Electronic or static error caused circuitry to lock.	Remove batteries and the optional AC ADAPTOR. Wait 15 seconds and re-insert. Make sure batteries are fresh or the optional AC ADAPTOR has power.



TECHNICAL SPECIFICATIONS

General

Maximum output
(stereo headphones).....20mW + 20mW

Power Supply

AC Adaptor Input..... 120V/60Hz-4.5V DC Output (optional)

DC3V: Using 2 size "AA" alkaline batteries

Set Dimensions (approximate)

 Width 5 3/4"

 Depth 5 3/4"

 Height 1"

Weight (approximate) 9.5oz. (270g) (set only)

CD Player Section

Frequency response 50Hz - 15kHz +/-2dB

Sampling frequency44.1kHz

D/A converter 1-bit

Error correction method CIRC

Pickup Optical 3-beam semiconductor laser
(780 nm wavelength)

Laser diode material GaAlAs
Laser output less than 44.6μW

NOTE: This CD player will only play **NORMAL** music CDs (or CD-R CDs).
This set will not play **CD-RW** encoded discs.

Because the products are subject to continuous improvement, LENOXX reserves the right to modify product designs and specifications without notice and without incurring any obligation.





LIMITED WARRANTY

We warrant this product to be free from defects in material and workmanship under normal use for a period of 1 year after purchase and we will repair it free of charge or replace it at no charge, should it become defective under this warranty, providing you submit proof of purchase (sales slip) with the set.

During the initial 1 year period after original purchase, we will service or exchange, at no charge, the set that is returned to LENOXX ELECTRONICS CORP. After the initial 1 year period expires, we will repair the unit covering any part(s) that need to be replaced at no charge, but will charge for the cost of labor, return postage paid by Lenoxx.

This warranty does not apply to any products which have been subject to misuse, neglect or accident. This warranty does not cover broken headphones or cabinet. UNDER NO CIRCUMSTANCES WILL LENOXX ELECTRONICS CORP. BE LIABLE FOR ANY INCIDENTAL OR CONSEQUENTIAL DAMAGES. Some states do not allow the exclusion or limitation of incidental or consequential damages, so the above limitations or exclusions may not apply to you.

This warranty gives you specific legal rights, and you may also have other rights which vary from state to state. The following charges apply to repairs beyond the warranty period: \$8.00. Be sure to pack carefully and return postage paid insured together with your money order (personal checks will not be accepted) and sales receipt to:

LENOXX ELECTRONICS CORP., 2 GERMAK DRIVE, CARTERET N.J. 07008.

For customer service Dial: 1-800-315-5885

(MONDAY - THURSDAY 9:00 AM - 5:00 PM, FRIDAY 9:00 AM - 1:00 PM EST)

<http://www.lenoxx.com>

© 2004 LENOXX ELECTRONICS CORP.
2 GERMAK DRIVE
CARTERET, N.J. 07008
MADE & PRINTED IN CHINA

Free Manuals Download Website

<http://myh66.com>

<http://usermanuals.us>

<http://www.somanuals.com>

<http://www.4manuals.cc>

<http://www.manual-lib.com>

<http://www.404manual.com>

<http://www.luxmanual.com>

<http://aubethermostatmanual.com>

Golf course search by state

<http://golfingnear.com>

Email search by domain

<http://emailbydomain.com>

Auto manuals search

<http://auto.somanuals.com>

TV manuals search

<http://tv.somanuals.com>