

Regent

MODEL HT-391

Home Theater System

**— Turns Your DVD Player Into a 5.1 Channel —
Home Theater Surround Sound System**

**5.1 CHANNEL
SYSTEM**

**SURROUND
SOUND**



— The Perfect Sound System for Your DVD Player —

- Just add your TV & DVD player; everything else is in the box.
- Incredible surround sound, perfect for DVD viewing & enhanced TV game experience.
- Also provides superior sound for computer system



PLEASE READ CAREFULLY BEFORE USE

IB-HT391-WM-E-073003

SAFETY INSTRUCTIONS

WARNING

TO PREVENT FIRE OR SHOCK HAZARD, DO NOT USE THE PLUG WITH AN EXTENSION CORD, RECEPTACLE OR OTHER OUTLET UNLESS THE BLADES CAN BE FULLY INSERTED TO PREVENT BLADE EXPOSURE. TO PREVENT FIRE OR SHOCK HAZARD, DO NOT EXPOSE THIS APPLIANCE TO RAIN OR MOISTURE.

 <p>The lightning flash with arrowhead symbol, within an equilateral triangle, is intended to alert the user to the presence of uninsulated "dangerous voltage" within the product's enclosure that may be of sufficient magnitude to constitute a risk of electric shock to persons.</p>	WARNING RISK OF ELECTRIC SHOCK DO NOT OPEN WARNING: TO REDUCE THE RISK OF ELECTRIC SHOCK, DO NOT REMOVE COVER (OR BACK). NO USER SERVICEABLE PARTS INSIDE. REFER SERVICING TO QUALIFIED SERVICE PERSONNEL.	 <p>The exclamation point within an equilateral triangle is intended to alert the user to the presence of important operating and maintenance (servicing) instructions in the literature accompanying the appliance.</p>
--	--	---

SEE BOTTOM OF THE MAIN SET.

IMPORTANT SAFETY INSTRUCTIONS

1. Read these instructions.
2. Keep these instructions.
3. Heed all warnings.
4. Follow all instructions.
5. Do not use this apparatus near water.
6. Clean only with dry cloth.
7. Do not block any ventilation openings, install in accordance with the manufacturer's instructions.
8. Do not install near any heat sources such as radiators, heat registers, stoves, or other apparatus (including amplifiers) that produce heat.
9. Do not defeat the safety purpose of the polarized or grounding-type plug. A polarized plug has two blades with one wider than the other. A grounding type plug has two blades and a third grounding prong. The wide blade or the third prong are provided for your safety. If the provided plug does not fit into your outlet, consult an electrician for replacement of the obsolete outlet.
10. Protect the power cord from being walked on or pinched particularly at plugs, convenience receptacles, and the point where they exit from the apparatus.
11. Only use attachments/accessories specified by the manufacturer.
12. Unplug this apparatus during lightning storms or when unused for long periods of time.
13. Refer all servicing to qualified service personnel. Servicing is required when the apparatus has been damaged in any way, such as power-supply cord or plug is damaged, liquid has been spilled or objects have fallen into the apparatus, the apparatus has been exposed to rain or moisture, does not operate normally or has been dropped.
14. This appliance shall not be exposed to dripping or splashing water and that no object filled with liquid such as vases shall be placed on the apparatus.

Do not apply oil or petroleum products or solvents to any part of this set.

Cleaning the Cabinet

Clean the cabinet and controls with a very dry or slightly moistened soft cloth. Do not use any type of abrasive pad, scouring powder, or solvents, such as alcohol or benzene.

Regent

MODEL: HT-391

HOME THEATER SYSTEM

AC ~ 120V 60Hz

POWER CONSUMPTION:

100 Watts

MADE IN CHINA



SEE BOTTOM OF THE MAIN SET.

FCC NOTE

This equipment has been tested and found to comply with the limits for a Class B digital device, pursuant to Part 15 of the FCC rules. These limits are designed to provide reasonable protection against harmful interference in a residential installation. This equipment generates, uses and can radiate radio frequency energy and, if not installed and used in accordance with the instructions, may cause harmful interference to radio communications. However, there is no guarantee that interference will not occur in a particular installation. If this equipment does cause harmful interference to radio or television reception, which can be determined by turning the equipment off and on, the user is encouraged to try to correct the interference by one or more of the following measures.

- Reorient or relocate the receiving antenna.
- Increase the separation between the equipment and receiver.
- Connect this equipment into an outlet on a circuit different from that to which the receiver is connected.
- consult the dealer or an experienced radio/TV technician for help.

CAUTION

FCC Regulations state that unauthorized changes or modifications to this equipment may void the user's authority to operate it.

PRECAUTIONS

ON SAFETY

Should any solid object or liquid fall into the Home Theater System, unplug the player, and have it checked by qualified personnel before operating it any further.

ON PLACEMENT OF YOUR HOME THEATER SYSTEM

- Do not leave the Home Theater in a location near a heat source, or in a place subject to direct sunlight, excessively dusty rooms or rooms with very high humidity.
- Do not place the Home Theater system on an inclined or unstable place.
- Do not place anything within 1 inch of the sides or 2 inches from the back of the cabinet. The heat sink fins must not be covered for the set to operate properly and prolong the life of its components.

INTRODUCTION

Thank you for purchasing this 5.1 Channel Home Theater Surround Sound System. This deluxe audio theater system turns your home into a virtual theater. In addition to the incredible surround sound of a 5.1 channel audio source, such as your current DVD player, this system also superbly enhances your other audio sources, such as a CD player, computer, VCR, or a cassette deck. The only thing you need to add is your own TV or other devices. We have designed this system to be easy to set up, but please, review this manual before you operate your system. Please have it handy while you are setting the system up; and keep it available for future reference, or in the unlikely event that you encounter any unexpected questions or problems. We have tried to keep this manual as simple as possible. It begins with how to connect the speakers, your TV, and other optional devices. It also includes instructions on how to position the speakers for the most natural surround sound. If you follow the instructions carefully you can have the system set up in about an hour.

This system was designed to provide you with many years of reliable operation with a minimum of care and maintenance. Every component in your system was perfect when it left our factory. If you experience any problem with the set-up or operation of this system, please review the Trouble Shooting Guide at the end of this manual before you contact the Customer Service Department at 1-800-315-5885.

All of the adjustable system settings have been preset at our factory for normal operation of the system. All you have to do is to sit back and enjoy the great home theater experience.

Later on, you may want to change some of the optional settings like speaker volume and balance settings. Instructions for changing them, are found later in this manual.

Basic Features & Benefits of this 5.1 Channel Home Theater System:

1. 5.1 channel audio decoder for home theater surround sound.
2. TV Game / Video Camera input jacks.
3. Includes audio inputs for DVD, AUX and GAME/CAMERA.
4. Customizable speaker level controls with indicators.
5. Powerful subwoofer provides real BOOM in your bass.
6. Deluxe easy-to-use remote control with batteries included.
7. LED indicators for DVD, AUXILIARY or GAME functions.
8. Designed for easy, mistake-proof color-coded speaker setup.
9. Compatible with computer sound system.

THIS SYSTEM CONTAINS

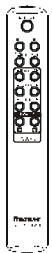

1 Remote Control

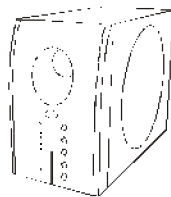

1 Main Set (Subwoofer)

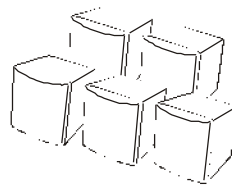

5 Satellite Speakers



2 "AAA" batteries

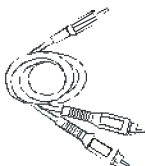

1 Set of Audio cables with green 3.5mm plug for Computer Connection (or other Source with 3.5mm Jack)

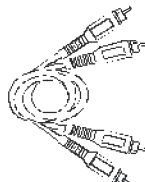

1 Set of Audio Cables for DVD or AUX IN (Red & White)

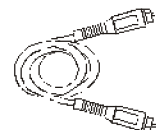

1 Yellow Video Cable

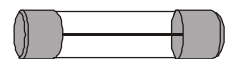

1 Spare Fuse

TABLE OF CONTENTS

• Getting Started

Safety Instructions	1
Introduction	2
Location of Controls	4,5
Remote Control Operation	6

• Connections

Choose Your Connection	7
Cables Needed to Connect Components to Your Home Theater System	7
Speaker system connections:	
Speaker system connections	8,9
Speaker Positioning Information	10,11
TV Connections	12
TV + DVD Connections	13
TV + VCR Connections	14
TV + VCR + Satellite Receiver Connections	15
TV + TV Game Connections	16
TV + Video Camera Connections	17
AUX IN Connections	18
AM/FM Tuner Connections	19
Computer Sound Connections	20

Amplifier in Main Unit

General	21
Volume Adjustment	22

• Listening Mode

5.1 Channel and Stereo Modes	23
------------------------------	----

• Trouble Shooting

• Specifications

LOCATION OF CONTROLS

FRONT OF MAIN SET (SUBWOOFER)

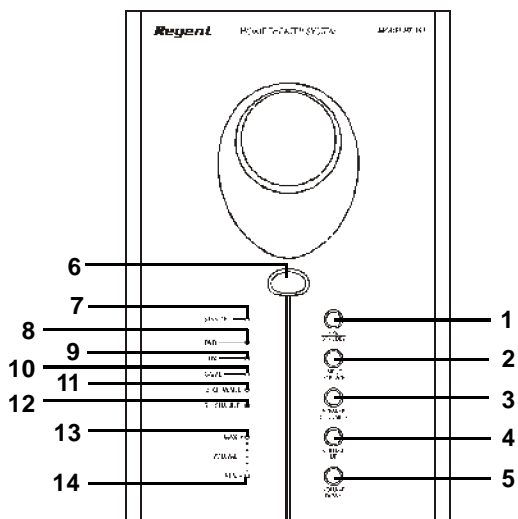

1. **ON / STANDBY button** - Press to switch the set to on or to standby mode.
2. **INPUT SOURCE button** - Press several times to select the sound input source you want: DVD, AUX or GAME.
3. **SPEAKER CHANNELS button** - Press to select 2 channel or 5.1 channel listening mode.
4. **VOLUME UP button** - Increases the volume level of all speakers.
5. **VOLUME DOWN button** - Decreases the volume level of all speakers.
6. **REMOTE SENSOR** - Receives the signal from the REMOTE CONTROL (aim the REMOTE control towards this sensor).
7. **STANDBY indicator** - This indicator has 2 modes: flashing and steadily on (slow flashing indicates the set is in standby, steadily on indicates the set is on). When the set is off (standby), pressing the ON/STANDBY button on the main set or on the REMOTE CONTROL will turn the set on, the indicator will become steadily on.
NOTE: The rear main power switch must be ON.
8. **DVD indicator** - For DVD sound use, press the INPUT SOURCE button on the main set till this lights or press the SOURCE button on your REMOTE control till this lights.
9. **AUX indicator** - For AUX IN sound use, press the INPUT SOURCE button on the main set till this lights or press the SOURCE button on your REMOTE control.
10. **GAME indicator** - For TV GAME or VIDEO CAMERA use, press the INPUT SOURCE button on the main set till this lights or press the SOURCE button on your REMOTE control.
11. **2 CHANNEL indicator** - When the listening mode is 2 channel, this indicator will light up. To change, press the SPEAKER CHANNELS button.
12. **5.1 CHANNEL indicator** - When the listening mode is 5.1 channel, this indicator will light up. To change, press the SPEAKER CHANNELS button.
13. **VOLUME MAX. indicator** - This indicator lights up when the MASTER VOLUME is at its maximum level, also it will flash confirming you pressed the VOLUME UP button of either the SUBWOOFER, or CENTER, or REAR, or the MASTER.
14. **VOLUME MIN. indicator** - This indicator lights up when the MASTER VOLUME is at its minimum level, also it will flash confirming you pressed the VOLUME DOWN button of either the SUBWOOFER, or CENTER, or REAR, or the MASTER.

BACK OF MAINSET (SUBWOOFER)

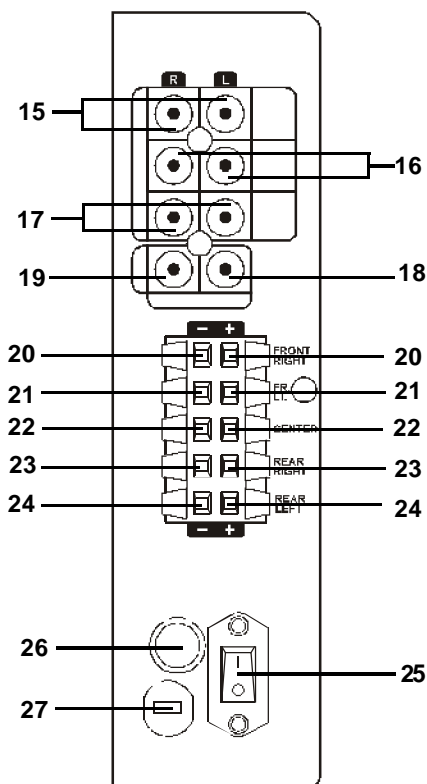

15. **DVD AUDIO INPUT jacks** - Connect to the audio output of a DVD player to have 5.1 channel surround sound.
16. **AUX INPUT jack** - Connect to the audio output of a tape deck or other component's output.
17. **GAME AUDIO INPUT jacks** - Connect to the audio output jack of a TV game or video camera.
18. **VIDEO INPUT jack** - For connection of a video signal from a TV game, or video camera, or other source.
19. **VIDEO OUT jack** - Connect to your TV's video input jack. (If your TV has no VIDEO jack, you have to buy a VIDEO RF MODULATOR.)
20. **FRONT RIGHT SPEAKER jacks** - Connect the FRONT RIGHT SPEAKER to the red and black terminals.
21. **FRONT LEFT SPEAKER jacks** - Connect the FRONT LEFT SPEAKER to the red and black terminals.
22. **CENTER SPEAKER jacks** - Connect only the CENTER SPEAKER to the blue and black terminals.
23. **REAR RIGHT SPEAKER jacks** - Connect the REAR RIGHT SPEAKER to the grey and black terminals.
24. **REAR LEFT SPEAKER jacks** - Connect the REAR LEFT SPEAKER to the grey and black terminals.
25. **POWER switch** - Press to power the set on or off.
NOTE: This switch must be ON in order to be able to use the ON/STANDBY button on the front of the main set or on the REMOTE CONTROL.
26. **FUSE HOLDER** with screw cover.
27. **AC LINE CORD** - Connect to a 120V/60Hz AC standard wall outlet.

LOCATION OF CONTROLS

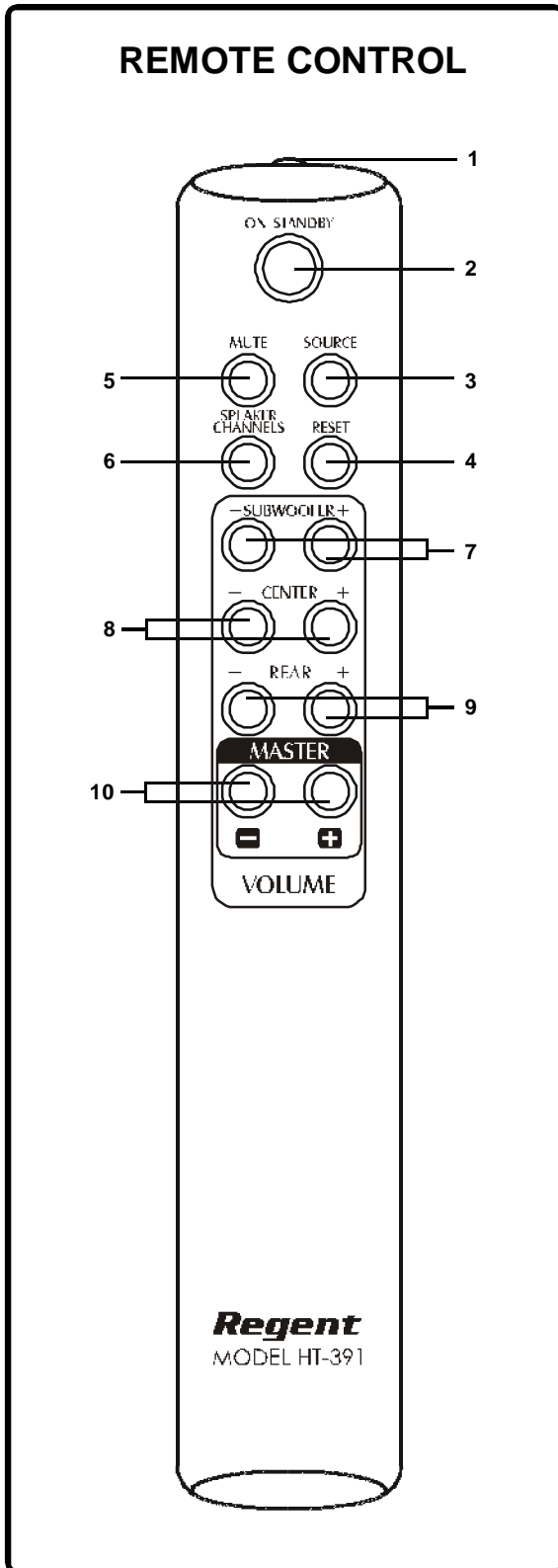

1. **IR DIODE** - Sends the signal to the set. Do not block or cover this.
2. **ON/STANDBY button** - Switches the player from STANDBY to ON or ON to STANDBY (if the main POWER of the set is ON).
3. **SOURCE button** - Press to select the sound input source you want: DVD, AUX or GAME.
4. **RESET button** - Press to adjust all speakers' output to the factory's default settings.
5. **MUTE button** - Instantly turns off the sound. Press again to restore the sound.
6. **SPEAKER CHANNELS button** - Press to select 2 channel or 5.1 channel listening mode.
7. **SUBWOOFER UP & DOWN VOLUME button** - Press to adjust the individual SUBWOOFER's sound level.
8. **CENTER UP & DOWN VOLUME button** - Press to adjust the individual CENTER speaker's sound level.
9. **REAR button** - Press to adjust the REAR LEFT/RIGHT speakers' sound level.
10. **MASTER VOLUME UP & DOWN button** - Press to adjust the sound level of all speakers.

SEE NEXT PAGE FOR REMOTE CONTROL BATTERY INSTALLATION.

REMOTE CONTROL OPERATION

Battery Installation

Remove the BATTERY COMPARTMENT DOOR of the REMOTE CONTROL and insert 2 size "AAA" alkaline batteries (included) according to the \oplus and \ominus markings inside the BATTERY COMPARTMENT of the REMOTE CONTROL unit.

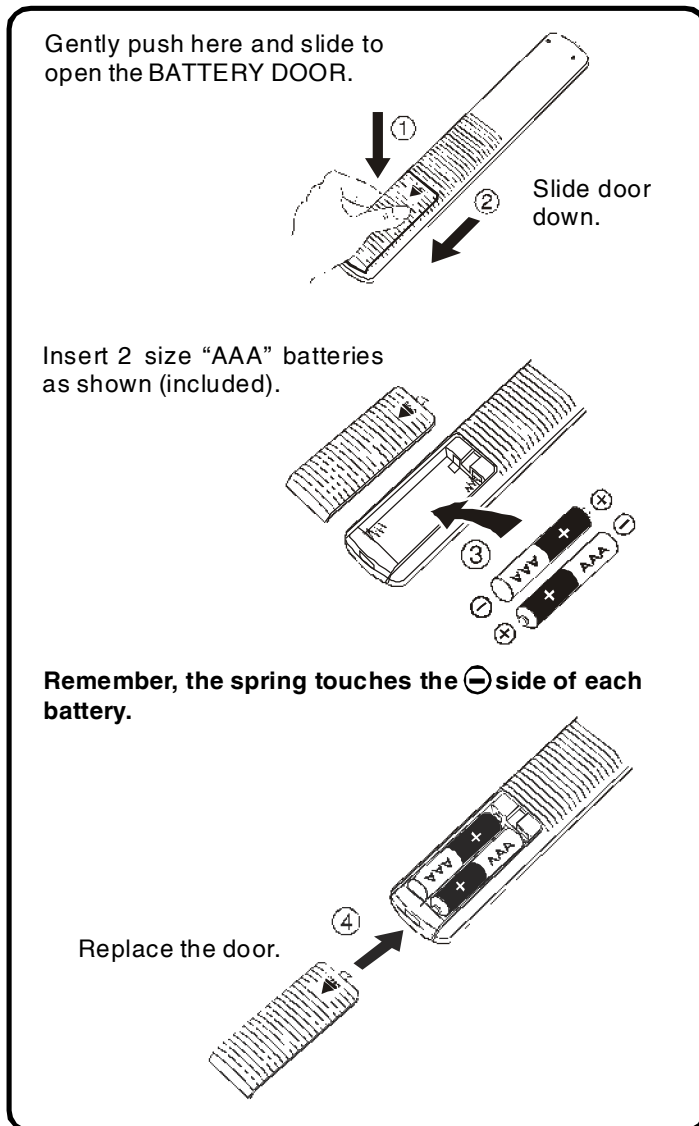

Tips on Battery Use

- Reversing polarities will damage the batteries and possibly your REMOTE. Be sure to follow polarity \oplus and \ominus as indicated.
- Do not mix different types of batteries together (Alkaline, Carbon-Zinc, Nickel-Cadmium etc.), or old batteries with new ones.
- When not in use for an extended period of time (over 60 days), remove the batteries to prevent possible acid leakage or corrosion resulting in possible damage to your REMOTE CONTROL.
- When the batteries have become discharged, they must be disposed of in a safe manner that complies with all applicable laws.
- Installation of batteries should only be done by an adult (for safety).

Remote Control Operating Range

Point the REMOTE CONTROL unit within 20 feet from the remote control sensor and facing the front of the HOME THEATER SYSTEM.

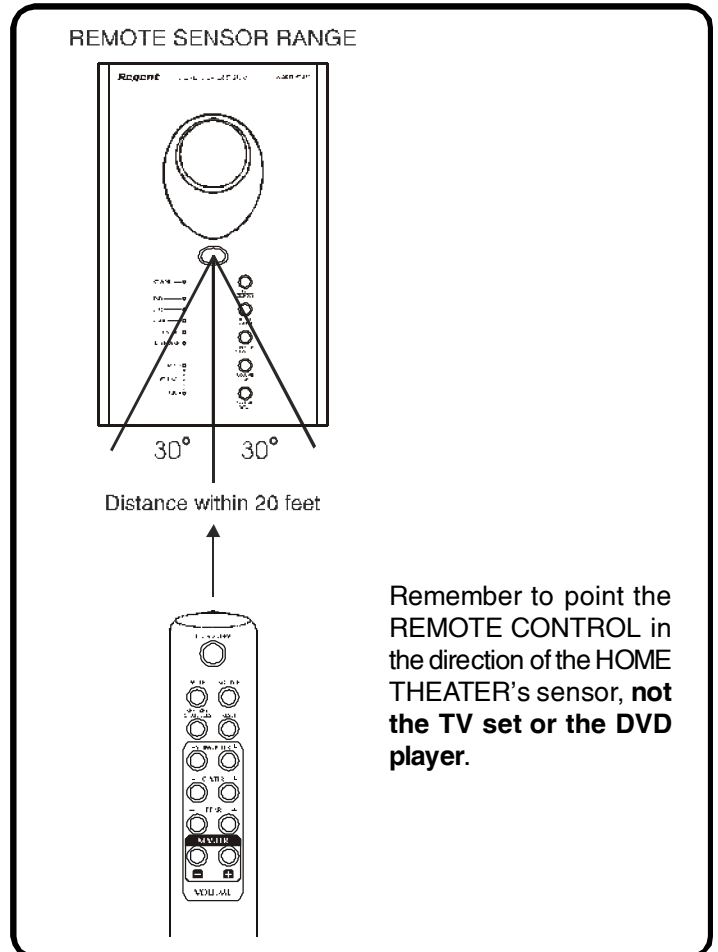

Point the REMOTE CONTROL at the Home Theater's Front

Make sure there is a clear path between the REMOTE CONTROL and the HOME THEATER SYSTEM so that the signal is not blocked.









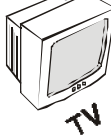

Tips on REMOTE CONTROL operation

- The REMOTE control's operating distance may vary according to the brightness of the room.
- Do not point bright lights at the REMOTE CONTROL SENSOR (like laser pointers).
- Do not place objects between the REMOTE CONTROL unit and the REMOTE SENSOR.
- Do not use this REMOTE CONTROL while simultaneously using the remote control unit of any other equipment, the signals may mix.
- Sometimes your TV's remote may cause an LED to flash, you can ignore this.

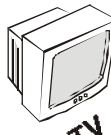
CONNECTIONS

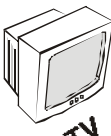
Choose Your Connection

There are several ways to connect your Home Theater System. Please use the following chart to determine which connection is the best for you. Turn to the appropriate page and connect your Home Theater System.

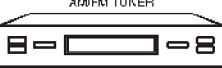
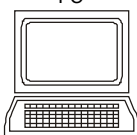
COMPONENTS		CABLES NEEDED	GO TO ...
	NOTE: This only applies if your TV has audio out jacks.	TV + HOME THEATER (only)	• Audio (included) Page 12
 		TV/DVD + HOME THEATER	• Video (included) • Audio (included) Page 13
 		TV/VCR + HOME THEATER	• Video (included) • Audio (included) Page 14
  		TV/VCR + HOME THEATER + SATELLITE	• Video (included) • Audio (included) Page 15
  		TV + HOME THEATER + TV GAME or VIDEO CAMERA	• Video (special, not included) • Audio (special, not included) Page 16,17
   		AM/FM TUNER or other AUX DEVICE + HOME THEATER	• Audio (included) Page 18,19,20

HOME THEATER SURROUND SOUND SYSTEM

Cables Needed to Connect Components to Your Home Theater System

The pictures below show the cables needed for the connections represented in this booklet.

NOTE: Audio cables are usually sold as a bundled set, but the connection sketches in this booklet show each cable separately for better visibility. You will need additional cables to connect everything shown above. Check your other equipments' booklets to see what cables are needed.

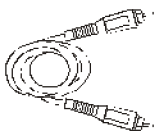

Yellow Video cable (one set included)

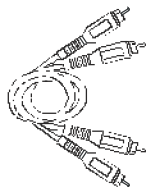

Red & White Audio cables (one set included, most installations will need these)

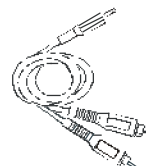

1 Set of Audio cables with green 3.5mm plug for Computer Connection (or other Source with 3.5mm Jack)



Speaker Wires (5 sets are attached to the back of the speakers)

SPEAKER SYSTEM CONNECTIONS

Speaker System Connections

Connect the supplied speaker system by matching the colors of the terminals to those of the cords.

IMPORTANT:

Before making connections, make sure the power is off.

The speaker wires and connectors are color-coded for easier set up.

- Connect the Front Left speaker to the Front Left terminals.
- Connect the Front Right speaker to the Front Right terminals.
- Connect the Center speaker to the Center speaker terminals.
- Connect the Rear Left speaker to the Rear Left terminals.
- Connect the Rear Right speaker to the Rear Right terminals.

QUICK SETUP DIAGRAM

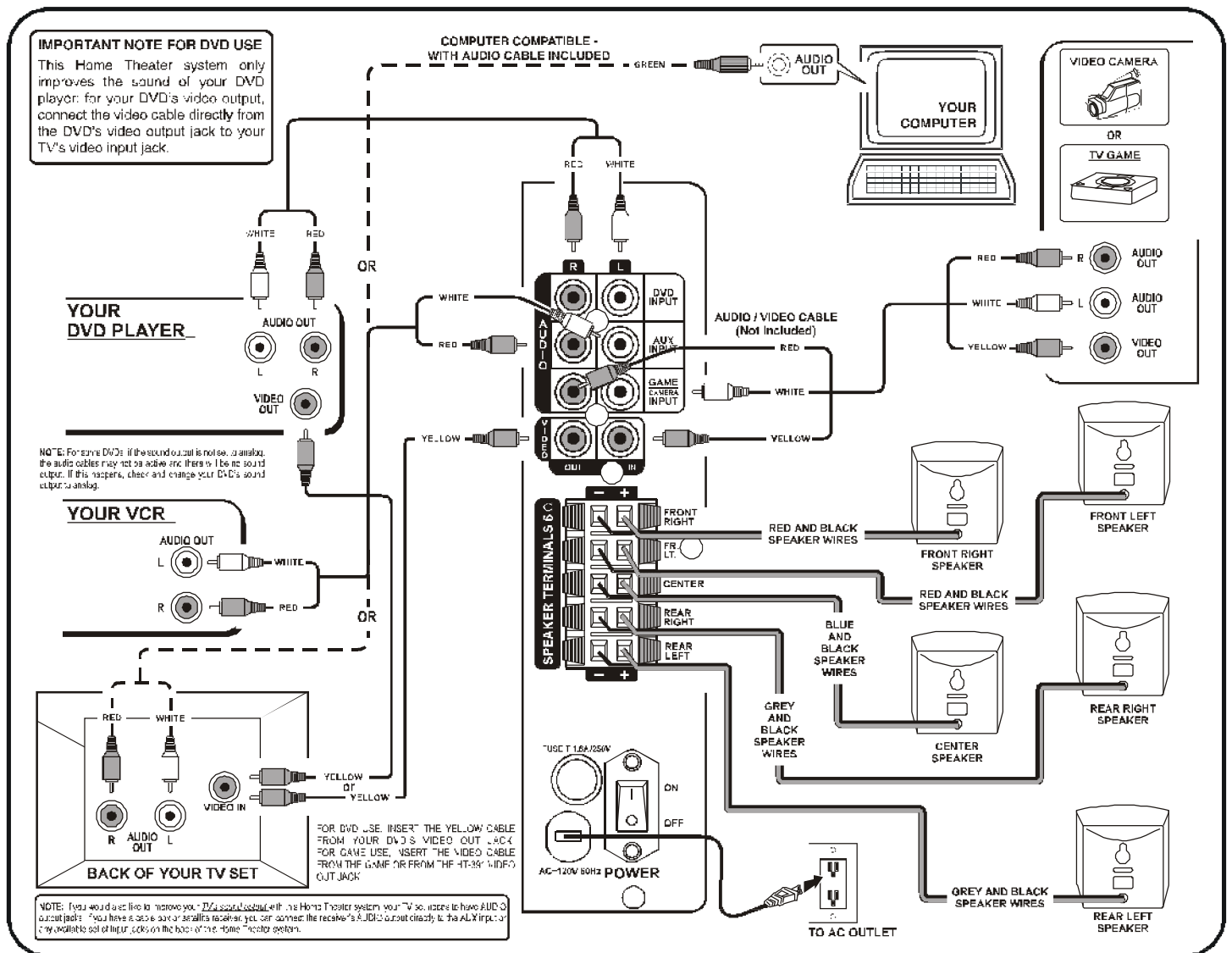

NOTE: If you would also like to improve your TV's sound output with this Home Theater system, your TV set needs to have AUDIO output jacks. If you have a cable box or satellite receiver, you can connect the receiver's AUDIO output directly to the AUX input or any available set of input jacks on the back of this Home Theater system.

SPEAKER SYSTEM CONNECTIONS

Tips for connecting the speaker wires

Unwind and stretch out the speaker wires attached with each speakers, then push and hold down the speaker terminal tab on the back of the main set to insert each wire. Make sure the wire is fully inserted, but the insulation is not covering the inserted part of the speaker wires.

SPEAKER TERMINALS

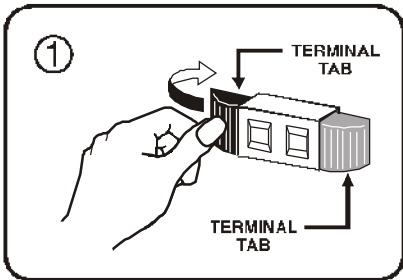

PUSH AND HOLD THE COLORED TAB OF TERMINAL.

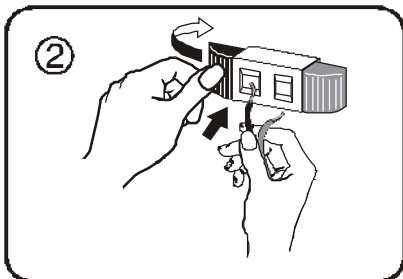

WHILE HOLDING THE TAB OF THE TERMINAL, STICK THE EXPOSED PART OF THE WIRE INTO THE HOLE OF THE TERMINAL.

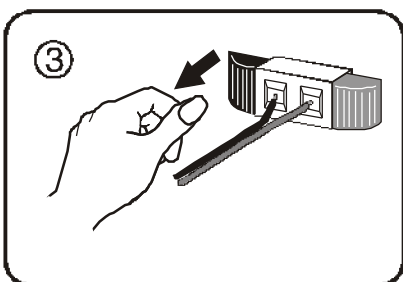

REMOVE YOUR FINGER FROM THE TERMINAL TO LOCK THE WIRE INSIDE THE TERMINAL.

**GO ON TO THE NEXT WIRE & REPEAT ABOVE.
MAKE SURE POWER IS OFF WHEN DOING THE ABOVE.**

NOTE:

Be sure to match the speaker wire to the appropriate terminal on the back of the main set: (+) to (+) (color), and (-) to (-) (black). If the wires are reversed, the sound will be distorted and will lack some tones. Follow the color codes of each terminals.

To avoid short-circuiting the speakers

- Make sure the stripped end of each speaker wire does not touch another speaker terminal or the stripped end of another speaker wire.

Examples of poor connection of the speaker wires

LOOSE STRANDS TOUCHING

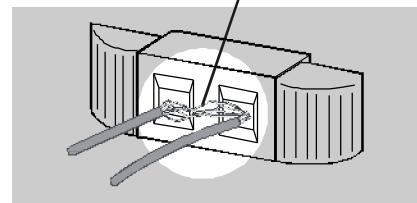

- Stripped speaker wire is touching another speaker terminal. **Make sure not even 1 strand of wire touches the other wire!**

WIRES SHORTED TO EACH OTHER

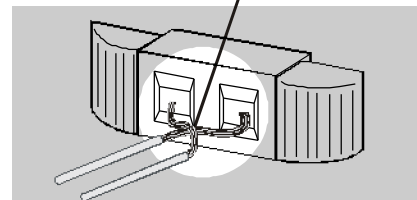

- Stripped wires are touching each other due to excessive removal of insulation. Do not allow the above to happen on your set.

NOTE: If longer wires are needed, you may buy any good quality speaker wire and splice the wires yourself. Please make sure the wires are not shorting to each other and observe the correct color polarity. Many speaker wires have a dotted line or solid line or raised rib on one side to identify each side.

Also make sure you use electrical tape to cover your splices.

SPEAKER POSITIONING INFORMATION—

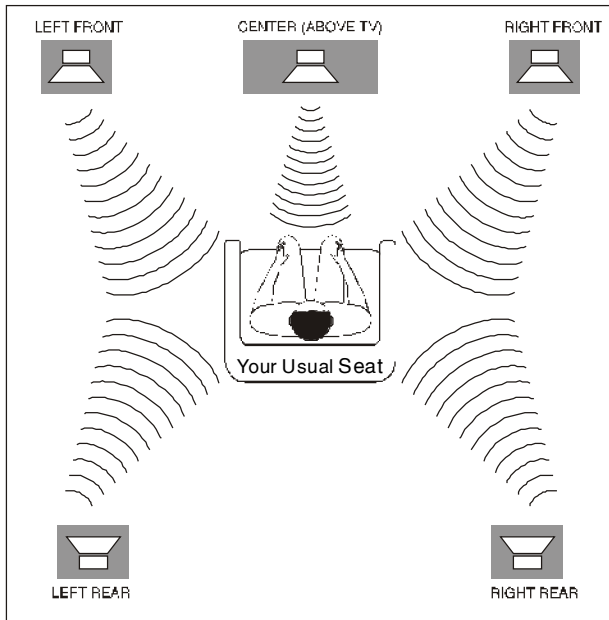

POSITION ALL 5 SPEAKERS APPROXIMATELY AT THE SAME DISTANCE FROM YOUR LISTENING POSITION. POSITION THE SUBWOOFER AS BELOW.

Your system is supplied with 5 compact sized satellite speakers and one large subwoofer (main set). The satellite speakers and the center speaker reproduce only the mid range and higher frequencies. All of the low frequency (bass) sounds are produced by the subwoofer. Proper positioning and placement of the speakers is important in order to provide the best surround sound experience. We understand that due to the size and shape of your listening room, and the location of your furniture, you may not be able to set up the speakers exactly as per these diagrams. However these simple guidelines will help you maximize your home theater experience.

- Note the speaker levels are preset at the factory and most people will not need to fine tune the sound of each speaker. We suggest you skip this part at first. Later on you can adjust the sound level of each individual speaker. See Page 22.
- Although all 5 satellites are of the same size, the speakers inside the cabinets are different. The speaker wires on the back of the cabinets are color-coded, as are the speaker terminals on the back of the main unit. Refer to the connection diagram on page 8. **Be sure you are using the correct satellite speaker in each location, front, rear and center.** Please follow the colors for best results.
- For best surround sound effects, all 4 of the satellite speakers and the center speaker should be roughly at the same distance from your usual listening position.

POSITION THE SPEAKERS LIKE THIS FOR OPTIMAL LISTENING EXPERIENCE

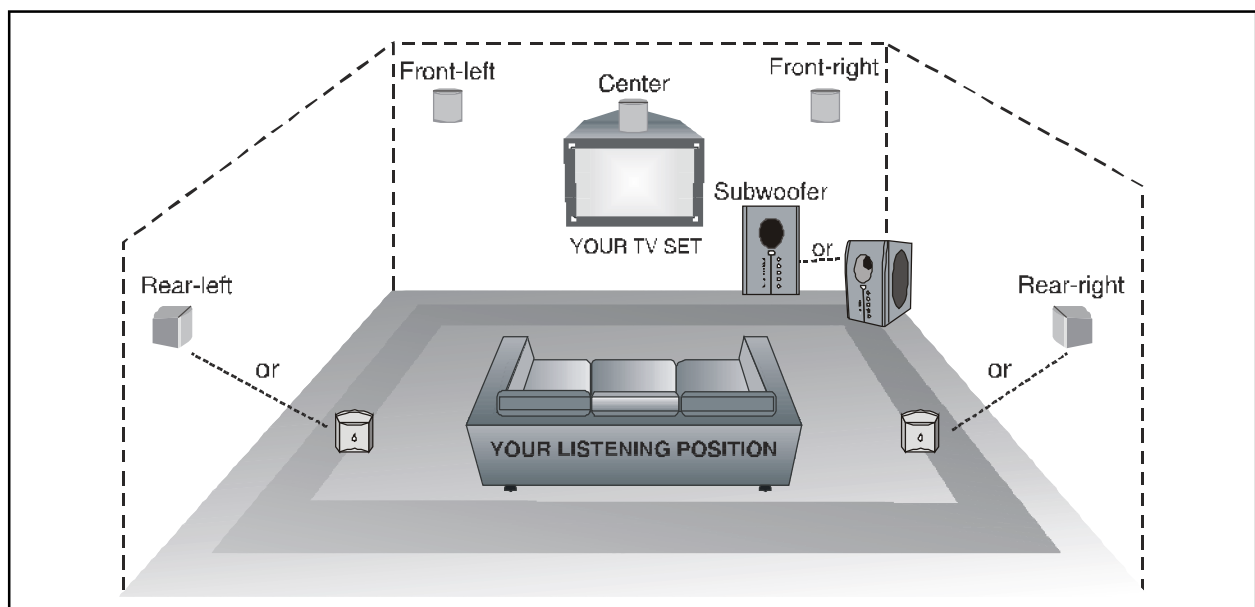

- The 4 satellite speakers and the center speaker should be placed approximately the same distance from your listening position.
- The center speaker should be placed directly above (or below) the TV set. Left and right front speakers should be approximately at the same height as the center speaker.
- The rear speakers should be either in line with, or behind your listening position, approximately at ear level, or slightly above.
- The subwoofer (main set) should be on the floor near the TV, or in any corner, but remember you need a clear path to your remote (don't block this set with a curtain).
- All speakers must be visible. Do not hide them behind curtains, furniture, etc, as this will affect the sound.

SPEAKER POSITIONING INFORMATION—

- The left front, right front, and center speakers should be placed at roughly the same height. The center speaker reproduces most of the dialog spoken by the actors on the TV screen, therefore it should be placed either directly above or below the center of the TV set. Once you position the center speaker, try to position the left front and right front speakers at the same height. It is not recommended to place any of the satellite speakers on the floor. Many people prefer to place the center speaker horizontally above the TV set.
- The left rear and right rear speakers can be placed in line with your listening position or behind your listening position. Ideally they should be placed slightly above your ear level when you are seated in your normal listening position.
- We have provided one keyhole opening on the backs of all the satellite speakers that allow the satellite speakers to be wall mounted in a vertical position.
- The subwoofer will provide the most dramatic bass effects (low frequency sounds like explosions and thunder) when it is placed on the floor. Do not place the subwoofer on a stand or table. The subwoofer should be placed in the front of the room so that it is facing towards your listening position. It can be placed on either side of the TV or even in the corner of the room, as far away as the cable will allow. The bass sounds from the subwoofer are non-directional. You will not really be able to tell where the bass is coming from.
- LONG ROOMS - In case your room is unusually long and longer wire are needed, you may buy any good quality speaker wire and splice the wires yourself for adding wire length to your speakers. Be careful not to allow the plus⊕ and minus⊖ wires to touch each other. Many speaker wires have a dotted line or solid line or raised rib on one side to identify each side.

Remember to cover the splices with electrical tape.

SATELLITE SPEAKERS

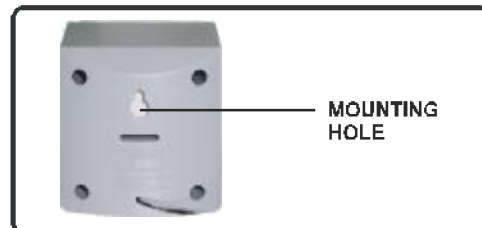
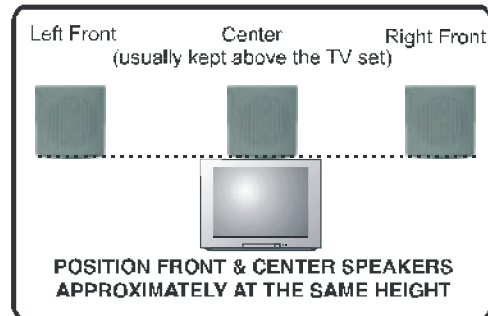

SUBWOOFER

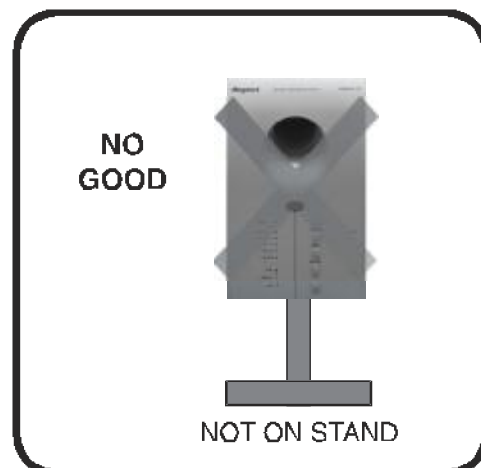

TV CONNECTIONS (If you don't have a DVD player yet)

Home Theater System + TV (if your TV has Audio Output jacks)

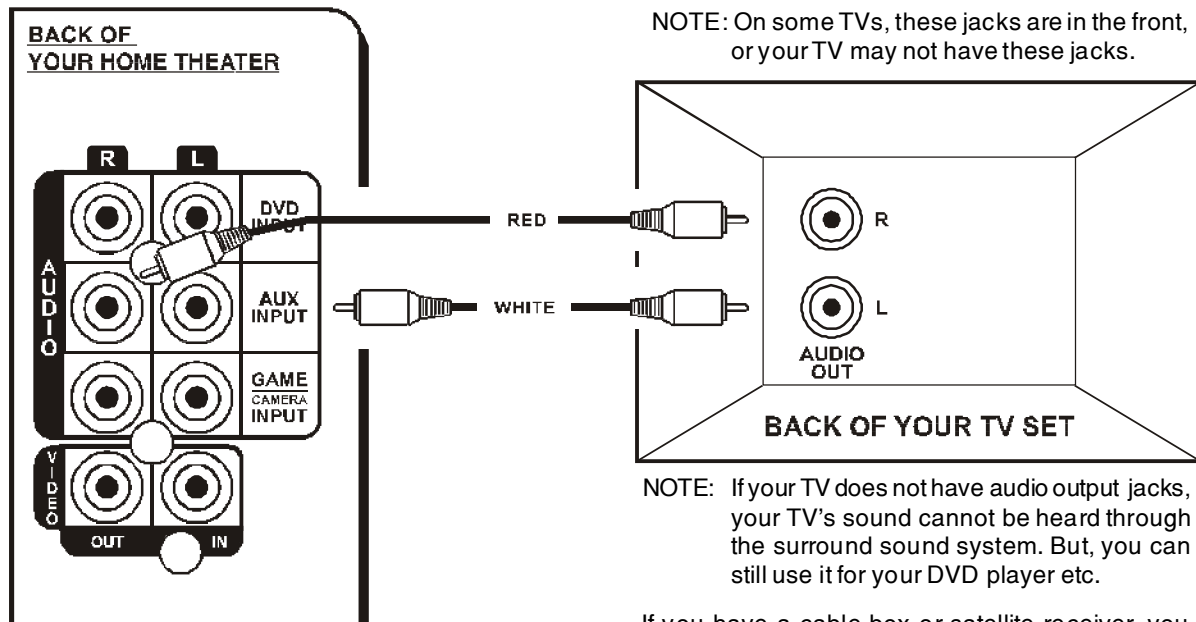

If you have a cable box or satellite receiver, you can connect the receiver AUDIO OUTPUT directly to your AUX INPUT or any available set of input jacks on the back of the HOME THEATER SYSTEM.

CONNECT ALL SPEAKERS AS SHOWN ON PAGE 8 (OR THE QUICK SETUP DIAGRAM SHEET)

1. Connect the 5 satellite speakers as shown on Page 8 (or the QUICK SETUP DIAGRAM packed with the set).
2. Insert the stereo audio cables (included) into the AUX AUDIO INPUT L (left=white) and R (right=red) jacks or any available set of input jacks on the back of your HOME THEATER SYSTEM, and into the corresponding AUDIO OUT jacks on your TV, this will allow your TV's sound to play through your HOME THEATER SYSTEM.
3. Insert the AC power cord into an AC outlet.
4. Make sure the POWER switch on the back of the main unit is at "ON" position. Next press the ON/STANDBY button on the front of the main set or on the REMOTE to turn the set on (or off).
5. Press the INPUT SOURCE button several times till the AUX indicator lights.

NOTE: On some TVs, you may have to activate the audio out jacks of your TV. See your TV's booklet.

NOTE: The factory's default input source is DVD with 5.1 channel sound output. When the set is turned ON, the DVD indicator and 5.1 channel indicator will be on and sound will come out of 5 speakers plus the subwoofer. To change 5.1 channel to 2 channel output, press the SPEAKER CHANNELS button. The sound will come out of only 2 front speakers plus the subwoofer.

6. Go to Page 21 for other detailed instructions.

NOTE: Your cable or antenna connection to your TV are not touched with this connection. Leave your antenna cable to your TV as you normally would. No changes will be made to your current antenna connections.

TV + DVD CONNECTIONS

Home Theater System + TV + DVD Player

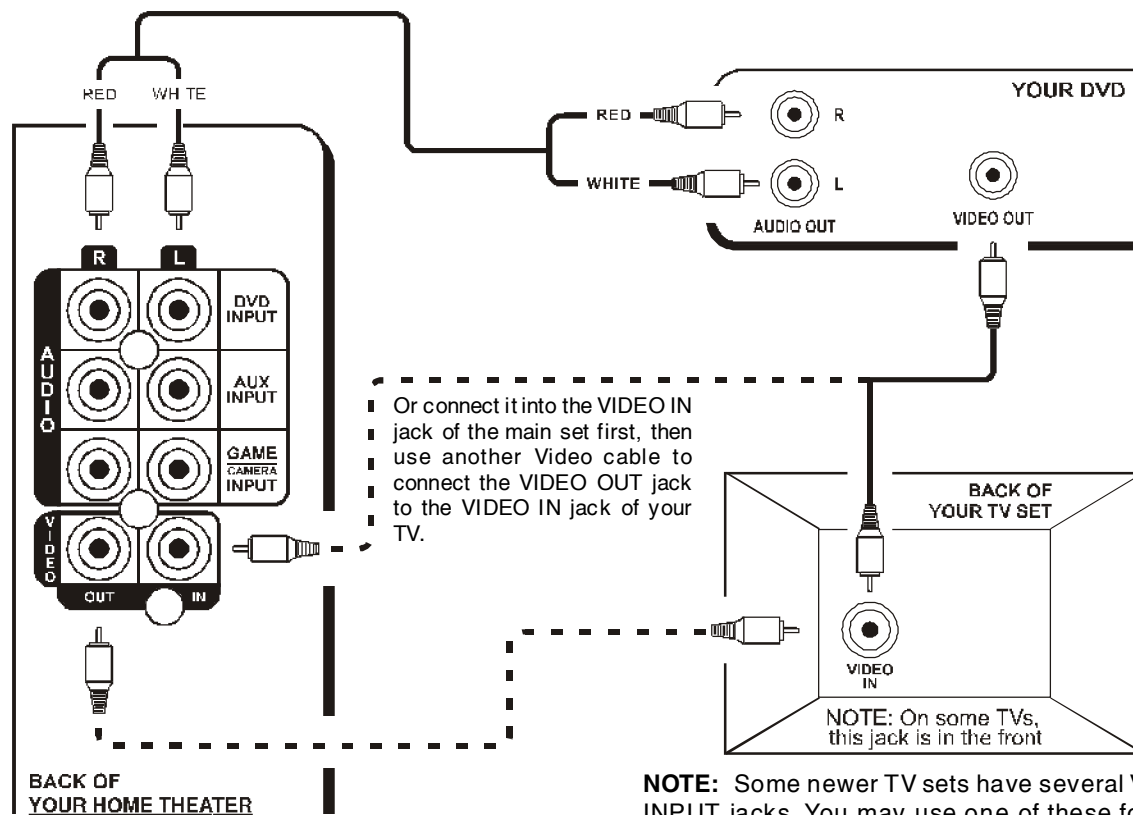

CONNECT ALL SPEAKERS AS SHOWN ON PAGE 8
(OR THE QUICK SETUP DIAGRAM SHEET)

1. Insert the audio cables (included) into the DVD INPUT jacks L (Left = White) and R (Right = Red) on the back of your HOME THEATER SYSTEM, and into the corresponding AUDIO OUT jacks on your DVD player, this will allow your DVD's sound to play through your HOME THEATER SYSTEM.
2. Insert the video cable directly into the VIDEO OUT jack on the back of your DVD player and into the VIDEO IN jack on the back of your TV set. This is especially convenient if your TV has several inputs.

NOTE: You may insert the video cable directly into the VIDEO OUT jack on the back of your DVD and into the VIDEO IN jack on the back of your HOME THEATER SYSTEM. Then insert the video cable into the VIDEO IN jack on your TV, and into the VIDEO OUT jack on the back of your HOME THEATER SYSTEM.

3. Insert the AC power cord into an AC outlet.
4. Make sure the POWER switch on the back of the main unit is at "ON" position. Next press the ON/STANDBY button on the front of the main set or on the REMOTE to turn the set on (or off).

NOTE: The factory's default input source is DVD with 5.1 channel sound output. When the set is turned to ON, the DVD indicator and 5.1 channel indicator will be on and sound will come out of 5 speakers plus the subwoofer. To change 5.1 channel to 2 channel output, press the SPEAKER CHANNELS button. The sound will come out of only 2 front speakers plus the subwoofer.

5. Make sure your DVD player is on and follow your DVD player's instructions.

NOTE: For some DVDs, if the sound output is not set to analog, the audio cables may not be active and there will be no sound output. If this happens, check and make sure your DVD's sound output is set to analog.

6. Go to Page 21 for other detailed instructions.

NOTE: Your cable or antenna connection to your TV are not affected with this connection. Leave your antenna cable connected to your TV as you normally would. No changes will be made to your current antenna connections.

TV + VCR CONNECTIONS

Home Theater System + TV + VCR

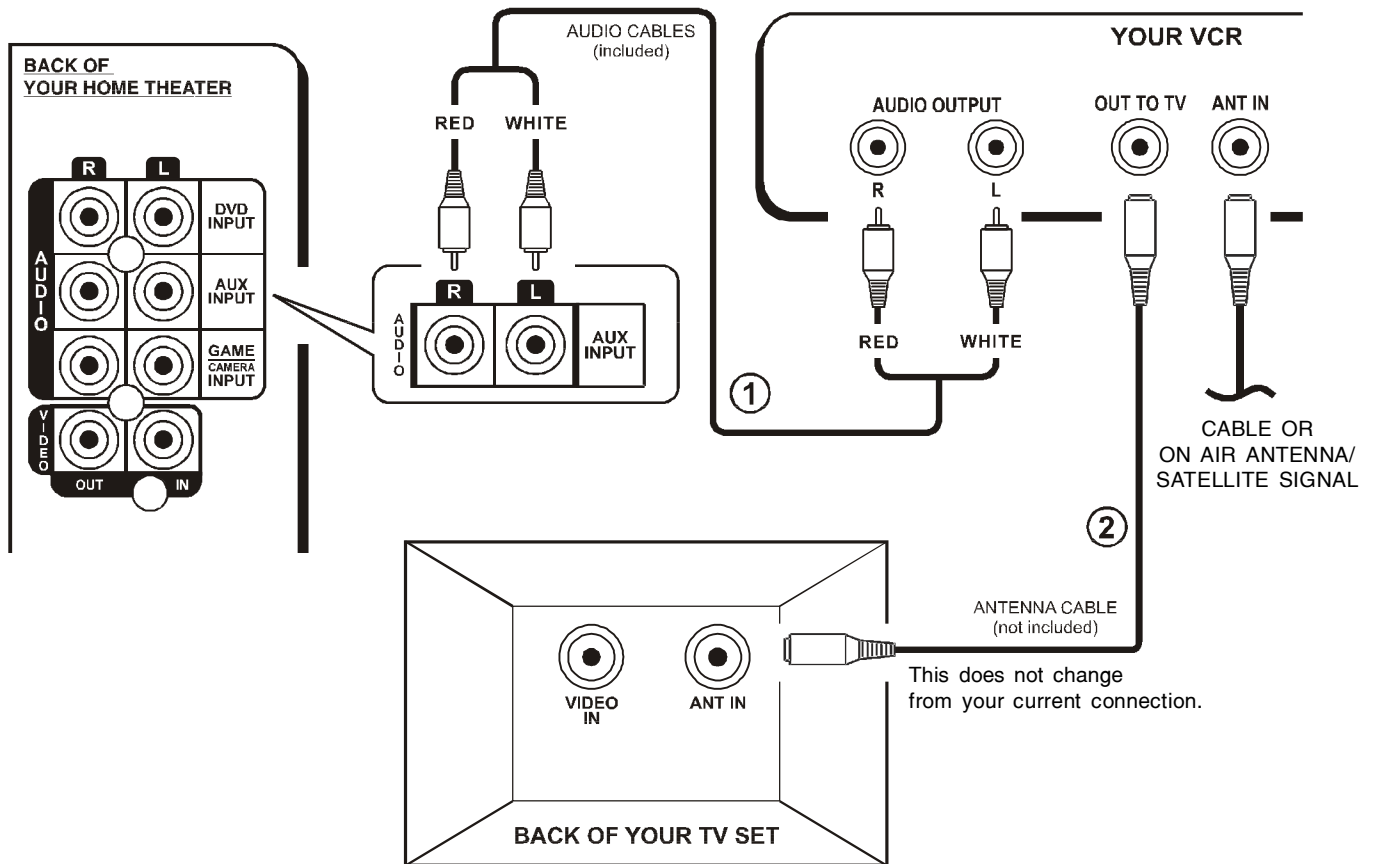

CONNECT ALL SPEAKERS AS SHOWN ON PAGE 8 (OR THE QUICK SETUP DIAGRAM SHEET)

1. Insert the stereo audio cables (included) into the AUX INPUT L (left=white) and R (right=red) jacks or any available set of input jacks on the back of your HOME THEATER SYSTEM, and into the corresponding AUDIO OUT jacks on your VCR, this will allow your VCR's sound to play through your HOME THEATER SYSTEM.
2. Connections of your cables are not changed when you add your HOME THEATER SYSTEM.

NOTE: You will hear sound from both the TV and your HOME THEATER SYSTEM, this is normal.

3. Insert the AC power cord into an AC outlet.
4. Make sure the POWER switch on the back of the main unit is at "ON" position. Next press the ON/STANDBY button on the front of the main set or on the REMOTE to turn the set on (or off).

NOTE: The factory's default input source is DVD with 5.1 channel sound output. When the set is turned to ON, the DVD indicator and 5.1 channel indicator will be on and sound will come out of 5 speakers plus the subwoofer. To change 5.1 channel to 2 channel output, press the SPEAKER CHANNELS button. The sound will come out of only 2 front speakers plus the subwoofer.

5. Press the INPUT SOURCE button several times till the AUX indicator lights.
6. Make sure your VCR is on and follow your VCR's instructions.
7. Go to Page 21 for other detailed instructions.

TV + VCR + SATELLITE RECEIVER CONNECTIONS

Home Theater System + TV + VCR + Satellite

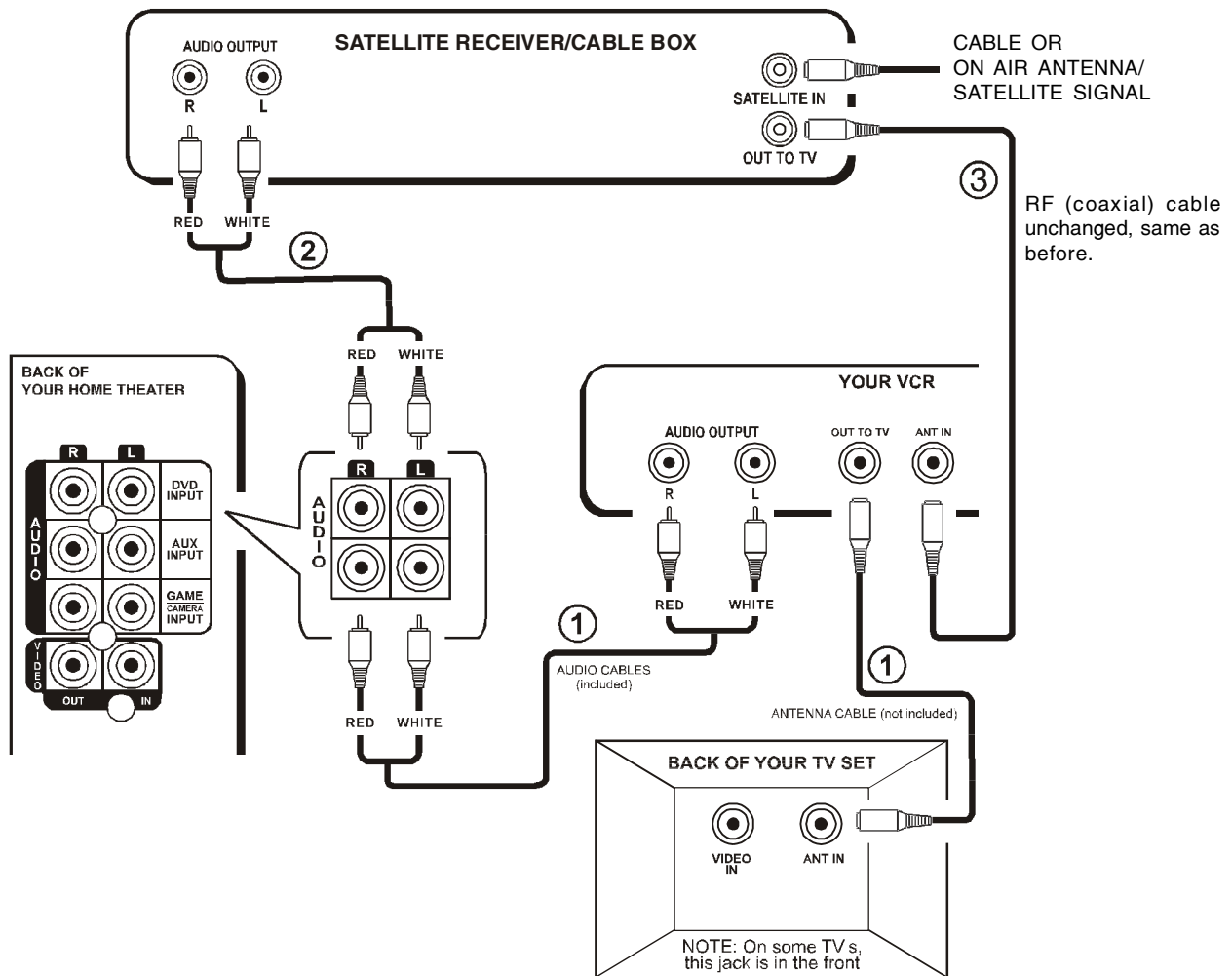

CONNECT ALL SPEAKERS AS SHOWN ON PAGE 8 (OR THE QUICK SETUP DIAGRAM SHEET).

1. Follow the same on P14 to connect your VCR with your HOME THEATER SYSTEM.
2. To hear the sound of the satellite programs through your HOME THEATER SYSTEM, just insert a set of audio cables (optional, not included) into one pair of the 3 audio input jacks of your HOME THEATER SYSTEM, and into the corresponding AUDIO OUT jacks of your SATELLITE RECEIVER/CABLE BOX.
3. Your RF (coaxial) cable connection from your SATELLITE RECEIVER/CABLE BOX to your VCR is unchanged, the same as before.

NOTE: You will hear sound from both the TV and your HOME THEATER SYSTEM, this is normal.

4. Insert the AC power cord into an AC outlet.
5. Make sure the POWER switch on the back of the main unit is at "ON" position. Next press the ON/STANDBY button on the front of the main set or on the REMOTE to turn the set on (or off).

NOTE: The factory's default input source is DVD with 5.1 channel sound output. When the set is turned to ON, the DVD indicator and 5.1 channel indicator will be on and sound will come out of 5 speakers plus the subwoofer. To change 5.1 channel to 2 channel output, press the SPEAKER CHANNELS button. The sound will come out of only 2 front speakers plus the subwoofer.

6. Press the INPUT SOURCE button several times till the AUX indicator lights.
7. Make sure your VCR is on and follow your VCR's instructions.
8. Go to Page 21 for other detailed instructions.

TV + TV GAME CONNECTIONS

Home Theater System + TV + TV Game

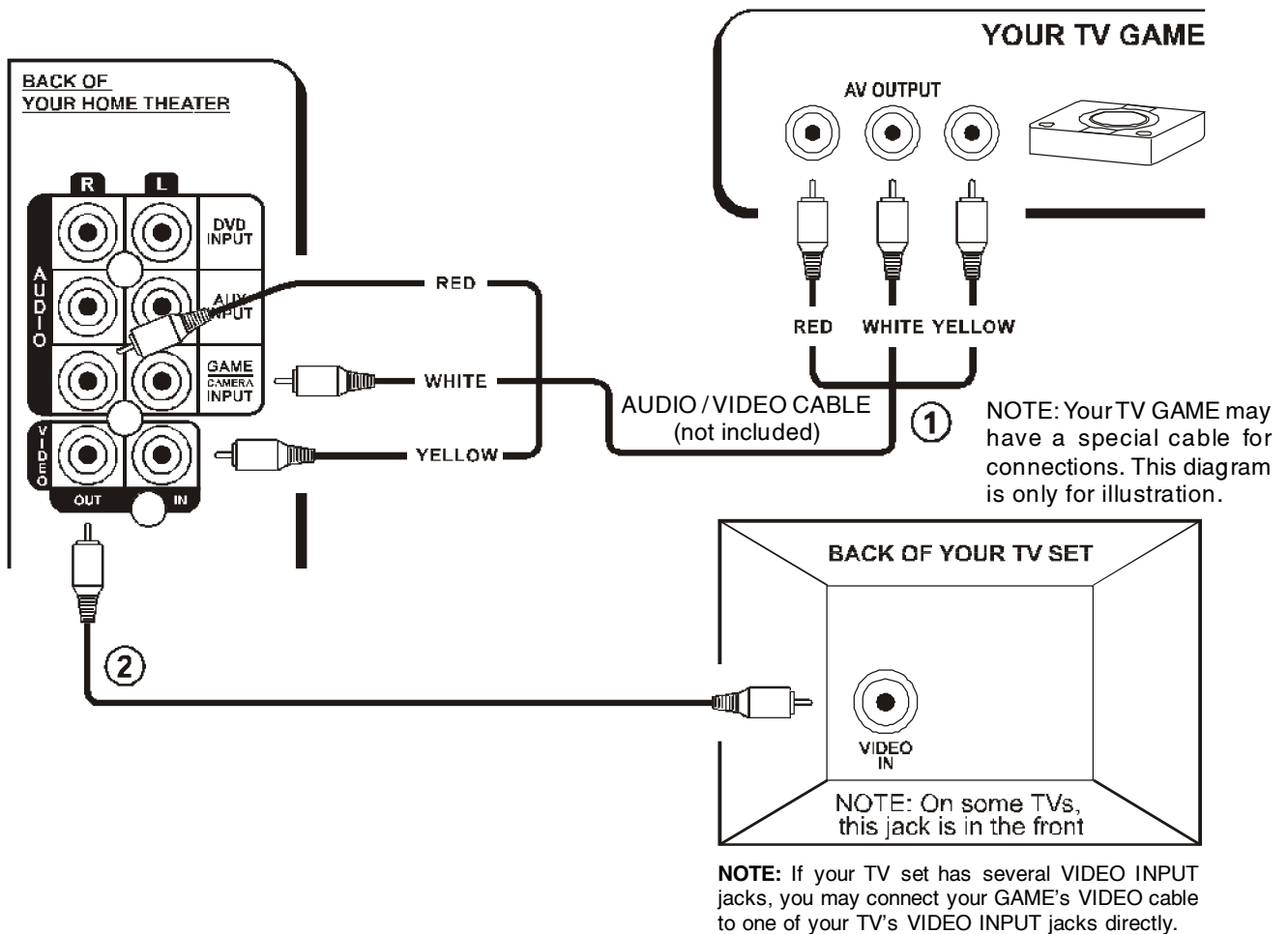

CONNECT ALL SPEAKERS AS SHOWN ON PAGE 8 (OR THE QUICK SETUP DIAGRAM SHEET).

1. Insert the stereo audio cables into the GAME INPUT AUDIO L (left=white) and AUDIO R (right=red) jacks or any available set of input jacks on the **BACK** of your HOME THEATER SYSTEM, and into the corresponding AUDIO OUT jacks on your TV GAME, this will allow your TV GAME's sound to play through your HOME THEATER SYSTEM.
2. Insert the yellow video cable (included with your TV GAME) into the GAME INPUT VIDEO jack on the **BACK** of your HOME THEATER SYSTEM, and into the VIDEO OUT jack on your TV GAME.
3. Insert another video cable into the VIDEO OUT jack on the back of your HOME THEATER SYSTEM, and into the VIDEO IN jack on your TV.

4. Insert the AC power cord into an AC outlet.

5. Make sure the POWER switch on the back of the main unit is at "ON" position. Next press the ON/STANDBY button on the front of the main set or on the REMOTE to turn the set on (or off).

NOTE: The factory's default input source is DVD with 5.1 channel sound output. When the set is turned to ON, the DVD indicator and 5.1 channel indicator will be on and sound will come out of 5 speakers plus the subwoofer. To change 5.1 channel to 2 channel output, press the SPEAKER CHANNELS button. The sound will come out of only 2 front speakers plus the subwoofer.

6. Press the INPUT SOURCE button several times till the GAME indicator lights.
7. Make sure your TV GAME is on and follow your TV GAME's instructions.
8. Go to Page 21 for other detailed instructions.

TV + VIDEO CAMERA CONNECTIONS

Home Theater System + TV + Video Camera

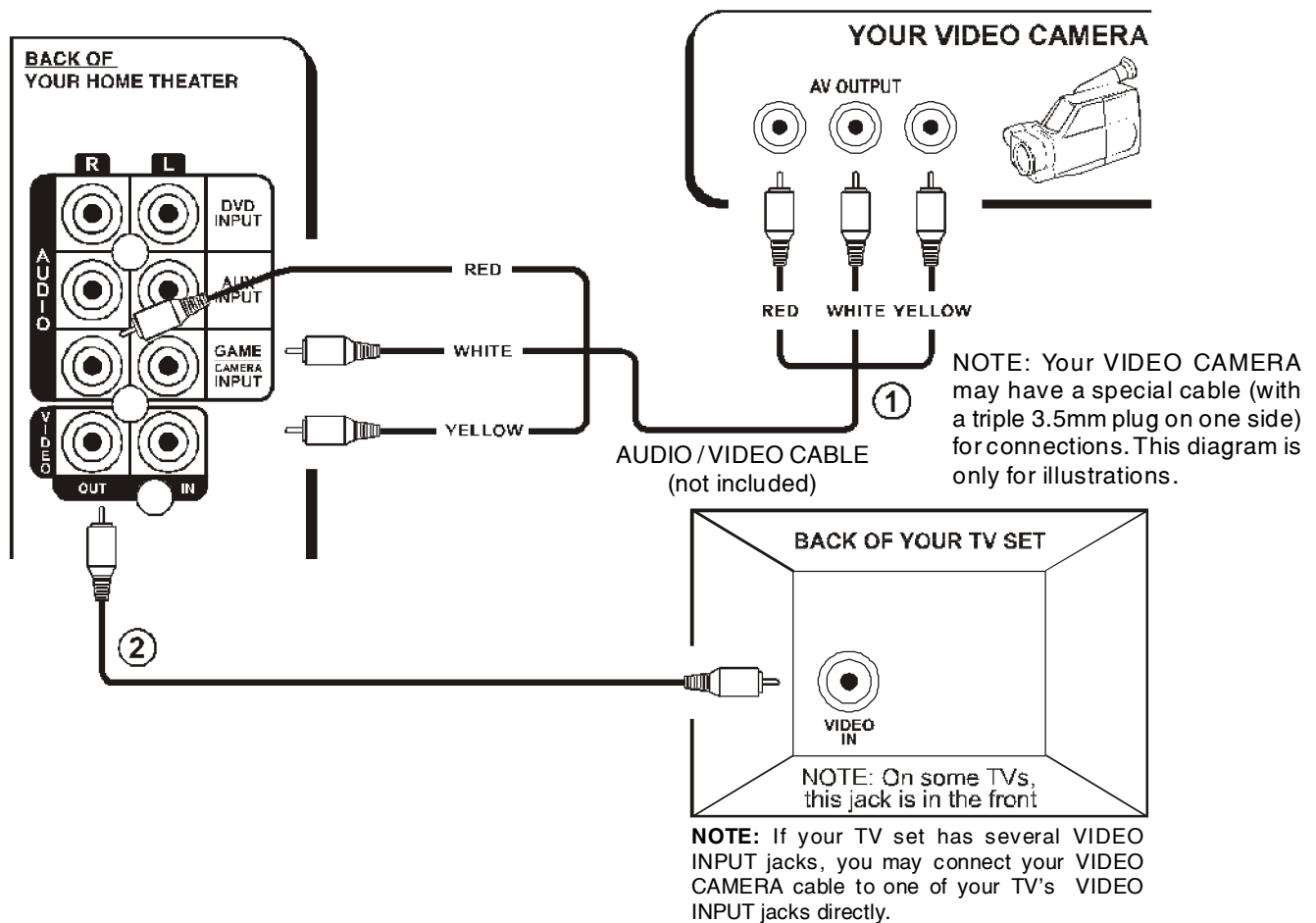

CONNECT ALL SPEAKERS AS SHOWN ON PAGE 8 (OR THE QUICK SETUP DIAGRAM SHEET).

1. Insert the stereo audio cables into the GAME INPUT AUDIO L (left=white) and AUDIO R (right=red) jacks or any available set of input jacks on the **BACK** of your HOME THEATER SYSTEM, and into the corresponding AUDIO OUT jacks on your VIDEO CAMERA, this will allow your CAMERA VIDEO's sound to play through your HOME THEATER SYSTEM. (NOTE: Many video cameras have special plugs on one side to connect to your camera.)
2. Insert the video cable (included with your VIDEO CAMERA) into the GAME INPUT VIDEO IN jack on the **BACK** of your HOME THEATER SYSTEM, and into the VIDEO OUT jack on your VIDEO CAMERA. (NOTE: Your video camera may have a 3.5mm triple jack, consult your camera's booklet for details.)
3. Insert the video cable (included) into the VIDEO OUT jack on the back of your HOME THEATER SYSTEM, and into the VIDEO IN jack on your TV.
4. Insert the AC power cord into an AC outlet.
5. Make sure the POWER switch on the back of the main unit is at "ON" position. Next press the ON/STANDBY button on the front of the main set or on the REMOTE to turn the set on (or off).
6. Press the INPUT SOURCE button several times till the GAME indicator lights. (This setting is either for a Video Camera or a TV Game.)

NOTE: The factory's default input source is DVD with 5.1 channel sound output. When the set is turned to ON, the DVD indicator and 5.1 channel indicator will be on and sound will come out of 5 speakers plus the subwoofer. To change 5.1 channel to 2 channel output, press the SPEAKER CHANNELS button. The sound will come out of only 2 front speakers plus the subwoofer.

7. Make sure your VIDEO CAMERA is on and follow your VIDEO CAMERA's instructions.
8. Go to Page 21 for other detailed instructions.

AUX IN CONNECTIONS

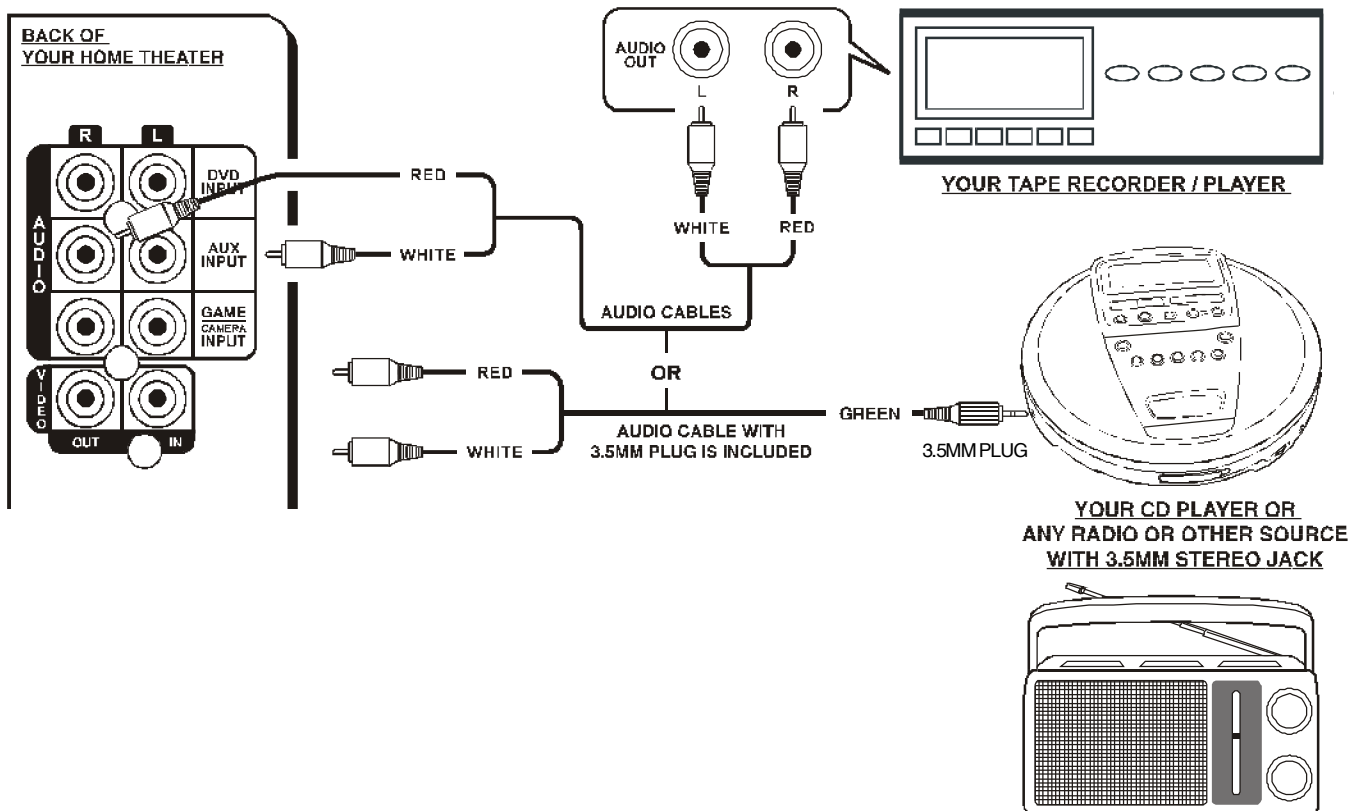

CONNECT ALL SPEAKERS AS SHOWN ON PAGE 8 (OR THE QUICK SETUP DIAGRAM SHEET).

- Illustration is showing some possible connections. You can only connect **ONE** of these components to the AUX INPUT jacks of your HOME THEATER SYSTEM (AUX stands for Auxiliary).
 - You can hear the sound of any one of these devices through your HOME THEATER SYSTEM if you connect the proper cables.
1. Insert the audio cables into the AUDIO OUTPUT **L** (left=white) and **R** (right=red) jacks of your TAPE RECORDER PLAYER, and into the corresponding AUX INPUT jacks or any available set of input jacks on your HOME THEATER. This will enable you to hear your components system through your HOME THEATER SYSTEM.
 2. You may also use the green 3.5mm plug and cable (included) to connect your CD PLAYER, RADIO or other device to your HOME THEATER SYSTEM
 3. Make sure the POWER switch on the back of the main unit is at "ON" position. Next press the ON/STANDBY button on the front of the main set or on the REMOTE to turn the set on (or off).
 4. Press the INPUT SOURCE button several times till the AUX indicator lights.
- NOTE:** The factory's default input source is DVD with 5.1 channel sound output. When the set is turned to ON, the DVD indicator and 5.1 channel indicator will be on and sound will come out of 5 speakers plus the subwoofer. To change 5.1 channel to 2 channel output, press the SPEAKER CHANNELS button. The sound will come out of only 2 front speakers plus the subwoofer.
5. Make sure your AUX IN component is on and follow your component's instructions.
 6. Go to Page 21 for other detailed instructions.

AM / FM TUNER CONNECTIONS

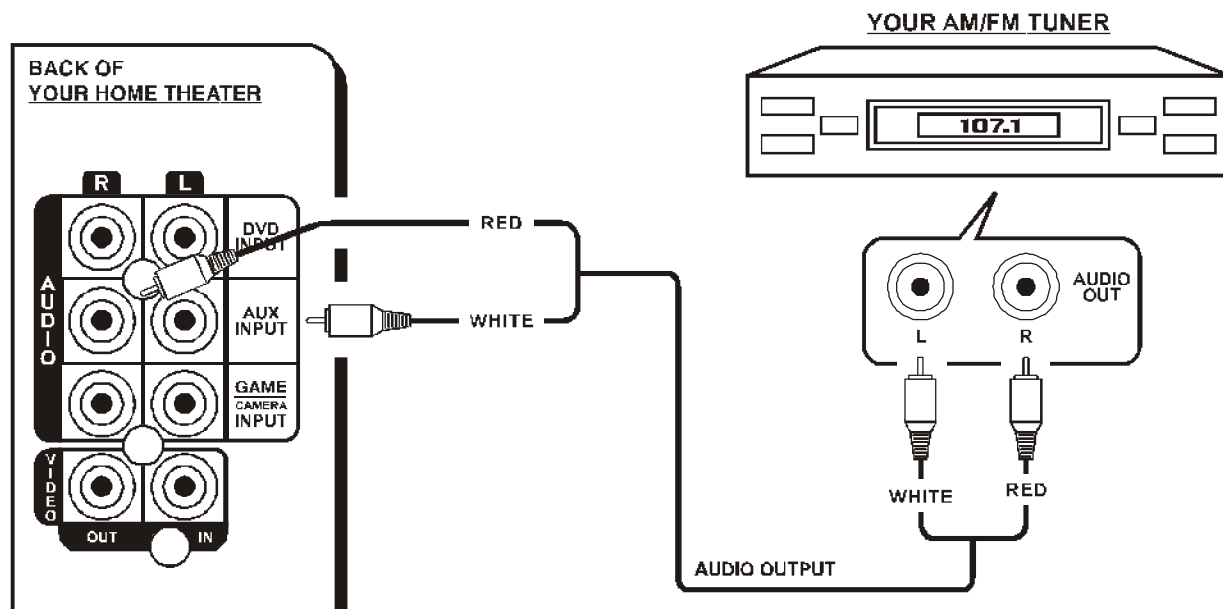

CONNECT ALL SPEAKERS AS SHOWN ON PAGE 8 (OR THE QUICK SETUP DIAGRAM SHEET).

1. Insert the audio cables into the AUDIO OUTPUT **L** (left=white) and **R** (right=red) jacks on the back of your AM/FM TUNER, and into the corresponding AUX INPUT jacks or any available set of input jacks on the back of your HOME THEATER. This will enable you to hear your stereo AM/FM TUNER through your HOME THEATER SYSTEM.

2. Make sure the POWER switch on the back of the main unit is at "ON" position. Next press the ON/STANDBY button on the front of the main set or on the REMOTE to turn the set on (or off).
3. Press the INPUT SOURCE button several times till the AUX indicator lights.

NOTE: The factory's default input source is DVD with 5.1 channel sound output. When the set is turned to ON, the DVD indicator and 5.1 channel indicator will be on and sound will come out of 5 speakers plus the subwoofer. To change 5.1 channel to 2 channel output, press the SPEAKER CHANNELS button. The sound will come out of only 2 front speakers plus the subwoofer.

4. Make sure your AM/FM TUNER is on and follow your AM/FM TUNER's instructions.
5. Go to Page 21 for other detailed instructions.

COMPUTER SOUND CONNECTIONS

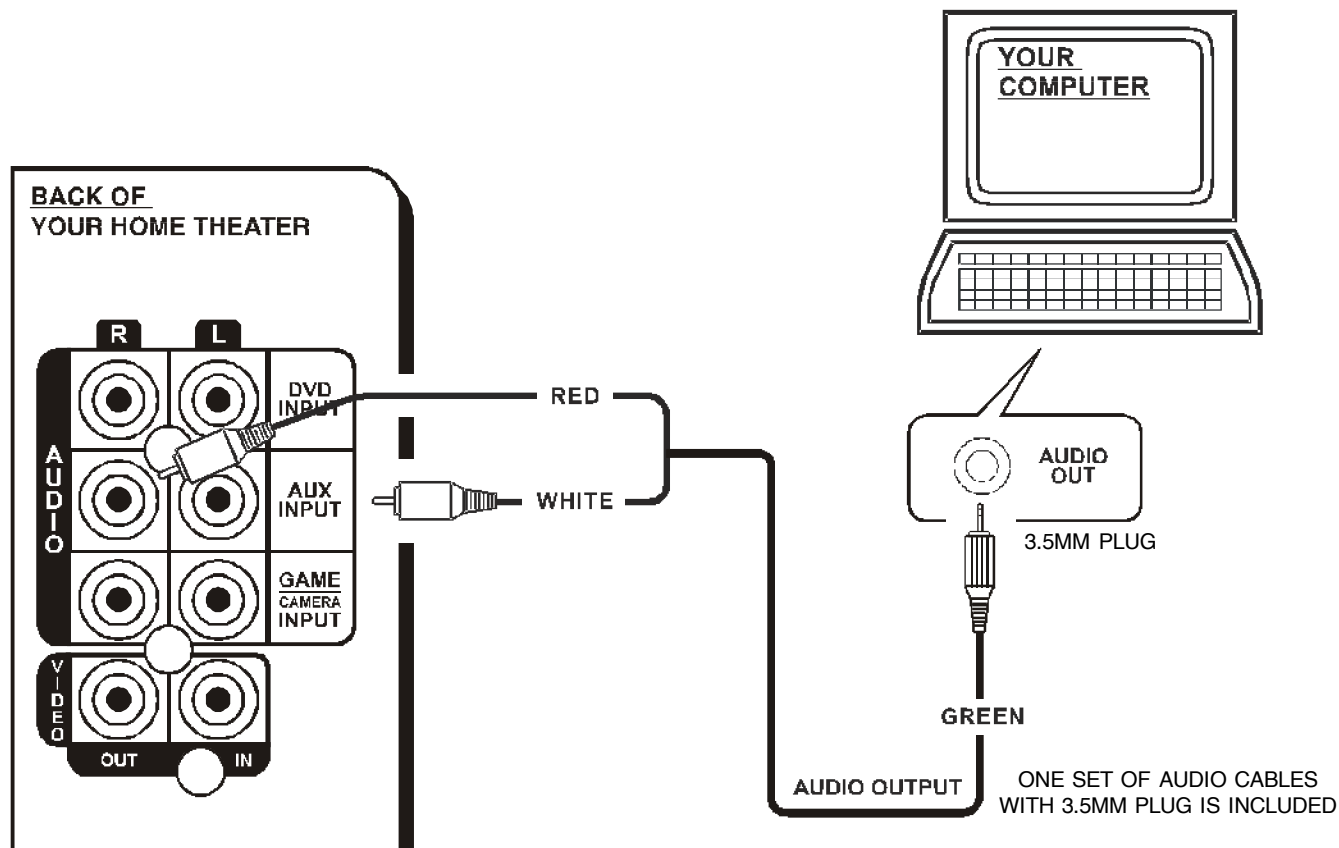

CONNECT ALL SPEAKERS AS SHOWN ON PAGE 8 (OR THE QUICK SETUP DIAGRAM SHEET).

1. Insert the green 3.5mm audio plug of the AUDIO cable (included) into the PC AUDIO OUT jack of your PC, and insert the AUX INPUT **L** (left = white) and **R** (right = red) plugs into the corresponding AUX INPUT jacks on the back of your HOME THEATER. This will enable you to hear your PC's music through your HOME THEATER SYSTEM.
2. Make sure the POWER switch on the back of the main unit is at "ON" position. Next press the ON/STANDBY button on the front of the main set or on the REMOTE to turn the set on (or off).
3. Press the INPUT SOURCE button several times till the AUX indicator lights.

NOTE: The factory's default input source is DVD with 5.1 channel sound output. When the set is turned to ON, the DVD indicator and 5.1 channel indicator will be on and sound will come out of 5 speakers plus the subwoofer. To change 5.1 channel to 2 channel output, press the SPEAKER CHANNELS button. The sound will come out of only 2 front speakers plus the subwoofer.

4. Make sure your computer is on and follow your computer's instructions.
5. Go to Page 21 for other detailed instructions.

AMPLIFIER IN MAIN UNIT

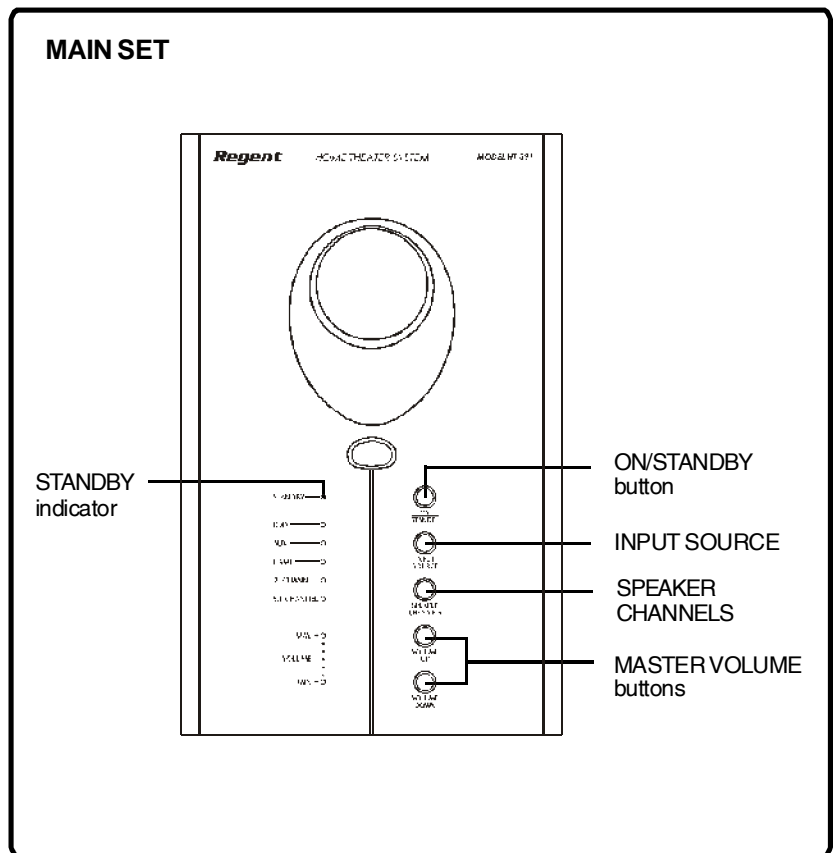
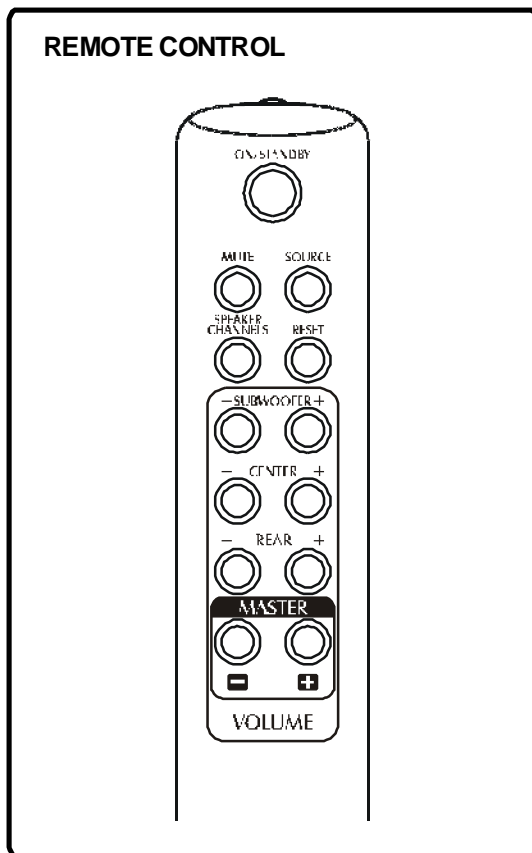

General

1 Make sure the POWER switch on the back of the main unit is at “ON” position. Next press the ON/STANDBY button on the front of the main set or on the REMOTE to turn the set on (or off).

NOTE: The STANDBY indicator has 2 modes: flashing and steadily ON (slow flashing indicates the set is in standby, steadily on indicates the set is on). When the set is off (standby), pressing the ON/STANDBY button on the main unit or on the REMOTE CONTROL will turn the set on. The indicator will become steadily on.

2 Press the **INPUT SOURCE** button on the front panel of the main unit repeatedly to select one of the input sources, or press the SOURCE button on the REMOTE to select the audio input source directly, the corresponding indicator will light.

3 For SUBWOOFER’s volume adjustments, press the SUBWOOFER volume control buttons on the Remote control:

- ⊕ raises the volume, and the top volume indicator will flash.
- ⊖ lowers the volume, and the lower volume indicator will flash.

Follow this step to adjust the CENTER and REAR speakers as well. Or you may press the VOLUME UP or DOWN button on the main set or the MASTER VOLUME control on the remote to raise or lower **all** speakers’ volumes at the same time.

4 To select the listening mode, press the **SPEAKER CHANNELS** button on the main set or on the REMOTE CONTROL.

NOTE: The factory’s default input source is DVD with 5.1 channel sound output. When the set is turned to ON, the DVD indicator and 5.1 channel indicator will be on and sound will come out of 5.1 speakers plus the subwoofer. To change 5.1 channel to 2 channel output, press the SPEAKER CHANNELS button. The sound will come out of only 2 front speakers plus the subwoofer.

5 To momentarily shut off the sound, press the **MUTE** button. Both the top and lower VOLUME indicators will flash. Press the MUTE button again or press the **MASTER VOLUME** button to restore the sound.

NOTE: Flip the POWER switch button on the back of the main unit to “OFF” if the set will not be used for a long period of time (several days or more).

AMPLIFIER

RESET BUTTON

Pressing this button on the remote control will reset all 5 satellite speakers and the subwoofer to their default factory settings, normal level.

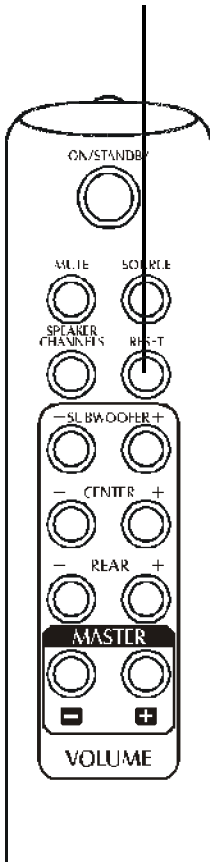

Volume Adjustment

1 To adjust the master volume

(Change all the speakers' volume settings at the same time), press the MASTER VOLUME buttons on the main unit or on the REMOTE to decrease or increase the master volume level.

- raises the volume
- lowers the volume

The MAX VOLUME indicator on the front panel will be on when the MASTER VOLUME is at its maximum level, also it will flash confirming you pressed the VOLUME UP button.

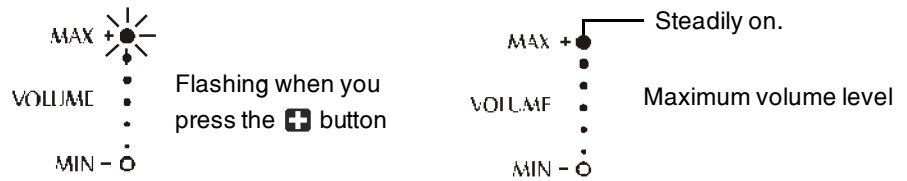

The MIN VOLUME indicator on the front panel will be on when the MASTER VOLUME is at its minimum level, also it will flash confirming you pressed the VOLUME DOWN button.

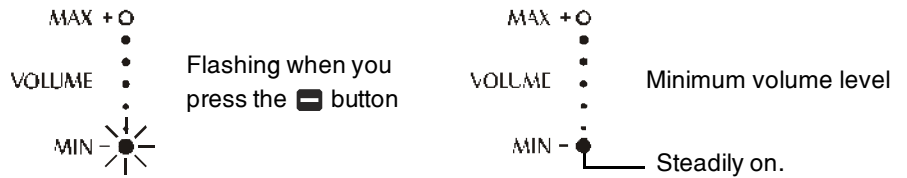

2 To adjust the individual speaker's volume:

For SUBWOOFER's volume adjustments, press the SUBWOOFER's volume control buttons:

- raises the volume, and the MAX VOLUME indicator will flash.
- lowers the volume, and the MIN VOLUME indicator will flash.

Follow this step to adjust the CENTER and REAR speakers as well. Or you may press the VOLUME UP or DOWN buttons on the main set or the MASTER VOLUME control on the remote to raise or lower **all** the speakers' volumes at the same time.

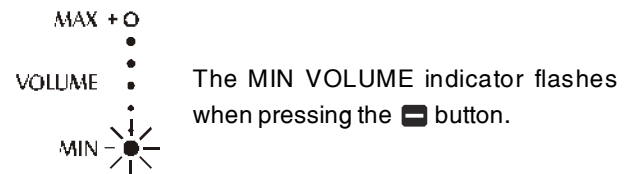
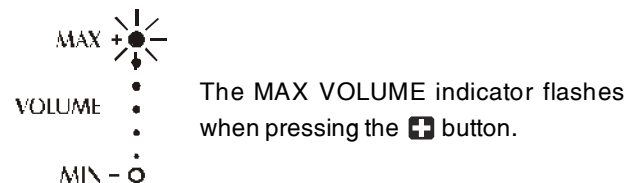

NOTE: Every time you turn the set on, the MASTER VOLUME will go back to the factory's default setting; and whenever you press the INPUT SOURCE button on the main unit or the SOURCE button on the REMOTE, the MASTER VOLUME will go back to the factory's default setting. This avoids sudden very loud sounds from startling you.

NOTE: REAR speakers and CENTER speaker volume adjustments can only be made from the remote control in 5.1 channel speaker mode, not in 2 channel speaker mode.

NOTE: The excessively loud volume settings may cause sound distortion. To reduce the sound distortion, adjust the set's MASTER volume or the SUBWOOFER's volume settings on the front of the HOME THEATER or on the remote, also adjust the volume of the input source (DVD or other).

LISTENING MODE

5.1 Channel and Stereo Modes

Most currently released DVDs, video cassettes and audio compact discs and many TV broadcasts are encoded with 2 channel Stereo or 5.1 channel. Audio discs and tuner broadcasts are in Stereo.

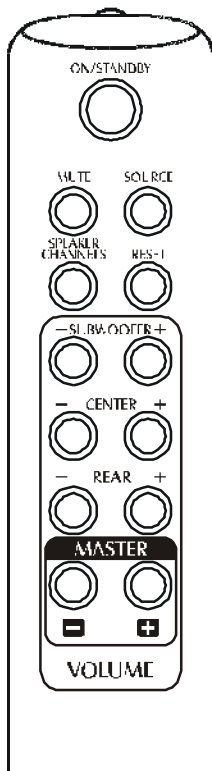

- 1 Press the **INPUT SOURCE** button on the front panel of the main unit repeatedly to select one of the audio input sources, or press the **SOURCE** button on the REMOTE to select directly your required audio input source. The corresponding indicator will light.

DVD —●
ALIX —○
GAME —○
2 CHANNEL ○
5.1 CHANNEL ○

NOTE: The factory's default input source is DVD with 5.1 channel sound output. When the set is turned to ON, the DVD indicator and 5.1 channel indicator will be on and sound will come out of 5 speakers plus the subwoofer. To change 5.1 channel to 2 channel output, press the SPEAKER CHANNELS button. The sound will only come out of 2 front speakers plus the subwoofer.

DVD —○
ALIX —○
GAME —○
2 CHANNEL ○
5.1 CHANNEL ●

- 2 Press the **SPEAKER CHANNELS** button on the REMOTE control to select 5.1 channel or 2 channel sound.
- 3 When 2 channel sound is selected, the center & rear speaker volume controls will, of course, not work.

NOTE: About fuse replacement.

In the unusual event that nothing lights up and no sound, your fuse may have blown. To check for a blown fuse, follow the steps below.

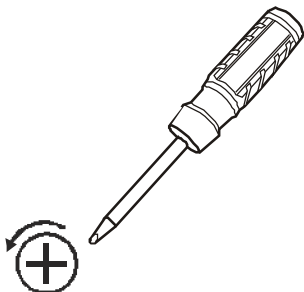

1. Open the fuse cover (on the back of the main set) by using a Philips screwdriver to unscrew the fuse cover cap.

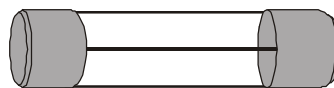

GOOD FUSE

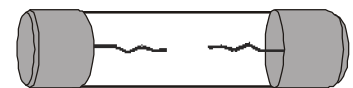

BLOWN FUSE

2. Examine the fuse. If a wire shows, the fuse is good.
3. If the wire is broken in the middle, replace with a 1.6A 250V "T" type glass fuse. "T" means time delay or slow blow fuse.

TROUBLE SHOOTING

Symptom	Remedy
No power	<ol style="list-style-type: none"> 1. Is the power cord firmly plugged into the power outlet? Insert the AC power plug securely into the power outlet. Make sure your outlet has power, you can check this by plugging a lamp into the outlet to see if it works. 2. Is the main power switched to off? Flip it to ON. 3. One of the safety mechanisms may be operating. In this event, unplug the player from the power outlet briefly and then plug it in again to reset the set.
No power	<p>Your set's fuse may have blown. Unscrew the fuse cover & check the fuse. Replace only with same 1.6A slow blow 250V "T" type glass fuse. See page 23 for more information.</p>
Your DVD player has no picture	<p>Make sure your DVD's video cable is plugged into your TV set. This Home Theater only improves the sound of your DVD player, it does not affect the video at all. Also select the correct VIDEO INPUT on your TV.</p>
<ul style="list-style-type: none"> • No sound or only a very low-level sound is heard. • Distorted sound. 	<ol style="list-style-type: none"> 1. Check that the speakers and components are connected securely and correctly, make sure the stripped end of each speaker wires does not touch each other to avoid short-circuit of the speaker wires (see Page 8, 9). Also check speaker volume (see Page 22). 2. Make sure your source (DVD or other) is plugged in and operating. Also check that component's booklet, maybe you need adjust that component. 3. Check and make sure your DVD's sound output is set to analog. For some DVDs, if the sound output is not set to analog, the audio cables may not be active and there will be no sound output. 4. Make sure that you have selected the correct source on the system (DVD or other). 5. Adjust the set's MASTER volume or the SUBWOOFER's volume settings on the front of the HOME THEATER or on the remote, also adjust the volume of the input source. 6. Ensure the MUTE button is not pressed on the HOME THEATER remote (If yes, press the MUTE button again). 7. The audio or speaker connecting wires are damaged. Replace them with new ones.
The REMOTE CONTROL unit does not work.	<ol style="list-style-type: none"> 1. Check if the batteries are installed with the correct polarities (+ and -). 2. If the batteries are weak or dead, replace them with new ones (size "AAA"). 3. Point the remote control unit at a distance of less than 20 feet from the main unit of the HOME THEATER system. 4. Remove any obstacles between the remote control unit and remote control sensor. 5. If the battery terminals are dirty or corroded, clean them with sandpaper.
No buttons operate (on the main unit and / or the REMOTE CONTROL unit).	<p>Press the POWER button on the back of the MAIN UNIT to turn the set ON. Then press the ON/STANDBY button on the front of the main unit or on the REMOTE. The HOME THEATER may not be operating properly due to lightning, static electricity, or some other external factors. Reset the player by disconnecting the power plug and then re-connecting it before calling customer service. Also check the Fuse. See page 23.</p>
The left and right sounds are unbalanced or reversed.	<p>Check that the speakers and components are connected correctly and securely.</p>
Rear speakers and center speaker cannot be adjusted individually.	<p>During 2 channel operation, these speakers cannot be adjusted individually, you can raise or lower the volume lever of the whole set by pressing the MASTER VOLUME UP or DOWN button. To adjust these speakers individually, set to 5.1 channel sound output mode.</p>
Loud hum or noise is heard.	<ol style="list-style-type: none"> 1. Check that the speakers and components are connected securely. 2. Insert all wires firmly, follow the setup pages starting on Page 7. Loud hum usually means a plug is not fully seated into the jack.
No sound is heard from the center speaker.	<ol style="list-style-type: none"> 1. Make sure the Center speaker's volume is set to a normal level (see Page 22). 2. Adjust the center speaker volume by pressing the volume control buttons of the center speaker on the REMOTE (see Page 22). 3. If you are listening to 2 channel output mode, only 2 front speakers plus the subwoofer will have sound.
The system does not operate properly.	<p>Double check if input & output jacks were inserted properly. Also ask a friend to help you before calling customer service.</p>

SPECIFICATIONS

General

Power requirements ----- AC 120V, 60Hz

Power consumption ----- 100W

Main Unit Dimensions --- 6¹/₂ X 13⁷/₈ X 10¹/₄ inches / 16.6 X 35.4 X 26.1 cm

Weight ----- 14.8 lbs / 6.7 kg

Audio Power Outputs

Total output power: 140 Watts at Maximum

Distortion

0.06% @ reference output

Remote Operating Range

Within 20 feet between the main unit and the remote.

Replacement Fuse

Time delay 1.6 Amp T type (slow blow) glass fuse 250V.

Speakers

Front Left ----- Dimensions: 3⁷/₈ x 3⁵/₈ x 4¹/₄ inches / 98 X 97 X 107 mm

Weight: 1 lb / 0.46 kg

Center ----- Dimensions: 3⁷/₈ x 3⁵/₈ x 4¹/₄ inches / 98 X 97 X 107 mm

Weight: 1 lb / 0.46 kg

Front Right ----- Dimensions: 3⁷/₈ x 3⁵/₈ x 4¹/₄ inches / 98 X 97 X 107 mm

Weight: 1 lb / 0.46 kg

Rear Left ----- Dimensions: 3⁷/₈ x 3⁵/₈ x 4¹/₄ inches / 98 X 97 X 107 mm

Weight: 0.9 lb / 0.43 kg

Rear Right ----- Dimensions: 3⁷/₈ x 3⁵/₈ x 4¹/₄ inches / 98 X 97 X 107 mm

Weight: 0.9 lb / 0.43 kg

LENOXX reserves the right to make design and specification changes for product improvement.

PROTECT YOUR FINE FURNITURE!

WE RECOMMEND A CLOTH OR OTHER PROTECTIVE MATERIAL BE PLACED UNDER THE SET OR SPEAKERS WHEN PLACING IT ON A SURFACE WITH A NATURAL OR LACQUER FINISH.

For customer service of this REGENT product

Visit Our Website: <http://www.lenoxx.com>

or Dial 1-800-315-5885 (MONDAY-THURSDAY 9:00 AM - 5:00 PM, FRIDAY 9:00 AM - 1:00 PM EST)

or Write to:

LENOXX ELECTRONICS CORP.
2 GERMAK DRIVE
CARTERET, N.J. 07008

© 2003 LENOXX ELECTRONICS CORP.
MADE & PRINTED IN CHINA

Free Manuals Download Website

<http://myh66.com>

<http://usermanuals.us>

<http://www.somanuals.com>

<http://www.4manuals.cc>

<http://www.manual-lib.com>

<http://www.404manual.com>

<http://www.luxmanual.com>

<http://aubethermostatmanual.com>

Golf course search by state

<http://golfingnear.com>

Email search by domain

<http://emailbydomain.com>

Auto manuals search

<http://auto.somanuals.com>

TV manuals search

<http://tv.somanuals.com>